



This is a digital copy of a book that was preserved for generations on library shelves before it was carefully scanned by Google as part of a project to make the world's books discoverable online.

It has survived long enough for the copyright to expire and the book to enter the public domain. A public domain book is one that was never subject to copyright or whose legal copyright term has expired. Whether a book is in the public domain may vary country to country. Public domain books are our gateways to the past, representing a wealth of history, culture and knowledge that's often difficult to discover.

Marks, notations and other marginalia present in the original volume will appear in this file - a reminder of this book's long journey from the publisher to a library and finally to you.

### **Usage guidelines**

Google is proud to partner with libraries to digitize public domain materials and make them widely accessible. Public domain books belong to the public and we are merely their custodians. Nevertheless, this work is expensive, so in order to keep providing this resource, we have taken steps to prevent abuse by commercial parties, including placing technical restrictions on automated querying.

We also ask that you:

- + *Make non-commercial use of the files* We designed Google Book Search for use by individuals, and we request that you use these files for personal, non-commercial purposes.
- + *Refrain from automated querying* Do not send automated queries of any sort to Google's system: If you are conducting research on machine translation, optical character recognition or other areas where access to a large amount of text is helpful, please contact us. We encourage the use of public domain materials for these purposes and may be able to help.
- + *Maintain attribution* The Google "watermark" you see on each file is essential for informing people about this project and helping them find additional materials through Google Book Search. Please do not remove it.
- + *Keep it legal* Whatever your use, remember that you are responsible for ensuring that what you are doing is legal. Do not assume that just because we believe a book is in the public domain for users in the United States, that the work is also in the public domain for users in other countries. Whether a book is still in copyright varies from country to country, and we can't offer guidance on whether any specific use of any specific book is allowed. Please do not assume that a book's appearance in Google Book Search means it can be used in any manner anywhere in the world. Copyright infringement liability can be quite severe.

### **About Google Book Search**

Google's mission is to organize the world's information and to make it universally accessible and useful. Google Book Search helps readers discover the world's books while helping authors and publishers reach new audiences. You can search through the full text of this book on the web at <http://books.google.com/>

V VV69 NH



KG 580

甲



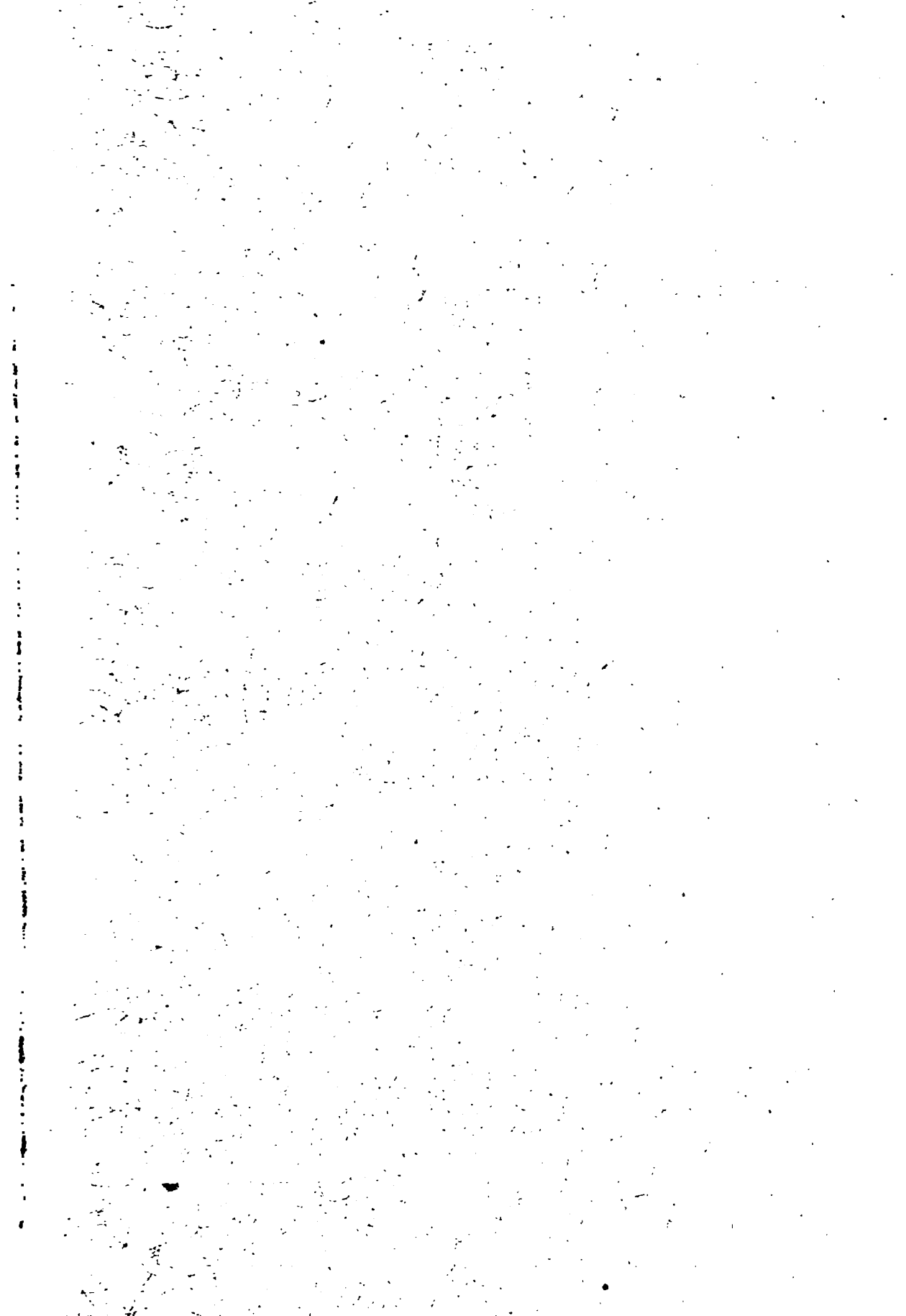

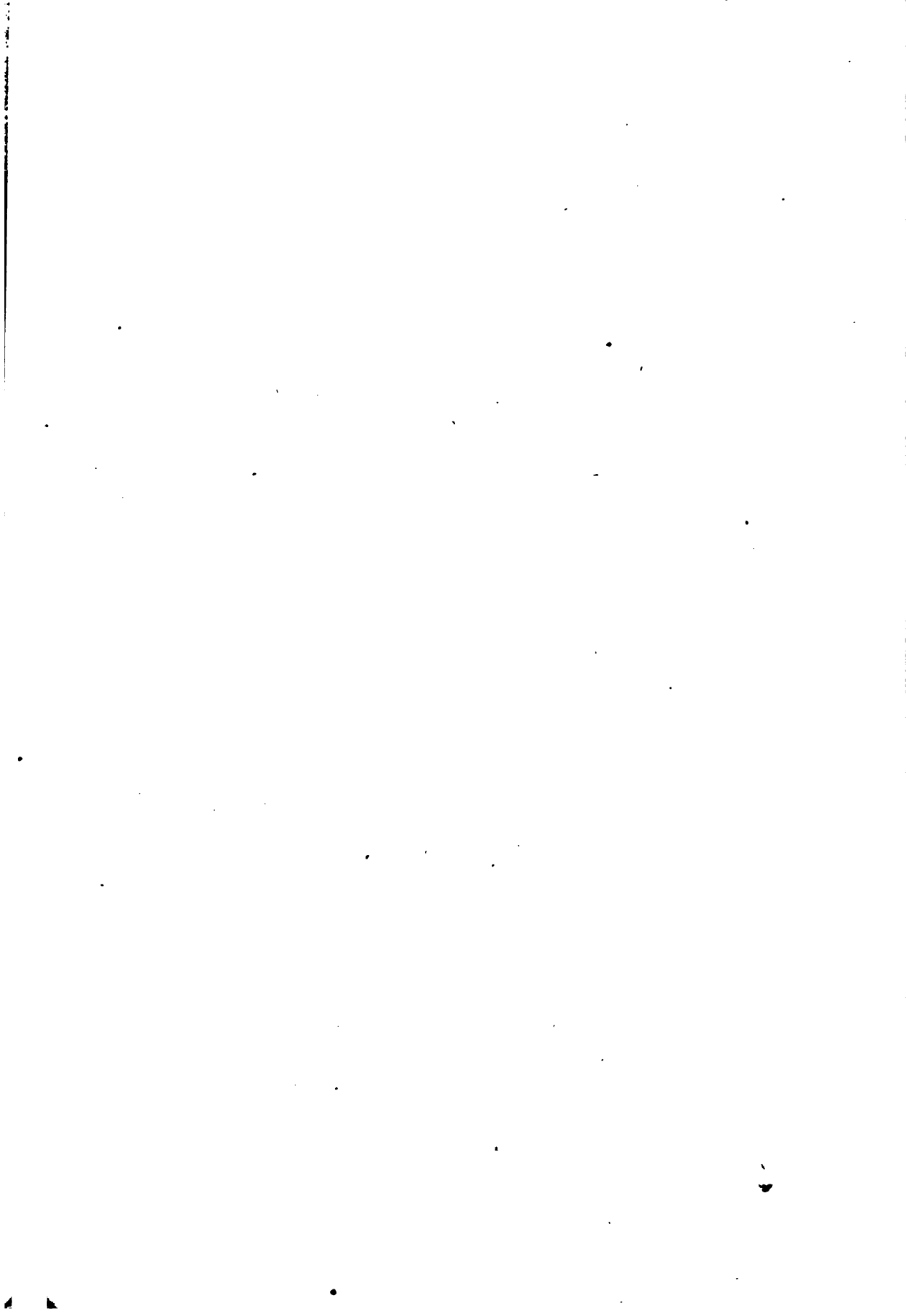



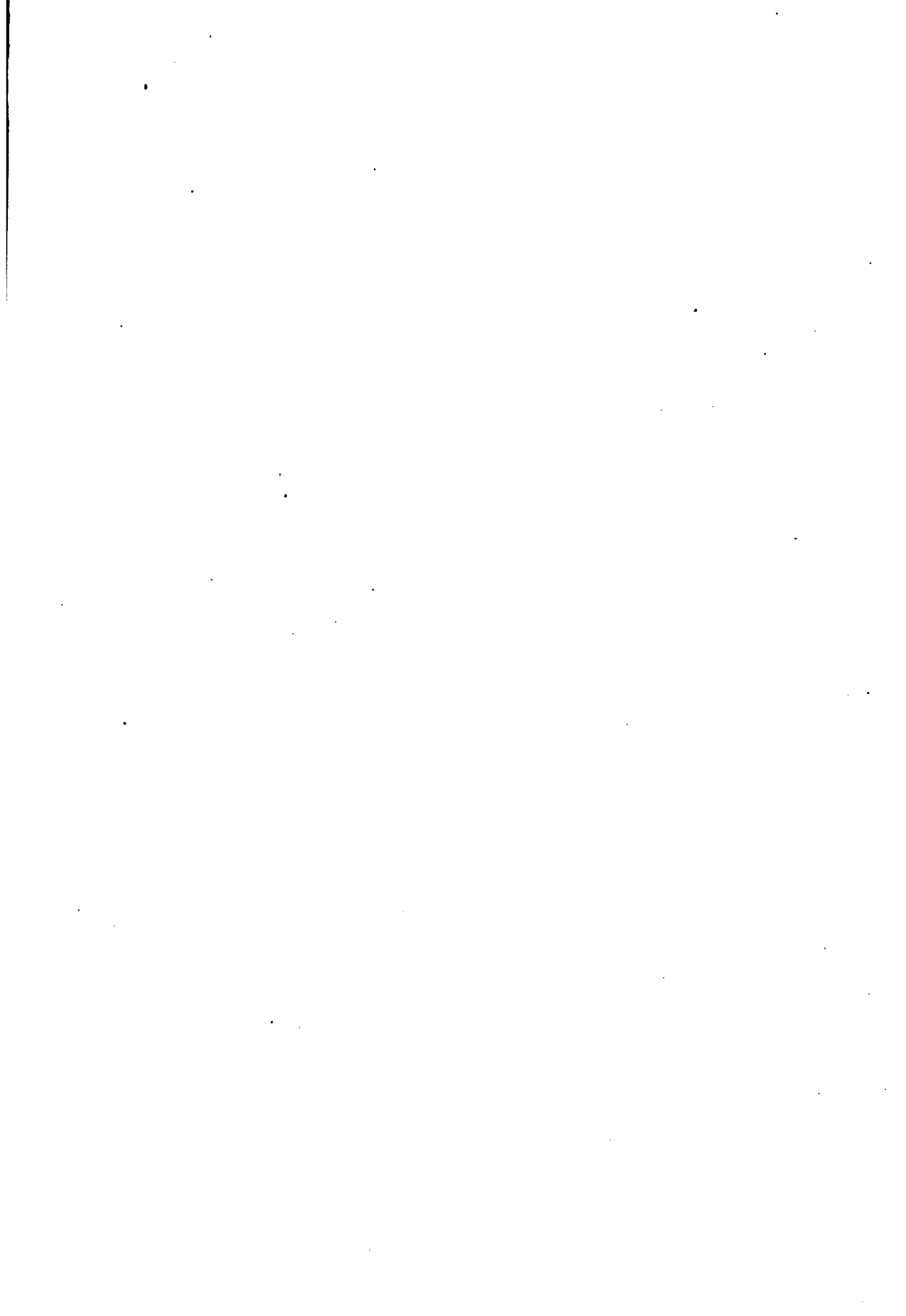

THE  
ENCYCLOPÆDIA BRITANNICA

A  
DICTIONARY

OF  
ARTS, SCIENCES, AND GENERAL LITERATURE

**Fifth Edition—Popular Reprint**

*VOLUME XVIII*

NEW YORK  
HENRY G. ALLEN AND COMPANY  
PUBLISHERS

1888.

KG 580



---

ARGYLE PRESS,  
PRINTING AND BOOKBINDING,  
256 & 257 CHERRY ST., N. Y.

---

# Encyclopædia Britannica—Vol. XVIII.

## PRINCIPAL CONTENTS.

ORNITHOLOGY. Prof. A. NEWTON.  
OSTADE. J. A. CROWE.  
OSTRICH. Prof. A. NEWTON.  
OTTER. Prof. W. H. FLOWER.  
OTWAY. RICHARD GARNETT, LL.D.  
OVID. Prof. W. Y. SELLAR.  
OWEN, JOHN. OSMUND AIRY.  
OWEN, ROBERT. THOMAS KIRKUP.  
OWL. Prof. A. NEWTON.  
OXALIC ACID. Prof. W. DITTMAR.  
OXFORD. F. MADAN.  
OXUS. Lieut.-Gen. WALKER, R.E., C.B.  
OYSTER. J. T. CUNNINGHAM.  
INDUSTRY. G. BROWN GOODE.  
PACIFIC OCEAN. JOHN MURRAY.  
PÆSTUM. J. H. MIDDLETON.  
PAHLAVI. Prof. THEODOR NÖLDEKE.  
PAINTING. GEORGE REID, R.S.A.  
PALÆOGRAPHY. E. MAUNDE THOMPSON.  
PALERMO. E. A. FREEMAN, D.C.L.  
PALESTINE. Prof. ALBRECHT SOGIN.  
PALESTRINA. W. S. ROCKSTRO.  
PALEY. Prof. ANDREW SETH.  
PALL. REINHOLD ROST, LL.D.  
PALM. MAXWELL T. MASTERS, M.D.  
PALMERSTON.  
PALMYRA. Prof. W. ROBERTSON SMITH, LL.D.  
PAMPHLETS. H. R. TEDDER.  
PANGOLIN. OLDFIELD THOMAS.  
PANIZZI. RICHARD GARNETT, LL.D.  
PANTOMIME. Prof. A. W. WARD.  
PAPER. E. MAUNDE THOMPSON and R. C. MENZIES.  
PAPHLAGONIA. E. H. BUNBURY.  
PAPPUS. T. L. HEATH.  
PARACELSUS. Prof. JOHN FERGUSON.  
PARAFFIN. Prof. DITTMAR and JAMES PATON.  
PARALLAX. DAVID GILL, LL.D.  
PARALLELS. Prof. GEORGE CHRYS TAL.  
PARALYSIS. J. O. AFFLECK, M. D.  
PARASITISM—  
ANIMAL. PATRICK GEDDES.  
VEGETABLE. G. R. MILNE MURRAY.  
IN MEDICINE. CHARLES CREIGHTON, M.D.  
PARIS. GASTON MEISSAS and ANTHEME ST. PAUL.  
PARISH. CHARLES I. ELTON.  
PARKER, MATTHEW. J. BASS MULLINGER.  
PARKER, THEODORE. Rev. J. F. SMITH.  
PARLIAMENT. Right Hon. Sir THOMAS ERSKINE  
MAY, K.C.B., D.C.L.  
PARMENIDES. HENRY JACKSON.  
PARMIGIANO. W. M. ROSSETTI.  
PARSEES. A. FÜHRER, Ph.D.  
PARTNERSHIP. JAMES WILLIAMS.  
PASCAL. Geo. SAINTSBURY and Prof. CHRYS TAL.  
PASSOVER. Prof. W. R. SMITH.  
PASTORAL. E. W. GOSSE.  
PASTORAL EPISTLES. Rev. EDWIN HATCH, D.D.  
PATENTS. J. HENRY JOHNSON.  
PATHOLOGY. CHAS. CREIGHTON, M.D.  
PATRON AND CLIENT. Prof. JAMES MUIRHEAD.  
PAUL. Rev. EDWIN HATCH, D.D.

PAUL OF SAMOSATA. Prof. ADOLF HARNACK.  
PAUSANIAS. F. A. PALEY, LL.D.  
PEAL. F. W. RUDLER.  
PEEL. GOLDWIN SMITH, LL.D., and C. S. PARKER,  
M.P.  
PEERAGE. E. A. FREEMAN, D.C.L.  
PEKING. Prof. R. K. DOUGLAS.  
PELAGIUS. Rev. MARCUS DODS, D.D.  
PEN. JAMES PATON.  
PENANCE. Rev. R. F. LITLEDALE, LL.D., D.C.L.  
PENN. OSMUND AIRY.  
PENNSYLVANIA. Prof. J. PETER LESLEY and Rev.  
C. G. AMES.  
PENTATEUCH. Prof. JULIUS WELLSHAUSEN.  
PEPYS. OSMUND AIRY.  
PERFUMERY. C. H. PREESE.  
PERICLES. J. G. FRAZER.  
PERIODICALS. H. R. TEDDER.  
PERIPATETICS. Prof. SETH.  
PERPETUAL MOTION. Prof. CHRYS TAL.  
PERSEPOLIS. Prof. NÖLDEKE.  
PERSIA—  
ANCIENT HISTORY. Prof. NÖLDEKE and Prof. A.  
VON GUTSCHMID.  
MODERN HISTORY AND GEOGRAPHY. Major-General  
Sir FREDERICK GOLDSMID, K.C.S.I.  
LANGUAGE. Prof. K. GELDNER.  
LITERATURE. Prof. HERMANN ETHÉ, Ph.D.  
PERSIUS. Prof. SELLAR.  
PERU. CLEMENTS R. MARKHAM, C.B.  
PERUGINO. W. M. ROSSETTI.  
PESSIMISM. Prof. WM. WALLACE.  
PETER. Rev. E. HATCH, D.D.  
PETRA. Prof. W. R. SMITH.  
PETRARCH. J. A. SYMONDS.  
PETROLEUM. Prof. S. F. PECKHAM.  
PETRONIUS. Prof. SELLAR.  
PHALANGER. OLDFIELD THOMAS.  
PHARMACOPEIA. E. M. HOLMES.  
PHIDIAS. A. S. MURRAY.  
PHILADELPHIA. CHARLES H. HART.  
PHILIP II. Prof. MANDELL CREIGHTON.  
PHILIPPIANS. Rev. E. HATCH, D.D.  
PHILIPPINE ISLANDS. H. A. WEBSTER.  
PHILISTINES. Prof. W. R. SMITH.  
PHILO. Prof. E. SCHÜRER.  
PHILOLOGY. Prof. W. D. WHITNEY.  
ARYAN LANGUAGES. Prof. E. SIEVERS.  
PHILOSOPHY. Prof. SETH.  
PHOCION. J. G. FRAZER.  
PHENICIA. Prof. A. SOGIN and Prof. A. VON GUT  
SCHMID.  
PHOSPHORESCENCE. W. E. HOYLE.  
PHOSPHORUS. Prof. DITTMAR.  
PHOTIUS. R. GARNETT, LL.D.  
PHOTOGRAPHY. Capt. WM. DE W. ABNEY, R.E.  
PHOTOMETRY. Prof. CHARLES PRITCHARD.  
PHRENOLOGY. Prof. A. MACALISTER.  
PHRYGIA. W. M. RAMSAY.  
PHTHISIS. J. O. AFFLECK, M.D.



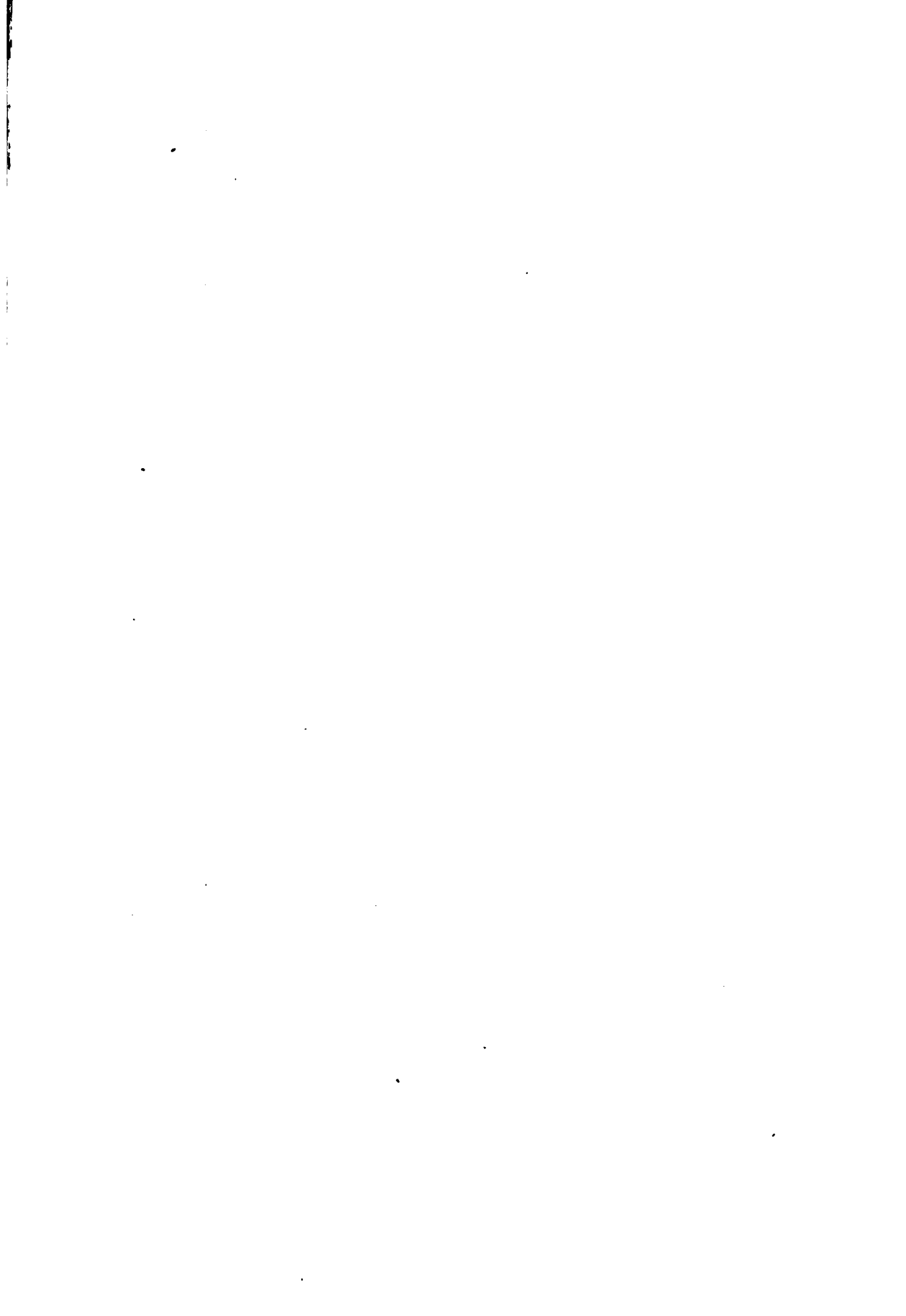

# ENCYCLOPÆDIA BRITANNICA.

## ORNE

**ORNE**, a department of the north-west of France, about half of which formerly belonged to the province of Normandy and the rest to the duchy of Alençon and to Perche, lies between 48° 10' and 48° 58' N. lat., and between 1° E. and 0° 50' W. long., and is bounded N. by Calvados, N.E. by Eure, S.E. by Eure-et-Loir, S. by Sarthe and Mayenne, and W. by Mancha. The greatest length from east to west is 87 miles, and the area 2635 square miles. The population in 1881 numbered 376,126. Geologically there are two distinct regions; to the west of the Orne and the railway from Argentan to Alençon lie primitive rocks connected with those of Brittany; to the east begin the Jurassic and Cretaceous formations of Normandy. The latter district is agriculturally the richest part of the department; in the former the poverty of the soil has led the inhabitants to seek their subsistence from industrial pursuits. Between the northern portions, draining to the Channel, and the southern portion, belonging to the basin of the Loire, stretch the hills of Perche and Normandy, which generally have a height of from 800 to 1000 feet. The highest point in the department, situated in the forest of Écouves north of Alençon, reaches 1378 feet. The department gives birth to three Seine tributaries—the Eure, its affluent the Iton, and the Rille, which passes by Laigle. The Touques, passing by Vimoutier, the Dive, and the Orne fall into the English Channel,—the last passing Sées and Argentan, and receiving the Noireau with its tributary the Vere, which runs past Flers. Towards the Loire flow the Huisne, a feeder of the Sarthe passing by Mortagne, the Sarthe, which passes by Alençon, and the Mayenne, some of whose affluents rise to the north of the dividing range and make their way through it by the most picturesque defiles. Nearly the whole department, indeed, with its beautiful forests containing oaks several centuries old, its green meadows peopled with herds, its limpid streams, its deep gorges, its stupendous rocks, is one of the most picturesque of all France, though neither bathed by the sea nor possessing a truly mountainous character. In the matter of climate Orne belongs to the Seine region. The mean temperature is 50° Fahr.; the summer heat is never extreme; the west winds are the most frequent; the rainfall, distributed over about a hundred days in the year, amounts to

nearly 3 feet, or half as much again as the average for France.

Arable land occupies seven-twelfths of the surface, woods one-eighth, and pasture land almost as much. The live stock comprises 70,000 horses, 4000 asses, 122,000 sheep (35,500 high-bred), yielding in 1878 660,000 lb of wool of the value of nearly £25,000, 53,000 pigs, 2800 goats, 210,000 horned cattle, 30,000 dogs, 700,000 fowls, 53,000 geese, and 15,800 beehives, each producing on the average 2 lb of wax and 20 lb of honey. Horse-breeding is the most flourishing business in the rural districts; there are three breeds—those of Perche, Le Merlerault (a cross between Norman and English horses), and Brittany. The great Government stud of Le Pin is situated between Le Merlerault and Argentan. Several horse-training establishments exist in the department. A large number of lean cattle are bought in the neighbouring departments to be fattened; the farms in the vicinity of Vimoutier, on the borders of Calvados, produce the famous Camembert cheese, and others excellent butter. In 1882 Orne produced 3,288,000 bushels of wheat, mealin 431,000, rye 315,700, barley 1,510,000, oats 3,410,000, buckwheat 600,000, potatoes 654,000, beetroot 939,000 cwt., colza seed 5000 cwt., hemp 8300 cwt., besides fodder in great quantity and variety, pulse, flax, fruits, &c. The variety of production is due to the great natural diversity of the soils. Small farms are the rule, and the fields in those cases are surrounded by hedges relieved by pollard trees. Along the roads or in the enclosures are planted numerous pear and apple trees (nearly 3,000,000), yielding 58,000,000 gallons of cider and perry, part of which is manufactured into brandy. Beech, oak, birch, and pine are the chief timber trees in the extensive forests of the department, of which a third belongs to the state. Orne contains iron ore of poor quality, granite quarries employing from 400 to 500 workmen, and a kind of smoky quartz known as Alençon diamond. Its most celebrated mineral waters are those of the hot springs of Bagnoles, which contain salt, sulphur, and arsenic, and are employed for tonic and restorative purposes in cases of general debility. In the forest of Bellême is the chalybeate spring of La Hesse, which was used by the Romans. The other mineral springs of the department are chalybeate or

sulphurous. Cotton and linen weaving forms the staple industry of Orne, 51 establishments (123,000 spindles and 12,170 looms) being devoted to cotton, 2 establishments (500 spindles) to wool, and 3 establishments (2400 spindles and 2800 looms) to linen. Flers manufactures ticking, table-linen, furniture satin, cotton cloth, and thread, employs 28,000 workmen, and produces to the annual value of £1,520,000. La Ferté Macé employs 10,000 workmen in the hand-loom manufacture of cotton. Alençon and Vimoutier are engaged in the production of linen and canvas, and have also dye-works and bleacheries. About 2000 workmen are employed at Alençon in the making of the lace which takes its name from the town. Foundries, wire-works, and one blast furnace also exist in the department, and cutlery, boilers, and articles in copper,

zinc, and lead are manufactured. Tin wares, pins, and needles are produced at Laigle. Glass-works give employment to 600 workmen, and turn out glass to the value of more than £100,000. There are flourishing paper-mills, tanneries (the waters of the Orne giving a special quality to the leather), and glove-works. There are in all 133 establishments making use of steam (2128 horse-power). There are 848 miles of railway. The department consists of four arrondissements (Alençon, Argentan, Domfront, and Mortagne), 36 cantons, and 511 communes, forms the diocese of Sées, depends on the Caen court of appeal, and is included in the corps d'armées of Le Mans. The communes with more than 5000 inhabitants are Alençon (17,237), Flers (12,304), La Ferté Macé (9396), Argentan (6300), and Laigle (5303).

## ORNITHOLOGY

ORNITHOLOGY<sup>1</sup> in its proper sense is the methodical study and consequent knowledge of Birds with all that relates to them; but the difficulty of assigning a limit to the commencement of such study and knowledge gives the word a very vague meaning, and practically procures its application to much that does not enter the domain of Science. This elastic application renders it impossible in the following sketch of the history of Ornithology to draw any sharp distinction between works that are emphatically ornithological and those to which that title can only be attached by courtesy; for, since Birds have always attracted far greater attention than any other group of animals with which in number or in importance they can be compared, there has grown up concerning them a literature of corresponding magnitude and of the widest range, extending from the recondite and laborious investigations of the morphologist and anatomist to the casual observations of the sportsman or the schoolboy. The chief cause of the disproportionate amount of attention which Birds have received plainly arises from the way in which so many of them familiarly present themselves to us, or even (it may be said) force themselves upon our notice. Trusting to the freedom from danger conferred by the power of flight, most Birds have no need to lurk hidden in dens, or to alink from place to place under shelter of the inequalities of the ground or of the vegetation which clothes it, as is the case with so many other animals of similar size. Besides this, a great number of the Birds which thus display themselves freely to our gaze are conspicuous for the beauty of their plumage; and there are very few that are not remarkable for the grace of their form. Some Birds again enchant us with their voice, and others administer to our luxuries and wants, while there is scarcely a species which has not idiosyncrasies that are found to be of engaging interest the more we know of them. Moreover, it is clear that the art of the fowler is one that must have been practised from the very earliest times, and to follow that art with success no inconsiderable amount of acquaintance with the haunts and habits of Birds is a necessity. Owing to one or another of these causes, or to the combination of more than one, it is not surprising that the observation of Birds has been from a very remote period a favourite pursuit among nearly all nations, and this observation has by degrees led to a study more or less framed on methodical principles, finally reaching the dignity of a

science, and a study that has its votaries in almost all classes of the population of every civilized country. In the ages during which intelligence dawned on the world's total ignorance, and even now in those districts that have not yet emerged from the twilight of a knowledge still more imperfect than is our own at present,<sup>2</sup> an additional and perhaps a stronger reason for paying attention to the ways of Birds existed, or exists, in their association with the cherished beliefs handed down from generation to generation among many races of men, and not unfrequently interwoven in their mythology.<sup>3</sup>

Moreover, though Birds make a not unimportant appearance in the earliest written records of the human race, the painter's brush has preserved their counterfeit presentment for a still longer period. What is asserted—and that, so far as the writer is aware, without contradiction—by Egyptologists of the highest repute to be the oldest picture in the world is a fragmentary fresco taken from a tomb at Maydoom, and happily deposited, though in a decaying condition, in the Museum at Boolak. This picture is said to date from the time of the third or fourth dynasty, some three thousand years before the Christian era. In it are depicted with a marvellous fidelity, and thorough appreciation of form and colouring (despite a certain conventional treatment), the figures of six Geese. Four of these figures can be unhesitatingly referred to two species (*Anser albifrons* and *A. ruficollis*) well known at the present day; and if the two remaining figures, belonging to a third species, were re-examined by an expert they would very possibly be capable of determination with no less certainty.<sup>4</sup> In later ages the representations of Birds of one sort or another in Egyptian paintings and sculptures become countless, and the *bas-reliefs* of Assyrian monuments, though mostly belonging of course to a subsequent period, are not without them. No figures of Birds, however, seem yet to have been found on the incised stones, bones, or ivories of the prehistoric races of Europe.

It is of course necessary to name ARISTOTLE (born B.C. 385, died B.C. 322) as the first serious author on Ornithology with whose writings we are acquainted, but even he had,

<sup>1</sup> Of the imperfection of our present knowledge more must be said presently.

<sup>2</sup> For instances of this among Greeks and Romans almost any dictionary or treatise of "Classical Antiquities" may be consulted, while as regards the superstitious or barbarous nations the authorities are far too numerous to be here named.

<sup>3</sup> The portion of the picture containing the figures of the Geese has been figured by Mr LORIN (*Ride in Egypt*, p. 209), and the present writer owes to that gentleman's kindness the opportunity of examining a copy made on the spot by an accomplished artist, as well as the information that it is No. 988 of Mariette's *Catalogue*. See art. MURAL DECORATION, vol. xvii. p. 29, fig. 7.

<sup>1</sup> *Ornithologia*, from the Greek ὄρνιθ, crude form of ὄρνις, a bird, and -λογία, allied to λόγος, commonly Englished a discourse. The earliest known use of the word Ornithology seems to be in the third edition of Blount's *Glossographia* (1670), where it is noted as being "the title of a late Book." See Prof. Skeat's *Etymological Dictionary of the English Language*.

as he tells us, predecessors; and, looking to that portion of his works on animals which has come down to us, one finds that, though more than 170 sorts of Birds are mentioned,<sup>1</sup> yet what is said of them amounts on the whole to very little, and this consists more of desultory observations in illustration of his general remarks (which are to a considerable extent physiological or bearing on the subject of reproduction) than of an attempt at a connected account of Birds. Some of these observations are so meagre as to have given plenty of occupation to his many commentators, who with varying success have for more than three hundred years been endeavouring to determine what were the Birds of which he wrote; and the admittedly corrupt state of the text adds to their difficulties. One of the most recent of these commentators, the late Prof. Sundevall—equally proficient in classical as in ornithological knowledge—was, in 1863, compelled to leave more than a score of the Birds unrecognized. Yet it is not to be supposed that in what survives of the great philosopher's writings we have more than a fragment of the knowledge possessed by him, though the hope of recovering his Ζωικά or his Ἀνατομικά, in which he seems to have given fuller descriptions of the animals he knew, can be hardly now entertained. A Latin translation by Gaza of Aristotle's existing zoological work was printed at Venice in 1503. Another version, by Scaliger, was subsequently published. Two wretched English translations have appeared.

Next in order of date, though at a long interval, comes CAIUS PLINIUS SECUNDUS, commonly known as PLINY the Elder, who died A.D. 79, author of a general and very discursive *Historia Naturalis* in thirty-seven books, of which Book X. is devoted to Birds. A considerable portion of Pliny's work may be traced to his great predecessor, of whose information he freely and avowedly availed himself, while the additions thereto made cannot be said to be, on the whole, improvements. Neither of these authors attempted to classify the Birds known to them beyond a very rough and for the most part obvious grouping. Aristotle seems to recognize eight principal groups:—(1) *Gampomyches*, approximately equivalent to the *Accipitres* of Linnæus; (2) *Scolecophaga*, containing most of what would now be called *Oscines*, excepting indeed the (3) *Acanthophaga*, composed of the Goldfinch, Siskin, and a few others; (4) *Scopophaga*, the Woodpeckers; (5) *Peristeroide*, or Pigeons; (6) *Schiopoda*, (7) *Steganopoda*, and (8) *Barea*, nearly the same respectively as the Linnæan *Grallæ*, *Anseres*, and *Callinæ*. Pliny, relying wholly on characters taken from the feet, limits himself to three groups—without assigning names to them—those which have “hooked talons, as Hawkes; or round long claws, as Hennes; or else they be broad, flat, and whole-footed, as Geese and all the sort in manner of water-foule”—to use the words of Philemon Holland, who, in 1601, published a quaint and, though condensed, yet fairly faithful English translation of Pliny's work.

About a century later came ÆLIAN, who died about A.D. 140, and compiled in Greek (though he was an Italian by birth) a number of miscellaneous observations on the peculiarities of animals. His work is a kind of commonplace book kept without scientific discrimination. A considerable number of Birds are mentioned, and something said of almost each of them; but that something is too often nonsense—according to modern ideas—though occasionally a fact of interest may therein be found. It contains numerous references to former or contemporary writers whose works have perished, but there is nothing to show that they were wiser than Ælian himself.

The twenty-six books *De Animalibus* of ALBERTUS MAGNUS (GROOT), who died A.D. 1282, were printed in 1478; but were apparently already well known from manuscript copies. They are founded on the works of Aristotle, many of whose statements are almost literally repeated, and often without acknowledgment. Occasionally Avicenna, or some other less-known author, is quoted; but it is hardly too much to say that the additional information is almost worthless. The twenty-third of these books is *De Avibus*, and therein a great number of Birds' names make their earliest appearance, few of which are without interest from a philologist's if not an ornithologist's point of view, but there is much difficulty in recognising the species to which many of them belong. In 1485 was printed the first dated copy of the volume known as the *Ortus Sanitatis*, to the popularity of which many editions testify. Though said by its author, JOHANN WÖNNKÖCKE VON CAUS (Latinized as JOHANNES DE CUBA),<sup>2</sup> to have been composed from a study of the collections formed by a certain nobleman who had travelled in Eastern Europe, Western Asia, and Egypt—possibly Breidenbach, an account of whose travels in the Levant was printed at Ments in 1486—it is really a medical treatise, and its zoological portion is mainly an abbreviation of the writings of Albertus Magnus, with a few interpolations from Isidorus of Seville (who flourished in the beginning of the seventh century, and was the author of many works highly esteemed in the Middle Ages) and a work known as *PHYSIOLOGUS* (q.v.). The third *tractatus* of this volume deals with Birds—including among them Bats, Bees, and other flying creatures; but as it is the first printed book in which figures of Birds are introduced it merits notice, though most of the illustrations, which are rude woodcuts, fail, even in the coloured copies, to give any precise indication of the species intended to be represented. The scientific degeneracy of this work is manifested as much by its title (*Ortus* for *Hortus*) as by the mode in which the several subjects are treated;<sup>3</sup> but the revival of learning was at hand, and WILLIAM TURNER, a Northumbrian, while residing abroad to avoid persecution at home, printed at Cologne in 1544 the first commentary on the Birds mentioned by Aristotle and Pliny conceived in anything like the spirit that moves modern naturalists.<sup>4</sup> In the same year and from the same press was issued a *Dialogus de Avibus* by GYBERTUS LONGOLIVUS, and in 1570 CAIUS brought out in London his treatise *De variorum animalium atque stirpium historia*. In this last work, small though it be, ornithology has a good share; and all three may still be consulted with interest and advantage by its votaries.<sup>5</sup> Meanwhile the study received a great impulse from the appearance, at Zurich in 1555, of the third book of the illustrious CONRAD GESNER's *Historia Animalium* “*qvi est de Anium natura*,” and at Paris in the same year

<sup>1</sup> On this point see G. A. Pritzel, *Botan. Zeitung*, 1846, pp. 785-790, and *Theor. Literat. Botanica* (Lipsia: 1851), pp. 349-352.

<sup>2</sup> Absurd as much that we find both in Albertus Magnus and the *Ortus* seems to modern eyes, if we go a step lower in the scale and consult the “*Bæstiarie*” or treatises on animals which were common from the twelfth to the fourteenth century we shall meet with many more absurdities. See for instance that by PHILIPPUS DE TRAVUN (PHILIPPUS TRAVUNENSIS), dedicated to Adelaide or Alice, queen of Henry I. of England, and probably written soon after 1121, as printed by the late Mr Thomas Wright, in his *Popular Treatises on Science written during the Middle Ages* (London: 1841).

<sup>3</sup> This was reprinted at Cambridge in 1823 by the late Dr George Thackeray.

<sup>4</sup> The Seventh of WORTON's *De differentiis animalium Libri Decem*, published at Paris in 1552, treats of Birds; but his work is merely a compilation from Aristotle and Pliny, with references to other classical writers who have more or less incidentally mentioned Birds and other animals. The author in his preface states—“*Veterum scriptorum sententias in unum quasi cumulum coaceruavi, de meo nihil addidi.*” Nevertheless he makes some attempt at a systematic arrangement of Birds, which, according to his lights, is far from despicable.

<sup>5</sup> This is Sundevall's estimate; Drs Aubert and Wimmer in their excellent edition of the *Trotopus septi* (Leipzig: 1866) limit the number to 125.

of Pierre BELON'S (BELLONTIUS) *Histoire de la nature des Oyseaux*. Gesner brought an amount of erudition, hitherto unequalled, to bear upon his subject; and, making due allowance for the times in which he wrote, his judgment must in most respects be deemed excellent. In his work, however, there is little that can be called systematic treatment. Like nearly all his predecessors since Elian, he adopted an alphabetical arrangement,<sup>1</sup> though this was not too pedantically preserved, and did not hinder him from placing together the kinds of Birds which he supposed (and generally supposed rightly) to have the most resemblance to that one whose name, being best known, was chosen for the headpiece (as it were) of his particular theme, thus recognizing to some extent the principle of classification.<sup>2</sup> Belon, with perhaps less book-learning than his contemporary, was evidently no mean scholar, and undoubtedly had more practical knowledge of Birds—their internal as well as external structure. Hence his work, written in French, contains a far greater amount of original matter; and his personal observations made in many countries, from England to Egypt, enabled him to avoid most of the puerilities which disfigure other works of his own or of a preceding age. Besides this, Belon disposed the Birds known to him according to a definite system, which (rude as we now know it to be) formed a foundation on which several of his successors were content to build, and even to this day traces of its influence may still be discerned in the arrangement followed by writers who have faintly appreciated the principles on which modern taxonomers rest the outline of their schemes. Both his work and that of Gesner were illustrated with woodcuts, many of which display much spirit and regard to accuracy.

Belon, as has just been said, had a knowledge of the anatomy of Birds, and he seems to have been the first to institute a direct comparison of their skeleton with that of Man; but in this respect he only anticipated by a few years the more precise researches of VOLCHER COITER, a Frisian, who in 1573 and 1575 published at Nuremberg two treatises, in one of which the internal structure of Birds in general is very creditably described, while in the other the osteology and myology of certain forms is given in considerable detail, and illustrated by carefully-drawn figures. The first is entitled *Externarum et internarum principalium humani corporis Tubula*, &c., while the second, which is the most valuable, is merely appended to the *Lectioes Gabrielis Fallopi de partibus similaribus humani corporis*, &c., and thus, the scope of each work being regarded as medical, the author's labours were wholly overlooked by the mere natural-historians who followed, though Coiter introduced a table, "*De differentiis Avium*," furnishing a key to a rough classification of such Birds as were known to him, and this as nearly the first attempt of the kind deserves notice here.

Contemporary with these three men was ULYSSES ALDROVANDUS, a Bolognese, who wrote an *Historia Naturalium* in sixteen folio volumes, most of which were not printed till after his death in 1605; but those on Birds appeared between 1599 and 1603. The work is almost wholly a compilation, and that not of the most discriminative kind, while a peculiar jealousy of Gesner is continually displayed, though his statements are very constantly quoted—nearly always as those of "Ornithologus," his name appearing but few times in the text, and not at all in the list of authors

<sup>1</sup> Even at the present day it may be shrewdly suspected that not a few ornithologists would gladly follow Gesner's plan in their despair of seeing, in their own time, a classification which would really deserve the epithet scientific.

<sup>2</sup> For instance, under the title of "Accipiter" we have to look, not only for the Sparrow-Hawk and Gos-Hawk, but for many other Birds of the Family (as we now call it) removed comparatively far from those species by modern ornithologists.

cited. With certain modifications in principle not very important, but characterized by much more elaborate detail, Aldrovandus adopted Belon's method of arrangement, but in a few respects there is a manifest retrogression. The work of Aldrovandus was illustrated by copper-plates, but none of his figures approach those of his immediate predecessors in character or accuracy. Nevertheless the book was eagerly sought, and several editions of it appeared.<sup>3</sup>

Mention must be made of a medical treatise by CARPUS SCHWENCKFELD, published at Liegnitz in 1603, under the title of *Theriotropeum Silesie*, the fourth book of which consists of an "Aviarium Silesie," and is the earliest of the works we now know by the name of Fauna. The author was well acquainted with the labours of his predecessors, as his list of over one hundred of them testifies. Most of the Birds he describes are characterized with accuracy sufficient to enable them to be identified, and his observations upon them have still some interest; but he was innocent of any methodical system, and was not exempt from most of the professional fallacies of his time.<sup>4</sup>

Hitherto, from the nature of the case, the works aforesaid consisted of scarcely any but the Birds belonging to the *orbis veteribus notus*; but the geographical discoveries of the sixteenth century began to bear fruit, and many animals of kinds unsuspected were, about one hundred years later, made known. Here there is only space to name BONTIUS, CLUSIUS, HERNANDEZ (or FERNANDEZ), MARCGRAVE, NIEMERBERG, and PISO,<sup>5</sup> whose several works describing the natural products of both the Indies—whether the result of their own observation or compilation—together with those of OLINA and WORM, produced a marked effect, since they led up to what may be deemed the foundation of scientific Ornithology.<sup>6</sup>

This foundation was laid by the joint labours of FRANCIS WILLUGHBY (born 1635, died 1672) and JOHN RAY (born 1628, died 1705), for it is impossible to separate their share of work in Natural History more than to say that, while the former more especially devoted himself to zoology, botany was the favourite pursuit of the latter. Together they studied, together they travelled, and together they collected. Willughby, the younger of the two, and at first the other's pupil, seems to have gradually become the master; but, he dying before the promise of his life was fulfilled, his writings were given to the world by his friend Ray, who, adding to them from his own stores, published the *Ornithologia* in Latin in 1676, and in English with many amendments in 1678. In this work Birds generally were grouped in two great divisions—"Land-Fowl" and "Water-Fowl"—the former being subdivided into those which have a crooked beak and talons and those which have a straighter bill and claws, while the latter was separated into those which frequent waters and watery places and those that swim in the water—each subdivision being further broken up into many sections, to the whole of which a key was given. Thus it became possible for almost any diligent reader without much chance of error to refer to its

<sup>3</sup> The *Historia Naturalis* of JOHANNES JOHNSTONUS, said to be of Scottish descent but by birth a Pole, ran through several editions during the seventeenth century, but is little more than an epitome of the work of Aldrovandus.

<sup>4</sup> The *Hiernicon* of Bochart—a treatise on the animals named in Holy Writ—was published in 1619.

<sup>5</sup> For Lichtentstein's determination of the Birds described by Marcgrave and Piso see the *Abhandlungen* of the Berlin Academy for 1817 (pp. 155 sq.).

<sup>6</sup> The earliest list of British Birds seems to be that in the *Pinax Rerum Naturalium* of CHRISTOPHER MERRET, published in 1667. In the following year appeared the *Onomasticon Zoologicum* of WALTER CHARLETON, which contains some information on ornithology. An enlarged edition of the latter, under the title of *Exercitationes* &c., was published in 1677; but neither of these writers is of much authority. In 1684 SIBBALD in his *Scotia Illustrata* published the earliest Fauna of Scotland.

proper place nearly every bird he was likely to meet with. Ray's interest in ornithology continued, and in 1694 he completed a *Synopsis Methodica Avium*, which, through the fault of the booksellers to whom it was entrusted, was not published till 1713, when Darham gave it to the world.<sup>1</sup>

Two years after Ray's death, LINNÆUS, the great reformer of Natural History, was born, and in 1736 appeared the first edition of the celebrated *Systema Naturæ*. Successive editions of this work were produced under its author's supervision in 1740, 1748, 1758, and 1766. Impressed by the belief that verbosity was the bane of science, he carried terseness to an extreme which frequently created obscurity, and this in no branch of zoology more than in that which relates to Birds. Still the practice introduced by him of assigning to each species a diagnosis by which it ought in theory to be distinguishable from any other known species, and of naming it by two words—the first being the generic and the second the specific term, was so manifest an improvement upon any thing which had previously obtained that the Linnæan method of differentiation and nomenclature established itself before long in spite of all opposition, and in principle became almost universally adopted. The opposition came of course from those who were habituated to the older state of things, and saw no evil in the cumbersome, half-descriptive half-designative titles which had to be employed whenever a species was to be spoken of or written about. The supporters of the new method were the rising generation of naturalists, many of whose names have since become famous, but among them were some whose admiration of their chief carried them to a pitch of enthusiasm which now seems absurd. Careful as Linnæus was in drawing up his definitions of groups, it was immediately seen that they occasionally were made to comprehend creatures whose characteristics contradicted the prescribed diagnosis. His chief glory lies in his having reduced, at least for a time, a chaos into order, and in his shewing both by precept and practice that a name was not a definition. In his classification of Birds he for the most part followed Ray, and where he departed from his model he seldom improved upon it.

In 1745 BARKER brought out at Perpignan a little book called *Ornithologia Specimen novum*, and in 1752 MÖHRING published at Aurich one still smaller, his *Avium Genera*. Both these works (now rare) are manifestly framed on the Linnæan method, so far as it had then reached; but in their arrangement of the various forms of Birds they differed greatly from that which they designed to supplant, and they deservedly obtained little success. Yet as systematists their authors were no worse than KLEIN, whose *Historia Avium Prodromus*, appearing at Lübeck in 1750, and *Stemmata Avium* at Leipzig in 1759, met with considerable favour in some quarters. The chief merit of the latter work lies in its forty plates, whereon the heads and feet of many Birds are indifferently figured.<sup>2</sup>

But, while the successive editions of Linnæus's great work were revolutionizing Natural History, and his example of precision in language producing excellent effect on scientific writers, several other authors were advancing the study of Ornithology in a very different way—a way that pleased the eye even more than his labours were pleasing the mind. Between 1731 and 1743 MARK CATESBY brought out in

London his *Natural History of Carolina*—two large folios containing highly-coloured plates of the Birds of that colony, Florida, and the Bahamas—the forerunners of those numerous costly tomes which will have to be mentioned presently at greater length.<sup>3</sup> ELIAZAR ALBIN between 1738 and 1740 produced a *Natural History of Birds* in three volumes of more modest dimensions, seeing that it is in quarto; but he seems to have been ignorant of Ornithology, and his coloured plates are greatly inferior to Catesby's. Far better both as draughtsman and as authority was GEORGE EDWARDS, who in 1743 began, under the same title as Albin, a series of plates with letter-press, which was continued by the name of *Gleanings in Natural History*, and finished in 1760, when it had reached seven parts, forming four quarto volumes, the figures of which are nearly always quoted with approval.<sup>4</sup>

The year which saw the works of Edwards completed was still further distinguished by the appearance in France, where little had been done since Belon's days,<sup>5</sup> in six quarto volumes, of the *Ornithologie* of MATHURIN JACQUES BRISSON—a work of very great merit so far as it goes, for as a descriptive ornithologist the author stands even now unsurpassed; but it must be said that his knowledge, according to internal evidence, was confined to books and to the external parts of Birds' skins. It was enough for him to give a scrupulously exact description of such specimens as came under his eye, distinguishing these by prefixing two asterisks to their name, using a single asterisk where he had only seen a part of the Bird, and leaving unmarked those that he described from other authors. He also added information as to the Museum (generally Réaumur's, of which he had been in charge) containing the specimen he described, acting on a principle which would have been advantageously adopted by many of his contemporaries and successors. His attempt at classification was certainly better than that of Linnæus; and it is rather curious that the researches of the latest ornithologists point to results in some degree comparable with Brisson's systematic arrangement, for they refuse to keep the Birds-of-Prey at the head of the Class *Avæ*, and they require the establishment of a much larger number of "Orders" than for a long while has been thought advisable. Of such "Orders" Brisson had twenty-six, and he gave Pigeons and Poultry precedence of the Birds which are plunderers and scavengers. But greater value lies in his generic or sub-generic divisions, which, taken as a whole, are far more natural than those of Linnæus, and consequently capable of better diagnosis. More than this, he seems to be the earliest ornithologist, perhaps the earliest zoologist, to conceive the idea of each genus possessing what is now called a "type"—though such a term does not occur in his work; and, in like manner, without declaring it in so many words, he indicated unmistakably the existence of subgenera—all this being effected by the skillful use of names. Unfortunately he was too soon in the field to avail himself, even had he been so minded, of the convenient mode of nomenclature brought into use by Linnæus. Immediately on the completion of his *Règne Animal* in 1766, Brisson set about his *Ornithologie*, and it is only in the last two volumes of the latter that any reference is made to the tenth edition of the *Systema Naturæ*, in which the binomial method

<sup>1</sup> To this was added a supplement by PRYMER on the Bird of Madras, taken from pictures and information sent him by one Edward Buckley of Fort St George, being the first attempt to catalogue the Birds of any part of the British possessions in India.

<sup>2</sup> After Klein's death his *Prodromus*, written in Latin, had the unexpected fortune of two distinct translations into German, published in the same year 1760, the one at Leipzig and Lübeck by BEHR, the other at Danzig by RAYGER—each of whom added more or less to the original.

<sup>3</sup> Several Birds from Jamaica were figured in SLOAN'S *Voyage*, &c. (1705-1725), and a good many exotic species in the *Thesaurus*, &c., of SEDA (1784-1765), but from their faulty execution these plates had little effect upon Ornithology.

<sup>4</sup> The works of Catesby and Edwards were afterwards reproduced at Nuremberg and Amsterdam by SULTZMANN, with the letterpress in German, French, and Dutch.

<sup>5</sup> Birds were treated of in a worthless fashion by one D. B. in a *Dictionnaire raisonné et universel des animaux*, published at Paris in 1759.

was introduced. It is certain that the first four volumes were written if not printed before that method was promulgated, and when the fame of Linnæus as a zoologist rested on little more than the very meagre sixth edition of the *Systema Naturæ* and the first edition of his *Fauna Suecica*. Brisson has been charged with jealousy if not hostility to the great Swede, and it is true that in the preface to his *Ornithologie* he complains of the insufficiency of the Linnæan characters, but, when one considers how much better acquainted with Birds the Frenchman was, such criticism must be allowed to be pardonable if not wholly just. Brisson's work was in French, with a parallel translation in Latin, which last was reprinted separately at Leyden two years afterwards.

In 1767 there was issued at Paris a book entitled *L'histoire naturelle éclaircie dans une de ses parties principales, l'Ornithologie*. This was the work of SALERNE, published after his death, and is often spoken of as being a mere translation of Ray's *Synopsis*, but is thereby very inadequately described, for, though it is confessedly founded on that little book, a vast amount of fresh matter, and mostly of good quality, is added.

The success of Edwards's very respectable work seems to have provoked competition, and in 1765, at the instigation of Buffon, the younger D'AUBERTON began the publication known as the *Planches Enluminées d'histoire naturelle*, which appearing in forty-two parts was not completed till 1780, when the plates<sup>1</sup> it contained reached the number of 1008—all coloured, as its title intimates, and nearly all representing Birds. This enormous work was subsidized by the French Government; and, though the figures are utterly devoid of artistic merit, they display the species they are intended to depict with sufficient approach to fidelity to ensure recognition in most cases without fear of error, which in the absence of any text is no small praise.<sup>2</sup>

But BUFFON was not content with merely causing to be published this unparalleled set of plates. He seems to have regarded the work just named as a necessary precursor to his own labours in Ornithology. His *Histoire Naturelle, générale et particulière*, was begun in 1749, and in 1770 he brought out, with the assistance of GÉNÉAU DE MONTBELLARD,<sup>3</sup> the first volume of that grand undertaking relating to Birds, which, for the first time since the days of Aristotle, became the theme of one who possessed real literary capacity. It is not too much to say that Buffon's florid fancy revelled in such a subject as was now that on which he exercised his brilliant pen; but it would be unjust to examine too closely what to many of his contemporaries seemed sound philosophical reasoning under the light that has since burst upon us. Strictly orthodox though he professed to be, there were those, both among his own countrymen and foreigners, who could not read his speculative indictments of the workings of Nature without a shudder; and it is easy for any one in these days to frame a reply, pointed with ridicule, to such a chapter as he wrote on the wretched fate of the Woodpecker. In the nine volumes devoted to the *Histoire Naturelle des Oiseaux* there are passages which will for ever live in the memory of those

that carefully read them, however much occasional expressions, or even the general tone of the author, may grate upon their feelings. He too was the first man who formed any theory that may be called reasonable of the Geographical Distribution of Animals, though this theory was scarcely touched in the ornithological portion of his work, and has since proved to be not in accordance with facts. He proclaimed the variability of species in opposition to the views of Linnæus as to their fixity, and moreover supposed that this variability arose in part by degradation.<sup>4</sup> Taking his labours as a whole, there cannot be a doubt that he enormously enlarged the purview of naturalists, and, even if limited to Birds, that, on the completion of his work upon them in 1783, Ornithology stood in a very different position from that which it had before occupied. Because he opposed the system of Linnæus he has been said to be opposed to systems in general; but that is scarcely correct, for he had a system of his own; and, as we now see it, it appears neither much better nor much worse than the systems which had been hitherto invented, or perhaps than any which was for many years to come propounded. It is certain that he despised any kind of scientific phraseology—a crime in the eyes of those who consider precise nomenclature to be the end of science; but those who deem it merely a means whereby knowledge can be securely stored will take a different view—and have done so.

Great as were the services of Buffon to Ornithology in one direction, those of a wholly different kind rendered by our countryman JOHN LATHAM must not be overlooked. In 1781 he began a work the practical utility of which was immediately recognized. This was his *General Synopsis of Birds*, and, though formed generally on the model of Linnæus, greatly diverged in some respects therefrom. The classification was modified, chiefly on the old lines of Willughby and Ray, and certainly for the better; but no scientific nomenclature was adopted, which, as the author subsequently found, was a change for the worse. His scope was co-extensive with that of Brisson, but Latham did not possess the inborn faculty of picking out the character wherein one species differs from another. His opportunities of becoming acquainted with Birds were hardly inferior to Brisson's, for during Latham's long lifetime there poured in upon him countless new discoveries from all parts of the world, but especially from the newly-explored shores of Australia and the islands of the Pacific Ocean. The British Museum had been formed, and he had access to everything it contained in addition to the abundant materials afforded him by the private Museum of Sir Ashton Lever.<sup>5</sup> Latham entered, so far as the limits of his work would allow, into the history of the Birds he described, and this with evident zest, whereby he differed from his French predecessor; but the number of cases in which he erred as to the determination of his species must be very great, and not unfrequently the same species is described more than once. His *Synopsis* was finished in 1785; two supplements were added in 1787 and 1802,<sup>6</sup> and in 1790 he produced an abstract of the work under the title of *Index Ornithologicus*, wherein he assigned names on the Linnæan method to all the species described. Not to recur again to his labours, it may be said here that between 1821 and 1828 he published at Winchester, in eleven volumes, an enlarged edition of his original work, entitling it *A General History of Birds*; but his defects as

<sup>1</sup> They were drawn and engraved by MARTINET, who himself began in 1787 a *Histoire des Oiseaux* with small coloured plates which have some merit, but the text is worthless. The work seems not to have been finished and is rare. For the opportunity of seeing a copy the writer is indebted to Mr Gurney.

<sup>2</sup> Between 1767 and 1776 there appeared at Florence a *Storia Naturale degli Uccelli*, in five folio volumes, containing a number of ill-drawn and ill-coloured figures from the collection of Giovanni Gorini, an ardent collector who died in 1751, and therefore must be acquitted of any share in the work, which, though sometimes attributed to him, is that of certain learned men who did not happen to be ornithologists (cf. Savi, *Ornithologia Toscana*, I. Introduzione, p. v).

<sup>3</sup> He retired on the completion of the sixth volume, and thereupon Buffon associated Bezon with himself.

<sup>4</sup> See Prof. Mivart's address to the Section of Biology, *Rep. Brit. Association* (Sheffield Meeting), 1879, p. 356.

<sup>5</sup> In 1792 SHAW began the *Museum Leveianum* in illustration of this collection, which was finally dispersed by sale, and what is known to remain of it found its way to Vienna. Of the specimens in the British Museum described by Latham it is to be feared that scarcely any exist. They were probably very imperfectly prepared.

<sup>6</sup> A German translation by Bechstein subsequently appeared.

a compiler, which had been manifest before, rather increased with age, and the consequences were not happy.<sup>1</sup>

About the time that Buffon was bringing to an end his studies of Birds, MAUDUYT undertook to write the *Ornithologie* of the *Encyclopédie Méthodique*—a comparatively easy task, considering the recent works of his fellow-countrymen on that subject, and finished in 1784. Here it requires no further comment, especially as a new edition was called for in 1790, the ornithological portion of which was begun by BONMATERRE, who, however, had only finished three hundred and twenty pages of it when he lost his life in the French Revolution; and the work thus arrested was continued by VIEILLOT under the slightly changed title of *Tableaux encyclopédiques et méthodiques des trois règnes de la Nature*—the *Ornithologie* forming volumes four to seven, and not completed till 1823. In the former edition Mauduyt had taken the subjects alphabetically; but here they are disposed according to an arrangement, with some few modifications, furnished by D'Aubenton, which is extremely shallow and unworthy of consideration.

Several other works bearing upon Ornithology in general, but of less importance than most of those just named, belong to this period. Among others may be mentioned the *Genera of Birds* by THOMAS PENNANT, first printed at Edinburgh in 1773, but best known by the edition which appeared in London in 1781; the *Elementa Ornithologica* and *Museum Ornithologicum* of SCHAEFER, published at Ratisbon in 1774 and 1784 respectively; PETER BROWN'S *New Illustrations of Zoology* in London in 1776; HEKMAN'S *Tabulae Affinitatum Animalium* at Strasburg in 1783, followed posthumously in 1804 by his *Observationes Zoologicae*; JACQUIN'S *Beitraege zur Geschichte der Voegel* at Vienna in 1784, and in 1790 at the same place the larger work of SPALOWSKY with nearly the same title; SPARRMAN'S *Museum Carolinianum* at Stockholm from 1786 to 1789; and in 1794 HAYES'S *Portraits of rare and curious Birds* from the menagerie of Child the banker at Osterley near London. The same draughtsman (who had in 1775 produced a *History of British Birds*) in 1822 began another series of *Figures of rare and curious Birds*.<sup>2</sup>

The practice of Brisson, Buffon, Latham, and others of neglecting to name after the Linnæan fashion the species they described gave great encouragement to compilation, and led to what has proved to be of some inconvenience to modern ornithologists. In 1773 P. L. S. MÜLLER brought out at Nuremberg a German translation of the *Systema Naturæ*, completing it in 1776 by a *Supplement* containing a list of animals thus described, which had hitherto been technically anonymous, with diagnoses and names on the Linnæan model. In 1783 BODDART printed at Utrecht a *Table des Planches Enluminées*,<sup>3</sup> in which he attempted to refer every species of Bird figured in that extensive series to its proper Linnæan genus, and to assign it a scientific name if it did not already possess one. In like manner in 1786, SCOPOLI—already the author of a little book published

at Leipzig in 1769 under the title of *Annus I. Historico-naturalis*, in which are described many Birds, mostly from his own collection or the Imperial vivarium at Vienna—was at the pains to print at Pavia in his miscellaneous *Delicious Flora et Fauna Insubrica a Specimen Zoologicum*<sup>4</sup> containing diagnoses, duly named, of the Birds discovered and described by SONNERAT in his *Voyage aux Indes orientales* and *Voyage à la Nouvelle Guinée*, severally published at Paris in 1772 and 1776. But the most striking example of compilation was that exhibited by J. F. GMELIN, who in 1788 commenced what he called the Thirteenth Edition of the celebrated *Systema Naturæ*, which obtained so wide a circulation that, in the comparative rarity of the original, the additions of this editor have been very frequently quoted, even by expert naturalists, as though they were the work of the author himself. Gmelin availed himself of every publication he could, but he perhaps found his richest booty in the labours of Latham, neatly condensing his English descriptions into Latin diagnoses, and bestowing on them binomial names. Hence it is that Gmelin appears as the authority for so much of the nomenclature now in use. He took many liberties with the details of Linnæus's work, but left the classification, at least of the Birds, as it was—a few new genera excepted.<sup>5</sup>

During all this time little had been done in studying the internal structure of Birds since the works of Coiter already mentioned<sup>6</sup>; but the foundations of the science of Embryology had been laid by the investigations into the development of the chick by the great HARVEY. Between 1666 and 1669 FERRAULT edited at Paris eight accounts of the dissection by DU VERNEY of as many species of Birds, which, translated into English, were published by the Royal Society in 1702, under the title of *The Natural History of Animals*. After the death of the two anatomists just named, another series of similar descriptions of eight other species was found among their papers, and the whole were published in the *Mémoires* of the French Academy of Sciences in 1733 and 1734. But in 1681 GERARD BLASTUS had brought out at Amsterdam an *Anatomie Animalium*, containing the results of all the dissections of animals that he could find; and the second part of this book, treating of *Volatilia*, makes a respectable show of more than one hundred and twenty closely-printed quarto pages, though nearly two-thirds is devoted to a treatise *De Ovo et Pullo*, containing among other things a reprint of Harvey's researches, and the scientific rank of the whole book may be inferred from Bats being still classed with Birds. In 1720 VALENTINI published, at Frankfort-on-the-Main, his *Amphitheatrum Zootomicum*, in which again most of the existing accounts of the anatomy of Birds were reprinted. But these and many other contributions,<sup>7</sup> made until nearly the close of the eighteenth century, though highly meritorious, were unconnected as a whole, and it is plain that no conception of what it was in the power of Comparative Anatomy to set forth had occurred to the most diligent dissectors. This privilege was reserved for GEORGES CUVIER, who in 1798 published at Paris his *Tableau Élémentaire de l'histoire naturelle des Animaux*, and thus laid the foundation of a thoroughly and hitherto unknown

<sup>1</sup> He also prepared for publication a second edition of his *Indes Ornithologica*, but this was never printed, and the manuscript is now in the present writer's possession.

<sup>2</sup> *The Naturalist's Miscellany* or *Vivarium Naturale*, in English and Latin, of SHAW and NODDER, the former being the author, the latter the draughtsman and engraver, was begun in 1789 and carried on till Shaw's death, forming twenty-four volumes. It contains figures of more than 280 Birds, but very poorly executed. In 1814 a sequel, *The Zoological Miscellany*, was begun by LEACH, Nodder continuing to do the plates. This was completed in 1817, and forms three volumes with 149 plates, 27 of which represent Birds.

<sup>3</sup> Of this work only fifty copies were printed, and it is one of the rarest known to the ornithologist. Only two copies are believed to exist in England, one in the British Museum, the other in private hands. It was reprinted in 1874 by Mr Tegetmeier.

<sup>4</sup> This was reprinted in 1832 by the Willagby Society. †

<sup>5</sup> DAUDIN'S unfinished *Traité Élémentaire et complet d'Ornithologie* appeared at Paris in 1800, and therefore is the last of these general works published in the eighteenth century.

<sup>6</sup> A succinct notice of the older works on Ornithotomy is given by Prof. SELLENKA in the introduction to that portion of Dr Bronn's *Klassen und Ordnungen des Thierreichs* relating to Birds (pp. 1-9) published in 1869; and Prof. CARUS'S *Geschichte der Zoologie*, published in 1872, may also be usefully consulted for further information on this and other heads.

<sup>7</sup> The treatises of the two BARTHOLOMÆ and BORRICHUS published at Copenhagen deserve mention if only to record the activity of Danish anatomists in those days.



mode of appreciating the value of the various groups of the Animal Kingdom. Yet his first attempt was a mere sketch.<sup>1</sup> Though he made a perceptible advance on the classification of Linnæus, at that time predominant, it is now easy to see in how many ways—want of sufficient material being no doubt one of the chief—Cuvier failed to produce a really natural arrangement. His principles, however, are those which must still guide taxonomers, notwithstanding that they have in so great a degree overthrown the entire scheme which he propounded. Confining our attention here, as of course it ought to be confined, to Ornithology, Cuvier's arrangement of the Class *Aves* is now seen to be not very much better than any which it superseded. But this view is gained by following the methods which Cuvier taught. In the work just mentioned few details are given; but even the more elaborate classification of Birds contained in his *Leçons d'Anatomie Comparée* of 1805 is based wholly on external characters, such as had been used by nearly all his predecessors; and the *Règne Animal* of 1817, when he was in his fullest vigour, afforded not the least evidence that he had ever dissected a couple even of Birds<sup>2</sup> with the object of determining their relative position in his system, which then, as before, depended wholly on the configuration of bills, wings, and feet. But, though apparently without such a knowledge of the anatomy of Birds as would enable him to apply it to the formation of that natural system which he was fully aware had yet to be sought, he seems to have been an excellent judge of the characters afforded by the bill and limbs, and the use he made of them, coupled with the extraordinary reputation he acquired on other grounds, procured for his system the adhesion for many years of the majority of ornithologists, and its influence though waning is still strong. Regret must always be felt by them that his great genius was never applied in earnest to their branch of study, especially when we consider that had it been so the perversion of energy in regard to the classification of Birds witnessed in England for nearly twenty years, and presently to be mentioned, would most likely have been prevented.<sup>3</sup>

Hitherto mention has chiefly been made of works on General Ornithology, but it will be understood that these were largely aided by the enterprise of travellers, and as there were many of them who published their narratives in separate forms their contributions have to be considered. Of those travellers then the first to be here especially named is MARSHALL, the fifth volume of whose *Danubius Pannonico-Mysicus* is devoted to the Birds he met with in the valley of the Danube, and appeared at the Hague in 1725, followed by a French translation in 1744.<sup>4</sup> Most of the many pupils whom Linnæus sent to foreign countries submitted their discoveries to him, but KALM, HASSELQVIST, and OSBECK published separately their respective travels

in North America, the Levant, and China.<sup>5</sup> The incessant journeys of PALLAS and his colleagues—FALK, GEORGI, S. G. GMELIN, GOLDENSTÄDT, LEPECHIN, and others—in the exploration of the recently extended Russian empire supplied not only much material to the *Commentarii* and *Acta* of the Academy of St Petersburg, but more that is to be found in their narratives,—all of it being of the highest interest to students of Palearctic or Nearctic Ornithology. Nearly the whole of their results, it may here be said, were summed up in the important *Zoographia Rosso-Asiatica* of the first-named naturalist, which saw the light in 1811,—the year of its author's death,—but, owing to circumstances over which he had no control, was not generally accessible till twenty years later. Of still wider interest are the accounts of Cook's three famous voyages, though unhappily much of the information gained by the naturalists who accompanied him on one or more of them seems to be irretrievably lost: the original observations of the elder FORSTER were not printed till 1844, and the valuable collection of zoological drawings made by the younger FORSTER still remains unpublished in the British Museum. The several accounts by JOHN WHITE, COLLINS, PHILLIPS, HUNTER, and others of the colonization of New South Wales at the end of the last century ought not to be overlooked by any Australian ornithologist. The only information at this period on the Ornithology of South America is contained in the two works on Chili by MOLINA, published at Bologna in 1776 and 1782. The travels of LE VAILLANT in South Africa having been completed in 1785, his great *Oiseaux d'Afrique* began to appear in Paris in 1790; but it is hard to speak properly of this work, for several of the species described in it are certainly not, and never were in his time, inhabitants of that country, though he sometimes gives a long account of the circumstances under which he observed them.<sup>6</sup>

From travellers who employ themselves in collecting the animals of any distant country the zoologists who stay at home and study those of their own district, be it great or small, are really not so much divided as at first might appear. Both may well be named "Faunists," and of the latter there were not a few who having turned their attention more or less to Ornithology should here be mentioned, and first among them RZACZYNSKI, who in 1721 brought out at Sandomirsk the *Historia naturalis curiosa regni Poloniae*, to which an *Auctuarium* was posthumously published at Danzig in 1742. This also may be perhaps the most proper place to notice the *Historia Avium Hungariae* of GROSSINGER, published at Posen in 1793. In 1734 J. L. FRISCH began the long series of works on the Birds of Germany with which the literature of Ornithology is enriched, by his *Vorstellung der Vögel Teutschlands*, which was only completed in 1763, and, its coloured plates proving very attractive, was again issued at Berlin in 1817. The little fly-sheet of ZOERN<sup>7</sup>—for it is scarcely more—on the Birds of the Hercynian Forest made its appearance at Pappenheim in 1745. In 1756 KRAMER published at Vienna a modest *Elenchus* of the plants and animals of Lower Austria, and J. D. PETERSEN produced at Altona in 1766 a *Vernichnus balthischer Vögel*; while in 1791 J. B. FISCHER's *Vernich einer Naturgeschichte von Livland* appeared at Königsberg, next year BESEKE brought out at Mitau his *Beytrag zur Naturgeschichte der Vögel Kurlands*,

<sup>1</sup> It had no effect on LACÉPÈDE, who in the following year added a *Tableau Méthodique* containing a classification of Birds to his *Discours d'Ouverture* (*Mém. de l'Institut*, iii. pp. 454-468, 508-519).

<sup>2</sup> So little regard did he pay to the Osteology of Birds that, according to De Blainville (*Jour. de Physique*, xlii. p. 187, note), the skeleton of a Powl to which was attached the head of a Hornbill was for a long time exhibited in the Museum of Comparative Anatomy at Paris! Yet, in order to determine the difference of structure in their organs of voice, Cuvier, as he says in his *Leçons* (iv. p. 464), dissected more than one hundred and fifty species of Birds. Unfortunately for him, as will appear in the sequel, it seems not to have occurred to him to use any of the results he obtained as the basis of a classification.

<sup>3</sup> It is unnecessary to enumerate the various editions of the *Règne Animal*. Of the English translations, that edited by Griffiths and Pidgeon is the most complete. The ornithological portion of it contained in these volumes received many additions from JOHN EDWARD GRAY, and appeared in 1829.

<sup>4</sup> Though much later in date, the *Iter per Posenanum Sclavoniam* of PILLER and MITTFACHNER, published at Buda in 1788, may perhaps be here most conveniently mentioned.

<sup>5</sup> The results of FORSKÄL's travels in the Levant, published after his death by Niebuhr, require mention, but the ornithology they contain is but scant.

<sup>6</sup> It has been charitably suggested that, his collection and notes having suffered shipwreck, he was induced to supply the latter from his memory and the former by the nearest approach to his lost specimens that he could obtain. This explanation, poor as it is, falls, however, in regard to some species.

<sup>7</sup> His earlier work under the title of *Patintheologie* can hardly be deemed scientific.

and in 1794 SIEMSEN'S *Handbuch* of the Birds of Mecklenburg was published at Rostock. But these works, locally useful as they may have been, did not occupy the whole attention of German ornithologists, for in 1791 BECHSTEIN reached the second volume of his *Gemeinnützige Naturgeschichte Deutschlands*, treating of the Birds of that country, which ended with the fourth in 1795. Of this an abridged edition by the name of *Ornithologisches Taschenbuch* appeared in 1802 and 1803, with a supplement in 1812; while between 1805 and 1809 a fuller edition of the original was issued. Moreover in 1795 J. A. NAUMANN humbly began at Cöthen a treatise on the Birds of the principality of Anhalt, which on its completion in 1804 was found to have swollen into an Ornithology of Northern Germany and the neighbouring countries. Eight supplements were successively published between 1805 and 1817, and in 1822 a new edition was required. This *Naturgeschichte der Vögel Deutschlands*, being almost wholly rewritten by his son J. F. NAUMANN, is by far the best thing of the kind as yet produced in any country. The fulness and accuracy of the text, combined with the neat beauty of its coloured plates, have gone far to promote the study of Ornithology in Germany, and while essentially a popular work, since it is suited to the comprehension of all readers, it is throughout written with a simple dignity that commends it to the serious and scientific. Its twelfth and last volume was published in 1844—by no means too long a period for so arduous and honest a performance, and a supplement was begun in 1847; but, the editor—or author as he may be fairly called—dying in 1857, this continuation was finished in 1860 by the joint efforts of J. H. BLASIUS and Dr BALDAMUS. In 1800 BORKHAUSEN with others commenced at Darmstadt a *Teutsche Ornithologie* in folio which appeared at intervals till 1812, and remains unfinished, though a reissue of the portion published took place between 1837 and 1841.

Other countries on the Continent, though not quite so prolific as Germany, bore some ornithological fruit at this period; but in all Southern Europe only four faunistic products can be named:—the *Saggio di Storia Naturale Bresiana* of PILATI, published at Brescia in 1769; the *Ornitologia dell' Europa Meridionale* of BERINZI, published at Parma between 1772 and 1776; the *Uccelli di Sardegna* of CETTI, published at Sassari in 1776; and the *Romana Ornithologia* of GILIUS, published at Rome in 1781—the last being in great part devoted to Pigeons and Poultry. More appeared in the North, for in 1770 Amsterdam sent forth the beginning of NOZEMAN'S *Nederlandsche Vogelén*, a fairly illustrated work in folio, but only completed by HOUTTUYN in 1829, and in Scandinavia most of all was done. In 1746 the great LINNÆUS had produced a *Fauna Svecica*, of which a second edition appeared in 1761, and a third revised by RETZIUS in 1800. In 1764 BRUNNICH published at Copenhagen his *Ornithologia Borealis*, a compendious sketch of the Birds of all the countries then subject to the Danish crown. At the same place appeared in 1767 LÆEM'S work *De Lapporibus Finmarckia*, to which GUNNERUS contributed some good notes on the Ornithology of Northern Norway, and at Copenhagen and Leipzig was published in 1780 the *Fauna Groenlandica* of OTTO FABRICIUS.

Of strictly American origin can here be cited only BARTRAM'S *Travels through North and South Carolina* and BARTON'S *Fragments of the Natural History of Pennsylvania*,<sup>1</sup> both printed at Philadelphia, one in 1791, the other in 1799; but J. R. FORSTER published a *Catalogue of the Animals of North America* in London in 1771, and the

following year described in the *Philosophical Transactions* a few Birds from Hudson's Bay.<sup>2</sup> A greater undertaking was PENNANT'S *Arctic Zoology*, published in 1783, with a supplement in 1787. The scope of this work was originally intended to be limited to North America, but circumstances induced him to include all the species of Northern Europe and Northern Asia, and though not free from errors it is a praiseworthy performance. A second edition appeared in 1792. The Ornithology of Britain naturally demands greater attention. The earliest list of British Birds we possess is that given by MERRETT in his *Pinax Rerum Naturalium Britannicarum*, printed in London in 1667.<sup>3</sup> In 1677 PLOT published his *Natural History of Oxfordshire*, which reached a second edition in 1705, and in 1686 that of *Staffordshire*. A similar work on *Lancashire, Cheshire, and the Peak* was sent out in 1700 by LEIGH, and one on *Cornwall* by BOBLASE in 1758—all these four being printed at Oxford. In 1766 appeared PENNANT'S *British Zoology*, a well-illustrated folio, of which a second edition in octavo was published in 1768, and considerable additions (forming the nominally third edition) in 1770, while in 1777 there were two issues, one in octavo the other in quarto, each called the fourth edition. In 1812, long after the author's death, another edition was printed, of which his son-in-law Hamner was the reputed editor, but he received much assistance from Latham, and through carelessness many of the additions herein made have often been ascribed to Pennant. In 1769 BERKENHOUT gave to the world his *Outlines of the Natural History of Great Britain and Ireland*, which reappeared under the title of *Synopsis of the same* in 1795. TUNSTALL'S *Ornithologia Britannica*, which appeared in 1771, is little more than a list of names.<sup>4</sup> In 1781 NASH'S *Worcestershire* included a few ornithological notices; and WALCOTT in 1789 published an illustrated *Synopsis of British Birds*, coloured copies of which are rare. In 1791 J. HEYSHAM added to Hutchins's *Cumberland* a list of Birds of that county, and in 1794 DONOVAN began a *History of British Birds* which was only finished in 1819—the earlier portion being reissued about the same time. In 1800 LEWIN brought out a very worthless work with the same title.

All the foregoing publications yield in importance to two that remain to be mentioned, a notice of which will fitly conclude this part of our subject. In 1767 Pennant, several of whose works have already been named, entered into correspondence with GILBERT WHITE, receiving from him much information, almost wholly drawn from his own observation, for the succeeding editions of the *British Zoology*. In 1769 White began exchanging letters of a similar character with Barrington. The epistolary intercourse with the former continued until 1780 and with the latter until 1787. In 1789 White's share of the correspondence, together with some miscellaneous matter, was published as *The Natural History of Selborne*—from the name of the village in which he lived. Observations on Birds form the principal though by no means the whole theme of this book, which may be safely said to have done more to promote a love of Ornithology in this country than any other work that has been written, nay more than all the other works (except one next to be mentioned) put together. It has passed through a far greater number of

<sup>1</sup> Both of these treatises have also been reprinted by the Willughby Society.

<sup>2</sup> In this year there were two issues of this book; one, nominally a second edition, only differs from the first in having a new title-page. No real second edition ever appeared, but in anticipation of it Sir THOMAS BROWNE prepared in or about 1671 (?) his "Account of Birds found in Norfolk," of which the draught, now in the British Museum, was printed in his collected works by Wilkin in 1835. If a fair copy was ever made its resting-place is unknown.

<sup>4</sup> It has been republished by the Willughby Society.

<sup>1</sup> This extremely rare book has been reprinted by the Willughby Society.

editions than any other work in Natural History in the whole world, and has become emphatically an English classic—the graceful simplicity of its style, the elevating tone of its spirit, and the sympathetic chords it strikes recommending it to every lover of Nature, while the severely scientific reader can scarcely find an error in any statement it contains, whether of matter of fact or opinion. It is almost certain that more than half the zoologists of the British Islands for the past seventy years or more have been infected with their love of the study by Gilbert White; and it can hardly be supposed that his influence will cease.<sup>1</sup>

The other work to the importance of which on Ornithology in this country allusion has been made is BEWICK'S *History of British Birds*. The first volume of this, containing the Land-Birds, appeared in 1797<sup>2</sup>—the text being, it is understood, by Beilby—the second, containing the Water-Birds, in 1804. The woodcuts illustrating this work are generally of surpassing excellence, and it takes rank in the category of artistic publications. Fully admitting the extraordinary execution of the engravings, every ornithologist may perceive that as portraits of the Birds they are of very unequal merit. Some of the figures were drawn from stuffed specimens, and accordingly perpetuate all the imperfections of the original; others represent species with the appearance of which the artist was not familiar, and these are either wanting in expression or are caricatures;<sup>3</sup> but those that were drawn from live Birds, or represent species which he knew in life, are worthy of all praise. It is well known that the earlier editions of this work, especially if they be upon large paper, command extravagant prices; but in reality the copies on smaller paper are now the rarer, for the stock of them has been consumed in nurseries and schoolrooms, where they have been torn up or worn out with incessant use. Moreover, whatever the lovers of the fine arts may say, it is nearly certain that the "Bewick Collector" is mistaken in attaching so high a value to these old editions, for owing to the want of skill in printing—indifferent ink being especially assigned as one cause—many of the earlier issues fail to show the most delicate touches of the engraver, which the increased care bestowed upon the edition of 1847 (published under the supervision of Mr John Hancock) has revealed,—though it must be admitted that certain blocks have suffered from wear of the press so as to be incapable of any more producing the effect intended. Of the text it may be said that it is respectable, but no more. It has given satisfaction to thousands of readers in time past, and will, it may be hoped, give satisfaction to thousands in time to come.

The existence of these two works explains the wisely-spread taste for Ornithology in this country, which is to foreigners so puzzling, and the zeal—not always according to knowledge, but occasionally reaching to serious study—with which that taste is pursued.

Having thus noticed, and it is to be hoped pretty thoroughly, the chief ornithological works begun if not completed prior to the commencement of the present cen-

<sup>1</sup> Next to the original edition, that known as Bennett's, published in 1837, which was reissued in 1875 by Mr Harting, was long deemed the best; but it must give place to that of Bell, which appeared in 1877, and contains much additional information of great interest. But the editions of Markwick, Herbert, Blyth, and Jardine all possess features of merit. An elaborately prepared edition, issued of late years under the management of one who gained great reputation as a naturalist, only shows his ignorance and his vulgarity.

<sup>2</sup> There were two issues—virtually two editions—of this with the same date on the title-page, though one of them is said not to have been published till the following year. Among several other *indicia* this may be recognized by the woodcut of the "Sea Eagle" at page 11 bearing at its base the inscription "Wycliffe, 1791," and by the additional misprint on page 145 of *Schenkiolus* for *Schenkius*.

<sup>3</sup> This is especially observable in the figures of the Birds-of-Prey.

tury, together with their immediate sequels, those which follow will require a very different mode of treatment, for their number is so great that it would be impossible for want of space to deal with them in the same extended fashion, though the attempt will finally be made to enter into details in the case of works constituting the foundation upon which apparently the superstructure of the future science has to be built. It ought not to need stating that much of what was, comparatively speaking, only a few years ago regarded as scientific labour is now no longer to be so considered. The mere fact that the principle of Evolution, and all its admission carries with it, has been accepted in some form or other by almost all naturalists, has rendered obsolete nearly every theory that had hitherto been broached, and in scarcely any branch of zoological research was theory more rife than in Ornithology. One of these theories must presently be noticed at some length on account of the historical importance which attaches to its malefic effects in impeding the progress of true Ornithology in Britain; but charity enjoins us to consign all the rest as much as possible to oblivion.

On reviewing the progress of Ornithology since the end of the last century, the first thing that will strike us is the fact that general works, though still undertaken, have become proportionally fewer, and such as exist are apt to consist of mere explanations of systematic methods that had already been more or less fully propounded, while special works, whether relating to the ornithic portion of the Fauna of any particular country, or limited to certain groups of Birds—works to which of late years the name of "Monograph" has become wholly restricted—have become far more numerous. But this seems to be the natural law in all sciences, and its cause is not far to seek. As the knowledge of any branch of study extends, it outgrows the opportunities and capabilities of most men to follow it as a whole; and, since the true naturalist, by reason of the irresistible impulse which drives him to work, cannot be idle, he is compelled to confine his energies to narrower fields of investigation. That in a general way this is for some reason to be regretted is true; but, like all natural operations, it carries with it some recompense, and the excellent work done by so-called "specialists" has over and over again proved of the greatest use to advancement in different departments of science, and in none more than in Ornithology.<sup>4</sup>

Another change has come over the condition of Ornithology, as of kindred sciences, induced by the multiplication of learned societies which issue publications as well as of periodicals of greater or less scientific pretension—the latter often enjoying a circulation far wider than the former. Both kinds increase yearly, and the desponding mind may fear the possibility of its favourite study expiring through being smothered by its own literature. Without anticipating such a future disaster, and looking merely to what has gone before, it is necessary here to premise that, in the observations which immediately follow, treatises which have appeared in the publications of learned bodies or in other scientific periodicals must, except they be of prime importance, be hereinafter passed unnoticed; but their omission will be the less felt because the more recent of those of a "faunal" character have generally been mentioned in a former dissertation (*BIRDS*, vol. iii. pp. 737-764) under the different Regions or

<sup>4</sup> The truth of the preceding remarks may be so obvious to most men who have acquaintance with the subject that their introduction here may seem unnecessary; but it is certain that the facts they state have been very little appreciated by many writers who profess to give an account of the progress of Natural History during the present century.

countries with which they deal, while reference to the older of these treatises is usually given by the writers of the newer. Still it seems advisable here to furnish some connected account of the progress made in the ornithological knowledge of those countries in which the readers of the present volume may be supposed to take the most lively interest—for example, the British Islands and those parts of the European continent which lie nearest to them or are most commonly sought by travellers, the Dominion of Canada and the United States of America, South Africa, India, together with Australia and New Zealand. The more important Monographs, again, will usually be found cited in the series of special articles on Birds contained in this work, though, as will be immediately perceived, there are some so-styled Monographs, which by reason of the changed views of classification that at present obtain have lost their restricted character, and for all practical purposes have now to be regarded as general works.

It will perhaps be most convenient to begin by mentioning some of these last, and in particular a number of them which appeared at Paris very early in this century. First in order of them is the *Histoire Naturelle d'une partie d'Oiseaux nouveaux et rares de l'Amérique et des Indes*, a folio volume<sup>1</sup> published in 1801 by LE VAILLANT. This is devoted to the very distinct and not nearly-allied groups of Hornbills and of birds which for want of a better name we must call "Chatterers," and is illustrated, like those works of which a notice immediately follows, by coloured plates, done in what was then considered to be the highest style of art and by the best draughtsmen procurable. The first volume of a *Histoire Naturelle des Perroquets*, a companion work by the same author, appeared in the same year, and is truly a Monograph, since the Parrots constitute a Family of birds so naturally severed from all others that there has rarely been anything else confounded with them. The second volume came out in 1805, and a third was issued in 1837-38 long after the death of its predecessor's author, by BOULEJOL ST-HILAIRE. Between 1803 and 1806 Le Vaillant also published in just the same style two volumes with the title of *Histoire Naturelle des Oiseaux de Paradis et des Rolliers, suivie de celle des Toucans et des Barbets*, an assemblage of forms, which, miscellaneous as it is, was surpassed in incongruity by a fourth work on the same scale, the *Histoire Naturelle des Promerops et des Gupiers, des Couroucou et des Touracos*, for herein are found Jays, Waxwings, the Cock-of-the-Rock (*Rupicola*), and what not besides. The plates in this last are by Barraband, for many years regarded as the perfection of ornithological artists, and indeed the figures, when they happen to have been drawn from the life, are not bad; but his skill was quite unable to vivify the preserved specimens contained in Museums, and when he had only these as subjects he simply copied the distortions of the "bird-stuffer." The following year, 1808, being aided by Temminck of Amsterdam, of whose son we shall presently hear more, Le Vaillant brought out the sixth volume of his *Oiseaux d'Afrique*, already mentioned. Four more volumes of this work were promised; but the means of executing them were denied to him, and, though he lived until 1824, his publications ceased.

A similar series of works was projected and begun about the same time as that of Le Vaillant by AUDEBERT and VIEILLON, though the former, who was by profession a painter and illustrated the work, was already dead more than a year before the appearance of the two volumes, bearing date 1802, and entitled *Oiseaux dorés ou a reflets métalliques*, the effect of the plates in which he sought to heighten by the lavish use of gilding. The first volume

contains the "Colibris, Oiseaux-mouches, Jacamars e. Promerops," the second the "Grimpeaux" and "Oiseaux de Paradis"—associations which set all the laws of systematic method at defiance. His colleague, Vieillot, brought out in 1805 a *Histoire Naturelle des plus beaux Chanteurs de la Zone Torride* with figures by Langlois of tropical Finches, Grosbeaks, Buntinga, and other hard-billed birds; and in 1807 two volumes of a *Histoire Naturelle des Oiseaux de l'Amérique Septentrionale*, without, however, paying much attention to the limits commonly assigned by geographers to that part of the world. In 1805 ANSKELM DESMAREST published a *Histoire naturelle des Tangaras, des Manakins et des Todiers*, which, though belonging to the same category as all the former, differs from them in its more scientific treatment of the subjects to which it refers; and, in 1808, TEMMINCK, whose father's aid to Le Vaillant has already been noticed, brought out at Paris a *Histoire Naturelle des Pigeons* illustrated by Madame Knip, who had drawn the plates for Desmarest's volume.<sup>2</sup>

Since we have begun by considering these large illustrated works in which the text is made subservient to the coloured plates, it may be convenient to continue our notice of such others of similar character as it may be expedient to mention here, though thereby we shall be led somewhat far afield. Most of them are but luxuries, and there is some degree of truth in the remark of Andreas Wagner in his *Report on the Progress of Zoology for 1843*, drawn up for the Ray Society (p. 60), that they "are not adapted for the extension and promotion of science, but must inevitably, on account of their unnecessary costliness, constantly tend to reduce the number of naturalists who are able to avail themselves of them, and they thus enrich ornithology only to its ultimate injury." Earliest in date as it is greatest in bulk stands AUDUBON'S egregious *Birds of America* in four volumes, containing four hundred and thirty-five plates, of which the first part appeared in London in 1827 and the last in 1838. It does not seem to have been the author's original intention to publish any letter-press to this enormous work, but to let the plates tell their own story, though finally, with the assistance, as is now known, of WILLIAM MACGILLIVRAY, a text, on the whole more than respectable, was produced in five large octavos under the title of *Ornithological Biography*, of which more will be said in the sequel. Audubon has been greatly extolled as an ornithological artist; but he was far too much addicted to representing his subjects in violent action and in postures that outrage nature, while his drawing is very frequently defective.<sup>3</sup> In 1866 Mr D. G. ELLIOT began, and in 1869 finished, a sequel to Audubon's great work in two volumes, on the same scale—*The New and Hitherto unfigured Species of the Birds of North America*, containing life-size figures of all those which had been added to its fauna since the completion of the former.

In 1830 JOHN EDWARD GRAY commenced the *Illustrations of Indian Zoology*, a series of plates of vertebrated animals, but mostly of Birds, from drawings it is believed by native artists in the collection of General HARDWICK, whose name is therefore associated with the work. Scientific

<sup>1</sup> Temminck subsequently reproduced, with many additions, the text of this volume in his *Histoire naturelle des Pigeons et des Gallinacés*, published at Amsterdam in 1818-15, in 3 vols. 8vo. Between 1838 and 1848 M. FLORENT-PROVOST brought out at Paris a further set of illustrations of Pigeons by M<sup>me</sup>. Knip.

<sup>2</sup> On the completion of these two works, for they must be regarded as distinct, an octavo edition in seven volumes under the title of *The Birds of America* was published in 1840-44. In this the large plates were reduced by means of the "camera lucida," the text was revised, and the whole systematically arranged. Other reprints have since been issued, but they are vastly inferior both in execution and value. A sequel to the octavo *Birds of America*, corresponding with it in form, was brought out in 1853-55 by CASPAR as *Illustrations of the Birds of California, Texas, Oregon, British and Russian America*.

<sup>3</sup> There is also an issue of this, as of the same author's other works, on large quarto paper.

names are assigned to the species figured; but no text was ever supplied. In 1832 Mr LEAR, afterwards well known as a painter, brought out his *Illustrations of the Family of Pittaciæ*, a volume which deserves especial notice from the extreme fidelity to nature and the great artistic skill with which the figures were executed.

This same year (1832) saw the beginning of the marvellous series of illustrated ornithological works by which the name of JOHN GOULD is likely to be always remembered. *A Century of Birds from the Himalaya Mountains* was followed by *The Birds of Europe* in five volumes, published between 1832 and 1837; while in the interim (1834) appeared *A Monograph of the Ramphastidæ*, of which a second edition was some years later called for, then the *Icones Avium*, of which only two parts were published (1837-38), and *A Monograph of the Trogonidæ* (1838), which also reached a second edition. Sailing in 1838 for New South Wales, on his return in 1840 he at once commenced the greatest of all his works, *The Birds of Australia*, which was finished in 1848 in seven volumes, to which several supplementary parts, forming another volume, were subsequently added. In 1849 he began *A Monograph of the Trochilidæ or Humming-birds* extending to five volumes, the last of which appeared in 1861, and has since been followed by a supplement now in course of completion by Mr SALVIN. *A Monograph of the Odontophorinæ or Partridges of America* (1850); *The Birds of Asia*, in seven volumes, the last completed by Mr SHARPE (1850-83); *The Birds of Great Britain*, in five volumes (1862-73); and *The Birds of New Guinea*, begun in 1875, and, after the author's death in 1881, undertaken by Mr Sharpe, make up the wonderful tale consisting of more than forty folio volumes, and containing more than three thousand coloured plates. The earlier of these works were illustrated by Mrs Gould, and the figures in them are fairly good; but those in the later, except when (as he occasionally did) he secured the services of Mr WOLF, are not so much to be commended. There is, it is true, a smoothness and finish about them not often seen elsewhere; but, as though to avoid the exaggerations of Audubon, Gould usually adopted the tamest of attitudes in which to represent his subjects, whereby expression as well as vivacity is wanting. Moreover, both in drawing and in colouring there is frequently much that is untrue to nature, so that it has not uncommonly happened for them to fail in the chief object of all zoological plates, that of affording sure means of recognizing specimens on comparison. In estimating the letterpress, which was avowedly held to be of secondary importance to the plates, we must bear in mind that, to ensure the success of his works, it had to be written to suit a very peculiarly composed body of subscribers. Nevertheless a scientific character was so adroitly assumed that scientific men—some of them even ornithologists—have thence been led to believe the text had a scientific value, and that of a high class. However it must also be remembered that, throughout the whole of his career, Gould consulted the convenience of working ornithologists by almost invariably refraining from including in his folio works the technical description of any new species without first publishing it in some journal of comparatively easy access.

An ambitious attempt to produce in England a general series of coloured plates on a large scale was Mr FRASER'S *Zoologia Typica*, the first part of which bears date 1841-42. Others appeared at irregular intervals until 1849, when the work, which seems never to have received the support it deserved, was discontinued. The seventy plates (forty-six of which represent birds) composing, with some explanatory letterpress, the volume are by C. Cousens and H. N. Turner,—the latter (as his publications prove) a zoologist of much promise, who in 1851 died, a victim to

his own zeal for investigation, of a wound received in dissecting. The chief object of the author, who had been naturalist to the Niger Expedition, and curator to the Museum of the Zoological Society of London, was to figure the animals contained in its gardens or described in its *Proceedings*, which until the year 1848 were not illustrated.

The publication of the *Zoological Sketches* of Mr WOLF, from animals in the gardens of the Zoological Society, was begun about 1855, with a brief text by MITCHELL, at that time the Society's secretary, in illustration of them. After his death in 1859, the explanatory letterpress was rewritten by Mr SOLATER, his successor in that office, and a volume was completed in 1861. Upon this a second series was commenced, and brought to an end in 1868. Though a comparatively small number of species of Birds are figured in this magnificent work (seventeen only in the first series, and twenty-two in the second), it must be mentioned here, for their likenesses are so admirably executed as to place it in regard to ornithological portraiture at the head of all others. There is not a single plate that is unworthy of the greatest of all animal painters.

Proceeding to illustrated works generally of less pretentious size but of greater ornithological utility than the books last mentioned, which are fitter for the drawing-room than the study, we next have to consider some in which the text is not wholly subordinated to the plates, though the latter still form a conspicuous feature of the publication. First of these in point of time as well as in importance is the *Nouveaux Recueil des Planches Coloriées d'Oiseaux* of TEMMINCK and LAUGIER, intended as a sequel to the *Planches Enluminées* of D'Aubenton before noticed (page 6), and like that work issued both in folio and quarto size. The first portion of this was published at Paris in 1820, and of its one hundred and two *livraisons*, which appeared with great irregularity (*Ibis*, 1868, p. 500), the last was issued in 1839, containing the titles of the five volumes that the whole forms, together with a "Tableau Méthodique" which but indifferently serves the purpose of an index. There are six hundred plates, but the exact number of species figured (which has been computed at six hundred and sixty-one) is not so easily ascertained. Generally the subject of each plate has letterpress to correspond, but in some cases this is wanting, while on the other hand descriptions of species not figured are occasionally introduced, and usually observations on the distribution and construction of each genus or group are added. The plates, which shew no improvement in execution on those of Martinet, are after drawings by Huet and Prêtre, the former being perhaps the less bad draughtsman of the two, for he seems to have had an idea of what a bird when alive looks like, though he was not able to give his figures any vitality, while the latter simply delineated the stiff and dishevelled specimens from museum shelves. Still the colouring is pretty well done, and experience has proved that generally speaking there is not much difficulty in recognizing the species represented. The letterpress is commonly limited to technical details, and is not always accurate; but it is of its kind useful, for in general knowledge of the outside of Birds Temminck probably surpassed any of his contemporaries. The "Tableau Méthodique" offers a convenient concordance of the old *Planches Enluminées* and its successor, and is arranged after the system set forth by Temminck in the first volume of the second edition of his *Manuel d'Ornithologie*, of which something must presently be said.

The *Galerie des Oiseaux*, a rival work, with plates by OUDART, seems to have been begun immediately after the former. The original project was apparently to give a figure and description of every species of Bird; but that was soon found to be impossible; and, when six parts had

been issued, with text by some unnamed author, the scheme was brought within practicable limits, and the writing of the letterpress was entrusted to VIEILLON, who, proceeding on a systematic plan, performed his task very creditably, completing the work, which forms two quarto volumes, in 1825, the original text and fifty-seven plates being relegated to the end of the second volume as a supplement. His portion is illustrated by two hundred and ninety-nine coloured plates that, wretched as they are, have been continually reproduced in various text-books—a fact possibly due to their subjects having been judiciously selected. It is a tradition that, this work not being favourably regarded by the authorities of the Paris Museum, its draughtsman and author were refused closer access to the specimens required, and had to draw and describe them through the glass as they stood on the shelves of the cases.

In 1825 JARDINE and SELBY began a series of *Illustrations of Ornithology*, the several parts of which appeared at long and irregular intervals, so that it was not until 1839 that three volumes containing one hundred and fifty plates were completed. Then they set about a Second Series, which, forming a single volume with fifty-three plates, was finished in 1843. These authors, being zealous amateur artists, were their own draughtsmen to the extent even of lithographing the figures. In 1828 JAMES WILSON (author of the article ORNITHOLOGY in the 7th and 8th editions of the present work) began, under the title of *Illustrations of Zoology*, the publication of a series of his own drawings (which he did not, however, himself engrave) with corresponding letterpress. Of the thirty-six plates illustrating this volume, a small folio, twenty are devoted to Ornithology, and contain figures, which, it must be allowed, are not very successful, of several species rare at the time.

Though the three works last mentioned fairly come under the same category as the *Planches Enluminees* and the *Planches Coloriees*, no one of them can be properly deemed their rightful heirs. The claim to that succession was made in 1845 by DES MURS for his *Iconographie Ornithologique*, which, containing seventy-two plates by Prévot and Oudart<sup>1</sup> (the latter of whom had marvellously improved in his drawings since he worked with Vieillon), was completed in 1849. Simultaneously with this DU BUS began a work on a plan precisely similar, the *Esquisses Ornithologiques*, illustrated by Severeys, which, however, stopped short in 1849 with its thirty-seventh plate, while the letterpress unfortunately does not go beyond that belonging to the twentieth. In 1866 the succession was again taken up by the *Exotic Ornithology* of Messrs SCLATER and SALVIN, containing one hundred plates, representing one hundred and four species, all from Central or South America, which are neatly executed by Mr Smit. The accompanying letterpress is in some places copious, and useful lists of the species of various genera are occasionally subjoined, adding to the definite value of the work, which, forming one volume, was completed in 1869.

Lastly here must be mentioned ROWLEY'S *Ornithological Miscellany* in three quarto volumes, profusely illustrated, which appeared between 1875 and 1878. The contents are as varied as the authorship, and, most of the leading English ornithologists having contributed to the work, some of the papers are extremely good, while in the plates, which are in Mr Keulemans's best manner, many rare species of Birds are figured, some of them for the first time.

All the works lately named have been purposely treated at some length, since being very costly they are not easily accessible. The few next to be mentioned, being of smaller size (octavo), may be within reach of more persons, and

<sup>1</sup> On the title page credit is given to the latter alone, but only two-thirds of the plates (from pl. 25 to the end) bear his name.

therefore can be passed over in a briefer fashion without detriment. In many ways, however, they are nearly as important. SWAINSON'S *Zoological Illustrations* in three volumes, containing one hundred and eighty-two plates, whereof seventy represent Birds, appeared between 1820 and 1821, and in 1829 a Second Series of the same was begun by him, which, extending to another three volumes, contained forty-eight more plates of Birds out of one hundred and thirty-six, and was completed in 1833. All the figures were drawn by the author, who as an ornithological artist had no rival in his time. Every plate is not beyond criticism, but his worst drawings shew more knowledge of bird-life than do the best of his English or French contemporaries. A work of somewhat similar character, but one in which the letterpress is of greater value, is the *Centuria Zoologica* of LESSON, a single volume that, though bearing the date 1830 on its title page, is believed to have been begun in 1829,<sup>2</sup> and was certainly not finished until 1831. It received the benefit of Isidore Geoffroy St-Hilaire's assistance. Notwithstanding its name it only contains eighty plates, but of them forty-two, all by Prêtre and in his usual stiff style, represent Birds. Concurrently with this volume appeared Lesson's *Traité d'Ornithologie*, which is dated 1831, and may perhaps be here most conveniently mentioned. Its professedly systematic form strictly relegates it to another group of works, but the presence of an "Atlas" (also in octavo) of one hundred and nineteen plates to some extent justifies its notice in this place. Between 1831 and 1834 the same author brought out, in continuation of his *Centuria*, his *Illustrations de Zoologie* with sixty plates, twenty of which represent Birds. In 1832 KIRTLITZ began to publish some *Kupfer tafeln zur Naturgeschichte der Vögel*, in which many new species are figured; but the work came to an end with its thirty-sixth plate in the following year. In 1845 REICHENBACH commenced with his *Praktische Naturgeschichte der Vögel* the extraordinary series of illustrated publications which, under titles far too numerous here to repeat, ended in or about 1855, and are commonly known collectively as his *Vollständige Naturgeschichte der Vögel*.<sup>3</sup> Herein are contained more than nine hundred coloured and more than one hundred uncoloured plates, which are crowded with the figures of Birds, a large proportion of them reduced copies from other works, and especially those of Gould.

It now behoves us to turn to general and particularly systematic works in which plates, if they exist at all, form but an accessory to the text. These need not detain us for long, since, however well some of them may have been executed, regard being had to their epoch, and whatever repute some of them may have achieved, they are, so far as general information and especially classification is concerned, wholly obsolete, and most of them almost useless except as matters of antiquarian interest. It will be enough merely to name DUMÉRIL'S *Zoologie Analytique* (1806) and GRAVENHORST'S *Vergleichende Uebersicht des linneischen und einiger neuern zoologischen Systeme* (1807); nor need we linger over SHAW'S *General Zoology*, a pretentious compilation continued by STEPHENS. The last seven of its fourteen volumes include the *Class Aves*, and the first part of them appeared in 1809, but, the original author dying in 1815, when only two volumes of Birds were published, the remainder was brought to an end in 1826 by his successor, who afterwards became well known as an entomologist. The engravings which these volumes contain are mostly bad copies, often of bad figures,

In 1828 he had brought out, under the title of *Manuel d'Ornithologie*, two handy duodecimos which are very good of their kind.

<sup>3</sup> Technically speaking it is in quarto, but their size is so small that they may be well spoken of here. In 1879 Dr A. B. Meyer brought out an *Index* to them.



though many are piracies from Bewick, and the whole is a most unsatisfactory performance. Of a very different kind is the next we have to notice, the *Prodromus Systematis Mammalium et Avium* of ILLIGER, published at Berlin in 1811, which must in its day have been a valuable little manual, and on many points it may now be consulted to advantage—the characters of the Genera being admirably given, and good explanatory lists of the technical terms of Ornithology furnished. The classification was quite new, and made a step distinctly in advance of anything that had before appeared.<sup>1</sup> In 1816 VIEILLOT published at Paris an *Analyse d'une nouvelle Ornithologie Élémentaire*, containing a method of classification which he had tried in vain to get printed before, both in Turin and in London.<sup>2</sup> Some of the ideas in this are said to have been taken from Illiger; but the two systems seem to be wholly distinct. Vieillot's was afterwards more fully expounded in the series of articles which he contributed between 1816 and 1819 to the Second Edition of the *Nouveau Dictionnaire d'Histoire Naturelle* containing much valuable information. The views of neither of these systematizers pleased TEMMINCK, who in 1817 replied rather sharply to Vieillot in some *Observations sur la Classification méthodique des Oiseaux*, a pamphlet published at Amsterdam, and prefixed to the second edition of his *Manuel d'Ornithologie*, which appeared in 1820, an *Analyse du Système Général d'Ornithologie*. This proved a great success, and his arrangement, though by no means simple,<sup>3</sup> was not only adopted by many ornithologists of almost every country, but still has some adherents. The following year RANZANI of Bologna, in his *Elementi di Zoologia*—a very respectable compilation—came to treat of Birds, and then followed to some extent the plan of De Blainville and Merrem (concerning which much more has to be said by and by) placing the Struthious Birds in an Order by themselves. In 1827 WAGLER brought out the first part of a *Systema Avium*, in this form never completed, consisting of forty-nine detached monographs of as many genera, the species of which are most elaborately described. The arrangement he subsequently adopted for them and for other groups is to be found in his *Natürliches System der Amphibien* (pp. 77–128), published in 1830, and is too fanciful to require any further attention. The several attempts at system-making by KAUP, from his *Allgemeine Zoologie* in 1829 to his *Ueber Classification der Vögel* in 1849, were equally arbitrary and abortive; but his *Skizzen der Entwickelungs-Geschichte* in 1829 must be here named, as it is so often quoted on account of the number of new genera which the peculiar views he had embraced compelled him to invent. These views he shared more or less with Vigors and Swainson, and to them attention will be immediately especially invited, while consideration of the scheme gradually developed

from 1831 onward by CHARLES LUCIEN BONAPARTE, and still not without its influence, is deferred until we come to treat of the rise and progress of what we may term the reformed school of Ornithology. Yet injustice would be done to one of the ablest of those now to be called the old masters of the science if mention were not here made of the *Conspectus Generum Avium*, begun in 1850 by the naturalist last named, with the help of SCHLEGEL, and unfortunately interrupted by its author's death six years later.<sup>4</sup> The systematic publications of GEORGE ROBERT GRAY, so long in charge of the ornithological collection of the British Museum, began with *A List of the Genera of Birds* published in 1840. This, having been closely, though by no means in a hostile spirit, criticized by STRICKLAND (*Ann. Nat. History*, vi. p. 410; vii. pp. 26 and 159), was followed by a Second Edition in 1841, in which nearly all the corrections of the reviewer were adopted, and in 1844 began the publication of *The Genera of Birds*, beautifully illustrated—first by MITCHELL and afterwards by Mr WOLF—which will always keep Gray's name in remembrance. The enormous labour required for this work seems scarcely to have been appreciated, though it remains to this day one of the most useful books in an ornithologist's library. Yet it must be confessed that its author was hardly an ornithologist but for the accident of his calling. He was a thoroughly conscientious clerk, devoted to his duty and unsparing of trouble. However, to have conceived the idea of executing a work on so grand a scale as this—it forms three folio volumes, and contains one hundred and eighty-five coloured and one hundred and forty-eight uncoloured plates, with references to upwards of two thousand four hundred generic names—was in itself a mark of genius, and it was brought to a successful conclusion in 1849. Costly as it necessarily was, it has been of great service to working ornithologists. In 1855 Gray brought out, as one of the Museum publications, *A Catalogue of the Genera and Subgenera of Birds*, a handy little volume, naturally founded on the larger works. Its chief drawback is that it does not give any more reference to the authority for a generic term than the name of its inventor and the year of its application, though of course more precise information would have at least doubled the size of the book. The same deficiency became still more apparent when, between 1869 and 1871, he published his *Hand-List of Genera and Species of Birds* in three octavo volumes (or parts, as they are called). Never was a book better named, for the working ornithologist must almost live with it in his hand, and though he has constantly to deplore its shortcomings, one of which especially is the wrong principle on which its index is constructed, he should be thankful that such a work exists. Many of its defects are, or perhaps it were better said ought to be, supplied by GIEBEL's *Theaurus Ornithologicus*, also in three volumes, published between 1872 and 1877, a work admirably planned, but the execution of which, whether through the author's carelessness or the printer's fault, or a combination of both, is lamentably disappointing. Again and again it will afford the enquirer who consults it valuable hints, but he must be mindful never to trust a single reference in it until it has been verified. It remains to warn the reader also that, useful as are both this work and those of Gray, their utility is almost solely confined to experts.

With the exception to which reference has just been made, scarcely any of the ornithologists hitherto named indulged their imagination in theories or speculations. Nearly all were content to prosecute their labours in a plain fashion consistent with common sense, plodding

<sup>4</sup> To this very indispensable work a good index was supplied in 1865 by Dr Finch.

<sup>1</sup> Illiger may be considered the founder of the school of nomenclatorial purists. He would not tolerate any of the "barbarous" generic terms adopted by other writers, though some had been in use for many years.

<sup>2</sup> The method was communicated to the Turin Academy, 10th January 1814, and was ordered to be printed (*Mém. Ac. Sc. Turin*, 1813–14, p. xxviii); but, through the derangements of that stormy period, the order was never carried out (*Mém. Acad. Sc. Torino*, xxiii. p. xvii). The minute-book of the Linnean Society of London shews that his *Pro-lusio* was read at meetings of that Society between 15th November 1814 and 21st February 1815. Why it was not at once accepted is not told, but the entry respecting it, which must be of much later date, in the "Register of Papers" is "Published already." It is due to Vieillot to mention these facts, as he has been accused of publishing his method in haste to anticipate some of Cuvier's views, but he might well complain of the delay in London. Some reparation has been made to his memory by the reprinting of his *Analyse* by the Willughby Society.

<sup>3</sup> He recognized sixteen Orders of Birds, while Vieillot had been content with five, and Illiger with seven.

steadily onwards in their efforts to describe and group the various species of Birds, as one after another they were made known. But this was not always to be, and now a few words must be said respecting a theory which was promulgated with great zeal by its upholders during the end of the first and early part of the second quarter of the present century, and for some years seemed likely to carry all before it. The success it gained was doubtless due, in some degree to the difficulty which most men had in comprehending it, for it was enwrapped in alluring mystery, but more to the confidence with which it was announced as being the long looked-for key to the wonders of creation, since its promoters did not hesitate to term it the discovery of "the Natural System," though they condescended, by way of explanation to less exalted intellects than their own, to allow it the more moderate appellation of the Circular or Quinary System.

A comparison of the relation of created beings to a number of intersecting circles is as old as the days of NIEMBERG, who in 1635 wrote (*Historia Naturæ*, lib. iii. cap. 8)—"Nullus hiatus est, nulla fractio, nulla dispersio formarum, invicem connexa sunt velut annulus annulo"; but it is almost clear that he was thinking only of a chain. In 1806 FISCHER DE WALDERHEIM, in his *Tableaux Synoptiques de zoognosie* (p. 181), quoting Niernberg, extended his figure of speech, and, while justly deprecating the notion that a series of forms belonging to any particular group of creatures—the *Mammalia* was that whence he took his instance—could be placed in a straight line, imagined the various genera to be arrayed in a series of contiguous circles around Man as a centre. Though there is nothing to shew that Fischer intended, by what is here said, to do anything else than illustrate more fully the marvellous interconnexion of different animals, or that he attached any realistic meaning to his metaphor, his words were eagerly caught up by the prophet of the new faith. This was WILLIAM SHARPE MACLEAY, a man of education and real genius, who in 1819 and 1821 brought out a work under the title of *Hæc Entomologica*, which was soon after hailed by VIGORS as containing a new revelation, and applied by him to Ornithology in some "Observations on the Natural Affinities that connect the Orders and Families of Birds," read before the Linnean Society of London in 1823, and afterwards published in its *Transactions* (xiv. pp. 395-517). In the following year Vigors returned to the subject in some papers published in the recently established *Zoological Journal*, and found an energetic condisciple and coadjutor in SWAINSON, who, for more than a dozen years—to the end, in fact, of his career as an ornithological writer—was instant in season and out of season in pressing on all his readers the views he had, through Vigors, adopted from Macleay, though not without some modification of detail if not of principle. What these views were it would be manifestly improper for a sceptic to state except in the terms of a believer. Their enunciation must therefore be given in Swainson's own words, though it must be admitted that space cannot be found here for the diagrams, which it was alleged were necessary for the right understanding of the theory. This theory, as originally propounded by Macleay, was said by Swainson in 1835 (*Geogr. and Classific. of Animals*, p. 202) to have consisted of the following propositions:—

"1. That the series of natural animals is continuous, forming, as it were, a circle; so that, upon commencing at any one given pair, and thence tracing all the modifications of structure, we shall be imperceptibly led, after passing through numerous forms, again to the point from which we started.

"2. That no groups are natural which do not exhibit, or show an evident tendency to exhibit, such a circular series.

"3. That the primary divisions of every large group are ten, five of which are composed of comparatively large circles, and five of smaller: these latter being termed *osculant*, and being intermediate between the former, which they serve to connect.

"4. That there is a tendency in such groups as are placed at the opposite points of a circle of affinity 'to meet each other.'

"5. That one of the five larger groups into which every natural circle is divided 'bears a resemblance to all the rest, or, more strictly speaking, consists of types which represent those of each of the four other groups, together with a type peculiar to itself.'

As subsequently modified by Swainson (*loc. cit.* pp. 224, 225), the foregoing propositions take the following form:—

"1. That every natural series of beings, in its progress from

a given point, either actually returns, or evinces a tendency to return, again to that point, thereby forming a circle.

"II. The primary circular divisions of every group are *inter* actually, or five apparently.

"III. The contents of such a circular group are symbolically (or analogically) represented by the contents of all other circles in the animal kingdom.

"IV. That these primary divisions of every group are characterized by definite peculiarities of form, structure, and economy, which, under diversified modifications, are uniform throughout the animal kingdom, and are therefore to be regarded as the PRIMARY TYPES OF NATURE.

"V. That the different ranks or degrees of circular groups exhibited in the animal kingdom are *inter* in number, each being involved within the other."

Though, as above stated, the theory here promulgated owed its temporary success chiefly to the extraordinary assurance and pertinacity with which it was urged upon a public generally incapable of understanding what it meant, that it received some support from men of science must be admitted. A "circular system" was advocated by the eminent botanist FRITZ, and the views of Macleay met with the partial approbation of the celebrated entomologist KIRBY, while at least as much may be said of the imaginative OKEK, whose mysticism far surpassed that of the Quinarians. But it is obvious to every one who nowadays indulges in the profitless pastime of studying their writings that, as a whole, they failed in grasping the essential difference between *homology* (or "affinity," as they generally termed it) and *analogy* (which is only a learned name for an uncertain kind of resemblance)—though this difference had been fully understood and set forth by Aristotle himself—and, moreover, that in seeking for analogies on which to base their foregone conclusions they were often put to hard shifts. Another singular fact is that they often seemed to be totally unaware of the tendency if not the meaning of some of their own expressions: thus Macleay could write, and doubtless in perfect good faith (*Trans. Linn. Society*, xvi. p. 9, note), "Naturalists have nothing to do with mysticism, and but little with *a priori* reasoning." Yet his followers, if not he himself, were ever making use of language in the highest degree metaphorical, and were always explaining facts in accordance with preconceived opinions. FLEMING, already the author of a harmless and extremely orthodox *Philosophy of Zoology*, pointed out in 1829 in the *Quarterly Review* (xii. pp. 302-327) some of the fallacies of Macleay's method, and in return provoked from him a reply, in the form of a letter addressed to Vigors *On the Dying Struggle of the Dichotomous System*, couched in language the force of which no one even at the present day can deny, though to the modern naturalist its invective power contrasts ludicrously with the strength of its ratiocination. But, confining ourselves to what is here our special business, it is to be remarked that perhaps the heaviest blow dealt at these strange doctrines was that delivered by KENNIE, who, in an edition of Montagu's *Ornithological Dictionary* (pp. xxxiii-iv), published in 1831 and again issued in 1833, attacked the Quinary System, and especially its application to Ornithology by Vigors and Swainson, in a way that might perhaps have demolished it, had not the author mingled with his undoubtedly sound reasoning much that is foreign to any question with which a naturalist, as such, ought to deal—though that herein he was only following the example of one of his opponents, who had constantly treated the subject in like manner, is to be allowed. This did not hinder Swainson, who had succeeded in getting the ornithological portion of the first zoological work ever published at the expense of the British Government (namely, the *Fauna Boreali-Americana*) executed in accordance with his own opinions, from maintaining them more strongly than ever in several of the volumes treating of Natural History which he contributed to the *Cabinet Cyclopædia*—among others that from which we have just given some extracts—and in what may be deemed the culmination in England of the Quinary System, the volume of the "Naturalist's Library" on *The Natural Arrangement and History of Flycatchers*, published in 1838, of which unhappy performance mention has already been made in this present work (vol. ix. p. 350, note). This seems to have been his last attempt; for, two years later, his *Bibliography of Zoology* shows little trace of his favourite theory, though nothing he had uttered in its support was retracted. Appearing almost simultaneously with this work, an article by STRICKLAND (*Mag. Nat. History*, ser. 2, iv. pp. 219-226) entitled *Observations upon the Affinities and Analogies of Organized Beings* administered to the theory a shock from which it never recovered, though attempts were now and then made by its adherents to revive it; and, even ten years or more later, KAUF, one of the few foreign ornithologists who had embraced Quinary principles, was by mistaken kindness allowed to publish *Monographs of the Birds-of-Prey* (Jardine's *Contributions to Ornithology*, 1849, pp. 68-75, 96-121; 1850, pp. 51-80; 1851, pp. 119-130; 1852, pp. 103-122; and *Trans. Zool. Society*, iv. pp. 201-260), in which its absurdity reached the climax.

The mischief caused by this theory of a Quinary System was

<sup>1</sup> We prefer giving them here in Swainson's version, because he seems to have set them forth more clearly and concisely than Macleay ever did; and, moreover, Swainson's application of them to Ornithology—a branch of science that lay outside of Macleay's proper studies—seems to be more suitable to the present occasion.



very great, but was chiefly confined to Britain, for (as has been already stated) the extraordinary views of its adherents found little favour on the continent of Europe. The purely artificial character of the System of Linnæus and his successors had been perceived, and men were at a loss to find a substitute for it. The new doctrine, loudly proclaiming the discovery of a "Natural" System, led away many from the steady practice which should have followed the teaching of Cuvier (though he in Ornithology had not been able to set up to the principles he had laid down) and from the extended study of Comparative Anatomy. Moreover, it veiled the honest attempts that were making both in France and Germany to find real grounds for establishing an improved state of things, and consequently the labours of DE BLAINVILLE, ÉTIENNE, GEOFFROY ST-HILAIRE, and L'HERMINIER, of MERREM, JOHANNES MÜLLER, and NITZSCH—to say nothing of others—were almost wholly unknown on this side of the Channel, and even the value of the investigations of British ornithologists of high merit, such as MACLEAY and MACGILLIVRAY, was almost completely overlooked. True it is that there were not wanting other men in these islands whose common sense refused to accept the metaphorical doctrine and the mystical jargon of the Quinarians, but so strenuously and persistently had the latter asserted their infallibility, and so vigorously had they assailed any who ventured to doubt it, that most peaceable ornithologists found it best to bend to the furious blast, and in some sort to acquiesce at least in the phraseology of the self-styled interpreters of Creative Will. But, while thus lamenting this unfortunate perversion into a mistaken channel of ornithological energy, we must not over-blame those who caused it. Macleay indeed never pretended to a high position in this branch of science, his tastes lying in the direction of Entomology; but few of their countrymen knew more of Birds than did Swainson and Vigors; and, while the latter, as editor for many years of the *Zoological Journal*, and the first Secretary of the Zoological Society, has special claims to the regard of all zoologists, so the former's indefatigable pursuit of Natural History, and conscientious labour in its behalf—among other ways by means of his graceful pencil—deserve to be remembered as a set-off against the injury he unwittingly caused.

It is now incumbent upon us to take a rapid survey of the ornithological works which come more or less under the designation of "Faunæ";<sup>1</sup> but these are so numerous that it will be necessary to limit this survey, as before indicated, to those countries alone which form the homes of English people, or are commonly visited by them in ordinary travel.

Beginning with our Antipodes, it is hardly needful to go further back than Mr Buller's beautiful *Birds of New Zealand* (4to, 1827-73), with coloured plates by Mr Keulemans, since the publication of which the same author has issued a *Manual of the Birds of New Zealand* (8vo, 1832), founded on the former; but justice requires that mention be made of the labours of G. R. Gray, first in the Appendix to Diessonbach's *Travels in New Zealand* (1843) and then in the ornithological portion of the *Zoology of the Voyage of H.M.S. "Erebus" and "Terror,"* begun in 1844, but left unfinished from the following year until completed by Mr Sharpe in 1876. A considerable number of valuable papers on the Ornithology of the country by Drs Hector and Von Haast, Prof. Hutton, Mr Potts, and others are to be found in the *Transactions and Proceedings of the New Zealand Institute*.

Passing to Australia, we have the first good description of some of its Birds in the several old voyages and in Latham's works before mentioned (pages 6 and 8). Shaw's *Zoology of New Holland* (4to, 1794) added those of a few more, as did J. W. Lowin's *Natural History of the Birds of New South Wales* (4to, 1822), which reached a third edition in 1838. Gould's great *Birds of Australia* has been already named, and he subsequently reproduced with some additions the text of that work under the title of *Handbook to the Birds of Australia* (2 vols. 8vo, 1865). In 1866 Mr Diggles commenced a similar publication, *The Ornithology of Australia*, but the coloured plates, though fairly drawn, are not comparable to those of his predecessor. This is still incomplete, though the parts that have appeared have been collected to form two volumes and issued with title-pages. Some notices of Australian Birds by Mr Ramsay and others are to be found in the *Proceedings of the Linnean Society of New South Wales* and of the *Royal Society of Tasmania*.

Coming to our Indian possessions, and beginning with Ceylon, we have Kelaart's *Prodromus Faunæ Zeylanicæ* (8vo, 1852), and the admirable *Birds of Ceylon* by Capt. Legge (4to, 1878-80), with coloured plates by Mr Keulemans of all the peculiar species. It is hardly possible to name any book that has been more conscientiously executed than this. In regard to continental India many

of the more important publications have been named in a former article (BIRDS, iii. pp. 762, 763), and since that was written the chief work that has appeared is Blyth's *Mammals and Birds of Burma* (8vo, 1875).<sup>2</sup> Jerdon's *Birds of India* (8vo, 1862-64; re-printed 1877) still reigns supreme as the sole comprehensive work on the Ornithology of the Peninsula. A very fairly executed compilation on the subject by an anonymous writer is to be found in a late edition of the *Cyclopædia of India* published at Madras. It is needless to observe that *Stray Feathers*, an ornithological journal for India and its dependencies, and maintained with much spirit by Mr A. O. Hume, contains many interesting and some valuable papers.

In regard to South Africa, besides the well-known work of Le Vaillant already mentioned, there is the second volume of Sir Andrew Smith's *Illustrations of the Zoology of South Africa* (4to, 1838-42), which is devoted to birds. This is an important but cannot be called a satisfactory work. Its one hundred and fourteen plates by Ford truthfully represent one hundred and twenty-two of the mounted specimens obtained by the author in his explorations into the interior. Mr Layard's handy *Birds of South Africa* (8vo, 1867), though by no means free from faults, has much to recommend it. A so-called new edition of it by Mr Sharpe has since appeared (1875-84), but is executed on a plan so wholly different that it must be regarded as a distinct work. Anderson's *Notes on the Birds of Damara Land* (8vo, 1872) has been carefully edited by Mr Garney, whose knowledge of South-African ornithology is perhaps greater than that of any one else. It is much to be regretted that of the numerous sporting books that treat of this part of the world so few give any important information respecting the Birds.

Of special works relating to the British West Indies, Waterton's well-known *Wanderings* has passed through several editions since its first appearance in 1825, and must be mentioned here, though, strictly speaking, much of the country he traversed was not British territory. To Dr Cabanis we are indebted for the ornithological results of Richard Schomburgk's researches given in the third volume (pp. 662-765) of the latter's *Reisen im Britisch-Guiana* (8vo, 1848), and then in Léotand's *Oiseaux de l'Île de la Trinidad* (8vo, 1866). Of the Antilles there is only to be named Mr Gosse's excellent *Birds of Jamaica* (12mo, 1847), together with its *Illustrations* (sm. fol., 1849) beautifully executed by him. A nominal list, with references, of the Birds of the island is contained in the *Handbook of Jamaica* for 1881 (pp. 103-117).

So admirable a "List of Faunal Publications relating to North American Ornithology" up to the year 1878 has been given by Dr Coues as an appendix to his *Birds of the Colorado Valley* (pp. 567-784) that nothing more of the kind is wanted except to notice the chief separate works which have since appeared. These may be said to be Mr Stearns's *New England Bird Life* (2 vols. 8vo, 1881-83), revised by Dr Coues, and the several editions of his own *Check List of North American Birds* (8vo, 1882), and *Key to North American Birds* (1884); while it may be added that the concluding volumes of the *North American Birds* of Prof. Baird, the late Dr Brewer, and Mr Ridgway (the first three of which were published in 1874) are expected to be issued about the time that these lines will meet the reader's eye. Yet some of the older works are still of sufficient importance to be especially mentioned here, and especially that of Alexander Wilson, whose *American Ornithology*, originally published between 1808 and 1814, has gone through more editions than there is room to specify, though mention should be made of those issued in Great Britain, by Jameson (4 vols. 16mo, 1831), and Jardine (8 vols. 8vo, 1832). The former of these has the entire text, but no plates; the latter reproduces the plates, but the text is in places much condensed, and excellent notes are added. A continuation of Wilson's work, under the same title and on the same plan, was issued by Bonaparte between 1825 and 1833, and most of the later editions include the work of both authors. The works of Audubon, with their continuations by Cassin and Mr Elliot, and the *Fauna Boracali-Americana* of Richardson and Swainson have already been noticed (pages 11 and 15); but they need naming here, as also does Nuttall's *Manual of the Ornithology of the United States and of Canada* (2 vols. 1832-34; 2d ed., 1840); the *Birds of Long Island* (8vo, 1844) by Giraud, remarkable for its excellent account of the habits of shore-birds; and of course the *Birds of North America* (4to, 1858) by Prof. Baird, with the co-operation of Cassin and Mr Lawrence, which originally formed a volume (ix.) of what are known as the "Pacific Railroad Reports." Apart from these special works the scientific journals of Boston, New York, Philadelphia, and Washington contain innumerable papers on the Ornithology of the country, while in 1876 the *Bulletin of the Nuttall Ornithological Club* began to appear and continued until 1884, when it was superseded by *The Auk*, established solely for the promotion of Ornithology in America, and

<sup>1</sup> A very useful list of more general scope is given as the Appendix to an address by Mr Sclater to the British Association in 1875 (*Report*, pt. ii. pp. 114-183).

<sup>2</sup> This is a posthumous publication, nominally forming an extra number of the *Journal of the Asiatic Society*; but, since it was separately issued, it is entitled to notice here.

numbering among its supporters almost every American ornithologist of repute, its editors being Messrs Allen, Coates, Ridgway, Brewster, and Chamberlain.

Returning to the Old World, among the countries whose Ornithology will most interest British readers we have first Iceland, the fallest—indeed the only full—account of the Birds of which is Faber's *Prodromus der isländischen Ornithologie* (8vo, 1823), though the island has since been visited by several good ornithologists.—Proctor, Krüper, and Wolley among them. A list of its Birds, with some notes, bibliographical and biological, has been given as an Appendix to Mr Baring-Gould's *Iceland, its Scenes and Sagas* (8vo, 1862); and Mr Shepherd's *North-west Peninsula of Iceland* (8vo, 1867) recounts a somewhat profitless expedition made there expressly for ornithological objects. For the Birds of the Faroes there is Herr H. C. Müller's *Færernes Fuglefæuna* (8vo, 1862), of which a German translation has appeared.<sup>1</sup> The Ornithology of Norway has been treated in a great many papers by Herr Collett, some of which may be said to have been separately published as *Norge Fugle* (8vo, 1868; with a supplement, 1871), and *The Ornithology of Northern Norway* (8vo, 1873)—this last in English. For Scandinavia generally the latest work is Herr Collin's *Scandinaviens Fugle* (8vo, 1878), being a greatly bettered edition of the very moderate *Danmarks Fugle* of Kjerbølling; but the ornithological portion of Nilsson's *Skandinaviens Fåuna, Fåglarna* (21 ed., 2 vols. 8vo, 1858) is of great merit; while the text of Sundevall's *Svenska Fåglarna* (obl. fol., 1856-78), unfortunately unfinished at his death, and Herr Holmgren's *Scandinaviens Fåglar* (2 vols. 8vo, 1866-75) deserve naming.

Works on the Birds of Germany are far too numerous to be recounted. That of the two Naumanns, already mentioned, and yet again to be spoken of, stands at the head of all, and perhaps at the head of the "Faunal" works of all countries. For want of space it must here suffice simply to name some of the ornithologists who in this century have elaborated, to an extent elsewhere unknown, the science as regards their own country:—Altmum, Baldamus, Bochstein, Blasius (father and two sons), Bolle, Borggreve, whose *Vogel-Fauna von Norddeutschland* (8vo, 1869) contains what is practically a bibliographical index to the subject, Brehm (father and sons), Von Droste, Gätke, Gloger, Hintz, Alexander and Eugen von Homeyer, Jäckel, Koch, König-Wart-hausen, Krüper, Kutter, Landbeck, Landois, Leisler, Von Maltzan, Bernard Meyer, Von der Mühle, Neumann, Tobias, Johann Wolf, and Zander.<sup>2</sup> Were we to extend the list beyond the boundaries of the German empire, and include the ornithologists of Austria, Bohemia, and the other states subject to the same monarch, the number would be nearly doubled; but that would overpass our proposed limits, though Herr von Pelsaln must be named.<sup>3</sup> Passing onward to Switzerland, we must content ourselves by referring to the list of works, forming a *Bibliographie Ornithologica Helvetica*, drawn up by Dr Stülker for Dr Fatio's *Bulletin de la Société Ornithologique Suisse* (ii. pp. 90-119). As to Italy, we can but name here the *Fauna d'Italia*, of which the second part, *Ucelli* (8vo, 1872), by Count Salvadori, contains an excellent bibliography of Italian works on the subject, and the posthumously published *Ornithologia Italiana* of Savi (3 vols. 8vo, 1873-77).<sup>4</sup> Coming to the Iberian peninsula, we must in default of separate works depart from our rule of not mentioning contributions to journals, for of the former there are only Col. Irby's *Ornithology of the Straits of Gibraltar* (8vo, 1875) and Mr A. G. Smith's *Spring Tour in Portugal*<sup>5</sup> to be named, and these only partially cover the ground. However, Dr A. E. Brehm has published a list of Spanish Birds (*Algebra deutsche Naturhist. Zeitung*, iii. p. 481), and *The Ibis* contains several excellent papers by Lord Lilford and by Mr Saunders, the latter of whom there records (1871, p. 55) the few works on Ornithology by Spanish authors, and in the *Bulletin de la Société Zoologique de France* (i. p. 315; ii. pp. 11, 89, 185) has given a list of the Spanish Birds known to him.

Returning northwards, we have of the Birds of the whole of France nothing of real importance more recent than the volume

*Oiseaux in Vieillot's Faune Française* (8vo, 1822-29); but there is a great number of local publications of which Mr Saunders has furnished (*Zoologist*, 1878, pp. 95-99) a catalogue. Some of these seem only to have appeared in journals, but many have certainly been issued separately. Those of most interest to English ornithologists naturally refer to Brittany, Normandy, and Picardy, and are by Baillon, Benoist, Blandin, Bureau, Canivet, Chesnon, Degland, Demarie, De Norguet, Gentil, Hardy, Lemetail, Lemonnicier, Lesauvage, Maignon, Marcotte, Nourry, and Tasié, while perhaps the *Ornithologie Parisienne* of M. René Paquet, under the pseudonym of Nérée Quépat, should also be named. Of the rest the most important are the *Ornithologie Provençale* of Roux (2 vols. 4to, 1825-29); Risso's *Histoire naturelle . . . des environs de Nice* (5 vols. 8vo, 1826-27); the *Ornithologie du Dauphiné* of Boutaille and Labatie (2 vols. 8vo, 1848-44); the *Faune Meridionale* of Crespon (2 vols. 8vo, 1844); the *Ornithologie de la Savoie* of Bailly (4 vols. 8vo, 1858-54); and *Les Richesses ornithologiques du midi de la France* (4to, 1859-61) of MM. Jaubert and Barthélemy-Lapommeraye. For Belgium the *Faune Belge* of Baron De Belye-Longchamps (8vo, 1842), old as it is, remains the classical work, though the *Planches colorées des Oiseaux de la Belgique* of M. Dubois (8vo, 1851-60) is so much later in date. In regard to Holland we have Schlegel's *De Vogels van Nederland* (8 vols. 8vo, 1854-58; 2d ed., 2 vols., 1878), besides his *De Dieren van Nederland: Vogels* (8vo, 1861).

Before considering the ornithological works relating solely to the British Islands, it may be well to cast a glance on a few of those that refer to Europe in general, the more so since most of them are of Continental origin. First we have the already-mentioned *Manuel d'Ornithologie* of Temminck, which originally appeared as a single volume in 1815,<sup>6</sup> but that was speedily superseded by the second edition of 1820, in two volumes. Two supplementary parts were issued in 1835 and 1840 respectively, and the work for many years deservedly maintained the highest position as the authority on European Ornithology—indeed in England it may almost without exaggeration be said to have been nearly the only foreign ornithological work known; but, as could only be expected, grave defects are now to be discovered in it. Some of them were already manifest when one of its author's colleagues, Schlegel (who had been employed to write the text for Susemihl's plates, originally intended to illustrate Temminck's work), brought out his bilingual *Revue critique des Oiseaux d'Europe* (8vo, 1844), a very remarkable volume, since it correlated and consolidated the labours of French and German, to say nothing of Russian, ornithologists. Of Gould's *Birds of Europe* (5 vols. fol., 1852-37) nothing need be added to what has been already said. The year 1849 saw the publication of Degland's *Ornithologie Européenne* (2 vols. 8vo), a work fully intended to take the place of Temminck's; but of which Bonaparte, in a caustic but by no means ill-deserved *Revue Critique* (12mo, 1850), said that the author had performed a miracle since he had worked without a collection of specimens and without a library. A second edition, revised by M. Garbe (2 vols. 8vo, 1867), strove to remedy, and to some extent did remedy, the grosser errors of the first, but enough still remain to make few statements in the work trustworthy unless corroborated by other evidence. Meanwhile in England Dr Bree had in 1858 begun the publication of *The Birds of Europe not observed in the British Isles* (4 vols. 8vo), which was completed in 1863, and in 1875 reached a second and improved edition (5 vols.). In 1862 M. Dubois brought out a similar work on the "Espèces non observées en Belgique," being supplementary to that of his above named. In 1870 Dr Fritsch completed his *Naturgeschichte der Vögel Europas* (8vo, with atlas in folio); and in 1871 Messrs Sharpe and Dresser began the publication of their *Birds of Europe*, which was completed by the latter in 1879 (8 vols. 4to), and is unquestionably the most complete work of its kind, both for fulness of information and beauty of illustration—the coloured plates being nearly all by Mr Kuhlmann, or when not by him from the hardly inferior hand of Mr Neale. In so huge an undertaking mistakes and omissions are of course to be found if any one likes the invidious task of seeking for them; but many of the errors imputed to this work prove on investigation to refer to matters of opinion and not to matters of fact, while many more are explicable if we remember that while the work was in progress Ornithology was being prosecuted with unprecedented activity, and thus statements which were in accordance with the best information at the beginning of the period were found to need modification before it was ended. As a whole European ornithologists are all but unanimously grateful to Mr Dresser for the way in which he performed the enormous labour he had undertaken.

Coming now to works on British Birds only, the first of the present century that requires remark is Montagu's *Ornithological Dictionary* (2 vols. 8vo, 1802; supplement 1813), the merits of which have been so long and so fully acknowledged both abroad and at home that no further comment is here wanted. In 1831

<sup>1</sup> *Journal für Ornithologie*, 1869, pp. 107, 341, 381. One may almost say an English translation also, for Major Feilden's contribution to the *Zoologist* for 1873 on the same subject gives the most essential part of Herr Müller's information.

<sup>2</sup> This is of course no complete list of German ornithologists. Some of the most eminent of them have written scarcely a line on the Birds of their own country, as Cabanis (editor since 1833 of the *Journal für Ornithologie*), Finckh, Herdauk, Prince Max of Wied, A. B. Meyer, Nathusius, Neuhorn, Reichenbach, Reichenow, and Schalow among others.

<sup>3</sup> The ornithological bibliography of the Austrian-Hungarian dominions was printed in the *Verhandlungen der Zoologischen und Botanischen Society of Vienna* for 1878, by Victor Ritter von Tschudi zu Schmidhofen. A similar bibliography of Russian Ornithology by Alexander Brandt was printed at St Petersburg in 1877 or 1878.

<sup>4</sup> A useful compendium of Greek and Turkish Ornithology by Drs Krüper and Hartlaub is contained in Mommsen's *Ornithologische Jahrbücher* for 1876 (Heft III.). For other countries in the Levant there are Canon Tristram's *Fauna and Flora of Palestine* (4to, 1864) and Capt. Shelley's *Handbook to the Birds of Egypt* (8vo, 1857).

<sup>5</sup> In the final chapter of this work the author gives a list of Portuguese Birds, including besides those observed by him those recorded by Prof. Barbosa du Sampaio in the *Gazeta Medica de Lisboa*, 1861, pp. 17-21.

<sup>6</sup> Copies are said to exist bearing the date 1814.

Rennie brought out a modified edition of it (reissued in 1833), and Newman another in 1866 (reissued in 1883); but those who wish to know the author's views had better consult the original. Next in order come the very inferior *British Ornithology of Graves* (3 vols. 8vo, 1811-21), and a work with the same title by Hunt (3 vols. 8vo, 1815-22), published at Norwich, but never finished. Then we have Selby's *Illustrations of British Ornithology*, two folio volumes of coloured plates engraved by himself, between 1821 and 1833, with letterpress also in two volumes (8vo, 1825-33), a second edition of the first volume being also issued (1838), for the author, having yielded to the pressure of the "Quinarian" doctrines then in vogue, thought it necessary to adjust his classification accordingly, and it must be admitted that for information the second edition is best. In 1828 Fleming brought out his *History of British Animals* (8vo), in which the Birds are treated at considerable length (pp. 41-146), though not with great success. In 1835 Mr Jenyns (now Blomfield) produced an excellent *Manual of British Vertebrate Animals*, a volume (8vo) executed with great scientific skill, the Birds again receiving due attention (pp. 49-286), and the descriptions of the various species being as accurate as they are terse. In the same year began the *Coloured Illustrations of British Birds and their Eggs* of H. L. Meyer (4to), which was completed in 1843, whereof a second edition (7 vols. 8vo, 1842-50) was brought out, and subsequently (1852-57) a reissue of the latter. In 1836 appeared Eyton's *History of the rarer British Birds*, intended as a sequel to Bewick's well-known volumes, to which no important additions had been made since the issue of 1821. The year 1837 saw the beginning of two remarkable works by Macgillivray and Yarrell respectively, and each entitled *A History of British Birds*. Of the first, undoubtedly the more original and in many respects the more minutely accurate, mention will again have to be made (page 24), and, save to state that its five volumes were not completed till 1852, nothing more needs now to be added. The second has unquestionably become the standard work on British Ornithology, a fact due in part to its numerous illustrations, many of them indeed ill drawn, though all carefully engraved, but much more to the breadth of the author's views and the judgment with which they were set forth. In practical acquaintance with the internal structure of Birds, and in the perception of its importance in classification, he was certainly not behind his rival; but he well knew that the British public in a Book of Birds not only did not want a series of anatomical treatises, but would even resent their introduction. He had the art to conceal his art, and his work was therefore a success, while the other was unhappily a failure. Yet with all his knowledge he was deficient in some of the qualities which a great naturalist ought to possess. His conception of what his work should be seems to have been perfect, his execution was not equal to the conception. However, he was not the first nor will he be the last to fall short in this respect. For him it must be said that, whatever may have been done by the generation of British ornithologists now becoming advanced in life, he educated them to do it; nay, his influence even extends to a younger generation still, though they may hardly be aware of it. Of Yarrell's work in three volumes, a second edition was published in 1845, a third in 1856, and a fourth, begun in 1871, and almost wholly rewritten, is still unfinished. Of the compilations based upon this work, without which they could not have been composed, there is no need to speak. One of the few appearing since, with the same scope, that are not borrowed is Jardine's *Birds of Great Britain and Ireland* (4 vols. 8vo, 1838-43), forming part of his *Naturalist's Library*; and Gould's *Birds of Great Britain* has been already mentioned.

A considerable number of local works deserving of notice have also to be named. The first three volumes of Thompson's *Natural History of Ireland* (8vo, 1849-51) contain an excellent account of the Birds of that island, and Mr Watters's *Birds of Ireland* (8vo, 1858) has also to be mentioned. For North Britain there is Mr Robert Gray's *Birds of the West of Scotland* (8vo, 1871), which virtually is an account of those of almost the whole of that part of the kingdom. To these may be added Dunn's *Ornithologist's Guide to Orkney and Shetland* (8vo, 1887), the unfinished *Historia Naturalis Orcadensis* of Baikie and Heddle (8vo, 1848), and Saxby's *Birds of Shetland* (8vo, 1874), while the sporting works of Charles St John contain much information on the Ornithology of the Highlands.<sup>1</sup> The local works on English Birds are still more numerous, but among them may be especially named Dillwyn's *Fauna and Flora of Swansea* (1848), Mr Knox's *Ornithological Rambles in Sussex* (1849), Mr Stevenson's *Birds of Norfolk* (1866-70), Mr Cecil Smith's *Birds of Somerset* (1869) and *Birds of*

*Guernsey* (1879), Mr Cordonax's *Birds of the Humber District* (1872), Mr John Hancock's *Birds of Northumberland and Durham* (1874), *The Birds of Nottinghamshire* by Messrs Sterland and Whitaker (1879), *Rodd's Birds of Cornwall* edited by Mr Harting (1880), and the *Vertebrate Fauna of Yorkshire* (1881), of which the "Birds" are by Mr W. E. Clarke.

The good effects of "Faunal" works such as those named in the foregoing rapid survey none can doubt. "Every kingdom, every province, should have its own monographer," wrote Gilbert White more than one hundred years ago, and experience has proved the truth of his assertion. In a former article (*BIRDS*, iii. pp. 736-764) the attempt has been made to shew how the labours of monographers of this kind, but on a more extended scale, can be brought together, and the valuable results that thence follow. Important as they are, they do not of themselves constitute Ornithology as a science; and an enquiry, no less wide and far more recondite, still remains. By whatever term we choose to call it—Classification, Arrangement, Systematising, or Taxonomy—that enquiry which has for its object the discovery of the natural groups into which Birds fall, and the mutual relations of those groups, has always been one of the deepest interest, and to it we must now recur.

But nearly all the authors above named, it will have been seen, trod the same ancient paths, and in the works of scarcely one of them had any new spark of intelligence been struck out to enlighten the gloom which surrounded the investigator. It is now for us to trace the rise of the present more advanced school of ornithologists whose labours, preliminary as we must still regard them to be, yet give signs of far greater promise. It would probably be unsafe to place its origin further back than a few scattered hints contained in the "Pterographische Fragments" of CHRISTIAN LUDWIG NITZSCH, published in the *Magazin für den neuesten Zustand der Naturkunde* (edited by Voigt) for May 1806 (xi. pp. 393-417), and even these might be left to pass unnoticed, were it not that we recognize in them the germ of the great work which the same admirable zoologist subsequently accomplished. In these "Fragments," apparently his earliest productions, we find him engaged on the subject with which his name will always be especially identified, the structure and arrangement of the feathers that form the proverbial characteristic of Birds. But, though the observations set forth in this essay were sufficiently novel, there is not much in them that at the time would have attracted attention, for perhaps no one—not even the author himself—could have then foreseen to what important end they would, in conjunction with other investigations, lead future naturalists; but they are marked by the same close and patient determination that eminently distinguishes all the work of their author; and, since it will be necessary for us to return to this part of the subject later, there is here no need to say more of them. In the following year another set of hints—of a kind so different that probably no one then living would have thought it possible that they should ever be brought in correlation with those of Nitzsch—are contained in a memoir on Fishes contributed to the tenth volume of the *Annales du Muséum d'histoire naturelle* of Paris by ETIENNE GEOFFROY ST-HILAIRE in 1807.<sup>2</sup> Here we have it stated as a general truth (p. 100) that young birds have the sternum formed of five separate pieces—one in the middle, being its keel, and two "annexes" on each side to which the ribs are articulated—all, however, finally uniting to form the single "breast-bone." Further on (pp. 101, 102) we find observations as to the number of ribs which are attached to each of the "annexes"—there being some-

<sup>1</sup> Though contravening our plan, we must for its great merits notice here Mr More's series of papers in *The Ibis* for 1865, "On the Distribution of Birds in Great Britain during the Nesting Season."

<sup>2</sup> Did our scheme permit us, we should be glad to mention in detail the various important communications on Scottish Birds of Alston, Messrs Buckley, Harvie-Brown, Lumsden, and others.

<sup>3</sup> In the *Philosophie Anatomique* (l. pp. 69-101, and especially pp. 135, 136), which appeared in 1818, Geoffroy St-Hilaire explained the views he had adopted at greater length.

times more of them articulated to the anterior than to the posterior, and in certain forms no ribs belonging to one, all being applied to the other. Moreover, the author goes on to remark that in adult birds trace of the origin of the sternum from five centres of ossification is always more or less indicated by sutures, and that, though these sutures had been generally regarded as ridges for the attachment of the sternal muscles, they indeed mark the extreme points of the five primary bony pieces of the sternum.

In 1810 appeared at Heidelberg the first volume of THEHMANN'S carefully-wrought *Anatomie und Naturgeschichte der Vögel*—which shows a remarkable advance upon the work which Cuvier did in 1805, and in some respects is superior to his later production of 1817. It is, however, only noticed here on account of the numerous references made to it by succeeding writers, for neither in this nor in the author's second volume (not published until 1814) did he propound any systematic arrangement of the Class. More germane to our present subject are the *Osteographische Beiträge zur Naturgeschichte der Vögel* of NITZSCH, printed at Leipzig in 1811—a miscellaneous set of detached essays on some peculiarities of the skeleton or portions of the skeleton of certain Birds—one of the most remarkable of which is that on the component parts of the foot (pp. 101-105) pointing out the aberration from the ordinary structure exhibited by the Goatsucker (*Caprimulgus*) and the Swift (*Cypselus*)—an aberration which, if rightly understood, would have conveyed a warning to those ornithological systematists who put their trust in Birds' toes for characters on which to erect a classification, if there was in them much more of importance, hidden in the integument, than had hitherto been suspected; but the warning was of little avail, if any, till many years had elapsed. However, Nitzsch had not as yet seen his way to proposing any methodical arrangement of the various groups of Birds, and it was not until some eighteen months later that a scheme of classification in the main anatomical was attempted.

This scheme was the work of BLASIVS MERREM, who, in a communication to the Academy of Sciences of Berlin on the 10th December 1812, which was published in its *Abhandlungen* for the following year (pp. 237-259), set forth a *Tentamen Systematis naturalis Avium*, no less modestly entitled than modestly executed. The attempt of Merrem must be regarded as the virtual starting-point of the latest efforts in Systematic Ornithology, and in that view its proposals deserve to be stated at length. Without pledging ourselves to the acceptance of all its details—some of which, as is only natural, cannot be sustained with our present knowledge, resulting from the information accumulated by various investigators throughout more than seventy years—it is certainly not too much to say that Merrem's merits are almost incomparably superior to those of any of his predecessors as well as to those of the majority of his successors for a long time to come; while the neglect of his treatise by many (perhaps it would not be erroneous to say by most) of those who have since written on the subject seems inexcusable save on the score of inadvertence. Premising then that the chief characters assigned by this ill-appreciated systematist to his several groups are drawn from almost all parts of the structure of Birds, and are supplemented by some others of their more prominent peculiarities, we present the following abstract of his scheme:—

<sup>1</sup> The names of the genera are, he tells us, for the most part those of Linnæus, as being the best-known, though not the best. To some of the Linnæan genera he dare not, however, assign a place, for instance, *Bucconid*, *Hæmatopus*, *Merops*, *Glareola* (Osmann's genus, by the bye), and *Palaemodæa*.

I. AVES CARINATÆ.

1. AVES ACROÆ.

A. Rapacæ.—a. Accipitres—*Fultur*, *Falco*, *Sagittarius*.  
b. Strix.

B. Hymenopodæ.—a. Chelidonæ: a. *C. nocturna*—*Caprimulgus*; b. *C. diurna*—*Hirundo*.

β. Ocinæ: a. *O. conirostris*—*Loria*, *Fringilla*, *Emberiza*, *Tangara*; b. *O. tenuirostris*—*Alauda*, *Motacilla*, *Mniotilta*, *Todus*, *Lanius*, *Ampelis*, *Turdus*, *Parus*, *Buphaga*, *Sturnus*, *Oriolus*, *Gracula*, *Coracias*, *Corvus*, *Pipra*, *Parus*, *Sitta*, *Certhia* quædam.

C. Mellinæ.—*Trochilus*, *Certhia* et *Upupa* plurimæ.

D. Dendrocolaptæ.—*Picus*, *Yunx*.

E. Brevilinguæ.—a. *Upupa*; b. *Isipida*.

F. Levirostræ.—a. *Ramphastus*, *Scythrops*; b. *Festucæ*.

G. Coccygæ.—*Cuculus*, *Trogon*, *Bucco*, *Crotophaga*.

2. AVES TERRESTRES.

A. *Columba*.

B. *Gallina*.

3. AVES AQUATICÆ.

A. Odontorhynchi: a. *Bucconæ*—*Anas*; b. *Mergus*; c. *Phalacropterus*.

B. *Platyrhynchi*—*Pelecanus*, *Phaeton*, *Platua*.

C. *Aptenodytes*.

D. Urinatrices: a. *Cephi*—*Alca*, *Colymbi* pedibus palmatis; b. *Podiceps*, *Colymbi* pedibus lobatis.

E. Stenorhynchi.—*Procellaria*, *Diomedæa*, *Larus*, *Sterna*, *Rhynchops*.

4. AVES PALUSTRES.

A. Rusticolæ: a. *Phalaridæ*—*Rallus*, *Fulica*, *Purra*; b. *Limosinæ*—*Numenius*, *Scelopax*, *Tringa*, *Charadrius*, *Recurvirostra*.

B. Grallæ: a. *Erodii*—*Ardeæ* unguis intermedio serrato, *Canceroma*; b. *Pelargi*—*Ciconia*, *Mydarteria*, *Tantalus* quidam, *Scopus*, *Platalea*; c. *Gerani*—*Ardeæ* cristata, *Gruæ*, *Prophæta*.

C. *Otia*.

II. AVES RATITÆ.—*Struthio*.

The most novel feature, and one the importance of which most ornithologists of the present day are fully prepared to admit, is of course the separation of the Class *Aves* into two great Divisions, which from one of the most obvious distinctions they present were called by its author *Carinata*<sup>2</sup> and *Ratita*,<sup>3</sup> according as the sternum possesses a keel (*crista* in the phraseology of many anatomists) or not. But Merrem, who subsequently communicated to the Academy of Berlin a more detailed memoir on the "flat-breasted" Birds,<sup>4</sup> was careful not here to rest his Divisions on the presence or absence of their sternal character alone. He concisely cites (p. 238) no fewer than eight other characters of more or less value as peculiar to the Carinate Division, the first of which is that the feathers have their barbs furnished with hooks, in consequence of which the barbs, including those of the wing-quills, cling closely together; while among the rest may be mentioned the position of the furcula and coracoids,<sup>5</sup> which keep the wing-bones apart; the limitation of the number of the lumbar vertebra to fifteen, and of the carpals to two; as well as the divergent direction of the iliac bones,—the corresponding characters peculiar to the Ratite Division being (p. 259) the disconnected condition of the barbs of the feathers, through the absence of any hooks whereby they might cohere; the non-existence of the furcula, and the coalescence of the coracoids with the scapulæ (or, as he expressed it, the extension of the scapulæ to supply the place of the coracoids, which he thought were wanting); the lumbar vertebra being twenty and the carpals three in number; and the parallelism of the iliac bones.

<sup>2</sup> From *carina*, a keel.  
<sup>3</sup> From *ratæ*, a raft or flat-bottomed barge.  
<sup>4</sup> "Beschreibung der Gerippes eines Casuars nebst einigen beiläufigen Bemerkungen über die flachbrüstigen Vögel"—*Abhandl. der Berlin. Akademie, Phys. Klasse*, 1817, pp. 179-198, tabb. I-III.  
<sup>5</sup> Merrem, as did many others in his time, calls the coracoids "*claviculæ*"; but it is now well understood that in Birds the real *claviculæ* form the furcula or "merry-thought."

As for Merrem's partitioning of the inferior groups there is less to be said in its praise as a whole, though credit must be given to his anatomical knowledge for leading him to the perception of several affinities, as well as differences, that had never before been suggested by superficial systematists. But it must be confessed that (chiefly, no doubt, from paucity of accessible material) he overlooked many points, both of alliance and the opposite, which since his time have gradually come to be admitted. For instance, he seems not to have been aware of the distinction, already shown by Nitzsch (as above mentioned) to exist, between the Swallows and the Swifts; and, by putting the genus *Coracias* among his *Ocines Tenuirostris*<sup>1</sup> without any remark, proved that he was not in all respects greatly in advance of his age; but on the other hand he most righteously judged that some species hitherto referred to the genera *Certhia* and *Upupa* required removal to other positions, and it is much to be regretted that the very concise terms in which his decisions were given to the world make it impossible to determine with any degree of certainty the extent of the changes in this respect which he would have introduced. Had Merrem published his scheme on an enlarged scale, it seems likely that he would have obtained for it far more attention, and possibly some portion of acceptance. He had deservedly attained no little reputation as a descriptive anatomist, and his claims to be regarded as a systematic reformer would probably have been admitted in his lifetime. As it was his scheme apparently fell flat, and not until many years had elapsed were its merits at all generally recognized.

Notice has next to be taken of a Memoir on the Employment of Sternal Characters in establishing Natural Families among Birds, which was read by DE BLAINVILLE before the Academy of Sciences of Paris in 1815,<sup>2</sup> but not published in full for more than five years later (*Journal de Physique . . . et des Arts*, xcii. pp. 185-215), though an abstract forming part of a *Prodrome d'une nouvelle distribution du Règne Animal* appeared earlier (*op. cit.*, lxxxiii. pp. 252, 253, 258, 259; and *Bull. Soc. Philomath. de Paris*, 1816, p. 110). This is a very disappointing performance, since the author observes that, notwithstanding his new classification of Birds is based on a study of the form of the sternal apparatus, yet, because that lies wholly within the body, he is compelled to have recourse to such outward characters as are afforded by the proportion of the limbs and the disposition of the toes—even as had been the practice of most ornithologists before him! It is evident that the features of the sternum on which De Blainville chiefly relied were those drawn from its posterior margin, which no very extensive experience of specimens is needed to show are of comparatively slight value; for the number of "*échancrures*"—notches as they have sometimes been called in English—when they exist, goes but a very short way as a guide, and is so variable in some very natural groups as to be even in that short way occasionally misleading.<sup>3</sup> There is no appearance of his having at all taken into consideration the far more trustworthy characters furnished by the anterior part of the sternum, as well as by the coracoids and the furcula. Still De Blainville made some advance in a right direction, as for instance by elevating the Parrots<sup>4</sup> and the Pigeons as "*Ordres*," equal in rank to that of the Birds-of-Prey and some others.

<sup>1</sup> He also placed the genus *Todus* in the same group, but it must be borne in mind that in his time a great many Birds were referred to that genus which (according to modern ideas) certainly do not belong to it, and it may well have been that he never had the opportunity of examining a specimen of the genus as nowadays restricted.

<sup>2</sup> Not 1812, as has sometimes been stated.

<sup>3</sup> Cf. *Philos. Transactions*, 1869, p. 337, note.

<sup>4</sup> This view of them had been long before taken by Willughby, but abandoned by all later authors.

According to the testimony of L'Hermier (for whom see later) he divided the "*Passereus*" into two sections, the "*Jans*" and the "*uraia*"; but, while the latter were very correctly defined, the former were most arbitrarily separated from the "*Grimpreus*." He also split his *Grallatores* and *Natatores* (practically identical with the *Grallæ* and *Anseres* of Linnaeus) each into four sections; but he failed to see—as on his own principles he ought to have seen—that each of these sections was at least equivalent to almost any one of his other "*Ordres*." He had, however, the courage to act up to his own professions in collocating the Rollers (*Coracias*) with the Bee-eaters (*Merops*), and had the sagacity to surmise that *Mesura* was not a Gallinaceous Bird. The greatest benefit conferred by this memoir is probably that it stimulated the efforts, presently to be mentioned, of one of his pupils, and that it brought more distinctly into sight that other factor, originally discovered by Merrem, of which it now clearly became the duty of systematizers to take cognizance.

Following the chronological order we are here adopting, we next have to recur to the labours of NITZSCH, who, in 1820, in a treatise on the Nasal Glands of Birds—a subject that had already attracted the attention of JACOBSON (*Nov. Bull. Soc. Philomath. de Paris*, iii. pp. 267-269)—first put forth in Meckel's *Deutsches Archiv für die Physiologie* (vi. pp. 251-269) a statement of his general views on ornithological classification which were based on a comparative examination of those bodies in various forms. It seems unnecessary here to occupy space by giving an abstract of his plan,<sup>5</sup> which hardly includes any but European species, because it was subsequently elaborated with no inconsiderable modifications in a way that must presently be mentioned at greater length. But the scheme, crude as it was, possesses some interest. It is not only a key to much of his later work—to nearly all indeed that was published in his lifetime—but in it are founded several definite groups (for example, *Passerinae* and *Picariae*) that subsequent experience has shown to be more or less natural; and it further serves as additional evidence of the breadth of his views, and his trust in the teachings of anatomy; for it is clear that, if organs so apparently insignificant as these nasal glands were found worthy of being taken into account, and capable of forming a base of operations, in drawing up a system, it would almost follow that there can be no part of a Bird's organization that by proper study would not help to supply some means of solving the great question of its affinities. This seems to the present writer to be one of the most certain general truths in Zoology, and is probably admitted in theory to be so by most zoologists, but their practice is opposed to it; for, whatever group of animals be studied, it is found that one set or another of characters is the chief favourite of the authors consulted—each generally taking a separate set, and that to the exclusion of all others, instead of effecting a combination of all the sets and taking the aggregate.<sup>6</sup>

That Nitzsch took this extended view is abundantly proved by the valuable series of ornithological observations which he must have been for some time accumulating.

<sup>5</sup> This plan, having been repeated by Schöps in 1829 (*op. cit.*, xii. p. 78), became known to Sir R. Owen in 1835, who then drew to it the attention of Kirby (*Sixteenth Bridgewater Treatise*, ii. pp. 444, 445), and in the next year referred to it in his own article "*Aves*" in *Todd's Cyclopædia of Anatomy* (l. p. 266), so that Englishmen need no excuse for not being aware of one of Nitzsch's labours, though his more advanced work of 1829, presently to be mentioned, was not referred to by Sir R. Owen.

<sup>6</sup> A very remarkable instance of this may be seen in the *Systema Avium*, promulgated in 1830 by Wagler (a man with great knowledge of Birds) in his *Natürliches System der Amphibien* (pp. 77-128). He took the tongue as his chief guide, and found it indeed an unruly member,

and almost immediately afterwards began to contribute to the younger Naumann's excellent *Naturgeschichte der Vögel Deutschlands*, already noticed above (page 9). Besides a concise general treatise on the Organization of Birds to be found in the Introduction to this work (i. pp. 23-52), a brief description from Nitzsch's pen of the peculiarities of the internal structure of nearly every genus is incorporated with the author's prefatory remarks, as each passed under consideration, and these descriptions being almost without exception so drawn up as to be comparative are accordingly of great utility to the student of classification, though they have been so greatly neglected. Upon these descriptions he was still engaged till death, in 1837, put an end to his labours, when his place as Naumann's assistant for the remainder of the work was taken by Rudolph Wagner; but, from time to time, a few more, which he had already completed, made their posthumous appearance in it, and, even in recent years, some selections from his unpublished papers have through the care of Giebel been presented to the public. Throughout the whole of this series the same marvellous industry and scrupulous accuracy are manifested, and attentive study of it will shew how many times Nitzsch anticipated the conclusions at which it has taken some modern taxonomers fifty years to arrive. Yet over and over again his determination of the affinities of several groups even of European Birds was disregarded; and his labours, being contained in a bulky and costly work, were hardly known at all outside of his own country, and within it by no means appreciated so much as they deserved<sup>1</sup>—for even Naumann himself, who gave them publication, and was doubtless in some degree influenced by them, utterly failed to perceive the importance of the characters offered by the song-muscles of certain groups, though their peculiarities were all duly described and recorded by his coadjutor, as some indeed had been long before by Cuvier in his famous dissertation<sup>2</sup> on the organs of voice in Birds (*Léçons d'anatomie comparée*, iv. pp. 450-491). Nitzsch's name was subsequently dismissed by Cuvier without a word of praise, and in terms which would have been applicable to many another and inferior author, while Temminck, terming Naumann's work an "*ouvrage de luxe*,"—it being in truth one of the cheapest for its contents ever published,—effectually shut it out from the realms of science. In Britain it seems to have been positively unknown until quoted some years after its completion by a catalogue-compiler on account of some peculiarities of nomenclature which it presented.<sup>3</sup>

Now we must return to France, where, in 1827, L'HERMINIER, a creole of Guadaloupe and a pupil of De Blainville's, contributed to the *Actes* of the Linnæan Society of Paris for that year (vi. pp. 3-93) the "*Recherches sur l'appareil sternal des Oiseaux*," which the precept and example of his master had prompted him to undertake, and Cuvier had found for him the means of executing. A second and considerably enlarged edition of this very remarkable treatise was published as a separate work in the following year. We have already seen that De Blainville, though fully persuaded of the great value of sternal features as a method of classification, had been compelled to fall back upon the old pedal characters so often employed before; but now the scholar had learnt to excel his teacher, and not only to form an at least provi-

sional arrangement of the various members of the Class, based on sternal characters, but to describe these characters at some length, and so give a reason for the faith that was in him. There is no evidence, so far as we can see, of his having been aware of Merrem's views; but like that anatomist he without hesitation divided the Class into two great "*coupees*," to which he gave, however, no other names than "*Oiseaux Normaux*" and "*Oiseaux Anormaux*,"—exactly corresponding with his predecessor's *Carinatus* and *Ratius*—and, moreover, he had a great advantage in founding these groups, since he had discovered, apparently from his own investigations, that the mode of ossification in each was distinct; for hitherto the statement of there being five centres of ossification in every Bird's sternum seems to have been accepted as a general truth, without contradiction, whereas in the Ostrich and the Rhea, at any rate, L'Herminier found that there were but two such primitive points,<sup>4</sup> and from analogy he judged that the same would be the case with the Cassowary and the Emou, which, with the two forms mentioned above, made up the whole of the "*Oiseaux Anormaux*" whose existence was then generally acknowledged.<sup>5</sup> These are the forms which composed the Family previously termed *Cursoræ* by De Blainville; but L'Herminier was able to distinguish no fewer than thirty-four Families of "*Oiseaux Normaux*," and the judgment with which their separation and definition were effected must be deemed on the whole to be most creditable to him. It is to be remarked, however, that the wealth of the Paris Museum, which he enjoyed to the full, placed him in a situation incomparably more favourable for arriving at results than that which was occupied by Merrem, to whom many of the most remarkable forms were wholly unknown, while L'Herminier had at his disposal examples of nearly every type then known to exist. But the latter used this privilege wisely and well—not, after the manner of De Blainville and others subsequent to him, relying solely or even chiefly on the character afforded by the posterior portion of the sternum, but taking also into consideration those of the anterior, as well as of the in some cases still more important characters presented by the pre-sternal bones, such as the furcula, coracoids, and scapula. L'Herminier thus separated the Families of "Normal Birds"—

- |   |  |
|---|--|
| 1. "Accipitres"— <i>Accipitres</i> , Linn.        | 18. "Passeræ"— <i>Passeræ</i> , Linn.                              |
| 2. "Serpentaires"— <i>Cypocopterus</i> , Illiger. | 19. "Pigeons"— <i>Columba</i> , Linn.                              |
| 3. "Chouettes"— <i>Syris</i> , Linn.              | 20. "Gallinacæ"— <i>Gallinacæ</i> , Linn.                          |
| 4. "Touraocs"— <i>Opatrus</i> , Vieillot.         | 21. "Tinamous"— <i>Tinamus</i> , Latham.                           |
| 5. "Petroquets"— <i>Prittacus</i> , Linn.         | 22. "Fouilles ou Poules d'eau"— <i>Fulica</i> , Linn.              |
| 6. "Colibris"— <i>Trochilus</i> , Linn.           | 23. "Grues"— <i>Grus</i> , Pallas.                                 |
| 7. "Martinets"— <i>Cypselus</i> , Illiger.        | 24. "Hérodions"— <i>Herodias</i> , Illiger.                        |
| 8. "Engoulevents"— <i>Caprimulgus</i> , Linn.     | 25. No name given, but said to include "les ibis et les spatules." |
| 9. "Coucous"— <i>Cuculus</i> , Linn.              | 26. "Gralles ou Échassiers"— <i>Grallæ</i> , Linn.                 |
| 10. "Courocoucs"— <i>Trogon</i> , Linn.           | 27. "Mouettes"— <i>Larus</i> , Linn.                               |
| 11. "Rolliers"— <i>Galgulus</i> , Brisson.        | 28. "Pétrels"— <i>Procellariæ</i> , Linn.                          |
| 12. "Gnâpiers"— <i>Merops</i> , Linn.             | 29. "Pâlicans"— <i>Pelecanus</i> , Linn.                           |
| 13. "Martins-Pêcheurs"— <i>Alcedo</i> , Linn.     | 30. "Canards"— <i>Anas</i> , Linn.                                 |
| 14. "Calacs"— <i>Buccones</i> , Linn.             | 31. "Grèbes"— <i>Podiceps</i> , Latham.                            |
| 15. "Toucans"— <i>Ramphastos</i> , Linn.          | 32. "Plongeurs"— <i>Columbus</i> , Latham.                         |
| 16. "Pies"— <i>Picus</i> , Linn.                  | 33. "Pingouins"— <i>Alca</i> , Latham.                             |
| 17. "Épépides"— <i>Epopsides</i> , Vieillot.      | 34. "Manchots"— <i>Aptemodytes</i> , Forster.                      |

<sup>1</sup> Their value was, however, understood by Gloger, who in 1834, as will presently be seen, expressed his regret at not being able to use them.

<sup>2</sup> Cuvier's first observations on the subject seem to have appeared in the *Magasin Encyclopédique* for 1795 (ii. pp. 380, 383).

<sup>3</sup> However, to this catalogue-compiler the present writer's gratitude is due, for thereby he became acquainted with the work and its merits.

<sup>4</sup> This fact in the Ostrich appears to have been known already to Geoffroy St-Hilaire from his own observation in Egypt, but does not seem to have been published by him.

<sup>5</sup> Considerable doubts were at that time, as said elsewhere (Krw, vol. xiv. p. 104), entertained in Paris as to the existence of the *Apteryx*.



The preceding list is given to shew the very marked agreement of L'Herminier's results compared with those obtained fifty years later by another investigator, who approached the subject from an entirely different, though still osteological, basis. The sequence of the Families adopted is of course open to much criticism; but that would be wasted upon it at the present day; and the cautious naturalist will remember that it is generally difficult and in most cases absolutely impossible to deploy even a small section of the Animal Kingdom into line. So far as a linear arrangement will permit, the above list is very creditable, and will not only pass muster, but cannot easily be surpassed for excellence even at this moment. Experience has shewn that a few of the Families are composite, and therefore require further splitting; but examples of actually false grouping cannot be said to occur. The most serious fault perhaps to be found is the intercalation of the Ducks (No. 30) between the Pelicans and the Grebes—but every systematist must recognize the difficulty there is in finding a place for the Ducks in any arrangement we can at present contrive that shall be regarded as satisfactory. Many of the excellencies of L'Herminier's method could not be pointed out without too great a sacrifice of space, because of the details into which it would be necessary to enter; but the trenchant way in which he showed that the "Passereaux"—a group of which Cuvier had said "Son caractère semble d'abord purement négatif," and had then failed to define the limits—differed so completely from every other assemblage, while maintaining among its own innumerable members an almost perfect essential homogeneity, is very striking, and shews how admirably he could grasp his subject. Not less conspicuous are his merits in disposing of the groups of what are ordinarily known as Water-birds, his indicating the affinity of the Rails (No. 22) to the Cranes (No. 23), and the severing of the latter from the Herons (No. 24). His union of the Snipes, Sandpipers, and Plovers into one group (No. 26) and the alliance, especially dwelt upon, of that group with the Gulls (No. 27) are steps which, though indicated by Merrem, are here for the first time clearly laid down; and the separation of the Gulls from the Petrels (No. 28)—a step in advance already taken, it is true, by Illiger—is here placed on indefeasible ground. With all this, perhaps on account of all this, L'Herminier's efforts did not find favour with his scientific superiors, and for the time things remained as though his investigations had never been carried on.<sup>1</sup>

Two years later Nitzsch, who was indefatigable in his endeavour to discover the Natural Families of Birds, and had been pursuing a series of researches into their vascular system, published the result, at Halle in Saxony, in his *Observationes de Avium arteria carotidæ communi*, in which is included a classification drawn up in accordance with the variation of structure which that important vessel presented in the several groups that he had opportunities of examining. By this time he had visited several of the principal museums on the Continent, among others Leyden (where Temminck resided) and Paris (where he had frequent intercourse with Cuvier), thus becoming acquainted with a considerable number of exotic forms that had hitherto been inaccessible to him. Consequently his labours had attained to a certain degree of completeness in this direction, and it may therefore be expedient here to name the different groups which he thus thought himself entitled to consider established. They are as follows:—

<sup>1</sup> With the exception of a brief and wholly inadequate notice in the *Edinburgh Journal of Natural History* (l. p. 90), the present writer is not aware of attention having been directed to L'Herminier's labours by British ornithologists for several years after; but considering how they were employing themselves at the time (as is shewn in another place) this is not surprising.

#### I. AVES CARINATÆ [L'H. Oiseaux Normaux \*].

A. Aves Carinatæ aereæ.

1. *Accipitrinus* [L'H. 1, 2 partim, 3]; 2. *Passerinus* [L'H. 18]; 3. *Macrochirus* [L'H. 6, 7]; 4. *Cuculinus* [L'H. 8, 9, 10 (qu. 11, 13)]; 5. *Picinus* [L'H. 15, 16]; 6. *Pratincola* [L'H. 5]; 7. *Lipoglossus* [L'H. 13, 14, 17]; 8. *Amphibolus* [L'H. 4].

B. Aves Carinatæ terrestres.

1. *Columbina* [L'H. 19]; 2. *Gallinaceus* [L'H. 20].

C. Aves Carinatæ aquaticæ.

Gralla.

1. *Alactoides* (= *Dicholophus* + *Otis*) [L'H. 2 partim, 26 partim]; 2. *Grutinus* [L'H. 23]; 3. *Fulicarius* [L'H. 22]; 4. *Herodias* [L'H. 24 partim]; 5. *Pelargi* [L'H. 24 partim, 25]; 6. *Odonoglossi* (= *Phaniopterus*) [L'H. 26 partim]; 7. *Limicola* [L'H. 26 pene omnes].

Palmata.

8. *Longipennis* [L'H. 27]; 9. *Nasutus* [L'H. 28]; 10. *Unguivores* [L'H. 30]; 11. *Steganopodes* [L'H. 29]; 12. *Pygopodes* [L'H. 31, 32, 33, 34].

#### II. AVES RATICÆ [L'H. "Oiseaux Anomaux \*].

To enable the reader to compare the several groups of Nitzsch with the Families of L'Herminier, the numbers applied by the latter to his Families are suffixed in square brackets to the names of the former; and, disregarding the order of sequence, which is here immaterial, the essential correspondences of the two systems is worthy of all attention, for it obviously means that these two investigators, starting from different points, must have been on the right track, when they so often coincided as to the limits of what they considered to be, and what we are now almost justified in calling, Natural Groups.<sup>2</sup> But it must be observed that the classification of Nitzsch, just given, rests much more on characters furnished by the general structure than on those furnished by the carotid artery only. Among all the species (188, he tells us, in number) of which he examined specimens, he found only four variations in the structure of that vessel, namely:—

1. That in which both a right carotid artery and a left are present. This is the most usual fashion among the various groups of Birds, including all the "aerial" forms excepting *Passerinus*, *Macrochirus*, and *Picinus*.

2. That in which there is but a single carotid artery, springing from both right and left trunk, but the branches soon coalescing, to take a midway course, and again dividing near the head. This form Nitzsch was only able to find in the Bittern (*Ardea stellaris*).

3. That in which the right carotid artery alone is present, of which, according to our author's experience, the Flamingo (*Phoenicopterus*) was the sole example.

4. That in which the left carotid artery alone exists, as found in all other Birds examined by Nitzsch, and therefore as regards species and individuals much the most common—since into this category come the countless thousands of the Passerine Birds—a group which outnumbers all the rest put together.

Considering the enormous stride in advance made by L'Herminier, it is very disappointing for the historian to have to record that the next inquirer into the osteology of Birds achieved a disastrous failure in his attempt to throw light on their arrangement by means of a comparison of their sternum. This was BERTHOLD, who devoted a long chapter of his *Beitrag zur Anatomie*, published at Göttingen in 1831, to a consideration of the subject. So far as his introductory chapter went—the development of the sternum—he was, for

<sup>2</sup> Whether Nitzsch was cognizant of L'Herminier's views is in no way apparent. The latter's name seems not to be even mentioned by him, but Nitzsch was in Paris in the summer of 1827, and it is almost impossible that he should not have heard of L'Herminier's labours, unless the relations between the followers of Cuvier, to whom Nitzsch attached himself, and those of De Blainville, whose pupil L'Herminier was, were such as to forbid any communication between the rival schools. Yet we have L'Herminier's evidence that Cuvier gave him every assistance. Nitzsch's silence, both on this occasion and afterwards, is very curious; but he cannot be accused of plagiarism, for the scheme given above is only an amplification of that foreshadowed by him (as already mentioned) in 1820—a scheme which seems to have been equally unknown to L'Herminier, perhaps through linguistic difficulty.

his time, right enough and somewhat instructive. It was only when, after a close examination of the sternal apparatus of one hundred and thirty species, which he carefully described, that he arrived (pp. 177-188) at the conclusion—astonishing to us who know of L'Herminier's previous results—that the sternum of Birds cannot be used as a help to their classification on account of the egregious anomalies that would follow the proceeding—such anomalies, for instance, as the separation of *Cypselus* from *Hirundo* and its alliance with *Trochilus*, and the grouping of *Hirundo* and *Fringilla* together. He seems to have been persuaded that the method of Linnæus and his disciples was indisputably right, and that any method which contradicted it must therefore be wrong. Moreover, he appears to have regarded the sternal structure as a mere function of the Bird's habit, especially in regard to its power of flight, and to have wholly overlooked the converse position, that this power of flight must depend entirely on the structure. Good descriptive anatomist as he certainly was, he was false to the anatomist's creed; but it is plain, from reading his careful descriptions of sternums, that he could not grasp the essential characters he had before him, and, attracted only by the more salient and obvious features, had not capacity to interpret the meaning of the whole. Yet he did not cease by giving many figures of sternums hitherto unrepresented. We pass from him to a more lively theme.

At the very beginning of the year 1832 Cuvier laid before the Academy of Sciences of Paris a memoir on the progress of ossification in the sternum of Birds, of which memoir an abstract will be found in the *Annales des Sciences Naturelles* (xxv. pp. 260-272). Herein he treated of several subjects with which we are not particularly concerned at present, and his remarks throughout were chiefly directed against certain theories which Étienne Geoffroy St-Hilaire had propounded in his *Philosophie Anatomique*, published a good many years before, and need not trouble us here; but what does signify to us now is that Cuvier traced in detail, illustrating his statements by the preparations he exhibited, the progress of ossification in the sternum of the Fowl and of the Duck, pointing out how it differed in each, and giving his interpretation of the differences. It had hitherto been generally believed that the mode of ossification in the Fowl was that which obtained in all Birds—the Ostrich and its allies (as L'Herminier, we have seen, had already shewn) excepted. But it was now made to appear that the Struthious Birds in this respect resembled, not only the Duck, but a great many other groups—Waders, Birds-of-Prey, Pigeons, Passerines, and perhaps all Birds not Gallinaceous,—so that, according to Cuvier's view, the five points of ossification observed in the *Gallina*, instead of exhibiting the normal process, exhibited one quite exceptional, and that in all other Birds, so far as he had been enabled to investigate the matter, ossification of the sternum began at two points only, situated near the anterior upper margin of the side of the sternum, and gradually crept towards the keel, into which it presently extended; and, though he allowed the appearance of detached portions of calcareous matter at the base of the still cartilaginous keel in Ducks at a certain age, he seemed to consider this an individual peculiarity. This fact was fastened upon by Geoffroy in his reply, which was a week later presented to the Academy, but was not published in full until the following year, when it appeared in the *Annales du Muséum* (ser. 3, ii. pp. 1-22). Geoffroy here maintained that the five centres of ossification existed in the Duck just as in the Fowl, and that the real difference of the process lay in the period at which they made their appearance, a circumstance, which, though virtually proved by the preparations Cuvier had used, had been by him overlooked or misinterpreted. The Fowl possesses all five ossifications at birth, and for a long while the middle piece forming the keel is by far the largest. They all grow slowly, and it is not until the animal is about six months old that they are united into one firm bone. The Duck on the other hand, when newly hatched, and for nearly a month after, has the sternum wholly cartilaginous.

Then, it is true, two lateral points of ossification appear at the margin, but subsequently the remaining three are developed, and when once formed they grow with much greater rapidity than in the Fowl, so that by the time the young Duck is quite independent of its parents, and can shift for itself, the whole sternum is completely bony. Nor, argued Geoffroy, was it true to say, as Cuvier had said, that the like occurred in the Pigeons and true Passerines. In their case the sternum begins to ossify from three very distinct points—one of which is the centre of ossification of the keel. As regards the Struthious Birds, they could not be likened to the Duck, for in them at no age was there any indication of a single median centre of ossification, as Geoffroy had satisfied himself by his own observations made in Egypt many years before. Cuvier seems to have acquiesced in the corrections of his views made by Geoffroy, and attempted no rejoinder; but the attentive and impartial student of the discussion will see that a good deal was really wanting to make the latter's reply effective, though, as events have shewn, the former was hasty in the conclusions at which he arrived, having trusted too much to the first appearance of centres of ossification, for, had his observations in regard to other Birds been carried on with the same attention to detail as in regard to the Fowl, he would certainly have reached some very different results.

In 1834 GLOGER brought out at Breslau the first (and unfortunately the only) part of a *Vollständiges Handbuch der Naturgeschichte der Vögel Europas*, treating of the Land-birds. In the Introduction to this book (p. xxxviii, note) he expressed his regret at not being able to use as fully as he could wish the excellent researches of Nitzsch which were then appearing (as has been above said) in the successive parts of Naumann's great work. Notwithstanding this, to Gloger seems to belong the credit of being the first author to avail himself in a book intended for practical ornithologists of the new light that had already been shed on Systematic Ornithology; and accordingly we have the second Order of his arrangement, the *Aves Passerines*, divided into two Suborders:—Singing Passerines (*melodiosus*), and Passerines without an apparatus of Song-muscles (*anomalous*)—the latter including what some later writers called *Picariæ*. For the rest his classification demands no particular remark; but that in a work of this kind he had the courage to recognize, for instance, such a fact as the essential difference between Swallows and Swifts lifts him considerably above the crowd of other ornithological writers of his time.

An improvement on the old method of classification by purely external characters was introduced to the Academy of Sciences of Stockholm by SUNDEVALL in 1838, and was published the following year in its *Handlingar* (pp. 43-180). This was the foundation of a more extensive work of which, from the influence it still exerts, it will be necessary to treat later at some length, and there will be no need now to enter much into details respecting the earlier performance. It is sufficient here to remark that the author, even then a man of great erudition, must have been aware of the turn which taxonomy was taking; but, not being able to divest himself of the older notion that external characters were superior to those furnished by the study of internal structure, and that Comparative Anatomy, instead of being a part of Zoology, was something distinct from it, he seems to have endeavoured to form a scheme which, while not running wholly counter to the teachings of Comparative Anatomists, should yet rest ostensibly on external characters. With this view he studied the latter most laboriously, and in some measure certainly not without success, for he brought into prominence several points that had hitherto escaped the notice of his predecessors. He also admitted among his characteristics a physiological consideration (apparently derived from Oken<sup>1</sup>) dividing the class *Aves* into two sections *Altrices* and *Præcoce*, according as the young were fed by their parents or, from the first, fed themselves. But at this time he was encumbered with the hazy doctrines of analogies, which, if it did not act to his detriment, was assuredly of no service to him. He prefixed an "Idea Systematis" to his "Expositio"; and the former, which appears to represent his real opinion, differs in arrangement very considerably from the latter. Like Gloger, Sundevall in his ideal system separated the true Passerines from all other Birds, calling them *Volucres*; but he took a step further, for he assigned to them the highest rank, wherein

<sup>1</sup> He says from Oken's *Naturgeschichte für Schulen*, published in 1821, but the division is to be found in that author's earlier *Lehrbuch der Zoologie* (ii. p. 871), which appeared in 1816.



nearly every recent authority agrees with him; out of them, however, he chose the Thrushes and Warblers to stand first as his ideal "Centrum"—a selection which, though in the opinion of the present writer erroneous, is still largely followed.

The points at issue between Cuvier and Étienne Geoffroy St-Hilaire before mentioned naturally attracted the attention of L'HERMINIER, who in 1836 presented to the French Academy the results of his researches into the mode of growth of that bone which in the adult Bird he had already studied to such good purpose. Unfortunately the full account of his diligent investigations was never published. We can best judge of his labours from an abstract printed in the *Comptes Rendus* (iii. pp. 12-20) and reprinted in the *Annales des Sciences Naturelles* (ser. 2, vi. pp. 107-115), and from the report upon them by ISIDORE GEOFFROY ST-HILAIRE, to whom with others they were referred. This report is contained in the *Comptes Rendus* for the following year (iv. pp. 565-574), and is very critical in its character. It were useless to conjecture why the whole memoir never appeared, as the reporter recommended that it should; but, whether, as he suggested, the author's observations failed to establish the theories he advanced or not, the loss of his observations in an extended form is greatly to be regretted, for no one seems to have continued the investigations he began and to some extent carried out; while, from his residence in Guadeloupe, he had peculiar advantages in studying certain types of Birds not generally available, his remarks on them could not fail to be valuable, quite irrespective of the interpretation he was led to put upon them. L'Herminier arrived at the conclusion that, so far from there being only two or three different modes by which the process of ossification in the sternum is carried out, the number of different modes is very considerable—almost each natural group of Birds having its own. The principal theory which he hence conceived himself justified in propounding was that instead of five being (as had been stated) the maximum number of centres of ossification in the sternum, there are no fewer than nine entering into the composition of the perfect sternum of Birds in general, though in every species some of these nine are wanting, whatever be the condition of development at the time of examination. These nine theoretical centres or "pieces" L'Herminier deemed to be disposed in three transverse series (*rangées*), namely the anterior or "prosternal," the middle or "mesosternal," and the posterior or "metasternal"—each series consisting of three portions, one median piece and two side-pieces. At the same time he seems, according to the abstract of his memoir, to have made the somewhat contradictory assertion that sometimes there are more than three pieces in each series, and in certain groups of Birds as many as six.<sup>1</sup> It would occupy more space than can here be allowed to give even the briefest abstract of the numerous observations which follow the statement of his theory and on which it professedly rests. They extend to more than a score of natural groups of Birds, and nearly each of them presents some peculiar characters. Thus of the first series of pieces he says that when all exist they may be developed simultaneously, or that the two side-pieces may precede the median, or again that the median may precede the side-pieces—according to the group of Birds, but that the second mode is much the commonest. The same variations are observable in the second or middle series, but its side-pieces are said to exist in all groups of Birds without exception. As to the third or posterior series, when it is complete the three constituent pieces are developed almost simultaneously;

but its median piece is said often to originate in two, which soon unite, especially when the side-pieces are wanting. By way of examples of L'Herminier's observations, what he says of the two groups that had been the subject of Cuvier's and the elder Geoffroy's contest may be mentioned. In the *Gallinae* the five well-known pieces or centres of ossification are said to consist of the two side-pieces of the second or middle series, and the three of the posterior. On two occasions, however, there was found in addition, what may be taken for a representation of the first series, a little "noyau" situated between the coracoids—forming the only instance of all three series being present in the same Bird. As regards the Ducks, L'Herminier agreed with Cuvier that there are commonly only two centres of ossification—the side-pieces of the middle series; but as these grow to meet one another a distinct median "noyau," also of the same series, sometimes appears, which soon forms a connexion with each of them. In the Ostrich and its allies no trace of this median centre of ossification ever occurs; but with these exceptions its existence is invariable in all other Birds. Here the matter must be left; but it is undoubtedly a subject which demands further investigation, and naturally any future investigator of it should consult the abstract of L'Herminier's memoir and the criticisms upon it of the younger Geoffroy.

Hitherto it will have been seen that our present business has lain wholly in Germany and France, for, as is elsewhere explained, the chief ornithologists of Britain were occupying themselves at this time in a very useless way—not but that there were several distinguished men in this country who were paying due heed at this time to the internal structure of Birds, and some excellent descriptive memoirs on special forms had appeared from their pens, to say nothing of more than one general treatise on ornithic anatomy.<sup>2</sup> Yet no one in Britain seems to have attempted to found any scientific arrangement of Birds on other than external characters until, in 1837, WILLIAM MACGILLIVRAY issued the first volume of his *History of British Birds*, wherein, though professing (p. 19) "not to add a new system to the many already in partial use, or that have passed away like their authors," he propounded (pp. 16-18) a scheme for classifying the Birds of Europe at least founded on a "consideration of the digestive organs, which merit special attention, on account, not so much of their great importance in the economy of birds, as the nervous, vascular, and other systems are not behind them in this respect; but because, exhibiting great diversity of form and structure, in accordance with the nature of the food, they are more obviously qualified to afford a basis for the classification of the numerous species of birds" (p. 52). Experience has again and again exposed the fallacy of this last conclusion, but it is no disparagement of its author, writing nearly fifty years ago, to say that in this passage, as well as in others that might be quoted, he was greater as an anatomist than as a logician.

<sup>1</sup> We shall perhaps be justified in assuming that this apparent inconsistency, and others which present themselves, would be explicable if the whole memoir with the necessary illustrations had been published.

<sup>2</sup> Sir Richard Owen's celebrated article "Aves," in Todd's *Cyclopaedia of Anatomy and Physiology* (l. pp. 265-358), appeared in 1836, and, as giving a general view of the structure of Birds, needs no praise here; but its object was not to establish a classification, or throw light especially on systematic arrangement. So far from that being the case, its distinguished author was content to adopt, as he tells us, the arrangement proposed by Kirby in the *Seventh Bridgewater Treatise* (ll. pp. 445-474), being that, it is true, of an estimable zoologist, but of one who had no special knowledge of Ornithology. Indeed it is, as the latter says, that of Linnaeus, improved by Cuvier, with an additional modification of Illiger's—all these three authors having totally ignored any but external characters. Yet it was regarded "as being the one which facilitates the expression of the leading anatomical differences which obtain in the class of Birds, and which therefore may be considered as the most natural."

He was indeed thoroughly grounded in anatomy,<sup>1</sup> and though undoubtedly the digestive organs of Birds have a claim to the fullest consideration, yet Macgillivray himself subsequently became aware of the fact that there were several other parts of their structure as important from the point of view of classification. He it was, apparently, who first detected the essential difference of the organs of voice resented by some of the New-World Passerines (subsequently known as *Clamatores*), and the earliest intimation of this seems to be given in his anatomical description of the Arkansas Flycatcher, *Tyrannus verticalis*, which was published in 1838 (*Ornithol. Biography*, iv. p. 425), though it must be admitted that he did not—because he then could not—perceive the bearing of their difference, which was reserved to be shown by the investigation of a still greater anatomist, and of one who had fuller facilities for research, and thereby almost revolutionized, as will presently be mentioned, the views of systematists as to this Order of Birds. There is only space here to say that the second volume of Macgillivray's work was published in 1839, and the third in 1840; but it was not until 1852 that the author, in broken health, found an opportunity of issuing the fourth and fifth. His scheme of classification, being as before stated partial, need not be given in detail. Its great merit is that it proved the necessity of combining another and hitherto much-neglected factor in any natural arrangement, though vitiated as so many other schemes have been by being based wholly on one class of characters.

But a bolder attempt at classification was that made in 1838 by BLYTH in the New Series (Mr Charlesworth's) of the *Magazine of Natural History* (ii. pp. 256–268, 314–319, 351–361, 420–426, 589–601; iii. pp. 76–84). It was limited, however, to what he called *Insectores*, being the group upon which that name had been conferred by Vigors (*Trans. Linn. Society*, xiv. p. 405) in 1823 (see above, p. 15), with the addition, however, of his *Raptors*, and it will be unnecessary to enter into particulars concerning it, though it is as equally remarkable for the insight shown by the author into the structure of Birds as for the philosophical breadth of his view, which comprehends almost every kind of character that had been at that time brought forward. It is plain that Blyth saw, and perhaps he was the first to see it, that Geographical Distribution was not unimportant in suggesting the affinities and differences of natural groups (pp. 258, 259); and, undeterred by the precepts and practice of the hitherto dominant English school of Ornithologists, he declared that "anatomy, when aided by every character which the manner of propagation, the progressive changes, and other physiological data supply, is the only sure basis of classification." He was quite aware of the taxonomic value of the vocal organs of some groups of Birds, presently to be especially mentioned, and he had himself ascertained the presence and absence of *cæca* in a not inconsiderable number of groups, drawing thence very justifiable inferences. He knew at least the earlier investigations of

L'Hermnier, and, though the work of Nitzsch, even if he had ever heard of it, must (through ignorance of the language in which it was written) have been to him a sealed book, he had followed out and extended the hints already given by Temminck as to the differences which various groups of Birds display in their moult. With all this it is not surprising to find, though the fact has been generally overlooked, that Blyth's proposed arrangement in many points anticipated conclusions that were subsequently reached, and were then regarded as fresh discoveries. It is proper to add that at this time the greater part of his work was carried on in conjunction with Mr BARTLETT, the present Superintendent of the Zoological Society's Gardens, and that, without his assistance, Blyth's opportunities, slender as they were compared with those which others have enjoyed, must have been still smaller. Considering the extent of their materials, which was limited to the bodies of such animals as they could obtain from dealers and the several menageries that then existed in or near London, the progress made in what has since proved to be the right direction is very wonderful. It is obvious that both these investigators had the genius for recognising and interpreting the value of characters; but their labours do not seem to have met with much encouragement; and a general arrangement of the Class laid by Blyth before the Zoological Society at this time<sup>2</sup> does not appear in its publications, possibly through his neglect to reduce his scheme to writing and deliver it within the prescribed period. But even if this were not the case, no one need be surprised at the result. The scheme could hardly fail to be a crude performance—a fact which nobody would know better than its author; but it must have presented much that was objectionable to the opinions then generally prevalent. Its line to some extent may be partly made out—very clearly, for the matter of that, so far as its details have been published in the series of papers to which reference has been given—and some traces of its features are probably preserved in his *Catalogue* of the specimens of Birds in the Museum of the Asiatic Society of Bengal, which, after several years of severe labour, made its appearance at Calcutta in 1849; but, from the time of his arrival in India, the onerous duties imposed upon Blyth, together with the want of sufficient books of reference, seem to have hindered him from seriously continuing his former researches, which, interrupted as they were, and born out of due time, had no appreciable effect on the views of systematizers generally.

Next must be noticed a series of short treatises communicated by JOHANN FRIEDRICH BRANDT, between the years 1836 and 1839, to the Academy of Sciences of St Petersburg, and published in its *Mémoires*. In the year last mentioned the greater part of these was separately issued under the title of *Beiträge zur Kenntnis der Naturgeschichte der Vögel*. Herein the author first assigned anatomical reasons for rearranging the Order *Anseres* of Linnæus and *Natales* of Illiger, who, so long before as 1811, had proposed a new distribution of it into six Families, the definitions of which, as was his wont, he had drawn from external characters only. Brandt now retained very nearly the same arrangement as his predecessor; but, notwithstanding that he could trust to the firmer foundation of internal framework, he took at least two retrograde steps. First he failed to see the great structural difference between the Penguins (which Illiger had placed as a group, *Impennes*, of equal rank to his other Families) and the Auks, Divers, and Grebes, *Pygopodes*—combining all of them to form a "Typus" (to use his term) *Urinatores*; and secondly he admitted among the *Natales*, though as a distinct "Typus" *Podoides*, the genera *Podas* and *Puffins*, which are now known to belong to the *Balliæ*—the latter indeed (see COOT, vol. vi. p. 341) being but very slightly removed from the MOOR-HEW (vol. xvi. p. 808). At the same time he corrected the error made by Illiger in associating the PHALAROPES (g.c.) with these forms, rightly declaring their

<sup>2</sup> An abstract is contained in the Minute-book of the Scientific Meetings of the Zoological Society, 26th June and 10th July 1836. The Class was to contain fifteen Orders, but only three were dealt with in any detail.

<sup>1</sup> This is not the place to expatiate on Macgillivray's merits; but the writer may perhaps be excused for here uttering the opinion that, after Willughby, Macgillivray was the greatest and most original ornithological genius save one (who did not live long enough to make his powers widely known) that this island has produced. The exact amount of assistance he afforded to Audubon in his *Ornithological Biography* will probably never be ascertained; but, setting aside "all the anatomical descriptions, as well as the sketches by which they are sometimes illustrated," that on the latter's own statement (*op. cit.*, iv., Introduction, p. xxiii) are the work of Macgillivray, no impartial reader can compare the style in which the *History of British Birds* is written with that of the *Ornithological Biography* without recognising the similarity of the two. On this subject some remarks of Prof. COOPER (*Bull. West. Ornithol. Club*, 1889, p. 301) may well be submitted.

relationship to *Tringa* (see SANDPIPER), a point of order which other systematists were long in admitting. On the whole Brandt's labours were of no small service in asserting the principle that consideration must be paid to osteology; for his position was such as to gain more attention to his views than some of his less favourably placed brethren had succeeded in doing.

In the same year (1839) another slight advance was made in the classification of the true Passerines. KEYSERLING and BLASIUS briefly pointed out in the *Archiv für Naturgeschichte* (v. pp. 332-334) that, while all the other Birds provided with perfect song-muscles had the "plants" or hind part of the "tarsus" covered with two long and undivided horny plates, the LARKS (vol. xiv. p. 316) had this part divided by many transverse sutures, so as to be scutellated behind as well as in front; just as is the case in many of the Passerines which have not the singing-apparatus, and also in the HOOPONS (vol. xii. p. 154). The importance of this singular but superficial departure from the normal structure has been so needlessly exaggerated as a character that at the present time its value is apt to be unduly depreciated. In so large and so homogeneous a group as that of the true Passerines, a constant character of this kind is not to be despised as a practical mode of separating the Birds which possess it; and, more than this, it would appear that the discovery thus announced was the immediate means of leading to a series of investigations of a much more important and lasting nature—those of Johannes Müller to be presently mentioned.

Again we must recur to that indefatigable and most original investigator NITZSCH, who, having never intermitted his study of the particular subject of his first contribution to science, long ago noticed, in 1833 brought out at Halle, where he was Professor of Zoology, an essay with the title *Pterylographis Avium Pars prior*. It seems that this was issued as much with the object of inviting assistance from others in view of future labours, since the materials at his disposal were comparatively scanty, as with that of making known the results to which his researches had already led him. Indeed he only communicated copies of this essay to a few friends, and examples of it are comparatively scarce. Moreover, he stated subsequently that he thereby hoped to excite other naturalists to share with him the investigations he was making on a subject which had hitherto escaped notice or had been wholly neglected, since he considered that he had proved the disposition of the feathered tracts in the plumage of Birds to be the means of furnishing characters for the discrimination of the various natural groups as significant and important as they were new and unexpected.<sup>1</sup> There was no need for us here to quote this essay in its chronological place, since it dealt only with the generalities of the subject, and did not enter upon any systematic details. These the author reserved for a second treatise which he was destined never to complete. He kept on diligently collecting materials, and as he did so

<sup>1</sup> It is still a prevalent belief among nearly all persons but well-informed ornithologists, that feathers grow almost uniformly over the whole surface of a Bird's body; some indeed are longer and some are shorter, but that is about all the difference perceptible to most people. It is the easiest thing for anybody to satisfy himself that this, except in a few cases, is altogether an erroneous supposition. In all but a small number of forms the feathers are produced in very definite clumps or tracts, called by Nitzsch *pteryla* (*σπάρον, penne, 날, plume*), a rather fanciful term it is true, but one to which no objection can be taken. Between these *pteryla* are spaces bare of feathers, which he named *apteria*. Before Nitzsch's time the only men who seem to have noticed this fact were the great John Hunter and the accurate Macartney. But the observations of the former on the subject were not given to the world until 1836, when Sir R. Owen introduced them into his *Catalogue of the Museum of the College of Surgeons in London* (vol. iii. pt. ii. p. 311), and therein is no indication of the fact having a taxonomical bearing. The same may be said of Macartney's remarks, which, though subsequent in point of time, were published earlier, namely, in 1819 (Roes's *Cyclopaedia*, xiv., art. "Feathers"). Ignorance of this simple fact has led astray many celebrated painters, among them Sir Edwin Landseer, whose pictures of Birds nearly always shew an unnatural representation of the plumage that at once betrays itself to the trained eye, though of course it is not perceived by spectators generally, who regard only the correctness of attitude and force of expression, which in that artist's work commonly leave little to be desired. Every draughtsman of Birds to be successful should study the plan on which their feathers are disposed.

was constrained to modify some of the statements he had published. He consequently fell into a state of doubt, and before he could make up his mind on some questions which he deemed important he was overtaken by death.<sup>2</sup> Then his papers were handed over to his friend and successor Prof. BURMEISTER, now and for many years past of Buenos Aires, who, with much skill elaborated from them the excellent work known as Nitzsch's *Pterylographie*, which was published at Halle in 1840. There can be no doubt that Prof. Burmeister (fortunately yet spared to us) discharged his editorial duty with the most conscientious scrupulosity; but, from what has been just said, it is certain that there were important points on which Nitzsch was as yet undecided—some of them perhaps of which no trace appeared in his manuscripts, and therefore as in every case of works posthumously published, unless (as rarely happens) they have received their author's "imprimatur," they cannot be implicitly trusted as the expression of his final views. It would consequently be unsafe to ascribe positively all that appears in this volume to the result of Nitzsch's mature consideration. Moreover, as Prof. Burmeister states in his preface, Nitzsch by no means regarded the natural sequence of groups as the highest problem of the systematist, but rather their correct limitation. Again the arrangement followed in the *Pterylographie* was of course based on pterylographical considerations, and we have its author's own word for it that he was persuaded that the limitation of natural groups could only be attained by the most assiduous research into the species of which they are composed from every point of view. The combination of these three facts will of itself explain some defects, or even retrogressions, observable in Nitzsch's later systematic work when compared with that which he had formerly done. On the other hand some manifest improvements are introduced, and the abundance of details into which he enters in his *Pterylographie* render it far more instructive and valuable than the older performance. As an abstract of that has already been given, it may be sufficient here to point out the chief changes made in his newer arrangement. To begin with, the three great sections of Aerial, Terrestrial, and Aquatic Birds are abolished. The "*Accipitres*" are divided into two groups, Diurnal and Nocturnal; but the first of these divisions is separated into three sections:—(1) the Vultures of the New World, (2) those of the Old World, and (3) the genus *Falco* of Linnaeus. The "*Passerinae*," that is to say, the true *Passeres*, are split into eight families, not wholly with judgment;<sup>3</sup> but of their taxonomy more is to be said presently. Then a new Order "*Picariae*" is instituted for the reception of the *Macrochires*, *Cuculinae*, *Picinae*, *Pittacinae*, and *Amphibola* of his old arrangement, to which are added three<sup>4</sup> others—*Caprimulginae*, *Todidae*, and *Lipoglossae*—the last consisting of the genera *Buccros*, *Upupa*, and *Alcedo*. The association of *Alcedo* with the

<sup>2</sup> Though not relating exactly to our present theme, it would be improper to dismiss Nitzsch's name without reference to his extraordinary labours in investigating the insect and other external parasites of Birds, a subject which as regards British species was subsequently elaborated by DENNY in his *Monographia Anophororum Britannicorum* (1842) and in his list of the specimens of British *Anophora* in the collection of the British Museum.

<sup>3</sup> A short essay by Nitzsch on the general structure of the Passerines, written, it is said, in 1836, was published in 1862 (*Zeitschr. Ges. Naturwissenschaft*, xix. pp. 389-408). It is probably to this essay that Prof. Burmeister refers in the *Pterylographie* (p. 102, note; English translation, p. 72, note) as forming the basis of the article "*Passerinae*" which he contributed to Ersch and Gruber's *Encyclopaedia* (sect. iii. bd. xiii. pp. 139-144), and published before the *Pterylographie*.

<sup>4</sup> By the numbers prefixed it would look as if there should be four new members of this Order; but that seems to be due rather to a slip of the pen or to a printer's error.

other two is no doubt a misplacement, but the alliance of *Buccones* to *Upupa*, already suggested by Gould and Blyth in 1833<sup>1</sup> (*Mag. Nat. History*, ser. 2, ii. pp. 422 and 589), though apparently unnatural, has been corroborated by many later systematizers; and taken as a whole the establishment of the *Picariæ* was certainly a commendable proceeding. For the rest there is only one considerable change, and that forms the greatest blot on the whole scheme. Instead of recognizing, as before, a Subclass in the *Ratiæ* of Merrem, Nitzsch now reduced them to the rank of an Order under the name "*Platystrææ*," placing them between the "*Gallinacæ*" and "*Grallæ*," though admitting that in their pterylosis they differ from all other Birds, in ways that he is at great pains to describe, in each of the four genera examined by him—*Struthio*, *Rhea*, *Dromæus*, and *Casuarina*.<sup>2</sup> It is significant that notwithstanding this he did not figure the pterylosis of any one of them, and the thought suggests itself that, though his editor assures us he had convinced himself that the group must be here shoved in (*eingeschoben* is the word used), the intrusion is rather due to the necessity which Nitzsch, in common with most men of his time (the Quinarians excepted), felt for deploying the whole series of Birds into line, in which case the proceeding may be defensible on the score of convenience. The extraordinary merits of this book, and the admirable fidelity to his principles which Prof. Burmeister shewed in the difficult task of editing it, were unfortunately overlooked for many years, and perhaps are not sufficiently recognized now. Even in Germany, the author's own country, there were few to notice seriously what is certainly one of the most remarkable works ever published on the science, much less to pursue the investigations that had been so laboriously begun.<sup>3</sup> Andreas Wagner, in his report on the progress of Ornithology, as might be expected from such a man as he was, placed the *Pterylographie* at the summit of those publications the appearance of which he had to record for the years 1839 and 1840, stating that for "Systematik" it was of the greatest importance.<sup>4</sup> On the other hand Oken (*Isis*, 1842, pp. 391-394), though giving a summary of Nitzsch's results and classification, was more sparing of his praise, and prefaced his remarks by asserting that he could not refrain from laughter when he looked at the plates in Nitzsch's work, since they reminded him of the plucked fowls hanging in a poulterer's shop—it might as well be urged as an objection to the plates in many an anatomical book that they called to mind a butcher's—and goes on to say that, as the author always had the luck to engage in researches of which nobody thought, so had he the luck to print them where nobody sought them. In Sweden

<sup>1</sup> This association is one of the most remarkable in the whole series of Blyth's remarkable papers on classification in the volume cited above. He states that Gould suspected the alliance of these two forms "from external structure and habits alone;" otherwise one might suppose that he had obtained an intimation to that effect on one of his Continental journeys. Blyth "arrived at the same conclusion, however, by a different train of investigation," and this is beyond doubt.

<sup>2</sup> He does not mention *Apteryx*, at that time so little known on the Continent.

<sup>3</sup> Some excuse is to be made for this neglect. Nitzsch had of course exhausted all the forms of Birds commonly to be obtained, and specimens of the less common forms were too valuable from the curator's or collector's point of view to be subjected to a treatment that might end in their destruction. Yet it is said, on good authority, that Nitzsch had the patience so to manipulate the skins of many rare species that he was able to ascertain the characters of their pterylosis by the inspection of their inside only, without in any way damaging them for the ordinary purpose of a museum. Nor is this surprising when we consider the marvellous skill of Continental and especially German taxidermists, many of whom have elevated their profession to a height of art inaccessible to most Englishmen, who are only acquainted with the miserable mockery of Nature which is the most sublime result of all but a few "bird-stuffers."

<sup>4</sup> *Archiv für Naturgeschichte*, vii. 2, pp. 60, 61.

Sundevall, without accepting Nitzsch's views, accorded them a far more appreciative greeting in his annual reports for 1840-42 (i. pp. 152-160); but of course in England and France<sup>5</sup> nothing was known of them beyond the scantiest notice, generally taken at second hand, in two or three publications. Thanks to Mr. Sclater, the Ray Society was induced to publish, in 1867, an excellent translation by Mr. Dalas of Nitzsch's *Pterylography*, and thereby, however tardily, justice was at length rendered by British ornithologists to one of their greatest foreign brethren.<sup>6</sup>

The treatise of KISSLEK on the osteology of Birds' feet, published in the *Bulletin* of the Moscow Society of Naturalists for 1841, next claims a few words, though its scope is rather to shew differences than affinities; but treatment of that kind is undoubtedly useful at times in indicating that alliances generally admitted are unnatural; and this is the case here, for, following Cuvier's method, the author's researches prove the artificial character of some of its associations. While furnishing—almost unconsciously, however—additional evidence for overthrowing that classification, there is, nevertheless, no attempt made to construct a better one; and the elaborate tables of dimensions, both absolute and proportional, suggestive as is the whole tendency of the author's observations, seem not to lead to any very practical result, though the systematist's need to look beneath the integument, even in parts that are so comparatively little hidden as Birds' feet, is once more made beyond all question apparent.

It has already been mentioned that MACGILLIVRAY contributed to Audubon's *Ornithological Biography* a series of descriptions of some parts of the anatomy of American Birds, from subjects supplied to him by that enthusiastic naturalist, whose zeal and prescience, it may be called, in this respect merits all praise. Thus he (prompted very likely by Macgillivray) wrote:—"I believe the time to be approaching when much of the results obtained from the inspection of the exterior alone will be laid aside; when museums filled with stuffed skins will be considered insufficient to afford a knowledge of birds; and when the student will go forth, not only to observe the habits and haunts of animals, but to preserve specimens of them to be carefully dissected" (*Ornith. Biography*, iv., Introduction, p. xxiv). As has been stated, the first of this series of anatomical descriptions appeared in the fourth volume of his work, published in 1838, but they were continued until its completion with the fifth volume in the following year, and the whole was incorporated into what may be termed its second edition, *The Birds of America*, which appeared between 1840 and 1844 (see p. 11). Among the many species whose anatomy Macgillivray thus partly described from autopsy were at least half a dozen<sup>7</sup> of those now referred to the Family *Tyrannidæ* (see KING-BIRD, vol. xiv. p. 80), but then included, with many others, according to the irrational, vague, and rudimentary notions of classification of the time, in what was termed the Family "*Muscicapinæ*." In all these species he found the vocal organs to differ essentially in structure from those of other Birds of the Old World, which we now call Passerine, or, to be still more precise, Oscinian. But by him these last were most arbitrarily severed, dissociated from their allies, and wrongly combined with other forms by no means nearly related to them (*Brit. Birds*, i. pp. 17, 18) which

<sup>5</sup> In 1836 JACQUEMIN communicated to the French Academy (*Comptes Rendus*, ii. pp. 374, 375, and 472) some observations on the order in which feathers are disposed on the body of Birds; but, however general may have been the scope of his investigations, the portion of them published refers only to the Crow, and there is no mention made of Nitzsch's former work.

<sup>6</sup> The Ray Society had the good fortune to obtain the ten original copper-plates, all but one drawn by the author himself, wherewith the work was illustrated. It is only to be regretted that the Society did not also stick to the quarto size in which it appeared, for by issuing their English version in folio they unnecessarily put an impediment in the way of its common and convenient use.

<sup>7</sup> These are, according to modern nomenclature, *Tyrannus carolinensis* and (as before mentioned) *T. verticalis*, *Myiarchus cinerascens*, *Sayornis fuscus*, *Contopus virens*, and *Empidonax auduboni*.

he also examined; and he practically, though not literally,<sup>1</sup> asserted the truth, when he said that the general structure, but especially the muscular appendages, of the lower larynx was "similarly formed in all other birds of this family" described in Audubon's work. Macgillivray did not, however, assign to this essential difference any systematic value. Indeed he was so much prepossessed in favour of a classification based on the structure of the digestive organs that he could not bring himself to consider vocal muscles to be of much taxonomic use, and it was reserved to JOHANNES MÜLLER to point out that the contrary was the fact. This the great German comparative anatomist did in two communications to the Academy of Sciences of Berlin, one on the 26th June 1845 and the other on the 14th May 1846, which, having been first briefly published in the Academy's *Monatsbericht*, were afterwards printed in full, and illustrated by numerous figures, in its *Abhandlungen*, though in this latter and complete form they did not appear in public until 1847. This very remarkable treatise forms the groundwork of almost all later or recent researches in the comparative anatomy and consequent arrangement of the *Passeres*, and, though it is certainly not free from imperfections, many of them, it must be said, arise from want of material, notwithstanding that its author had command of a much more abundant supply than was at the disposal of Nitzsch. Carrying on the work from the anatomical point at which he had left it, correcting his errors, and utilizing to the fullest extent the observations of Keyserling and Blasius, to which reference has already been made, Müller, though hampered by mistaken notions of which he seems to have been unable to rid himself, propounded a scheme for the classification of this group, the general truth of which has been admitted by all his successors, based, as the title of his treatise expressed, on the hitherto unknown different types of the vocal organs in the *Passerines*. He freely recognized the prior discoveries of, as he thought, Audubon, though really, as has since been ascertained, of Macgillivray; but Müller was able to perceive their systematic value, which Macgillivray did not, and taught others to know it. At the same time Müller shewed himself, his power of discrimination notwithstanding, to fall behind Nitzsch in one very crucial point, for he refused to the latter's *Picariis* the rank that had been claimed for them, and imagined that the groups associated under that name formed but a third "Tribe"—*Picariis*—of a great Order *Insectores*, the others being (1) the *Oscines* or *Polymyodi*—the Singing Birds by emphasis, whose inferior larynx was endowed with the full number of five pairs of song-muscles, and (2) the *Tracheophones*, composed of some South-American Families. Looking on Müller's labours as we now can, we see that such errors as he committed are chiefly due to his want of special knowledge of Ornithology: combined with the absence in several instances of sufficient materials for investigation. Nothing whatever is to be said against the composition of his first and second "Tribes"; but the third is an assemblage still more heterogeneous than that which Nitzsch brought together under a name so like that of Müller—for the fact must never be allowed to go out of sight that the extent of the *Picariis* of the latter is not at all that of the *Picariis* of the former.<sup>2</sup> For instance, Müller places in his

third "Tribe" the group which he called *Ampetidae*, meaning thereby the peculiar forms of South America that are now considered to be more properly named *Cotingidae*, and herein he was clearly right, while Nitzsch, who (misled by their supposed affinity to the genus *Ampelis*—peculiar to the Northern Hemisphere, and a purely *Passerine* form) had kept them among his *Passerines*, was as clearly wrong. But again Müller made his third "Tribe" *Picariis* also to contain the *Tyrannidae*, of which mention has just been made, though it is so obvious as now to be generally admitted that they have no very intimate relationship to the other Families with which they are there associated. There is no need here to criticize more minutely his projected arrangement, and it must be said that, notwithstanding his researches, he seems to have had some misgivings that, after all, the separation of the *Insectores* into those "Tribes" might not be justifiable. At any rate he wavered in his estimate of their taxonomic value, for he gave an alternative proposal, arranging all the genera in a single series, a proceeding in those days thought not only defensible and possible, but desirable or even requisite, though now utterly abandoned. Just as Nitzsch had laboured under the disadvantage of never having any example of the abnormal *Passeres* of the New World to dissect, and therefore was wholly ignorant of their abnormality, so Müller never succeeded in getting hold of an example of the genus *Pitta* for the same purpose, and yet, acting on the clew furnished by Keyserling and Blasius, he did not hesitate to predict that it would be found to fill one of the gaps he had to leave, and this to some extent it has been since proved to do.

The result of all this is that the *Oscines* or true *Passeres* are found to be a group in which the vocal organs not only attain the greatest perfection, but are nearly if not quite as uniform in their structure as is the eternal apparatus; while at the same time each set of characters is wholly unlike that which exists in any other group of Birds. In nearly all Birds the inferior larynx, or syrinx, which is, as proved long ago by the experiments of Cuvier, the seat of their vocal powers, is at the bottom of the trachea or windpipe, and is formed by the more or less firm union of several of the bony rings of which that tube is composed. In the *Rallus*, the genus *Rhea* excepted, and in one group of *Carinatae*, the American Vultures *Cathartidae*, but therein it is believed only, there is no special modification of the trachea into a syrinx;<sup>3</sup> but usually, at a little distance from the lungs, the trachea is somewhat enlarged, and here is found a thicker and stouter bony ring, which is bisected axially by a *septum* or partition extending from behind forwards, and thus dividing the pipe,<sup>4</sup> each half of which swells out below the ring and then rapidly contracts to enter the lung on its own side. The halves of the pipe thus formed are the *bronchi*, tubes whose inner side is flattened and composed of the *membrana tympaniformis*, on the change of form and length of which some of the varieties of intonation depend, while the outer and curved side is supported by bony half-hoops, connected by membrane just as are the entire hoops of the upper part of the trachea. The whole of this apparatus is extremely flexible, and is controlled by muscles, the real vocal muscles of which mention has previously been so frequently made. These vary in number in different groups of Birds, and reach their maximum in the *Oscines*, which have always five pairs, or even more according to some authorities.<sup>5</sup> But supposing five to be the number of pairs, as it is generally allowed to be in this group of them, two pairs have a common origin about the middle of the trachea, and, descending on its outside, divide at a short distance above the lower end of the tube; one of them, the *tensor posterior longus*, being directed downward and backward, is inserted at the extreme posterior end of the first half-ring of the bronchus, while its counterpart, the *tensor anterior longus*, passing from the place of separation downward and forward, is inserted below the extreme point of the last ring of the trachea. Within the angle formed by the divergence of each of these pairs of muscles, a third slender muscle—the *sterno-trachealis*—is given off

<sup>1</sup> Not literally, because a few other forms such as the genera *Polyptila* and *Ptilogenys*, now known to have no relation to the *Tyrannidae*, were included, though these forms, it would seem, had never been dissected by him. On the other hand he declares that the American Redstart, *Muscicapa*, or, as it now stands, *Salpadora ruticilla*, when young, has its vocal organs like the rest—an extraordinary statement which is worthy the attention of the many able American ornithologists.

<sup>2</sup> It is not needless to point out this fine distinction, for more than one modern author would seem to have overlooked it.

<sup>3</sup> See BIRDS, vol. III. p. 726; but cf. Forbes, *Proc. Zool. Society*, 1881, pp. 778, 788.

<sup>4</sup> In a few forms belonging to the *Spheniscidae* and *Procellariidae*, this *septum* is prolonged upwards, to what purpose is of course unknown. On the other hand, the Parrots have no *septum* (see BIRDS, *ut supra*).

<sup>5</sup> See BIRDS, vol. III. p. 726.

on each side and is attached to the sternum.<sup>1</sup> The fourth pair, the *tensores posteriores breves*, is the smallest of all, and, arising near the middle of the lower end of the trachea, has its fibres inserted on the extremity of the first of the incomplete rings of the bronchi. The fifth pair, the *tensores anteriores*, originates like the last from the middle of the trachea, but is somewhat larger and thicker, appearing as though made up of several small muscles in close contact, and by some ornithologists is believed to be of a composite nature. Its direction is obliquely downward and forward, and, attached by a broad base to the last ring of the trachea and cartilage immediately below, reaches the first or second of the half-rings of the bronchi—in the normal *Ocineas* at their extremity; but, in another section of that group, which it will be necessary to mention later, it is found to be attached to their middle. There is no question of its being by the action of the syringeal muscles just described that the expansion of the bronchi, both as to length and diameter, is controlled, and, as thereby the sounds uttered by the Bird are modified, they are properly called the Song-muscles.

It must not be supposed that the muscles just defined were first discovered by Müller; on the contrary they had been described long before, and by many writers on the anatomy of Birds. To say nothing of foreigners, or the authors of general works on the subject, an excellent account of them had been given to the Linnean Society by YARRELL in 1829, and published with elaborate figures in its *Transactions* (xvi. pp. 305-321, pls. 17, 18), an abstract of which was subsequently given in the article "Raven" in his *History of British Birds*, and Macgillivray also described and figured them with the greatest accuracy ten years later in his work with the same title (ii. pp. 21-37, pls. x-xii), while Blyth and Nitzsch had (as already mentioned) seen some of their value in classification. But Müller has the merit of clearly outstriking his predecessors, and with his accustomed perspicuity made the way even plainer for his successors to see than he himself was able to see it. What remains to add is that the extraordinary celebrity of its author actually procured for the first portion of his researches notice in England (*Ann. Nat. History*, xvii. p. 499), though it must be confessed not then to any practical purpose; but more than thirty years after there appeared an English translation of his treatise by Prof. Jeffrey Bell, with an appendix by Garrod containing a summary of the latter's own continuation of the same line of research, and thus once more Mr. Selator, for it was at his instigation that the work was undertaken, had the satisfaction of rendering proper tribute to one who by his investigations had so materially advanced the study of Ornithology.<sup>2</sup>

It is now necessary to revert to the year 1842, in which Dr CORNAY of Rochefort communicated to the French Academy of Sciences a memoir on a new Classification of Birds, of which, however, nothing but a notice has been preserved (*Comptes Rendus*, xiv. p. 184). Two years later this was followed by a second contribution from him on the same subject, and of this only an extract appeared in the official organ of the Academy (*ut supra*, xvi. pp. 94, 95), though an abstract was inserted in one scientific journal (*L'Institut*, xii. p. 21), and its first portion in another (*Journal des Connaissances*, i. p. 250). The *Revue Zoologique* for 1847 (pp. 360-369) contained the whole, and enabled naturalists to consider the merits of the author's project which was to found a new Classification of Birds on the form of the anterior palatal bones, which he declared to be subjected more evidently than any other to certain fixed laws. These laws, as formulated by him, are that (1) there is a coincidence of form of the anterior palatal and of the cranium in Birds of the same Order; (2) there is a likeness between the anterior palatal bones in Birds of the same Order; (3) there are relations of likeness between the anterior palatal bones in groups of Birds which are near to one another. These laws, he added, exist in regard to all

parts that offer characters fit for the methodical arrangement of Birds, but it is in regard to the anterior palatal bone that they unquestionably offer the most evidence. In the evolution of these laws Dr Cornay had most laudably studied, as his observations prove, a vast number of different types, and the upshot of his whole labours, though not very clearly stated, was such as to wholly subvert the classification at that time generally adopted by French ornithologists. He of course knew the investigations of L'Hermier and De Blainville on sternal formation, and he also seems to have been aware of some pterylogical differences exhibited by Birds—whether those of Nitzsch or those of Jacquemin is not stated. True it is the latter were never published in full, but it is quite conceivable that Dr Cornay may have known their drift. Be that as it may, he declares that characters drawn from the sternum or the pelvis—hitherto deemed to be, next to the bones of the head, the most important portions of the Bird's framework—are scarcely worth more, from a classificatory point of view, than characters drawn from the bill or the legs; while pterylogical considerations, together with many others to which some systematists had attached more or less importance, can only assist, and apparently must never be taken to control, the force of evidence furnished by this bone of all bones—the anterior palatal.

That Dr Cornay was on the brink of making a discovery of considerable merit will by and by appear; but, with every disposition to regard his investigations favourably, it cannot be said that he accomplished it. No account need be taken of the criticism which denominated his attempt "unphilosophical and one-sided," nor does it signify that his proposals either attracted no attention or were generally received with indifference. Such is commonly the fate of any deep-seated reform of classification proposed by a comparatively unknown man, unless it happen to possess some extraordinarily taking qualities, or be explained with an abundance of pictorial illustration. This was not the case here. Whatever proofs Dr Cornay may have had to satisfy himself of his being on the right track, these proofs were not adduced in sufficient number nor arranged with sufficient skill to persuade a somewhat stiff-necked generation of the truth of his views—for it was a generation whose leaders, in France at any rate, looked with suspicion upon any one who professed to go beyond the bounds which the genius of Cuvier had been unable to overpass, and regarded the notion of upsetting any of the positions maintained by him as verging almost upon profanity. Moreover, Dr Cornay's scheme was not given to the world with any of those adjuncts that not merely please the eye but are in many cases necessary, for, though on a subject which required for its proper comprehension a series of plates, it made even its final appearance unadorned by a single explanatory figure, and in a journal, respectable and well-known indeed, but one not of the highest scientific rank. Add to all this that its author, in his summary of the practical results of his investigations, committed a grave sin in the eyes of rigid systematists by ostentatiously arranging the names of the forty types which he selected to prove his case wholly without order, and without any intimation of the greater or less affinity any one of them might bear to the rest. That success should attend a scheme so inconclusively elaborated could not be expected.

The same year which saw the promulgation of the crude scheme just described, as well as the publication of the final researches of Müller, witnessed also another attempt at the classification of Birds, much more limited indeed in scope, but, so far as it went, regarded by most ornithologists of the time as almost final in its operation. Under the vague title of "Ornithologische Notizen" Prof. Cabanis of Berlin contributed to the *Archiv für Naturgeschichte* (xii. 1, pp. 186-256, 308-352) an essay in two parts, wherein, following the researches of Müller<sup>3</sup> on the syrinx, in the course of which a correlation had been shewn to exist between the whole or divided condition of the *planta* or hind part of the "tarsus," first noticed, as has been said, by Keyserling and Blasius, and the presence or absence of the perfect song-apparatus, the younger author found an agreement which seemed almost invariable in this respect, and he also pointed out that the *planta* of the different groups of Birds in which it is divided is divided in different modes, the mode of division being generally characteristic of the group. Such a coincidence of the internal and external features of Birds was naturally deemed a discovery of the greatest value by those ornithologists who thought most highly of the latter, and it was unquestionably of no little practical utility. Further examination also revealed the fact<sup>4</sup> that

<sup>1</sup> According to Blyth (*Mag. Nat. History*, ser. 2, ii. p. 264), Yarrell ascertained that this pair of muscles was wanting in "the same genus" (qu. *Gracula*), a statement that requires attention either for confirmation or contradiction.

<sup>2</sup> The title of the English translation is *Johannes Müller on Certain Variations in the Vocal Organs of the Passeres that have hitherto escaped notice*. It was published at Oxford in 1878. By some unaccountable accident, the date of the original communication to the Academy of Berlin is wrongly printed. It has been rightly given above.

<sup>3</sup> On the other hand, Müller makes several references to the labours of Prof. Cabanis. The investigations of both authors must have been proceeding simultaneously, and it matters little which actually appeared first.

<sup>4</sup> This seems to have been made known by Prof. Cabanis the preceding year to the *Gesellschaft der Naturforschender Freunde* (cf. Müller, *Stimmorgan der Passerinen*, p. 65). Of course the variation to which the number of primaries was subject had not escaped the observation of Nitzsch, but he had scarcely used it as a classificatory character.



In certain groups the number of "primaries," or quill-feathers growing from the manus or distal segment of the wing, formed another characteristic easy of observation. In the *Oscines* or *Polymyidi* of Müller the number was either nine or ten—and if the latter the outermost of them was generally very small. In two of the other groups of which Prof. Cabanis especially treated—groups which had been hitherto more or less confounded with the *Oscines*—the number of primaries was invariably ten, and the outermost of them was comparatively large. This observation was also hailed as the discovery of a fact of extraordinary importance; and, from the results of these investigations, taken altogether, Ornithology was declared by Sundevall, undoubtedly a man who had a right to speak with authority, to have made greater progress than had been achieved since the days of Cuvier. The final disposition of the "Subclass *Incesores*"—all the perching Birds, that is to say, which are neither Birds-of-Prey nor Pigeons—proposed by Prof. Cabanis, was into four "Orders," as follows:—

1. *Oscines*, equal to Müller's group of the same name;
2. *Clamatores*, being a majority of that division of the *Picariis* of Nitzsch, so called by Andreas Wagner, in 1841,<sup>1</sup> which have their feet normally constructed;
3. *Strisores*, a group now separated from the *Clamatores* of Wagner, and containing those forms which have their feet abnormally constructed; and
4. *Scansores*, being the *Grimpeurs* of Cuvier, the *Zygodactyli* of several other systematists.

The first of these four "Orders" had been already indefeasibly established as one perfectly natural, but respecting its details more must presently be said. The remaining three are now seen to be obviously artificial associations, and the second of them, *Clamatores*, in particular, containing a very heterogeneous assemblage of forms; but it must be borne in mind that the internal structure of some of them was at that time still more imperfectly known than now. Yet even then enough had been ascertained to have saved what are now recognized as the Families *Totidæ* and *Tyrannidæ* from being placed as "Subfamilies" in the same "Family *Colopteridæ*"; and several other instances of unharmonious combination in this "Order" might be adduced were it worth while to particularize them. More than that, it would not be difficult to shew, only the present is not exactly the place for it, that some groups or Families which in reality are not far distant from one another are distributed, owing to the dissimilarity of their external characters, throughout these three Orders. Thus the *Podarginæ* are associated with the *Coraciidæ* under the head *Clamatores*, while the *Caprimulgidæ*, to which they are clearly most allied, if they do not form part of that Family (GOATSUCKER, vol. x. p. 711), are placed with the *Strisores*; and again the *Misophagidæ* also stand as *Strisores*, while the *Cuculidæ*, which modern systematists think to be their nearest relations, are considered to be *Scansores*.

But to return to the *Oscines*, the arrangement of which in the classification now under review has been deemed its greatest merit, and consequently has been very generally followed. That by virtue of the perfection of their vocal organs, and certain other properties—though some of these last have perhaps never yet been made clear enough—they should stand at the head of the whole Class, may here be freely admitted, but the respective rank assigned to the various component Families of the group is certainly open to question, and to the present writer seems, in the methods of several systematists, to be based upon a fallacy. This respective rank of the different Families appears to have been assigned on the principle that, since by reason of one character (namely, the more complicated structure of their syrinx) the *Oscines* form a higher group than the *Clamatores*, therefore all the concomitant features which the former possess and the latter do not must be equally indicative of superiority. Now one of the features in which most of the *Oscines* differ from the lower "Order" is the having a more or less undivided *planta*, and accordingly it has been assumed that the Family of *Oscines* in which this modification of the *planta* is carried to its extreme point must be the highest of that "Order." Since, therefore, this extreme modification of the *planta* is

exhibited by the Thrushes and their allies, it is alleged that they must be placed first, and indeed at the head of all Birds. The groundlessness of this reasoning ought to be apparent to everybody. In the present state of anatomy at any rate, it is impossible to prove that there is more than a coincidence in the facts just stated, and in the association of two characters—one deeply seated and affecting the whole life of the Bird, the other superficially, and so far as we can perceive without effect upon its organism. Because the *Clamatores*, having no song-muscles, have a divided *planta*, it cannot be logical to assume that among the *Oscines*, which possess song-muscles, such of them as have an undivided *planta* must be higher than those that have it divided. The argument, if it can be called an argument, is hardly one of analogy; and yet no stronger ground has been occupied by those who invest the Thrushes, as do the majority of modern systematists, with the most dignified position in the whole Class. But passing from general to particular considerations, so soon as a practical application of the principle is made its inefficacy is manifest. The test of perfection of the vocal organs must be the perfection of the notes they enable their possessor to utter. There cannot be a question that, sing admirably as do some of the Birds included among the Thrushes,<sup>2</sup> the Larks, as a Family, infinitely surpass them. Yet the Larks form the very group which, as has been already shewn (LARK, vol. xiv. p. 314), have the *planta* more divided than any other among the *Oscines*. It seems hardly possible to adduce anything that would more conclusively demonstrate the independent nature of each of these characters—the complicated structure of the syrinx and the asserted inferior formation of the *planta*—which are in the *Alaudidæ* associated.<sup>3</sup> Moreover, this same Family affords a very valid protest against the extreme value attached to the presence or absence of the outermost quill-feather of the wings, and in this work it has been before shewn (*ut supra*) that almost every stage of magnitude in this feather is exhibited by the Larks from its rudimentary or almost abortive condition in *Alauda arvensis* to its very considerable development in *Melanocorypha calandra*. Indeed there are many genera of *Oscines* in which the proportion that the outermost primary bears to the rest is at best but a specific character, and certain exceptions are allowed by Prof. Cabanis (p. 313) to exist. Some of them it is now easy to explain, inasmuch as in a few cases the apparently aberrant genera have elsewhere found a more natural position, a contingency to which he himself was fully awake. But as a rule the allocation and ranking of the different Families of *Oscines* by this author must be deemed arbitrary.<sup>4</sup> Yet the value of his *Ornithologische Notizen* is great, not only as evidence of his extraordinarily extensive acquaintance with different forms, which is proclaimed in every page, but in leading to a far fuller appreciation of characters that certainly should on no account be neglected, though

<sup>1</sup> Prof. Cabanis would have strengthened his position had he included in the same Family with the Thrushes, which he called *Rhamnoides*, the Birds commonly known as Warblers, *Sylviidæ*, which the more advanced of recent systematists are inclined with much reason to unite with the Thrushes, *Turdidæ*; but instead of that he, trusting to the planter character, segregated the Warblers, including of course the Nightingale, and did not even allow them the second place in his method, putting them below the Family called by him *Sylvioides*, consisting chiefly of the American forms now known as *Mniotiltidæ*, none of which as songsters approach those of the Old World.

<sup>2</sup> It must be observed that Prof. Cabanis does not place the *Alaudidæ* lowest of the seventeen Families of which he makes the *Oscines* to be composed. They stand eleventh in order, while the *Corvidæ* are last—a matter on which something has to be said in the sequel.

<sup>3</sup> By a curious error, probably of the press, the number of primaries assigned to the *Paradisiidæ* and *Corvidæ* is wrong (pp. 334, 336). In each case 10 should be substituted for 12 and 14.

<sup>4</sup> *Archiv für Naturgeschichte*, vii. 2, pp. 93, 94. The division seems to have been instituted by this author a couple of years earlier in the second edition of his *Handbuch der Naturgeschichte* (a work not seen by the present writer), but not then to have received a scientific name. It included all *Picariis* which had not "zygodactylous" feet, that is to say, toes placed in pairs, two before and two behind.

too much importance may easily be, and already has been, assigned to them.<sup>1</sup>

This will perhaps be the most convenient place to mention another kind of classification of Birds, which, based on a principle wholly different from those that have just been explained, requires a few words, though it has not been productive, nor is likely, from all that appears, to be productive of any great effect. So long ago as 1831, BONAPARTE, in his *Saggio di una distribuzione metodica degli Animali Vertebrati*, published at Rome, and in 1837 communicated to the Linnean Society of London, "A new Systematic Arrangement of Vertebrated Animals," which was subsequently printed in that Society's *Transactions* (xviii. pp. 247-304), though before it appeared there was issued at Bologna, under the title of *Synopsis Vertebratorum Systematis*, a Latin translation of it. Herein he divided the Class *Aves* into two Subclasses, to which he applied the names of *Insectores* and *Orallatores* (hitherto used by their inventors Vigors and Illiger in a different sense), in the latter work relying chiefly for this division on characters which had not before been used by any systematist, namely, that in the former group Monogamy generally prevailed and the helpless nestlings were fed by their parents, while the latter group were mostly Polygamous, and the chicks at birth were active and capable of feeding themselves. This method, which in process of time was dignified by the title of a Physiological Arrangement, was insisted upon with more or less pertinacity by the author throughout a long series of publications, some of them separate books, some of them contributed to the memoirs issued by many scientific bodies of various European countries, ceasing only at his death, which in July 1857 found him occupied upon a *Conspectus Generum Avium*, that in consequence remains unfinished (see p. 14). In the course of this series, however, he saw fit to alter the name of his two Subclasses, since those which he at first adopted were open to a variety of meanings, and in a communication to the French Academy of Sciences in 1853 (*Comptes Rendus*, xxvii. pp. 641-647) the denomination *Insectores* was changed to *Allrices*, and *Orallatores* to *Procoes*—the terms now preferred by him being taken from Sander's treatise of 1835 already mentioned. The views of Bonaparte were, it appears, also shared by an ornithological amateur of some distinction, Hooq, who propounded a scheme which, as he subsequently stated (*Zoologist*, 1850, p. 2797), was founded strictly in accordance with them; but it would seem that, allowing his convictions to be warped by other considerations, he abandoned the original "physiological" basis of his system, so that this, when published in 1846 (*Edinb. N. Philosoph. Journal*, xli. pp. 50-71), was found to be established on a single character of the feet only; though he was careful to point out, immediately after formulating the definition of his Subclasses *Constrictipedes* and *Inconstrictipedes*, that the former "make, in general, compact and well-built nests, wherein they bring up their very weak, blind, and mostly naked young, which they feed with care, by bringing food to them for many days, until they are fledged and sufficiently strong to leave their nest," observing also that they "are principally monogamous" (pp. 55, 56); while of the latter he says that they "make either a poor and rude nest, in which they lay their eggs, or else none, depositing them on the bare ground. The young are generally born with their full sight, covered with down, strong, and capable of running or swimming immediately after they leave the egg-shell." He adds that the parents, which "are mostly polygamous," attend their young and direct them where to find their food (p. 68). The numerous errors in these assertions hardly need pointing out. The Herons, for instance, are much more "*Constrictipedes*" than are the Larks or the Kingfishers, and, so far from the majority of "*Inconstrictipedes*" being polygamous, there is scarcely any evidence of polygamy obtaining as a habit among Birds in a state of nature except in certain of the *Gallinæ* and a very few others. Furthermore, the young of the Goatsuckers are at hatching far more developed than are those of the Herons or the Cormorants; and, in a general way, nearly every one of the asserted peculiarities of the two Subclasses breaks down under careful examination. Yet the idea of a "physiological" arrangement on the same kind of principle found another follower, or, as he thought, inventor, in NEWMAN, who in 1850 communicated to the Zoological Society of London a plan published in its *Proceedings* for that year (pp. 46-48), and reprinted also in his own journal *The Zoologist* (pp. 2780-2783), based on exactly the same considerations, dividing Birds into two groups, "Hæstogenous"—a word so vicious in formation as to be incapable of amendment, but intended to signify those that were hatched with a clothing of down—and "Gymnogenous," or those that were hatched naked. These three systems are essentially identical; but, plausible as they may be at

the first aspect, they have been found to be practically useless, though such of their characters as their upholders have advanced with truth deserve attention. Physiology may one day very likely assist the systematist; but it must be real physiology and not a sham.

In 1856 Prof. GERVAIS, who had already contributed to the *Zoologie* of M. de Castelnau's *Expédition dans les parties centrales de l'Amérique du Sud* some of his most important memoirs describing the anatomy of the HOACHTIN (vol. xii. p. 28) and certain other Birds of doubtful or anomalous position, published some remarks on the characters which could be drawn from the sternum of Birds (*Ann. Sc. Nat. Zoologie*, ser. 4, vi. pp. 6-15). The considerations are not very striking from a general point of view; but the author adds to the weight of evidence which some of his predecessors had brought to bear on certain matters, particularly in aiding to abolish the artificial groups "Dédactyls," "Syndactyls," and "Zygodactyls," on which so much reliance had been placed by many of his countrymen; and it is with him a great merit that he was the first apparently to recognize publicly that characters drawn from the posterior part of the sternum, and particularly from the "*schæncures*," commonly called in English "notches" or "emarginations," are of comparatively little importance, since their number is apt to vary in forms that are most closely allied, and even in species that are usually associated in the same genus or unquestionably belong to the same Family,<sup>2</sup> while these "notches" sometimes become simple *foramina*, as in certain Pigeons, or on the other hand *foramina* may exceptionally change to "notches," and not unfrequently disappear wholly. Among his chief systematic determinations we may mention that he refers the Tinamous to the Rail, because apparently of their deep "notches," but otherwise takes a view of that group more correct according to modern notions than did most of his contemporaries. The Bustards he would place with the "Limicolæ," as also *Dromas* and *Chionis*, the SHEATH-BILL (*g. s.*) *Phaethon*, the TROPIC-BIRD (*g. s.*) he would place with the "Laridæ" and not with the "Pelicanidæ," which it only resembles in its feet having all the toes connected by a web. Finally Divers, Auks, and Penguins, according to him, form the last term in the series, and it seems fit to him that they should be regarded as forming a separate Order. It is a curious fact that even at a date so late as this, and by an investigator so well informed, doubt should still have existed whether *Apteryx* (KIWI, vol. xiv. p. 104) should be referred to the group containing the Casowary and the Ostrich. On the whole the remarks of this esteemed author do not go much beyond such as might occur to any one who had made a study of a good series of specimens; but many of them are published for the first time, and the author is careful to insist on the necessity of not resting solely on sternal characters, but associating with them those drawn from other parts of the body.

Three years later in the same journal (xi. pp. 11-146, pls. 2-4) M. BLANCHARD published some *Recherches sur les caractères ostéologiques des Oiseaux appliquées à la Classification naturelle de ces animaux*, strongly urging the superiority of such characters over those drawn from the bill or feet, which, he remarks, though they may have sometimes given correct notions, have mostly led to mistakes, and, if observations of habits and food have sometimes afforded happy results, they have often been deceptive; so that, should more be wanted than to draw up a mere inventory of creation or trace the distinctive outline of each species, zoology without anatomy would remain a barren study. At the same time he states that authors who have occupied themselves with the sternum alone have often produced uncertain results, especially when they have neglected its anterior for its posterior part; for in truth every bone of the skeleton ought to be studied in all its details. Yet this distinguished zoologist selects the sternum as furnishing the key to his primary groups or "Orders" of the Class, adopting, as Merrem had done long before, the same two divisions *Carinata* and *Batita*, naming, however, the former *Tropidosterni* and the latter *Homalosterni*.<sup>3</sup> Some unkind fate has hitherto hindered him from making known to the world the rest of his researches in regard to the other bones of the skeleton till he reached the head, and in the memoir cited he treats of the sternum of only a portion of his first "Order." This is the more to be regretted by all ornithologists, since he intended to conclude with what to them would have been a very great boon—the showing in what way external characters coincided with those presented by Osteology. It was also within the scope of his plan to have continued on a more extended scale the researches on ossification begun by L'Herminier, and thus M.

<sup>2</sup> Thus he cites the cases of *Machates pugnax* and *Scolopax rusticola* among the "Limicolæ," and *Larus catartacus* among the "Laridæ," as differing from their nearest allies by the possession of only one "notch" on either side of the keel. Several additional instances are cited in *Philos. Transactions*, 1869, p. 337, note.

<sup>3</sup> These terms were explained in his great work *L'Organisation du Règne Animal, Oiseaux* (p. 16), begun in 1855, and still (1884) no further advanced than its fourth part, comprehending in all but thirty-two pages of letter-press, to mean exactly the same as those applied by Merrem to his two primary divisions.

<sup>1</sup> A much more extensive and detailed application of his method was begun by Prof. Cabanis in the *Museum Helveticum*, a very useful catalogue of specimens in the collection of Herr Oberamtmann Heine, of which the first part was published at Halberstadt in 1850, and the last which has appeared, the work being still unfinished, in 1863.



Blanchard's investigations, if completed, would obviously have taken extraordinarily high rank among the highest contributions to ornithology. As it is, so much of them as we have are of considerable importance; for, in this unfortunately unfinished memoir, he describes in some detail the several differences which the sternum in a great many different groups of his *Tropidosterni* presents, and to some extent makes a methodical disposition of them accordingly. Thus he separates the Birds-of-Prey into three great groups—(1) the ordinary Diurnal forms, including the *Falconidae* and *Faltridae* of the systematist of his time, but distinguishing the American Vultures from those of the Old World; (2) *Gypogeronus*, the SECRETARY-BIRD (*g.v.*); and (3) the Owls (*infra*, p. 88). Next he places the PARROTS (*g.v.*), and then the vast assemblage of "Passeriaux"—which he declares to be all of one type, even genera like *Pipra* (MANAKIN, vol. xv. p. 455) and *Pitta*—and concludes with the somewhat heterogeneous conglomeration of forms, beginning with *Cypselus* (SWIFT, *g.v.*), that so many systematists have been accustomed to call *Picariae*, though to them as a group he assigns no name. A continuation of the treatise was promised in a succeeding part of the *Annales*, but a quarter of a century has passed without its appearance.<sup>1</sup>

Important as are the characters afforded by the sternum, that bone even with the whole sternal apparatus should obviously not be considered alone. To aid ornithologists in their studies in this respect, EYTON, who for many years had been forming a collection of Birds' skeletons, began the publication of a series of plates representing them. The first part of this work, *Osteologia Avium*, appeared early in 1859, and a volume was completed in 1867. A Supplement was issued in 1869, and a Second Supplement, in three parts, between 1873 and 1875. The whole work contains a great number of figures of Birds' skeletons and detached bones; but they are not so drawn as to be of much practical use, and the accompanying letter-press is too brief to be satisfactory.

That the eggs laid by Birds should offer to some extent characters of utility to systematists is only to be expected, when it is considered that those from the same nest generally bear an extraordinary family-likeness to one another, and also that in certain groups the essential peculiarities of the egg-shell are constantly and distinctively characteristic. Thus no one who has ever examined the egg of a Duck or of a Tinamou would ever be in danger of not referring another Tinamou's egg or another Duck's, that he might see, to its proper Family, and so on with many others. Yet, as has been stated on a former occasion (BIRDS, vol. iii. p. 772), the expectation held out to oologists, and by them, of the benefits to be conferred upon Systematic Ornithology from the study of Birds' eggs, so far from being fulfilled, has not infrequently led to disappointment. But at the same time many of the shortcomings of Oology in this respect must be set down to the defective information and observation of its votaries, among whom some have been very lax, not to say incautions, in not ascertaining on due evidence the percentage of their specimens, and the author next to be named is open to this charge. After several minor notices that appeared in journals at various times, DES MURS in 1860 brought out at Paris his ambitious *Traité général d'Oologie Ornithologique au point de vue de la Classification*, which contains (pp. 529-538) a "Systema Oologicum" as the final result of his labours. In this scheme Birds are arranged according to what the author considered to be their natural method and sequence; but the result exhibits some unions as ill-assorted as can well be met with in the whole range of tentative arrangements of the Class, together with some very unjustifiable divorces. Its basis is the classification of Cuvier, the modifications of which by Des Murs will seldom commend themselves to systematists whose opinion is generally deemed worth having. Few, if any, of the faults of that classification are removed, and the improvements suggested, if not established by his successors, those especially of other countries than France, are ignored, or, as in the case with some of those of L'Herminier, are only cited to be set aside. Oologists have no reason to be thankful to Des Murs, notwithstanding his zeal in behalf of their study. It is perfectly true that in several or even in many instances he acknowledges and deprecates the poverty of his information, but this does not excuse him for making assertions (and such assertions are not unfrequent) based on evidence that is either wholly untrustworthy or needs further enquiry before it can be accepted (*Ibid.*, 1860, pp. 331-335). This being the case, it would seem useless to take up further space by analysing the several proposed modifications of Cuvier's arrangement. The great merit of the work is that the author shows the necessity of taking Oology into account when investigating the classification of Birds; but it also proves that in so doing the paramount consideration lies in the thorough sifting of evidence as to the percentage of the eggs which are to serve as the building stones of the fabric to be erected. The attempt of Des Murs was

praiseworthy; but in effect it has utterly failed, notwithstanding the encomiums passed upon it by friendly critics (*Litt. de Zoologie*, 1860, pp. 178-183, 318-325, 370-373).<sup>2</sup>

Until about this time systematists, almost without exception, may be said to have been wandering with no definite purpose. At least their purpose was indefinite compared with that which they now have before them. No doubt they all agreed in saying that they were prosecuting a search for what they called the True System of Nature; but that was nearly the end of their agreement, for in what that True System consisted the opinions of scarcely any two would coincide, unless to own that it was some shadowy idea beyond the present power of mortals to reach or even comprehend. The Quinarians, who boldly asserted that they had fathomed the mystery of Creation, had been shown to be no wiser than other men, if indeed they had not utterly befooled themselves; for their theory at best could give no other explanation of things than that they were because they were. The conception of such a process as has now come to be called by the name of Evolution was certainly not novel; but except to two men the way in which that process was or could be possible had not been revealed.<sup>3</sup> Here there is no need to enter into details of the history of Evolution; but the annalist in every branch of Biology must record the eventful 1st of July 1859, when the now celebrated views of DARWIN and MR WALLACE were first laid before the scientific world,<sup>4</sup> and must also notice the appearance towards the end of the following year of the former's *Origin of Species*, which has effected the greatest revolution of human thought in this or perhaps in any century. The majority of biologists who had schooled themselves on other principles were of course slow to embrace the new doctrine; but their hesitation was only the natural consequence of the caution which their scientific training enjoined. A few there were who felt as though scales had suddenly dropped from their eyes, when greeted by the idea conveyed in the now familiar phrase "Natural Selection"; but even those who had hitherto believed, and still continued to believe, in the sanctity of "Species" at once perceived that their life-long study had undergone a change, that their old position was seriously threatened by a perilous siege, and that to make it good they must find new means of defence. Many bravely maintained their posts, and for them not a word of blame ought to be expressed. Some few pretended, though the contrary was notorious, that they had always been on the side of the new philosophy, so far as they allowed it to be philosophy at all, and for them hardly a word of blame is too severe. Others after due deliberation, as became men who honestly desired the truth and nothing but the truth, yielded wholly or almost wholly to arguments which they gradually found to be irresistible. But, leaving generalities apart, and restricting ourselves to what is here our proper business, there was possibly no branch of Zoology in which so many of the best informed and consequently the most advanced of its workers sooner accepted the principles of Evolution than Ornithology, and of course the effect upon its study was very marked. New spirit was given to it. Ornithologists now felt they had something before them that was really worth investigating. Questions of Affinity, and the details of Geographical Distribution, were endowed with a real interest, in comparison with

<sup>1</sup> In this historical sketch of the progress of Ornithology it has not been thought necessary to mention other oological works, since they have not a taxonomic bearing, and the chief of them have been already named (BIRDS, vol. iii. p. 774, note 1).

<sup>2</sup> Neither Lamarck nor Robert Chambers (the now acknowledged author of *Vestiges of Creation*), though thorough evolutionists, rationally indicated any means whereby, to use the old phrase, "the transmutation of species" could be effected.

<sup>3</sup> *Journal of the Proceedings of the Linnean Society*, vol. iii., Zoology, pp. 45-62.

<sup>4</sup> M. Blanchard's animal-versions on the employment of external characters, and on trusting to observations on the habits of Birds, called forth a rejoinder from Mr Wallace (*Ibid.*, 1864, pp. 36-41), who successfully showed that they are not altogether to be despised.

which any interest that had hitherto been taken was a trifling pastime. Classification assumed a wholly different aspect. It had up to this time been little more than the shuffling of cards, the ingenious arrangement of counters in a pretty pattern. Henceforward it was to be the serious study of the workings of Nature in producing the beings we see around us from beings more or less unlike them, that had existed in bygone ages and had been the parents of a varied and varying offspring—our fellow-creatures of today. Classification for the first time was something more than the expression of a fancy, not that it had not also its imaginative side. Men's minds began to figure to themselves the original type of some well-marked genus or Family of Birds. They could even discern dimly some generalized stock whence had descended whole groups that now differed strangely in habits and appearance—their discernment aided, may be, by some isolated form which yet retained undeniable traces of a primitive structure. More dimly still visions of what the first Bird may have been like could be reasonably entertained; and, passing even to a higher antiquity, the Roptilian parent whence all Birds have sprung was brought within reach of man's consciousness. But, relieved as it may be by reflexions of this kind—dreams some may perhaps still call them—the study of Ornithology has unquestionably become harder and more serious; and a corresponding change in the style of investigation, followed in the works that remain to be considered, will be immediately perceptible.

That this was the case is undeniably shewn by some remarks of Canon TRISTRAM, who, in treating of the *Alaudids* and *Saxicolins* of Algeria (whence he had recently brought a large collection of specimens of his own making), stated (*Ibis*, 1859, pp. 429-433) that he could "not help feeling convinced of the truth of the views set forth by Messrs Darwin and Wallace," adding that it was "hardly possible, I should think, to illustrate this theory better than by the Larks and Chats of North Africa." It is unnecessary to continue the quotation; the few words just cited are enough to assure to their author the credit of being (so far as is known) the first ornithological specialist who had the courage publicly to recognize and receive the new and at that time unpopular philosophy.<sup>1</sup> But greater work was at hand. In June 1860 Prof. PARKER broke, as most will allow, entirely fresh ground, and ground that he has since continued to till more deeply perhaps than any other zoologist, by communicating to the Zoological Society a memoir "On the Osteology of *Balmiceps*," subsequently published in that Society's *Transactions* (iv. pp. 269-351). Of this contribution to science, as of all the rest which have since proceeded from him, may be said in the words he himself has applied (*ut supra*, p. 271) to the work of another labourer in a not distant field:—"This is a model paper for unbiassed observation, and freedom from that pleasant-mode of supposing instead of ascertaining what is the true nature of an anatomical element."<sup>2</sup> Indeed the study of this memoir, limited though it be in scope, could not fail to convince any one that it proceeded from the mind of one who taught with the authority derived directly from original knowledge, and not from association with the scribes—a conviction that has become strengthened as, in a series of successive memoirs, the stores of more than twenty years' silent observation and unmitting research

were unfolded, and, more than that, the hidden forces of the science of Morphology were gradually brought to bear upon almost each subject that came under discussion. These different memoirs, being technically monographs, have strictly no right to be mentioned in this place; but there is scarcely one of them, if one indeed there be, that does not deal with the generalities of the study; and the influence they have had upon contemporary investigation is so strong that it is impossible to refrain from noticing them here, though want of space forbids us from enlarging on their contents.<sup>3</sup> Moreover, the doctrine of Descent with variation is preached in all—seldom, if ever, conspicuously, but perhaps all the more effectively on that account. There is no reflective thinker but must perceive that Morphology is the lamp destined to throw more light than that afforded by any other kind of study on the obscurity that still shrouds the genealogy of Birds as of other animals; and, though as yet its illuminating power is admittedly far from what is desired, it has perhaps never shone more brightly than in Prof. Parker's hands. The great fault of his series of memoirs, if it may be allowed the present writer to criticize them, is the indifference of their author to formulating his views, so as to enable the ordinary taxonomer to perceive how far he has got, if not to present him with a fair scheme. But this fault is possibly one of those that are "to merit near allied," since it would seem to spring from the author's hesitation to pass from observation to theory, for to theory at present belong, and must for some time belong, all attempts at Classification. Still it is not the less annoying and disappointing to the systematist to find that the man whose life-long application would enable him, better than any one else, to declare the effect of the alliances and differences that have been shewn to exist among various members of the Class should yet be so reticent, or that when he speaks he should rather use the language of Morphology, which those who are not morphologists find difficult of correct interpretation, and wholly inadequate to allow of zoological deductions.<sup>4</sup>

<sup>1</sup> It may be convenient to our readers that a list of Prof. Parker's works which treat of ornithological subjects, in addition to the two above mentioned, should here be given. They are as follows:—*In the Zoological Society's Transactions*, 25th November 1862, "On the Osteology of the Gallinaceous Birds and Tinamous," v. pp. 149-241; 12th December 1860, "On some fossil Birds from the Zebbug Cave," vi. pp. 119-124; 9th January 1863, "On the Osteology of the Kagu," vi. pp. 501-521; 18th February 1878, "On the *Egithognathus* Birds," Pt. I. ix. pp. 289-352; 15th February 1876, "On the Skull of the *Egithognathus* Birds," Pt. II. x. pp. 251-314. *In the Proceedings of the same Society*, 8th December 1863, "On the systematic position of the Crested Screamer," pp. 511-518; 23rd February 1865, "On the Osteology of *Microptocca alata*," pp. 235-238. *In the Philosophical Transactions of the Royal Society*, 9th March 1865, "On the Structure and Development of the Skull in the Ostrich Tribe," pp. 113-183; 11th February 1869, "On the Structure and Development of the Skull of the Common Fowl," pp. 755-807. *In the Linnean Society's Transactions*, 2d April 1874, "On the Morphology of the Skull in the Woodpeckers and Wrynecks," ser. 2, Zoology, l. pp. 1-22; 16th December 1875, "On the Structure and Development of the Bird's Skull," *tom. cit.*, pp. 99-154. *In the Monthly Microscopical Journal* for 1872, "On the Structure and Development of the Crow's Skull," pp. 217-263; for 1873, "On the Development of the Skull in the genus *Turdus*," pp. 102-107, and "On the Development of the Skull in the Tit and Sparrow Hawk" parts i. and ii., pp. 6-11, 45-50. There is besides the great work published by the Ray Society in 1868, *A Monograph on the Structure and Development of the Shoulder-girdle and Sternum*, of which pp. 142-191 treat of these parts in the Class *Aves*; and our readers will hardly need to be reminded of the article *BIRDS* in the present work (vol. III. pp. 699-728). Nearly every one of this marvellous series of contributions is copiously illustrated by plates from drawings made by the author himself.

<sup>2</sup> As an instance, take the passages in which *Ternitis* and *Thimocorus* are apparently referred to the *Egithognathus* (*Trans. Zool. Society*, ix. pp. 291 *et seq.*; and *supra*, vol. III. p. 700), a view which, as shewn by the author (*Transactions*, x. p. 310), is not that really intended by him.

For some time past rumours of a discovery of the highest interest had been agitating the minds of zoologists, for in 1861 ANDREAS WAGNER had sent to the Academy of Sciences of Munich (*Sitzungsberichte*, pp. 146-154; *Ann. Nat. History*, ser. 3, ix. pp. 261-267) an account of what he conceived to be a feathered Reptile (assigning to it the name *Griphosaurus*), the remains of which had been found in the lithographic beds of Solenhofen; but he himself, through failing health, had been unable to see the fossil. In 1862 the slabs containing the remains were acquired by the British Museum, and towards the end of that year Sir R. OWEN communicated a detailed description of them to the *Philosophical Transactions* (1863, pp. 33-47), proving their Bird-like nature, and referring them to the genus *Archæopteryx* of Hermann von Meyer, hitherto known only by the impression of a single feather from the same geological beds. Wagner foresaw the use that would be made of this discovery by the adherents of the new Philosophy, and, in the usual language of its opponents at the time, strove to ward off the "misinterpretations" that they would put upon it. His protest, it is needless to say, was unavailing, and all who respect his memory must regret that the sunset of life failed to give him that insight into the future which is poetically ascribed to it. To Darwin and those who believed with him scarcely any discovery could have been more welcome; but that is beside our present business. It was quickly seen—even by those who held *Archæopteryx* to be a Reptile—that it was a form intermediate between existing Birds and existing Reptiles—while those who were convinced by Sir R. Owen's researches of its ornithic affinity saw that it must belong to a type of Birds wholly unknown before, and one that in any future for the arrangement of the Class must have a special rank reserved for it.<sup>1</sup> It has been already briefly described and figured in this work (BIRDS, vol. iii. pp. 728, 729).

It behoves us next to mention the "Outlines of a Systematic Review of the Class of Birds," communicated by Prof. LILLJEBORG to the Zoological Society in 1866, and published in its *Proceedings* for that year (pp. 5-20), since it was immediately after reprinted by the Smithsonian Institution, and with that authorization has exercised a great influence on the opinions of American ornithologists. Otherwise the scheme would hardly need notice here. This paper is indeed little more than an English translation of one published by the author in the annual volume (*Arskrift*) of the Scientific Society of Upsala for 1860, and belonging to the pre-Darwinian epoch should perhaps have been more properly treated before, but that at the time of its original appearance it failed to attract attention. The chief merit of the scheme perhaps is that, contrary to nearly every precedent, it begins with the lower and rises to the higher groups of Birds, which is of course the natural mode of proceeding, and one therefore to be commended. Otherwise the "principles" on which it is founded are not clear to the ordinary zoologist. One of them is said to be "irritability," and, though this is explained to mean, not "muscular strength alone, but vivacity and activity generally,"<sup>2</sup> it does not seem to form a character that can be easily appreciated either as to quantity or quality; in fact, most persons would deem it quite immeasurable, and, as such, removed from practical consideration. Moreover, Prof. Lilljeborg's scheme, being actually an adaptation of that of Sundevall, of which we shall have to speak at some length almost immediately, may possibly be left for the present with these remarks.

In the spring of the year 1867 Prof. HUXLEY, to the delight of an appreciative audience, delivered at the Royal College of Surgeons of England a course of lectures on Birds, and it is much to be regretted that his many engagements hindered him from publishing in its entirety his elucidation of the anatomy of the Class, and the results

which he drew from his investigations of it; for never assuredly had the subject been attacked with greater skill and power, or, since the days Buffon, had Ornithology been set forth with greater eloquence. To remedy, in some degree, this unavoidable loss, and to preserve at least a portion of the fruits of his labours, Prof. Huxley, a few weeks after, presented an abstract of his researches to the Zoological Society, in whose *Proceedings* for the same year it will be found printed (pp. 415-472) as a paper "On the Classification of Birds, and on the taxonomic value of the modifications of certain of the cranial bones observable in that Class." Starting from the basis (which, undeniably true as it is, not a little shocked many of his ornithological hearers) "that the phrase 'Birds are greatly modified Reptiles' would hardly be an exaggerated expression of the closeness" of the resemblance between the two Classes, which he had previously brigaded under the name of *Sauropsida* (as he had brigaded the *Pisces* and *Amphibia* as *Ichthyopsida*), he drew in bold outline both their likenesses and their differences, and then proceeded to inquire how the *Aves* could be most appropriately subdivided into Orders, Suborders, and Families. In this course of lectures he had already dwelt at some length on the insufficiency of the characters on which such groups as had hitherto been thought to be established were founded; but for the consideration of this part of his subject there was no room in the present paper, and the reasons why he arrived at the conclusion that new means of philosophically and successfully separating the Class must be sought are herein left to be inferred. The upshot, however, admits of no uncertainty: the Class *Aves* is held to be composed of three "Orders"—(I.) SAURURÆ, Hæckel; (II.) RATITÆ, Merrem; and (III.) CARINATÆ, Merrom. The *Saururæ* have the metacarpals well developed and not ankylosed, and the caudal vertebrae are numerous and large, so that the caudal region of the spine is longer than the body. The furcula is complete and strong, the feet very Passerine in appearance. The skull and sternum were at the time unknown, and indeed the whole Order, without doubt entirely extinct, rested exclusively on the celebrated fossil, then unique, *Archæopteryx* (BIRDS, vol. iii. pp. 728, 729). The *Ratitæ* comprehend the Struthious Birds, which differ from all others now extant in the combination of several peculiarities, some of which have been mentioned in the preceding pages. The sternum has no keel, and ossifies from lateral and paired centres only; the axes of the scapula and coracoid have the same general direction; certain of the cranial bones have characters very unlike those possessed by the next Order—the vomer, for example, being broad posteriorly and generally intervening between the basisphenoidal rostrum and the palatals and pterygoids; the bars of the feathers are disconnected; there is no syrinx or inferior larynx; and the diaphragm is better developed than in other Birds.<sup>3</sup> The *Ratitæ* are divided into five groups, separated by very trenchant characters, principally osteological, and many of them afforded by the cranial bones. These groups consist of (i.) *Struthio* (OSTRICH, *infra*, p. 62), (ii.) *RHEA* (*g.v.*), (iii.) *Casuarus* and *Dromæus* (EMEU, vol. viii. 171), (iv.) *Dinornis*, and (v.) *Apteryx* (KIWI, vol. xiv. p. 104); but no names are here given to them. The *Carinatæ* comprise all other existing Birds. The sternum has more or less of a keel, and is said to ossify, with the possible exception of *Strigops* (KAKAPO, vol. xiii. p. 825), from a median centre as well as from paired and lateral centres. The axes of the scapula and coracoid meet at an acute, or, as in *Didus* (DODO, vol. vii. p. 321) and *Ocydromus* (OCYDROME, vol. xvii. p. 222), at a slightly obtuse angle, while the vomer is

<sup>1</sup> This was done shortly afterwards by Prof. Hæckel, who proposed the name *Saurura* for the group containing it.

<sup>2</sup> On this ground it is stated that the *Passeres* should be placed highest in the Class. But those who know the habits and demeanour of many of the *Limicolæ* would no doubt rightly claim for them much more "vivacity and activity" than is possessed by most *Passeres*.

<sup>3</sup> This peculiarity had led some zoologists to consider the Struthious Birds more nearly allied to the *Mammalia* than any others.

comparatively narrow and allows the pterygoids and palatals to articulate directly with the basisphenoidal rostrum. The *Carinatae* are divided, according to the formation of the palate, into four "Suborders," and named (i.) *Dromagnathae*, (ii.) *Schiognathae*, (iii.) *Demognathae*, and (iv.) *Egithognathae*.<sup>1</sup> The *Dromagnathae* resemble the *Ratites*, and especially the genus *Dromus*, in their palatal structure, and are composed of the TIMAMOUS (*q.v.*). The *Schiognathae* include a great many of the forms belonging to the Linnæan Orders *Gallinae*, *Grallae*, and *Asseres*. In them the vomer, however variable, always tapers to a point anteriorly, while behind it includes the basisphenoidal rostrum between the palatals; but neither these nor the pterygoids are borne by its posterior divergent ends. The maxillo-palatals are usually elongated and lamellar, uniting with the palatals, and, bending backward along their inner edge, leave a cleft (whence the name given to the "Suborder") between the vomer and themselves. Six groups of *Schiognathae* are distinguished with considerable minuteness:—(1) *Charadriomorphae*, containing *Charadriids* (PLOVER, *q.v.*), *Otidids* (BUSTARD, vol. iv. p. 578), and *Scelopacids*; (2) *Geranomorphae*, including *Gruidae* (CRANE, vol. vi. p. 546) and *Ballidae*, between which *Prophiids* and *Rhinocetids* are intermediate, while the *SERIEMA* (*q.v.*) would also seem to belong here; (3) *Coccomorphae*, comprising *Larids* (GULL, vol. xi. p. 314), *Procellariids* (PETREL, *q.v.*), *Colymbids* (DIVER, vol. vii. p. 292), and *Alcids* (GUILLEMOU, vol. xi. p. 262); (4) *Sphenicomorphae*, composed of the PENGUINS (*q.v.*); (5) *Alectoromorphae* (FOWL, vol. ix. p. 491), being all the *Gallinae* except the Timamous; and finally (6) *Peristeromorphae*, consisting of the DOVES (vol. vii. p. 379) and *Pipitids* (*q.v.*). In the third of these Suborders, the *Demognathae*, the vomer is either abortive or so small as to disappear from the skeleton. When it exists it is always slender, and tapers to a point anteriorly. The maxillo-palatals are bound together (whence the name of the "Suborder") across the middle line, either directly or by the ossification of the nasal septum. The posterior ends of the palatals and anterior of the pterygoids articulate directly with the rostrum. The groups of *Demognathae* are characterized as carefully as are those of the preceding "Suborder," and are as follows:—(1) *Chenomorphae*, consisting of the *Anatides* (DUCK, vol. vii. p. 505; GOOSE, vol. x. p. 777) with *Palamedea*, the SCREAMER (*q.v.*); (2) *Amphimorphae*, the FLAMINGOES (vol. ix. p. 286); (3) *Pelargomorphae*, containing the *Ardeids* (HERON, vol. xi. p. 760), *Ciconiids* (STORK, *q.v.*), and *Tantalids*; (4) *Dyspocormorphae*, the CORMORANTS (vol. vi. p. 407), FRIGATE-BIRDS (vol. ix. p. 786), GANNETS (vol. x. p. 70), and PELICANS (*q.v.*); (5) *Aetomorphae*, comprising all the Birds-of-Prey; (6) *Pittacomorphae*, the PARROTS (*q.v.*); and lastly (7) *Coccygomorphae*, which are held to include four groups, viz., (a) *Coliids* (MOUSE-BIRD, vol. xvii. p. 6); (b) *Musophagids* (PLANTAIN-EATERS and TOURACO, *q.v.*) *Cuculids* (CUCOOK, vol. vi. p. 685), *Bucconids*, *Rhamphastids* (TOUCANS, *q.v.*), *Captitornids*, *Galbulids* (JACAMAR, vol. xiii. p. 531); (c) *Alcedinids* (KING-FISHER, vol. p. 81), *Bucerotids* (HORNBILL, xii. p. 169), *Upipids* (HOOPOE, xii. p. 154), *Meropids*, *Momotids* (MOTMOT, xvii. p. 3), *Coraciids* (ROLLER, *q.v.*); and (d) *Trogonids* (TROGON, *q.v.*). Next in order come the *Celecomorphae* or WOODPECKERS (*q.v.*), a group respecting the exact position of which Prof. Huxley was uncertain,<sup>2</sup>

though he inclined to think its relations were with the next group, *Egithognathae*, the fourth and last of his "Suborders," characterized by a form of palate in some respects intermediate between the two preceding. The vomer is broad, abruptly truncated in front, and deeply cleft behind, so as to embrace the rostrum of the sphenoid; the palatals have produced postero-external angles; the maxillo-palatals are slender at their origin, and extend obliquely inwards and forwards over the palatals, ending beneath the vomer in expanded extremities, not united either with one another or with the vomer, nor does the latter unite with the nasal septum, though that is frequently ossified. Of the *Egithognathae* two divisions are made—(1) *Cypselomorphae*, including *Trochilids* (HUMMING-BIRD, vol. xii. p. 357), *Cypselids* (SWIFT, *q.v.*), and *Caprimulgids* (GOATSUCKER, vol. x. p. 711); and (2) *Coracomorphae*, which last are separable into two groups, one (a) formed of the genus *Menura* (LYRE-BIRD, vol. xv. p. 115), which then seemed to stand alone, and the other (b) made up of *Polymyodae*, *Tracheophones*, and *Oligomyodae*, sections founded on the syringeal structure, but declared to be not natural.

The above abstract<sup>3</sup> shows the general drift of this very remarkable contribution to Ornithology, and it has to be added that for by far the greater number of his minor groups Prof. Huxley relies solely on the form of the palatal structure, the importance of which Dr. Cornay, as already stated (p. 29), had before urged, though to so little purpose. That the palatal structure must be taken into consideration by taxonomers as affording hints of some utility there can no longer be a doubt; but the present writer is inclined to think that the characters drawn thence owe more of their worth to the extraordinary perspicuity with which they have been presented by Prof. Huxley than to their own intrinsic value, and that if the same power had been employed to elucidate in the same way other parts of the skeleton—say the bones of the sternal apparatus or even of the pelvic girdle—either set could have been made to appear quite as instructive and perhaps more so. Adventitious value would therefore seem to have been acquired by the bones of the palate through the fact that so great a master of the art of exposition selected them as fitting examples upon which to exercise his skill.<sup>4</sup> At the same time it must be stated this selection was not premeditated by Prof. Huxley, but forced itself upon him as his investigations proceeded.<sup>5</sup> In reply to some critical remarks (*Ibis*, 1868, pp. 85–96), chiefly aimed at shewing the inexpediency of relying solely on one set of characters, especially when those afforded by the palatal bones were not, even within the limits of Families, wholly diagnostic, the author (*Ibis*, 1868, pp. 357–362) announced a slight modification of his original scheme, by introducing three more groups into it, and concluded by indicating how its bearings upon the great question of "Genetic Classification" might be represented so far as the different groups of *Carinatae* are concerned:—

<sup>1</sup> This is adapted from that given in the *Record of Zoological Literature* (iv. pp. 46–49), which is believed to have not inadequately represented the author's views.

<sup>2</sup> The notion of the superiority of the palatal bones to all others for purposes of classification has pleased many persons, from the fact that these bones are not unfrequently retained in the dried skins of Birds sent home by collectors in foreign countries, and are therefore available for study, while such bones as the sternum and pelvis are rarely preserved. The common practice of ordinary collectors, until at least very recently, has been tersely described to the present writer as being to "shoot a bird, take off its skin, and throw away its characters."

<sup>3</sup> Perhaps this may be partially explained by the fact that the Museum of the College of Surgeons, in which these investigations were chiefly carried on, like most other museums of the time, contained a much larger series of the heads of Birds than of their entire skeletons, or of any other portion of the skeleton. Consequently the materials available for the comparison of different forms consisted in great part of heads only.

<sup>4</sup> These names are compounded respectively of *Dromus*, the generic name applied to the Emeu, *oxy* (a, a split or cleft, *delta*, a bond or tying, *delta*, a Finch, and in each case, *gamma*, a jaw.

<sup>5</sup> Prof. Parker subsequently advanced the Woodpeckers to a higher rank under the name of *Sawognathae* (*Monthly Microscop. Journal*, 1872, p. 219, and *Tr. Linn. Soc.*, ser. 2, Zoology, l. p. 2).

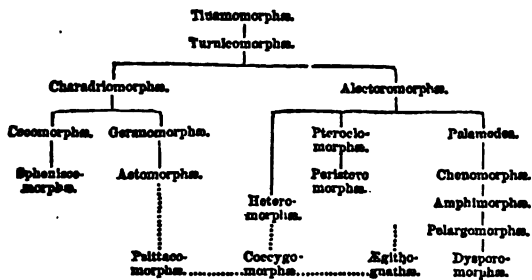

The above scheme, in Prof. Huxley's opinion, nearly represents the affinities of the various Carinate groups,—the great difficulty being to determine the relations to the rest of the *Coccygomorphia*, *Psittacomorphia*, and *Agithognathimorphia*, which he indicated "only in the most doubtful and hypothetical fashion." Almost simultaneously with this he expounded more particularly before the Zoological Society, in whose *Proceedings* (1868, pp. 294–319) his results were soon after published, the groups of which he believed the *Alectoromorphia* to be composed and the relations to them of some outlying forms usually regarded as Gallineous, the *Turnicidae* and *Pteroclididae*, as well as the singular HOACTZIS (vol. xii. p. 28), for all three of which he had to institute new groups—the last forming the sole representative of his *Heteromorphia*. More than this, he entered upon their Geographical Distribution, the facts of which important subject are here, almost for the first time, since the attempt of Blyth already mentioned,<sup>1</sup> brought to bear practically on Classification, as has been previously hinted (Birds, vol. iii. pp. 736, 737); but, that subject having been already treated at some length, there is no need to enter upon it here.

Nevertheless it is necessary to mention here the intimate connexion between Classification and Geographical Distribution as revealed by the palaeontological researches of Prof. ALPHONSE MILNE-EDWARDS, whose magnificent *Oiseaux Fossiles de la France* began to appear in 1867, and was completed in 1871—the more so, since the exigencies of his undertaking compelled him to use materials that had been almost wholly neglected by other investigators. A large proportion of the fossil remains the determination and description of which was his object were what are very commonly called the "long bones," that is to say, those of the limbs. The recognition of these, minute and fragmentary as many were, and the referring them to their proper place, rendered necessary an attentive study of the comparative osteology and myology of Birds in general, that of the "long bones," whose sole characters were often a few muscular ridges or depressions, being especially obligatory. Hence it became manifest that a very respectable Classification can be found in which characters drawn from these bones play a rather important part. Limited by circumstances as is that followed by M. Milne-Edwards, the details of his arrangement do not require setting forth here. It is enough to point out that we have in his work another proof of the multiplicity of the factors which must be taken into consideration by the systematist, and another proof of the fallacy of trusting to one set of characters alone. But this is not the only way in which the author has rendered service to the advanced student of Orni-

thology. The unlooked-for discovery in France of remains which he has referred to forms now existing it is true, but existing only in countries far removed from Europe, forms such as *Collocalia*, *Leptosomus*, *Psittacus*, *Serpentarius*, and *Trogon*, is perhaps even more suggestive than the finding that France was once inhabited by forms that are wholly extinct, of which, as has been already mentioned (Birds, vol. iii. pp. 730, 731), in the older formations there is abundance. Unfortunately none of these, however, can be compared for singularity with *Archaeopteryx* or with some American fossil forms next to be noticed, for their particular bearing on our knowledge of Ornithology will be most conveniently treated here.

In November 1870 Prof. MARSH, by finding the imperfect fossilized tibia of a Bird in the Middle Cretaceous shale of Kansas, began a series of wonderful discoveries which will ever be associated with his name,<sup>2</sup> and, making us acquainted with a great number of forms long since vanished from among the earth's inhabitants, has thrown a comparatively broad beam of light upon the darkness that, broken only by the solitary spark emitted on the recognition of *Archaeopteryx*, had hitherto brooded over our knowledge of the genealogy of Birds, and is even now for the most part palpable. Subsequent visits to the same part of North America, often performed under circumstances of discomfort and occasionally of danger, brought to this intrepid and energetic explorer the reward he had so fully earned. Brief notices of his spoils appeared from time to time in various volumes of the *American Journal of Science and Arts* (Silliman's), but it is unnecessary here to refer to more than a few of them. In that *Journal* for May 1872 (ser. 3, iii. p. 360) the remains of a large swimming Bird (nearly 6 feet in length, as afterwards appeared) having some affinity, it was thought, to the *Colymbidae* were described under the name of *Hesperornis regalis*, and a few months later (iv. p. 344) a second fossil Bird from the same locality was indicated as *Ichthyornis dispar*—from the Fish-like, biconcave form of its vertebrae. Further examination of the enormous collections gathered by the author, and preserved in the Museum of Yale College at New Haven in Connecticut, shewed him that this last Bird, and another to which he gave the name of *Apatornis*, had possessed well-developed teeth implanted in sockets in both jaws, and induced him to establish (v. pp. 161, 162) for their reception a "Subclass" *Odontornithes* and an Order *Ichthyornithes*. Two years more and the originally found *Hesperornis* was discovered also to have teeth, but these were inserted in a groove. It was accordingly regarded as the type of a distinct Order *Odontocera* (x. pp. 403–408), to which were assigned as other characters vertebrae of a saddle-shape and not biconcave, a keelless sternum, and wings consisting only of the humerus. In 1880 Prof. Marsh brought out a grand volume, *Odontornithes*, being a monograph of the extinct toothed Birds of North America. Herein remains, attributed to no fewer than a score of species, which were referred to eight different genera, are fully described and sufficiently illustrated, and, instead of the ordinal name *Ichthyornithes* previously used, that of *Odontornithes* was proposed. In the author's concluding summary he remarks on the fact that, while the *Odontocera*, as exhibited in *Hesperornis*, had teeth inserted in a continuous groove—a low and generalized character as shewn by Reptiles, they had, however, the strongly differentiated saddle-shaped vertebrae such as all modern Birds possess. On the other hand the *Odontornithes*, as exemplified in *Ichthyornis*, having the primitive biconcave vertebrae, yet possessed the highly

<sup>1</sup> It is true that from the time of Buffon, though he scorned any regular Classification, Geographical Distribution had been occasionally held to have something to do with systematic arrangement; but the way in which the two were related was never clearly put forth, though people who could read between the lines might have guessed the secret from Darwin's *Journal of Researches*, as well as from his introduction to the *Ecology of the "Beagle" Voyage*.

<sup>2</sup> It will of course be needless to remind the general zoologist of Prof. Marsh's no less wonderful discoveries of wholly unlooked-for types of Reptiles and Mammals.

specialized feature of teeth in distinct sockets. *Hesperornis* too, with its keelless sternum, had aborted wings but strong legs and feet adapted for swimming, while *Ichthyornis* had a keeled sternum and powerful wings, but diminutive legs and feet. These and other characters separate the two forms so widely as quite to justify the establishment of as many Orders for their reception, and the opposite nature of the evidence they afford illustrates one fundamental principle of evolution, namely, that an animal may attain to great development of one set of characters and at the same time retain other features of a low ancestral type. Prof. Marsh states that he had fully satisfied himself that *Archopteryx* belonged to the *Odontornithes*, which he thought it advisable for the present to regard as a Subclass, separated into three Orders—*Odontoptera*, *Odontotormes*, and *Saurura*—all well marked, but evidently not of equal rank, the last being clearly much more widely distinguished from the first two than they are from one another. But that these three oldest-known forms of Birds should differ so greatly from each other unmistakably points to a great antiquity for the Class. All are true Birds; but the Reptilian characters they possess converge towards a more generalized type. He then proceeds to treat of the characters which may be expected to have occurred in their common ancestor, whose remains may yet be hoped for from the Palæozoic rocks if not from the Permian beds that in North America are so rich in the fossils of a terrestrial fauna. Birds, he believes, branched off by a single stem, which gradually lost its Reptilian as it assumed the Ornithic type; and in the existing *Ratites* we have the survivors of this direct line. The lineal descendants of this primal stock doubtless at an early time attained feathers and warm blood, but, in his opinion, never acquired the power of flight, which probably originated among the small arboreal forms of Reptilian Birds. In them even rudimentary feathers on the fore-limbs would be an advantage, as they would tend to lengthen a leap from branch to branch, or break the force of a fall in leaping to the ground. As the feathers increased, the body would become warmer and the blood more active. With still more feathers would come increased power of flight as we see in the young Birds of to-day. A greater activity would result in a more perfect circulation. A true Bird would doubtless require warm blood, but would not necessarily be hot-blooded, like the Birds now living. Whether *Archopteryx* was on the true Carinate line cannot as yet be determined, and this is also true of *Ichthyornis*; but the biconcave vertebra of the latter suggest its being an early offshoot, while it is probable that *Hesperornis* came off from the main "Struthious" stem and has left no descendants.

Bold as are the speculations above summarized, there seems no reason to doubt the probability of their turning out to be, if not the exact truth, yet something very like it.

From this bright vision of the poetic past—a glimpse, some may call it, into the land of dreams—we must relapse into a sober contemplation of the prosaic present—a subject quite as difficult to understand. The former efforts at classification made by Sundevall have already several times been mentioned, and a return to their consideration was promised. In 1872 and 1873 he brought out at Stockholm a *Methodi Naturalis Avium Dispositionis Tentamen*, two portions of which (those relating to the Diurnal Birds-of-Prey and the "*Cichlomorphæ*," or forms related to the Thrushes) he found himself under the necessity of revising and modifying in the course of 1874, in as many communications to the Swedish Academy of Sciences (*K. V.-Ak. Förhandlingar*, 1874, No. 2, pp. 21-30; No. 3, pp. 27-30). This *Tentamen*, containing the

latest complete method of classifying Birds in general, has naturally received much attention, the more so perhaps, since, with its appendices, it was nearly the last labour of its respected author, whose industrious life came to an end in the course of the following year. From what has before been said of his works it may have been gathered that, while professedly basing his systematic arrangement of the groups of Birds on their external features, he had hitherto striven to make his schemes harmonize if possible with the dictates of internal structure as evinced by the sciences of anatomy, though he uniformly and persistently protested against the inside being better than the outside. In thus acting he proved himself a true follower of his great countryman Linnæus; but, without disparagement of his efforts in this respect, it must be said that when internal and external characters appeared to be in conflict he gave, perhaps with unconscious bias, a preference to the latter, for he belonged to a school of zoologists whose natural instinct was to believe that such a conflict always existed. Hence his efforts, praiseworthy as they were from several points of view, and particularly so in regard to some details, failed to satisfy the philosophic taxonomer when generalizations and deeper principles were concerned, and in his practice in respect of certain technicalities of classification he was, in the eyes of the orthodox, a transgressor. Thus instead of contenting himself with terms that had met with pretty general approval, such as Class, Subclass, Order, Suborder, Family, Subfamily, and so on, he introduced into his final scheme other designations, "Agmen," "Cohors," "Phalanx," and the like, which to the ordinary student of Ornithology convey an indefinite meaning, if any meaning at all. He also carried to a very extreme limit his views of nomenclature, which were certainly not in accordance with those held by most zoologists, though this is a matter so trifling as to need no details in illustration. It is by no means easy to set forth briefly, and at the same time intelligibly, to any but experts, the final scheme of Sundevall, owing to the number of new names introduced by him, nevertheless the attempt must be made; but it must be understood that in the following paradigm, in which his later modifications are incorporated, only the most remarkable or best-known forms are cited as examples of his several groups, for to give the whole of them would, if any explanations were added, occupy far more space than the occasion seems to justify, and without such explanations the list would be of use only to experts, who would rather consult the original work.

First, Sundevall would still make two grand divisions ("Agmina") of Birds, even as had been done nearly forty years before; but, having found that the names *Altrices* and *Præcoces*, he had formerly used were not always applicable, as the groups thereby indicated naturally disposed, he at first distinguished them as *Psilopædes* and *Philopædes*. Then, seeing that the great similarity of these two words would produce confusion both in speaking and writing, he changed them (p. 168) into the equivalent *Gymnopædes* and *Dasympædes*, according as the young were hatched naked or clothed. The *Gymnopædes* are divided into two "Orders"—*Oscines* and *Volucres*—the former intended to be identical with the group of the same name established by older authors, and, in accordance with the observations of Keysorling and Blasius already mentioned, divided into two "Series"—*Laminiplantares*, having the hinder part of the "tarsus" covered with two horny plates, and *Scutelliplantares*, in which the same part is scutellated. These *Laminiplantares* are composed of six Cohorts as follows:—

Cohors 1. *Oichlomorphæ*.

Phalanx 1. *Oscines*.—7 Families: the Nightingales standing first, and therefore at the head of all Birds, with the Redbreast, Redstart, and the American Blue-bird; after them the Chats,

Thrushes proper, Dippers, Water-Chats (*Hemicircus*), Bush-Chats, and (under the name of *Euchlinae*) the singular group commonly known as Pittas or Water-Thrushes.

Phalanx 2. *Novempennatae*.—6 Families: Pipits, Wagtails, American Fly-catching Warblers, and Australian Diamond-birds (*Paralotus*).

Phalanx 3. *Sylviiformes*.—17 Families: divided geographically (7) into two groups—the Old-World forms, and those of the New. The first is further broken up into three sections—(a) 4 Families with moderately long wings and a slender bill, containing what may be called perhaps the normal Warblers, as the Willow-Wren, Whitthroats, Sedge-birds, and others; (b) 5 Families, with short wings and a slender bill, what are often called by Indian and African writers Bush-babblers (*Bradypterus*, *Crateropus*, and others); (c) 3 Families, with a somewhat stout or blunt bill, the Thick-heads of some writers (*Pachycephalus*) and Titmouse Family. The second or American group comprehends 5 Families, Vireos, Cat-birds, Wrens (not, by the way, peculiar to America), and some other forms for which it is impossible to find names that will pass as English.

Phalanx 4. *Brachyptera*.—3 Families: the short-winged Wren-Warblers, with long tails, of the Australian (*Maturus*), Indian, and Ethiopian Regions.

Phalanx 5. *Leucirostres*.—7 Families: the true Flycatchers (*Muscicapæ*), and several others of fly-catching habits.

Phalanx 6. *Brachypodes*.—8 Families: Waxwings, Orioles, Swallow-Flycatchers (*Artamus*), Caterpillar-catchers (*Campophaga*), and Drongos (*Dicurus*).

Phalanx 7. *Dentirostres* or *Laniformes*.—3 Families: Shrikes, Puff-backed Shrikes.

Phalanx 8. *Subcorviformes*.—1 Family: Bower-birds and some others.

Cohors 2. *Centrostræa*.

Phalanx 1. *Decempennatae*.—3 Families: Weaver-birds (*Ploceus*), Whydah-birds (*Vidua*), and Hedge-Sparrows (*Accator*).

Phalanx 2. *Anplipalatales*.—2 Families: Grosbeaks, true Finches.

Phalanx 3. *Arctipalatales*.—6 Families: Crossbills, Buntings, Rice-birds, and many hard-billed forms which are usually placed among the Tanagers.

Phalanx 4. *Simpleirostres*.—4 Families: Tanagers.

Cohors 3. *Coliionompha*.

Phalanx 1. *Novempennatae*.—3 Families: Grackles or American Starlings.

Phalanx 2. *Humilinaræ*.—4 Families: True Starlings, Oxpeckers, Choughs.

Phalanx 3. *Altinareæ*.—3 Families: Nutcrackers, Jays, Crows.

Phalanx 4. *Idiodactylæ*.—5 Families: Crow-Shrikes, Birds-of-Paradise.

Cohors 4. *Certhionompha*.—3 Families: Tree-creepers, Nuthatches.

Cohors 5. *Cinnyrimorpha*.—5 Families: Sun-birds, Honey-suckers.

Cohors 6. *Chelidonompha*.—1 Family: Swallows.

The *Scutellipiantares* include a much smaller number of forms, and, with the exception of the first "Cohort" and a few groups of the fourth and fifth, all are peculiar to America.

Cohors 1. *Holaspidae*.—2 Families: Larks, Hoopoes.

Cohors 2. *Endaspidae*.—3 Families—all Neotropical: Oven-birds (*Furnarius*), *Synallaxis*, and the Piculules (*Dendrocolaptes*).

Cohors 3. *Exaspidae*.—4 Families: the first two separated as *Lysodactylæ*, including the King-birds or Tyrants, of which twelve groups are made; the remaining two as *Syndactylæ*, composed of the Todies and Manakins.

Cohors 4. *Pycnaspidae*.—3 Families: Cocks-of-the-Rock (*Rupicola*), to which the Indian genus *Calyptonna*, *Eurylasmus*, and some others are supposed to be allied, the Chatterers and Fruit-Crows (*Chasmorhynchus*, *Cephalopterus*, and others), as well as *Tityra* and *Lipaugus*.

Cohors 5. *Taxaspidae*.—5 Families: the very singular Madagascar form *Philepitta*; the Bush-Shrikes (*Thamnophilus*), Ant-Thrushes (*Formicarius*), and Tapaculos (*Pteroptochus*) of the Neotropical Region; and the Australian Lyre-bird.

We then arrive at the Second Order *Volucres*, which is divided into two "Series." Of these the first is made to contain, under the name *Zygodactylæ*,

Cohors 1. *Psittacæ*.—6 Families: Parrots;

Cohors 2. *Picæ*.—6 Families: Woodpeckers, Piculets (*Picumnus*), and Wrynecks;

Cohors 3. *Coccygæ*.—12 Families: divided into two groups—(1) *Altinareæ*, containing the Honey-Guides, Barbets, Toucans, Jacamars, Puff-birds, and the Madagascar genus *Leptosomus*; and (2) *Humilinaræ*, comprising all the forms commonly known as *Cuculidæ*, broken up, however, into three sections;

while to the second "Series" are referred, as *Anisodactylæ*,

Cohors 4. *Camomorpha*.—4 Families: Plantain-eaters or Tournesons, Mouse-birds, Rollers, and the peculiar Madagascar forms *Atolornis* and *Brachyptera*;

Cohors 5. *Ampligularæ*.—4 Families: Trogons, Goatsuckers, and Swifts;

Cohors 6. *Longilingus* or *Mellisuga*.—12 Families: Humming-birds, arranged in three "Series;"

Cohors 7. *Syndactylæ*.—4 Families: Bee-eaters, Motmots, Kingfishers, and Hornbills;

Cohors 8. *Foristeroides*.—3 Families: *Didunculus*, with the Dodo, Pigeons, and the Crowned Pigeons (*Goura*) separated from the last.

The *Dasyppades* of Sundevall are separated into six "Orders"; but these will occupy us but a short while.

The first of them, *Accipitres*, comprehending all the Birds-of-Prey, were separated into 4 "Cohorts" in his original work, but these were reduced in his appendix to two—

*Nyctarpages* or Owls with 4 Families divided into 2 series, and *Hemerocharypages* containing all the rest, and comprising 10 Families (the last of which is the *Serioma*,

*Dicholophus*) divided into 2 groups as *Rapaces* and *Saprophagi*—the latter including the Vultures. Next stands the Order *Gallinæ* with 4 "Cohorts":—(1) *Tetraomorpha*, comprising 2 Families, the Sand-Grouse (*Pterocetes*) and the Grouse proper, among which the Central-American *Oreophasis* finds itself; (2) *Phasianomorpha*, with 4 Families, Pheasants, Peacocks, Turkeys, Guinea Fowls, Partridges, Quails, and Hemipodes (*Turnix*); (3) *Micronyctes*, the Megapodes, with 2 Families; (4) the *Duodecimpennatae*, the Curassows and Guans, also with 2 Families; (5) the *Struthioniformes*, composed of the Tinamous; and (6) the *Subgrallatores* with 2 Families, one consisting of the curious South-American genera *Thinocorus* and *Attagis* and the other of the Sheathbill (*Chionis*).

The Fifth Order (the third of the *Dasyppades*) is formed by the *Grallatores*, divided into 2 "series"—(1) *Altinareæ*, consisting of 2 "Cohorts," *Herodias* with 1 Family, the Herons, and *Pelargi* with 4 Families, Spoonbills, Ibises, Storks, and the Umbre (*Scopus*), with *Balaniceps*; (2) *Humilinaræ*, also consisting of 2 "Cohorts," *Limicola* with 2 Families, Sandpipers and Snipes, Stilts and Avocets, and *Cursores* with 8 Families, including Plovers, Bustards, Cranes, Rails, and all the other "Waders." The Sixth Order, *Natatores*, consists of all the Birds that habitually swim and a few that do not, containing 6 Cohorts:—

*Longipennes* and *Pygopodes* with 3 Families each; *Totipalmata* with 1 Family; *Tubinareæ* with 3 Families; *Impennes* with 1 Family, Penguins; and *Lamelliostres* with 2 Families, Flamingoes and Ducks. The Seventh Order, *Proceræ*, is divided into 2 Cohorts—*Veri* with 2 Families, Ostriches and Emews; and *Subnobiles*, consisting of the genus *Apteryx*. The Eighth Order is formed by the *Saurura*.

Such then is Sundevall's perfected system, which has in various quarters been so much praised, and has been partially recognized by so many succeeding writers, that it would have been impossible to pass it over here, though the present writer is confident that the best-informed ornithologists will agree with him in thinking that the compilation of the above abstract has been but so much waste of time, and its insertion here but so much waste of space. Without, however, some such abstract its shortcomings could not be made apparent, and it will be seen to what little purpose so many able men have laboured if arrangement and grouping so manifestly artificial—the latter often of forms possessing no real affinity—can pass as a natural method. We should be too sanguine to hope that it may be the last of its kind, yet any one accustomed to look deeper than the surface must see its numerous defects, and almost every one, whether so accustomed or not, ought by its means to be brought to the conclusion that, when a man of Sundevall's knowledge and experience



could not, by trusting only to external characters, do better than this, the most convincing proof is afforded of the inability of external characters alone to produce anything save ataxy. The principal merits it possesses are confined to the minor arrangement of some of the *Oscines*; but even here many of the alliances, such, for instance, as that of *Pitta* with the true Thrushes, are indefensible on any rational grounds, and some, as that of *Accipiter* with the Weaver-birds and Whydah-birds, verge upon the ridiculous, while on the other hand the interpolation of the American Fly-catching Warblers, *Mniotiltia*, between the normal Warblers of the Old World and the Thrushes is absurd—especially when the genus *Mniotiltia* is placed, notwithstanding its different wing-formula, with the Tree-creepers, *Certhiidae*. The whole work unfortunately betrays throughout an utter want of the sense of proportion. In many of the large groups the effect of very slight differences is to keep the forms exhibiting them widely apart, while in most of the smaller groups differences of far greater kind are overlooked, so that the forms which present them are linked together in more or less close union. Thus, regarding only external characters, great as is the structural distinction between the Gannets, Cormorants, Frigate-birds, and Pelicans, it is not held to remove them from the limits of a single Family; and yet the Thrushes and the Chats, whose distinctions are barely sensible, are placed in separate Families, as are also the Chats and the Nightingales, wherein no structural distinctions at all can be traced. Again, even in one and the same group the equalization of characters indicative of Families is wholly neglected. Thus among the Pigeons the genera *Didus* and *Didunculus*, which differ, so far as we know it, in every external character of their structure, are placed in one Family, and yet on the slightest pretext the genus *Goura*, which in all respects so intimately resembles ordinary Pigeons, is set apart as the representative of a distinct Family. The only use of dwelling upon these imperfections here is the hope that thereby students of Ornithology may be induced to abandon the belief in the efficacy of external characters as a sole means of classification, and, by seeing how unmanageable they become unless checked by internal characters, be persuaded of the futility of any attempt to form an arrangement without that solid foundation which can only be obtained by a knowledge of anatomy. Where Sundevall failed no one else is likely to succeed; for he was a man gifted with intelligence of a rare order, a man of cultivation and learning, one who had devoted his whole life to science, who had travelled much, studied much and reflected much, a man whose acquaintance with the literature of his subject probably exceeded that of any of his contemporaries, and a man whose linguistic attainments rendered him the envy of his many friends. Yet what should have been the crowning work of his long life is one that all who respected him, and that comprehends all who knew him, must regret.

Of the very opposite kind was the work of the two men next to be mentioned—GARROD and FORBES—both cut short in a career of promise<sup>1</sup> that among students of Ornithology has rarely been equalled and perhaps never surpassed. The present writer finds it difficult to treat of the labours of two pupils and friends from whose assistance he had originally hoped to profit in the preparation of this very article, the more so that, while fully recognizing the brilliant nature of some of their researches, he is compelled very frequently to dissent from the conclusions at which

they arrived, deeming them to have often been of a kind that, had their authors survived to a maturer age, they would have greatly modified. Still he well knows that learners are mostly wiser than their teachers; and, making due allowance for the haste with which, from the exigencies of the post they successively held, their investigations had usually to be published, he believes that much of the highest value underlies even the crudest conjectures contained in their several contributions to Ornithology. Putting aside the monographical papers by which each of them followed the excellent example set by their predecessor in the office they filled—Dr MURIE<sup>2</sup>—and beginning with Garrod's,<sup>3</sup> those having a more general scope, all published in the Zoological Society's *Proceedings*, may be briefly considered. Starting from the level reached by Prof. Huxley, the first attempt made by the younger investigator was in 1873, "On the value in Classification of a Peculiarity in the anterior margin of the Nasal Bones in certain Birds." Herein he strove to prove that Birds ought to be divided into two Subclasses—one, called "Holorhinal," in which a straight line drawn transversely across the hindmost points of the external nasal apertures passes in front of the posterior ends of the nasal processes of the premaxilla, and the other, called "Schizorhinal," in which such a line passes behind those processes. If this be used as a criterion, the validity of Prof. Huxley's group *Schioznathes* is shaken; but there is no need to enlarge upon the proposal, for it was virtually abandoned by its author within little more than a twelvemonth. The next subject in connexion with Systematic Ornithology to which Garrod applied himself was an investigation of the Carotid Arteries, and here, in the same year, he made a considerable advance upon the labours of Nitzsch, as might well be expected, for the opportunities of the latter were very limited, and he was only able, as we have seen (page 22), to adduce four types of structure in them, while Garrod, with the superior advantages of his situation, raised the number to six. Nevertheless he remarks that their "disposition has not much significance among Birds, there being many Families in which, whilst the majority of the species have two, some have only one carotid." The exceptional cases cited by him are quite sufficient to prove that the condition of this artery has nearly no value from the point of view of general classification. If relied upon it would split up the Families *Bucerotidae* and *Cypselidae*, which no sane person would doubt to be homogeneous and natural. The femoral vessels formed another subject of investigation, and were found to exhibit as much exceptional conformation as those of the neck—for instance in *Centropus phasianus*, one of the Birds known as Coucals, the femoral artery accompanies the femoral vein, though it does not do so in another species of the genus, *C. rufipennis*, nor in any other of the *Cuculidae* (to which Family the genus *Centropus* has been always assigned) examined by Garrod. Nor are the results of the very great labour which he bestowed upon the muscular conformation of the thigh in Birds any more conclusive when they come to be impartially and carefully considered. Myology was with him always a favourite study, and he

<sup>2</sup> Dr Murie's chief papers having a direct bearing on Systematic Ornithology are:—in the Zoological Society's *Transactions* (vii. p. 405), "On the Dermal and Visceral Structures of the Kagu, Sun-Bittern, and Boatbill"; in the same Society's *Proceedings*—(1871, p. 647) "Additional Notice concerning the Powder-Downs of *Rhinocetus jubatus*," (1872, p. 664) "On the Skeleton of *Todus* with remarks as to its Allies," (1879, p. 552) "On the Skeleton and Lineage of *Fregilupus varius*," in *The Ibis*—(1872, p. 262) "On the genus *Colinus*," (1872, p. 383) "Motmots and their affinities," (1873, p. 181) "Relationships of the *Upupidae*."

<sup>3</sup> Garrod's *Scientific Papers* have been collected and published in a memorial volume, edited by Forbes. There is therefore no need to give a list of them here. Forbes's papers are to be edited by Prof. F. J. Bell.

<sup>1</sup> Alfred Henry Garrod, Prosecutor to the Zoological Society of London, died of consumption in 1879, aged thirty-three. His successor in that office, William Alexander Forbes, fell a victim to the deadly climate of the Niger in 1883, and in his twenty-eighth year.



may be not unreasonably supposed to have a strong feeling as to its efficacy for systematic ends. It was in favour of an arrangement based upon the muscles of the thigh, and elaborated by him in 1874, that he gave up the arrangement he had published barely more than a year before based upon the conformation of the nostrils. Nevertheless it appears that even the later of the two methods did not eventually content him, and this was only to be expected, though he is said by Forbes (*Ibis*, 1881, p. 28) to have remained "satisfied to the last as to the naturalness of the two main groups into which he there divided birds"—*Homologonata* and *Anomalogonata*. The key to this arrangement lay in the presence or absence of the *ambiens* muscle, "not because of its own intrinsic importance, but because its presence is always associated with peculiarities in other parts never found in any Anomalogonatus bird." Garrod thought that so great was the improbability of the same combination of three or four different characters (such as an accessory femoro-caudal muscle, a tufted oil-gland, and cæca) arising independently in different Birds that similar combinations of characters could only be due to blood-relationship. The ingenuity with which he found and expressed these combinations of characters is worthy of all praise; the regret is that time was wanting for him to think out all their consequences, and that he did not take also into account other and especially osteological characters. Every osteologist must recognize that the neglect of these makes Garrod's proposed classification as unnatural as any that had been previously drawn up, and more unnatural than many. So much is this the case that, with the knowledge we have that ere his death he had already seen the need of introducing some modifications into it, its reproduction here, even in the briefest abstract possible, would not be advisable. Two instances, however, of its failure to shew natural affinities or differences may be cited. The first Order *Galliformes* of his Subclass *Homalogonata* is made to consist of three "Cohorts"—*Struthiones*, *Gallinaceæ*, and *Pittaci*—a somewhat astonishing alliance; but even if that be allowed to pass, we find the second "Cohort" composed of the Families *Palamedeidae*, *Gallinæ*, *Rallidae*, *Otididae* (containing two Subfamilies, the Bustards and the Flamingoes), *Musophagidae*, and *Cuculidae*. Again the Subclass *Anomalogonata* includes three Orders—*Piciformes*, *Passeriformes*, and *Cypseliformes*—a preliminary to which at first sight no exception need be taken; but immediately we look into details we find the *Alcedinidae* placed in the first Order and the *Meropidae* in the second, together with the *Passeres* and a collection of Families almost every feature in the skeleton of which points to a separation. Common sense revolts at the acceptance of any scheme which involves so many manifest incongruities. With far greater pleasure we would leave these investigations, and those on certain other muscles, as well as on the Disposition of the deep plantar Tendons, and dwell upon his researches into the anatomy of the Passerine Birds with the view to their systematic arrangement. Here he was on much safer ground, and it can hardly be doubted that his labours will stand the test of future experience, for, though it may be that all his views will not meet with ultimate approval, he certainly made the greatest advance since the days of Müller, to the English translation of whose classical work he added (as already mentioned) an excellent appendix, besides having already contributed to the *Zoological Proceedings* between 1876 and 1878 four memoirs replete with observed facts which no one can gainsay. As his labours were continued exactly on the same lines by Forbes, who, between 1880 and 1883, published in the same journal six more memoirs on the subject, it will be convenient here to state generally, and

in a combined form, the results arrived at by these two investigators.

Instead of the divisions of Passerine Birds instituted by Müller, Garrod and Forbes having a wider range of experience consider that they have shown that the *Passeres* consist of two primary sections, which the latter named respectively *Desmoductyli* and *Eleutheroductyli*, from the facts discovered by the former that in the *Eurylamidae*, or Broadbills, a small Family peculiar to some parts of the Indian Region, and consisting of some nine or ten species only, there is a strong band joining the muscles of the hind toe exactly in the same way as in many Families that are not Passerine, and hence the name *Desmoductyli*, while in all other Passerines the hind toe is free. This point settled, the *Eleutheroductyli* form two great divisions, according to the structure of their vocal organs; one of them, roughly agreeing with the *Clamatores* of some writers, is called *Mesomyodi*, and the other, corresponding in the main, if not absolutely, with the *Oscines*, *Polymyodi*, or true *Passeres* of various authors, is named *Acromyodi*—"an Acromyodian bird being one in which the muscles of the syrinx are attached to the extremities of the bronchial semi-rings, a Mesomyodian bird being one in which the muscles of the syrinx join the semi-rings in their middle." Furthermore, each of these groups is subdivided into two: the *Acromyodi* into "normal" and "abnormal," of which more presently; the *Mesomyodi* into *Homocomeri* and *Heteromeri*, according as the sciatic or the femoral artery of the thigh is developed—the former being the usual arrangement among Birds and the latter the exceptional. Under the head *Heteromeri* come only two Families the *Cotingidae* (Chatterers) and *Pipridæ* (MANAKINS, vol. xv. p. 455) of most ornithologists, but these Garrod was inclined to think should not be considered distinct. The *Homocomeri* form a larger group, and are at once separable, on account of the structure of their vocal organs, into *Tracheophona* (practically equivalent to the *Tracheophones* of Müller) and *Haplophona* (as Garrod named them)—the last being those *Passeres* which were by Müller erroneously included among his *Picariæ*, namely, the *Tyrannidae* (see KING-BIRD, vol. xiv. p. 80) with *Rupicola*, the Cocks-of-the-Rock. To these are now added Families not examined by him,—but subsequently ascertained by Forbes to belong to the same group,—*Pittidae*, *Philepittidae*, and *Xenicidae* (more properly perhaps to be called *Acanthisittidae*), and it is remarkable that these last three Families are the only members of the *Mesomyodi* which are not peculiar to the New World—nay more, if we except the *Tyrannidae*, which in North America occur chiefly as migrants,—not peculiar to the Neotropical Region. The *Tracheophona* are held to contain five Families—*Furnariidae* (Oven-birds), *Pteroptochidae* (TAPACULOS, *q.v.*), *Dendrocolaptidae* (Piculules), *Conopophagidae*, and *Formicariidae* (Ant-Thrushes). Returning now to the *Acromyodi*, which include, it has just been said, a normal and an abnormal section, the latter consists of birds agreeing in the main, though not absolutely, as to the structure of the syrinx with that of the former, yet differing so considerably in their osteology as to be most justifiably separated. At present only two types of these abnormal *Acromyodi* are known—*Menura* (the LYRE-BIRD, vol. xv. p. 115) and *Atrichia* (the SCRUB-BIRD, *q.v.*), both from Australia, while all the remaining *Passeres*, that is to say, incomparably the greater number of Birds in general, belong to the normal section. Thus the whole scheme of the *Passeres*,<sup>1</sup> as worked out by Garrod and Forbes, can be

<sup>1</sup> It is right to observe that this scheme was not a little aided by a consideration of palatal characters, as well as from the disposition of some of the tendons of the wing-muscles.

briefly expressed as below; and this expression, so far as it goes, is probably very near the truth, though for simplicity's sake some of the intermediate group-names might perhaps be omitted:—

**PASSERINES,**

**ELEUTHERODACTYLI,**

**ACROMYODI,**

**NORMALES,**

**ABNORMALES, *Meura, Atrickia.***

**MESOMYODI,**

**HOMOMERII,**

**Tracheophona,**

*Furnariida, Pteroptochida, Dendrocolaptida, Conop-*  
*phagida, Formicariida.*

**Hajuloophona,**

*Tyrannida, Rupicola, Pittida, Phileptitida, Xenicida.*

**HETEROMERII, Cotingida, Piprida.**

**DESMODACTYLI,**

*Eurylamida.*

It will be seen that no attempt is here made to separate the Normal Acromyodians into Families. Already, in *The Ibis* for 1874 (pp. 406-416), Mr WALLACE had published a plan, which, with two slight modifications that were manifestly improvements, he employed two years later in his great work on *The Geographical Distribution of Animals*, and this included a method of arranging the Families of this division. Being based, however, wholly on alar characters, it has of course a great similarity to the schemes of Dr Cabanis and of Sundevall, and, though simpler than either of those, there is no need here to enter much into its details. The Birds which would fall under the category of Garrod's *Acromyodi normales* are grouped in three series:—A. "Typical or Turdoid *Passeres*," having a wing with ten primaries, the first of which is always more or less markedly reduced in size, and to this 21 Families are allotted; B. "*Tanagroid Passeres*," having a wing with nine primaries, the first of which is fully developed and usually very long, and containing 10 Families; and C. "*Sturnoid Passeres*," having a wing with ten primaries, the first of which is "rudimentary," with only 4 Families. The remaining Families, 10 in number, which are not normally acromyodian are grouped as Series D. and called "*Formicarioid Passeres*."

In *The Ibis* for 1880 (pp. 340-350, 399-411) Mr SCLATER made a laudable attempt at a general arrangement of Birds,<sup>1</sup> trying to harmonize the views of ornithologists with those taken by the ornithologists who only study the exterior; but, as he explained, his scheme is really that of Prof. Huxley reversed, with some slight modifications mostly consequent on the recent researches of Prof. Parker and of Garrod, and (he might have added) a few details derived from his own extensive knowledge of the Class. Adopting the two Subclasses *Carinatae* and *Ratita*, he recognized 3 "Orders" as forming the latter and 23 the former—a number far exceeding any that had of late years met with the approval of ornithologists. It is certainly difficult in the present state of our knowledge to get on with much fewer groups; whether we call them "Orders" or not is immaterial. First of them comes the *Passeres*, of which Mr Sclater would make four Suborders:—(1) the *Acromyodi normales* of Garrod under the older name of *Oscines*, to the further subdivision of which we must immediately return; (2) under Prof. Huxley's term *Oligomyodi*, all the *Haplophona*, *Heteromeri*, and *Desmodactyli* of Garrod, comprehending 8 Families—*Oxyrhamphida*,<sup>2</sup> *Tyrannida*, *Piprida*, *Cotingida*, *Phytotomida*,<sup>3</sup> *Pitida*, *Phileptitida*, and *Eurylamida*; (3) *Tracheophona*,

containing the same groups as in the older scheme, but here combined into 3 Families only—*Dendrocolaptida*, *Formicariida*, and *Pteroptochida*; and (4) the *Acromyodi abnormales* of Garrod, now elevated to the rank of a Suborder and called *Parudoecinae*.<sup>4</sup> With regard to the *Acromyodi normales* or *Oscines*, Mr Sclater takes what seems to be quite the most reasonable view, when he states that they "are all very closely related to one another, and, in reality, form little more than one group, equivalent to other so-called families of birds," going on to remark that as there are some 4700 known species of them "it is absolutely necessary to subdivide them," and finally proceeding to do this nearly on the method of Sundevall's *Tentamen* (see above pp. 37, 38), merely changing the names and position of the groups in accordance with a plan of his own set forth in the *Nomenclator Avium Neotropicalium*, which he and Mr Salvin printed in 1873, making, as did Sundevall, two divisions (according as the hind part of the "tarsus" is plated or scaled), A. *Laminiplantares* and B. *Scutiplantares*—but confining the latter to the *Alaudida* alone, since the other Families forming Sundevall's *Scutiplantares* are not Oscinian, nor all even Passerine. The following table shows the comparative result of the two modes as regards the *Laminiplantares*, and, since the composition of the Swedish author's groups was explained at some length, may be found convenient by the reader:—

*Mr Sclater, 1880.*

1. Dentirotres, "
2. Latirotres, "
3. Curvirotres, "
4. Tenuirotres, "
5. Conirotres, "
6. Cultrirotres, "

*Sundevall, 1872-73.*

1. Cichlomorphæ.
6. Chelidonomorphæ.
4. Certhiomorphæ.
5. Cinnyrmorphæ.
2. Conirotres.
3. Collomorphæ.

These six groups Mr Sclater thinks may be separated without much difficulty, though on that point the proceedings of some later writers (a notable instance of which he himself cites) shew that doubt may still be entertained; but he rightly remarks that, "when we come to attempt to subdivide them, there is room for endless varieties of opinion as to the nearest allies of many of the forms," and into further details he does not go. It will be perceived that, like so many of his predecessors, he accords the highest rank to the *Dentirotres*, which, as has before been hinted, seems to be a mistaken view that must be considered in the sequel.

Leaving the *Passeres*, the next "Order" is *Picaria*, of which Mr Sclater proposes to make six Suborders:—(1) *Pici*, the Woodpeckers, with 2 Families; (2) *Cypseli*, with 3 Families,<sup>5</sup> practically equal to the *Macrochires* of Nitzsch; (3) *Anisodactyla*, with 12 Families—*Coliida* (MOUSE-BIRD, vol. xvii. p. 6), *Alcedinida* (KINGFISHER, vol. xiv. p. 81), *Bucconida* (HORNBILL, vol. xii. p. 169), *Upupida* (HOOPOE, vol. xii. p. 154), *Irrisorida*, *Meropida*, *Momotida* (MOTMOT, vol. xvii. p. 3), *Todida* (TODY, *q.v.*), *Coraciida* (ROLLER, *q.v.*), *Leptocornida*, *Podargida*, and *Steatornithida* (GUACHARO, vol. xi. p. 227); (4) *Heterodactyla*, consisting only of the TROGONS (*q.v.*); (5) *Zygodactyla* with 5 Families, *Galbulida* (JACAMAR, vol. xiii. p. 531), *Buconida* (PUFF-BIRD, *q.v.*), *Rhamphastida* (TOUCAN, *q.v.*), *Capitonida*, and *Indicatorida* (HONEY-GUIDE, vol. xii. p. 139); and (6) *Coccygæ*, composed of the two Families *Cuculida* and *Mucophagida*. That all these may be most conveniently

<sup>4</sup> A term unhappily of hybrid origin, and therefore one to which purists may take exception.

<sup>5</sup> These are not equivalent to Sundevall's groups of the same names.

<sup>6</sup> Mr Sclater (p. 248) inadvertently states that no species of Sundevall's *Certhiomorphæ* is found in the New World, having omitted to notice that in the *Tentamen* (pp. 46, 47) the genera *Mastitta* (peculiar to America) as well as *Certhis* and *Sitta* are therein placed.

<sup>7</sup> Or 2 only, the position of the *Cypripulgida* being left undecided, but in 1883 (see next note) put here.

<sup>1</sup> An abstract of this was read to the British Association at Swansea in the same year, and may be found in its *Report* (pp. 606-609).

<sup>2</sup> Not recognized by Garrod.

<sup>3</sup> To these Mr Sclater would now doubtless add Forbes's *Xenicida*.

associated under the name *Picaris* seems likely enough, and the first two "Suborders" are probably natural groups, though possibly groups of different value. In regard to the rest comment is for the present deferred. The *Psittaci*, *Striges*, and *Accipitres*, containing respectively the PARROTS (*q.v.*), OWLS (*q.v.*), and diurnal Birds-of-Prey, form the next three "Orders"—the last being held to include 3 Families, *Falconidae*, *Cathartidae*, and *Serpentariidae*, which is perhaps the best that can be done with them—the difficult question as to the position of *Cariama* (SERIEMA, *q.v.*) being decided against the admission of that form to the last Family, notwithstanding its remarkable resemblance to *Serpentarius* (SECRETARY-BIRD, *q.v.*). We have then the *Steganopodes* to make the Sixth "Order," consisting of the 5 Families usually grouped together as by Brandt (*supra*, p. 25) and others, and these are followed naturally enough by the HERONS (vol. xi. p. 760) under the name of *Herodiones*, to which the 3 Families *Ardeidae*, *Ciconiidae* (STORK, *q.v.*), and *Plataleidae* (SPONBILL, *q.v.*) are referred; but the FLAMINGOES (vol. ix. p. 286), under Prof. Huxley's title *Odontoglossæ*, form a distinct "Order." The Ninth "Order" is now erected for the *Palamedes* (SCREAMER, *q.v.*), which precede the *Anseres*—a group that, disencumbered from both the last two, is eminently natural, and easily dealt with. A great break then occurs, and the new series is opened by the Eleventh "Order," *Columbæ*, with 3 Families, *Carpophagidae*, *Columbidae*, and *Gouridae*, "or perhaps a fourth," *Didunculidae*,<sup>1</sup>—the DODOS (vol. vii. p. 321) being "held to belong to quite a separate section of the order." The Twelfth "Order" is formed by the *Pterocletes*, the Sand-Grouse; and then we have the very natural group *Gallinæ* ranking as the Thirteenth. The next two are the *Opiathocomi* and *Hemipodii* for the HOACTZIN (vol. xii. p. 88) and the *Turnicidae* (often known as Button-Quails) respectively, to which follow as Sixteenth and Seventeenth the *Fulicariæ* and *Alectorides*—the former consisting of the Families *Rallidae* (RAIL, *q.v.*) and *Heliornithidae*, and the latter of what seems to be a very heterogeneous compound of 6 Families—*Aramidae*, *Eurypygidæ* (SUN BITTERN, *q.v.*), *Gruvidæ* (CRANE, vol. vi. p. 546), *Psopiidae* (TRUMPETER, *q.v.*), *Cariamidae* (SERIEMA, *q.v.*), and *Otididae*,<sup>2</sup> (BUSTARD, vol. iv. p. 578). It is confessedly very puzzling to know how these varied types, or some of them at least, should be classed; but they need for the establishment of this group, and especially the insertion in it of certain forms, is not explained by the author. Then we have "Orders" Eighteen and Nineteen, the *Limicolæ*, with 6 Families, and *Gaviæ*, consisting only of *Laridæ* (GULL, vol. xi. p. 274), which taken in their simplest condition do not present much difficulty. The last are followed by *Tubinæræ*, the PETRELS (*q.v.*), and these by *Pygopodes*, to which only 2 Families *Colymbidae* (DIVER, vol. vii. p. 292) and *Alcidæ* are allowed—the GREES (vol. xi. p. 79) being included in the former. The *Impennes* or PENGUINS (*q.v.*) form the Twenty-second, and TINAMOUS (*q.v.*) as *Crypturi* complete the Carinate Subclass. For the *Ratitæ* only three "Orders" are allotted—*Apterygæ*, *Casuarii*, and *Struthionæ*.

As a whole it is impossible not to speak well of the scheme thus sketched out; nevertheless it does seem in some parts to be open to amendment, though the task of attempting to suggest any modifications of it by way of improvement is one that the present writer approaches with reluctance and the utmost diffidence. Yet the task, it appears, must be undertaken. From the preceding

<sup>1</sup> In the eighth edition of the *List of Vertebrated Animals in the Zoological Gardens*, which, being published in 1883, may be taken as expressing Mr. Sclater's latest views, the first two Families only are recognized, the last two being placed under *Columbidae*.

<sup>2</sup> Wrongly spelt *Otidæ*.

pages, recounting the efforts of many system-makers—good, bad, and indifferent—it will have been seen what a very great number and variety of characters need to be had in remembrance while planning any scheme that will at all adequately represent the results of the knowledge hitherto attained, and the best lesson to be learnt from them is that our present knowledge goes but a very little way in comparison with what we, or our successors, may hope to reach in years to come. Still we may feel pretty confident that we are on the right track, and, moreover, that here and there we can plant our feet on firm ground, however uncertain, not to say treacherous, may be the spaces that intervene. Now that geographical exploration has left so small a portion of the earth's surface unvisited, we cannot reasonably look for the encountering of new forms of ornithic life that, by revealing hitherto unknown stepping stones, will quicken our course or effectively point out our path. Indeed, as a matter of fact, the two most important and singular types of existing Birds—*Balaniceps* and *Rhinocetus*—that in later years have rewarded the exertions of travelling naturalists, have proved rather sources of perplexity than founts of inspiration. Should fortune favour ornithologists in the discovery of fossil remains, they will unquestionably form the surest guide to our faltering steps; but experience forbids us to expect much aid from this quarter, however warmly we may wish for it, and the pleasure of any discovery of the kind would be enhanced equally by its rarity as by its intrinsic worth. However, it is now a well-accepted maxim in zoology that the mature forms of the past are repeated in the immature forms of the present, and that, where Palæontology fails to instruct us, Embryology may be trusted to no small extent to supply the deficiency. Unhappily the embryology of Birds has been as yet very insufficiently studied. We have indeed embryological memoirs of a value that can scarcely be rated too highly, but almost all are of a monographic character. They are only cases in a desert of ignorance, and a really connected and continuous series of investigations, such as the many morphological laboratories, now established in various countries, would easily render possible, has yet to be instituted. No methodical attempt at this kind of work seems to have been made for nearly half a century, and, with the advantage of modern appliances, no one can justifiably doubt the success of a renewal of such an attempt any more than he can possibly foresee the precise nature of the revelations that would come of it.

The various schemes for classifying Birds set forth by the authors of general text-books of Zoology do not call for any particular review here, as almost without exception they are so drawn up as to be rather of the nature of a compromise than of a harmony. The best and most notable is perhaps that by Prof. CARUS in 1868 (*Handbuch der Zoologie*, i. pp. 191-368); but it is of course now antiquated. The worst scheme is one of the most recent, that by Prof. CLAUS in 1882 (*Grundzüge der Zoologie*, ii. pp. 318-388). Of most other similar text-books that have come under the writer's notice, especially those issued in the United Kingdom, the less said the better. It is unfortunate that neither Prof. Gegenbaur nor the late Prof. F. M. Balfour should have turned their attention to this matter; but an improvement may be expected from Dr. Gadov, who is engaged in completing the ornithological portion of Bronn's *Thierreich*, so long left unfinished.

Birds are animals so similar to Reptiles in all the most essential features of their organization that they may be said to be merely an extremely modified and aberrant Reptilian type. These are almost the very words of Prof. Huxley twenty years ago,<sup>3</sup> and there are now but few zoologists to dissent from his statement, which by another man of science has been expressed in a phrase even more

<sup>3</sup> *Lectures on the Elements of Comparative Anatomy*, p. 69; see also Carus, *Handbuch der Zoologie*, i. p. 192.

path—"Birds are only glorified Reptiles." It is not intended here to enter upon their points of resemblance and differences. These may be found summarized with more or less accuracy in any text-book of zoology. We shall content ourselves by remarking that by the naturalist just named Birds and Reptiles have been brigaded together under the name of *Sauropsida* as forming one of the three primary divisions of the *Vertebrata*—the other two being *Ichthyopsida* and *Mammalia*. Yet Birds have a right to be considered a Class, and as a Class they have become so wholly differentiated from every other group of the Animal Kingdom that, among recent and even the few fossil forms known to us, there is not one about the assignation of which any doubt ought now to exist, though it is right to state that some naturalists have even lately refused a place among *Aves* to the singular *Archaeopteryx*, of which the remains of two individuals—most probably belonging to as many distinct forms—have been discovered in the quarries of Solenhofen in Bavaria. Yet one of them has been referred, without much hesitation, by Prof. Vogt to the Class *Reptilia* on grounds which seem to be mistaken, since it was evidently in great part if not entirely clothed with feathers.<sup>2</sup> The peculiar structure of *Archaeopteryx* has already been briefly mentioned and partly figured in this work (*BIRDS*, vol. iii. p. 728-9), and, while the present writer cannot doubt that its Bird-like characters predominate over those which are obviously Reptilian, he will not venture to declare more concerning its relations to other Birds, and accordingly thinks it advisable to leave the genus as the sole representative as yet known of the Subclass *Saurura*,<sup>3</sup> established for its reception by Prof. Hæckel, trusting that time may shew whether this provisional arrangement will be substantiated. The great use of the discovery of *Archaeopteryx* to naturalists in general is well known to have been the convincing testimony it afforded as to what is well called "the imperfection of the Geological Record." To ornithologists in particular its chief attraction is the evidence it furnishes in proof of the evolution of Birds from Reptiles; though, as to the group of the latter from which the former may have sprung, it tells us little that is not negative. It throws, for instance, the Pterodactyl—so often imagined to be nearly related to Birds, if not to be their direct ancestors—completely out of the line of descent. Next to this its principal advantage is to reveal the existence at so early an epoch of Birds with some portions of their structure as highly organized as the highest of the present day, a fact witnessed by its foot, which, so far as can be judged by its petrified relics,

might well be that of a modern Crow. The fossil remains of many other Birds, for example Prof. SEELEY'S *Enalornis* (*Quart. Journ. Geol. Society*, 1856, pp. 496-512), Sir R. OWEN'S *Odontopteryx* (*BIRDS*, vol. iii. p. 729), *Gastornis*, Prof. COPP'S *Diatryma* (*Proc. Acad. N. Sc. Philadelphia*, April 1876), and some more, are too fragmentary to serve the purposes of the systematist; but the grand discoveries of Prof. Marsh, spoken of above, afford plentiful hints as to the taxonomy of the Class, and their bearing deserves the closest consideration. First of all we find that, while Birds still possess the teeth they had inherited from their Reptilian ancestors, two remarkable and very distinct types of the Class had already made their appearance, and we must note that these two types are those which persist at the present day, and even now divide the Class into *Ratite* and *Carinate*, the groups whose essentially distinct characters were recognized by Merrem. Furthermore, while the Ratite type (*Hesperornis*) presents the kind of teeth, arrayed in grooves, which indicate (in Reptiles at least) a low morphological rank, the Carinate type (*Ichthyornis*) is furnished with teeth set in sockets, and showing a higher development. On the other hand this early Carinate type has vertebrae whose comparatively simple, biconcave form is equally evidence of a rank unquestionably low; but the saddle-shaped vertebrae of the contemporary Ratite type as surely testify to a more exalted position. Reference has been already made to this complicated if not contradictory state of things, the true explanation of which seems to be out of reach at present. It has been for some time a question whether the Ratite is a degraded type descended from the Carinate, or the Carinate a superior development of the Ratite type. Several eminent zoologists have declared themselves in favour of the former probability, and at first sight most people would be inclined to decide with them; for, on this hypothesis, the easiest answer to the question would be found. But the easiest answer is not always the true one; and to the present writer it seems that before this question be answered, a reply should be given to another—Was the first animal which any one could properly call a "Bird," as distinguished from a "Reptile," possessed of a keeled sternum or not? Now Birds would seem to have been differentiated from Reptiles while the latter had biconcave vertebrae, and teeth whose mode of attachment to the jaw was still variable. There is no reason to think that at that period any Reptile (with the exception of Pterodactyls, which, as has already been said, are certainly not in the line of Birds' ancestors) had a keeled sternum. Hence it seems almost impossible that the first Bird should have possessed one; that is to say, it must have been practically of the Ratite type. Prof. Marsh has shewn that there is good reason for believing that the power of flight was gradually acquired by Birds, and with that power would be associated the development of a keel to the sternum, on which the volant faculty so much depends, and with which it is so intimately correlated that in certain forms which have to a greater or less extent given up the use of their fore-limbs the keel though present has become proportionally aborted. Thus the Carinate type would, from all we can see at present, appear to have been evolved from the Ratite. This view receives further support from a consideration of the results of such embryological research as has already been made—the unquestionable ossification of the Ratite sternum from a smaller number of paired centres than the Carinate sternum, in which (with the doubtful exception of the *Anatidae*) an additional, unpaired centre makes its appearance. Again the geographical distribution of existing, or comparatively recent, Ratite forms points to the same conclusion. That these forms—Moa, Kiwi, Emeu and Cassowary, Rhea, and finally Ostrich—

<sup>1</sup> See Prof. Seeley's remarks on the differences between the two specimens, in the *Geological Magazine* for October 1881.

<sup>2</sup> Prof. Vogt lays much stress on the absence of feathers from certain parts of the body of the second example of *Archaeopteryx* now, thanks to Dr. Werner Siemens, in the museum of Berlin. But Prof. Vogt himself shews that the parts of the body devoid of feathers are also devoid of skin. Now it is well known that amongst most existing Birds the ordinary "contour-feathers" have their origin no deeper than the skin, and thus if that decayed and were washed away the feathers growing upon it would equally be lost. This has evidently happened (to judge from photographs) to the Berlin specimen just as to that which is in London. In each case, as Sir R. Owen most rightly suggested of the latter, the remains exactly call to mind the very familiar relics of Birds found on a seashore, exposed perhaps for weeks or even months to the wash of the tides so as to lose all but the deeply-seated feathers, and finally to be embedded in the soft soil. Prof. Vogt's paper is in the *Revue Scientifique*, ser. 2, ix. p. 241, and an English translation of it in *The Ibis* for 1880, p. 434.

<sup>3</sup> Prof. Hæckel seems first to have spelt this word *Saurura*, in which form it appears in his *Allgemeine Entwicklungsgeschichte der Organismen*, forming the second volume of his *Generelle Morphologie* (pp. xi. and cxxxix.), published at Berlin in 1866, though on plate iv. of the same volume it appears as *Sauriurk*. Whether the masculine or feminine termination be preferred matters little, though the latter is come into general use, but the interpolation of the *u* in the middle of the word appears to be against all the laws of orthography.

must have had a common ancestor nearer to them than is the ancestor of any Carinate form seems to need no proof. If we add to these the *Ēpyornis* of Madagascar, the fossil *Ratita* of the Siwalik rocks,<sup>1</sup> and the as yet but partially recognized *Struthiolithus* of Southern Russia,<sup>2</sup> to say nothing of *Gastornis*, the evidence is stronger still. Scattered as these Birds have been or are throughout the world, it seems justifiable to consider them the survivals of a very ancient type, which has hardly undergone any essential modification since the appearance of Bird-life upon the earth—even though one at least of them has become very highly specialized.

No doubt the difficulty presented by the biconcave vertebrae of the earliest known representative of the Carinate type is a considerable obstacle to the view just taken. But in the *American Journal of Science* (April 1879), and again in his great work (pp. 180, 181), Prof. MANN has shown that in the third cervical vertebra of *Ichthyornis* "we catch nature in the act as it were" of modifying one form of vertebra into another, for this single vertebra in *Ichthyornis* is in vertical section "moderately convex, while transversely it is strongly concave, thus presenting a near approach to the saddle-like articulation"; and he proceeds to point out that this specialized feature occurs at the first bend of the neck, and, greatly facilitating motion in a vertical plane, is "mainly due originally to its predominance." The form of the vertebrae would accordingly seem to be as much correlated with the mobility of the neck as is the form of the sternum with the faculty of flight. If therefore the development of the saddle shape be an indication of development, as well may be the outgrowth of a keel. However, the solution of this perplexing problem, if a solution be ever found, must remain for future palæontological or embryological discoverers. The present writer is far from attempting to decide a question so complicated, though he does not hesitate to say, notwithstanding the weight of authority on the other side, that according to present evidence the probability is in favour of the Carinate having been evolved from a more ancient Ratite type. One thing only is certain, and that is the independent and contemporaneous existence of each of these great divisions at the earliest period when Birds at all like recent forms are known to have lived. The facts that each of these types was provided with teeth, and that the teeth were of a different pattern, are of comparatively secondary importance.

It seems therefore quite justifiable to continue, after the fashion that has been set, to separate the Class *Aves* into three primary groups:—I. *Saururæ*, II. *Ratitæ*, III. *Carinatæ*—the earliest members of the two last, as well as possibly all of the first, being provided with teeth. These three primary groups we may call "Subclasses."<sup>3</sup> Thus we shall have:—

SAURURÆ, Hæckel. *Archæopteryx* the only known form.  
RATITÆ, Merrem. a. with teeth;

a'. with biconcave vertebrae—as yet unknown;

b'. with saddle-shaped vertebrae—*Hesperornis*.

b. without teeth—recent and existing forms.

<sup>1</sup> For notice of these see the papers by Mr Davies in the *Geological Magazine* (new series, decade II., vol. vii. p. 18), and Mr Lydekker in the *Records of the Geological Survey of India* (xii. p. 52).

<sup>2</sup> *Bull. Acad. Sc. St. Petersburg*, xviii. p. 158; *Ibid.*, 1874, p. 4.

<sup>3</sup> Prof. Huxley has termed them "Orders"; but it is more in accordance with the practice of ornithological writers to raise them to a higher rank, and to call the secondary groups "Orders." There is a good deal to be said in behalf of either view; but, as in most cases of mere terminology, the matter is not worth wasting words over it, so long as we bear in mind that what here is meant by an "Order" of *Aves* is a very different thing from an "Order" of *Reptilia*.

CARINATÆ, Merrem. a. with teeth;

a'. with biconcave vertebrae—*Ichthyornis*;

b'. with saddle-shaped vertebrae—as yet unknown.

b. without teeth—recent and existing forms.

We have now to consider the recent and existing forms of toothless *Ratitæ*. These were shown beyond doubt by Prof. Huxley to form five separate groups, which we shall here dignify by the name of Orders,<sup>4</sup> adding to them a sixth, though little is as yet known of its characteristics. Of this, which contains the great extinct Birds of Madagascar, he did not take cognizance, as it is here necessary to do. In the absence of any certain means of arranging all of these orders according to their affinities, it will be best to place their names alphabetically, thus:—

ĒPYORNITHES. Fam. *Ēpyornithidæ*.

APTERYGES. Fam. *Apterygidæ* (KIWI, vol. xiv. p. 104).

IMMANES. Fam. i. *Dinornithidæ*; Fam. ii. *Palaapterygidæ*.<sup>5</sup>

MEGISTANES. Fam. i. *Casuariidæ*; Fam. ii. *Dromidæ* (EMEU, vol. viii. p. 171).

RHEÆ. Fam. *Rheidæ* (RHEA, *q.v.*).

STRUTHIONES. Fam. *Struthionidæ* (OSTRICH, p. 62 *infra*).

Some systematists think there can be little question of the *Struthiones* being the most specialized and therefore probably the highest type of these Orders, and the present writer is rather inclined to agree with them. Nevertheless the formation of the bill in the *Apteryges* is quite unique in the whole Class, and indicates therefore an extraordinary amount of specialization. Their functionless wings, however, point to their being a degraded form, though in this matter they are not much worse than the *Megistanes*, and are far above the *Immanes*—some of which at least appear to have been absolutely wingless, and were thus the only members of the Class possessing but a single pair of limbs.

Turning then to the third Subclass, the *Carinatæ*, their subdivision into Orders is attended with a considerable amount of difficulty; and still greater difficulty is presented if we make any attempt to arrange these Orders so as in some way or other to show their respective relations—in other words, their genealogy. In regard to the first of these tasks, a few groups can no doubt be at once separated without fear of going wrong. For instance, the *Crypturæ* or Tinamous, the *Impennes* or Penguins, the *Strigæ* or Owls, the *Pittaci* or Parrots, and the *Passeræ*, or at least the *Ocines*, seem to stand as groups each quite by itself, and, since none of them contains any hangers-on about the character of which there can any longer be room to hesitate, there can be little risk in setting them apart. Next comes a category of groups in which differentiation appears not to have been carried so far, and, though there may be as little doubt as to the association in one Order of the greater number of forms commonly assigned to each, yet there are in every case more or fewer outliers that do not well harmonize with the rest. Here we have such groups as those called *Pygopodes*, *Gaviæ*, *Limicolæ*, *Gallinæ*, *Columbæ*, *Anseræ*, *Herodionæ*, *Steganopodes*, and *Accipitræ*. Finally there are two groups of types presenting characteristics so diverse as to defy almost any definition, and, if it were not almost nonsense to say so, agreeing in little more than in the differences. These two groups are those known as *Picariæ* and *Alectoridæ*; but, while the majority

<sup>4</sup> See *Ann. Nat. History*, ser. 4, xx. pp. 499, 500.

<sup>5</sup> On the supposition that the opinions of Dr Von Haast (*Trans. and Proc. N. Zealand Inst.*, vi. pp. 426, 427) can be substantiated; but they have since been disputed by Prof. Hutton (*op. cit.*, ix. pp. 363–365), and for the present it is advisable to suspend our judgment.

of Families or genera usually referred to the former plainly have some features in common, the few Families or genera that have been slotted together in the latter make an assemblage that is quite artificial, though it may be freely owned that with our present knowledge it is impossible to determine the natural alliances of all of them.<sup>1</sup>

That our knowledge is also too imperfect to enable systematists to compose a phylogeny of Birds, even of the Carinate Subclass, and draw out their pedigree, ought to be sufficiently evident. The uncertainty which still prevails among the best-informed ornithologists as to the respective origin of the *Ratites* and *Carinatae* is in itself a proof of that fact, and in regard to some groups much less widely differentiated the same thing occurs. We can point to some forms which seem to be collaterally ancestral (if such a phrase may be allowed), and among them perhaps some of those which have been referred to the group "*Alcedorides*" just mentioned, and from a consideration of their Geographical Distribution and especially Isolation it will be obvious that they are the remnants of a very ancient and more generalized stock which in various parts of the world have become more or less specialized. The very case of the New Caledonian Kagu (*Rhinocetus*), combining features which occasionally recall the Sun-Bittern (*Eurypyga*), and again present an unmistakable likeness to the *Limicola* or the *Rallida*, shews that it is without any very near relation on the earth, and, if convenience permitted, would almost justify us in placing it in a group apart from any other, though possessing some characteristics in common with several.

It is anything but the desire of the present writer to invent a new arrangement of Birds. Such acquaintance as he possesses with the plans which have been already propounded warns him that until a great deal more labour has been expended, and its results made clearly known, no general scheme of Classification will deserve to be regarded as final. Nevertheless in the best of modern systems there are some points which, as already hinted, seem to be well established, while in them there are also some dispositions and assignments which he is as yet unable to accept, while he knows that he is not alone in his mistrust of them, and he thinks it his duty here to mention them in the hope that thereby attention may be further directed to them, and his doubts either dispelled or established—it matters not which. The most convenient way of bringing them to the notice of the reader will perhaps be by considering in succession the different groups set forth by the latest systematist of any authority—Mr Sclater—a sketch of whose method has been above given.

If we trust to the results at which Prof. Huxley arrived, there can be little doubt as to the propriety of beginning the Carinate Subclass with his *Dromagnathae*, the *Crypturi* of Illiger and others, or Tinamous, for their resemblance to the *Ratites* is not to be disputed; but it must be borne in mind that nothing whatever is known of their mode of development, and that this may, when made out, seriously modify their position relatively to another group, the normal *Anseres*, in which the investigations of Cuvier and L'Herminier have already shewn that there is some resemblance to the *Ratites* as regards the ossification of the sternum. It will be for embryologists to determine whether this asserted resemblance has any real meaning; but of the sufficient standing of the *Crypturi* as an Order there can hardly be a question.

<sup>1</sup> Heterogeneous as is the group as left by the latest systematist, it is nothing to its state when first founded by Illiger in 1811; for it then contained in addition the genera *Glaucola* and *Cereopsis*, but the last was restored to its true place among the *Anseres* by Temminck. The *Alcedorides* of Duméril have nothing in common with the *Alcedorides* of Illiger, and the latter is a name most unfortunately chosen, since the group so called does not include any Cook-like Bird.

We have seen that Prof. Huxley would derive all other existing Carinate Birds from the *Dromagnathae*; but of course it must be understood in this, as in every other similar case, that it is not thereby implied that the modern representatives of the *Dromagnathous* type (namely, the Tinamous) stand in the line of ancestry.

Under the name *Impennes* we have a group of Birds, the Penguins, smaller even than the last, and one over which until lately systematists have been sadly at fault; for, though we as yet know little if anything definite as to their embryology, no one, free from bias, can examine any member of the group, either externally or internally, without perceiving how completely different it is from any others of the Carinate division. There is perhaps scarcely a feather or a bone which is not diagnostic, and nearly every character hitherto observed points to a low morphological rank. It may even be that the clothing of *Hesperornis* was not very dissimilar to the "plumage" which now covers the *Impennes*, and the title of an Order can hardly be refused to them.

The group known as *Pygopodes* has been often asserted to be closely akin to the *Impennes*, and we have seen that Brandt combined the two under the name of *Urinatores*, while Mr Sclater thinks the *Pygopodes* "seem to form a natural transition between" the Gulls and the Penguins. The affinity of the *Alcids* or Auks (and through them the Divers or *Colymbidae*) to the Gulls may be a matter beyond doubt, and there appears to be ground for considering them to be the degraded offspring of the former; but to the present writer it appears questionable whether the *Gibbae*, *Podicipedidae*, have any real affinity to the two Families with which they are usually associated, and this is a point deserving of more attention on the part of morphologists than it has hitherto received. Under the name of *Gavia* the Gulls and their close allies form a very natural section, but it probably hardly merits the rank of an Order more than the *Pygopodes*, for its relations to the large and somewhat multiform though very natural group *Limicola* have to be taken into consideration. Prof. PARKER long ago observed (*Trans. Zool. Society*, v. p. 150) that characters exhibited by Gulls when young, but lost by them when adult, are found in certain Plovers at all ages, and hence it would appear that the *Gavia* are but more advanced *Limicola*. The Limicoline genera *Dromas* and *Chionis* have many points of resemblance to the *Laridae*; and on the whole the proper inference would seem to be that the *Limicola*, or something very like them, form the parent-stock whence have descended the *Gavia*, from which or from their ancestral forms the *Alcids* have proceeded as a degenerate branch. If this hypothesis be correct, the association of these three groups would constitute an Order, of which the highest Family would perhaps be *Otididae*, the Bustards; but until further research shews whether the view can be maintained it is not worth while to encumber nomenclature by inventing a new name for the combination. On the other hand the Petrels, which form the group *Tubinariae*, would seem for several reasons to be perfectly distinct from the *Gavia* and their allies, and possibly will have to rank as an Order.

Considerable doubt has already been expressed as to the existence of an Order *Alcedorides*, which no one can regard as a natural group, and it has just been proposed to retransfer to the *Limicola* one of the Families, *Otididae*, kept in it by Mr Sclater. Another Family included in it by its founder is *Cariamidae*, the true place of which has long been a puzzle to systematizers. The present writer is inclined to think that those who have urged its affinity to the *Accipitres*, and among them taxonomers starting from bases so opposite as Sundevall and Prof. Parker, have more nearly hit the mark, and accordingly would

now relegate it to that Order. It is doubtless an extremely generalized form,<sup>1</sup> the survival of a very ancient type, whence several groups may have sprung; and, whenever the secret it has to tell shall be revealed, a considerable step in the phylogeny of Birds can scarcely fail to follow.<sup>2</sup> Allusion has also been made to the peculiarities of two other forms placed with the last among the *Alectorides*—*Eurypyga* and *Rhinocetus*—being each the sole type of a separate Family. It seems that they might be brought with the *Gruidæ*, *Psophidæ*, and *Aramidæ* into a group or Suborder *Grues*,—which, with the *Fulicariæ*<sup>3</sup> of Nitzsch and Mr Sclater as another Suborder, would constitute an Order that may continue to bear the old Linnæan name *Grallæ*. It must be borne in mind, however, that some members of both these Suborders exhibit many points of resemblance to certain other forms that it is at present necessary to place in different groups—thus some *Rallidæ* to the *Gallinæ*, *Grus* to *Otis*, and so forth; and it is as yet doubtful whether further investigation may not shew the resemblance to be one of affinity, and therefore of taxonomic value, instead of mere analogy, and therefore of no worth in that respect.

We have next to deal with a group nearly as complicated. The true *Gallinæ* are indeed as well marked a section as any to be found; but round and near them cluster some forms very troublesome to allocate. The strange Hoactzin (*Opisthocomus*) is one of these, and what seems to be in some degree its arrested development makes its position almost unique,<sup>4</sup>—but enough has already been said of it before (see vol. xii. p. 28, and *supra* p. 36). It must for the present at least stand alone, the sole occupant of a single Order. Then there are the Hemipodes or Button-Quails, which have been raised to equal rank by Prof. Huxley as *Turnicomorphæ*; but, though no doubt the osteological differences between them and the normal *Gallinæ*, pointed out by him as well as by Prof. Parker, are great, they do not seem to be more essential than are found in different members of some other Orders, nor to offer an insuperable objection to their being classed under the designation *Gallinæ*. If this be so there will be no necessity for removing them from that Order, which may then be portioned into three Suborders—*Hemipodii* standing somewhat apart, and *Alectoropodes* and *Peristeropodes*, which are more nearly allied—the latter comprehending the *Megapodiidæ* and *Craciidæ*, and the former consisting of the normal *Gallinæ*, of which it is difficult to justify the recognition of more than a single Family, though in that two types of structure are discernible.

The Family of Sand-Grouse, *Pteroclidæ*, is perhaps one of the most instructive in the whole range of Ornithology. In Prof. HUXLEY'S words (*Proceedings*, 1868, p. 303), they are "completely intermediate between the *Alectoromorphæ* [i.e., *Gallinæ*] and the *Peristeromorphæ* [the Pigeons]. They cannot be included within either of these groups without destroying its definition, while they are perfectly definable themselves." Hence he would make them an independent group of equal value with the other two. Almost the same result has been reached by Dr GADOW

<sup>1</sup> *Cariama* is the oldest name for the genus, but being a word of "barbarous" origin it was set aside by Illiger and the purists in favour of *Dicholophus*, under which name it has been several times mentioned in the foregoing pages.

<sup>2</sup> A brief description of the egg and young of *Cariama cristata* produced in the Jardin des Plantes at Paris is given in the Zoological Society's *Proceedings* for 1881, p. 2.

<sup>3</sup> This group would contain three families—*Rallidæ*, *Heliornithidæ* (the Finfoots of Africa and South America), and the *Mecitidæ* of Madagascar—whose at least approximate place has been at last found for them by M. A. Milne-Edwards (*Ann. Sc. Naturelles*, ser. 6. vii. No. 6).

<sup>4</sup> *Mesites*, just mentioned, presents a case which may, however, be very similar.

(*op. cit.*, 1882, pp. 331, 332). No doubt there are strong and tempting reasons for taking this step; but peradventure the real lesson taught by this aggregation of common characters is rather the retention of the union of the *Gallinæ* and *Columbæ* into a single group, after the fashion of by-gone years, under the name, however meaningless, of *Rasores*. Failing that, the general resemblance of most parts of the osteology of the Sand-Grouse to that of the Pigeons, so well shewn by M. Milne-Edwards, combined with their Pigeon-like pterylosis, inclines the present writer to group them as a Suborder of *Columbæ*; but the many important points in which they differ from the more normal Pigeons, especially in the matter of their young being clothed with down, and their coloured and speckled eggs,<sup>5</sup> must be freely admitted. Young Sand-Grouse are described as being not only "Dasypædes" but even "Præcoces" at birth, while of course every one knows the helpless condition of "Pipers"—that is, Pigeons newly-hatched from their white eggs. Thus the opposite condition of the young of these two admittedly very near groups inflicts a severe blow on the so-called "physiological" method of dividing Birds before mentioned, and renders the *Pteroclidæ* so instructive a form. The *Columbæ*, considered in the wide sense just suggested, would seem to have possessed another and degenerate Suborder in the Dodo and its kindred, though the extirpation of those strange and monstrous forms will most likely leave their precise relations a matter of some doubt; while the third and last Suborder, the true *Columbæ*, is much more homogeneous, and can hardly be said to contain more than two Families, *Columbidæ* and *Didunculidæ*—the latter consisting of a single species peculiar to the Samoa Islands, and having no direct connexion with the *Dididæ* or *Dodos*,<sup>6</sup> though possibly it may be found that the Papuan genus *Otidiphaps* presents a form linking it with the *Columbidæ*.

The *Gallinæ* would seem to hold a somewhat central position among existing members of the Carinate division,<sup>7</sup> whence many groups diverge, and one of them, the *Opisthocomi* or *Heteromorphæ* of Prof. Huxley, indicates, as he has hinted, the existence of an old line of descent, now almost obliterated, in the direction of the *Musophagidæ*, and thence, we may not unreasonably infer, to the *Coccygomorphæ* of the same authority. But these "Coccygomorphs" would also appear to reach a higher rank than some other groups that we have to notice, and therefore, leaving the former, we must attempt to trace the fortunes of a more remote and less exalted line. It has already been stated that the *Gaviæ* are a group closely allied to though somewhat higher than the *Limicolæ*, and that at least two forms of what have here been called *Grallæ* present an affinity to the latter. One of them, *Rhinocetus*, has been several times thought to be connected through its presumed relative *Eurypyga* (from which, however, it is a good way removed both as regards distribution and structure) with the *Heriodiones*, Herons. On the other hand the *Gaviæ* would seem to be in like manner related through *Phaethon* (the TROPIC-BIRD, *q.v.*) with the *Steganopodes* or *Dysporomorphæ* of Prof. Huxley, among which it is usually placed, though according to Prof. MIVART (*Trans. Zool. Society*, x. pp. 364, 365) wrongly. These supposed affinities lead us to two other groups of Birds that have, it has been proved, some common characters; and from one or the other (no one yet can say which) the *Accipitres* would seem to branch off—

<sup>5</sup> This fact tells in favour of the views of Dr Gadow and those who hold the Sand-Grouse to be allied to the Plovers; but then he places the Pigeons between these groups, and their eggs tell as strongly the other way.

<sup>6</sup> *Cf. Phil. Transactions*, 1867, p. 349.

<sup>7</sup> *Cf. Prof. Parker's remarks in the Philosophical Transactions for 1869, p. 755.*



possibly from some ancestral type akin to and now most directly represented by the enigmatical *Cariama*—possibly in some other way which we can only dimly foreshadow. The *Herodiones* are commonly partitioned into three groups—*Ardea*, *Ciconia*, and *Platalea*, the last including the Ibises—which may certainly be considered to be as many Suborders. The second of them, the Storks, may perhaps be regarded as the point of departure for the *Accipitres* in the manner indicated,<sup>1</sup> as well as, according to Prof. Huxley, for the Flamingoes, of which he would make a distinct group, *Amphimorpha*, equivalent to the *Odontoglossæ* of Nitzsch, intermediate between the *Pelargomorpha* and the *Chenomorpha*, that is, between the Storks and the Geese. When the embryology of the *Phanicopteridæ* is investigated their supposed relationship may perhaps be made out. At present it is, like so much that needs to be here advanced, very hypothetical; but there is so much in the osteology of the Flamingoes, besides other things; that resembles the *Anseres* that it would seem better to regard them as forming a Subclass of that group to rank equally with the true *Anseres* and with the *Palamedes* (SCREAMER, &c.), which last, notwithstanding the opinion of Garrod, can hardly from their osteological similarity to the true *Anseres* be removed from their neighbourhood.

Whatever be the alliances of the genealogy of the *Accipitres*, the Diurnal Birds-of-Prey, their main body must stand alone, hardly divisible into more than two principal groups—(1) containing the *Cathartidæ* or the Vultures of the New World, and (2) all the rest, though no doubt the latter may be easily subdivided into at least two Families, *Vulturidæ* and *Falconidæ*, and the last into many smaller sections, as has commonly been done; but then we have the outliers left. The African *Serpentariidæ*, though represented only by a single species,<sup>2</sup> are fully allowed to form a type equivalent to the true *Accipitres* composing the main body; but whether to the Secretary-bird should be added the often-named *Cariama*, with its two species, must still remain an open question.

It has so long been the custom to place the Owls next to the Diurnal Birds-of-Prey that any attempt to remove them from that position cannot fail to incur criticism. Yet when we disregard their carnivorous habits, and certain modifications which may possibly be thereby induced, we find almost nothing of value to indicate relationship between them. That the *Striges* stand quite independently of the *Accipitres* as above limited can hardly be doubted, and, while the *Psittaci* or Parrots would on some grounds appear to be the nearest allies of the *Accipitres*, the nearest relations of the Owls must be looked for in the multifarious group *Picariæ*. Here we have the singular *Steatornis* (GUACHARO, vol. ix. p. 227), which, long confounded with the *Caprimulgidæ* (GOATSUCKER, vol. ix. p. 711), has at last been recognized as an independent form, and one cannot but think that it has branched off from a common ancestor with the Owls. The Goatsuckers may have done the like,<sup>3</sup> for there is really not much to ally them to the Swifts and Humming-birds, the *Macrochiræ* proper, as has often been recommended. However, the present writer would not have it supposed that he would place the *Striges* under the *Picariæ*, for the

last are already a sufficiently heterogeneous assemblage, and one with which he would not meddle. Whether the Woodpeckers should be separated from the rest is a matter of deeper consideration after the deliberate opinion of Prof. Parker, who would lift them as *Saurogynathæ* to a higher rank than that in which Prof. Huxley left them as *Celeomorpha*, indeed to be the peers of *Schisognathæ*, *Demognathæ*, and so forth; but this advancement is based solely on the characters of their palatal structure, and is unsupported by any others. That the *Pici* constitute a very natural and easily defined group is indisputable; more than that, they are perhaps the most differentiated group of all those that are retained in the "Order" *Picariæ*; but it does not seem advisable at present to deliver them from that chaos when so many other groups have to be left in it.

Lastly we arrive at the *Passeres*, and here, as already mentioned, the researches of Garrod and Forbes prove to be of immense service. It is of course not to be supposed that they have exhausted the subject even as regards their *Mesomyodi*, while their *Acromyodi* were left almost untouched so far as concerns details of arrangement; but the present writer has no wish to disturb by other than very slight modifications the scheme they put forth. He would agree with Mr Sclater in disregarding the distinctions of *Desmodactylis* and *Eleutherodactylis*, grouping the former (*Eurylamidæ*) with the *Heteromeri* and *Huplophona*, which all together then might be termed the Suborder *Oligomyodi*. To this would follow as a second Suborder the *Tracheophona* as left by Garrod, and then as a third Suborder the abnormal *Acromyodi*, whether they are to be called *Pseudococines* or not, that small group containing, so far as is known at present, only the two Families *Atrichidæ* and *Menuridæ*. Finally we have the normal *Acromyodi* or true *Ocines*.

This last and highest group of Birds is one which, as before hinted, it is very hard to subdivide. Some two or three natural, because well-differentiated, Families are to be found in it—such, for instance, as the *Hirundinidæ* or Swallows, which have no near relations; the *Alaudidæ* or Larks, that can be unfaithfully distinguished at a glance by their scutellated *planta*, as has been before mentioned; or the *Meliphagidæ* with their curiously constructed tongue. But the great mass, comprehending incomparably the greatest number of genera and species of Birds, defies any sure means of separation. Here and there, of course, a good many individual genera may be picked out capable of the most accurate definition; but genera like these are in the minority, and most of the remainder present several apparent alliances, from which we are at a loss to choose that which is nearest. Four of the six groups of Mr Sclater's "Laminiplantar" *Ocines* seem to pass almost imperceptibly into one another. We may take examples in which what we may call the Thrush-form, the Tree-creep-form, the Finch-form, or the Crow-form is pushed to the most extreme point of differentiation, but we shall find that between the outposts thus established there exists a regular chain of intermediate stations so intimately connected that no precise lines of demarcation can be drawn cutting off one from the other.

Still one thing is possible. Hard though it be to find definitions for the several groups of *Ocines*, whether we make them more or fewer, it is by no means so hard, if we go the right way to work, to determine which of them is the highest, and, possibly, which of them is the lowest. It has already been shewn (page 30) how, by a woful want of the logical apprehension of facts, the *Turdidæ* came to be accounted the highest, and the position accorded to them has been generally acquiesced in by those who have followed in the footsteps of Keyserling and

<sup>1</sup> Garrod and Forbes suggest a "Cleoniform" origin for the *Tubinares* (*Zool. Voy. "Challenger,"* pt. xi. pp. 62, 63).

<sup>2</sup> It was long suspected that the genus *Polyboroides* of South Africa and Madagascar, from its general resemblance in plumage and outward form, might come into this group, but that idea has now been fully dispelled by M. A. Milne-Edwards in his and M. Granddier's magnificent *Oisines de Madagascar* (vol. i. pp. 50-66).

<sup>3</sup> The great resemblance in coloration between Goatsuckers and Owls is of course obvious, so obvious indeed as to make one suspicious of their being akin; but in reality the existence of the likeness is no bar to the affinity of the groups; it merely has to be wholly disregarded.



*Blastus*, of Prof. Cabanis and of Sundevall. To the present writer the order thus prescribed seems to be almost the very reverse of that which the doctrine of Evolution requires, and, so far from the *Turdidae* being at the head of the *Ocineae*, they are among its lower members. There is no doubt whatever as to the intimate relationship of the Thrushes (*Turdidae*) to the Chats (*Saricolinae*), for that is admitted by nearly every systematizer. Now most authorities on classification are agreed in associating with the latter group the Birds of the Australian genus *Petroica* and its allies—the so-called “Robins” of the English-speaking part of the great southern communities. But it so happens that, from the inferior type of the osteological characters of this very group of Birds, Prof. PARKER has called them (*Trans. Zool. Society*, v. p. 152) “Struthious Warblers.” Now if the *Petroica*-group be, as most allow, allied to the *Saricolinae*, they must also be allied, only rather more remotely, to the *Turdidae*—for Thrushes and Chats are inseparable, and therefore this connexion must drag down the Thrushes in the scale. Let it be granted that the more highly-developed Thrushes have got rid of the low “Struthious” features which characterize their Australian relatives, the unbroken series of connecting forms chains them to the inferior position, and of itself disqualifies them from the rank so fallaciously assigned to them. Nor does this consideration stand alone. By submitting the Thrushes and allied groups of Chats and Warblers to other tests we may try still more completely their claim to the position to which they have been advanced.

Without attaching too much importance to the systematic value which the characters of the nervous system afford, there can be little doubt that, throughout the Animal Kingdom, where the nervous system is sufficiently developed to produce a brain, the creatures possessing one are considerably superior to those which have none. Consequently we may reasonably infer that those which are the best furnished with a brain are superior to those which are less well endowed in that respect, and that this inference is reasonable is in accordance with the experience of every Physiologist, Comparative Anatomist, and Palaeontologist, who are agreed that, within limits, the proportion which the brain bears to the spinal marrow in a vertebrate is a measure of that animal's morphological condition. These preliminaries being beyond contradiction, it is clear that, if we had a series of accurate weights and measurements of Birds' brains, it would go far to help us in deciding many cases of disputed precedency, and especially such a case as we now have under discussion. To the dispraise of Ornithologists this subject has never been properly investigated, and of late years seems to have been wholly neglected. The present writer can only refer to the meagre lists given by TIEDEMANN (*Anat. und Naturgesch. der Vögel*, i. pp. 18–22), based for the most part on very ancient observations; but, so far as those observations go, their result is conclusive, for we find that in the Blackbird, *Turdus merula*, the proportion which the brain bears to the body is lower than in any of the eight species of *Ocineae* there named, being as 1 is to 67. In the Redbreast, *Erethacus rubecula*, certainly an ally of the *Turdidae*, it is as 1 to 32; while it is highest in two of the Finches—the Goldfinch, *Carduelis elegans*, and the Canary-bird, *Serinus canarius*, being in each as 1 to 14. The signification of these numbers needs no comment to be understood.

Evidence of another kind may also be adduced in proof that the high place hitherto commonly accorded to the *Turdidae* is undeserved. Throughout the Class *Aves* it is observable that the young when first fledged generally assume a spotted plumage of a peculiar character—nearly each of the body-feathers having a light-coloured spot at

its tip—and this is particularly to be remarked in most groups of *Ocineae*, so much so indeed, that a bird thus marked may, in the majority of cases, be set down without fear of mistake as being immature. All the teachings of morphology go to establish the fact that any characters which are peculiar to the immature condition of an animal, and are lost in its progress to maturity, are those which its less advanced progenitors bore while adult, and that in proportion as it gets rid of them it shows its superiority over its ancestry. This being the case, it would follow that an animal which at no time in its life exhibits such marks of immaturity or inferiority must be of a rank, compared with its allies, superior to those which do exhibit these marks. The same may be said of external and secondary sexual characters. Those of the female are almost invariably to be deemed the survival of ancestral characters, while those peculiar to the male are in advance of the older fashion, generally and perhaps always the result of sexual selection.<sup>1</sup> When both sexes agree in appearance it may mean one of two things—either that the male has not lifted himself much above the condition of his mate, or that, he having raised himself, the female has successfully followed his example. In the former alternative, as regards Birds, we shall find that neither sex departs very much from the coloration of its fellow-species; in the latter the departure may be very considerable. Now, applying these principles to the Thrushes, we shall find that without exception, so far as is known, the young have their first plumage more or less spotted; and, except in some three or four species at most,<sup>2</sup> both sexes, if they agree in plumage, do not differ greatly from their fellow-species.

Therefore as regards capacity of brain and coloration of plumage priority ought not to be given to the *Turdidae*. It remains for us to see if we can find the group which is entitled to that eminence. Among Ornithologists of the highest rank there have been few whose opinion is more worthy of attention than Macgillivray, a trained anatomist and a man of thoroughly independent mind. Through the insufficiency of his opportunities, his views on general classification were confessedly imperfect, but on certain special points, where the materials were present for him to form a judgment, one may generally depend upon it. Such is the case here, for his work shows him to have diligently exercised his genius in regard to the Birds which we now call *Ocineae*. He belonged to a period anterior to that in which questions that have been brought uppermost by the doctrine of Evolution existed, and yet he seems not to have been without perception that such questions might arise. In treating of what he termed the Order *Vagatores*,<sup>3</sup> including among others the Family *Corvidae*—the Crows, he tells us (*Brit. Birds*, i. pp. 485, 486) that they “are to be accounted among the most perfectly organized birds,” justifying the opinion by stating the reasons, which are of a very varied kind, that led him to it. In one of the earlier treatises of Prof. PARKER, he has expressed (*Trans. Zool. Society*, v. p. 150) his approval of Macgillivray's views, adding that, “as that speaking, singing, mocking animal, Man, is the culmination of the Mammalian series, so that bird in which the gifts of speech, song, and mockery are combined must be considered as the top and crown of the bird-class.” Any doubt as to which Bird is here intended is dispelled by another passage, written ten

<sup>1</sup> See Darwin, *Descent of Man*, chap. xv., xvi.

<sup>2</sup> According to Mr Seebohm (*Cat. Birds Brit. Museum*, v. p. 232) these are in his nomenclature *Merula nigrescens*, *M. fusca*, *M. gigan*, and *M. gigantea*.

<sup>3</sup> In this Order he included several groups of Birds which we now know to be but slightly if at all allied; but his intimate acquaintance was derived from the *Corvidae* and the allied Family we now call *Sturnidae*.

years later, wherein (*Monthly Microsc. Journal*, 1872, p. 317) he says, "The Crow is the great sub-rational chief of the whole kingdom of the Birds; he has the largest brain; the most wit and wisdom;" and again, in the *Zoological Society's Transactions* (ix. p. 300), "In all respects, physiological, morphological, and ornithological, the Crow may be placed at the head, not only of its own great series (birds of the *Crow-form*), but also as the unchallenged chief of the whole of the 'Carinatae.'"

It is to be supposed that the opinion so strongly expressed in the passage last cited has escaped the observation of recent systematizers; for he would be a bold man who would venture to gainsay it. Still Prof. Parker has left untouched or only obscurely alluded to one other consideration that has been here brought forward in opposing the claim of the *Turdidae*, and therefore a few words may not be out of place on that point—the evidence afforded by the coloration of plumage in young and old. Now the *Corvidae* fail as completely as is possible for any group of Birds to do the obligations required by exalted rank. To the magnitude of their brain beyond that of all other Birds Prof. Parker has already testified, and it is the rule for their young at once to be clothed in a plumage which is essentially that of the adult. This plumage may lack the lustrous reflexions that are only assumed when it is necessary for the welfare of the race that the wearer should don the best apparel, but then they are speedily acquired, and the original difference between old and young is of the slightest. Moreover, this obtains even in what we may fairly consider to be the weaker forms of the *Corvidae*—the Pies and Jays. In one species of *Corvus*, and that (as might be expected) the most abundant, namely, the Rook, *C. frugilegus*, very interesting cases of what would seem to be explicable on the theory of Reversion occasionally though rarely occur. In them the young are more or less spotted with a lighter shade, and these exceptional cases, if rightly understood, do but confirm the rule.<sup>1</sup> It may be conceded that even among *Oscines*<sup>2</sup> there are some other groups or sections of

groups in which the transformation in appearance from youth to full age is as slight. This is so among the *Paridae*; and there are a few groups in which the young, prior to the first moult, may be more brightly tinted than afterwards, as in the genera *Phylloscopus* and *Anthus*. These anomalies cannot be explained as yet, but we see that they do not extend to more than a portion, and generally a small portion, of the groups in which they occur; whereas in the Crows the likeness between young and old is, so far as is known, common to every member of the Family. It is therefore confidently that the present writer asserts, as Prof. Parker, with far more right to speak on the subject, has already done, that at the head of the Class *Aves* must stand the Family *Corvidae*, of which Family no one will dispute the superiority of the genus *Corvus*, nor in that genus the pre-eminence of *Corvus corax*—the widely-ranging Raven of the Northern Hemisphere, the Bird perhaps best known from the most ancient times, and, as it happens, that to which belongs the earliest historical association with man. There are of course innumerable points in regard to the Classification of Birds which are, and for a long time will continue to be, hypothetical as matters of opinion, but this one seems to stand a fact on the firm ground of proof.

During the compilation of much of the present article the writer flattered himself with the hope that he might at its conclusion have been able to give a graphic illustration of the way in which the various groups of Birds may be conceived to be related to one another in the form of a map, such as has been so usefully furnished by several of his more gifted brethren in regard to other Classes or portions of Classes of the Animal Kingdom. This hope he has been reluctantly constrained to abandon,—whether from the inherent difficulty, perhaps impossibility, of at present executing the task, or from his own want of cartographical skill, it is not for him to say. He may, however, be allowed to express the belief that there is no group in Animated Nature that more assuredly deserves the further attention of the highest zoological intellects than Birds; and, looking to the perplexities which on all sides beset their scientific study, there is no department of Zoology that will better repay the application of those intellects than Ornithology. (A. N.)

<sup>1</sup> One of these specimens has been figured by Mr Hancock (*N. H. Trans. Northumb. and Durham*, vi. pl. 3); see also Yarrell's *British Birds*, ed. 4, ii. pp. 302, 303.

<sup>2</sup> In other Orders there are many, for instance some Hummingbirds and Kingfishers; but this only seems to shew the excellence in those Orders attained by the forms which enjoy the privilege.

INDEX.

Allen, 3, 4.	Bennett, 10.	Brandt, J. F., 25, 26, 42, 46.	Clara, 42.	Droste, 17.	Gilke, 17.	Harter, 10, 18.
Albertus Magnus, 2.	Bendat, 17.	Brae, 17.	Christa, 4.	Dubola, 17.	Gaza, 2.	Hartlaub, 17.
Albin, 5.	Berkenhout, 2.	Brahm, A. E., 17.	Colter, 4, 7.	Da Bua, 12.	Gentil, 17.	Harvey, 7.
Aldrovandus, 4.	Bernali, 9.	Brahm, C. L., 17.	Collett, 17.	Duméril, 13, 43.	Georgi, 2.	Harvie-Brown, 18.
Allen, 17.	Berthold, 22.	Brewer, 16.	Collin, 17.	Dunn, 18.	Gerbe, 17.	Hamelqvist, 2.
Alston, 12.	Besaka, 2.	Brewster, 17.	Collins, 2.	Edwards, 5, 6.	Gervais, 21.	Hagaa, 7.
Alston, 17.	Beswick, 10, 14, 18.	Brison, 2, 4, 7.	Cope, 42.	Elliot, 11, 16.	Gesser, 2, 4.	Heater, 16.
Anderson, 16.	Beton, 6.	Brown, F., 7.	Cordeaux, 18.	Eyton, 12, 22.	Giabel, 14, 21.	Heddie, 12.
Aristotle, 2, 12, 18.	Blainville, 2, 14, 20, 21, 22, 23.	Brown, P., 42.	Cornay, 29, 35.	Faber, 17.	Gilna, 9.	Helne, 21.
Aubert, 2.	Blanchard, 31, 32.	Browne, P. T., 9.	Couca, 16, 17, 22.	Fabricius, 2.	Grand, 16.	Herbert, 19.
Audubert, 11.	Blandin, 17.	Brunnich, 9.	Cousens, 12.	Falk, 2.	Gloger, 17, 21, 22.	Hermann, 7.
Andersson, 11, 12, 16, 22, 27, 28.	Blasius, G., 7.	Buckley, E., 5.	Crespon, 17.	Fatio, 17.	Gmelin, J. F., 7, 19.	Hermann, 4.
Bakke, 12.	Blasius, J. H., 9.	Buffon, 6, 7, 26.	Cuba, 2.	Feldten, 17.	Gmelin, S. G., 2.	Heysham, 9.
Baldus, 17.	Blyth, 10, 16, 22, 27, 29, 36, 29, 27, 42.	Buller, 16.	Cuvier, 7, 8, 14, 16, 19, 21, 22, 23, 24, 27, 29, 30, 32, 45.	Fernandez, 4.	Gossa, 16.	Hiaz, 17.
Baldus, 2, 17.	Bocage, Barbosa du, 17.	Bureau, 17.	Dallas, 27.	Finech, 14, 17.	Gould, 12, 13, 16, 17, 18, 27.	Hogg, 21.
Barraband, 11.	Bocart, 4.	Burmeister, 26, 27.	Darwin, 22, 23, 24, 26, 42.	Fischer, J. B., 2.	Grandidier, 47.	Holland, 2.
Barrere, 2.	Boddaert, 7.	Cabanis, 16, 17, 29, 30, 31, 41, 42.	D'Aubenton, 6, 7, 12.	Fischer de Waldheim, 12.	Gravenhorst, 17.	Holmgren, 17.
Barrington, 2.	Bolla, 17.	Caixa, 2.	Daudin, 7.	Fleming, 15, 18.	Graves, 12.	Holmgren, 17.
Bartholomy-Lapomernie, 17.	Bonaparte, 14, 16, 17, 21.	Canivez, 17.	Davies, 44.	Florent-Prevost, 11.	Gray, G. R., 14, 16.	Honeyar, A. von, 17.
Berthelid, 7.	Bonnaterre, 7.	Carus, 7, 22.	Della, 44.	Fraser, 12.	Gray, J. E., 2, 11.	H. von, 17.
Berthelot, 25.	Bontinga, 7.	Casini, 11, 32.	Dennis, 26.	Files, 15.	Gray, R., 12.	Houttuyn, 9.
Berton, 2.	Bordas, 7.	Cateby, 2.	Dorham, 5.	Frisch, 2.	Griffiths, 2.	Huet, 12.
Boscovich, 6, 9, 17.	Bongrove, 17.	Clap, 2.	Desmarest, 11.	Fritsch, 17.	Grossiger, 2.	Hume, 12.
Bon. F. J., 29, 30.	Borlase, 2.	Chamberlain, 17.	Desmarest, 11.	Forbes, 22, 23, 24, 41, 47.	Güldenstädt, 2.	Hunt, 12.
Bon. T., 12.	Borlase, 2.	Chambers, 22.	Desmarest, 11.	Ford, 16.	Gunnarus, 2.	Hunter, 2, 22.
Bon. A., 17.	Borrichius, 7.	Charlesworth, 25.	Desmarest, 11.	Forster, G., 2.	Gurney, 2, 16.	Hutton, 16, 44.
	Boutelle, 17.	Charlton, 2.	Desmarest, 11.	Forster, J. R., 2, 9.	Haast, 16, 44.	Huxley, 24, 25, 26, 29, 41, 42, 44, 45, 46, 47.
	Brandt, A., 17.	Chaston, 4.	Desmarest, 11.	Garrod, 42, 46.	Häkel, 24, 45, 44.	Hillger, 14, 22, 24, 25, 31, 44.
		Chenon, 17.	Desmarest, 11.	Carroll, 29, 30, 40, 41, 47.	Hancock, 10, 18, 49.	Irby, 17.
		Clarke, 12.	Desmarest, 11.	Hardwicke, 11.	Hancock, 10, 18, 49.	Jäckel, 17.
			Desmarest, 11.	Hardy, 17.	Jacobson, 20.	Jacobson, 20.

Jaquesmin, 27, 29.	Leaz, 12.	Martinet, 4, 12.	Nitsch, 14, 18, 19,	Ray, 4, 5, 6.	Sealey, 42.	Tiedemann, 10, 44.
Jaquin, 7.	Legge, 14.	Mandeyt, 7.	20, 21, 22, 23, 24,	Edemmer, 7.	Selby, 12, 18.	Tobias, 17.
Jamson, 14.	Leigh, 4.	Max, 17.	26, 27, 28, 29, 30,	Reichenbach, 13, 17.	Selenka, 7.	Tristram, 17, 32.
Jarvis, 10, 12, 16,	Lelander, 17.	Marrew, 14, 16, 19,	39, 44.	Reichenow, 17.	Seligmann, 8.	Tschud-Schmidhoffs,
18.	Lemontel, 17.	20, 21, 22, 27, 31,		Reinhardt, 23.	Selys - Longchamps,	17.
Jumbert, 17.	Lemontel, 17.	34, 43, 44.		Rennie, 14, 18.	17.	Tunstall, 8.
Jemys, 18.	Lotand, 14.	Merritt, 4, 9.		Retain, 8.	Sovereyns, 12.	Turner, H. N., 12.
Jerdon, 14.	Lopezin, 8.	Meyer, A. B., 13, 17.		Reyer, 8.	Sharpe, 12, 16, 17.	Turner, W., 2.
Johnston, 4.	Louvaige, 17.	Meyer, B., 17.		Richardson, 16.	Shaw, 6, 7, 12.	Valencia, 7.
Kahn, 8.	Lesson, 12.	Meyer, H. L., 12.		Ridgway, 17.	Shelley, 17.	Vernoy, 7.
Kamp, 14, 18.	Le Vallant, 4, 11, 16.	Meyer, H. von, 24.		Risso, 17.	Shepherd, 17.	Vismol, 7, 11, 12, 14, 17.
Kelaart, 16.	Lever, 8.	Milne-Edwards, 24,		Rodd, 12.	Sibbold, 4.	Vigora, 14, 15, 16, 23,
Kessler, 27.	Lewis, J. W., 14.	44, 47.		Roux, 17.	Simsen, 9.	31.
Koulemann, 12, 16, 17.	Lewis, W., 9.	Mitchell, 12, 14.		Rowley, 12.	Sisana, 2.	Vogt, 42.
Keyserling, 26, 28,	L'Hermittier, 16, 20,	Mittelpacher, 8.		Raczynski, 8.	Smith, 12.	Wagler, 14, 20.
29, 37, 47.	19, 31, 32, 34, 25,	Mivart, 4, 44.		St-Hilaire, Bourjot, 11.	Smith, Alfred C., 17.	Wagner, A., 11, 27,
Kirby, 18, 20, 24.	29, 31, 32, 43.	Möhring, 8.		St-Hilaire, G. Geoff-	Smith, Cecill, 18.	30, 34.
Klitz, 12.	Lichtenstein, 4.	Mölna, 8.		roy, 16, 18, 17, 29,	Sonnerat, 7.	Wagner, R., 21.
Kjerfving, 17.	Lilford, 17.	Montagu, 18, 17.		24.	Spalowsky, 7.	Walcott, 9.
Klein, 8.	Lilleborg, 24.	Montbellard, 4.		St-Hilaire, I. Geoff-	Sparman, 16.	Wallace, 22, 33, 41.
Knap, 11.	Linnæus, 5, 4, 7, 8,	Mora, 12.		roy, 12, 24.	Stearns, 16.	Waterton, 16.
Knorr, 12.	9, 14, 19, 20, 24, 25,	Mühle, 17.		St John, 12.	Stephens, 12.	Watters, 18.
Koch, 17.	29, 37.	Müller, H. C., 17.		Salerna, 6.	Striand, 12.	Whitaker, 18.
König - Walthöden,	Löffle, 2.	Müller, Johannes, 16,		Salvadori, 17.	Stevenson, 12.	White, G., 9, 10, 18.
17.	Lomelius, 2.	22, 29, 30, 40.		Saunders, 17.	Stöcker, 17.	White, J., 8.
Kramer, 8.	Lunden, 18.	Müller, P. L. S., 7.		Savi, 4, 17.	Strickland, 14, 18.	Willughby, 4, 6, 20,
Kripper, 17.	Lydekker, 44.	Murie, 29.		Saxby, 19.	Sunderland, 3, 17, 22,	22.
Kutter, 17.	Macartney, 16, 24.	Nash, 8.		Schäffer, 7.	27, 30, 31, 34, 37.	Wilson, Alexander, 16.
Labatie, 17.	Macgillivray, 11, 16,	Nathusius, 17.		Schalzer, 17.	38, 39, 41, 44, 45.	Wilson, James, 12.
Leopold, 8.	29, 44.	Neumann, J. A., 8,		Schlegel, 14, 17.	Susemihl, 17.	Wimbor, 2.
Lamarck, 22.	Macleay, 15, 16.	17.		Schoenburgh, 14.	Susmilch, 12.	Wolf, Johann, 17.
Landbeck, 17.	Maignon, 17.	Neumann, J. F., 9, 17,		Schöps, 20.	Swainson, 12, 14, 14,	14.
Landa, 17.	Maitzen, 17.	21, 22.		Schwenckfeld, 4.	16.	16.
Landaer, 24.	Malsan, 17.	Neale, 17.		Schwarz, 12, 13, 16, 37.	Taalé, 17.	Tegelmator, 7.
Latham, 4, 7, 8, 14.	Margrova, 4.	Neuhorn, 17.		29, 41, 43, 44, 46, 47.	Tegelmator, 7.	Temminck, 11, 12, 14,
Laugier, 12.	Marctote, 17.	Neumann, 17.		Scopoli, 7.	17, 21, 22, 23, 45.	17.
Lawrence, 16.	Markwick, 10.	Nierenberg, 4, 15.		Soba, 5.	Thaun, 2.	Thompson, 12.
Leyard, 14.	Marrigll, 8.	Nilsson, 17.		Seebahn, 44.		
Leach, 7.						

ORNITHORHYNCHUS. See PLATYPUS.

ORONTES. See SYRIA.

OROPUS, a Greek seaport, on the Euripus, in the district Παρική, opposite Eretria. It was a border city between Bœotia and Attica, and its possession was a continual source of dispute between the two countries; but at last it came into the final possession of Athens, and is always alluded to under the Roman empire as an Attic town. The actual harbour, which was called Delphinium, was at the mouth of the Asopus, about a mile north of the city. The famous oracle of Amphiarus was situated in the territory of Oropus, 12 stadia from the city. A village still called Oropo occupies the site of the ancient town.

OROSIUS, PAULUS, author of the once widely read *Historiarum adversum Paganos Libri VII.*, was born in Spain towards the close of the 4th century; that he was a native of Tarragona is a somewhat precarious inference from his manner of referring to "Tarraco nostra" in *Hist.* vii. 22. Having entered the Christian priesthood, he naturally took an interest in the Priscillianist controversy then going on in his native country, and it was in connexion with this that he went (or was sent) to consult Augustine at Hippo in 413 or 414. After staying for some time in Africa as the disciple of Augustine, he was sent by him in 415 to Palestine with a letter of introduction to Jerome, then at Bethlehem. The ostensible purpose of his mission (apart, of course, from those of pilgrimage and perhaps relic hunting) was that he might gain further instruction from Jerome on the points raised by the Priscillianists and Origenists; but in reality, it would seem, his business was to stir up and assist Jerome and others against Pelagius, who, since the synod of Carthage in 411, had been living in Palestine, and finding some acceptance there. The result of his arrival was that John, bishop of Jerusalem, was induced to summon at his capital in June 415 a synod at which Orosius communicated the decisions of Carthage and read such of Augustine's writings against Pelagius as had at that time appeared. Success, however,

was scarcely to be hoped for amongst Orientals who did not understand Latin, and whose sense of reverence was unshocked by the question of Pelagius "et quis est mihi Augustinus!" All that Orosius succeeded in obtaining was John's consent to send letters and deputies to Innocent of Rome; and, after having waited long enough to learn the unfavourable decision of the synod of Diospolis or Lydda in December of the same year, he returned to north Africa, where he is believed to have died. According to Gennadius he carried with him recently discovered relics of the protomartyr Stephen from Palestine to the West.

The earliest work of Orosius, *Consultatio sive Commemoratorium ad Augustinum de errore Priscillianistarum et Origenistarum*, explains its object by its title; it was written soon after his arrival in Africa, and is usually printed in the works of Augustine along with the reply of the latter, *Contra Priscillianistas et Origenistas Liber ad Orosium*. His next treatise, *Liber Apologeticus de arbitrii libertate*, was written during his stay in Palestine, and in connexion with the controversy which engaged him there. It occurs in the *Biblioth. Max. Patr.*, and also in Hardouin and Mansi. The *Historiarum adversum Paganos* was undertaken at the suggestion of Augustine, to whom it is dedicated. When Augustine proposed this task he had already planned and made some progress with his own *De Civitate Dei*; it is the same argument that is elaborated by his disciple, namely, the evidence from history that the circumstances of the world had not really become worse since the introduction of Christianity. The work, which is thus a pragmatical chronicle of the calamities that have happened to mankind from the fall down to the Gothic period, has little accuracy or learning, and even less of literary charm to commend it; but its purpose gave it value in the eyes of the orthodox, and the *Historia, Ormista, or Ormista* (Ors[i]l M[un]di Hist[oria]), as it was called, speedily attained a wide popularity. A free abridged translation by King Alfred is still extant (Old English text, with original in Latin, edited by H. Sweet, 1838). The *editio princeps* of the original appeared at Vienna (1471); that of Havercamp (Leyden, 1738 and 1767) has now been superseded by Zangemeister, who has edited the *Hist.* and also the *Lib. Apol.* in vol. v. of the *Corp. Scr. Eccl. Lat.* (Vienna, 1822). The "sources" made use of by Orosius have been investigated by Mörmner (*De Orosii vita ejusque hist. libr. VII. adversum Paganos*, 1844); besides the Old and New Testaments, he appears to have consulted Livy, Justin, Tacitus, Suetonius, Florus, and a cosmography, attaching also great value to Jerome's translation of the *Chronicles* of Eusebius.

ORPHEUS, a very important figure in Greek legend. The name is an ancient Indo-European one; the original *Arhu* can be traced in the *Rihhu* of the Rigveda and the *Alp* or *Elf* of Teutonic folklore. It is, however, impossible to establish any connexion between the Orpheus legend in the highly developed form which alone has come down to us and the beliefs entertained about *Rihhu* and *Elf*. In Greece, Orpheus was always associated with the early Thracian race, which was supposed to have inhabited the neighbourhood of Mount Helicon, the district of Pieria in Macedonia, and the coasts and country generally on the north of the *Ægean* Sea. The religion of the Muses and the religion of Dionysus, with both of which Orpheus is connected, are intimately associated with this race (see *MUSES*). Orpheus was son of the river god *Ægeus* and the Muse *Calliope*. He played so divinely on the lyre that all nature stopped to listen to his music. When his wife *Eurydice* died, he went after her to *Hades*, and the strains of his lyre softened even the stern gods of the dead. *Eurydice* was released, and followed him to the upper world, but he looked back towards her before she was clear of the world of death and she vanished again from his sight. The Thracian women, jealous of his unconquerable love for his lost wife, tore him to pieces during the frenzy of the Bacchic orgies; his head and his lyre floated "down the swift *Hebrus* to the Lesbian shore," where a shrine of Orpheus was built near *Antissa*. The legend, with all its melancholy, its love, and its sympathy with nature, has obviously taken shape in the hands of an early school of lyric poetry, associated with the worship of the Muses; the ancient Thracian *oidoi* are recognized as the earliest singers in Greece, but their art and their Muse-religion have passed to *Lesbos*, which was the chief seat of Greek lyric poetry in the 7th and 6th centuries B.C. The tragic death of Orpheus is obviously connected with the Bacchic ritual (see *OROSIS*). Orpheus is the representative of the god torn to pieces every year by the envious powers of nature, a ceremony that was duly enacted by the *Bacchæ*, in earlier times with a human victim, afterwards with a bull to represent the bull-formed god.

The Orpheus legend is closely analogous with that of *Marsyas*. Orpheus and *Marsyas* are embodiments of the supposed origin of music in *Thrace* and in *Phrygia*, countries inhabited by kindred races, viz., the influences of nature (both being closely connected with river-worship) and the teaching or gift of a goddess. The melancholy history of both must have its origin in the character of the *Thracio-Phrygian* people: the divine gift brings sorrow as well as power. Each uses the musical instrument that characterized his country.

The name of Orpheus is equally important in the religious history of Greece; and in this respect also it is associated with *Thrace*. He was the mythic founder of a religious school or sect, with a code of rules of life, a mystic eclectic theology, a system of purificatory and expiatory rites, and peculiar mysteries. This school is first observable under the rule of *Pisistratus* at Athens in the 6th century B.C. Its doctrines are founded on two elements—(1) the *Thracio-Phrygian* religion of *Bacchus* with its enthusiastic orgies, its mysteries, and its purifications, and (2) the tendency to philosophic speculation on the nature and mutual relations of the numerous gods, developed at this time by intercourse with *Egypt* and the *East*, and by the quickened intercourse between different tribes and different religions in Greece itself. These causes produced similar results in different parts of Greece. The close analogy between *Pythagoreanism* and *Orphism* has been recognized from *Herodotus* (ii. 81) to the latest modern writers. Both inculcated a peculiar kind of ascetic life; both had a mystical speculative

theory of religion, with purificatory rites, abstinence from beans, &c.; but *Orphism* was more especially religious, while *Pythagoreanism*, at least originally, inclined more to be a political and philosophical creed.

The rules of the Orphic life (*βίος Ὀρφικός*) prescribed abstinence from beans, flesh, certain kinds of fish, &c., the wearing of a special kind of clothes, and numerous other practices and abstinences, for all of which reasons were given in religious myths (*ἱεροὶ λόγοι*). The ritual of worship was peculiar, not admitting bloody sacrifices. The belief was taught in the homogeneity of all living things, in the transmigration of souls, in the view that the soul is imprisoned in the body, and that it may gradually attain perfection during connexion with a series of bodies. It is not possible here to treat of the Orphic mysteries (see *Lobeck, Aglaophamus*). The influence of Orphism on the *Eleusinian* mysteries has been described under *MYSTERIES*, and points of similarity and diversity noted. Greek literature was always hostile to the Orphic religion (cf. *Eur., Hipp.*, 952 sq.; *Plato, Rep.*, ii. 364; *Theophr., Char.*, 25).

A large number of writings in the tone of the Orphic religion existed and were ascribed to Orpheus, as the poems of the *Trojan* and *Theban* cycles to *Homer* and *Hesiod*. The real names of the authors of these works were in many cases known to those who inquired into the matter, though the common people believed that all were written before the time of *Homer* by Orpheus (*Herod.*, ii. 53). *Aristotle* declared that there had never been a poet Orpheus. The names of poets of the Orphic cycle can be traced as early as 550 B.C. *Onomacritus* is the most famous of them all (see *ONOMACRITUS*). These poems were recited at rhapsodic contests alongside of *Homeric* and *Hesiodic* works (*Plato, Ion*, 536). Orphic hymns were used in the mysteries at *Phlya* and *Eleusis* (*Paus.*, ix. 27, 2; 30, 5; i. 14). The poems were a favourite subject of study for the *Alexandrian* grammarians. Again in the controversies between *Christian* and *pagan* writers in the 3d and 4th centuries after *Christ* the Orphic religious poems played a great part: *pagan* writers quoted them to show the real meaning of the multitude of gods, while *Christians* retorted by reference to the obscene and disgraceful fictions by which they degraded the gods.

The Orphic literature was united in a *corpus*, entitled τὰ Ὀρφικά, or τὰ εἰς Ὀρφέα ἀναφερόμενα; the different parts were connected, and the whole prefaced by a dedication to *Museus* as son and first initiate of Orpheus. The chief poem was ἡ τοῦ Ὀρφέως θεολογία or μυσθεσία, which existed in several versions, showing considerable variations. There was also a collection of Orphic hymns, containing numerous liturgic songs used in the mysteries and in exoteric ceremonial; also practical treatises, Ἔργα καὶ ἡμέραι, and poems on stones, herbs, and plants, &c. These works have been lost, except fragments collected by *Lobeck*. There exist several poems called Orphic (*Argonautica, Hymns, Lithica*). These are very late works, composed at the time when *paganism* was passing away before *Christianity*.

The story of Orpheus, as was to be expected of a legend told both by *Ovid* and *Boetius* (bk. iii. cap. xxxv.), retained its popularity throughout the *Middle Ages* and was transformed into the likeness of a northern fairy tale. In *English* medieval literature it appears in three somewhat different versions:—*Sir Orpheo*, a "lay of *Brittany*" printed from the *Harleian MS.* in *Ritson's Ancient English Metrical Romances*, vol. ii.; *Orpheo* and *Heurodis* from the *Auchinleck MS.* in *David Laing's Select Remains of the Ancient Popular Poetry of Scotland*; and *Kyng Orfeo* from the *Ashmolean MS.* in *Halliwel's Illustrations of Fairy Mythology* (*Shakespeare Soc.*, 1842). The poems bear trace of *French* influence.

ORPIMENT (*auripigmentum*), the trisulphide of arsenic,  $As_2S_3$ , or yellow realgar, occurs in small quantities as a native mineral of a brilliant golden-yellow colour in *Bohemia*, *Peru*, &c. For industrial purposes an artificial orpiment is manufactured by subliming one part of sulphur with two of arsenious acid. The sublimate varies in colour from yellow to red, according to the intimacy of the combination of the ingredients; and by varying the relative

quantities used many intermediate tones may be obtained. These artificial preparations all contain free arsenious acid, and are therefore highly poisonous. Formerly, under the name of king's yellow, a preparation of orpiment was in considerable use as a pigment, but now it has been largely superseded by chromo-yellow. It was also at one time used in dyeing and calico-printing, and for the unhairing of skins, &c.; but safer and equally efficient substitutes have been found.

ORRERY, EARLS OF. See BOYLE.

ORRIS-ROOT consists of the rhizomes or underground stems of three species of *Iris*, *I. germanica*, *I. florentina*, and *I. pallida*, closely allied plants growing in subtropical and temperate latitudes, but principally identified with North Italy. The three plants are indiscriminately cultivated in the neighbourhood of Florence as an agricultural product under the name of "ghiaggiuolo." The rhizomes form joints of annual growth from 3 to 4 inches long; they branch and give off rootlets at the joints, and when these attain five years of age they begin to decay. When taken out of the ground the branches and rootlets are trimmed off, the brown bark removed, and the separated joints are put up to dry and mature. In its fresh condition orris-root contains an acrid juice and has an earthy odour, but it is quite destitute of the fragrance which ultimately characterizes the substance, and which develops fully only after a lapse of about two years, probably by fermentation. As it comes into the market, orris-root is in the form of contorted sticks and irregular knobby pieces up to 4 inches in length, of a compact chalky appearance, having a delicate but distinct odour of violets. By distillation with water a crystalline body known as orris-camphor or oil of orris, possessing the fragrant properties of orris-root, is obtained. It is present in exceedingly small quantity, from 0.10 to 0.80 per cent., and Professor Flückiger has demonstrated that the crude distillate consists only of myristic acid impregnated with or scented by the essential oil of orris, a body which may never be isolated owing to the necessarily minute quantities in which it could be produced. Orris-root has been a well-known and esteemed perfume from early Greek times. It is principally powdered for use in dentifrices and other scented dry preparations; but to some extent the crude oil is distilled for general perfumery purposes. It is also used in small pellets as issue peas.

ORSINI, FELICE (1819-1858), Italian patriot, was born in December 1819 at a small town in the Roman states not far from Forlì. He was educated for the church, but soon abandoned that career, and joined Mazzini's Young Italy Society in 1838. For engaging in revolutionary projects he was arrested 1st May 1844, and sentenced at Rome to the galleys for life, but by the amnesty proclaimed on the accession of Pius IX. he was restored to liberty. In 1848 he became leader of a band of youthful Romagnoli, distinguishing himself greatly at Vicenza and Treviso; and in 1849 he was chosen a deputy to the Roman parliament. After the suppression of the revolution he became one of the most active agents of Mazzini, and while engaged in a mission to Hungary he was in December 1854 arrested at Hermannstadt and imprisoned at Mantua. A few months afterwards he made his escape by sawing through the bars of his cell, and in 1856 he published a narrative of his prison experiences under the title *Austrian Dungeons in Italy*. Some time after a rupture with Mazzini he went to Paris with the determination to assassinate Napoleon III., whom he regarded as the chief stumbling-block in the way of Italian independence, and the principal cause of the anti-liberal reaction in Europe. While the emperor and empress were returning from the opera on the evening of January 14, 1858, bombs were exploded at their carriage,

but without inflicting any injury on either. In the attempt Orsini had three associates, Pieri, Rudio, and Gomez. Gomez was pardoned, the sentence against Rudio was commuted on the scaffold, but Orsini and Pieri were executed 13th March 1858. Orsini, whose action had an important influence in precipitating the campaign of 1859 (see vol. ix. p. 624), met his fate with great dignity and stoicism.

See *Memoirs and Adventures of Felice Orsini written by himself*, translated by George Carbonel, Edinburgh, 1857; *Lettere Edite ed Inedite di Felice Orsini*, 2 vols., Milan, 1861; *I Contemporanei Italiani—Felice Orsini*, by Enrico Montazio, Turin, 1862; *La Verità sur Orsini, par un ancien Procerit*, 1879.

ORSK (*Yaman-kala* of the Kirghiz), a district town of Orenburg, Russia, 155 miles to the east-south-east of the capital of the government, on the right bank of the Ural, was originally founded in 1735 as the principal Russian fort against the attacks of the Kirghiz. Though this was afterwards transferred to Orenburg, the town of Orsk has increased rapidly within the last few years, owing to the fertility of the surrounding country, to immigration, and to the growth of trade with the Kirghiz. The population, only 6000 some fifteen years ago, reached 14,350 in 1880, and has since become larger.

ORTELIUS, ORTELL, or OERTEL, ABRAHAM, next to Mercator the greatest geographer of his age, was born at Antwerp in 1527, and died in the same city on June 28, 1598. He visited various parts of the Netherlands and Germany (1575), England and Ireland (1577), and Italy on several occasions. His *Theatrum Orbis Terrarum* (published at Antwerp in 1570, and reissued in a revised form five times during his lifetime) was the first modern atlas, Mercator having, it is said, delayed the appearance of his collection out of consideration for his friend. Most of the maps were admittedly reproductions, and no attempt was made to reconcile discrepancies of delineation or nomenclature. To the modern eye even England and Scotland appear with amusing distortions (the Mons Grampius, e.g., lies between the Forth and the Clyde); but, taken as a whole, the noble folio, with its well-nigh one hundred maps, and its careful accompaniment of text, was a monument of rare erudition and industry; and the author well deserved the appointment to be cosmographer to Philip II. bestowed upon him in 1575. A few years later he laid the basis of a critical treatment of ancient geography by his *Synonymia geographica* (Antwerp, 1578), reissued as *Thesaurus geographicus* in 1596. Other works from his pen are *Itinerarium per nonnullas Gallias Belgicas partes*, 1584 (reprinted in Hegenitius, *Itin. Frisio-Holl.*); *Deorum dearumque capita*, 1573 (reprinted in Gronovius, *Thea. Gr. Ant.*, vol. vii.).

See Marodo in *Annales des Voyages*, II., and Girard in *Bull. de la Soc. géogr. d'Anvers*, 1880.

ORTHONYX, the scientific name given in 1820, by Temminck, to a little bird, which, from the straightness of its claws,—a character somewhat exaggerated by him,—its large feet and spiny tail, he judged to be generically distinct from any other form. Concerning its affinities much doubt has long prevailed, and this has been only lately set at rest. The typical species, *O. spinicauda*, is from south-eastern Australia, where it is said to be very local in its distribution, and strictly terrestrial in its habits. In the course of time two other small birds from New Zealand, where they are known as the "Whitehead" and "Yellowhead," were referred to the genus, under the names of *O. albicilla*<sup>1</sup> and *O. ochrocephala*, and then the question of its affinity became more interesting. By some systematists it was supposed to belong to the otherwise purely Neotropical *Dendrocolaptidae*, and in that case would have been the sole representative of the Tracheo-

<sup>1</sup> It may be charitably conjectured that the nomenclator intended to write *albicapilla*.

phone *Passeres* in the Australian Region. Others considered it one of the nearest relatives of *Menura*, and if that view were correct it would add a third form to the small section of *Pseudoscines* (see LYRE-BIRD, vol. xv. p. 115); while Sundevall, in 1872, placed it not far from *Timelia*, among a group the proper sorting of which will probably for years tax the ingenuity of ornithologists. The late Mr W. A. Forbes shewed (*Proc. Zool. Soc.*, 1882, p. 544) that this last position was the most correct, as *Orthonyx spinicauda* proved on dissection to be one of the true *Oscines*, but yet to stand, so far as is known, alone among birds of that group, or any other group of *Passeres*, in consequence of the superficial course taken by the (left) carotid artery, which is nowhere contained in the subvertebral canal. Whether this discovery will require the segregation of the genus as the representative of a separate Family *Orthonyxidae*—which has been proposed by Mr Salvin (*Catal. Coll. Strickland*, p. 294)—remains to be seen. Forbes also demonstrated that one at least of the two New-Zealand species above mentioned, *O. ochrocephala*, had been wrongly referred to this genus, and they therefore at present stand as *Clitonyx*. This is a point of some little importance in its bearing on the relationship of the fauna of the two countries, for *Orthonyx* was supposed to be one of the few genera of Land-birds common to both.

The typical species of *Orthonyx*—for the scientific name has been adopted in English—is rather larger than a Skylark, coloured above not unlike a Hedge-Sparrow. The wings are, however, barred with white, and the chin, throat, and breast are in the male pure white, but of a bright reddish-orange in the female. The remiges are very short, rounded, and much incurved, showing a bird of weak flight. The rectrices are very broad, the shafts stiff, and towards the tip divested of barbs. Two other species that seem rightly to belong to the genus have been described—*O. spaldingi* from Queensland, of much greater size than the type, and with a jet-black plumage, and *O. novz-guineae*, from the great island of that name, which seems closely to resemble *O. spinicauda*. (A. N.)

ORTOLAN (French, *Ortolan*), the *Emberiza hortulana* of Linnæus, a bird so celebrated for the delicate flavour of its flesh as to have become proverbial. A native of most European countries—the British Islands (in which it occurs but rarely) excepted—as well as of western Asia, it emigrates in autumn presumably to the southward of the Mediterranean, though its winter quarters cannot be said to be accurately known, and returns about the end of April or beginning of May. Its distribution throughout its breeding-range seems to be very local, and for this no reason can be assigned. It was long ago said in France, and apparently with truth, to prefer wine-growing districts; but it certainly does not feed upon grapes, and is found equally in countries where vineyards are unknown—reaching in Scandinavia even beyond the arctic circle—and then generally frequents corn-fields and their neighbourhood. In appearance and habits it much resembles its congener the YELLOW-HAMMER (*q.v.*), but wants the bright colouring of that species, its head for instance being of a greenish-grey instead of a lively yellow. The somewhat monotonous song of the cock is also much of the same kind; and, where the bird is a familiar object to the country people, who usually associate its arrival with the return of fair weather, they commonly apply various syllabic interpretations to its notes, just as our boys do to those of the Yellow-hammer. The nest is placed on or near the ground, but the eggs seldom shew the hair-like markings so characteristic of those of most Buntings. Ortolans are netted in great numbers, kept alive in an artificially lighted or darkened room, and fed with oats and other seeds. In a very short time they become enormously fat,

and are then killed for the table. If, as is supposed, the Ortolan be the *Miliaria* of Varro, the practice of artificially fattening birds of this species is very ancient. In French the word *Ortolan* is used so as to be almost synonymous with the English "Bunting"—thus the *Ortolan-de-neige* is the Snow-Bunting (*Plectrophanes nivalis*), the *Ortolan-de-ris* is the Rice-bird or "Bobolink" of North America (*Dolichonyx oryzivorus*), so justly celebrated for its delicious flavour; but the name is also applied to other birds much more distantly related, for the *Ortolan* of some of the Antilles, where French is spoken, is a little Ground-Dove of the genus *Chamaepelia*.

In Europe the *Beccafico* (Fig-eater) shares with the Ortolan the highest honours of the dish, and this may be a convenient place to point out that the former is a name of equally elastic signification. The true *Beccafico* is said to be what is known in England as the Garden-Warbler (the *Motacilla salicaria* of Linnæus, the *Sylvia hortensis* of many writers); but in Italy any soft-billed small bird that can be snared or netted in its autumnal emigration passes under the name in the markets and cook-shops. The "Beccafico," however, is not as a rule artificially fattened, and on this account is preferred by some sensitive tastes to the Ortolan. (A. N.)

ORVIETO, a town in Umbria, Italy, on the main road from Florence to Rome, situated on an almost isolated volcanic rock, about 770 feet above the plain. It is now the capital of a province, the seat of a bishop, and in 1881 had a population of 8626. The town is of Etruscan origin, and is said to have joined the Volscians in their war against Rome; it is the *Urbidentum* of Procopius (with which the *Herbanum* of Pliny has been conjecturally identified), and the mediæval *Urbs Vetus* (whence the modern name). Owing to the strong Guelphic sympathies of the inhabitants, and the inaccessible nature of the site, Orvieto has been constantly used as a place of refuge by the popes, of whom no less than thirty-two have at different times found shelter there. The town is very picturesque, both from its magnificent position and also from the unusually large number of fine 13th-century houses and palaces which still exist in its streets. The chief glory of the place is its splendid cathedral, dedicated to the Virgin; it was founded in 1290 by Nicholas IV. on the site of an older church; it was designed by Lorenzo Maitani, a Siennese architect, and from the 13th till the 16th century was enriched by the labours of a whole succession of great Italian painters and sculptors (see ΟΡΘΟΝΑ). The exterior is covered with black and white marble; the interior is of grey limestone with bands of a dark basaltic stone. The plan consists of large rectangular nave, with semicircular recesses for altars, opening out of the aisles, north and south. There are two transeptal chapels, and a short choir. The most magnificent part of the exterior is the west façade, built of richly-sculptured marble, divided into three gables with intervening pinnacles, much resembling the front of Siena cathedral, the work of the same architect. The mosaics are modern, and the whole church has suffered greatly from recent "restoration." The four wall-surfaces that flank the three western doorways are decorated with very beautiful sculpture in relief, once ornamented with colour, the work mainly of pupils of Niccolò Pisano, at the end of the 13th century. This at least is Vasari's statement. Giovanni Pisano, Arnolfo del Cambio, and Fra Guglielmo da Pisa were the chief of these. The subjects are scenes from the Old and New Testaments, and the Final Doom, with Heaven and Hell. In the interior on the north, the Cappella del Corporale possesses a large silver shrine, enriched with countless figures in relief and subjects in translucent coloured enamels—*one of the most important specimens of early silver-*

smith's work that yet exists in Italy. It was begun by Ugolino Veri of Siena in 1338, and was made to contain the Holy Corporal from Bolsena, which, according to the legend, became miraculously stained with blood during the celebration of mass to convince a sceptical priest of the truth of the doctrine of transubstantiation. This is supposed to have happened in the middle of the 13th century, while Urban IV. was residing at Orvieto; and it was to commemorate this miracle that the existing cathedral was built. On the south side is the chapel of S. Brizio, separated from the nave by a fine 14th-century wrought-iron screen. The walls and vault of this chapel are covered with some of the best-preserved and finest frescoes in Italy—among the noblest works of Fra Angelico, his pupil Benozzo Gozzoli, and Luca Signorelli, mainly painted between 1450 and 1501,—the latter being of especial importance in the history of art owing to their great influence on Michelangelo in his early days (see Symonds, *Renaissance in Italy—Fine Arts*, pp. 278–291). The choir stalls are fine and elaborate specimens of *tarsia* and rich wood-carving—the work of various Sienese artists in the 14th century. In 16th-century sculpture the cathedral is especially rich, containing many statues, groups, and altar-reliefs by Simone Mosca, Ippolito Scalza, and Gian di Bologna,—some of them well designed and carefully executed, but all showing strongly the rapid decay into which the art of that time was falling. The well, now disused, called *Il pozzo di S. Patrizio*, is one of the chief curiosities of Orvieto. It is 180 feet deep to the water-level and 46 feet in diameter, cut in the rock, with a double winding inclined plane, so that oxen could ascend and descend to carry up the water from the bottom. It was begun by the architect San Gallo in 1527 for Clement VII., who fled to Orvieto after the sack of Rome, and was finished by Simone Mosca under Paul III. It resembles in many respects the "Well of Joseph" (Saladin) in the citadel of Cairo. The Palazzo Faina has an interesting collection of objects found in Etruscan tombs, of which a large number exist in the neighbourhood of Orvieto. The church of S. Domenico contains one of the finest works in sculpture by Arnolfo del Cambio. This is the tomb with recumbent effigy of the Cardinal Brago or De Braye (1282), with much beautiful sculpture and mosaic. It is signed *HOC OPVS FECIT ARNVLVS*. It was imitated by Giovanni Pisano in his monument to Pope Benedict XI. at Perugia.

See Guglielmo della Valle, *Storia del Duomo di Orvieto* (1791), and *Stamps del Duomo di Orvieto* (1791); Luzzi, *Descrizione del Duomo di Orvieto*, &c., 1836; Cicognara, *Storia della Scultura*, 2d ed., 1823–24; Perkins, *Tuscan Sculptors*, 1864; Vasari, *Vite dei pittori*, &c., Milanese's ed., 1878–82; Gruner, *Die Basreliefs des Doms zu Orvieto*, 1858; Crowe and Cavalaselle, *Painting in Italy*, vols. I. and III., 1866; Benoist, *Cathédrale d'Orvieto*, 1877. For Etruscan remains see Dennis, *Cities of Etruria*, II. p. 86, 1878.

**ORYEKHOFF-ZUYEFF**, or **ORYEKHOVSKIY POGOST**, a village of European Russia, in the Pokroff district of the Vladimir government, 12 miles west of Pokroff by rail, on the Klyazma, a tributary of the Volga. A great cotton factory in the vicinity has become the centre of a new town, which is called after the village, but also frequently *Nikolskoye*. About 12,600 hands are employed in the cotton manufacture itself, and about 6000 in digging peats and making bricks for the firm. There are forty-two steam engines (978 horse-power), and goods were manufactured to the value of 8,328,000 roubles in 1881 (2,590,000 in 1861). The cotton is procured from Asia and western Europe, and the goods are sold throughout southern and south-eastern Russia.

**OSBORN, SHEPARD** (1822–1875), English admiral and explorer, was the son of Lieutenant-Colonel Osborn of the Madras army, and was born 25th April 1822. Entering

the navy as a first-class volunteer in 1837, he was in the following year entrusted, though only a midshipman, with the command of a gunboat, the "Emerald," at the attack on Kedah. He was present at the reduction of Canton in 1841, and at the capture of the batteries of Woon-sung in the following year. Having passed lieutenant in 1844, he was in the same year appointed gunnery mate of the "Collingwood," under Sir George Seymour in the Pacific. On account of his interest in the fate of many of his friends and messmates, he took a prominent part in advocating a new search expedition for Sir John Franklin. When it was agreed upon he was appointed to the command of one of the ships, and performed a remarkable sledge journey to the western extremity of Prince of Wales Island, of which he published an account entitled *Stray Leaves from an Arctic Journal*, 1852. In the new expedition fitted out in the spring of that year he also took part as commander of the "Pioneer," and, after spending two trying winters up Wellington Channel, returned home in 1855. In 1856 he published the journals of Robert M'Clure, giving a narrative of the discovery of the North-West Passage. Shortly after his return he was called to active service in connexion with the Russian war; and in command of a light squadron of gunboats on the Sea of Azoff he distinguished himself in the destruction of the stores of the enemy at various points on the coast. Receiving post rank, he was appointed to the "Medusa," in which he continued to command the Sea of Azoff squadron until the conclusion of peace. As commander of the "Furious" he took a prominent part in the second Chinese war, during which he performed the remarkable feat of proving the navigability of the Yang-tze, by taking the "Furious" as far up the river as Hankow, 600 miles from the sea. In 1859 he returned to England in broken health, and to support his family engaged in literary pursuits, contributing many important articles to *Blackwood's Magazine*, and publishing in December of that year *The Career, Last Voyage, and Fate of Sir John Franklin*. In 1864 he was appointed to the command of the "Royal Sovereign," to assist Captain Coles in his experiments regarding the turret system of shipbuilding. Retiring soon afterwards on half pay, he was in 1865 appointed agent to the Great Indian Peninsula Railway Company, and in 1867 managing director of the Telegraph Construction and Maintenance Company, for the construction of a submarine system of telegraphy between Great Britain and her Eastern and Australian dependencies. In 1873 he was promoted rear-admiral. Continuing to interest himself in Arctic exploration, he induced A. H. Markham to visit Baffin's Bay in a whaler to report on the possibility of ice-navigation with the aid of steam. A record of his observations was published under the title of a *Whaling Cruise to Baffin's Bay* in 1873, with the result that a new Arctic expedition was fitted out in 1874. Osborn died 6th May 1875.

**OSCAN**, or **OPICAN**, was the name given both by Greeks and Romans to one of the ancient nations of central Italy. There can be no doubt that the original form of the name was *Opicus*, which, as we learn from Festus, was still used by Ennius. This the Greeks softened into *Opicus*, while the Latin writers always used *Oscus* as a national appellation, though they occasionally employ the term "*opicus*" in the sense of barbarous or ignorant. It is singular that, though there can be no doubt the name was a national one, it is not found in history as the name of any particular nation. No mention occurs of the *Oscans* among the populations of Italy that were successively reduced by the Roman arms; but we learn incidentally from a passage in Livy (x. 20) that the language of the Samnites and Campanians was *Oscan*; and it is cer-



tan that this continued to be the vernacular tongue of the people of Italy until long after the Roman conquest. Of the ethnical affinities or origin of the Oscans we know nothing, except what may be gathered philologically from the remains of their language; and their relations with the Samnites and other Sabellian tribes, whom we find during the historical period settled in this part of Italy, are extremely obscure. Perhaps the most plausible theory is that they were in very early times the inhabitants of the regions subsequently occupied by a race of invaders from the north, who were known as Sabines, Samnites, and Sabellians, but who, being comparatively few in numbers, and in an inferior stage of civilization, gradually adopted the language of the conquered race (see ITALY, vol. xiii. p. 445).

It is certain that the Oscan language continued in common use as a vernacular dialect till the close of the Roman republic. Ennius boasted that he was possessed of three tongues because he could speak Latin, Greek, and Oscan (Gell. vii. 17); and at the time of the Social War (88 a.c.) the allies made an attempt to introduce it as the official language, and struck coins with Oscan inscriptions bearing the names of Vitellius (for Italia), Safinum, &c. After the failure of that movement there can be no doubt that the language was never again employed for official purposes, though it would linger long in use among the rustic populations of the mountains. Nor was it altogether without a literature, for the *Fabula Atellana*, a kind of rude farces popular among the Romans, not only derived their names and origin from the Oscan district of Campania, but were undoubtedly in the first instance composed and recited in the Oscan dialect. The monuments of the language which have been preserved to us by inscriptions are much more numerous than those of any other ancient Italian dialect. The principal of them are enumerated in the article above referred to, and they are all collected and examined in detail by Professor Mommsen in his *Unteritalischen Dialekte* (Leipzig, 1850). The general result is that the Oscan language must have resembled the Latin much more closely than any other of the Italian dialects, but wanted almost entirely the Greek or Pelasgic element which is found so distinctly in the more cultivated language, and which formed the basis of the Messapian and other dialects of the southern part of the Italian peninsula.

See Hasehko, *Die Oskischen und Sabellischen Denkmäler*, Elberfeld, 1856.

**OSHKOSH**, a city of the United States, capital of Winnebago county, Wisconsin, stretches from the west side of Lake Winnebago for about 3 miles up Fox River to Lake Buttes des Morts, and covers an area of about 2 square miles. By rail the distance from Milwaukee is 84 miles. Oshkosh is the seat of the United States district court for the eastern district of Wisconsin; and, besides the court-house, it contains the State normal school, a fine high school, and two opera-houses. The leading industry is the manufacture of sashes, doors, and blinds. Lumber shingles, matches, trunks, and carriages are also manufactured, and there are foundries, match-factories, flour-mills, and breweries. The population was 6085 in 1860, 12,663 in 1870, and 15,748 in 1880. Oshkosh may be said to date from 1836; it was incorporated in 1853. In 1859, 1866, 1874, and 1875 it suffered severely from conflagrations.

**OSIANDER, ANDREAS** (1498-1552), German Reformer, was born at Gunzenhausen, near Nuremberg, on December 19, 1498. His German name was Heiligmann, or, according to others, Hosemann. After studying at Leipsic, Altenburg, and Ingolstadt, he was ordained in 1520 to the priesthood, when he became Hebrew tutor in the Augus-

tinian convent at Nuremberg. Two years afterwards he was appointed preacher in the St Lorenz Kirche, and about the same time he publicly joined the Lutheran party, taking a prominent part in the discussion which ultimately led to the adoption of the Reformation by the city. He married in 1525. As a theologian of recognized ability and influence, he was present at the Marburg conference in 1529, at the Augsburg diet in 1530, and at the signing of the Smalkald articles in 1537, and took part in other public transactions of importance in the history of the Reformation; if he had an exceptionally large number of personal enemies the circumstance can be readily explained by his vehemence, coarseness, and arrogance as a controversialist. The introduction of the Augsburg Interim in 1548 necessitated his departure from Nuremberg; he went first to Breslau, and afterwards settled at Königsberg as professor in the new university there at the call of Duke Albert of Prussia. Here in 1550 he published two disputations, the one *De Lege et Evangelio* and the other *De Justificatione*, which aroused a vehement controversy that was not brought to a close by his death in 1552 (October 17). The nature of the dispute has been indicated elsewhere (see LUTHERANS, vol. xv. p. 85). The party was afterwards led by Funk, Oslander's son-in-law, but disappeared after his execution for high treason in 1566.

Oslander, besides a number of controversial writings, published a corrected edition of the Vulgate, with notes, in 1522, and a *Harmony of the Gospels*—the first work of its kind—in 1537. His son Lukas Oslander (1534-1604), a prominent ecclesiastic in Würtemberg, published a *Biblia Latina ad fontes Hebr. text. emendata cum brevi et perspicua expositione illustrata* (1578-86) in seven quarto volumes, which was highly appreciated in its day, an *Institutio Christianæ Religionis* (1576), and, his best-known work, an *Epitoma of the Magdeburg Centuria*. Several other Oslanders, also descendants of Andreas, figure with more or less prominence in the theological literature of Germany.

**OSIRIS**. See EGYPT, vol. vii. p. 716.

**OSKALOOSA**, a city of the United States, capital of Mahaska county, Iowa, about 55 miles south-east of Des Moines. It lies on high ground between the Des Moines and the South Skunk, in a fine agricultural district, with coal and iron mines in the vicinity; and it contains two colleges—Oskaloosa College (1861), belonging to the "Disciples," and Penn College (1873), a Quaker institution—flour-mills, wool-factories, iron and brass foundries, lumber yards, &c., and an artesian well 2900 feet deep. The population, 3204 in 1870 and 4598 in 1880, is estimated at over 7000 in 1884.

**OSMAN**. This transcription of the Arabic name 'Othmán (which first appears in history as borne by the famous companion of Mohammed, and third caliph, see vol. xvi. pp. 548, 563) corresponds to the pronunciation of the Persians and Turks, and is therefore commonly used in speaking of Osman I. Gházi, the founder of the dynasty of Osmanli or Ottoman Turks. He took the title of sultan in 699 A.H. (1299 A.D.), ruled in Asia Minor, and died in 726 A.H. Osman II., the sixteenth Ottoman sultan, came to the throne in 1616 A.D., and was strangled in a sedition of the Janissaries in 1621. See TURKEY.

**OSMIUM**. See PLATINUM.

**OSNABRÜCK**, a prosperous manufacturing town of Prussia, the see of a Roman Catholic bishop, and the capital of a district of its own name in the province of Hanover, is pleasantly situated on the Hase, 70 miles to the west of the town of Hanover. The older streets are narrow and crooked, containing many interesting examples of Gothic and Renaissance domestic architecture, while the substantial houses of the modern quarters testify to the present well-being of the town. The old fortifications have been converted into promenades. The Roman Catholic cathedral, with its three towers, is a spacious building of the 12th century, partly in the Romanesque and partly in



the Transitional style; but it is inferior in architectural interest to the Marienkirche, a fine Gothic structure of the 14th century. The town-house contains portraits of the plenipotentiaries engaged in concluding the peace of Westphalia, the negotiations for which were partly carried on here. Among the other principal buildings are the episcopal residence, the law courts, the two gymnasia, the commercial school, and various other educational and charitable institutions. The museum contains antiquities and objects of natural history. The lunatic asylum on the Gertrudenberg occupies the site of an ancient nunnery. Linen was formerly the staple product of Osnabrück, but no longer takes so prominent a position among its manufactures, which now include paper, dyes, chemicals, machinery, nails, pianos, tobacco, and cotton. There are also large iron and steel works and a rolling mill. A brisk trade is carried on in grain, drugs, linen, and Westphalian hams, and important cattle and horse fairs are held here at regular intervals. Osnabrück contains (1880) 32,812 inhabitants, one-third of whom are Roman Catholics. The patriotic writer and philanthropist Julius Möser (1720-94) was a native of Osnabrück, and has a statue in the cathedral square.

Osnabrück is a place of very ancient origin, and in 888 received the right to establish a mint, an annual fair, and a custom-house. It was surrounded with walls towards the close of the 11th century. The bishopric to which it gave name was founded by Charlemagne after the subjugation of the Saxon inhabitants of the district (c. 790), and embraced what was afterwards the south-west part of the kingdom of Hanover. The town maintained a very independent attitude towards its nominal rulers, the bishops, and joined the Hanseatic League. It reached the height of its prosperity in the 15th century, but the decay inaugurated by the disensions of the Reformation was accelerated by the trials of the Thirty Years' War. The peace of Westphalia decreed that the bishopric of Westphalia should be held alternately by a Roman Catholic and a Protestant bishop, and this curious state of affairs lasted down to its secularization in 1803. The last bishop was the late duke of York. Since 1859 Osnabrück has again been the seat of a Roman Catholic bishop, who, of course, has no territorial jurisdiction. The revived prosperity of the town dates from the middle of last century.

OSORIO, GERONIMO (1506-1580), "the Cicero of Portugal," belonged to a noble family, and was born at Lisbon in 1506. After studying languages at Salamanca, philosophy at Paris, and theology at Bologna, he rose through successive ecclesiastical dignities to the bishopric of Sylves. He evaded the necessity of accompanying Dom Sebastian on his first African expedition (which he did all in his power to discourage) only by setting out for Rome, where he was well received by Gregory XIII. The disaster which overtook the Portuguese arms at Alcazarquivir in 1578 had a serious effect on Osorio's health and spirits; he withdrew into solitude, and died at Tavira on August 20, 1580.

His principal work, a history of the reign of King Emmanuel I. (*De rebus Emmanuelis Lusitanis regis invictissimi virtute et auspicio domi fortisq; gestis libri XII.*, 1571), undertaken at the request of Cardinal Henry, entitles him to considerable literary rank, not only by pure Latinity and artistic arrangement, but also by historical accuracy and insight, as well as by impartiality and elevation of tone. An English translation appeared in 1752; and versions in French, German, and Dutch also exist. Osorio's *De gloria libri V.* (1552), and his double treatise *De nobilitate civili et de nobilitate Christiana* (1542) have been often reprinted; of the former D'Alembert is reported to have declared that it was really a production of Cicero's palmæd off by the modern as his own. Osorio also published *De regis institutione et disciplina libri VIII.* (1574) and a large mass of theological matter, including commentaries on the Epistle to the Romans, the Gospel according to John, and some of the minor prophets. His *Admonitio* and *Epistola* to Queen Elizabeth of England are polemical treatises. The *Opera Omnia* of Osorio were collected and published at Rome by his nephew in 1592 (4 vols. folio).

OSPREY, or OSPRAY, a word said to be corrupted from "Ossifrage," in Latin *Ossifraga* or bone-breaker. The *Ossifraga* of Pliny (*H. N.*, x. 3) and some other classical writers seems, as already said, to have been the LÄMMER-GEYER (vol. xiv. p. 244); but the name, not inapplicable

in that case, has been transferred—through a not uncommon but inexplicable confusion—to another bird which is no breaker of bones, save incidentally those of the fishes it devours.<sup>1</sup> The Osprey is a rapacious bird, of middling size and of conspicuously-marked plumage, the white of its lower parts, and often of its head, contrasting sharply with the dark brown of the back and most of its upper parts when the bird is seen on the wing. It is the *Falco haliaetus* of Linnæus, but unquestionably deserving generic separation was, in 1810, established by Savigny (*Ois. de l'Égypte*, p. 35) as the type of a new genus which he was pleased to term *Pandion*—a name since pretty generally accepted. It has commonly been kept in the Family *Falconidae*, but of late regarded as the representative of a separate Family, *Pandionidae*, for which view not a little can be said.<sup>2</sup> *Pandion* differs from the *Falconidae* not only pterylogically, as long ago observed by Nitzsch, but also osteologically, as pointed out by M. Alphonse Milne-Edwards (*Ois. Foss. France*, ii. pp. 413, 419), and it is a curious fact that in some of the characters in which it differs structurally from the *Falconidae*, it agrees with certain of the Owls; but the most important parts of its internal structure, as well as of its pterylosis, quite forbid a belief that there is any near alliance of the two groups.

The Osprey is one of the most cosmopolitan Birds-of-Prey. From Alaska to Brazil, from Lapland to Natal, from Japan to Tasmania, and in some of the islands of the Pacific, it occurs as a winter-visitant or as a resident. The countries which it does not frequent would be more easily named than those in which it is found—and among the former are Iceland and New Zealand. Though migratory in Europe at least, it is generally independent of climate. It breeds equally on the half-thawed shores of Hudson's Bay and on the cays of Honduras, in the dense forests of Finland and on the barren rocks of the Red Sea, in Kamchatka and in West Australia. Where, through abundance of food, it is numerous—as in former days was the case in the eastern part of the United States—the nests of the Fish-Hawk (to use its American name) may be placed on trees to the number of three hundred close together. Where food is scarcer and the species accordingly less plentiful, a single pair will occupy an isolated rock, and jealously expel all intruders of their kind, as happens in Scotland.<sup>3</sup> The lover of birds cannot see many more enjoyable spectacles than an Osprey engaged in fishing—poising itself aloft, with upright body, and wings beating horizontally, ere it plunges like a plummet beneath the water, and immediately after reappears shaking a shower of drops from its plumage. The feat of carrying off an Osprey's eggs is often difficult, and attended with some risk, but has more than once tempted the most daring of birds' nesters. Apart from the dangerous situation not unfrequently chosen by the birds for their eyry,—a steep rock in a lonely lake, only to be reached after a

<sup>1</sup> Another supposed old form of the name is "Orfraie"; but that is said by M. Rolland (*Faune popul. France*, fl. p. 9, note), quoting M. Suchler (*Zeitschr. Röm. Philol.*, i. p. 432), to arise from a mingling of two wholly different sources:—(1) *Orisparagus*, *Orisparagus*, *Orprais*, and (2) *Ossifraga*. "Orfraie" again is occasionally interchanged with *Épfraie* (which, through such dialectical forms as *Fressaie*, *Fressaie*, is said to come from the Latin *præsaia*), the ordinary French name for the Barn-Owl, *Aluco flammeus* (see OWL, *infra*, p. 91); but the subject is too complex for any but an expert philologist to treat. According to Prof. Skcat's *Dictionary* (l. p. 408), "Osprey" is the oldest English form; but "Osprey" dates from Cotgrave at least.

<sup>2</sup> Mr Sharpe goes further, and makes a "Suborder" *Pandionæ*; but the characters on which he founds such an important division are obviously inadequate. The other genus associated with *Pandion* by him has been shown by Mr Gurney (*Ibis*, 1878, p. 455) to be nearly allied to the ordinary Sea-Eagle (*Haliaeetus*), and therefore one of the true *Falconidae*.

<sup>3</sup> Two good examples of the different localities chosen by this bird for its nest are illustrated in *Ootheca Wollayana*, pla. B. & H.

long swim through chilly water, or the summit of a very tall tree,—their fierceness in defence of their eggs and young is not to be despised. Men and boys have had their head gashed by the sharp claw of the angry parent, and this happening when the robber is already in a precarious predicament, and unable to use any defensive weapon, renders the enterprise formidable. But the prize is worthy of the danger. Few birds lay eggs so beautiful or so rich in colouring: their white or pale ground is spotted, blotched, or marbled with almost every shade of purple, orange, and red—passing from the most delicate lilac, buff, and peach-blossom, through violet, chestnut, and crimson, to a nearly absolute black. A few years ago some of the best-informed ornithologists were led to think that persecution had exterminated the Osprey from Great Britain, except as a chance visitant. This opinion proved to be incorrect, and at the present time the bird is believed still to breed in at least two counties of Scotland, but the secret of its resorts is carefully guarded by those who wish to retain it as a member of the country's fauna, for publication would doubtless speedily put an end to its occupancy. (A. N.)

**OSRHOENE, or ORRHOENE**, the district of western Mesopotamia of which Edessa was the capital (see *MESOPOTAMIA*, vol. xvi. p. 47). It may be here added that the older form of the name appears to be Choroene (Chouroene). Edessa or Orrhoi thus appears to have been "the city of Chosrau," implying an early Parthian influence. See G. Hoffmann in *Z. D. M. G.*, xxxii. 743.

**OSSETI-CUM-GAWTHORPE**, a township and urban sanitary district in the West Riding of Yorkshire, including the contiguous hamlets of Ossett, South Ossett, and Gawthorpe, is situated about 3 miles west-north-west of Wakefield, and  $1\frac{1}{2}$  north-west from the Horbury station on the Lancashire and Yorkshire Railway. The Great Northern Railway has two stations in the township. The church of the Holy Trinity, a fine cruciform structure in the Early Decorated style, was erected in 1865 at a cost of £20,000. There are woollen cloth and mungo mills, and in the neighbourhood extensive collieries. The population of the township (3105 acres) in 1871 was 9190, and in 1881 it was 10,957.

**OSSIAN, or OISIN**. See *CELTIC LITERATURE*, vol. v. pp. 311, 313, and *GÆLIC LITERATURE*, vol. x. p. 13.

**OSSOLI, SARAH MARGARET FULLER, MARCHIONESS**, (1810-1850), an American authoress, was the eldest child of Timothy Fuller, a lawyer and politician of some eminence, and was born at Cambridge Port, Massachusetts, 23d May 1810. Her education was conducted by her father, who, she states, made the mistake of thinking to "gain time by bringing forward the intellect as early as possible," the consequence being "a premature development of brain that made her a youthful prodigy by day, and by night a victim of spectral illusions, nightmare, and somnambulism." At six years she began to read Latin, and at a very early age she had selected as her favourite authors Shakespeare, Cervantes, and Molière. Soon the great amount of study exacted of her ceased to be a burden, and reading became a habit and a passion. Having made herself familiar with the masterpieces of French, Italian, and Spanish literature, she in 1833 began the study of German, and within the year had read some of the masterpieces of Goethe, Körner, Novalis, and Schiller. Her father dying in 1835, she went in 1836 to Boston to teach languages, and in 1837 she was chosen principal teacher in the Green Street school, Providence, Rhode Island, where she remained till 1839. From this year until 1844 she stayed at different places in the immediate neighbourhood of Boston, forming an intimate acquaintance with the colonists of Brook Farm, and number-

ing among her closest friends R. W. Emerson, Nathaniel Hawthorne, and W. E. Channing. In 1839 she published a translation of Eckermann's *Conversations with Goethe*, which was followed in 1841 by a translation of the *Letters of Gûnderode and Bettina*. Aided by R. W. Emerson and George Ripley, she in 1840 started *The Dial*, a poetical and philosophical magazine representing the opinions and aims of the New England Transcendentalists. This journal she continued to edit for two years, and while in Boston she also conducted conversation classes for ladies in which philosophical and social subjects were discussed with a somewhat over-accentuated earnestness, and which may be regarded as perhaps the beginning of the modern movement in behalf of women's rights. R. W. Emerson, who had met her as early as 1836, thus describes her appearance:—"She was then twenty-six years old. She had a face and frame that would indicate fulness and tenacity of life. She was rather under the middle height; her complexion was fair, with strong fair hair. She was then, as always, carefully and becomingly dressed, and of ladylike self-possession. For the rest her appearance had nothing prepossessing. Her extreme plainness, a trick of incessantly opening and shutting her eyelids, the nasal tone of her voice, all repelled; and I said to myself we shall never get far." On fuller acquaintance this unprepossessing exterior seemed, however, to melt away, and her inordinate self-esteem to be lost in the depth and universality of her sympathy. She possessed an almost irresistible power of winning the intellectual and moral confidence of those with whom she came in contact, and "applied herself to her companion as the sponge applied itself to water." She obtained from each the best they had to give. It was indeed more as a conversationalist than as a writer that she earned the title of the Priestess of Transcendentalism. It was her intimate friends who admired her most. Smart and pungent though she is as a writer, any originality that seems to characterize her views partakes more of wayward eccentricity than either intellectual depth or imaginative vigour. In 1844 she removed to New York to become contributor to *The Tribune*, and in 1846 she published a selection from her criticisms on contemporary authors in Europe and America, under the title *Papers on Art and Literature*. The same year she paid a visit to Europe, passing some time in England and France, and finally taking up her residence in Italy. There she was married in December 1847 to the Marquis Giovanni Angelo Ossoli, a friend of Mazzini. During 1848-49 she was present with her husband in Rome, and when the city was besieged she, at the request of Mazzini, took charge of one of the two hospitals while her husband fought on the walls. In May 1850, along with her husband and infant son, she embarked at Leghorn for America, but when they had all but reached their destination the vessel was wrecked on Fire Island beach, and the Ossolis were among the passengers who perished.

The *Autobiography of Margaret Fuller Ossoli*, with additional Memoirs by J. F. Clarke, R. W. Emerson, and W. E. Channing, was published in 1852, the last edition being that of 1874. See also *Margaret Fuller (Marchesa Ossoli)*, by Julia Ward Howe, 1888, in the Eminent Women Series. Her collected works were also published in 1874.

**OSTADE**. The Ostadets are Dutch painters of note, whose ancestors were settled at Eyndhoven, near the small village of Ostaden, from which they took their name. Early in the 17th century Jan Hendricx, a weaver, moved with his family from Eyndhoven to Haarlem, where he married and founded a large family. The eldest and youngest of his sons became celebrated artists.

**I ADRIAN OSTADE** (1610-1685), the first of Jan Hendricx's boys, was born at Haarlem shortly before the 10th December 1610, when he was christened in presence

of several witnesses. His death took place on the 27th April, his burial on the 2d May 1685, at Haarlem. According to Houbraken he was taught by Frans Hals, at that time master of Adrian Brouwer. At twenty-six he joined a company of the civic guard at Haarlem; at twenty-eight he married his first wife, who lived till 1642. He speedily married again, but again became a widower in 1666. Persons curious of matters connected with the lives of famous men may visit the house in the Königstraat at Haarlem where Adrian Ostade lived in 1657, or that of the Ridderstraat which he occupied in 1670. He took the highest honours of his profession, the presidency of the painters' guild at Haarlem, in 1662. Amongst the treasures of the Louvre collection, a striking picture represents the father of a large family sitting in state with his wife at his side in a handsomely furnished room, surrounded by his son and five daughters, and a young married couple. It is an old tradition that Ostade here ornamented himself and his children in holiday attire; yet the style is much too refined for the painter of boors, and pitiless records tell us that Ostade had but one daughter. The number of Ostade's pictures is given by Smith at three hundred and eighty-five. It is probable that he painted many more. At his death the stock of his unsold pieces was over two hundred. His engraved plates were put up to auction, with the pictures, and fifty etched plates—most of them dated 1647-48—were disposed of in 1686. At the present time it is easy to trace two hundred and twenty pictures in public and private collections, of which one hundred and four are signed and dated, seventeen are signed with the name but not with the date, and the rest are accepted as genuine by modern critics.

Adrian Ostade is the contemporary of David Teniers and Adrian Brouwer. Like them he spent his life in the delineation of the homeliest subjects—tavern scenes, village fairs, and country quarters. Between Teniers and Ostade the contrast lies in the different condition of the agricultural classes of Brabant and Holland, and the atmosphere and dwellings that were peculiar to each region. Erabant has more sun, more comfort, and a higher type of humanity; Teniers, in consequence, is silvery and sparkling; the people he paints are fair specimens of a well-built race. Holland, in the vicinity of Haarlem, seems to have suffered much from war; the air is moist and hazy, and the people, as depicted by Ostade are short, ill-favoured, and marked with the stamp of adversity on their features and dress. Brouwer, who painted the Dutch boor in his frolics and passion, imported more of the spirit of Frans Hals into his delineations than his colleague; but the type is the same as Ostade's, only more animated and vicious. How was it that the disciples of Hals should have fallen into this course, whilst Hals himself drew people of the gentle classes with such distinction? It was probably because of his superiority and the monopoly which he and a few colleagues at Haarlem enjoyed that his pupils were forced into a humbler walk, and into this walk Hals was able to lead them, because he was equally able in depicting the strolling wail or fishwife, or the more aristocratic patrician who strutted about in lace collar, with his rapier at his side. But the practice of Hals in this form was confined to the city, or to those wanderers from the country who visited town. Brouwer and Ostade went to the country itself and lived in the taverns and cottages of peasants, where they got the models for their pictures. Neither of them followed the habits of the artists of the Hague, who took sitters into their studios and made compositions from them. Their sitters were people, unconscious that they sat, taken on the spot and from life, and transferred with cunning art to pictures.

There is less of the style of Hals in Adrian Ostade than in Brouwer, but a great likeness to Brouwer in Ostade's early works. During the first years of his career, Ostade displayed the same tendency to exaggeration and frolic as his comrade. He had humour and boisterous spirits, but he is to be distinguished from his rival by a more general use of the principles of light and shade, and especially by a greater concentration of light on a small surface in contrast with a broad expanse of gloom. The key of his harmonies remains for a time in the scale of greys. But his treatment is dry and careful, and in this style he shuns no difficulties of detail, representing cottages inside and out, with the vine leaves covering the poorness of the outer side, and nothing inside to deck the patch-work of rafters and thatch, or tumble-down chimneys and ladder staircases, that make up the sordid interior of the Dutch rustic of those days. His men and women, attuned to these needy surroundings, are invariably dressed in the poorest clothes. The hard life and privations of the race are impressed on their shapes and faces, their shoes and hats, worn at heel and battered to softness, as if they had descended from generation to generation, so that the boy of ten seems to wear the cast-off things of his sire and grandsire. It was not easy to get poetry out of such materials. But the greatness of Ostade lies in the fact that he often caught the poetic side of the life of the peasant class, in spite of its ugliness and stunted form and mishapen features. He did so by giving their vulgar sports, their quarrels, even their quieter moods of enjoyment, the magic light of the sunbeam, and by clothing the wreck of cottages with gay vegetation.

It was natural that, with the tendency to effect which marked Ostade from the first, he should have been fired by emulation to rival the masterpieces of Rembrandt. His early pictures are not so rare but that we can trace how he glided out of one period into the other. Before the dispersion of the Gsell collection at Vienna in 1872, it was easy to study the steel-grey harmonies and exaggerated caricature of his early works in the period intervening between 1632 and 1638. There is a picture of Rustics, dated 1632, in the Kœloff collection at St Petersburg; a Countryman having his Tooth Drawn, in the Belvedere of Vienna, of a similar date though unsigned; a Bagpiper of 1635 in the Lichtenstein gallery at Vienna; Cottage Scenes of 1635 and 1636, in the museums of Carlsruhe, Darmstadt, and Dresden; Smokers in the House of Count Borchom at Munich; and Card Players of 1637 in the Lichtenstein palace at Vienna, which make up for the loss of the Gsell collection. The same style marks most of these pieces. About 1638 or 1640 the influence of Rembrandt suddenly changed his style, and he painted the Annunciation of the Brunswick museum, where the angels appearing in the sky to Dutch boors half asleep amidst their cattle, sheep, and dogs, in front of a cottage, at once recall the similar subject by Rembrandt, and his effective mode of lighting the principal groups by rays propelled to the earth out of a murky sky. But Ostade was not successful in this effort to vulgarize Scripture. He might have been pardoned had he given dramatic force and expression to his picture; but his shepherds were only boors without much emotion, passion, or surprise. His picture was a mere effect of light, as such masterly, in its sketchy rubbings, of dark brown tone relieved by strongly impasted lights, but without the very qualities which made his usual subjects attractive. When, in 1642, he painted the beautiful interior at the Louvre, in which a mother tends her child in a cradle at the side of a great chimney near which her husband is sitting, the darkness of a country loft is dimly illumined by a beam from the sun that shines on the casement; and one might think the painter intended to depict the Nativity, but that there is nothing holy in all the surroundings, nothing attractive indeed except the wonderful Rembrandtesque transparency, the brown tone, and the admirable keeping of the minutest parts. The sparkle of Brouwer is not there; nor as yet the concentrated evenness of such pictures of Rembrandt as the Meditative Philosopher at the Louvre. Yet there is perhaps more conscientiousness of detail. Ostade was more at home in a similar effect applied to the commonplace incident of the Slaughtering of a Pig, one of the masterpieces of 1643, once in the Gsell collection at Vienna. In this and similar subjects of previous and succeeding years, he returned to the homely subjects in which his power and wonderful observation made him a master. He never seems to have gone back to gospel illustrations till 1667, when he produced the admirable Nativity of Mr Walter of Bearwood, which is only surpassed as regards

arrangement and colour by Rembrandt's Carpenter's Family at the Louvre, or the Woodcutter and Children in the gallery of Cassel. Innumerable almost are the more familiar themes to which he devoted his pencil during this interval, from small single figures, representing smokers or drinkers, to vulgarised allegories of the five senses (Hermitage and Brunswick galleries), half-lengths of fishermen and bakers, and cottage brawls, or scenes of gambling, or itinerant players and quacks, and nine-pin players in the open air. The humour in some of these pieces is contagious, as in the Tavern Scene of the Lacaze collection (Louvre, 1653), where a boor squeezes the empty beer-pot in his hands to show that the last drop has been sucked out of it. It would be tedious to enumerate the masterpieces of this kind. But those who have no other opportunities may study with pleasure and advantage the large series of dated pieces which adorn every European capital, from St Petersburg to London. Buckingham Palace has a large store, and many and many a good specimen lies hid in the private collections of England. But if we should select a few as peculiarly worthy of attention, we might point to the Rustics in a Tavern of 1622 at the Hague, the Village School of the same year at the Louvre, the Tavern Court-yard of 1670 at Cassel, the Sportsman's Rest of 1671 at Amsterdam, and the Fiddler and his Audience of 1673 at the Hague. At Amsterdam we have the likeness of a painter, in a red bonnet and violet coat, sitting with his back to the spectator, at his easel. The colour-grinder is stuck in a corner, a pupil prepares a palette, and a black dog sleeps on the ground. The same picture, with the date of 1666, is in the Dresden gallery. Both specimens are supposed to represent Ostade himself. But unfortunately we see the artist's back and not his face. Ostade painted with equal vigour at all times. Two of his latest dated works, the Village Street and Skittle Players in the Ashburton and Ellesmere collections, were executed in 1676 without any sign of declining powers. The prices which he received are not known, but those of the present day are talling when compared with those of the close of last century. Early pictures, which may have been sold by the painter for a few shillings, now fetch £200. Later ones, which were worth £40 in 1750, are now worth £1000, and Earl Dudley gave £4120 for a cottage interior in 1876. The signatures of Ostade vary at different periods. But the first two letters are generally interlaced. Up to 1635 Ostade writes himself Ostaden, — *e.g.*, in the Bagpiper of 1635 in the Lichtenstein collection at Vienna. Later on he uses the long *s* (*ſ*), and occasionally he signs in capital letters (Strass collection, Vienna, 1647; and Hague museum, 1673). His pupils are his own brother Isaac, Cornelis Bega, Cornelis Dusart, and Richard Brakenburg.

II. ISAAC OSTADE (1621–1649) was christened on the 2d of June 1621, at Haarlem. He began his studies under Adrian, with whom he remained till 1641, when he started on his own account. At an early period he felt the influence of Rembrandt, and this is apparent in a Slaughtered Pig of 1639, in the gallery of Augsburg. But he soon reverted to a style more suited to his pencil. He produced pictures in 1641–42 on the lines of his brother,—amongst these, the Five Senses, which Adrian afterwards represented by a Man Reading a Paper, a Peasant Tasting Beer, a Rustic Smearing his Sores with Ointment, and a Countryman Sniffing at a Snuff-box. The contract for these pieces was made before 1643, when Leendert, a dealer, summoned him for a breach of his agreement before the burgomaster of Haarlem. The matter was referred to the guild, and evidence was adduced to prove that Isaac had promised in 1641 to deliver six pictures and seven rounds, including the Five Senses, for 27 florins. Isaac, in his defence, urged that he had finished two of the pictures and two of the rounds, which Leendert had seen, but neglected to fetch; that he had begun the remainder of the series, but that in the meanwhile the value of his works had risen, so that he thought that on that ground alone he was freed from the obligations he had assumed. The guild decided that Isaac was bound to furnish the pictures before Easter 1643. But they reduced the number of the rounds to five, and assessed the price of the whole at 50 florins. A specimen of Isaac's work at this period may be seen in the Laughing Boor with a Pot of Beer, in the museum of Amsterdam; the cottage interior, with two peasants and three children near a fire, in the Berlin museum; a Concert, with people listening to singers accompanied by a piper and flute player, and a Boor Stealing a Kiss from a Woman, in the

Lacaze collection at the Louvre. The interior at Berlin is lighted from a casement in the same Rembrandtesque style as Adrian's interior of 1643 at the Louvre. The value of these panels, which we saw estimated in 1643 at two florins apiece, was greatly enhanced in the following century, when the Laughing Boor at Amsterdam was sold for 56 florins. But the low price fixed by the guild of Haarlem must have induced Isaac to give up the practice, in which he could only hope to remain a satellite in the orbit of Adrian, and accordingly we find him gradually abandoning the cottage subjects of his brother for landscapes in the fashion of Esaias Van de Velde and Salomon Ruissdael. Once only, in 1645, he seems to have fallen into the old groove, when he produced the Slaughtered Pig, with the boy puffing out a bladder, in the museum of Lille. But this was a mere accident. Isaac's progress in the new path which he had cut out for himself was greatly facilitated by his previous experience as a figure painter; and, although he now selected his subjects either from village high streets or frozen canals, he was enabled to give fresh life and animation to the scenes he depicted by groups of people full of movement and animation, which he relieved in their coarse humours and sordid appearance by a refined and searching study of picturesque contrasts. Unfortunately he did not live long enough to bring his art to the highest perfection. He died at twenty-eight on the 16th October 1649.

The first manifestation of Isaac's surrender of Adrian's style is apparent in 1644 when the skating and sledging scenes were executed which we see in the Lacaze collection and the galleries of the Hermitage, Antwerp, and Lille. Three of these examples bear the artist's name, spelt *Isaac van Ostade*, and the dates of 1644 and 1645. The road-side inns, with halts of travellers, form a compact series from 1646 to 1649. In this, the last form of his art, Isaac has very distinct peculiarities. The air which pervades his composition is warm and sunny, yet mellow and hazy, as if the sky were veiled with a vapour coloured by moor smoke. The trees are rublings of umber, in which the prominent foliage is tipped with touches hardened in a liquid state by amber varnish mediums. The same principle applied to details such as glazed bricks or rents in the mud lining of cottages gives an unreal and conventional stamp to those particular parts. But these blemishes are forgotten when one looks at the broad contrasts of light and shade and the masterly figures of steeds and riders, and travellers and rustics, or quarrelling children and dogs, poultry, and cattle, amongst which a favourite place is always given to the white horse, who seems as invariable an accompaniment as the grey in the skirmishes and fairs of Wouvertmans. But it is in winter scenes that Isaac displays the best qualities. The absence of foliage, the crisp atmosphere, the calm air of cold January days, unsoftened by smoke or vapour, preclude the use of the brown tinge, and leave the painter no choice but to ring the changes on opal tints of great variety, upon which the figures come out with masterly effect on the light background upon which they are thrown. Amongst the road-side inns which will best repay attention we should notice those of Buckingham Palace, the National Gallery, the Wallace, Ellesmere, Ashburton, Holford, Bobarts, and Bearwood collections in England, and those of the Louvre, Berlin, Hermitage, and Rotterdam museums and the Rothschild collections at Vienna on the Continent. The finest of the ice scenes is the famous one at the Louvre. (J. A. C.)

OSTASHKOFF, a town of Tver, Russia, 163 miles by rail south-east from the capital of that government, on Lake Seliger, has a population of 12,500. The fisheries, which still employ a considerable number of the inhabitants, attracted settlers at an early date, but it is not till 1500 that the Ostashkoff villages are mentioned in Russian annals. The advantageous site, the proximity of the Smolenskiy Jitnyi monastery, a pilgrim-resort on an island of the lake, and the early development of certain petty trades, combined to bring prosperity to Ostashkoff; and its cathedral (1672–85) still contains rich offerings, as also do two other churches of the same century. About 200,000 pairs of boots are now manufactured annually; hatchets, scythes, shears, and similar implements are also made; and tanning is another important industry.



**OSTEND**, a seaport of Belgium, in the province of West Flanders, 70 miles west-north-west from Brussels, is surrounded on the north and west by the sea; its site is an extensive plain, lying below high-water level, the town and surrounding country being protected by a sea-wall built of granite with a brick revetment, upon which the waves generally exhaust their force even in the roughest weather, though the town has occasionally been inundated through a combination of westerly gales and unusually high tides. The port is dangerous in unfavourable weather; the channel leading into the two interior basins (which are calculated to hold more than a thousand vessels) is formed by two long wooden piers, and at its mouth has a width of only 165 yards. The rise of the tide in the harbour is about 15 feet, and as the bed of the sluice lies 3 feet under low-water mark, the depth at high water should amount to 18 feet; but the entrance to the harbour is obstructed by sandbanks, which frequently shift their position under the influence of wind and tide, and leave a free depth of only about 9 feet. At the north-west extremity of the sea-wall (digue de mer) is a lighthouse erected in 1771, and subsequently modernized, with a light visible at a distance of 45 miles. The town has an active trade in refined salt, ropes, sails, soap, tobacco, lace, and wool. The imports greatly exceed the exports. In 1883 1345 vessels entered with 175,987 tons cargo, and 1342 cleared with 32,010.

The large fishing population is chiefly occupied in the cod or herring fisheries; the trade in oysters is important, these being brought over in large quantities from the English coast, principally about Harwich or Colchester, and fattened in the Ostend oyster-beds. There are no manufactures of any consequence; and, unlike other Flemish cities, Ostend has no monument or building in any way worthy of notice. The town owes its repute and prosperity chiefly to its sea-beach, which is admirably adapted for bathing purposes, being composed of perfectly smooth sands, firm, level, and of great extent. Ostend is the yearly resort, from August to October, of many thousand visitors, comprising not only members of the fashionable society of Brussels and the larger provincial towns of Belgium, but also foreigners, principally Germans and Russians. During the season the digue and piers are crowded; entertainments and festivities are offered to guests at the Kursaal, Casino, &c.; a good deal of private and promiscuous gambling is carried on. The influx of bathers and pleasure-seekers has led to the development of some quieter resorts in the immediate vicinity, such as Blankerbergh (lately a mere fishing village), Heyst, Middelkerk, and others. In 1880 the population of the town was 16,823.

In the 10th century Ostend was but a cluster of fishermen's huts. In 1072 Robert I. of Flanders built a church there in honour of St Peter. The place thenceforth grew in importance, and the

harbour became noted. Margaret of Constantinople, countess of Flanders, raised it to the rank of a city in 1267. In 1445 Philip the Good caused it to be walled round, but the prince of Orange was the first to fortify it in earnest (1583); and a short time afterwards it sustained a memorable siege, during the reign of Albert and Isabella, being invested on the 5th of July 1601, and taken by Spinola on the 14th of September 1604, after a resistance of more than three years. It was then in a state of almost absolute ruin, but was speedily rebuilt by the archduke, who granted the citizens many privileges. The prosperity of Ostend, however, was constantly impeded by rivalries and dissensions. In the beginning of the 18th century it appeared in a fair way to attain commercial eminence, the emperor Charles VI. having selected it as the seat of the East Indian Company; but the interference of powerful neighbours, and principally of England and Holland, caused a stop to be put to this by the treaty of Vienna in 1732. Ostend was taken by the French in 1794, and belonged to the republic until 1814, after which it formed part of the Netherlands, and subsequently, since 1830, of the kingdom of Belgium.

**OSTERVALD**, JEAN FREDÉRIC (1663-1747), Swiss Protestant theologian, was born at Neuchâtel on November 25, 1663, was educated at Zurich and at Saumur (where

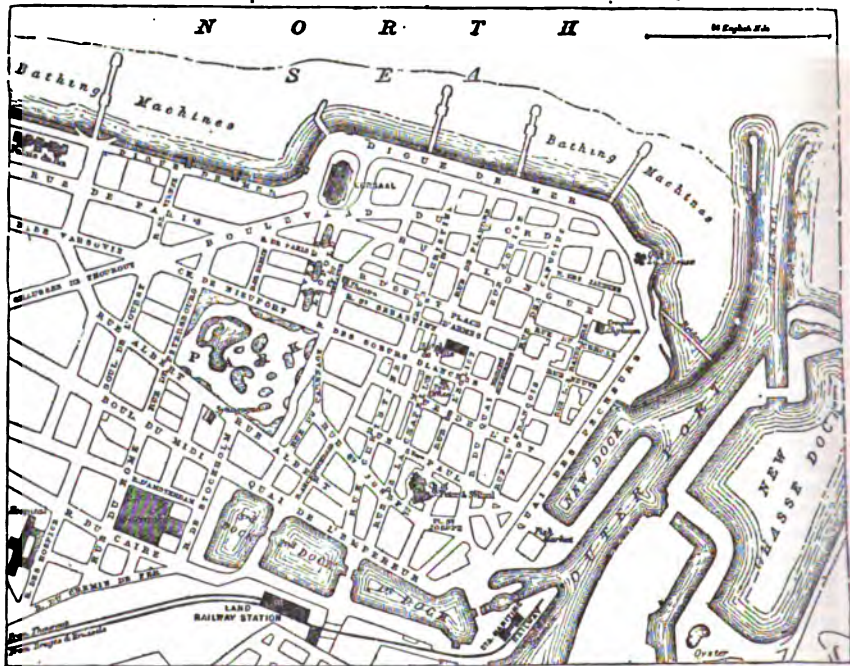

Plan of Ostend.

he graduated), studied theology at Orleans, Paris, and Geneva, and was ordained to the ministry in his native place in 1683. As preacher, pastor, lecturer, and author, he attained a position of great influence in his day, he and his friends J. A. Turretin of Geneva and S. Werenfels of Basel forming what was once called the "Swiss triumvirate." He died on April 14, 1747.

His principal works are *Traité des sources de la corruption qui règne aujourd'hui parmi les Chrétiens* (1700), practically a plea for a more ethical and less doctrinal type of Christianity; *Calichism ou Instruction dans la Religion Chrétienne*, 1702; *Traité contre l'Impureté*, 1707; *Sermons sur divers Textes*, 1722-24; *Theologi Compendium*, 1739; and *Traduction de la Bible*, 1724. All his writings attained great popularity among French Protestants; many were translated into various languages; and "Ostervald Bible," in particular, was long well known and much valued in Britain. A *Life* by Durand was published in London in 1778.

**OSTIA**, a city of ancient Latium, situated at the mouth of the Tiber, from which circumstance it obviously derives its name. Owing to this position it became from an early period the port of Rome, but its foundation as a regular colony of that city is ascribed by ancient authors to Ancus

Marcus, who is said to have at the same time established there extensive salt works, which long continued to supply Rome and its neighbourhood with that necessary article. As the wealth and importance of Rome itself increased, the prosperity of Ostia naturally rose with it, and it continued throughout the period of the Roman republic to be at once the principal emporium of trade in this part of Italy and the permanent station of the Roman fleet. It was, however, at no period a really good port, and the natural disadvantages of its position were not merely felt the more keenly as its commercial importance increased, but they were continually aggravated by natural causes,—the alluvial matter continually brought down by the Tiber having filled up the port, and at the same time in great measure blocked the mouth of the river, so as to render it inaccessible to the larger class of vessels. Strabo gives a lively picture of the difficulties with which these had to contend in his time, and which were only surmounted on account of the great pecuniary advantages arising from its proximity to the capital. The necessity of taking some steps to obviate these evils had indeed already presented itself to the dictator Cæsar, who had proposed to construct an artificial port at Ostia, with all the appurtenances requisite for so extensive a trade, but no steps were taken towards the execution of this project till the reign of the emperor Claudius, who constructed an entirely new basin or artificial port at a distance of about two miles north of Ostia, and communicating by an artificial channel with the Tiber on one side and the sea on the other. These works were afterwards largely augmented by Trajan, so that the port came to be known as the Portus Trajani, and the channel from thence to the sea was called the Fossa Trajani. This was undoubtedly the same with what is now become the right branch of the Tiber, entering the sea at Fiumicino. From this time the great mass of the trade was transferred to the new port, while that of Ostia continually diminished, though the city itself continued to be a populous and flourishing place throughout the period of the Roman empire. It was not till the close of the western empire that Ostia itself, which was unprotected by walls, and consequently exposed to the attacks of the barbarians, fell into decay; and after it was plundered by the Saracens in the 9th century the site became altogether abandoned, the modern village of Ostia (a very poor place) being situated at a distance of about half a mile from the ruins of the ancient city. The extent and variety of these, as well as the beauty of the works of art discovered on the site, confirm the accounts given by ancient writers of the opulence and prosperity of Ostia in the days of the empire; while those of Porto, as the port of Trajan is still called, are of great interest as exhibiting not only the artificial basin of the port, with its quays and the remains of the surrounding magazines, but a large part of the circuit of walls and towers by which it was protected. Such was the importance of Portus under the Roman empire that it became an episcopal see, and still gives that title to one of the cardinals of Rome.

The continual advance of the coast-line, owing to the alluvial deposits brought down by the Tiber, has left the ruins of Ostia more than two miles from the sea. Those of Portus are separated from it by an equal interval, and even the tower of Fiumicino, which was built in the last century at the entrance of the right branch of the Tiber—the only one now navigable—is already a considerable distance inland.

For a detailed account of the history and topography of Ostia and the neighbouring Portus, as well as of the changes in the coast-line and channel of the Tiber, the reader may consult Nibby, *Distoria di Roma*, vol. ii. p. 426-474, 602-660; and an elaborate paper by Preller in the *Berichte der Bœhmischen Gesellschaft* for 1849.

OSTIAKS, or ОСТЯКИ, a tribe of Finnish origin, who inhabit the basin of the Obi in western Siberia: a few hundreds also are nomads in the basin of the lower Yenisei. Plano Carpini and Marco Polo in the 13th century knew them on the flat lands of the Obi, and the best investigators (Castrén, Løberg, A. Schrenck) consider the trans-Uralian Ostiaks and Samoyedes as identical with the Yugra of the Russian annals. During the Russian conquest their abodes extended much farther south than now, and they had numerous settlements on the basin of the Obi, no less than forty-one of their fortified places having been destroyed by the Cossacks in 1501, in the region of Obdorak alone. Remains of these "towns" are still to be seen at the Kunovat river, on the Obi 20 miles below Obdorak, and elsewhere. The total number of the Ostiaks may be estimated at a little over 27,000. Those on the Irthik are mostly settled, and have adopted the manner of life of Russians and Tartars. Those on the Obi are mostly nomads; along with 8000 Samoyedes in the districts of Beryozoff and Surgut, they own 93,600 reindeer. The Obi Ostiaks are Russified to a great extent. They live almost exclusively by fishing, buying from Russian merchants corn for bread, the use of which has become widely diffused.

The Ostiaks call themselves Ass-yakh (people of the Obi), and it is supposed that their present designation is a corruption of this name. By language they belong (Castrén, *Reisberichte, Reisebriefe*, Ahlqvist, *Ofvers. af Finnska Vet.-Soc. Forh.*, xli.) to the Ugrian branch of the eastern Finnish stem,—a classification confirmed by a grammar of their language, compiled in 1875, in Hungarian, by Hunfalvy. All the Ostiaks speak the same language, mixed to some extent with foreign elements; but three or four leading dialects can be distinguished.

The Ostiaks are middle-sized, or of low stature, mostly meagre, and not ill made, however clumsy their appearance in winter, in their thick fur-clothes. The extremities are fine, and the feet are usually small. The skull is brachycephalic, mostly of moderate size and height. The hair is dark and soft for the most part, fair and reddish individuals being rare; the eyes are dark, generally narrow; the nose is flat and broad; the mouth is large and with thick lips; the beard is scanty. The younger men and women are sometimes of an agreeable appearance. The Mongolian type is more strongly pronounced in the women than in the men. On the whole, the Ostiaks are not a pure race; the purest type is found among the fishers on the Obi, the reindeer-breeders of the tundra being largely intermixed with Samoyedes (see Castrén; Dr Finsch's *Reise nach West-Sibirien*, &c.).

Investigators are unanimous in describing them as very kind, gentle, and honest; rioting is almost quite unknown among them, as also theft, this last occurring only in the vicinity of Russian settlements, and the only penalty enforced being the restitution twofold of the property stolen. The farther they are removed from contact with Russian dealers and traders the higher do their moral qualities become (Middendorff and Castrén).

They are very skillful in the arts they practise, especially in carving wood and bone, tanning (with egg-yolk and brains), preparation of implements from birch bark, &c. Some of their carved or decorated bark implements (like those figured in Middendorff's *Sibirische Reise*, iv. 2) show great artistic skill. Only a few have guns, the great majority continuing to hunt with bow and arrow.

Their folk-lore, like that of other Finnish stems, is imbued with a deep feeling of natural poetry, and reflects also the sadness, or even the despair, which has been noticed among them. The number of those who are considered Christians reaches 2000; but their Shamanism is still retained, hardly anything being borrowed from Christianity beyond the worship of St Nicholas, who is a most popular saint among them.

OSTRACISM, a peculiar political institution in Athens, designed by Clisthenes as a safeguard against any citizen acquiring too great power and aspiring to make himself tyrant of the state. Before it could be carried into effect, a decree of the people had to be passed that an ostracism was necessary. If this was done, the voting was fixed for a special day in the agora. The votes were given according to tribes; and each citizen wrote on an oyster shell (*δοσπρακον*) the name of the person who he thought should be ostracized. The person who obtained the majority was exiled for ten years, provided the votes against him were

6000. If no person were designated on so many shells, the proceedings were at an end. The ostracized person might return at the end of his term of banishment, having then the full rights of citizenship, or his term might be shortened by a special vote of the people. The institution was intended as a precaution in view of the weakness of the central Government, which, having no standing army at its disposal, was liable to be disturbed or overturned by a sudden attack arranged by a powerful partisan. When party strife ran high, ostracism was frequently resorted to with the consent of the two parties, in order to test their strength; but when an ostracism had been arranged in 416 B.C. the parties subsequently compromised their dispute and directed their votes against an insignificant person named Hyperbolus. After this the institution fell into disuse. According to Aristotle and Philochorus, the people were required every year in the first assembly of the sixth prytany to determine whether or not an ostracism should take place. The same institution is said to have been in use at Argos, Miletus, and Megara, and a similar one called *petalismus* was employed at Syracuse for a short time during the 5th century B.C.; the latter was named from the olive leaves (*πέταλα*) used instead of oyster-shells.

**OSTRICH** (Old English, *Estridge*; French, *Austruche*; Spanish, *Avestrus*; Latin, *Avi struthio*). Among exotic birds there can be hardly one better known by report than the strange, majestic, and fleet-footed creature that "scorneth the horse and his rider," or one that from the earliest times to the present has been oftener more or less fully described; and there must be few persons in any civilized country unacquainted with the appearance of this, the largest of living birds, whose size is not insignificant in comparison even with the mightiest of the plumed giants that of old existed upon the earth, since an adult male will stand nearly 8 feet in height, and weigh 300 lb.

As to the ways of the Ostrich in a state of nature, not much has been added of late years to the knowledge acquired and imparted by former travellers and naturalists, many of whom enjoyed opportunities that will never again occur of discovering its peculiarities, for even the most favourably-placed of their successors in recent years seem to content themselves with repeating the older observations, and to want either leisure or patience to make additions thereto, their personal acquaintance with the bird not amounting to more than such casual meetings with it as must inevitably fall to the lot of those who traverse its haunts. Thus there are still several dubious points in its natural history. On the other hand we unquestionably know far more than our predecessors respecting its geographical distribution, which has been traced with great minuteness in the *Vögel Ost-Afrikas* of Drs Finsch and Hartlaub, who have therein given (pp. 591-607) the most comprehensive account of the bird that is to be found in the literature of ornithology.<sup>1</sup> As with most birds, the Ostrich is disappearing before the persecution of man, and this fact it is which gives the advantage to older travellers, for there are many districts, some of wide extent, known to have been frequented by the Ostrich within the present century, especially towards the extremities of its African range—as on the borders of Egypt and the Cape Colony—in which it no longer occurs, while in Asia there is evidence, more or less trustworthy, of its former existence in most parts of the south-western desert-tracts, in few of which it

is now to be found. Xenophon's notice of its abundance in Assyria (*Anabasis*, i. 5) is well known. It is probable that it still lingers in the wastes of Kirwan in eastern Persia, whence examples may occasionally stray northward to those of Turkestan,<sup>2</sup> even near the Lower Oxus; but the assertion, often repeated, as to its former occurrence in Baloochistan or Sindh, though not incredible, seems to rest on testimony as yet too slender for acceptance. Apparently the most northerly limit of the Ostrich's ordinary range at the present day cannot be further than that portion of the Syrian Desert lying directly to the eastward of Damascus; and, within the limits of what may be called Palestine, Canon Tristram (*Fauna and Flora of Palestine*, p. 139) regards it as but a straggler from central Arabia, though we have little information as to its appearance and distribution in that country. Africa, however, is still, as in ancient days, the continent in which



Ostrich.

the Ostrich most flourishes, and from the confines of Barbary to those of the European settlements in the south it appears to inhabit every waste sufficiently extensive to afford it the solitude it loves, and in many wide districts, where the influence of the markets of civilization is feebly felt, to be still almost as abundant as ever. Yet even there it has to contend with deadly foes in the many species of *Carnivora* which frequent the same tracts and prey upon its eggs and young—the latter especially; and Lichtenstein long ago remarked that if it were not for its numerous enemies "the multiplication of Ostriches would be quite unexampled." The account given of the habits of the species by this naturalist, who had excellent opportunities of observing it during his three years'

<sup>1</sup> A good summary of it is contained in the *Ostriches and Ostrich Farming* of Messrs De Moenthal and Harting, from which the accompanying figure is, with permission, taken. Von Heuglin, in his *Ornithologie Nordost-Afrikas* (pp. 925-935), has given more particular details of the Ostrich's distribution in Africa.

<sup>2</sup> Drs Finsch and Hartlaub quote a passage from Remusat's *Remarques sur l'extension de l'Empire Chinoise*, stating that in about the seventh century of our era a live "camel-bird" was sent as a present with an embassy from Turkestan to China.



travels in South Africa, is perhaps one of the best we have, and since his narrative<sup>1</sup> has been neglected by most of its more recent historians we may do well by calling attention thereto. Though sometimes assembling in troops of from thirty to fifty, and then generally associating with zebras or with some of the larger antelopes, Ostriches commonly, and especially in the breeding season, live in companies of not more than four or five, one of which is a cock and the rest are hens. All the latter lay their eggs in one and the same nest, a shallow pit scraped out by their feet, with the earth heaped around to form a kind of wall against which the outermost circle of eggs rest. As soon as ten or a dozen eggs are laid, the cock begins to brood, always taking his place on them at nightfall surrounded by his wives, while by day they relieve one another, more it would seem to guard their common treasure from jackals and small beasts-of-prey than directly to forward the process of hatching, for that is often left wholly to the sun.<sup>2</sup> Some thirty eggs are laid in the nest, and round it are scattered perhaps as many more. These last are said to be broken by the old birds to serve as nourishment for the newly-hatched chicks, whose stomachs cannot bear the hard food on which their parents thrive. The greatest care is taken by them not only to place the nest where it may not be discovered, but to avoid being seen when going to or from it, and their solicitude for their tender young is no less. Anderson in his *Lake Nyami* (pp. 253-269) has given a lively account of the pursuit by himself and Mr Francis Galton of a brood of Ostriches, in the course of which the father of the family feigning himself on the ground and feigned being wounded to distract their attention from his offspring. Though the Ostrich ordinarily inhabits the most arid districts, it requires water to drink; more than that, it will frequently bathe, and sometimes even, according to Von Henglin, in the sea.

The question whether to recognize more than one species of Ostrich, the *Struthio camelus* of Linnaeus, has been for some years agitated without leading to a satisfactory solution. It has long been known that, while eggs from North Africa present a perfectly smooth surface, those from South Africa are pitted (see BIRDS, vol. iii. p. 775, note 1). It has also been observed that northern birds have the skin of the parts not covered with feathers flesh-colored, while this skin is bluish in southern birds, and hence the latter have been thought to need specific designation as *S. australis*. Still more recently examples from the Somali country have been described as forming a distinct species under the name of *S. molybdophanes* from the leaden colour of their naked parts.

The genus *Struthio* forms the type of one group of the Subclass *Ratites*, which differs so widely from the rest, in points that have been concisely set forth by Prof. Huxley (*Proc. Zool. Society*, 1867, p. 419), as to justify us in regarding it as an Order, to which the name *Struthionides* may be applied (see ORNITHOLOGY, p. 44); but that term, as well as *Struthionidae*, has been often used in a more general sense by systematists, even to signify the whole of the *Ratites*, and hence for the present caution must be

<sup>1</sup> M. H. K. Lichtenstein, *Reise im südlichen Africa*, ii. pp. 42-45 (Berlin, 1812).

<sup>2</sup> By those whose experience is derived from the observation of captive Ostriches this fact has been often disputed. But, to say nothing of the effects of the enforced monogamy in which such birds live, the difference of circumstances under which they find themselves, and in particular their removal from the heat-retaining sands of the desert and its burning sunshine, is quite enough to account for the change of habit. Von Henglin also (p. 983) is explicit on this point. That the female Ostriches while on duty crouch down to avoid detection is only natural, and this habit seems to have led hasty observers to suppose they were really brooding.

exercised as to whether certain fossil remains from the Sivalik formation, referred to "*Struthionida*," be regarded as true Ostriches or not. The most obvious distinctive character presented by the Ostrich is the presence of two toes only, the third and fourth, on each foot,—a character absolutely peculiar to the genus *Struthio*.

The great mercantile value of Ostrich-feathers, and the increasing difficulty, due to the causes already mentioned, of procuring them from wild birds, has led to the formation in the Cape Colony and elsewhere of numerous "Ostrich-farms," on which these birds are kept in confinement, and at regular intervals of time deprived of their plumes. In favourable localities and with judicious management these establishments are understood to yield very considerable profit; while, as the ancient taste for wearing Ostrich-feathers shews no sign of falling off, but seems rather to be growing, it is probable that the practice will yet be largely extended.

Among the more important treatises on this bird may be mentioned:—E. D'Alton, *Die Skelet der Strussenartigen Vögel abgebildet und beschrieben*, folio, Bonn, 1827; P. L. Esclater, "On the Struthion Birds living in the Zoological Society's Menagerie," *Transactions*, iv. p. 353, containing the finest representation (pl. 67), by Mr Wolf, ever published of the male *Struthio camelus*; Prof. Mivart, "On the Axial Skeleton of the Ostrich," *op. cit.*, viii. p. 385; Prof. Huxington, "On the Muscular Mechanism of the Leg of the Ostrich," *Ann. Nat. History*, ser. 8, xv. pp. 262-272; and Prof. Macalister, "On the Anatomy of the Ostrich," *Proc. R. Irish Academy*, ix. pp. 1-24. (A. N.)

OSTUNI, a city of Italy, in the province of Lecce, 23 miles by rail north-west of Brindisi. It is a bishop's see, has a cathedral of the 15th century with a fine Romanesque façade, several other churches of some interest, a municipal library with a collection of antiquities, and a technical school. The population was 14,422 in 1871 and 15,199 in 1881, that of the commune being 16,295 and 18,226.

OSUNA, a town of Spain, in the province of Seville, distant 48 miles by road and 57 by rail east-south-east from that city, is built in a semicircular form on the slope of a hill, at the edge of a fertile plain watered by the Salado, a sub-tributary of the Guadalquivir. On the top of the hill, which commands an extensive view, stands the collegiate church, a mixed Gothic and cinquecento building, containing several good specimens of Ribera, which, however, as well as the sculptures over the portal, suffered considerably during the occupation of the place by Soult. The vaults, which are supported by Moorish arches, contain the tombs of the Giron family, by one of whom, Don Juan Tellez, the church was founded in 1534. The university of Osuna, founded also by him in 1549, was suppressed in 1820; but the large building is still used as a secondary school. A great number of the inhabitants of Osuna are engaged in agriculture, and the making of esparto mats employs many of the poorer people. Earthenware, bricks, oil, soap, linen, hats, are also manufactured; and barley, oil, and wheat are sent in large quantities to Seville and Malaga. The population of the ayuntamiento in 1877 was 17,211.

Osuna, the *Urso* of Hirtius, where the Pompeians made their last stand, was afterwards called by the Romans *Gemina Urbanorum*, from the fact, it is said, that two urban legions were simultaneously quartered there. The place was taken from the Moors in 1239, and given by Alphonso the Wise to the knights of Calatrava in 1264. Don Pedro Giron appropriated it to himself in 1445. One of his descendants founded the university, and another, Don Pedro Tellez, was made duke of Osuna by Philip II. (1562).

OSWALD (c. 604-642), "most Christian king of the Northumbrians," was the son of King Ethelfrith, and was born about 604. On the death of his father on the battlefield in 617, he and his brothers were compelled to take refuge among the northern Celts, where they are said to have received baptism. The fall of King Edwin in 633 permitted their return, and after the death of Eanfrid,



who had received Deira, and of Osric, who had been chosen to Bernicia, Oswald was called to the throne of the united kingdoms, and established his claim to it by his great victory over Ceadwalla at Heavenfield near Hexham in 635. His beneficent reign, which was chiefly devoted to the establishment of Christianity throughout his dominions, was brought to an end by his defeat and death on August 5, 642 (see NORTHUMBERLAND). The cross erected by Oswald on the scene of his victory in 635 was afterwards the scene or the instrument of many miracles, and gradually his name found a place in the calendar, August 5th being the day sacred to his memory. A German "Spielmannsgedicht" of the 12th or 13th century takes its name from St Oswald, but the narrative has no relation to anything recorded about the hero in authentic history (see monographs by Zingerle, 1856; Strobl, 1870; and Edzardi, 1876). Oswald, bishop of Winchester, who died February 29, 992, is also commemorated as a saint (October 15).

**OSWALDTWISTLE**, a township of Lancashire, England, is situated on the Leeds and Liverpool Canal and the East Lancashire Railway,  $3\frac{1}{2}$  miles east-south-east of Blackburn and 24 north of Manchester. It possesses cotton-mills, printworks, bleachworks, and chemical works, and in the neighbourhood there are collieries, stone quarries, and potteries. The population of the township and urban sanitary district (area 4883 acres) in 1871 was 10,283, and in 1881 it was 12,206.

**OSWEGO**, a city and port of entry of the United States, capital of Oswego county, New York, stretches between 2 and 3 miles along the south-east shore of Lake Ontario, on the low bluffs and hilly ground near the mouth of the Oswego river, which divides it into two nearly equal portions, and is spanned by three iron drawbridges. By the Delaware, Lackawanna, and Western Railroad it is 305 miles from New York, and by the New York, Ontario, and Western Railway 326 miles. The Oswego Canal connects at Syracuse with the Erie Canal. The situation of the city is a beautiful and healthful one: most of the streets are 100 feet wide, and there are two finely-shaded public parks, one on each side of the river. Among the more conspicuous buildings are the adjunct custom-house, post-office, and United States court-house, erected in 1858 at a cost of \$120,000, the city-hall, the county court-house, the State armoury, the church of the Evangelists, the large Roman Catholic church in Mohawk Street, the public library (10,000 volumes), the normal and training schools, the city almshouse (2 miles outside the city limits), and the orphan asylum. Falling 34 feet in its passage through the city, Oswego river furnishes a good supply of water-power, rendered available by a canal on each side. Besides the Oswego starch factory (founded in 1848, and now probably the largest in the world, occupying 10 acres of ground, partly with fireproof buildings seven stories high, and producing 35 tons of starch daily), the manufactories of Oswego comprise flour-mills, large iron-works (making steam-engines, steam-shovels, dredges, &c.), knitting works, shade-cloth factories, railway carriage works and repair shops, box factories, planing-mills, and a large number of subsidiary establishments. In the extent of its trade Oswego is the principal United States port on Lake Ontario, importing vast quantities of grain and timber, and exporting coal, flour, and salt. The annual duties on imports average over \$1,000,000. The inner harbour, formed by the river mouth being enclosed by jetties, has about 3 miles of wharfage, and a depth at low water of from 9 to 13 feet; and the outer harbour, formed by the construction since 1871 of a breakwater 5700 feet long, has about 4 miles of wharfage, and a depth of 20 feet. Fort Ontario, rebuilt by the United States Government in

1839, guards the entrance to the harbour; it is a place of some strength. The population of Oswego was 12,205 in 1850, 20,910 in 1870, and 21,112 in 1880.

Oswego was visited by Champlain in 1615, by the Jesuits Le Mayne in 1654, and by other early explorers. In 1722 the English established a trading post here, and in 1727 Governor William Burnet (son of Bishop Burnet) erected Fort Oswego. A body of about 700 men, left here by Governor Shirley, constructed in 1755-56 two other forts—Fort Ontario on the east and Oswego New Fort on the west side of the river. In 1756 the place was bombarded and captured by Montcalm; but between 1757 and 1759 new works were constructed by the English, who kept possession till Oswego was transferred to the United States by the Jay treaty in 1796. In 1814 Sir James Yeo took the fortress after a bombardment of three hours. The little hamlet of Oswego, commenced by Neil M'Mullen, rapidly increased after the introduction of steam navigation on the lake (1816) and the construction of the Welland and the Oswego Canal (1828). In 1828 it was incorporated as a village, in 1848 as a city.

**OSWESTRY**, a market-town and municipal borough in Shropshire, England, on the borders of Wales, on two railway lines and near the Shropshire Canal, 18 miles north-west of Shrewsbury and 16 north from Welshpool. It is a well-built town with wide and regular streets, although some of the old wooden houses still remain. There are still some traces of the ancient castle erected in the reign of Stephen. The church of St Oswald, originally conventual, has been very much altered, the original structure having been more than once damaged, and the tower taken down by the Royalists in 1644. It was restored in 1872 at a cost of £10,000. For the free grammar school, founded in the reign of Henry IV., a new building was erected in 1810, which was enlarged in 1863 and 1878. Among the other public buildings are the public hall, the Victoria Rooms, the guildhall, the general market-hall, the literary institute, the union workhouse, and the cottage hospital. The town possesses locomotive repairing works, steam-engine, threshing machine, and agricultural implement works, steam printing works, corn mills, malting works, breweries, and a leather factory. In the vicinity are coal-mines and limestone quarries. The population of the municipal borough (area 1888 acres) in 1871 was 7306, and in 1881 it was 7847.

Oswestry was called by the Britons Tre'r Cadsiriau, the town of chairs or seats commanding an extensive view, in reference to the eminences in the neighbourhood. It existed in the 4th century, and, having been given in the 5th century by Cunedda Wlodig, prince of North Wales, to his son Oswael, it received the name of Oswailing and subsequently Maserfield. After a battle in 642 between Oswald the Christian king of Northumbria, and Penda the pagan king of Mercia, in which the former was slain, the name was changed to Oswaldstre (Welsh, *Croes Oswallt*), which was gradually corrupted into Oswestry. On the spot where Oswald was slain a monastery was afterwards erected, and near its site there is a spring still called Oswald's well. In 777 Oswestry was disjoined from Powis and added to Mercia. It stands between Offa's and Wat's dykes. About a mile from the town is an old British earthwork, known as Old Port, a corruption of Old Fort (Welsh, *Hên Dinas*), and sometimes called Old Oswestry, from a tradition that Oswestry originally occupied its site. Oswestry is not mentioned in Domesday. The castle is said to have been built about 1149 by Madoc, the ruler of Powis Vadog. It was burned in 1216 and in 1288. Edward I. began in 1277 to surround the town with walls, which were about one mile in circumference and had four gates. During invasions of the Welsh the town was burned in 1400 and 1408; it also suffered severely from a similar cause in 1542, 1544, and 1567, and in 1559 it was devastated by the plague. Oswestry was garrisoned for the Royalists, but surrendered 22d June 1644, and a few years afterwards the castle was demolished. The town obtained the grant of a fair from Henry III. It received its first charter from William Fitz-Alan in the reign of Henry II., and a royal charter from Richard II. Its present charter was granted by Charles II.

See Price, *History of Oswestry*, 1815; Cathrall, *History of Oswestry and Topography of the Borough*, 1855; Pennant, *Tow*; Eyton, *Antiquities of Shropshire*.

**OTAGO**. See NEW ZEALAND.

**OTAHETE**, or TAHITI. See SOCIETY ISLANDS.

**OTHO**, MARCUS SALVIUS, Roman emperor from January 15 to April 15, 69 A.D., was born April 28, 32 A.D. He belonged to an ancient and noble Etruscan

family, settled at Feruntinum in Etruria. His grandfather had been a senator and held the prætorship; his father had added to the family honours the dignity of a consulship. Otho himself first appears in history as one of the most reckless and extravagant of the young nobles who surrounded Nero and shared his revels. But his friendship with that emperor was brought to an abrupt close in 58 A.D., when Otho was only twenty-six years old, by his refusal to divorce his beautiful wife Poppæa Sabina at the bidding of Nero, who was enslaved by her charms. The emperor, impatient as usual of anything that hindered the gratification of his passions, at once removed Otho from the scene by appointing him governor of the remote province of Lusitania. In this honourable exile Otho remained for ten years, and, contrary to all expectation, his administration was marked by a moderation unusual at the time. When in 68 his neighbour Galba, the governor of Hispania Tarraconensis, rose in revolt against Nero, Otho at once joined him and accompanied him to Rome. Resentment at the treatment he had received from Nero may very well have impelled him to this course, but to this motive was added before long that of personal ambition. Galba was far advanced in years, and Otho, encouraged by the predictions of astrologers, aspired to succeed him, and, as a preliminary step, to be adopted as his heir by the emperor himself. With this object in view he set himself to win the affections of the soldiery and the populace in Rome, who, disgusted by Galba's old-fashioned parsimony and severity, were easily brought to look favourably upon a claimant for the imperial purple whose open-handed generosity and easy manners promised a return of the golden years of Nero. But in January 69 his hopes in this direction were dissipated by Galba's formal adoption of L. Calpurnius Piso as the fittest man to succeed him. Nothing now remained for Otho but to strike a bold blow for the prize which seemed to be slipping from his grasp. Desperate as was the state of his finances, thanks to his previous extravagance, he found money enough to purchase the services of some three-and-twenty soldiers of the prætorian guard, with whom he arranged his plan of operations. On the morning of January 15, five days only after the adoption of Piso, Otho attended as usual to pay his respects to the emperor, and then hastily excusing himself on the score of private business hurried from the Palatine to meet his slender band of accomplices in the forum. By them he was escorted to the prætorian camp, where, after a few moments of surprise and indecision, he was saluted imperator by the assembled troops. At the head of an imposing force he returned to the forum, and at the foot of the Capitol encountered Galba himself, who, alarmed by vague rumours of treachery, was making his way through a dense crowd of wondering citizens towards the barracks of the guard. The cohort on duty at the Palatine, which had accompanied the emperor, instantly deserted him; Galba himself was brutally murdered by the fierce prætorians, and his fate was shared by his adopted heir Piso, and by his chief confidants and advisers. The brief struggle over, Otho returned in triumph to the camp. Towards sunset on the same day he proceeded to the senate-house, and there was duly invested by the senators with the name of Augustus, the tribunician power, and the other dignities belonging to the principate. Otho had owed his success largely, not only to the resentment felt by the prætorian guards at Galba's well-meant attempts to curtail their privileges in the interests of discipline, but also to the attachment felt in Rome for the memory of Nero; and his first acts as emperor showed that he was not unmindful of the fact. He accepted, or appeared to accept, the cognomen of Nero conferred upon him by the shouts of the populace, whom

his comparative youth and the officinacy of his appearance reminded of their lost favourite. Nero's statues were again set up, his freedmen and household officers reinstalled in their places, and the intended completion of the Golden House announced. At the same time the fears of the more sober and respectable citizens were allayed by Otho's liberal professions of his intention to govern equitably, and by his judicious clemency towards Marius Celsus, consul-designate, a devoted adherent of Galba. These favourable symptoms were eagerly seized upon as promising better things than could have been hoped for from one who was only known as yet in Rome as a passionate and reckless profligate and spendthrift.

But any further development of Otho's policy was speedily checked by the news which reached Rome shortly after his accession, that the army in Germany had declared for Vitellius, the commander of the legions on the lower Rhine, and were already advancing upon Italy under the command of Vitellius's two lieutenants, Fabius Valens and Alienus Cæcina. After in vain attempting to conciliate Vitellius by the offer of a share in the empire, Otho, with unexpected vigour, prepared for war. His resources were not contemptible. From the remote provinces, indeed, which had acquiesced in his accession little help was to be expected; but the legions of Dalmatia, Pannonia, and Mœsia were eager in his cause, the prætorian cohorts were in themselves a formidable force, and an efficient fleet gave him the mastery of the Italian seas. Nor was he himself wanting in promptitude. The fleet was at once despatched to secure Liguria, and on March 14 Otho, undismayed by omens and prodigies, started northwards at the head of his troops, in the hopes of preventing the entry of the Vitellian troops into Italy. But for this he was too late. Both Valens and Cæcina had already crossed the Alps,—the former by the Cottian, the latter by the Pennine passes,—and all that could be done was to throw troops into Placentia and hold the line of the Po. The campaign opened favourably for Otho. His advanced guard successfully defended Placentia against Cæcina, and compelled that general to fall back on Cremona. But the arrival of Valens altered the aspect of affairs. The Vitellian commanders now resolved to bring on a decisive battle, and their designs were assisted by the divided and irresolute counsels which prevailed in Otho's camp. The more experienced officers urged the importance of avoiding a battle, until at least the legions from Dalmatia had arrived. But the inconsiderate rashness of the emperor's brother Titianus and of Ercolus, prefect of the prætorian guards, added to Otho's feverish impatience of prolonged suspense, overruled all opposition, and an immediate advance was decided upon, Otho himself remaining behind with a considerable reserve force at Brixellum, on the southern bank of the Po. At the time when this decision was taken the Othonian forces had already crossed the Po and were encamped at Bedriacum, a small village on the Via Postumia, and on the route by which the legions from Dalmatia would naturally arrive. Leaving a strong detachment to hold the camp at Bedriacum, the Othonian forces advanced along the Via Postumia in the direction of Cremona. At a short distance from that city they unexpectedly encountered the Vitellian troops, and a battle at once ensued. The Othonians, though taken at a disadvantage, fought desperately, but were finally defeated at all points and forced to fall back in disorder upon their camp at Bedriacum. Thither on the next day the victorious Vitellians followed them, but only to come to terms at once with their disheartened enemy, and to be welcomed into the camp as friends. More unexpected still, was the effect produced by the news of the battle at Brixellum. Otho was still in command of a formidable force—the Dalmatian legions had already reached Aquileia; and the spirit of his soldiers and their officers was still unbroken. But he was resolved to accept the verdict of the battle which his own impatience had hastened. He had made a bold throw for success and had failed. He was weary of the suspense and anxieties of a protracted struggle, and he may even have been sincere in his professed unwillingness to cause further bloodshed. In a dignified speech he bade farewell to those about him, and then retiring to rest slept soundly for some hours. Early in the morning he stabbed himself to the heart with a dagger which he had concealed under his pillow, and died as his attendants entered the tent. His funeral was celebrated at once, as he had wished, and not a few of his soldiers followed their master's example by killing themselves at his pyre. A plain tomb was erected in his honour at Brixellum, with the simple inscription "Dis Manibus Marci Othonia." At the time of his death (April 15, 69) he was only in his thirty-eighth year, and had reigned just three months. In all his life nothing became him so well as his manner of leaving it; but the fortitude he then showed, even if it was not merely the courage of despair, cannot blind us to the fact that he was little better than a reckless

and vicious spendthrift, who was not the less dangerous because his fiercer passions were concealed beneath an affectation of effeminate dandyism.

(H. F. P.)

OTHO I. (912-973), called The Great, Holy Roman emperor, was born in 912. After the death of his father, Henry, king of Germany, he was elected and crowned king in 936 at Aix-la-Chapelle; and he occupied the throne upwards of thirty-six years. His reign was one of the most momentous in mediæval history, its chief incident being his assumption of the imperial crown, whereby he rendered impossible the growth of a compact German monarchy. Otho was a man of great ambition, stern and resolute; and soon after his coronation as king of Germany his leading vassals saw that he intended to claim from them something more than nominal allegiance. First he had to suppress a rebellion headed by Eberhard, duke of Franconia, in association with Thankmar, a son of King Henry by a marriage which had been declared invalid. When this insurrection was put down, Thankmar having died, there was a more formidable rising, in which Eberhard secured the alliance of Otho's younger brother Henry, of Giselbert, duke of Lorraine, of Frederick, archbishop of Mainz, and of other powerful prelates. The king was again triumphant, and on this occasion he strengthened his position by retaining Franconia in his own hands, and by granting Lorraine to his supporter Conrad, who married Otho's daughter Liudgard. To his brother Henry, whom he pardoned, he gave Bavaria; and over Swabia, after the death of its duke, he placed his own son Ludolf. His native duchy, Saxony, was entrusted to Count Hermann, called Billung, a brave noble who had distinguished himself in wars on the eastern borders of Germany. Thus all the great offices of the state were held by Otho's kinsmen and friends; and he exercised more direct control over his subjects than any sovereign, except Charlemagne, had done before him. In wars with the Bohemians, the Wends, and the Danes Otho was not less successful. In 951 he crossed the Alps to help Queen Adelaide, and, having conquered Berengar II., he married her and became king of Lombardy. On his return to Germany his son Ludolf rebelled against him, and was aided by Duke Conrad, by Archbishop Frederick of Mainz, and by many discontented magnates. In the midst of the struggle Germany was attacked by the Magyars, whom Duke Conrad had summoned to his aid. This common danger led to the establishment of internal peace, and Otho succeeded in defeating the Magyars. When in 955 they returned in greater numbers than ever, he inflicted on them so decisive a defeat that they did not again invade Germany. In 961, in response to the appeal of Pope John XII., Otho returned to Italy to punish his rebellious vassal Berengar; and on the 2d February 962 he was crowned emperor by the pope, for the deposition of whom he soon afterwards summoned a council. At this time Otho remained two years in Italy, and a later visit extended over six years, during which he not only maintained his authority in Lombardy, but sought to assert it in southern Italy. In Germany his policy was directed chiefly to the strengthening of the church, which was to act as a counterpoise to the influence of the secular nobles. He died on the 7th May 973, at Memleben, and was buried in Magdeburg, which he had made the seat of an archbishopric.

See Köpke and Dümmler, *Kaiser Otto der Grosse*, 1876.

OTHO II. (955-983), Holy Roman emperor, son of Otho I. and Adelaide, was born in 955. In the lifetime of his father he was twice crowned, in 961 as king of Germany, and in 967 (at Rome) as emperor. He became sole ruler after the death of Otho I. in 973. Early in his reign he had to suppress a great conspiracy organized by

his cousin, Duke Henry of Bavaria; and at the same time he was repeatedly attacked by Harold, king of the Danes. In 978, when his authority had been in some measure re-established, he was confronted by a now danger, for Lothair, king of France, suddenly invaded Lorraine. Otho hastily assembled an army, drove Lothair from Lorraine, and pushed on to Paris, which he unsuccessfully besieged. In the treaty by which peace was concluded, France formally recognized the right of Germany to Lorraine. Otho next went to restore order in Rome, from which Pope Benedict VII. had been expelled by Crescentius. In southern Italy Otho (who, in virtue of his wife, Theophano, claimed Apulia and Calabria) waged war with the Saracens, and defeated them in a great battle. On the 13th July 982, however, he himself was defeated, and was very nearly taken prisoner. At a diet in Verona, attended by German and Italian princes, his son Otho, three years of age, was chosen to be his successor, and arrangements were made for a new campaign in the south. On the 7th December 983 Otho II. died, leaving the empire in a state of confusion, the Danes and the Wends, encouraged by his defeat, having risen against German supremacy. Although warlike and impetuous, Otho II. was a man of refined and scholarly tastes, which had been carefully cultivated by his mother.

See Giesebrecht, *Geschichte der deutschen Kaiserzeit*.

OTHO III. (980-1002), Holy Roman emperor, son of Otho II. and Theophano, was born in 980, and crowned king of Germany at Aix-la-Chapelle in 983. After his coronation his kinsman, Duke Henry of Bavaria, who had been imprisoned by Otho II. in Utrecht, made his escape and seized the young king, in whose name he proposed to govern the empire. His pretensions were resisted, however, and he agreed to submit on condition of being reinstated in his dukedom. During Otho's minority public affairs were administered, with the aid of Willegis, archbishop of Mainz, by his mother Theophano, his grandmother Adelaide, and his aunt Matilda, sister of Otho II. and abbess of Quedlinburg. Otho was a dreamy and imaginative youth of brilliant talents, which were carefully developed by Gerbert, the greatest scholar of the age. In 996, when Otho was declared to have reached his majority, he went to Rome, where Crescentius had made himself suprema. After the death of Pope John XV. Otho caused Bruno, who was related to the Saxon dynasty, to be elected to the holy see; and by him (Gregory V.) Otho was crowned emperor on the 21st May 996. After Otho's departure Crescentius again rose, drove Gregory V. from Rome, and set up an anti-pope. Otho immediately returned, and Crescentius, with twelve of his supporters, was executed. On the death of Gregory V., Otho's tutor, Gerbert, archbishop of Ravenna, was appointed pope; and, in part through his influence, the emperor began to form great plans, deciding to make Rome the centre of the secular as well as of the spiritual world. At the approach of the year 1000, when it was commonly supposed that the earth was about to be destroyed, Otho returned to Germany and made a pilgrimage to the tomb of St Adalbert at Gnesen. Afterwards, in Aix-la-Chapelle, he entered the vault in which the body of Charlemagne sat upon a throne, and took away the golden cross which hung on the mighty emperor's breast. In 1001 Otho went back to Italy for the purpose of carrying out his far-reaching schemes; but popular disturbances in Rome compelled him to quit the city; and on the way to Ravenna, where he proposed to wait for a German army, he died at Paterno, near Viterbo, on the 21st January 1002.

See Wilmans, *Jahrbücher des deutschen Reichs unter Kaiser Otto III.*; Giesebrecht, *Geschichte der deutschen Kaiserzeit*.

**OTHO IV.** (c. 1174–1218), Holy Roman emperor, the second son of Henry the Lion, duke of Saxony and Bavaria, of the house of Guelph, was born about 1174. After the banishment of his father to England in 1180, Otho was educated at the court of Richard I, whose sister Matilda was Otho's mother. Otho distinguished himself in the war between England and France, and in 1196 Richard I made him duke of Aquitaine and count of Poitou. In 1197, when the majority of the German princes, disregarding the previous election of Frederick II, offered the crown to Philip of Swabia, a party in the Rhine country, headed by the archbishop of Cologne, set up Otho as anti-king, and he was crowned at Aix-la-Chapelle. The result was a civil war which lasted about ten years, Philip being supported by most of the German princes and by the king of France, Otho by the kings of England and Denmark. For some time Pope Innocent hesitated to take part with either side, but at last he declared for Otho, who promised to make over certain fiefs claimed by the holy see. Notwithstanding the pope's aid, Otho's cause did not prosper; but in 1208 Philip was murdered by Otho of Wittelsbach, and then Otho IV. was universally acknowledged as king. On the 27th September 1209, at Rome, he was crowned emperor by the pope, to whom he had made new and more important concessions. Otho gave deadly offence to Innocent by seizing Ancona and Spoleto, which had been united to the papal territories; and, when the emperor, having conquered Apulia, was about to cross to Sicily, the pope excommunicated him, released the German princes from their oath of allegiance, and recognized the right of Frederick II to the throne. In 1212 Otho returned to Germany, where he acted with so much vigour that he seemed to be capable of defying the papacy; but he immediately lost ground when Frederick II, a youth of brilliant genius, appeared as his rival. After the battle of Bouvines (July 27, 1214), in which Otho, with King John of England, was defeated by the French, the discredited emperor had no chance of recovering his position. He made some ineffectual attempts to assert his claims, but ultimately he contented himself with the principality of Brunswick, which he had inherited when the Guelphic territories were divided in 1202. On the 19th of May 1218 he died at the Harzburg.

See Langerfeldt, *Kaiser Otto IV.*, 1872; Winkelmann, *Philipp von Schwaben und Otto IV.*, 1878.

**OTHO OF FREISING**, German historian, was the son of Leopold IV., margrave of Austria, and of Agnes, the daughter of the emperor Henry IV. He became a priest, and was made provost of the monastery of Neuburg, which had been founded by his father. Soon afterwards he went to Paris to prosecute his studies; and on his way back he joined the Cistercian order in the monastery of Morimont, in Burgundy, of which he became abbot. In 1137 he was elected bishop of Freising, and this position he held until his death on September 22, 1158.

He was the author of two important works, a universal history, in which he brought the record down to 1146, and a history of the reign of the emperor Frederick I. The first of these works was continued (to 1209) by Otho of St Blasien, the second by Ragwin. Otho was not a very accurate historian, but he was much more than a mere chronicler, his materials being clearly and effectively arranged, and his narrative giving evidence of a penetrating and philosophical judgment. A critical edition of his writings was presented for the first time in the *Monumenta Germaniae*, and this was afterwards separately published with the title, *Othonis Episcopi Frisingensis Opera*, 1867.

**OTIS, JAMES** (1724–1783), was born at Barnstable, Massachusetts, U.S., on February 5, 1724 (o.s.). He graduated with honours at Harvard in 1743, and for a year or two afterwards devoted himself to the study of literature before reading law. He had been a dozen years at the bar, and had risen to professional distinction, when in 1760 he

published a *Rudiments of Latin Prosody*, a book long ago out of print as well as out of date, but of authority in its time. He wrote also a similar treatise upon Greek prosody; but that was never published, because, as he said, there was not a fount of Greek letters in the country, nor, if there were, a printer who could have set it up. These, however, were his first and last works upon any other subject than politics. As the long war between Great Britain and France drew towards its close in 1762, measures were taken to enforce anew, in the British colonies in America, the commercial laws which had been in a measure lost sight of. The relaxation had taught the colonists that the burden was heavier than they thought when they bent beneath it; now the war had given them confidence in their own power, and the time had come, therefore, when resistance was inevitable. A trade with the West Indies in colonial vessels had been specially developed. This was in violation of the navigation laws, and to break it up an order in council was sent from England in 1760 directing the issue of writs of assistance, which would authorize the custom-officers to enter any man's house on suspicion of concealment of smuggled goods. The legality of a measure which would put so dangerous a power into the hands of irresponsible men was questioned, and the superior courts consented to hear argument. Otis was a law-officer under the Government. He refused, resigned his office, and appeared for the people against the issue of the writs. His plea was profound for its legal lore, fearless in its assertion of the rights of colonial Englishmen, and so fervid in its eloquence that it was said he "was a flame of fire." Though it failed to convince a court where the lieutenant-governor, Hutchinson, sat as chief justice, Otis was from that moment a man of mark. John Adams, who heard him, said, "American independence was then and there born." The young orator was soon afterwards unanimously elected a representative from Boston to the Colonial Assembly. To that position he was re-elected nearly every year of the remaining active years of his life, serving there with his father, who was usually a member, and often speaker, of that body. Of most of the important state papers addressed to the colonies to enlist them in the common cause, or sent to the Government in England to uphold the rights or set forth the grievances of the colonists, the younger Otis was the author. His influence at home in controlling and directing the movement of events which led to the revolution was universally felt and acknowledged; and abroad no American was so frequently quoted, denounced, or applauded in parliament and the English press, as the recognized head and chief of the rebellious spirit of the colonies.<sup>1</sup> In 1765 Massachusetts sent him as one of her representatives to the first Continental Congress, where he was a conspicuous figure. Four years later his brilliant public career was brought to a close. In consequence of a newspaper controversy with some Tory office-holders in Boston, he was attacked in a darkened room in a public coffee-house by a dozen men, and wounded by a blow upon the head from which he never recovered. His health gave way, and he was subject to frequent attacks of insanity. He was killed by lightning on the 23d May 1783.

A biography of Otis by William Tudor appeared in 1823; and a much briefer one, by Francis Bowen, in 1844.

<sup>1</sup> The political writings of Otis were chiefly controversial, and were published in the Boston newspapers. His more important pamphlets were *A Vindication of the Conduct of the House of Representatives of the Province of Massachusetts Bay*, published in 1763; *The Rights of the British Colonies Asserted and Proved*, 1764; *A Vindication of the British Colonies against the Assertions of the Halifax Gentleman, in his Letter to a Rhode Island Friend*,—a letter known at the time as the "Halifax Libel," 1765; *Considerations on Behalf of the Colonists in a Letter to a Noble Lord*, published in England the same year.

**OTLEY**, a market-town in the West Riding of Yorkshire, is picturesquely situated on the south bank of the Wharfe, at the foot of the precipitous Chevin Hill, 10 miles north of Bradford and 9 south-west of Harrogate. The river is crossed by a stone bridge of seven arches. The church of All Saints contains what is said to be a Saxon doorway belonging to the original building, and several interesting monuments. A free grammar school took its origin from a bequest by Thomas Cave in 1602, and was named in honour of Henry, prince of Wales, son of James I. A mechanics' institute was erected in 1869 in the Italian style, and a court-house in 1875. Worsteds spinning and weaving, machine making, tanning and leather dressing, organ-building, and paper-making are the principal industries. Otley is a very old town. It is mentioned in Domesday, the name being possibly derived from Othelai—the field of Otho. The population of the town and urban sanitary district (area 2370 acres) was 5855 in 1871 and 6806 in 1881.

**OTRANTO**, a city of Italy in the province of Lecce (Terra d'Otranto), 53½ miles by rail south of Brindisi on the coast of the Adriatic, within sight on a clear day of the mountains of Albania. Though at present a small place with a communal population of only 2333 (1881), it was formerly one of the most celebrated cities of southern Italy, and the seat of an archbishop who bore the title of primate of the Salentines.

Probably of Greek origin, Hydruntum or Hydrus, as it was called, seems for a time to have suffered from the prosperity of Brundisium, but by the 4th century it had become the regular port for travellers bound for the East by Apollonia and Dyrrachium. It remained in the hands of the Greek emperors till its second capture by Robert Guiscard in 1068. In 1480 the Turkish fleet under Achmet, grand-vizier of Mohammed II., destroyed the city and massacred or enslaved the inhabitants; and, though Otranto was recovered for Ferdinand by Alphonso, duke of Calabria, and fortified by King Alphonso and Charles V., it never rose to its former importance. During the war of the League of Cambrai, Ferdinand of Aragon expelled the Venetians, who had been for some time in possession of the city. In 1810 Napoleon made Fouché duke of Otranto. The cathedral (S. Annunziata), a three-aisled basilica ending in three apses, contains a mosaic floor dating from 1163, greatly injured by the Turkish horses; and the castle still stands which gave its title to Walpole's well-known novel, *The Castle of Otranto*.

**OTTAWA**, the capital of the Dominion of Canada, the seat of the supreme court, and the residence of the governor-general, of the Church of England bishop of Ontario, and of the Roman Catholic bishop of Ottawa, is situated in 45° 25' 59" N. lat. and 75° 43' 4" W. long., in the province of Ontario, on the south bank of the Ottawa (which forms the boundary between Ontario and Quebec), about 90 miles above its junction with the St Lawrence. By the Canadian Pacific Railway, which here crosses from the north to the south side of the Ottawa valley, the city is 120 miles west of Montreal (by the Canada Atlantic Railway the distance is 116 miles), and from Prescott on the Grand Trunk Railway and opposite Ogdensburg in New York it is distant 54 miles. The site of Ottawa is sufficiently remarkable, extending as it does for about 2 miles along the Ottawa from the Chaudière Falls (where the river, narrowed to 200 feet, rushes down about 40 feet over a broken ledge of rock) to the falls at the mouth of the Rideau (a right-hand tributary), and rising about midway into a cluster of hills—Parliament or Barrack Hill (160 feet), Major's Hill, &c.—which front the river with bold bluffs. The Rideau Canal, which skirts the east side of Parliament Hill, separates what is known as the higher from the lower town. To the south of Parliament Hill is the more commercial part of the city, stretching westward to the suburb of Rochesterville and the lumber district round the Chaudière Falls. Major's Hill, east of the canal, is laid out as a public park; and

Sandy Hill, to the south of the lower town, forms a residential quarter. Beyond the Rideau river lies the suburban village of New Edinburgh, with the official residence of the governor-general, Rideau Hall. The city of Hull too, on the opposite side of the Ottawa, in the province of Quebec, may be regarded as a suburb of the capital, with which it is connected by a suspension bridge. The Government buildings, which give the name to Parliament Hill, rank among the finest specimens of architecture in North America. The central pile, or Parliament House, is in Italian Gothic of the 13th century,—the material mainly Potsdam sandstone from Nepean. The main (south) front is 470 feet long and 40 feet high, and in the middle over the principal entrance stands Victoria Tower, 180 feet high, and surmounted by a great iron crown. In the centre of the north front is a semi-detached polygonal (almost circular) hall, 90 feet in diameter, appropriated to the library. The corner stone of the building was laid by the Prince of Wales in 1860. The total cost was about £1,000,000.

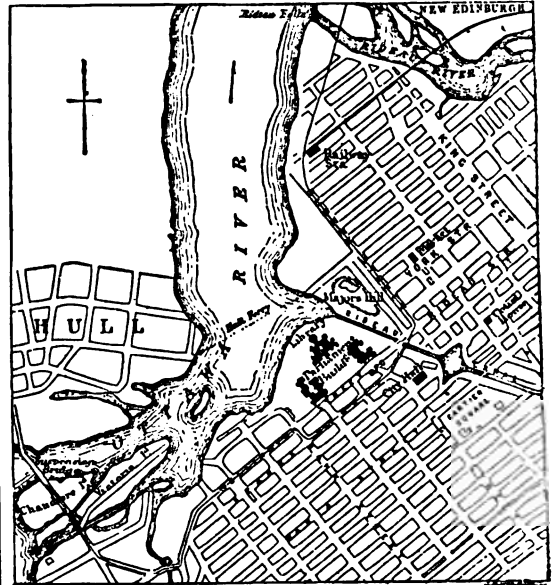

Plan of Ottawa.

(For ground plan and elevation see *The Builder*, 1859 and 1860.) Two extensive blocks of departmental buildings are placed like detached wings forming the sides of the quadrangle in front. Ottawa also contains a Roman Catholic cathedral (Notre Dame) with twin spires 200 feet high, the Gray Nunnery (the mother-house of the province of Ontario), the Black Nunnery, two convents, a Roman Catholic college (Ottawa University), a Roman Catholic hospital, a Protestant hospital, a Protestant ladies' college, a city-hall, a custom-house, the Government normal school for central Canada, the museum of the geological survey, &c. Besides being a great seat of the lumber trade, with saw-mills and match-works, it manufactures flour, cast-iron wares, leather, and bricks. The exports were valued at \$1,683,148 in the fiscal year ending June 1874, and at \$2,444,723 in the fiscal year 1883,—the imports at the same dates amounting to \$1,495,169 and \$1,562,344. The revenue arising from customs duties amounts to about £260,000 annually. The population of the city (about half being Roman Catholics and half Protestants) was 14,669 in 1861, 21,545 in 1871, and 27,412 in 1881. A mayor and board of aldermen constitute the municipal government, and the city is divided into five wards—Wellington, Victoria, St George's, By, and Ottawa.

Steamers ply in summer down to Montreal, and for about 200 miles up the river above the falls, as well as through the Rideau Canal to Kingston.

Philemon Wright of Woburn, in Massachusetts, settled in 1800 at the foot of the portage round the Chaudière Falls on the site of Hull, and some twenty years later he transferred his claim to the hills on the other side of the river to a teamster named Sparks, who would have preferred the \$200 due to him. Sparks Street is now the fashionable commercial street of Ottawa. In 1827 the Rideau Canal was constructed at a cost of \$2,500,000 to connect lower Canada with Kingston on Lake Ontario, and in that way prevent the necessity of gun-boats, &c., passing up the St. Lawrence exposed to the enemy's fire; and soon afterwards a town sprang up at the Ottawa end, called Bytown after Colonel By, R. E., who had surveyed the canal. At its incorporation as a city in 1854 Bytown received the name of Ottawa. In 1858 the queen, to whom the matter was referred, selected Ottawa as the capital of the Dominion of Canada, partly because of the advantages of its site, and partly to avoid invidious preference among the rival claims of Quebec, Montreal, Kingston, and Toronto. The first session of parliament in Ottawa was opened in 1855.

OTTAWA, a city of the United States, capital of La Salle county, Illinois, on both sides of the Illinois above and below the mouth of the Fox river (which furnishes abundant water-power by a fall of 29 feet), on the Illinois and Michigan Canal, and at the junction of the Fox river branch of the Chicago, Burlington, and Quincy Railway with the Chicago, Rock Island, and Pacific Railway, 84 miles southwest of Chicago. Ottawa ships large quantities of produce and live stock, and has manufactories of agricultural implements, carriages, glass, and clothing. The more conspicuous buildings are those occupied by the county courts and jail, and the supreme court for the northern division of the State. Near the south bank of the Illinois there are mineral springs possessing important medicinal properties. In 1880 the population was 7834 (811 in South Ottawa).

OTTENSEN, a town of Prussia, in the province of Schleswig-Holstein, lies on the right bank of the Elbe, immediately below Altona, of which it practically forms a part. It contains numerous villas of Hamburg merchants, and carries on manufactures of machinery, tobacco, soap, gilt frames and cornices, glass, iron, and other articles. Ottensen, which received its municipal charter in 1871, contained 15,375 inhabitants at the census of 1880. The three "Graves of Ottensen," besung by the poet Rückert, are those of 1138 citizens, who were expelled from Hamburg by Marshal Davoust in 1813-14, and perished here, of Charles, duke of Brunswick, who died at Ottensen of wounds received at the battle of Jena, and of Klopstock and his wife Meta. The last alone now remains.

OTTER, a group of animals belonging to the family *Mustelidae*, of the order *Carnivora* (see MAMMALIA, vol. xv. p. 439), distinguished from their allies by their aquatic habits. The true otters constitute the genus *Lutra* of zoologists, of which the common species of the British Isles, *L. vulgaris*, may be taken as the type. It has an elongated, low body, short limbs, short broad feet, with five toes on each, connected together by webs, and all with short, moderately strong, compressed, curved, pointed claws. Head rather small, broad, and flat; muzzle very broad; whiskers thick and strong; eyes small and black; ears short and rounded. Tail a little more than half the length of the body and head together, very broad and strong at the base, and gradually tapering to the end, somewhat flattened horizontally. The fur is of very fine quality, consisting of a short soft under fur of a whitish grey colour, brown at the tips, interspersed with longer, stiffer, and thicker hairs, very shining, greyish at the base, bright rich brown at the points, especially on the upper parts and outer surface of the legs; the throat, cheeks, under parts and inner surface of the legs brownish grey throughout. Individual otters vary much in size. The total length from the nose to the end of the tail averages about

3½ feet, of which the tail occupies 1 foot 3 or 4 inches. The weight of a full size male is from 18 to 24 lb, that of a female about 4 lb less.

As the otter lives almost exclusively on fish, it is rarely met with far from water, and usually frequents the shores of brooks, rivers, lakes, and, in some localities, the sea itself. It is a most expert swimmer and diver, easily overtaking and seizing fish in the water, but when it has captured its prey it brings it to shore to devour it. When lying upon the bank it holds the fish between its fore-paws, commences at the head and then eats gradually towards the tail, which it is said always to leave. The female produces three to five young ones at a time, in the month of March or April, and brings them up in a nest formed of grass or other herbage, usually placed in a hollow place in the bank of a river, or under the shelter of the roots of some overhanging tree. The Common Otter is found in localities suitable to its habits throughout Great Britain and Ireland, though far less abundantly than formerly, for, being very destructive to fish, and thus coming into keen competition with those who pursue the occupation of fishing either for sport or for gain, it is rarely allowed to live in peace when once its haunts are discovered. Otter hunting with packs of hounds of a special breed, and trained for the purpose, was formerly a common pastime in the country. When hunted down and brought to bay by the dogs, the otter is finally despatched by long spears carried for the purpose by the huntsmen.

The Common Otter ranges throughout the greater part of Europe and Asia. A closely allied but larger species, *L. canadensis*, is extensively distributed throughout North America, where it is systematically pursued by professional trappers for the value of its fur. An Indian species, *L. nasir*, is regularly trained by the natives of some parts of Bengal to assist them in fishing, by driving the fish into the nets. In China also otters are taught to catch fish, being let into the water for the purpose attached to a long cord.

Otters are widely distributed over the earth, and, as they are much alike in size and coloration, their specific distinctions are by no means well defined. Besides those mentioned above, the following have been described, *L. californica*, North America; *L. felina*, Central America, Peru, and Chili; *L. brasiliensis*, Brazil; *L. maculicollis*, South Africa; *L. schizolepis*, Japan; *L. chinensis*, China and Formosa, and other doubtful species. A very large species from Demerara and Surinam, with a prominent flange-like ridge along each lateral margin of the tail, *L. sandbachii*, constitutes the genus *Pteronura* of Gray. Others, with the feet only slightly webbed, and the claws exceedingly small or altogether wanting on some of the toes, and also with some difference in dental characters, are with better reason separated into a distinct genus called *Aonyx*. These are *A. tsumuguis* from South Africa and *A. leptonyx* from Java and Sumatra.

More distinct still is the Sea-Otter (*Enhydra lutris*). It differs from all other known *Carnivora* in having but two incisors on each side of the lower jaw, the one corresponding to the first (very small in the true otters) being constantly absent. Though the molar teeth resemble those of *Lutra* in their proportions, they differ very much in the exceeding roundness and massiveness of their crowns and bluntness of their cusps. The fore feet are very small, with five short webbed toes, and naked palms; the hind feet are altogether unlike those of the true otters, but approaching those of the seals, being large, flat, palmated, and furry on both sides. The outer toe is the largest and stoutest, the rest gradually diminishing in size to the first. The tail is about one-fourth of the length of the head and body, cylindrical and obtuse. The entire length of the animal from nose to end of tail is about 4 feet, so that the body is considerably larger and more massive than that of the English otter. The skin is peculiarly loose, and stretches when removed from the animal so as to give the idea of a still larger creature than it really is. The fur is remarkable for the preponderance of the beautifully soft woolly under fur, the longer stiffer hairs being very scanty. The general colour is a deep liver-brown, everywhere silvered or frosted with the hoary tips of the longer stiff



hairs. These are, however, removed when the skin is dressed for commercial purposes.

Sea-otters are only found upon the rocky shores of certain parts of the North Pacific Ocean, especially the Aleutian Islands and Alaska, extending as far south on the American



The Sea-Otter (*Enhydra lutris*). From Wolf in the *Proceedings of the Zoological Society of London*, 1865, pl. vii.

coast as Oregon; but, owing to the unremitting persecution to which they are subjected for the sake of their skins, which rank among the most valuable known to the furrier, their numbers are greatly diminishing, and, unless some restriction can be placed upon their destruction, such as that which protects the fur seals of the Pribyloff Islands, the species is threatened with extermination, or, at all events, excessive scarcity. When this occurs, the occupation of five thousand of the half-civilized natives of Alaska, who are dependent upon sea-otter hunting as a means for obtaining their living, will be gone. The principal hunting grounds at present are the little rocky islets and reefs around the island of Saanach and the Chernobours, where they are captured by spearing, clubbing, or nets, and recently by the more destructive rifle bullet. They do not feed on fish, like the true otters, but on clams, mussels, sea-urchins, and crabs, and the female brings forth but a single young one at a time, apparently at no particular season of the year. They are excessively shy and wary, and all attempts to rear the young ones in captivity have hitherto failed.

See Elliott Coues, *Monograph of North American Fur-bearing Animals*, 1877.

(W. H. F.)

OTTOMAN EMPIRE. See TURKEY.

OTTUMWA, a city of the United States, capital of Wapello county, Iowa, lies on the Des Moines river (here spanned by a bridge), 75 miles north-west of Burlington by the main line of the Chicago, Burlington, and Quincy Railroad. An important railway junction, in the heart of the coal-region of Iowa, and in possession of good water-power, Ottumwa, whose existence as a city dates from 1856, is growing in commercial and industrial activity. There is a large pork-packing establishment, killing 100,000 hogs annually. Among the manufactures are waggons and carriages, ploughs, sewing machine attachments, table-cutlery, corn-starch, linseed oil, harness, and furniture. The population was 1632 in 1860, 5214 in 1870, and 9004 in 1880.

OTWAY, THOMAS (1651-1685), the best English tragic poet of the classical school, was the son of the Rev. Humphrey Otway, rector of Woolbeding, near Midhurst in Sussex, and was born at the adjoining village of Trotton, March 3, 1651. He acknowledges his obligations to the care and education of his parents. He went to

school at Wickham, near Winchester, and in 1669 proceeded to Christ Church, Oxford. In 1671 he appeared at the Duke's Theatre, Lincoln's Inn Fields, in the *Forced Marriage*, a new play by Aphra Behn, but, failed ignominiously. Declining to take orders, he quitted the university in 1674, and obtained a cornetcy in a troop of horse. Within a twelvemonth he sold his commission, and came to London as a literary adventurer. In 1675 his *Alcibiades*, a poor play, was performed with indifferent success at the Duke's Theatre. In the following year *Don Carlos*, a vigorous rhymed tragedy, puerile in conception and showing little knowledge of human nature, but full of declamatory energy, took the town fairly by storm. He followed it up with translations of Racine's *Berenice* and Molière's *Fourberies de Scapin*, and with a very dull and indecent comedy of his own, *Friendship in Fashion*. He next went as a volunteer to the wars in Flanders, an unfortunate expedition which pointed the merciless lampoons of Rochester, to whom *Berenice* had been dedicated, but with whom he had now quarrelled. It also prompted his mediocre but not uninteresting play, *The Soldier's Fortune* (1679), in which he has turned his military experience to account. Next year he produced *The Orphan*, founded upon a novel called *English Adventures*, one of the two plays which have placed him in the first rank of English tragic poets; and *Caius Marius*, a wholesale but acknowledged plagiarism from *Romeo and Juliet*. In 1682 appeared his masterpiece, *Venice Preserved*, the plot of which is taken from Saint Réal's *Histoire de la Conjuracion du Marquis de Bedemar*. Its success was decisive, but it brought little pecuniary advantage to the author, who was already sinking into abject poverty, and, as appears by some letters attributed by Mr Gosse to this date, was further tormented by a hopeless passion for the beautiful Mrs Barry, the principal female performer in his plays. Some of his letters to her were first published with Rochester's works, and subsequently included in his own. Desponding and broken-hearted, he seems to have given himself up to dissipation, and produced but one more insignificant play, *The Atheist*, a second part of the *Soldier's Fortune* (1684). On April 14, 1685, he died on Tower Hill, under most melancholy circumstances if the tradition can be believed that he was choked by a piece of bread begged from a passer by. There is no absolute confirmation of this sad story, or of a late account which attributes his death to a fever caught by over-exertion in pursuing a robber. Whatever the exact manner of his decease, he certainly expired in obscurity and want. A tragedy called *Heroic Friendship* was published under his name in 1719. It has generally been regarded as wholly spurious; but Mr Gosse, his most sympathetic critic, recognizes some traces of his hand.

Otway's strong point is pathos. In this respect, though in no other, he is the Euripides of the English stage. When he would excite compassion he is irresistible. Unlike Shakespeare's, however, his pathos springs entirely out of the situation. His characters in themselves are not interesting, but the circumstances in which they are placed afford scope for the most moving appeals, and merit and demerit are altogether lost sight of in the contemplation of human suffering. The love scenes between Jaffier and Belvidera cannot be surpassed; and no plot more skilfully calculated to move the emotions than that of *Venice Preserved* was ever contrived by dramatist. It is to be regretted that modern fastidiousness has banished from the stage *The Orphan*, in which Johnson saw no harm. In everything but pathos Otway is mediocre: he has no deep insight into the human heart; his ideas are circumscribed and commonplace; and his attempted eloquence is frequently mere rant. Even the affecting madness of Belvidera verges dangerously on burlesque, and is no

doubt parodied in Sheridan's *Critic*. His boyish *Aleibiades* is positively absurd, and even *Don Carlos* produces much the same effect in the closet, though its rattling vigour carried it off well in the theatre at a time when nature was little regarded. It was probably not unknown to Schiller. The comedies and melodramas are simply tiresome, although a certain interest attaches to the military scenes in the *Soldier's Fortune*. There has hardly been another instance of a poet whose best and whose worst are at such an immeasurable distance from each other as Otway's; but his supreme excellence in one of the most difficult branches of the dramatic art must always be held to entitle him to an exalted place as a tragic poet. It has been remarked that Dryden, with all his splendour, has but one truly pathetic passage in the whole range of his dramas. Otway, writing simply from the heart, reached at a bound an eminence inaccessible to the laborious efforts of the greater poet. His miscellaneous poems are only interesting in so far as they illustrate his life and character. Of the latter little is known. He was a man about town in a dissipated age; but his references to his parents and friends, and his letters to the object of his unfortunate passion, show that he possessed deep and refined feeling.

See Baker, *Biographia Dramatica*; Johnson, *Lives of the Poets*; Goss, *Seventeenth Century Studies*; and Ward, *History of English Dramatic Literature*, vol. ii. (R. G.)

**OUDENARDE**, or **OUDENAERDE**, a small town of Belgium, in the province of East Flanders, on the Scheldt, 17 miles south-south-west from Ghent, with a population (1880) of 5880. It has manufactures of cotton and woollen fabrics, lace, tobacco, and starch, dyeing and bleaching establishments, salt refineries, distilleries, and so on. The town-hall, built in 1530 by Van Pede, is remarkable for the elegance of its architecture and the profusion of its ornament; the portal of the council chamber is a masterpiece of wood-carving, executed in 1534 by Paul van der Schelden. Among other buildings of interest are the old church of St Walburga, of the 10th century, partly rebuilt in the 14th, and that of Our Lady of Pamele, an example, rare in Belgium, of the transition Gothic style. A monument was erected at Oudenarde in 1567 to the memory of the Belgians who fell in Mexico, at the battle of Zacámbaro.

The origin of Oudenarde is unknown; it appears to have been a stronghold of some importance under the Romans. A fortress was erected there by Count Baldwin of Flanders in 1058. It was besieged in 1452 by the citizens of Ghent, who were repulsed by Simon de Lalain after a memorable siege. Alexander Farnese took the town in 1581. Close to its walls was fought, on July 11, 1708, the battle of Oudenarde, in which the French were defeated by the allied army under the command of Marlborough and Prince Eugene. It was retaken by the French in 1745.

**OUDH**, a province of British India, now under the political administration of the lieutenant-governorship of the North-Western Provinces, but in respect of its land and courts still a distinct chief-commissionership. Lying between 25° 34' and 28° 42' N. lat. and between 79° 44' and 83° 9' E. long., it is bounded on the N.E. by Nepál, on the N.W. by the Rohilkhand division, on the S.W. by the Ganges river, on the E. and S.E. by the Benares division. The administrative headquarters of the province are at Lucknow.

*Physical Aspects.*—Oudh forms the central portion of the great Gangetic plain, sloping downwards from the Nepál Himalayas in the north-east to the Ganges on the south-west. For 60 miles along the northern border of Gonda and Bahráich districts the boundary extends close up to the lower slopes of the Himalayas, embracing the damp and unhealthy sub-montane region known as the *terái*. To the westward of this, the northern boundary recedes a little from the mountain tract, and the *terái* in

this portion of the range has been for the most part ceded to Nepál. With the exception of a belt of Government forest along the northern frontier, the rest of the province consists of a fertile and densely peopled monotonous plain. The greatest elevation (600 feet) is attained in the jungled plateau of Khairigarh in Kheri district, while the extreme south-east frontier is only 230 feet above sea-level. Four great rivers traverse or skirt the plain of Oudh in converging courses—the Ganges, the Gumti, the Gogra, and the Ráptí. Numerous smaller channels seam the whole face of the country, carrying off the surplus drainage in the rains, but drying up in the hot season. All the larger rivers, except the Gumti, as well as most of the smaller streams, have beds hardly sunk below the general level; and in time of floods they burst through their confining banks and carve out new channels for themselves. Numerous shallow ponds or *jháls* mark the former beds of the shifting rivers. These *jháls* have great value, not only as preservatives against inundation, but also as reservoirs for irrigation. The soil of Oudh consists of a rich alluvial deposit, the detritus of the Himalayan system, washed down into the Ganges valley by ages of fluvial action. Usually a light loam, it passes here and there into pure clay, or degenerates occasionally into barren sand. The uncultivable land consists chiefly of extensive *usar* plains, found in the southern and western districts, and covered by the deleterious saline efflorescence known as *rah*. Oudh possesses no valuable minerals. Salt was extensively manufactured during native rule, but the British Government has prohibited this industry for fiscal reasons. Nodular limestones (*kankar*) occurs in considerable deposits, and is used as road metal.

The general aspect of the province is that of a rich expanse of waving and very varied crops, interspersed by numerous ponds or lakes. The villages lie thickly scattered, consisting of low thatched cottages, and surrounded by patches of garden land, or groves of banyan, *pípál*, and *pákar* trees. The dense foliage of the mango marks the site of almost every little homestead,—no less an area than 1000 square miles being covered by these valuable fruit-trees. Tamarinds overhang the huts of the poorer classes, while the neighbourhood of a wealthy family may be recognized by the graceful clumps of bamboo. Plantains, guavas, jack-fruit, limes, and oranges add further beauty to the village plots. The flora of the Government reserved forests is rich and varied. The *sal* tree yields the most important timber; the finest logs are cut in the Khairigarh jungles and floated down the Gogra to Bahramghát, where they are sawn. The hard wood of the *shisham* is also valuable; and several other timber-trees afford materials for furniture or roofing shingle. Among the scattered jungles in various parts of the province, the *mahud* tree is prized alike for its edible flowers, its fruits, and its timber. The *jháls* supply the villages with wild rice, the roots and seeds of the lotus, and the *singhára* water-nut. The fauna comprises most of the animals and birds common to the Gangetic plain; but many species, formerly common, have now almost, if not entirely, disappeared. The wild elephant is now practically unknown, except when a stray specimen loses its way at the foot of the hills. Tigers are now only found in any numbers in the wilds of Khairigarh. Leopards still haunt the cane-brakes and thickets along the banks of the rivers; and *nilgái* and antelopes abound. Game birds consist of teal and wild duck, snipe, jungle fowl, and peacock.

*Climate.*—The climate of Oudh is less damp than that of Lower Bengal, and has greater varieties of temperature. The year falls naturally into three seasons—the rainy, from the middle of June to the beginning of October; the cold weather, from October to February or March; and the



hot season, from March to June. The mean temperature at Lucknow for the thirteen years ending 1880 was 78°; in 1881 it was the same, the maximum temperature on any one day during the year being 111°, and the minimum 35°. The heat proves most oppressive in the rainy season. The heaviest downpours occur in July and September, but are extremely capricious. The average annual rainfall at Lucknow for the fourteen years ending 1881 amounted to 37.57 inches.

**Population.**—Oudh is probably more densely peopled than any other equal rural area in the world. The census of 1881 returned the population at 11,887,741 (5,851,655 males and 5,536,086 females), distributed over an area of 24,245 square miles. The following table exhibits the areas and populations of the districts separately.

Divisions.	Districts.	Area in Square Miles.	Population (1881).
Lucknow...	Lucknow.....	989	696,824
	Unao.....	1,747	899,069
	Bera Bānki.....	1,768	1,026,788
Sitāpur...	Sitāpur.....	2,251	958,251
	Hardoi.....	2,812	987,630
	Kheri.....	2,992	831,922
Faisābād (Fyzābad).	Faisābād.....	1,689	1,081,419
	Bahrāich (Bharāich).....	2,741	878,048
	Gonda.....	2,875	1,270,926
Rāi Barellī	Rāi Barellī.....	1,738	951,905
	Sultānpur.....	1,707	957,912
	Partāgarh (Pratāgarh)	1,486	847,047
Total.....		24,245	11,887,741

Divided according to religion, the population consisted of 9,942,411 Hindus, 1,433,448 Mohammedans, 1154 Sikhs, 9060 Christians, and 1678 others. The Mohammedans are subdivided into the four classes of Sayyids, Shaikhs, Pathāns, and Mughals, but they have lost greatly in social prestige since the downfall of the royal line. In the higher rank they still number seventy-eight *idukdars*. Some of these, as the *rājās* of Utrānā and Nānpāra, trace their descent from local Mohammedan chieftains. Others belong to ancient Hindu families. The Mohammedans still furnish the ablest public servants in the province, and supply almost entirely the native bar. The lower orders make industrious cultivators and weavers. Among the Hindu population, the Brāhmins preponderate, numbering 1,864,788, about one-eighth of the entire population. They include, however, only six *idukdars* in the whole province, and two of these acquired their wealth during the later days of Mohammedan rule. Large numbers of them follow agriculture, but they make undesirable tenants,—most of them refusing to hold the plough, and cultivating their fields by hired labour. They supply good soldiers, however, and many are employed in trade. The Kshātriyas, or Rājās, form the great landholding class, but the majority are now in decayed circumstances. The Mohammedans, Brāhmins, and Kshātriyas compose the higher social stratum of society, and number altogether about a fourth of the entire population. Amongst the lower Hindus, the Kāyasthas, or clerk and scrivener class, number 147,432. The Sūdras or lowest class of Hindus include 1,185,512 Ahirs, cattle graziers and cultivators. The best tenantry and most industrious cultivators are to be found amongst the Kurmis, who number nearly 800,000. Of the aboriginal or semi-Hinduzed tribes some, such as the Pāsīs, who number 718,906, make good soldiers, and furnish the greater part of the rural police. Others, like the Bhārs and Thārus, live in small isolated groups on the outskirts of the jungle or the hill country, and hold no communication with the outer world. The Nats and Kanjars wander like gipsies over the country, with their small movable villages or wigwams of matting and leaf-screens. The Koris and Chamāras, weavers and leather-cutters, reach the lowest depth of all. In the northern districts many still practically occupy the position of serfs, bound to the soil, having seldom spirit enough to avail themselves of the remedy afforded by the courts of law. They hold the plough for the Brahman or Kshātriya master, and dwell with the pigs in a separate quarter of the village, apart from their purer neighbours.

Fifteen towns in the province have a population exceeding 10,000 persons, according to the census of 1881, namely—Lucknow, 239,773; Faisābād, 88,828; Lucknow Cantonment, 21,530; Bahrāich, 19,439; Shāhābād, 18,510; Fānda, 16,594; Sandila, 14,965; Khairābād, 14,217; Nawabganj, 13,933; Ajudhia, 11,643; Badauli, 11,894; Bīlgrām, 11,067; Mallāwān, 10,970; Lahārpur, 10,437; Hardoi, 10,026. Thirty-six other towns have a population exceeding 5000. The general population is essentially rural, spread over the surface of the country in small cultivating communities. Over 90 per cent. of the population belong to the rural class.

**Agriculture.**—There are three harvests, reaped respectively in September, December, and March, while sugar-cane comes to maturity in February, cotton in May, and *adwās* in almost any month of the year. The principal September crops are rice, Indian corn, and millets. Fine rice, transplanted in August from nurseries near the village sites, forms the most valuable item of the December harvest, the other staples being mustard-seed and pulses. Wheat forms the main spring crop. Sugar-cane occupies the land for an entire year; it requires much labour and several waterings, but the result in ordinary years amply repays the outlay.

At the date of the annexation of Oudh in 1856, 23,500 villages, or about two-thirds of the entire area of the province, were in the possession of the great *idukdars*, heads of powerful clans and representatives of ancient families, a feudal aristocracy, based upon rights in the soil, which went back to traditional times, and which were heartily acknowledged by the subordinate holders. The new settlement paid no regard to their claims, and many landholders were stripped of almost their entire possessions. The mutiny of 1857 suddenly put a stop to this work of disinheritance, and it is hardly to be wondered at that throughout Oudh, the whole *idukdars*, with a very few isolated exceptions, joined the sepoys. On the restoration of order the principle adopted was to restore to the *idukdars* all that they had formerly possessed, but in such a manner that their rights should depend upon the immediate grant of the British Government. About two-thirds of the number accepted an invitation to come to Lucknow, and there concluded political arrangements with the Government. On the one hand, the *idukdars* bound themselves to level all forts, give up arms, and act loyally, to pay punctually the revenue assessed upon them and the wages of the village officials, and to assist the police in keeping order. On the other hand, the British Government conferred a right of property unknown alike to Hindu and to Mohammedan law, comprising full power of alienation by will, and succession according to primogeniture in case of intestacy. The land revenue demand was fixed at one-half the gross rental; subordinate tenureholders were confirmed in their ancient privileges; and a clause was introduced to protect the actual cultivators from extortion. Such were the main features of the *sanads* issued by Sir C. Wingfield in October 1859, which constitute the land system of Oudh to the present day, subject to a few minor modifications. The detailed operations for giving effect to this settlement were carried out by a revenue survey, conducted both by fields and villages, begun in 1860, and finished in 1871. The total assessed area in 1881–82 was 14,877,020 acres, the total assessment as land revenue being £1,442,147, or an average of 1s. 11½d. per acre. The total cultivated area is 8,274,560 acres; cultivable and grazing lands are set down at 4,085,351 acres; and uncultivable waste at 2,567,109 acres.

The estates on the revenue roll are divided into three classes:—(1) those held under the *idukdars* rules described above; (2) those held by ordinary *samsādars* tenure; and (3) those held in fee-simple. There are altogether about 400 *idukdars* in the province, of whom about two-thirds, with an area of about 2½ million acres, hold their estates under the rule of primogeniture. The *samsādars* estates, locally known by the name of *masrāid*, may be the undivided property of a single owner; but far more commonly they are owned by a coparcenary community who regard themselves as descendants of a common ancestor. The fee-simple estates, which are very few in number, consist of land sold under the Waste Land Rules. The sub-tenures under the above estates are—(1) sub-settled villages comprised within *idukdars* estates; (2) lands known as *str*, *darwānt*, *nanāda*, and *dūddārt*, held by proprietors who have been unable to prove their right to the sub-settlement of a whole village; (3) groves held by cultivators, who, according to immemorial custom, give the landlord a certain share of the produce; (4) lands granted, either by sale or as gifts, for religious endowments; and (5) lands held rent-free by village servants and officials.

**Commerce and Manufactures.**—Under native rule the only exports were salt and saltpetre, while the imports were confined to articles of luxury required for the Lucknow court. Since the introduction of British authority, although Lucknow has declined, countless small centres of traffic have sprung up throughout the country. The staple exports consist of wheat and other food grains, and oil-seeds; the main imports are cotton piece goods, cotton twist, and salt. Cawnpur, though lying on the southern bank of the Ganges within the North-Western Provinces, is, in fact, the emporium for the whole trade of Oudh, by rail, road, and river. The enormous exports of wheat and oil-seeds from Cawnpur represent to a great extent the surplus harvest of the Oudh cultivator. A brisk trade is also carried on with Nepal, along the three frontier districts of Kheri, Bahrāich, and Gonda. The policy of the Nepal court is to compel this traffic to be transacted at marts within its own dominions. At all of these a considerable number of Oudh merchants are permanently settled, whereas Nepālis rarely cross the frontier to trade except for the purchase of petty necessaries. The principal exports from Oudh into Nepal are Indian and European piece goods, salt, sugar,

tobacco, spices, and chemicals. The imports from Nepal, which considerably exceed the exports in value, consist chiefly of rice, oil-seeds, ghee or clarified butter, metal-ware, timber, spices, drugs, and cattle.

No province of India is more destitute of wholesale manufactures than Oudh. Almost all manufactured articles of any nicety require to be imported. The only specialties are gold and silver lace-work, silver chasing, and rich embroidery, all confined to Lucknow, and the weaving of a peculiar class of cotton goods, which still flourishes at Tanda.

**Communication.**—The Oudh and Rohilkhand Railway forms the great trunk of communications. A branch runs from Lucknow through Unao to Cawnpur; and another diverges at Bāra Bānki to Baharāghāt on the Gogra. The whole railway forms a loop-line between the East Indian and the Sind, Punjab, and Delhi systems. Good roads connect all the principal towns, and much traffic passes along the rivers.

**Administration.**—The administration belongs to the non-regulation system, under which a single officer discharges both fiscal and judicial functions. The province contains twelve districts, each under a deputy-commissioner. The chief-commissionership is now amalgamated with the governorship of the North-Western Provinces. The high court, presided over by the judicial commissioner, forms the ultimate court of appeal. The principal items of revenue consist of the land revenue, which stands at about £1,060,000; stamps, £116,770; excise, £100,411; forests, £31,114; and others over £101,000. In 1881 the total police force numbered 754 officers and men, maintained at a cost of £95,815.

**Early.**—At the dawn of history Oudh appears as a flourishing kingdom, ruled over from Srāvastī by a powerful sovereign. In its capital Sakya Muni (Buddha) began his labours, and the city long remained a seat of learning for Buddhist disciples. For six centuries Srāvastī maintained a high position among the states of northern India, but in the 1st century of our era the Buddhist monarch of Kushān was defeated by the Brāhmanical king of Ujjāin, who razed the fane and holy places of Ajodhya, the Hindu sacred city, which had fallen into decay. A long struggle between Buddhism and Brāhmanism followed, and when the Chinese pilgrim Fa Hsien (c. 400 A.D.) visited Srāvastī, as one of the most sacred historical places of his religion, he found the once populous city still marked by lofty walls, enclosing the ruins of numerous temples and palaces, but inhabited only by a few destitute monks and devotees. In the 7th century the desolation was complete. According to local tradition, about the 8th or 9th century the Thāra, an aboriginal tribe, descended from the hills and began to clear the jungle which had overgrown the deserted kingdom, as it is the sacred city of Ajodhya. To the present day these aborigines are the only people who can withstand the influence of malaria, and so become the pioneers of civilization in the jungle tracts. About a century later, a family of Sombāsi lineage from the north-west, subjected the wild settlers to their sway. The new dynasty belonged to the Jain faith, and still ruled at or near the ruins of Srāvastī at the time of the invasion of Mahmūd's famous general, Sayyid Bālar. Towards the close of the 11th century Oudh was added to the kingdom of Kanauj by conquest. After its downfall Shāhab-ud-dīn Ghori, his lieutenant, overran Oudh in 1194. Mohammed Bakhtiyār Khilji was the first Mohammedan to organise the administration, and establish in Oudh a base for his military operations, which extended to the banks of the Brahmaputra. On the death of Kub-ud-dīn he refused allegiance to Altamah as a slave, and his son Ghiyās-ud-dīn established an hereditary governorship of Bengal. Oudh, however, was wrested from the Bengal dynasty, and remained an outlying province of Delhi. Although nominally ruled in the name of the Delhi empire by great Mohammedan vassals from Bahāich or Mānikpur, Oudh continued to be a congeries of Rājput principalities and baronies, which made war, collected revenues, and administered justice within their territories at their own pleasure. During the early days of Mohammedan supremacy the Hindu chiefs of southern Oudh were engaged in a desultory war with the receding Bhāra, an aboriginal tribe who had obtained a temporary ascendancy after the first Moslem invasions. Upon their subjection the Mohammedan kingdom of Jaunpur arose in the valley of the Ganges. Ibrahim Shāh Shāri, the ablest of the Jaunpur rulers, turned his attention to the fruitful province which lay in the direct path between his capital and Delhi. He attempted thoroughly to reduce Oudh to the condition of a Moslem country, and, as long as he lived, the people sullenly acquiesced. But on his death the national spirit successfully reasserted itself under the leadership of Rājā Tilok Chānd, probably a descendant of the Kanauj sovereigns; and for a hundred years the land had peace.

During the troubled times which followed the death of Bābar, the first Mughal emperor of Delhi, Oudh became a focus of dissension against the reigning house. After the final defeat of the Akbar dynasty at Panipat, and the firm establishment of Akbar's rule, the province settled down into one of the most important among the imperial vicerealties. Under the Mughal dynasty in

its flourishing days, the Hindu chieftains accepted their position without difficulty. But when the rise of the Mahrattā power broke down the decaying empire of Aurangzeb, the chieftains of Oudh again acquired an almost complete independence. About 1738 Saīdat Alī Khān, a Persian merchant, received the appointment of governor of Oudh, and founded the Mohammedan dynasty which ruled over Oudh down to our own days. Before his death, in 1743, Oudh had become practically an independent kingdom, the rulers retaining the title of nawāb waṣīf, or chief minister of the empire. Saīdat Khān was succeeded by his brother-in-law, Saīdar Jang, under whose wise rule the country enjoyed internal prosperity, although exposed to constant attacks from the Rohillās on one side and the Mahrattās on the other. The next nawāb, Shujā-ud-daulā, who succeeded his father Saīdar Jang in 1753, attempted to take advantage of the war in Bengal between the British and Mir Kāsim to acquire for himself the rich province of Behar. He therefore advanced upon Patnā, taking with him the fugitive emperor Shāh Alam and the exiled nawāb of Bengal. The enterprise proved a failure, and Shujā-ud-daulā retired to Bazar, where, in October 1764, Major Munro won a decisive victory, which laid the whole of upper India at the feet of the Company. The nawāb fled to Bareilly (Bareilly), while the unfortunate emperor joined the British camp.

By the treaty of 1765 Korah and Allahābād, which had hitherto formed part of the Oudh vicerealty, were made over to the emperor for the support of his dignity and expenses, all the remaining territories being restored to Shujā-ud-daulā, who had thrown himself upon the generosity of the British. A few years later, in 1771, the titular Mughal emperor, Shāh Alam, was a virtual prisoner in the hands of the Mahrattās, who extorted from him the cession of Korah and Allahābād. This was considered to be contrary to the terms of the treaty of 1765, and, as the emperor had abandoned possession of them, the British sold them to the Oudh nawāb. Saīdat Alī Khān, threatened by Sindhia on the advance of Zamān Shāh to the Indus, concluded a new treaty with the British in 1801, by which he gave up half his territories in return for increased means of protection. Rohilkhand thus passed under British rule, and the nawāb became still more absolute within his restricted dominions. Saīdat's son, Ghāz-ud-dīn Haider (1814), was the first to obtain the title of king. In 1847 Wajid Alī Shāh, the last king, ascended the throne. The condition of the province had long attracted the attention of the British Government. The king's army, receiving insufficient pay, recouped itself by constant depredations upon the people. The Hindu chiefs, each isolated in his petty fort, had turned the surrounding country into a jungle as a means of resisting the demands of the court and its soldiery. Before 1855 the chronic anarchy and oppression had reduced the people of Oudh to extreme misery.

A treaty was proposed to the king in 1856, which provided that the sole civil and military government of Oudh should be vested in the British Government for ever, and that the title of king of Oudh should be continued to him and his heirs male, with certain privileges and allowances. He refused to sign the treaty, and on the 18th February 1856 the British Government assumed the administration of the province, Oudh thus becoming an integral part of the British empire. A provision of 12 lakhs a year was made to the king, who resides in a palace at Garden Reach, a few miles south of Calcutta. Wajid Alī Shāh has been allowed to retain the title of king of Oudh, but on his death the title will cease absolutely, and the allowance will not be continued on its present scale.

Immediately after annexation in 1856, Oudh was constituted into a chief-commissionership, and organized on the ordinary British model. In March 1867 Sir Henry Lawrence assumed the administration at Lucknow; and on the 30th of May five of the native regiments broke into mutiny. The remainder of the events connected with the siege and recovery of the capital have been narrated in the article on LUCKNOW. Since 1858 the province has been administered without further vicissitudes. On the 17th of January 1877 Oudh was partially amalgamated with the North-Western Provinces by the unification of the two offices of chief-commissioner and lieutenant-governor.

**OU DINOT, CHARLES NICOLAS (1767-1847)**, duke of Reggio, one of the most distinguished of Napoleon's marshals, came of a good bourgeois family in Lorraine, and was born at Bar-le-duc on April 25, 1767. From his youth he had a passion for a military career, and served in the regiment of Médoc from 1784 to 1787, when he retired with the rank of sergeant, and the knowledge that as a bourgeois he could never obtain a commission. The Revolution changed his fortunes, and in 1792, on the outbreak of war, he was elected lieutenant-colonel of the 3d battalion of the volunteers of the Meuse. His gallant defence of the little fort of Bitche in the Vosges in 1792

drow attention to him; he was transferred to the regular army in November 1793, and after serving in all the numerous actions on the Belgian frontier he was promoted general of brigade in June 1794 for his conduct at the battle of Kaiserslautern. He continued to serve with the greatest distinction on the German frontier under Hoche, Pichegru, and Moreau, and was repeatedly wounded and once (in 1795) made prisoner. He was Masséna's right hand all through the great Swiss campaign of 1799—first as a general of division, to which grade he was promoted in April, and then as chief of the staff—and was instrumental in winning the battle of Zurich. He was present under Masséna at the defence of Genoa, and so distinguished himself at the combat of Monzambano that Napoleon presented him with a sword of honour. On the declaration of the empire he was given the Grand Cross of the Legion of Honour, but was not included in the first creation of marshals. In the same year he received the command of ten battalions of the army of the reserve, which he formed into the famous division of the "grenadiers Oudinot," and with which he won the battle of Ostrolenka and decided the fate of at least three great battles—Austerlitz, Friedland, and Wagram. A week after the last-named battle he was promoted to the rank of marshal, and he was made Duc de Reggio in the following month. He administered the government of Holland from 1810 to 1812, and commanded the 2d corps of the grand army in the Russian campaign. He was present at Lützen and Bautzen, and when holding the independent command of the corps directed to take Berlin was defeated at Gross Beeren. He was then superseded by Ney, but the mischief was too great to be repaired, and Napoleon was utterly defeated at Leipsic. Though superseded, Oudinot was not disgraced, and held an important command throughout the campaign of 1814. On the abdication of Napoleon he rallied to the new Government, and was made a peer by Louis XVIII., and, unlike many of his old comrades, he remained faithful to his new sovereign, and did not desert to his old master in 1815. He died on September 13, 1847.

Oudinot's son, Charles Nicolas Victor, second duke of Reggio (1791-1863), served through the later campaigns of Napoleon from 1809 to 1814, but is chiefly known by his capture of Rome from Garibaldi in 1849.

OUGHTRFD, WILLIAM (1574-1660), an eminent mathematician, was born at Eton in 1574, and educated there and at King's College, Cambridge, of which he became fellow. Being admitted to holy orders, he left the university about 1603, and was presented to the rectory of Aldbury, near Guildford in Surrey; and about 1628 he was appointed by the earl of Arundel to instruct his son in mathematics. He corresponded with some of the most eminent scholars of his time on mathematical subjects; and his house was generally full of pupils from all quarters. It is said that he expired in a sudden transport of joy upon hearing the news of the vote at Westminster for the restoration of Charles II.

He published, among other mathematical works, *Clavis Mathematica*, in 1681; *A Description of the Double Horizontal Dial*, in 1636; and *Opuscula Mathematica*, in 1676.

OUNCE. See MAMMALIA, vol. xv. p. 435.

OURO PRETO, a city of Brazil, the chief town of the extensive province of Minas Geraes, lies 170 miles north by west of Rio de Janeiro, in the upper part of the Rio São Francisco basin, at a height of 3757 feet above the sea. A steep hill to the north of the peak of Itacolumi (5740) is broken up by ravines into a number of distinct plateaus; and it is round these plateaus, generally crowned by a church, that most of the houses of Ouro Preto cluster in irregular and almost independent groups. The streets run up and down hill in such a way as to

make riding on horseback hazardous and the use of carriages impossible. The stream which passes through the town and was formerly the scene of the most extensive gold washing operations, the Ribeirão de Ouro Preto or Do Carmo, is a tributary of the São Francisco. Besides the churches, the prominent buildings are the president's palace, the town-house, and the prison, all fronting the principal square, the treasury, the theatre (the oldest in Brazil, and restored in 1861-62), and the hospital. The botanical garden, dating from 1825, used to distribute specimens of different kinds of tea, but is now practically defunct. A public library has been in existence since before 1865. At present the importance of Ouro Preto is almost entirely administrative; formerly it was one of the great mining centres of Brazil. Its population is about 8000.

The first "prospectors," finding the hills full of a gold ore which, from the presence of silver alloy, turned black on exposure to the air, called them Serra do Ouro Preto, and the village, built in 1701 by Antonio Dias of Taubate, bore at first the same name (meaning Black Gold). In 1711 the settlement was formally constituted as the city of Villa Rica, and for sixty or seventy years it continued to deserve its new title,—the population amounting to 25,000 or 30,000, and 12,000 slaves being employed in its gold mines. When in 1720 Minas Geraes was separated from the captaincy of S. Paulo, Villa Rica was made the capital of the new province. In 1788 it was the centre of the disastrous attempt made by Tiradentes, the poet Gonzaga, &c., to found an independent republic in Brazil with São João del Rei as its capital and Villa Rica as its university town (see GONZAGA); and in 1821 it took a vigorous part in the successful revolution. A comarca of Ouro Preto was created in 1823, and Villa Rica received back its original name.

OUSEL, or OTZEL, Anglo-Saxon *Ode*, equivalent of the German *Amsel* (a form of the word found in several old English books, and perhaps yet surviving in some parts of the country), apparently the ancient name for what is now more commonly known as the Blackbird, the *Turdus merula* of ornithologists, but at the present day not applied to that species, though, as will immediately be seen, used in a compound form for two others. In many parts of Britain the Blackbird is still called the Merle, a name had directly from the French, and abbreviated from the Latin *Merula*, which has the same meaning. The adult male of this beautiful and well-known species scarcely needs any other description than that of the poet:—

"The Ousel-cock, so black of hue

With orange-tawny bill."

—*Midsommer Night's Dream*, act III. sc. 1.

But the female is of an uniform umber-brown above, has the chin, throat, and upper part of the breast orange-brown, with a few dark streaks, and the rest of the plumage beneath of a hair-brown. The young of both sexes resemble the mother. The Blackbird is found in every country of Europe, even breeding—though rarely—beyond the arctic circle, and in eastern Asia, as well as in Barbary and the Atlantic islands. Resident in Britain as a species, its numbers yet receive considerable accession of passing visitors in autumn, and in most parts of its range it is very migratory. The song of the cock has a peculiarly liquid tone, which makes it much admired, but it is rather too discontinuous to rank the bird very high as a musician. The species is very prolific, having sometimes as many as four broods in the course of the spring and summer. The nest, generally placed in a thick bush, is made of coarse roots or grass, strongly put together with earth, and is lined with fine grass. Herein are laid from four to six eggs of a light greenish-blue closely mottled with reddish-brown. Generally vermivorous, the Blackbird will, when pressed for food, eat grains and seeds, while berries and fruits in their season are eagerly sought by it, thus earning the enmity of gardeners. More or less allied to and resembling the Blackbird are many other species which inhabit most parts of the world, excepting the Ethiopian Region, New Zealand and Australia proper, and

North America. Some of them have the legs as well as the bill yellow or orange; and, in a few of them, both sexes alike display a uniformly glossy black. The only other species that need here be mentioned is the Ring-Ousel, *Turdus torquatus*, which differs from the Blackbird in the dark colour of its bill, and in possessing a conspicuous white gorget—whence its name. It has also very different habits, frequenting wild and open tracts of country, shunning woods, groves, and plantations, and preferring the shelter of rocks to that of trees. Its distribution is accordingly much more local, and in most parts of England it is only known as a transitory migrant in spring and autumn—from and to its hardly as yet ascertained winter quarters. It does not seem to have an extensive range to the eastward, though it has been recorded from Persia.

The Water-Ousel, or Water-Crow, now commonly named the "Dipper,"—a term apparently invented and bestowed in the first edition of Bewick's *British Birds* (ii. pp. 16, 17),—not, as is commonly supposed, from the bird's habit of entering the water in pursuit of its prey, but because "it may be seen perched on the top of a stone in the midst of the torrent, in a continual dipping motion, or short crouse often repeated." This, the *Cinclus aquaticus* of most ornithologists, is the type of a small but remarkable group of birds, the position of which many taxonomers have been at their wits' end to determine. It would be useless here to recount the various suppositions that have been expressed; suffice it to say that almost all ornithologists are now agreed in regarding the genus *Cinclus*<sup>1</sup> as



*Cinclus aquaticus.*

differing so much from other birds that, though essentially one of the true *Passeres* (i.e., *Ocines*), it forms a distinct Family, *Cinclidæ*, which has no very near allies. That some of its peculiarities (for instance, the sternum in adult examples having the posterior margin generally entire, and the close covering of down that clothes the whole body—a character fully recognized by Nitzsch) are correlated with its aquatic habit is probably not to be questioned; but this fact furnishes no argument for associating it, as has often been done, with the Thrushes (*Turdidæ*), the Wrens (*Troglodytidæ*), or much less with other groups to which it has undoubtedly no affinity. The Dipper haunts rocky streams, into which it boldly enters, generally by deliberately wading, and then by the strenuous combined action of its wings and feet makes its way along the bottom in quest of its living prey—freshwater mollusks, and aquatic insects in their larval or mature condition. By the careless and ignorant it is accused of feeding on the spawn of fishes, and it has been on that account subjected to much persecution. Innumerable examinations of the contents of its stomach have not only proved that the charge is baseless, but that the bird clears off many of the worst enemies of the precious product. Short and squat of stature, active and

restless in its movements, silky black above, with a pure white throat and upper part of the breast, to which succeeds a broad band of dark bay, it is a familiar figure to most fishermen on the streams it frequents, while the cheerful song of the cock, often heard in the hardest frost, helps to make it a favourite with them in spite of the obloquy under which it labours. The Water-Ousel's nest is a very curious structure,—outwardly resembling a Wren's, but built on a wholly different principle,—an ordinary cup-shaped nest of grass lined with dead leaves, placed in some convenient niche, but encased with moss so as to form a large mass that covers it completely except only a small hole for the bird's passage. The eggs laid within are from four to six in number, and are of a pure white. These remarks refer to the Water-Ousel of central and western Europe, including the British Islands; but, except as regards plumage, it is believed that they will apply to all the other species, about a dozen in number, which have been described. These inhabit suitable places throughout the whole Palearctic Region as well as the southern slopes of the Himalaya and the hill-country of Formosa, besides the Rocky Mountains and a great part of the Andes. Mr Salvin, in a very philosophical paper on the genus (*Ibis*, 1867, pp. 109–122), refers these species—some of which are wholly black and one slate-coloured—to five well-marked forms, of which the other members are either "representative species" or merely "local races"; but all seem to occupy distinct geographical areas,—that which is represented in the accompanying woodcut having a wide range along the mountainous parts of North America to Mexico; and it is quite possible that their number may yet be increased, for the general habits of the birds preclude any invasion of territory, and thus produce practical isolation.

(A. N.)

OUSELEY, SIR WILLIAM (1769–1842), Orientalist, was the eldest son of Captain Ralph Ouseley, of an old Irish family, and was born in Monmouthshire in 1769. After a private education he went to Paris, in 1787, to perfect himself in French, and in the following year became cornet in the 8th regiment of dragoons. After obtaining the grade of lieutenant he, on the conclusion of the campaign of 1794, sold his commission in order to devote his attention to the study of Oriental literature, especially Persian. In 1795 he published *Persian Miscellanies*; in 1797, *Oriental Collections*; in 1799, *Epitome of the Ancient History of Persia*; in 1801, *Tales of Bakhthar and Observations on Some Medals and Gems*; and in 1804, *The Oriental Geography of Ebn Haukal*. He received the degree of LL.D. from the university of Dublin in 1797; and in 1800 he was knighted by the Marquis Cornwallis. On his brother, Sir Gore Ouseley, being appointed ambassador to Persia in 1810, Sir William accompanied him as secretary. He returned to England in 1813, and in 1819–23 published, in three volumes, *Travels in Various Countries of the East, especially Persia*, in 1810, 1811, and 1812. He also published editions of the *Travels and Arabian Proverbs* of Burckhardt. He was a member of various learned societies, and contributed a number of important papers to the *Transactions of the Royal Society of Literature*. He died at Boulogne in September 1842.

OUTLAW, in English law, is a person put out of the protection of the law by process of outlawry. A woman is properly said to be waived rather than outlawed. Outlawry was usually the result of non-appearance of the defendant or accused at the trial, and involved deprivation of all civil rights. It was finally abolished in civil proceedings in 1879 by 42 & 43 Vict. c. 59, § 3. In criminal proceedings it has become practically obsolete, and the Criminal Code, § 458, proposes to formally abolish it.

<sup>1</sup> Some writers have used for this genus the name *Hydrobeta*.

In Scotland outlawry or fugitation may be pronounced by the supreme criminal court in the absence of the panel on the day of trial. In the United States outlawry never existed in civil cases, and in the few cases where it existed in criminal proceedings it has become obsolete.

**OUTRAM, SIR JAMES (1803-1868)**, English general, was the son of Benjamin Outram of Butterley Hall, Derbyshire, civil engineer, and was born 29th January 1803. His father died in 1805, and his mother, a daughter of Dr James Anderson, the Scottish writer on agriculture, removed in 1810 to Aberdeenshire. From Uday school the boy went in 1818 to Marischal College, Aberdeen; and in 1819 an Indian cadetship was given him. Soon after his arrival in India his remarkable energy attracted notice, and in July 1820 he became acting adjutant to the first battalion of the 12th regiment on its embodiment at Poona, an experience which he found to be of immense advantage to him in his after career. In 1825 he was sent to Khandesh, where he succeeded in training a light infantry corps, formed of the wild robber Bhils, gaining over them a marvellous personal influence, and employing them with great success in checking outrages and plunder. Their loyalty to him had its principal source in their boundless admiration of his hunting achievements, which in their cool daring and hairbreadth escapes have perhaps never been equalled. Originally a "puny lad," and for many years after his arrival in India subject to constant attacks of sickness, Outram seemed to win strength by every new illness, acquiring a constitution of iron, "nerves of steel, shoulders and muscles worthy of a six-foot Highlander." In 1835 he was sent to Gujerat to make a report on the Mahi Kanthá district, and for some time he remained there as political agent. On the outbreak of the Afghan war in 1838 he was appointed extra aide-de-camp on the staff of Sir John Keane, and besides many other brilliant deeds performed an extraordinary exploit in capturing a banner of the enemy before Ghazni. After conducting various raids against different Afghan tribes, he was in 1839 promoted major, and appointed political agent in Lower Sind, and later in Upper Sind. On his return from a short visit to England in 1843, he was, with the rank of brevet lieutenant-colonel, appointed to a command in the Mahratta country, and in 1847 he was transferred from Satára to Baroda. In 1854 he became chief-commissioner of Oudh, and in 1856 he received the honour of knighthood. Appointed in 1857, with the rank of lieutenant-general, to command an expedition against Persia, he defeated the enemy with great slaughter at Khushab, and otherwise conducted the campaign with such rapid decision that peace was shortly afterwards concluded, his brilliant services being rewarded by the Grand Cross of the Bath. From Persia he was summoned in June to India, with the brief explanation,—"We want all our best men here." Immediately on his arrival in Calcutta he was appointed to command the two divisions of the Bengal army, occupying the country from Calcutta to Cawnpur; and to the military control was also joined the commissioner-ship of Oudh. Already the rebellion had assumed such proportions as to compel Havelock to fall back on Cawnpur, which he only held with difficulty, although a speedy advance was necessary to save the garrison at Lucknow. On arriving at Cawnpur with reinforcements, Outram, "in admiration of the brilliant deeds of General Havelock," conceded to him the glory of relieving Lucknow, and, waiving his rank, tendered his services to him as a volunteer. During the advance he commanded a troop of volunteer cavalry, and performed exploits of great brilliancy at Mangalwar, and in the attack at the Alam-bagh; and in the final conflict he led the way, charging through a very tempest of fire. Resuming supreme com-

mand, he then held the town till the arrival of Sir Colin Campbell, after which he conducted the evacuation of the residency so as completely to deceive the enemy. In the second capture of Lucknow, on the commander-in-chief's return, Outram was entrusted with the attack on the side of the Gumti, and afterwards, having recrossed the river, he advanced "through the Chatter Manzil to take the residency," thus, in the words of Sir Colin Campbell, "putting the finishing stroke on the enemy." After the capture of Lucknow he was gazetted lieutenant-general. In February 1858 he received the special thanks of both Houses of Parliament, and in the same year the dignity of baronet with an annuity of £1000. When, on account of shattered health, he returned finally to England in 1860, a movement was set on foot to mark the sense entertained, not only of his military achievements, but of his constant exertions in behalf of the natives of India, whose "weal," in his own words, "he made his first object." The movement resulted in the presentation of a public testimonial and the erection of statues in London and Calcutta. He died 11th March 1863, and was buried in Westminster Abbey, where the marble slab on his grave bears the pregnant epitaph "The Bayard of India."

See *James Outram, a Biography*, by Major-General Sir F. J. Goldsmid, C.B., K.C.S.I., 2 vols., 1880, 2d ed., 1881.

**OVAR**, a town of Portugal, in the district of Aveiro (Beira), with a station on the railway 20 miles south of Oporto, lies at the northern end of the Aveiro lagoon, —an extremely unhealthy position. It contains 10,022 inhabitants (1878), and carries on a brisk trade with the colonies and northern Africa.

**OVATION**, an honour awarded in Rome to victorious generals. It was less distinguished than the triumph (see *ΤΡΥΜΦΗ*), and was awarded either when the campaign, though victorious, had not been important enough for the higher honour, or when the general was not of rank sufficient to give him the right to a triumph. The ceremonial was on the whole similar in the two cases, but in an ovation the general walked or more commonly rode on horseback.

**OVEN**, a close chamber or compartment in which a considerable degree of heat may be generated either from internal or from external sources. In English the term is generally restricted to a chamber for baking bread and other food substances, being equivalent to the French *four* or the German *Backofen*; but the chambers in which coal is coked are termed coke ovens. See **BAKING**, vol. iii. 257, and **COKE**, vol. vi. 118.

**OVERBECK, JOHANN FRIEDRICH (1789-1869)**, the reviver and leader of "Christian art" in the 19th century, was born in Lübeck 4th July 1789. His ancestors for three generations had been Protestant pastors; his father was doctor of laws, poet, mystic pietist, and burgo-master of Lübeck. Within stone's throw of the family mansion in the Königstrasse stood the gymnasium, where the uncle, doctor of theology and a voluminous writer, was the master; there the nephew became a classic scholar and received instruction in art.

The young artist left Lübeck in March 1806, and entered as student the academy of Vienna, then under the direction of F. H. Füger, a painter of some renown, but of the pseudo-classic school of the French David. Here was gained thorough knowledge, but the teachings and associations proved unendurable to the sensitive, spiritual-minded youth. Overbeck wrote to a friend that he had fallen among a vulgar set, that every noble thought was suppressed within the academy, and that losing all faith in humanity he turned inwardly on himself. These words are a key to his future position and art. It seemed to him that in Vienna, and indeed throughout Europe, the pure springs of

Christian art had been for centuries diverted and corrupted, and so he sought out afresh the living source, and, casting on one side his contemporaries, took for his guides the early and pre-Raphaelite painters of Italy. At the end of four years, differences had grown so irreconcilable that Overbeck and his band of followers were expelled from the academy. True art, he writes, he had sought in Vienna in vain—"Oh! I was full of it; my whole fancy was possessed by Madonnas and Christs, but nowhere could I find response." Accordingly he left for Rome, carrying his half-finished canvas *Christ's Entry into Jerusalem*, as the charter of his creed—"I will abide by the Bible; I elect it as my standing-point."

Overbeck in 1810 entered Rome, which became for fifty-nine years the centre of his unremitting labour. He was joined by a goodly company, including Cornelius, Wilhelm Schadow, and Philip Veit, who took up their abode in the old Franciscan convent of San Isidoro on the Pincian Hill, and were known among friends and enemies by the descriptive epithets—"the Nazarites," "the pre-Raphaelites," "the new-old school," "the German-Roman artists," "the church-romantic painters," "the German patriotic and religious painters." Their precept was hard and honest work and holy living; they eschewed the artifices as pagan, the Renaissance as false, and built up a severe revival on simple nature and on the serious art of Perugino, Pinturicchio, Francia, and the young Raphael. The characteristics of the style thus educed were nobility of idea, precision and even hardness of outline, scholastic composition, with the addition of light, shade, and colour, not for allurements, but chiefly for perspicuity and completion of motive. Overbeck was mentor in the movement; a fellow-labourer writes:—"No one who saw him or heard him speak could question his purity of motive, his deep insight and abounding knowledge; he is a treasury of art and poetry, and a saintly man." But the struggle was hard and poverty its reward. Helpful friends, however, came in Niebuhr, Bunsen, and Frederick Schlegel. Overbeck in 1813 joined the Roman Catholic Church, and thereby he believed that his art received Christian baptism.

Faith in a mission beget enthusiasm among kindred minds, and timely commissions followed. The Prussian consul, Bartholdi, had a house on the brow of the Pincian, and he engaged Overbeck, Cornelius, Veit, and Schadow to decorate a room 24 feet square with frescoes from the *Story of Joseph and his Brethren*. The subjects which fell to the lot of Overbeck were the *Seven Years of Famine and Joseph Sold by his Brethren*. These tentative wall-pictures, finished in 1818, produced so favourable an impression among the Italians that in the same year Prince Massimo commissioned Overbeck, Cornelius, Veit, and Schnorr to cover the walls and ceilings of his garden pavilion, near St John Lateran, with frescoes illustrative of *Lamé, Dante, and Ariosto*. To Overbeck was assigned, in a room 15 feet square, the illustration of *Tasso's Jerusalem Delivered*; and of eleven compositions the largest and most noteworthy, occupying one entire wall, is the *Meeting of Godfrey de Bouillon and Peter the Hermit*. The completion of the frescoes—very unequal in merit—after ten years' delay, the overtaxed and enfeebled painter delegated to his friend Joseph Führich. The leisure thus gained was devoted to a thoroughly congenial theme, the *Vision of St Francis*, a wall-painting 20 feet long, figures life size, finished in 1830, for the church of *Santa Maria degli Angeli* near Assisi. Overbeck and the brethren set themselves the task of recovering the neglected art of fresco and of monumental painting; they adopted the old methods, and their success led to memorable revivals throughout Europe.

Fifty years of the artist's laborious life were given to

oil and easel paintings, of which the chief, for size and import, are the following:—*Christ's Entry into Jerusalem* (1824), in the Marien Kirche, Lübeck; *Christ's Agony in the Garden* (1835), in the great hospital, Hamburg; *Lo Spozalizio* (1836), Raczyński gallery, Berlin; *the Triumph of Religion in the Arts* (1840), in the Stadel Institut, Frankfurt; *Pietà* (1846), in the Marien Kirche, Lübeck; *the Incredulity of St Thomas* (1851), in the possession of Mr Beresford Hope, London; *the Assumption of the Madonna* (1855), in Cologne Cathedral; *Christ Delivered from the Jews* (1858), tempera, on a ceiling in the Quirinal Palace,—a commission from Pius IX., and a direct attack on the Italian temporal government, therefore now covered by a canvas adorned with Cupids. All the artist's works are marked by religious fervour, careful and protracted study, with a dry, severe handling, and an abstemious colour.

Overbeck belongs to eclectic schools, and yet was creative; he ranks among thinkers, and his pen was hardly less busy than his pencil. He was a minor poet, an essayist, and a voluminous letter-writer. His style is wordy and tedious; like his art it is borne down with emotion and possessed by a somewhat morbid "subjectivity." His pictures were didactic, and used as propagandas of his artistic and religious faith, and the teachings of such compositions as the *Triumph of Religion* and the *Sacraments* he enforced by rapturous literary effusions. His art was the issue of his life: his constant thoughts, cherished in solitude and chastened by prayer, he transposed into pictorial forms, and thus were evolved countless and much-prized drawings and cartoons, of which the most considerable are the *Gospels*, forty cartoons (1852); *Via Crucis*, fourteen water-colour drawings (1857); the *Seven Sacraments*, seven cartoons (1861). Overbeck's compositions, with few exceptions, are engraved. His life-work he sums up in the words—"Art to me is as the harp of David, whereupon I would desire that psalms aloud at all times be sounded to the praise of the Lord." He died in Rome in 1869, aged eighty, and lies buried in San Bernardo, the church wherein he worshipped. (J. B. A.)

OVER DARWEN, a municipal borough of Lancashire, is situated in the vale of the Darwen river, shut-in by heath-covered hills, and on the Lancashire and Yorkshire Railway, 3 miles south from Blackburn and 9 north from Bolton. There are four ecclesiastical parishes, each of which has a handsome church; and among the other public buildings are the market-house, the Liberal and Conservative club-houses, a free public library with 10,000 volumes, and the Peel baths, erected in memory of Sir Robert Peel. The town possesses cotton factories, iron and brass foundries, machine works, paper mills, paper-staining works—the first and probably the largest of their kind. In the neighbourhood there are collieries and stone quarries. The population of the municipal borough (area 5918 acres) in 1881 was 29,744. It includes part of Lower Darwen and Eccleshill, with 2118 inhabitants. The postal designation is Darwen.

Over Darwen was at one time included in Walton-le-dale, which was granted by Henry de Lacy to Robert Banastre in the reign of Henry II. In the 4th of Edward II. (1810) it is mentioned along with Livesey and Toxholes, the three containing a carucate of land in fee of the castle of Clitheroe. In 38 Edward III. (1864) a moiety of the manor of Over Darwen was held by Thomas Molyneux, the other moiety being held by the Osbaldeston family. Subsequently the whole manor became the property of the Traffords, of whom it was purchased in 1810 by the present owners the Duckworths. Over Darwen was incorporated as a municipal borough in 1878, and a commission of the peace was granted in 1881.

OVERTURE. See MUSIC, vol. xvii. p. 95 sq.

OVERYSSEL, or OVERIJSEL, a province of Holland, bounded N.W. by the Zuyder Zee, N. by Friesland and



Drenthe, N.E. by Hanover (Prussia), S.E. by Westphalia (Prussia), and S. and S.W. by Guelderland, with an area of 1291 square miles. The southern district belongs to the basin of the Yssel; the northern is watered by the Vecht and various small streams falling into the Zwartewater, the river which was for so many generations the object of dispute between Zwolle and Hasselt. A large proportion of the surface is a sandy flat relieved by hillocks, rising at times to a height of 230 feet above the sea. Husbandry, stock-raising, and dairy-farming are the principal means of subsistence in the province, though the fisheries, turf-cutting, the shipping trade, and a number of manufacturing industries are also of importance. In the district of Twenthe (towards the east) more especially there are a great many cotton-mills and bleaching-works; brick and tile making is prosecuted in the neighbourhood of the Yssel; and along the coast a good many people are engaged in making mats and besoms. During the present century the province has been opened up by the construction of several large canals—the Dedemsvaart, the Noord-Willamsvaart (between the Yssel and the Zwartewater), the "Overysel canals" (running near the eastern frontier), &c.; and a fairly complete railway system has come into existence. The province is divided into the three administrative districts of Zwolle, Deventer, and Almelo. Its population, 234,376 in 1859 and 263,008 in 1875 (134,201 males, 128,807 females), was 247,136 in 1879. Of the total for 1875, 181,863 were Protestants, 76,891 Roman Catholics, and 4018 Jews. The chief town, Zwolle, had in 1879 a communal population of 22,759, and there were fourteen other communes with more than 2000 inhabitants, including Deventer, 19,162; Kampen, 17,444; Almelo, 7758; Hengelo, 6502.

Both the present name Overysel and the older designation Oversticht are explained by the fact that the province lies mainly on the other side of the Yssel from Utrecht, with which it long constituted an episcopal principality. Vollenhove was bestowed on the bishops in 943, Oldenzaal in 970, the land north-east of Vollenhove in 1042, Deventer in 1046, a part of Salland in 1226, the countship of Goor in 1248, the lordship of Dispenheim in 1831, and that of Almelo in 1406. In 1527 Bishop Henry of Bavaria advised the recognition of Charles V. as protector and ruler of the district, and Oversticht became Overysel. It was the sixth province to join the Union in 1679. During the French occupation it bore the name of the department of Bouches de l'Issel.

OVID (P. OVIDIUS NASO) was the last in order of time of the poets of the Augustan age, whose works have given to it the distinction of ranking among the great eras in the history of human culture. As is the case with most other Roman writers, his personal history has to be gathered almost entirely from his own writings. The materials for his life are partly the record of the immediate impressions of the time in which they were written contained in the *Amores*, partly the reminiscences of his happier days, to which his mind constantly recurred in the writings from his place of exile.

His life is almost coincident in extent with that of the Augustan age. The year of his birth, 43 B.C.—the year of the consulship of Hirtius and Pansa, which intervened between the death of Julius Cæsar and the partition of the Roman world among the Triumvirs,—may be regarded as the last year of the republic. It was the year of the death of Cicero, which marks the close of the republican literature. Thus the only form of political life known to Ovid was that of the ascendancy and absolute rule of Augustus and his successor. His character was neither strengthened nor sobered, like that of his older contemporaries, by personal recollection of the crisis through which the republic passed into the empire. There is no sense of political freedom in any of his writings. The spirit inherited from his ancestors was that of the Italian country districts and *sanscivita*, not that of Rome. He

was sprung from the Peligni, one of the four small mountain peoples whose proudest memories were of the part they had played in the Social War. They had no old race-hostility with Rome, such as that which made the most powerful representative of the Sabellian stock remain till the last her implacable enemy; and their opposition to the senatorial aristocracy in the Social War would predispose them to accept the empire. Ovid belonged by birth to the same social class as Tibullus and Propertius, that of old hereditary landowners; but he was more fortunate than they in the immunity which his native district enjoyed from the confiscations made by the triumvirs. His native town and district, Sulmo, lay high among the Apennines, and is described by Mr Hare as "grandly situated on an isolated platform, backed by snowy mountains." The poet himself describes this district as remarkable for the abundance of its streams and for its salubrity—

"Parva, sed irriguis ora salubris aquis;"

and he recalls the fresh charm of its scenery from the desolate waste of his Scythian exile. To his early life in such a district he may have owed his eye for natural beauty, and that interest in the common sights of the country which relieves the monotony of his life of pleasure in Rome and the dreary record of the life spent within the walls of Tomi, and enables him to add the charm of natural scenery to the romantic creations of his fancy. The pure air of this mountain home may have contributed to the vigorous vitality which prevented the life of pleasure from palling on him, and which beats strongly even through all the misery of his exile. But if this vitality—with its natural accompaniment, a keen capacity for enjoyment—was a gift due to his birthplace, it was apparently a gift transmitted to him by inheritance; for he tells us that his father lived till the age of ninety, and that he performed the funeral rites to his mother after his father's death. While he mentions both with the piety characteristic of the old Italian, he tells us little more about them than that "their thrift curtailed his youthful expenses,"<sup>1</sup> and that his father did what he could to dissuade him from poetry, and to force him into the more profitable career of the law courts. He had one brother, exactly a year older than himself, who, after showing promise as a speaker, died at the age of twenty. The tone in which Ovid speaks of him is indicative of sincere affection, but not of such depth of feeling as was called forth in Catullus by a similar loss. The two brothers had been brought early to Rome for their education, where they attended the lectures of the most eminent rhetoricians of their time. Education had become more purely rhetorical and literary, less philosophical and political, than it had been in a previous generation. Ovid is said to have attended these lectures eagerly, and to have shown in his exercises that his gift was poetical rather than oratorical, and that he had a distaste for the severer processes of thought. Like Pope, "he lisped in numbers," and he wrote and destroyed many verses before he published anything. The earliest edition of the *Amores*, which first appeared in five books, and the *Heroides* were given by him to the world at an early age. He courted the society of the older and younger poets of his time, and formed one among those friendly coteries who read or recited their works to one another before they gave them to the world. "He had only seen Virgil"; but Virgil's friend and contemporary Æmilius Macer used in his advanced years to read his didactic epic to him; and although there is no indication in the works of either the reigning or the rising poet of any intimacy between them even the fastidious Horace sometimes delighted his ear:

<sup>1</sup> *Æt. Ponticæ*, l. 8, 42.

with the music of his verse. He had a closer bond of intimacy with the younger poets of the older generation, Tibullus, whose death he laments in one of the few pathetic pieces among his earlier writings, and Propertius, to whom he describes himself as united in the close ties of comradeship. The name of Mæcenas occurs nowhere in his poems. The time of his paramount influence both on public affairs and on literature was past before Ovid entered on his poetical career, but Messala and Fabius Maximus, whose name is mentioned by Juvenal along with that of Mæcenas as the type of a munificent patron of letters in the Augustan age, encouraged his earliest efforts. With their sons he lived in intimacy in after years, and, as he speaks of having known the younger Fabius in his cradle, his friendship with his family must have begun early in his career. He enjoyed also the intimacy of poets and men of literary accomplishment belonging to a younger generation; and with one of them, Macer, he travelled for more than a year. It is not mentioned whether he travelled immediately after the completion of his education, or in the interval between the publication of his earlier poems and that of the *Mæs* and *Ars Amatoria*; but it is in his later works, the *Fest* and *Metamorphoses*, that we seem chiefly to recognize the impressions of the scenes he visited. In one of the epistles written from Pontus to his fellow-traveller there is a vivid record of the pleasant time they had passed together. Athens was to a Roman of that time what Rome is to an educated Englishman of the present day. Ovid speaks of having gone there under the influence of literary enthusiasm ("studiosus"); but the impression of his visit which remains on his writings is not of the wisdom taught "among the woods of Academe," but of the flowers that grow on the neighbouring Hymettus. A similar impulse induced him to visit the supposed site of Troy. The two friends saw together the splendid cities of Asia, which had inspired the enthusiasm of travel in Catullus, and had become familiar to Cicero and Horace during the years they passed abroad. They spent nearly a year in Sicily, which attracted him, as it had attracted Lucretius<sup>1</sup> and Virgil,<sup>2</sup> by its manifold charm of climate, of sea-shore and inland scenery, and of legendary and poetical association,—a charm which has found its most enduring expression in some of his most delightful tales. He recalls with a fresh sense of pleasure the incidents of their tour (which they made sometimes in a pinnace or yacht, sometimes in a light carriage), and the endless delight which they had in each other's conversation. We would gladly exchange the record of his life of pleasure in Rome for more of these recollections. The highest type of classic culture realized in ancient Rome—the type realized in such men as Cicero and Catullus, Virgil and Horace, Ovid and Germanicus—shows its affinity to a type which is the result of essentially similar studies in modern times by nothing more clearly than the enthusiasm for travel among lands famous for their natural beauty, their monuments of art, and their historical associations.

When settled at Rome, although a public career, leading to senatorial position, was open to him, and, although he filled various judicial offices, and claims to have filled them well, he had no ambition for such distinction, and looked upon pleasure and poetry as the occupations of his life. He tells us that he was married, when little more than a boy, to a wife for whom he did not care, who, he implies, was not worthy of him, and from whom he was soon

separated, and afterwards to a second wife, with whom his union, although through no fault of hers, did not last long. But he had other objects of his volatile affections, and one of them, Corinna, after the example of his predecessors Gallus, Propertius, and Tibullus, and their Alexandrian prototypes Callimachus, Philetas, &c., he makes the heroine of his love elegies. It is doubtful whether, like Lesbia, Delia, and Cynthia, she belonged to the class of Roman ladies of recognized position, or to that to which the Chloes and Lalages of Horace's artistic fancy evidently belong. If trust can be placed in the later apologies for his life, in which he states that he had never given occasion for any serious scandal, it is probable that she belonged to the class of "libertinae." Ovid is not only a less constant but he is a much less serious lover than Catullus, Tibullus, or Propertius. His tone is that either of mere sensual self-regarding feeling or of persiflage. That tone is in many ways offensive to modern taste, but in nothing is it more characteristic of his age than in his light-hearted justification of his choice both of a theme and of a career. In his complete emancipation from all sense of restraint or wish for better things, Ovid goes beyond all his predecessors, although Tibullus and Propertius, and even Horace in the ironical disclaimers of his earlier *Odes*, give indication of the same state of feeling. In this Ovid reflects the tastes and tone of fashionable, well-born, and wealthy Roman society between the years 20 B.C. and the beginning of our era. The memory of the civil wars no longer weighed on the world. The career of ambition was so far from attracting men that they had to be urged and coerced into filling official places and carrying on the routine duties of the senate. Society was bent simply on amusement. There was less of coarseness in the pursuit of pleasure than had prevailed among the contemporaries of Catullus. We find little trace in Ovid of the convivial pleasures which Horace celebrates in his lighter odes, or of the excesses of which Propertius makes confession. Ovid says of himself that he drank scarcely anything but water, and from what he tells us of his appearance and constitution he was evidently not of the temperament to which convivial excesses bring any temptation.<sup>3</sup> But probably it was not the fashion of the time to live intemperately. As a result of the loss of political interests, women came to play a more important and brilliant part in society, and the tone of fashionable conversation and literature was adapted to them. Julia, daughter of the emperor, was by her position, her brilliant gifts, and her reckless laxity of character the natural leader of such a society. The awakening of the Roman world out of this fool's paradise of pleasure was due to the discovery of her intrigue with Julius Antonius, son of Mark Antony, and to the open and violent display of anger with which Augustus resented what was at once a shock to his affections and a blow to his policy. Nearly coincidently with the publicity given to this scandal appeared the famous *Ars Amatoria* of Ovid, perhaps the most immoral and demoralizing work ever written, at least in ancient times, by a man of genius. Ovid was the favourite poet of the fashionable world; he lived on terms of intimacy with its leading members, the younger representatives of the old nobility, who had survived the proscriptions and the fatal day of Philippi. His poetical accomplishment would naturally recommend him to Iulus Antonius, of whose gifts Horace has spoken so eulogistically. His marriage with his third wife, a lady of the great Fabian house, and a friend of the empress Livia, had probably taken place before this time. It thus seems likely that he may have been admitted into the intimacy of the

<sup>1</sup> Cf. Lucret., l. 726—

"Quæ cum magna modis multis miranda videtur

Gentibus humanis regio visendaque fertur."

<sup>2</sup> "Quæcumque secum Campanie Siciliæque plurimum uteretur."

—Dion.

<sup>3</sup> Compare *Am.*, ll. 23—

"Grædies, non sunt sine virtus artus;  
Pondere, non nervis, corpora nostra carent."



younger society of the Palatine, although in the midst of his most fulsome flattery he does not claim ever to have enjoyed the favour of Augustus. Whether he was in any way mixed up with this intrigue is not known. But that the work which appeared coincidentally with it excited deep resentment in the mind of the emperor, as the pander to the passions by which the dignity of his family had been outraged and his state policy thwarted, is shown by his edict, issued ten years later, against the book and its author. Augustus had the art of dissembling his anger; and Ovid appears to have had no idea of the storm that was gathering over him. He still continued to enjoy the society of the court and of the fashionable world; he passed before the emperor in the annual procession among the ranks of the equites; he filled a more important judicial place; and he had developed a richer vein of genius than he had shown in his youthful prime. But he was aware that public opinion had been shocked, or professed to be shocked, by his last work; and after writing a kind of apology for it, called the *Remedia Amoris*, he directed his genius into other channels, and wrote during the next ten years the *Metamorphoses* and the *Fasts*. He had already written one work, the *Heroides*, in which he had imparted a modern and romantic interest to the heroines of the old mythology,<sup>1</sup> and a tragedy, the *Medea*, which must have afforded greater scope for the dramatic and psychological treatment of the passion with which he was most familiar. In the *Fasts* Ovid assumes the position of a national poet<sup>2</sup> by imparting poetical life and interest to the ceremonial observances of Roman religion; but it is as the brilliant narrator of the romantic tales that have got so strangely blended with the realistic annals of Rome that he succeeds in the part assumed by him. The *Metamorphoses* professed to trace the relations of the gods with human affairs from the reign of Chaos to the deification of Augustus; and in the later books that work also may claim something of a national character. But it consists for the most part of a series of tales of the love adventures of the gods with nymphs and heroines, told in a tone of mixed irony and romance. This work, which he regards as his most serious claim to immortality, had not been finally revised at the time of his disgrace, and he committed it to the flames; but other copies were in existence, and the book was given to the world in his absence. He often regrets that it had not obtained his final revision. The *Fasts* also was broken off by his exile, after the completion and publication of the first six books, treating of the first six months of the year.

The actual offence which gave occasion for his banishment is not exactly known. In his frequent references to it he wavers between assertions of his innocence of anything beyond simplicity and error and the admission that, though he had done nothing, he yet deserved his punishment. He had witnessed something which was a cause of pain and offence to the emperor. In a letter to one of his intimate friends, to whom he had been in the habit of confiding all his secrets, he says that had he confided this one he would have escaped condemnation. In writing to another friend in reference to his disgrace, he warns him against the danger of courting too high society—"prælustria vita." The cause which excited or renewed the anger of Augustus was connected with the old offence of writing and publishing the *Ars Amatoria*. All this points to his having been in some way mixed up with some scandal affecting the imperial family. He distinctly disclaims the idea that he had anything to do with any treasonable plot; and he

certainly appears to have been the last man who ever could have been made the confederate of a serious conspiracy. All this seems to connect him with one event, coincident in time with his disgrace,—the intrigue of the younger Julia, granddaughter of the emperor, with Silanus,—mentioned by Tacitus in the third book of the *Annals*. Tacitus tells us how deeply Augustus felt these family scandals, looking upon them as acts of treason and sacrilege. It seems, at first sight, strange that the chief punishment fell, not on the real offenders, but on Ovid, who at the worst could only have been the confidant of their intrigue, perhaps may have lent his house as a place of rendezvous for the lovers. To Julia herself was assigned the lighter penalty of seclusion in one of the towns of Italy, and Silanus had no other punishment than that of exclusion from the court. Augustus must have regarded Ovid and his works as, if not the corrupter of the age, yet the most typical representative of that corruption which in its effects on his own family might be regarded as the nemesis attending on, as it was the direct consequence of, the outward success of his policy. The date of this scandal must have been 7 or early in 8 A.D., as Tacitus, under the date 28 A.D., mentions the death of Julia after twenty years of seclusion.

A delay of nearly two years seems to have taken place between the disgrace and the sentence passed on Ovid, and it must have been during this interval that he visited his friend Fabius at Elba,<sup>3</sup> probably with the view of inducing him to intercede for him. At last the edict, dictated by relentless policy rather than personal vindictiveness, was published. He was left in the enjoyment of the rights of citizenship and in the possession of his property (perhaps through the exercise of the influence of Livia in favour of his wife), but was ordered to leave Rome on a particular day, and to settle at the very outskirts of civilization,—in the semi-Greek semi-barbaric town of Tomi, near the mouth of the Danube. He tells vividly the story of the agony of his last night at Rome, of the dangers and hardships of his winter voyage down the Adriatic, and of his desolate feelings on his first arrival at his new abode. But this was merely the beginning of his miseries. For eight years he bore up in his solitude, in the dreariest circumstances, suffering from the unhealthiness of the climate and exposed to constant alarm from the incursions of the neighbouring barbarians. He continued to be buoyed up by hopes first of a remission of his sentence, afterwards of at least a change to another place of exile. He wrote his complaints first in a series of books sent successively to Rome, afterwards in a number of poetical epistles, also collected into books, addressed to all his friends who were likely to have influence at court. He believed that Augustus had softened towards him before his death, but his successor was inexorable to his complaints. Perhaps the person who most deeply resented the offence was the one who exercised the greatest influence over both, the empress Livia, whose life and example were a protest against the laxity of the age, and who was an unsympathetic stepmother to the members of the imperial family. His chief consolation was the exercise of his art, and the only expression of a worthy feeling of resistance to his misery is in a letter to his daughter Perilla, in which he asserts that over his genius Augustus had no control:—

"Ingenio tamen ipse meo comitorque fruorque:  
Cesar in hoc potuit juris habere nihil."

—*Tristia*, iii. 7, 47.

Yet as time goes on he is painfully conscious of failure in power, and of the absence of all motive to perfect his work. He had access to no books except such as he may have brought with him, and the zest for reading, as for all

<sup>1</sup> The essentially modern character of the work appears in his making a heroine of the time of the Trojan war speak of visiting "learned" Athens (*Heroid.*, ii. 83).

<sup>2</sup> "Animos ad publica carmina flexi" (*Trist.*, v. 23).

<sup>3</sup> *Ex Ponto*, ii. 3, 83.

other pleasure, was gone. He recalls the memories of the happy days he had spent at Rome; and the chief relief to the misery of his exile was the receipt of letters from his friends. M. Gaston Boissier says that he left his genius behind him at Rome; and it is true that the works written in exile have not the brilliant versatility, the buoyant spirit, or the finished art of his earlier writings. They harp eternally on the same theme. All his faults of diffuseness and self-repetition appear in an exaggerated form. But there is the same power of vivid realization and expression, the same power of making his thought, feeling, and situation immediately present to the reader. What they lose in art they gain in personal interest. They have, like the letters of Cicero to Atticus, the fascination exercised by those works which have been given to the world under the title of *Confessions*; and they are the sincerest expression in literature of the state of mind produced by a unique experience,—that of a man, when well advanced in years, but still retaining extraordinary sensibility to pleasure and pain, withdrawn from a most brilliant position in the centre of social and intellectual life and material civilization, and cast upon his own resources in a place and among people affording the dreariest contrast to all that had gruffed his eye, heart, and mind through the whole of his previous life. How far these letters and confidences are to be regarded as equally sincere expressions of his affection or admiration for his correspondents is another question, which need not be pressed. Even in those addressed to his wife, in which he might be supposed to pour out his heart naturally, there may perhaps be detected a certain ring of insincerity. He pays her compliments, addresses her in the studied language of gallantry, and compares her to Penelope and Laodamia and the other famous heroines of ancient legend. Had she been a Penelope or a Laodamia she would have accompanied him in his exile, as we learn from Tacitus was done by other wives<sup>1</sup> in the more evil days of which he wrote the record. There is a note of truer affection in the one letter to his daughter Perilla, of whose genius and beauty he was proud, and who in her tastes and character was more in sympathy with him. This is one of several points of resemblance in the position, feelings, and fortunes of Ovid with one whose career and character were so essentially different—Cicero. He shows a regard for many of his friends, and dependence on their sympathy and appreciation, and he recalls with some bitterness the coldness with which some of those in whom he had trusted treated him when his disgrace first overtook him. He was moved by the persistent hostility of one whom he had regarded as a friend to an act of retaliation for which neither his temper nor his genius was adapted,—the composition of a lampoon, the *Ibis*, in imitation of a poem of Callimachus, called by the same name. His affections, like his genius, were diffused widely rather than strongly concentrated, and he seems to have had rather a large circle of intimate acquaintances than any close friends to whom he was attached as Cicero was to Atticus, Horace to Mæcenas, Catullus to Calvus and Veranius. He was evidently a man of gentle and genial manners; and, as his active mind induced him to learn the language of the new people among whom he was thrown, his active interest in life enabled him to gain their regard and various marks of honour. One of the last acts of his literary career was to revise the *Fasts* and re-edit it with a dedication to Germanicus. The last lines of the *Ex Ponto* sound like the despairing sigh of a drowning man who had long struggled alone with the waves:—

"Omnis perdidimus, tantum modo vita relicta est  
Præbeat ut sensum materiamque malis."

Shortly after these words were written the poet died, at the

<sup>1</sup> "Comitate profugos liberos matres, secute maritos in exilia conjuges" (Tac., *Hist.*, l. 3).

age of sixty-one, in the year 17 A.D., the third year of the reign of Tiberius.

The natural temperament of Ovid, as indicated in his writings, has more in common with the suppleness and fineness of the modern Italian than with the strength and direct force of the ancient Roman. That stamp of her own character and understanding which Rome impressed on the genius of those other races, Italian, Celtic, or Iberian, which she incorporated with herself, is fainter in Ovid than in any other great writer. He ostentatiously disclaims the manliness which in the republican times was regarded as the birthright not of Romans only but of the Sabellian races from which he sprung. He is as devoid of dignity in his abandonment to pleasure as in the weakness with which he meets calamity. He has no depth of serious conviction, no vein of sober reflexion, and is sustained by no great or elevating purpose. Although the beings of a supernatural world fill a large place in his writings, they appear stripped of all sanctity and mystery. It is difficult to say whether the tone in which the adventures of the gods and goddesses of mythology are told, or his prayer offered to the gods of heaven and of the sea, when in danger of shipwreck,

"Pro superi viridesque dei, quibus æquom cura,"

implies a kind of half-believing return to the most childish elements of paganism, or is simply one of mocking unbelief. He has absolutely no reverence, and consequently almost alone among the greater poets of Greece or Rome (the "sancti" of Lucretius, the "pii vates" of Virgil) he inspires no reverence in his reader. With all a poet's feeling for the life, variety, and subtlety of nature, he has no sense of her mystery and majesty. Though he can give dramatic expression to pathetic emotion, the profound melancholy of Lucretius, the spiritual sadness, half-relieved by dim spiritual hopes, of Virgil, the thoughtful renunciation with which Horace fronts "the cloud of mortal destiny," are states of mind which were seemingly inconceivable by him. Nor is he more capable of sounding the deeper sources of joy than of sorrow. The love which he celebrates is sensual and superficial—a matter of vanity as much as of passion. He prefers the piquant attraction of falsehood and fickleness to the charm of truth and constancy. Even where he follows Roman tendencies in his art he perverts them. Didactic poetry has set before itself many false ends in ancient Roman as in modern English literature; but the pedantry of systematic teaching has never been so strangely misapplied, as it never has been so strangely combined with brilliant power of execution, as in the methodical teaching of the art—"corrumpere et corrumpi." The *Fasts* is a work conceived in the prosaic spirit of Roman antiquarianism. But this conception might have been made poetical had it been penetrated by the religious and patriotic spirit in which Virgil treats the origin of ancient ceremonies, or the serious, half-mystic spirit in which he accepts the revelations of science. The contrast between the actual trivialities of ancient science and ancient ceremonial, on the one hand, and the new meaning which both were capable of receiving from a reverential treatment, could not be more effectually enforced than by a comparison of passages in the *Georgics* and *Æneid* treating the astronomical fancies and religious ceremonies of early ages with the literal definiteness or the light persiflage of the *Fasts*.

These grave defects in strength and gravity of character had an important effect on the artistic result of Ovid's writings. Though he wanted neither diligence, perseverance, nor literary ambition, he seems incapable of conceiving a great and serious whole. Though his mind works very actively in the way of observing and reflecting on

the superficial aspects of life, yet he has added no great thoughts or maxims to the moral or intellectual heritage of the world. With a more versatile dramatic faculty than any of his countrymen, he has created no great character, comparable either with the grand impersonations of Greek tragedy, or with the Dido and Turnus of Virgil. He has both the psychological power of reading and the rhetorical power of expressing passion and emotion of different kinds; but he has not a genuine and consistent sense of human greatness or heroism. He represents with impartial sympathy the noble heart of Laodamia and the unhallowed lust of Myrrha. His spirit seems thoroughly ironical or indifferent in regard to the higher ideals or graver convictions of men.

But with all the laxity and levity of his character he must have had qualities which made him, if not much esteemed, yet much liked in his own day, and which have perpetuated themselves in the genial amiability of his writings. He claims for himself two social virtues, highly prized by the Romans, "fides" and "candor,"—the qualities of social honour and kindly sincerity, the qualities which made a man a pleasant member of society and a friend who might be relied on in the ordinary relations of life. There is no indication of anything base, anything ungenerous, or anything morose in his relations to others. The literary quality of "candor," the generous appreciation of all sorts of excellence, he possesses in a remarkable degree. He heartily admires everything in the literature of the past, Greek or Roman, that had any merit. In him more than in any of the other Augustan poets we find words of admiration more than once applied to the rude genius of Ennius and the high spirit of Accius. It is by him, not by Virgil or Horace, that Lucretius is first named and the sublimity of his genius is first acknowledged. The image of Catullus that most haunts the imagination is that of the poet who died so early—

..... "hedera juvenalis cinctus  
Tempora."

as he is represented by Ovid coming to meet the shade of the young Tibullus in Elysium. To his own contemporaries, known and unknown to fame, he is as liberal in his words of recognition. He enjoyed society too in a thoroughly amiable and unenvious spirit. He lived on a friendly footing with a large circle of men of letters, poets, critics, grammarians, &c., but he showed none of that sense of superiority which is manifest in Horace's estimate of the "tribes of grammarians" and the poetasters of his day. Like Horace, too, he courted the society of the great, and probably he did not maintain an equally independent attitude towards it; but unlike Horace he expresses no contempt for the profane world outside. With his gifts of irony and knowledge of the world one might have expected him to be the social satirist of the later phase of the Augustan age. But he wanted the censorious and critical temper necessary for a social, and the admixture of gall in his disposition necessary for a successful personal satirist.

"Candidus a salibus suffusus felle refugit"

is a claim on our regard which he is fully justified in making. In his exile, and in imitation of his model Callimachus, he did retaliate on one enemy and persistent detractor; but the *Ibis* is a satire more remarkable for irrelevant learning than for epigrammatic sting.

But his chief personal endowment was his vivacity, and his keen interest in and enjoyment of life. He had no grain of discontent in his composition. He had no regrets for an ideal past nor longings for an imaginary future. The age in which his lot was cast was, as he tells us, that in which more than any other he would have wished to live.<sup>1</sup>

He is its most gifted representative, but he does not rise above it. The great object of his art was to amuse and delight it by the vivid picture he presented of its actual fashions and pleasures, and by creating a literature of romance which reflected these fashions and pleasures, and which could stimulate the curiosity and fascinate the fancy of a society too idle and luxurious for serious intellectual effort. The sympathy which he felt with the love adventures and intrigues of his contemporaries, to which he probably owed his fall, quickened his creative power to the composition of the *Heroides* and the romantic tales of the *Metamorphoses*. Catullus, by his force of concentration, makes the actual life of his age more immediately present; but none of the Roman poets can people a purely imaginary world with such spontaneous fertility of fancy as Ovid. In heart and mind he is inferior to Lucretius and Catullus, to Virgil and Horace, perhaps to Tibullus and Propertius; but in the power and range of imaginative vision he is surpassed by no ancient and by few modern poets. This power of vision is the counterpart of his lively sensuous nature. He has a keener eye for the apprehension of outward beauty, for the life and colour and forms of nature, than any Roman or perhaps than any Greek poet. This power, acting upon the wealth of his varied reading, gathered with eager curiosity and received into a singularly retentive mind, has enabled him to body forth scenes of the most varied and picturesque beauty in all the lands of Europe and Asia famous in ancient song and story. If his tragedy the *Medea*, highly praised by ancient critics, had been preserved, we should have been able to judge whether Roman art was capable of producing a great drama. In many of the *Heroides*, and in several speeches attributed to his imaginary personages, he gives evidence of true dramatic creativeness. Catullus, in his *Ariadne* and his *Attis*, has given a voice to deeper and more powerful feeling, and he presents an idyllic picture of the heroic age with a purer charm. But the range and variety of his art were limited by the shortness as well as the turmoil of his life. Catullus is unsurpassed as the author of an epic idyll. Ovid is not idyllic in his art, or whatever there is of idyll in it is lost in the rapid movement of his narrative. But he is one, among the poets of all times, who can imagine a story with most vivid inventiveness and tell it with most unflagging animation. An ideal world, poetical and supernatural, but never fantastic or grotesque, of beings rich with the beauty and fulness of youth, playing their part in scenes of picturesque beauty, is brought before us in verse and diction of apparently inexhaustible resource and unimpeded flow, partly created or rising up spontaneously for the occasion, partly borrowed boldly and freely from all his predecessors in Latin poetry, but always full of genuine life and movement. The faults of his verse and diction are those which arise from the vitality of his temperament,—too facile a flow, too great exuberance of illustration. He has as little sense of the need of severe restraint in his art as in his life. He is not without mannerism, but he is quite unaffected, and, however far short he might fall of the highest excellence of verse or style, it was not possible for him to be rough or harsh, dull or obscure.

As regards the school of art to which he belongs, he may be described as the most brilliant representative of Roman Alexandrinism. The latter half of the Augustan age was, in its social and intellectual aspects, more like the Alexandrian age than any other era of antiquity. The Alexandrian age was like the Augustan, one of refinement and luxury, of outward magnificence and literary dilettanteism flourishing under the fostering influence of an absolute monarchy. Poetry was the only important branch of literature cultivated, and the chief subjects of

<sup>1</sup> *Are Amatoris*, iii. 121, &c.

poetry were mythological tales, various phases of the passion of love, the popular aspects of science, and some aspects of the beauty of nature. These, too, were the chief subjects of the later Augustan poetry. The higher feelings and ideas which found expression in the poetry of Virgil, Horace, Varius, and the writers of an older generation no longer acted on the Roman world. It was to the private tastes and pleasures of individuals and society that Roman Alexandrinism had appealed, both in the poetry of Catullus, Cinna, Calvus, &c., and in that of Gallus, Tibullus, and Propertius. Ovid was the last of this school of writers; he profited at the very entrance on his poetical career by the artistic accomplishment in form, metre, and diction which had been gained by the slow labours of his predecessors; his fancy was much more active and brilliant than that of any of them; and his spirit was more unreservedly satisfied with the conditions imposed both by the art to which he devoted himself and the political and social circumstances by which he was surrounded. Like all his countrymen, he wanted power to create a new form of art and a new vehicle of expression. But if he could have foreseen his future fame his literary ambition would have been completely satisfied by the consciousness that he had not only immeasurably surpassed, but had, for all after time, practically superseded his Greek models. He has confined himself to two vehicles of expression—the elegiac metre and the hexameter. In the first the great mass of his poetry is written,—the *Herodes*, the *Amores*, the *Ars Amatoria*, the *Remedia Amoris*, the *Fasts*, the *Tristia*, the *Ex Ponto*, the *Ibis*, the *Medeamina Faciei*; in the hexameter we have the work which he regarded as that on which his hope of immortality was based, the *Metamorphoses*, and a fragment of a didactic poem written in the style of the Alexandrians, probably with the mere desire to kill time in the place of his exile, called the *Halieutica*. Of the first metre he is the acknowledged master. He brought it to its highest perfection, and all the immense mass of elegiac verse published and written in modern times has merely endeavoured to reproduce the echo of his rhythm and manner. In the direct expression and illustration of feeling his elegiac metre has much more ease, vivacity, and sparkle than that of any of his predecessors, while he alone has communicated to it, without altering its essential characteristic of recurrent and regular pauses, a fluidity and rapidity of movement which makes it an admirable vehicle for tales of pathetic and picturesque interest. It was impossible for him to give to the hexameter a greater perfection than it had already attained, but he imparted to it also a new character, wanting indeed the weight, and majesty, and intricate harmonies of Virgil, but rapid, varied, animated, and in complete accord with the swift, versatile, and fervid movement of his imagination. One other proof he gave of his irrepressible energy and vitality by composing, during his exile, a poem in the Gothic language, in praise of Augustus,—the loss of which, whatever it may have been to literature, is one much to be regretted in the interests of philological science.

Ovid would, in any previous century since the revival of classical studies, have been regarded as a more important representative of ancient life and feeling, and as a greater poet, than he is in the present day. During the earlier period of this revival, the beauty and refinement of ancient literature, and of the life to which that literature is the key, were better appreciated than their moral and intellectual greatness. As the representative writer of an age of great material civilization and luxury, he gained the attention of a time and a class struggling towards a similar civilization and animated by the same love of pleasure. It was in his writings that the world of romance and wonder, created by the early Greek imagination, was first revealed to the modern world. The vivid, sensuous fancy through which he reproduced the tales and beings of mythology, as well as the transparent lucidity, the unflinching frankness, the ease and directness of the medium through which

this is done, made his works the most accessible and among the most attractive of the recovered treasures of antiquity. His influence was first felt in the literature of the Italian Renaissance. But in the most creative periods of English literature he seems to have been more read than any other ancient poet, not even excepting Virgil; and it was on the most creative minds, such as those of Marlowe, Spenser, Shakespeare, Milton, and Dryden, that he acted most powerfully. The continuance of his influence is equally unmistakable during the classical era of Addison and Pope. The most successful Latin poetry of modern times has been written in imitation of him; and the accomplishment by which the faculty of literary composition and the feeling for ancient Roman culture were most developed in the great schools of England and France was the writing of Ovidian elegiacs. His works gave also a powerful stimulus and supplied abundant materials to the great painters who flourished during and immediately subsequent to the Renaissance. The mythological figures and landscapes which crowd the great galleries of Europe reproduce on canvas the forms, life, colour, and spirit which first were clothed in words and metre in his *Elegies* and *Metamorphoses*.

But, whatever charm individual readers of ancient literature may still find in him, no one would claim for him anything like the same influence on literature, art, and education in the present day as he formerly enjoyed. Judged by the attention given to their works by professional scholars and also in current criticism, not only Virgil and Horace, but Lucretius and Catullus, appear to be more in esteem than Ovid. This may perhaps be due as much to a loss in imagination as to a gain in critical power. Although the spirit of antiquity is better understood now than it was in the 16th and 17th centuries, yet in the capacity of appreciating works of brilliant fancy we can claim no superiority over the centuries which produced Spenser, Shakespeare, and Milton, nor over those which produced the great Italian, French, and Flemish painters. Still, whatever be the cause of the change in taste, Ovid is not one of those poets who seem to have much to teach us, or much power to move and interest us now. Perhaps the very liveliness and clearness of his style and manner, which made him the most accessible of ancient authors in times of less exact learning, have tended to deaden curiosity about him in the present day. There is no deep or recondite meaning to be extracted from him. The sensuous and more superficial aspects of the later phase of ancient civilization, of which he is the most brilliant exponent, have much less interest for us than the heroic aspects of his earlier phase, and the spiritual, ethical, and political significance of its maturity. The art which chiefly ministers to pleasure, though it had its place in the great ages of antiquity, had then only a subordinate one; and it is to that place that it has been relegated by the permanent judgment of the world. It is of that art that Ovid is the chief master, and it is that with which he is identified. There might almost seem to be some danger of his falling into the neglect which has deservedly overtaken the authors of the epics of the Flavian era. It is therefore perhaps worth while to indicate some of the grounds on which his works must continue to hold an important place in any comprehensive study of Roman literature or human culture.

His first claim on the attention of modern readers is that already indicated—the influence which he exercised on the earlier development of modern art and literature. Just as certain Greek poets and literary periods (the Alexandrians for instance) claim attention as much on account of their influence on the development of Roman literature as on their own account, so, if for no other reason, the works of Ovid must always retain an importance, second only to those of Virgil and Horace, as one of the chief media through which the stream of ancient feeling and fancy mingled with the great river of modern literature.

He is interesting further as the sole contemporary exponent of the last half of the Augustan age. The whole of that age is a time of which the outward show and the inner spirit are known from the works, not of contemporary historians or prose-writers, but of its poets. The successive phases of feeling and experience through which the world passed during the whole of this critical period of human affairs are revealed in the poetry of Virgil, Horace, and Ovid. Virgil throws an idealizing and religious halo around the hopes and aspirations of the first rise of the empire. His aim seems to be to bring the new régime into living connexion with the past, not of Rome only but of the civilized world. Horace presents the most complete image of his age in its most various aspects, realistic and ideal. Ovid, in all his earlier writings, reflects the life of the world of wealth and fashion under the influence of the new court. It is a life of material prosperity, splendour, refinement, of frivolity and intrigue, of dilettantism in literature, of decay in all the nobler energies, of servility and adulation. He is the most characteristic painter such a time could have found. For the continuous study

<sup>2</sup> The influence of Ovid on Shakespeare is shown conclusively in the interesting papers on "What Shakespeare learned at School," contributed to *Fraser's Magazine* (1879, 1880) by Prof. Baynes.

of the Roman world in its moral and social relations, his place is important as marking a stage of transition between the representation of Horace, in which the life of pleasure and amusement has its place, but one subordinate to the life of reflection and of serious affairs, and the life which reveals itself in the cynicism of Martial and the morose disgust of Juvenal.

From the times of Ennius and Lucilius, Roman poetry occupied itself much with the lives, pursuits, and personal feelings of its authors, and this is one element of interest which it has in common with such works as the *Letters* of Cicero and of Pliny. Few poets of any age or country bring themselves into such close relation with their readers as Catullus, Horace, Ovid, and Martial. Ovid is in mind and character perhaps the least interesting of the four. But an exceptional interest attaches to his history. He attracts curiosity by having a secret, which, though it may be guessed with an approach to certainty, is not fully revealed. He excites also personal sympathy by the contrast presented in his writings between the unclouded gaiety of his youth and prime and the long heart-break of his exile. If we know him only from the personal impression which he makes in the *Amores* and the *Art Amatoria*, it would be allowed that few men of equal genius had so little claim on the esteem of the world. In the ten books of complaint which he pours out from his place of exile, though he shows no sign of a manlier temper than when he wrote his "imballes elegi," yet by the vividness with which he realizes the contrast between his past and present, by his keen capacity for pleasure and pain, by the unreserve with which he exposes all his feelings, he forces himself on our intimacy, and awakens those sympathies which all sincere and passionate confessions create, where there is nothing base or malignant in the temper of their author to alienate them. Though his fate does not rouse the powerful interest inspired by the "fiery courage" and "Titanic might" with which Byron struggled during his self-imposed exile, yet to it, too, apply the sympathetic words of Virgil—"Mentem mortalia tangunt."

But it was not owing to the historical and personal interest of his works that he gained his great name among his countrymen and the readers of a former generation, nor is it on that ground solely that he claims attention now. He is the last true poet of the great age of Roman literature,—which begins with Lucretius and closes with him,—of the age which drew the most powerful stimulus from the genius and art of Greece, from the sentiment inspired by Rome, and from the Italian love of nature. Among the five or six great poets of that time Ovid is distinguished both as a brilliant artist who brought one branch of poetry to the highest perfection and also as a poet in whom one rich vein of the genius of Italy most conspicuously manifested itself. It is mainly through his reproduction of the forms, metres, and materials of the chief Alexandrian poets that these have maintained an enduring place in literature. But, great as he was in art and imitative faculty, his spontaneous gifts of genius were still more remarkable. If his works had perished we should have had a most inadequate idea of what the farvid Italian genius could accomplish in ancient times. No other Roman poet can invent and tell a story and make an outward scene and dramatic situation present to the eye and mind with such vivid power. If he does not greatly move the deeper sources of emotion, he has the power of lightly stirring many of them. No Roman poet writes with such ease, life, and rapidity of movement. None is endowed with such fertility of fancy, such quickness of apprehension. In respect of his vivacity and fertility we recognise in him the countryman of Cicero and Livy. But the type of genius of which he affords the best example is more familiar in modern Italian than in ancient Roman literature. While the serious spirit of Lucretius and Virgil reappeared in Dante, the qualities attributed by his latest and most accomplished critic to Ariosto may be said to reproduce the light-hearted gaiety and the brilliant fancy of Ovid.

There were several editions of Ovid's collected works in the 16th and 17th centuries, the time in which he enjoyed his greatest popularity. Recent editions of the text have been published by E. Marini and A. Eusebi. The most important aids to the study of Ovid recently made in England are the editions of the *Ides* by Mr Robinson Ellis, and those of the *Heroides* by Mr A. Palmer. Much light is thrown on the diction of Ovid by Zingerle in his *Ovidius und sein Verhältniss zu den Vergilischen*. The most interesting discussion on the cause of his exile is that of M. Gaston Boissier, which originally appeared in the *Revue des Deux Mondes*, and now forms part of his volume entitled *L'Opposition sous les Césars*. (W. Y. A.)

OVIEDO, a city in the north of Spain, capital of a province of the same name,<sup>1</sup> stands on a gentle northern slope, about 72 miles by rail and diligence to the north

of Leon, and 14 miles to the south of the Bay of Biscay. About a mile to the north-west is the Sierra de Naranco, a Red Sandstone hill 1070 feet above the sea and about 470 above the town, which is thus sheltered from the north wind, but subject in consequence to a large rainfall. Most of the town was burnt in 1531, and the reconstruction, till recently, has been irregular. The four main streets are formed by the roads connecting Gijon and Leon (north and south) and Grado and Santander (east and west), which cross each other in a central square, the Plaza Mayor. The streets are clean and well lighted; the projecting roofs of the houses give a characteristic effect, and some portions of the old Calle de la Platería are highly picturesque. In the Plaza Mayor are the handsome Casas Consistoriales, dating from the 17th century; one or two deserted mansions of the nobility are architecturally interesting. The university, founded by Philip III in 1604, is lodged in a plain building, 180 feet square; connected with it are a small library and physical and chemical museums. The cathedral, an elegant Perpendicular building of the 14th century, occupies the site of an earlier edifice, founded in the 8th century, of which only the Camara Santa remains. The west front has a fine portico of ornamented arches between the two towers. Of these one, very richly adorned, has been completed, and is 284 feet high; the other, which is larger, does not as yet rise above the nave. The interior has some fine stained glass, but has been much disfigured with modern rococo additions. The Capilla del Rey Santo (Alfonso II., who died in Oviedo in 843) contains the remains of many successive princes of the house of Pelayo; and the Camara Santa (dating from 802) preserves in an arca the crucifix, sudarium, and other relics saved by Don Pelayo in his fight. The cathedral library has some curious old MSS., mostly from Toledo. On the Sierra de Naranco is the ancient Santa Maria de Naranco, originally built by Ramiro in 850 as a palace, and afterwards turned into a church. Higher up the hill is San Miguel de Lino, also of the 9th century; and on the road to Gijon, about a mile outside the town, is the Santullano or church of St Julian, also of very early date. The modern town has the usual equipments in the way of hospitals, schools, theatre, casino, and the like; and in the neighbourhood are some pleasant paseos or promenades (San Francisco, Bombé, Jardin Botanico). The industries of the town include hat-making and tanning, and there is also a manufactory of arms. The population of the ayuntamiento in 1877 was 34,460.

Oviedo, founded in the reign of Fruela (762), became the fixed residence of the kings of the Asturias in the time of Alfonso the Chaste, and continued to be so until about 924, when the advancing moonquest led them to remove their capital to Leon. From that date the history of the city was comparatively uneventful. It was twice plundered during the war of independence—by Ney in 1809 and by Bonnet in the following year.

OVIEDO Y VALDÉZ, GONZALO FERNÁNDEZ DE (1478–1557), an early historian of Spanish America, was born at Madrid, of noble Asturian descent, in 1478. He was brought up at the court of Ferdinand and Isabella as one of the pages of Prince John; in this capacity he was present at the surrender of Granada in 1492, and saw Columbus at Barcelona on his first return from America in 1493. In 1514 he was sent out to San Domingo as supervisor of the gold-smeltings. He only occasionally afterwards visited his native country and the American mainland. Among other offices subsequently added to his original appointment was that of historiographer of the Indies, in the discharge of which he produced, besides some unimportant chronicles, two large works of abiding interest and value—*La general y natural Historia de las Indias* and *Quincuagenas de los Notables de España*. He died at Valladolid in 1557.

<sup>1</sup> The province of Oviedo, corresponding to the ancient province and principality of ASTURIAS (q. v.), has an area of 4091 square miles and a population (1877) of 576,352. At that census the ayuntamientos (besides the capital) having a population exceeding 10,000 were—Cangas de Tineo, 22,212; Cudillero, 10,118; Gijon, 80,591; Grado, 20,255; Langreo, 12,832; Lena, 11,657; Llanes, 18,637; Mieres, 12,614; Piloña, 18,648; Salas, 16,394; Siero, 21,494; Tineo, 21,414; Valdés, 22,014; and Villaviecosa, 20,179.

The *History of the Indies* first appeared at Madrid in the form of a *Sumario* in 1526. Of the full work, consisting of fifty books, the first twenty-one were published at Seville in 1585 (Eng. transl. by Eden, 1855; Fr. transl. by Foleur, 1856). The whole has recently been published for the first time by the Madrid Royal Academy of History (4 vols. fol., 1851-55). It contains a large mass of valuable information, but written in a loose rambling moralizing style which makes it somewhat difficult to use. According to Las Casas, it is "as full of lies almost as pages," but the judgment of the humane ecclesiastic was, necessarily perhaps, somewhat prejudiced. The *Quincuagenas*, devoted to reminiscences of the principal characters who had figured in Spain during his lifetime, consists of a series of imaginary conversations full of gossip and curious anecdotes of great interest to the student of history. Several MSS. are extant, but the work has never been printed.

OWEGO, a post village and township of the United States, capital of Tioga county, New York, lies at the mouth of Owego Creek, on the north side of the Susquehanna (here crossed by a bridge), 237 miles north-west of New York by the New York, Erie, and Western Railroad, which here connects with the Delaware, Lackawanna, and Western and the Southern Central Railroads. The village, built at the foot of a considerable hill in the heart of a fine agricultural district, is a pleasant place with broad maple-shaded side-walks along its principal streets. Grist-mills, soap-works, marble-works, a piano factory, and carriage-works are among the industrial establishments. The population of the village was 4756 in 1870 and 5525 in 1880; that of the whole township 9442 and 9984 respectively.

OWEN, JOHN (*Ovenius* or *Audonius*) (1560-1622), a writer of Latin epigrams, once very popular all over Europe, was of Welsh extraction, and was born at Armon, Carmarvonshire, in 1560. He was educated under Dr Elson at Wykeham's School, Winchester, and afterwards studied at New College, Oxford, where he received a fellowship in 1584, and took the degree of bachelor of laws in 1590. Throwing up his fellowship during the following year, he turned schoolmaster, and taught successively at Trylgh, near Monmouth, and at Warwick, where he was master of the free school founded by Henry VIII. He soon became distinguished for his perfect mastery of the Latin language, and for the humour, felicity, and point of his epigrams. As a writer of Latin verse he takes rank with Buchanan and Cowley. Those who, with Dryden, place the epigram "at the bottom of all poetry" will not estimate Owen's poetical genius very high; yet the Continental scholars and wits of the day used to call him "the British Martial." "In one respect he was a true poet," says a biographer; "namely, he was always poor." He was a staunch Protestant besides, and could not resist the temptation of turning his wit against Popery occasionally. This practice caused his book to be placed on the *Index Prohibitorius* of the Roman Church in 1654, and, what was yet more serious, led a rich old uncle of the Roman Catholic communion, from whom he had "great expectations," to cut the epigrammatist out of his will. When the poet died in 1622, his countryman and relative, Bishop Williams of Lincoln, had him buried at St Paul's Cathedral, London, where he erected a monument to his memory bearing an elegant epitaph in Latin.

Owen's *Epigrammata* are divided into twelve books, of which the first four were published in 1606, and the rest at four different times. Owen frequently adapts and alters to his own purpose the lines of his predecessors in Latin verse, and one such borrowing has become celebrated as a quotation, though few know where it is to be found. It is the first line of this epigram:—

"Tempora mutantur, nos et mutamur in illis;  
Quo modo? Si semper tempore peior homo."  
(Lib. I. ad Edoardum Noel, *epig.* 89.)

This first line is altered from an epigram by Matthew Borbonius, one of a series of mottoes for various emperors, this one being for Lothaire I.

"Omnia mutantur, nos et mutamur in illis;  
Illa vires quasdam res habet, illa vires."

There are editions of the *Epigrammata* by Elsevir and by Didot;

the best is that edited by Renouard (2 vols., Paris, 1795). Translations into English, either in whole or in part, have been made by Vicars, 1619; by Pecke, in his *Parnassus Purpurium*, 1659; and by Harvey in 1677, which is the most complete. La Torre, the Spanish epigrammatist, owed much to Owen, and translated his works into Spanish in 1674. French translations of the best of Owen's epigrams have been published by A. L. Lebrun, 1709, and by Kérivalant, 1819.

OWEN, JOHN (1616-1683), theologian, was born of Puritan parents at Statham in Oxfordshire in 1616. At twelve years of age he was admitted at Queen's College, Oxford, where he took his B.A. degree in 1632 and M.A. in 1635. During these years he worked with such diligence that he allowed himself but four hours sleep a night, and damaged his health by this excessive labour. In 1637 he was driven from Oxford by his refusal to comply with the requirements of Laud's new statutes. Having taken orders shortly before, he became chaplain and tutor in the family of Sir Robert Dormer of Ascot in Oxfordshire. At the outbreak of the civil troubles he adopted Parliamentary principles, and thus lost both his place and the prospects of succeeding to his uncle's fortune. For a while he lived in Charterhouse Yard, in great unsettlement of mind on religious questions, which was removed at length by a sermon which he accidentally heard at St Michael's in Wood Street.

His first publication, in 1642, *The Display of Arminianism*, dedicated to the committee of religion, gained him the living of Fordham in Essex, from which a "scandalous minister" had been ejected. Here he was married, and by his marriage he had eleven children.

Although he was thus formally united to Presbyterianism, Owen's views were originally inclined to those of the Independents, and, as he acquainted himself more fully with the controversy, he became more resolved in that direction. He represented, in fact, that large class of persons who, falling away from Episcopacy, attached themselves to the very moderate form of Presbyterianism which obtained in England as being that which came first in their way. His views at this time are shown by his *Duty of Pastors and People Distinguished*. At Fordham he remained until 1646, when, the old incumbent dying, the presentation lapsed to the patron, who gave it to some one else. He was now, however, coming into notice, for on April 29 he preached before the Parliament. In this sermon, and still more in his *Thoughts on Church Government*, which he appended to it, his tendency to break away from Presbyterianism is displayed.

The people of Coggeshall in Essex now invited him to become their pastor. Here he declared his change by founding a church on Congregational principles, and, in 1647, by publishing *Escol*, as well as various works against Arminianism. He made the friendship of Fairfax while the latter was besieging Colchester, and urgently addressed the army there against religious persecution. He was chosen to preach to Parliament on the day after the execution of Charles, and succeeded in fulfilling his task without mentioning that event, and again on April 19, when he spoke thus:—"The time shall come when the earth shall disclose her slain, and not the simplest heretic shall have his blood unrevenge; neither shall any atonement or expiation be allowed for this blood, while a toe of the image, or a bone of the beast, is left unbroken."

He now became acquainted with Cromwell, who carried him off to Ireland in 1649 as his chaplain, that he might regulate the affairs of Trinity College; while there he began the first of his frequent controversies with Baxter by writing against the latter's *Aphorisms of Justification*. In 1650 he accompanied Cromwell to Scotland, and returned to Coggeshall in 1651. In March Cromwell, as chancellor, gave him the deanery of Christ Church, and made him

vico-chancellor in September 1652. In 1651, October 24, after Worcester, he preached the thanksgiving sermon before Parliament. In October 1653 he was one of several ministers whom Cromwell, probably to sound their views, summoned to a consultation as to church union. In December in the same year he had the honour of D.D. conferred upon him by his university. In the Parliament of 1654 he sat, but only for a short time, as member for Oxford university, and, with Baxter, was placed on the committee for settling the "fundamentals" necessary for the toleration promised in the Instrument of Government. He was, too, one of the Triers, and appears to have behaved with kindness and moderation in that capacity. As vico-chancellor he acted with readiness and spirit when a general rising in the west seemed imminent in 1655; his adherence to Cromwell, however, was by no means slavish, for he drew up, at the request of Desborough and Pride, a petition against his receiving the kingship (see Ludlow's *Memoirs*, ed. 1751, p. 224). During the years 1654-58 his chief controversial works were *Divina Justitia, The Perseverance of Saints* (against Goodwin), and *Vindictæ Evangelicæ* (against the Socinians). In 1658 he took a leading part in the conference which drew up the Savoy Declaration.

Baxter declares that at the death of Cromwell Owen joined the Wallingford House party. This, though supported by the fact that under the Restoration he had among his congregation a large number of these officers, Owen himself utterly denied. He appears, however, to have assisted in the restoration of the Rump Parliament, and, when Monk began his march into England, Owen, in the name of the Independent churches, to whom Monk was supposed to belong, and who were keenly anxious as to his intentions, wrote to dissuade him from the enterprise.

In March 1660, the Presbyterian party being uppermost, Owen was deprived of his deanery, which was given back to Reynolda. He retired to Stadham, where he wrote various controversial and theological works, in especial the laborious *Theologoumena Pantodapa*, a history of the rise and progress of theology. In 1661 was published the celebrated *Fiat Lux*, a work in which the oneness and beauty of Roman Catholicism are contrasted with the confusion and multiplicity of Protestant sects. At Clarendon's request Owen answered this in 1662 in his *Animadversions*; and this led of course to a prolonged controversy. Clarendon now offered Owen peremptory if he would conform. Owen's condition for making terms was liberty to all who agree in doctrine with the Church of England; nothing therefore came of the negotiation.

In 1663 he was invited by the Congregational churches in Boston, New England, to become their minister, but declined. The Conventicle and Five Mile Acts soon drove him to London; and in 1666, after the Fire, he, as did other leading Nonconformist ministers, fitted up a room for public service and gathered a congregation, composed chiefly of the old Commonwealth officers. Meanwhile he was incessantly writing; and in 1667 he published his *Catechism*, which led to a proposal from Baxter for union. Various papers passed, and after a year the attempt was closed by the following laconical note from Owen: "I am still a well-wisher to these mathematicæ." It was now, too, that he published the first part of his vast work upon the Epistle to the Hebrews.

In 1669 Owen wrote a spirited remonstrance to the Congregationalists in New England, who, under the influence of Presbyterianism, had shown themselves persecutors. At home, too, he was busy in the same cause. In 1670 Parker attacked the Nonconformists in his own style of clumsy intolerance. Owen answered him; Parker

repeated his attack; Marvell wrote *The Rehearsal Transposed*; and Parker is remembered by this alone.

At the revival of the Conventicle Acts in 1670, Owen was appointed to draw up a paper of reasons which was submitted to the House of Lords in protest. In this or the following year Harvard university invited him to become their president; he received similar invitations from some of the Dutch universities.

When Charles issued his Declaration of Indulgence in 1672, Owen drew up an address of thanks. This indulgence gave the dissenters an opportunity for increasing their churches and services, and Owen was one of the first preachers at the weekly lectures which the Independents and Presbyterians jointly held in Plummer's Hall. He was held in high respect by a large number of the nobility (one of the many things which point to the fact that Congregationalism was by no means the creed of the poor and insignificant), and during 1674 both Charles and James held prolonged conversations with him in which they assured him of their good wishes to the dissenters. Charles gave him 1000 guineas to relieve those upon whom the severe laws had chiefly pressed. In 1674 Owen was attacked by one Dr Sherlock, whom he easily vanquished, and from this time until 1680 he was engaged upon his ministry and the writing of religious works. In 1680, however, Stillingfleet having on May 11 preached his sermon on "The Mischief of Separation," Owen defended the Nonconformists from the charge of schism in his *Brief Vindication*. Baxter and Howe also answered Stillingfleet, who replied in *The Unreasonableness of Separation*. Owen again answered this, and then left the controversy to a swarm of eager combatants. From this time to his death he was occupied with continual writing, disturbed only by an absurd charge of being concerned in the Rye House Plot. His most important work was his *Treatise on Evangelical Churches*, in which were contained his latest views regarding church government. During his life he issued more than eighty separate publications, many of them of great size. Of these a list may be found in Orme's *Memoirs of Owen*. For some years before his death Owen had suffered greatly from stone and asthma. He died quietly, though after great pain, at Ealing, on August 24, 1683, and was buried on September 4th in Bunhill Fields, being followed to the grave by a large procession of persons of distinction. "In younger age a most comely and majestic form; but in the latter stages of life, depressed by constant infirmities, emaciated with frequent diseases, and above all crushed under the weight of intense and unremitting studies, it became an incommensurable mansion for the vigorous exertions of the spirit in the service of its God."

For engraved portraits of Owen see first edition of Palmer's *Nonconformists' Memorial and Vertue's Sermons and Tracts*, 1721. The chief authorities for the life are Owen's *Works*; Orme's *Memoirs of Owen*; Wood's *Athenæ Cantoniæ*; Baxter's *Life*; Neal's *History of the Puritans*; Edwards's *Gangrene*; and the various histories of the Independents.

(O. A.)

OWEN, ROBERT (1771-1858), philanthropist, and founder of English socialism, was born at the village of Newtown, Montgomeryshire, in North Wales. His father had a small business in Newtown as saddler and ironmonger, and there young Owen received all his school education, which terminated at the age of nine. At ten he went to Stamford, where he served in a draper's shop for three or four years, and, after a short experience of work in a London shop, removed to Manchester. His success at Manchester was very rapid. When only nineteen years of age he became manager of a cotton mill, in which five hundred people were employed, and by his administrative intelligence, energy, industry, and steadiness soon made it one of the very best establishments of the kind in Great Britain. In this factory Owen used the first bags of



American sea-land cotton ever imported into the country; it was the first cotton obtained from the Southern States of America. Owen also made remarkable improvement in the quality of the cotton spun; and indeed there is no reason to doubt that at this early age he was the first cotton-spinner in England, a position entirely due to his own capacity and knowledge of the trade, as he had found the mill in no well-ordered condition, and was left to organize it entirely on his own responsibility. Owen had become manager and one of the partners of the Chorlton Twist Company at Manchester, when he made his first acquaintance with the scene of his future philanthropic efforts at New Lanark. During a visit to Glasgow he had fallen in love with the daughter of the proprietor of the New Lanark mills, Mr Dale. Owen induced his partners to purchase New Lanark; and after his marriage with Miss Dale he settled there, as manager and part owner of the mills (1800). Encouraged by his great success in the management of cotton factories in Manchester, he had already formed the intention of conducting New Lanark on higher principles than the current commercial ones.

The factory of New Lanark had been started in 1784 by Dale and Arkwright, the water-power afforded by the falls of the Clyde being the great attraction. Connected with the mills were about two thousand people, five hundred of whom were children, brought, most of them, at the age of five or six from the poorhouses and charities of Edinburgh and Glasgow. The children especially had been well treated by Dale, but the general condition of the people was very unsatisfactory. Many of them were the lowest of the population, the respectable country people refusing to submit to the long hours and demoralizing drudgery of the factories; theft, drunkenness, and other vices were common; education and sanitation were alike neglected; most families lived only in one room. It was this population, thus committed to his care, which Owen now set himself to elevate and ameliorate. He greatly improved their houses, and by the unsparring and benevolent exertion of his personal influence trained them to habits of order, cleanliness, and thrift. He opened a store, where the people could buy goods of the soundest quality at little more than cost price; and the sale of drink was placed under the strictest supervision. His greatest success, however, was in the education of the young, to which he devoted special attention. He was the founder of infant schools in Great Britain; and, though he was anticipated by Continental reformers, he seems to have been led to institute them by his own views of what education ought to be, and without hint from abroad. In all these plans Owen obtained the most gratifying success. Though at first regarded with suspicion as a stranger, he soon won the confidence of his people. The mills continued to be a great commercial success, but it is needless to say that some of Owen's schemes involved considerable expense, which was displeasing to his partners. Tired at last of the restrictions imposed on him by men who wished to conduct the business on the ordinary principles, Owen formed a new firm, who, content with 5 per cent. of return for their capital, were ready to give freer scope to his philanthropy (1813). In this firm Jeremy Bentham and the well-known Quaker, William Allen, were partners. In the same year Owen first appeared as an author of essays, in which he expounded the principles on which his system of educational philanthropy was based. From an early age he had lost all belief in the prevailing forms of religion, and had thought out a creed for himself, which he considered an entirely new and original discovery. The chief points in this philosophy were that man's character is made not by him but for him; that it has been formed by circumstances over which he had no control; that he

is not a proper subject either of praise or blame,—these principles leading up to the practical conclusion that the great secret in the right formation of man's character is to place him under the proper influences—physical, moral, and social—from his earliest years. These principles—of the irresponsibility of man and of the effect of early influences—are the keynote of Owen's whole system of education and social amelioration. As we have said, they are embodied in his first work, *A New View of Society, or Essays on the Principle of the Formation of the Human Character*, the first of these essays (there are four in all) being published in 1813. It is needless to say that Owen's new views theoretically belong to a very old system of philosophy, and that his originality is to be found only in his benevolent application of them. For the next few years Owen's work at New Lanark continued to have a national and even a European significance. His schemes for the education of his workpeople attained to something like completion on the opening of the institution at New Lanark in 1816. He was a zealous supporter of the factory legislation resulting in the Act of 1819, which, however, greatly disappointed him. He had interviews and communications with the leading members of Government, including the premier, Lord Liverpool, and with many of the rulers and leading statesmen of the Continent. New Lanark itself became a much-frequented place of pilgrimage for social reformers, statesmen, and royal personages, including Nicholas, afterwards emperor of Russia. According to the unanimous testimony of all who visited it, the results achieved by Owen were singularly good. The manners of the children, brought up under his system, were beautifully graceful, genial, and unconstrained; health, plenty, and contentment prevailed; drunkenness was almost unknown, and illegitimacy was extremely rare. The most perfect good feeling subsisted between Owen and his workpeople, and all the operations of the mill proceeded with the utmost smoothness and regularity; and the business was a great commercial success.

Hitherto Owen's work had been that of a philanthropist, whose great distinction was the originality and unwearying unselfishness of his methods. His first departure in socialism took place in 1817, and was embodied in a report communicated to the Committee of the House of Commons on the Poor Law. The general misery and stagnation of trade consequent on the termination of the great war was engrossing the attention of the country. After clearly tracing the special causes connected with the war which had led to such a deplorable state of things, Owen pointed out that the permanent cause of distress was to be found in the competition of human labour with machinery, and that the only effective remedy was the united action of men, and the subordination of machinery. His proposals for the treatment of pauperism were based on these principles. He recommended that communities of about twelve hundred persons each should be settled on quantities of land of from 1000 to 1500 acres, all living in one large building in the form of a square, with public kitchen and mess-rooms. Each family should have its own private apartments, and the entire care of the children till the age of three, after which they should be brought up by the community, their parents having access to them at meals and all other proper times. These communities might be established by individuals, by parishes, by counties, or by the state; in every case there should be effective supervision by duly qualified persons. Work, and the enjoyment of its results, should be in common. The size of his community was no doubt partly suggested by his village of New Lanark; and he soon proceeded to advocate such a scheme as the best form for the reorganization of society in general. In its fully developed form—and it cannot be said to have



changed much during Owen's lifetime—it was as follows. He considered an association of from 500 to 3000 as the fit number for a good working community. While mainly agricultural, it should possess all the best machinery, should offer every variety of employment, and should, as far as possible, be self-contained. "As these townships," as he also called them, "should increase in number, unions of them federatively united shall be formed in circles of tens, hundreds, and thousands," till they should embrace the whole world in a common interest.

His plans for the cure of pauperism were received with great favour. *The Times* and *The Morning Post* and many of the leading men of the country countenanced them; one of his most steadfast friends was the duke of Kent, father of Queen Victoria. He had indeed gained the ear of the country, and had the prospect before him of a great career as a social reformer, when he went out of his way at a large meeting in London to declare his hostility to all the received forms of religion. After this defiance to the religious sentiment of the country, Owen's theories were in the popular mind associated with infidelity, and were henceforward suspected and discredited. Owen's own confidence, however, remained unshaken; and he was anxious that his scheme for establishing a community should be tested. At last, in 1825, such an experiment was attempted under the direction of his disciple, Abram Combe, at Orbiston near Glasgow; and in the same year Owen himself commenced another at New Harmony in Indiana, America. After a trial of about two years both failed completely. Neither of them was a pauper experiment; but it must be said that the members were of the most motley description, many worthy people of the highest aims being mixed with vagrants, adventurers, and crotchety, wrong-headed enthusiasts. After a long period of friction with William Allen and some of his other partners, Owen resigned all connexion with New Lanark in 1828. On his return from America he made London the centre of his activity. Most of his means having been sunk in the New Harmony experiment, he was no longer a flourishing capitalist, but the head of a vigorous propaganda, in which socialism and secularism were combined. One of the most interesting features of the movement at this period was the establishment in 1832 of an equitable labour exchange system, in which exchange was effected by means of labour notes, the usual means of exchange and the usual middlemen being alike superseded. The word "socialism" first became current in the discussions of the Association of all Classes of all Nations; formed by Owen in 1835. During these years also his secularistic teaching gained such influence among the working classes as to give occasion for the statement in the *Westminster Review* (1839) that his principles were the actual creed of a great portion of them. His views on marriage, which were certainly lax, gave just ground for offence. At this period some more communistic experiments were made, of which the most important were that at Ralahine, in the county of Clare, Ireland, and that at Tytherly in Hampshire. It is admitted that the former (1831) was a remarkable success for three and a half years, till the proprietor, having ruined himself by gambling, was obliged to sell out. Tytherly, begun in 1839, was an absolute failure. By 1846 the only permanent result of Owen's agitation, so zealously carried on by public meetings, pamphlets, periodicals, and occasional treatises, was the co-operative movement, and for the time even that seemed to have utterly collapsed. In his later years Owen became a firm believer in spiritualism. He died at his native town at the age of eighty-seven.

The exposition and criticism of Owen's socialism and of his socialistic experiments belong to the general subject (see SOCIAL-

ISM). Robert Owen was essentially a pioneer, whose work and influence it would be unjust to measure by their tangible results. Apart from his socialistic theories, it should, nevertheless, be remembered that he was one of the foremost and most energetic promoters of many movements of acknowledged and enduring usefulness. He was the founder of infant schools in England; he was the first to introduce reasonably short hours into factory labour, and zealously promoted factory legislation—one of the most needed and most beneficial reforms of the century; and he was the real founder of the co-operative movement. In general education, in sanitary reform, and in his sound and humanitarian views of common life, he was far in advance of his time. Still he had many serious faults; all that was quixotic, crude, and superficial in his views became more prominent in his later years; and by the extravagance of his advocacy of them he did vital injury to the cause he had at heart. In his personal character he was without reproach—frank, benevolent, and straightforward to a fault; and he pursued the altruistic schemes in which he spent all his means with more earnestness than most men devote to the accumulation of a fortune.

Of R. Owen's numerous works in exposition of his system, the most important are the *New View of Society*, already mentioned; the *Report* communicated to the Committee on the Poor Law; the *Book of the New Moral World*; and *Revolution in the Mind and Practice of the Human Race*. See *Life of Robert Owen* written by himself, London, 1827, and *Threading my Way, Twenty-seven Years of Autobiography*, by Robert Dale Owen, his son, London, 1874. There are also *Lives of Owen* by A. J. Booth (London, 1869) and by W. L. Bergant (London, 1890). For works of a more general character see G. J. Holyoake, *History of Co-operatives in England*, London, 1878; Baynaud, *Etudes sur les réformateurs modernes*, Paris, 1884; Adolf Held, *Zwei Dächter zur sozialen Geschichte Englands*, Leipzig, 1881. (G. K.)

OWENSBOROUGH, a city of the United States, capital of Daviess county, Kentucky, on the Ohio, 160 miles below Louisville. It engages extensively in the manufacture of whisky and the curing of tobacco, and has wagon factories, flour-mills, and foundries. The population, 6231 in 1880, exceeded 11,000 in 1883.

OWL, the Anglo-Saxon *Ule*, Swedish *Ugla*, and German *Eule*—all allied to the Latin *Uvula*, and evidently of imitative origin—the general English name for every nocturnal Bird-of-prey,<sup>1</sup> of which group nearly two hundred species have been recognized. The Owls form a very natural assemblage, and one about the limits of which no doubt has for a long while existed. Placed by nearly all systematists for many years as a Family of the Order *Accipitres* (or whatever may have been the equivalent term used by the particular taxonomers), there has been of late a disposition to regard them as forming a group of higher rank. On many accounts it is plain that they differ from the ordinary diurnal Birds-of-prey, more than the latter do among themselves; and, though in some respects Owls have a superficial likeness to the GOATSUCKERS (vol. x. p. 711), and a resemblance more deeply seated to the GUACHARO (vol. xi. p. 227), even the last has not been made out to have any strong affinity to them. A good deal is therefore to be said for the opinion which would regard the Owls as forming an independent Order, or at any rate Sub-order, *Striges*. Whatever be the position assigned to the group, its subdivision has always been a fruitful matter of discussion, owing to the great resemblance obtaining among all its members, and the existence of safe characters for its division has only lately been at all generally recognized. By the older naturalists, it is true, Owls were divided, as was first done by Willughby, into two sections—one in which all the species exhibit tufts of feathers on the head, the so-called "ears" or "horns," and the second in which the head is not tufted. The artificial and therefore untrustworthy nature of this distinction was shewn by Isidore Geoffroy St-Hilaire (*Ann. Sc. Naturelles*, xii. pp. 194-203) in 1830; but he did not do much good in the

<sup>1</sup> The poverty of the English language—generally so rich in synonyms—is here very remarkable. Though four well-known if not common species of Owls are native to Britain, to say nothing of half a dozen others which occur with greater or less frequency, none of them has ever acquired an absolutely individual name, and various prefixes have to be used to distinguish them. In Greece and Italy, Germany and France, almost each indigenous species has had its own particular designation in the vulgar tongue. The English Owllet or Howlet is of course a simple diminutive only.

arrangement of the Owls which he then proposed; and it was hardly until the publication ten years later of Nitzsch's *Pterylographie* that rational grounds on which to base a division of the Owls were adduced. It then became manifest that two very distinct types of pterylois existed in the group, and further it appeared that certain differences, already partly shewn by Berthold (*Beitr. zur Anatomie*, pp. 166, 167), of sternal structure coincided with the pterylogical distinctions. By degrees other significant differences were pointed out, till, as summed up by Prof. Alphonse Milne-Edwards (*Ois. foss. de la France*, ii. pp. 474-492), there could no longer be any doubt that the bird known in England as the Screech-Owl or Barn-Owl, with its allies, formed a section which should be most justifiably separated from all the others of the group then known. Space is here wanting to state particularly the pterylogical distinctions which will be found described at length in Nitzsch's classical work (English translation, pp. 70, 71), and even the chief osteological distinctions must be only briefly mentioned. These consist in the Screech-Owl section wanting any manubrial process in front of the sternum, which has its broad keel joined to the clavicles united as a furcula, while posteriorly it presents an unbroken outline. In the other section, of which the bird known in England as the Tawny or Bawn Owl is the type, there is a manubrial process; the furcula, far from being joined to the keel of the sternum, often consists but of two stylets which do not even meet one another; and the posterior margin of the sternum presents two pairs of projections, one pair on each side, with corresponding fissures between them. Furthermore the Ovis of the same section shew another peculiarity in the bone usually called the tarsus. This is a bony ring or loop bridging the channel in which lies the common extensor tendon of the toes—which does not appear in the Screech-Owl section any more than in the majority of birds. The subsequent examination by M. Milne-Edwards (*Nouv. Arch. du Muséum*, ser. 2, i. pp. 185-200) of the skeleton of an Owl known as *Phodilus* (more correctly *Photodilus*) *badicus*, hitherto attached to the Screech-Owl section, shews that, though in most of its osteological characters it must be referred to the Tawny Owl section, in several of the particulars mentioned above it resembles the Screech-Owls, and therefore we are bound to deem it a connecting link between them. The pterylogical characters of *Photodilus* seem not to have been investigated, but it is found to want the singular bony tarsal loop, as well as the manubrial process, while its clavicles are not united into a furcula and do not meet the keel, and the posterior margin of the sternum has processes and fissures like those of the Tawny Owl section. *Photodilus* having thus to be removed from the Screech-Owl section, Prof. Milne-Edwards has been able to replace it by a new form *Hediodilus* from Madagascar, described at length by him in M. Grandidier's great work on the natural history of that island (*Oiseaux*, i. pp. 113-118). The unexpected results thus obtained preach caution in regard to the classification of other Owls, and add to the misgivings that every honest ornithologist must feel as to former attempts to methodize the whole group—misgivings that had already arisen from the great diversity of opinion displayed by previous classifiers, no two of whom seem able to agree. Moreover, the difficulties which beset the study of the Owls are not limited to their respective relations, but extend to their scientific terminology, which has long been in a state so bewildering that nothing but the strictest adherence to the very letter of the laws of nomenclature, which are approved in principle by all but an insignificant number of naturalists, can clear up the confusion into which the matter has been thrown by heed-

less or ignorant writers—some of those who are in general most careful to avoid error being not wholly free from blame in this respect.

A few words are therefore here needed on this most unprofitable subject.<sup>1</sup> Under the generic term *Strix* Linnaeus placed all the Owls known to him; but Brisson most justifiably divided that genus, and in so doing fixed upon the *S. stridula*—the aforesaid Tawny Owl—as its type, while under the name of *Asio* he established a second genus, of which his contemporary's *S. ovis*, afterwards to be mentioned, is the type. Some years later Savigny, who had very peculiar notions on nomenclature, disregarding the act of Brisson, chose to regard the Linnaean *S. flammea*—the Screech-Owl before spoken of—as the type of the genus *Strix*, which genus he further discovered, and his example was largely followed until Fleming gave to the Screech-Owl the generic name of *Asuco*,<sup>2</sup> by which it had been known for more than three hundred years, and reserved *Strix* for the Tawny Owl. He thus anticipated Nitzsch, whose editor was probably unacquainted with this fact when he allowed the name *Hybris* to be conferred on the Screech-Owl. No doubt inconvenience is caused by changing any general practice; but, as will have been seen, the practice was not universal, and such inconvenience as may arise is not chargeable on those who abide by the law, as it is intended in this article to do. The reader is therefore warned that the word *Strix* will be here used in what is believed to be the legitimate way, for the genus containing the *Strix stridula* of Linnaeus, while *Asuco* is retained for that including the *S. flammea* of the same naturalist.

Except the two main divisions already mentioned, any further arrangement of the Owls must at present be deemed tentative, for the ordinary external characters, to which most systematists trust, are useless if not misleading.<sup>3</sup> Several systematizers have tried to draw characters from the orifice of the ear, and the parts about it; but hitherto these have not been sufficiently studied to make the attempts very successful. If it be true that the predominant organ in any group of animals furnishes for that group the best distinctive characters, we may have some hope of future attempts in this direction,<sup>4</sup> for we know that few birds have the sense of hearing so highly developed as the Owls, and also that the external ear varies considerably in form in several of the genera which have been examined. Thus in *Surnia*, the Hawk-Owl, and in *Nyctea*, the Snowy Owl, the external ear is simple in form, and, though proportionally larger than in most birds, it possesses no very remarkable peculiarities,—a fact which may be correlated with the diurnal habits of these Owls—natives of the far north, where the summer is a season of constant daylight, and to effect the capture of prey the eyes are perhaps more employed than the ears.<sup>5</sup> In *Bubo*, the Eagle-Owl, though

<sup>1</sup> It has been dealt with at greater length in *The Ibis* for 1876 (pp. 94-105).

<sup>2</sup> The word seems to have been the invention of Gass, the translator of Aristotle, in 1503, and is the Latinized form of the Italian *Asucco*.

<sup>3</sup> It is very much to be regretted that a very interesting form of Owl, *Sceloglaux albifacies*, peculiar to New Zealand, should be rapidly becoming extinct, without any effort, so far as is known, being made to ascertain its affinities. It would seem to belong to the Strigine section, and is remarkable for its very massive clavicles, that unite by a kind of false joint, which in some examples may possibly be wholly ankylosed, in the median line.

<sup>4</sup> This hope is strengthened by the very praiseworthy essay on the Owls of Norway by Herr Collett in the *Forhandlinger* of Christiania for 1881.

<sup>5</sup> But this hypothesis must not be too strongly urged; for in *Carina*, a more southern form of nocturnal (or at least crepuscular) habits, the external ear is perhaps even more normal. Of course by the ear the real organ of hearing is here meant, not the tuft of feathers often so called in speaking of Owls.

certainly more nocturnal in habit, the external ear, however, has no very remarkable development of conch, which may perhaps be accounted for by the ordinary prey of the bird being the larger rodents, that from their size are more readily seen, and hence the growth of the bird's auditory organs has not been much stimulated. In *Strix* (as the name is here used), a form depending greatly on its sense of hearing for the capture of its prey, the ear-conch is much enlarged, and it has, moreover, an elevated flap or operculum. In *Asio*, containing the Long-eared and Short-eared Owls of Europe, Asia, and America, the conch is enormously exaggerated, extending in a semicircular direction from the base of the lower mandible to above the middle of the eye, and is furnished in its whole length with an operculum.<sup>1</sup> But what is more extraordinary in this genus is that the entrance to the ear is asymmetrical—the orifice on one side opening downwards and on the other upwards. This curious adaptation is carried still further in the genus *Nyctala*, containing two or three small species of the Northern hemisphere, in which the asymmetry that in *Asio* is only skin-deep extends, in a manner very surprising, to several of the bones of the head, as may be seen in the Zoological Society's *Proceedings* (1871, pp. 739-743), and in the large series of figures given by Messrs Baird, Brewer and Ridgway (*N. Am. Birds*, iii, pp. 97-102).

Among Owls are found birds which vary in length from 5 inches—as *Glaucidium cobanense*, which is therefore much smaller than a Skylark—to more than 2 feet, a size that is attained by many species. Their plumage, none of the feathers of which possesses an afterhaft, is of the softest kind, rendering their flight, almost noiseless. But one of the most characteristic features of this whole group is the ruff, consisting of several rows of small and much-curved feathers with stiff shafts—originating from a fold of the skin, which begins on each side of the base of the beak, runs above the eyes, and passing downwards round and behind the ears turns forward, and ends at the chin—and serving to support the longer feathers of the "disk" or space immediately around the eyes, which extend over it. A considerable number of species of Owls, belonging to various genera, and natives of countries most widely separated, are remarkable for exhibiting two phases of coloration—one in which the prevalent browns have a more or less rusty-red tinge, and the other in which they incline to grey. Another characteristic of nearly all Owls is the reversible property of their outer toes, which are not unfrequently turned at the bird's pleasure quite backwards. Many forms have the legs and toes thickly clothed to the very claws; others have the toes, and even the tarsi, bare, or only sparsely beset by bristles. Among the bare-legged Owls those of the Indian *Ketupa* are conspicuous, and this feature is usually correlated with their fish-catching habits; but certainly other Owls that are not known to catch fish present much the same character.

Among the multitude of Owls there is only room here to make further mention of a few of the more interesting. First must be noticed the Tawny Owl—the *Strix stridula* of Linnaeus, the type, as has been above said, of the whole group, and especially of the Strigine section as here understood. This is the *Syrnium aluco* of some authors, the *Chat-huant* of the French, the species whose tremulous hooting "tu-whit, to-who," has been celebrated by Shakespeare, and, as well as the plaintive call, "keewick," of the young after leaving the nest, will be familiar sounds to many readers, for the bird is very generally distributed throughout most parts of Europe, extending its range through Asia Minor to Palestine, and also to Barbary—but not belonging to the Ethiopian Region or to the eastern half of the Palearctic. It is the largest of the species indigenous to Britain, and is strictly a woodland bird, only occasionally choosing any other place for its nest than a hollow tree. Its food consists almost entirely of small mammals, chiefly rodents;

<sup>1</sup> Figures of these different forms are given by Macgillivray (*Brit. Birds*, iii, pp. 396, 403, and 427).

but, though on this account most deserving of protection from all classes, it is subject to the stupid persecution of the ignorant, and is rapidly declining in numbers.<sup>2</sup> Its nearest allies in North America are the *S. nebulosa*, with some kindred forms, one of which, the *S. occidentalis* of California and Arizona, is figured below; but none of them seem to have the "merry note" that is uttered by the



FIG. 1.—*Strix occidentalis*.

European species. Common to the most northerly forest-tracts of both continents (for, though a slight difference of coloration is observable between American examples and those from the Old World, it is impossible to consider it specific) is the much larger *S. cinerea* or *S. lapponica*, whose iron-grey plumage, delicately mottled with dark brown, and the concentric circles of its facial disks make it one of the most remarkable of the group. Then may be noticed the genus *Bubo*—containing several species which from their size are usually known as Eagle-Owls. Here the Nearctic and Palearctic forms are sufficiently distinct—the latter, *B. igneus*,<sup>3</sup> the *Duc* or *Grand Duc* of the French, ranging over the whole of Europe and Asia north of the Himalayas, while the former, *B. virginianus*, extends over the whole of North America. A contrast to the generally sombre colour of these birds is shown by the Snowy Owl, *Nyctea scandiaca*, a circumpolar species, and the only one of its genus, which disdains the shelter of forests and braves the most rigorous arctic climate, though compelled to migrate southward in winter when no sustenance is left for it. Its large size and white plumage, more or less mottled with black, distinguish this from every other Owl. Then may be mentioned the birds commonly known in English as "Horned" Owls—the *Hibos* of the French, belonging to the genus *Asio*. One, *A. otus* (the *Otus vulgaris* of some authors), inhabits woods, and, distinguished by its long tufts, usually borne erected, would seem to be common to both America and Europe—though experts profess their ability to distinguish between examples from each country. Another species, *A. accipitrinus* (the *Otus brachyotus* of many authors), has much shorter tufts on its head, and they are frequently carried depressed so as to escape observation. This is the "Woodcock-Owl" of English sportsmen, for, though a good many are bred in Great Britain, the majority arrive in autumn from Scandinavia, just about the time that the immigration of Woodcocks occurs. This species frequents heaths, moors, and the open country generally, to the exclusion of woods, and has an enormous geographical range, including not only all Europe, North Africa, and Northern Asia, but the whole of America,—reaching also to the Falklands, the Galapagos, and the Sandwich Islands,—for the attempt to

<sup>2</sup> All Owls have the habit of casting up the indigestible parts of the food swallowed in the form of pellets, which may often be found in abundance under the Owl-roost, and reveal without any manner of doubt what the prey of the birds has been. The result in nearly every case shows the enormous services they render to man in destroying rats and mice. Details of many observations to this effect are recorded in the *Bericht über die XIV. Versammlung der Deutschen Ornithologen-Gesellschaft* (pp. 30-34).

<sup>3</sup> This species bears confinement very well, and propagates freely therein. To it belong the historic Owls of Arundel Castle.

separate specifically examples from those localities only shows that they possess "more or less well-defined local races. Commonly placed near *Asio*, but whether really akin it cannot be stated, is the genus *Scops*, of which nearly forty species, coming from different parts of the world, have been described; but this number should probably be reduced by one half. The type of the genus, & genus, the *Petit Duc* of the French, is a well-known bird in the south of Europe, about as big as a Thrush, with very delicately pencilled plumage, occasionally visiting Britain, emigrating in autumn across the Mediterranean, and ranging very far to the eastward. Further southward, both in Asia and Africa, it is represented by other species of very similar size, and in the eastern part of North America by *S. asio*, of which there is a tolerably distinct western form, *S. kennicottii*, besides several local races. *S. asio* is one of the Owls that especially exhibits the dimorphism of coloration above mentioned, and it was long before the true state of the case was understood. At first the two forms were thought to be distinct, and then for some time the belief obtained that the ruddy birds were the young of the greyer form which was called *f. savius*; but now the "Red Owl" and the "Mottled Owl" of the older American ornithologists are known to be one species.<sup>1</sup> One of the most remarkable of American Owls is *Spotio ocellularis*, the bird that in the northern part of the continent inhabits the burrows of the prairie dog, and in the southern those of the beech, where the latter occurs—making holes for itself, says Deriv, when that is not the case,—rattlesnakes being often also joint tenants of the same abodes. The odd association of these animals, interesting as it is, cannot here be more than noticed, for the words must be said, ere we leave the Owls of this section, on the species which has associations of a very different kind—the bird Pallas Athene, the emblem of the city to which science and art were so welcome. There can be no doubt, from the many representations on coins and sculptures, as to their subject being the *Græce nocturna* of modern ornithologists, but those who know the grotesque actions and ludicrous expression of this veritable buffoon of birds can never cease to wonder at its having been simply selected as the symbol of learning, and can hardly divest themselves of a suspicion that the choice must have been made in the spirit of sarcasm. This Little Owl (for that is its only name—though it is not even the smallest that appears in England), the *Chastels* of the French, is spread throughout the greater part of Europe, but it is not a native of Britain. It has a congener in *C. brama*, a bird well known to all residents in India.

Finally, we have Owls of the second section, those allied to the Screech-Owl, *Aluco flammeus*, the *Egyptus*<sup>2</sup> of the French. This,



FIG. 2.—*ALUCO FLAMMEUS*.

with its discordant scream, its snoring, and its hissing, is far too well known to need description, for it is one of the most widely-spread of birds, and is the Owl that has the greatest geographical range, inhabiting almost every country in the world,—Sweden and Norway, America north of lat. 45°, and New Zealand being the principal exceptions. It varies, however, not inconsiderably, both in size and in sameness of colour, and several ornithologists have tried

<sup>1</sup> See the remarks of Mr Ridgway in the work before quoted (*A. N. America*, iii. pp. 9, 10), where also reference is made to the observations of Mr Allen in the *Harvard Bulletin* (ii. pp. 388, 389).

<sup>2</sup> Through the dialectic forms *Frænsis* and *Prænsis*, the origin of the word is easily traced to the Latin *prænsa*—a bird of bad omen; but it has also been confounded with *Ocfraie*, a name of the OGREY (*vide supra*, p. 56).

to found on these variations more than half a dozen distinct species. Some, if not most of them, seem, however, hardly worthy to be considered geographical races, for their differences do not always depend on locality. Mr Sharpe, with much labour and in great detail, has given his reasons (*Cat. B. Brit. Musæum*, ii. pp. 291-309; and *Ornith. Miscellany*, i. pp. 299-298; ii. pp. 1-21) for acknowledging four "subspecies" of *A. flammeus*, as well as five other species. Of these last, *A. insularis* is peculiar to Australia, while *A. nova-hollandia* inhabits also New Guinea, and has a "subspecies," *A. castanops*, found only in Tasmania; a third, *A. aspidus*, has a wide range from Fiji and northern Australia through the Philippines and Formosa to China, Burmah, and India; a fourth, *A. expensis*, is peculiar to South Africa; while *A. thomensis* is said to be confined to the African island of St Thomas. To these may perhaps have to be added a species from New Britain, described by Count Salvadori as *Sirix suranica*, but it may possibly prove on further investigation not to be an Alucine Owl at all. (A. N.)

#### OX. See CATTLE.

**OXALIG ACID**, an organic acid of the formula (COOH)<sub>2</sub>, which, in a general scientific sense, excites our interest chiefly by its almost universal diffusion throughout the vegetable kingdom. Traces of oxalates are contained in the juices of, probably, all plants at certain stages of their growth; but so are lime-salts, which, in solutions, can coexist with the former only in the presence of free acid. Hence the frequent occurrence in plant-cells of those crystals of oxalates of lime with which all microscopists are familiar. In certain algae, if they grow on calcareous soils, this salt, according to Braconnot, may form as much as one-half of the total dry solids. Of phanerogamic tissues, the roots of the officinal kinds of rhubarb may be named as being peculiarly rich in oxalate of lime-crystals. It is perhaps as well to add that the juicy stems of the garden rhubarb, although not free of oxalic, owe their sourness chiefly to malic acid. The strongly sour juices of certain species of *Rumex* and *Acetosella*, on the other hand, are exceptionally rich in acid oxalates. The juice of *Oxalis Acetosella*, when concentrated by evaporation, deposits on cooling a large crop of crystals of binoxalate of potash. This salt, as an educt from the plant juice named, has been known for some three centuries as "sal acetosellæ" or "salt of sorrel." Oxalic acid and all soluble oxalates are dangerous poisons, which almost implies that they cannot occur, under normal conditions, in the juices of the higher animals. Yet human urine always contains traces of oxalate of lime, which, when the urine is or becomes alkaline, forms on standing a micro-crystalline deposit. In certain diseased conditions of the system the oxalate is formed more largely, and may be deposited within the bladder in crystals or even develop into calculi.

The discovery of oxalic acid must be credited to Scheele, who obtained it in 1776 by the oxidation of sugar with nitric acid, and called it saccharic acid. In 1784 he proved its identity with the acid of sal acetosellæ. Our knowledge of the elementary composition of oxalic acid is the result of the independent labours of Berzelius, Dübener, and Dulong (1814-21).

Its artificial synthesis can be effected in various ways. Thus, for instance, (1) cyanogen, when dissolved in aqueous hydrochloric acid, gradually assimilates 4H<sub>2</sub>O per N<sub>2</sub>C<sub>2</sub> and becomes oxalate of ammonia, C<sub>2</sub>O<sub>4</sub>(NH<sub>4</sub>)<sub>2</sub> (Liebig). Or (2) moist carbonic acid is reduced by potassium to formic acid, CO<sub>2</sub> + H<sub>2</sub>O - O = CH<sub>2</sub>O<sub>2</sub>, which, of course, assumes the form of potash salt (Kolbe). This latter, when heated beyond its fusing point, breaks up into oxalate and hydrogen, 2CHKO<sub>2</sub> = H<sub>2</sub> + C<sub>2</sub>O<sub>4</sub>K<sub>2</sub> (Erlenmeyer). At 350° dry CO<sub>2</sub> and sodium unite into oxalate C<sub>2</sub>O<sub>4</sub>Na<sub>2</sub> (Drechael).

Sugar, starch, and many other organic bodies of the "fatty" series, when boiled with nitric acid, yield oxalic acid as a penultimate product of oxidation. In this manner oxalic acid used to be produced, industrially, from

starch or molasses; but this method, though not by any means obsolete, is almost superseded by a new process which we owe to Mr Dale of Manchester.

Mr Dale's process is founded upon the old observation of Gay-Lussac's that cellulose, by fusion with caustic potash, is oxidized into oxalate with evolution of (impure) hydrogen. In Mr Dale's works (at Warrington) sawdust and wood-shavings do service as cellulose, while a mixed caustic alkali lye of 1.34 to 1.35 specific gravity, containing 1KHO for every 3NaHO, serves as a reagent. Unmixed caustic soda gives no or little oxalate. The wood-shavings are soaked in a quantity of lye equal to 30 to 40 per cent. of their weight of dry alkali, and the mixture is evaporated down on iron plates at about 200° C. with constant agitation, until it is converted into a homogeneous brown mass completely soluble in water. This mass (which is as yet very poor in oxalate) is then dried up fully at a somewhat lower temperature, and thus converted into a crude oxalate equivalent to 28 to 30 per cent. of its weight of oxalic acid crystals. Messrs Roberts, Dale, & Co. have come, latterly, to substitute for the iron plates an iron pipe passing slantingly through a heated chamber and provided inside with a revolving screw, which draws in the mixture of wood and alkali below, and conveys it along at such a rate that it comes out above as finished product. The crude oxalate is lixiviated with cold water, when the bulk of the oxalic acid remains as soda salt, while the rest of the alkali passes into solution as, substantially, carbonate. The oxalate, after having been washed with the least sufficient quantity of water, is boiled with a dilute milk of lime and thus converted into a precipitate of oxalate of lime, while caustic soda passes in to solution, which is added to the liquors produced in the separation of the oxalate of soda from the surplus alkali. The oxalate of lime is washed and then decomposed by boiling it with three times the calculated amount of dilute sulphuric acid, the sulphate of lime filtered off, and the solution evaporated to crystallization. The yield as oxalic acid crystals amounts to 50 to 60 per cent. of the weight of the wood-shavings. The united alkali-liquors are causticized with lime, and thus (apart from the unavoidable losses) the originally employed caustic alkali is recovered in its entirety.

Commercial (oxalic) acid is contaminated chiefly with sulphuric acid and alkali, of which the latter cannot be removed by recrystallization from water, but, according to Stolba, easily and exhaustively by recrystallization from 10 to 15 per cent. hydrochloric acid.

Crystallized oxalic acid forms colourless needles of the composition  $C_2O_3H_2 + 2H_2O$ . It melts at 98° C., and when kept at about this temperature readily loses its crystal-water, but at 110° the dry acid  $C_2O_3H_2$  already begins to volatilize. The latter sublimes most readily at 165° C. without previous fusion, in needles. At higher temperatures it breaks up, more or less completely, into  $CO_2$  + formic acid,  $CH_2O_2$  (or  $CO + H_2O$ ). The crystallized acid dissolves in 10.5 parts of water of 14° F., also in alcohol. The solution readily neutralizes basic hydrates and carbonates; in the case of the alkalies and alkaline earths, the point of neutrality to litmus corresponds to the normal salt, i.e., to the ratio  $CO_2H : RHO$ , where  $R = K, Na, (NH_4), \frac{1}{2}Ba, \&c.$  The normal salt  $CO_2R$  combines with  $1CO_2H$  into "binoxalate," and, in the case of  $R = K$  or  $NH_4$ , also with  $3CO_2H$  into "quadroxalate." Alkaline oxalates are soluble in water—the soda and ammonia salts rather sparingly; of the rest of oxalates, as far as they are normal salts, the majority are insoluble or difficultly soluble in water, and therefore most conveniently produced, by double decomposition, as precipitates.

**Potash Salts.**—The normal salt,  $C_2O_3K_2 + H_2O$ , is soluble in 5 parts of water of 16° C. The binoxalate (salt of sorrel) is generally anhydrous, but occasionally  $C_2O_3KH + \frac{1}{2}H_2O$ , the latter soluble in 26.2 parts of water of 8° C. The elsewhere extinct industry of manufacturing this salt from sorrel-juice survives in the Black Forest. It is used habitually for removing ink and rust-stains from linen, though oxalic acid is better and cheaper. The quadroxalate,  $C_2O_3KH + C_2O_3H_2 + 2H_2O$ , soluble in 20 parts of water at 20° C., is often sold as salt of sorrel.

**Soda Salts.**—The normal salt,  $C_2O_3Na_2$ , generally forms small

imperfect crystals, soluble in 31.6 parts of water of 13° C. The acid salt,  $C_2O_3NaH + H_2O$ , is soluble in 67.6 parts of water at 10° C.

**Ammonium Salts.**—The normal salt,  $C_2O_3(NH_4)_2 + H_2O$ , found native in guano, crystallizes in needles, and is soluble in 23.7 parts of water of 15° C. It is much used in the laboratory as a most delicate precipitant for lime salts. The binoxalate,  $C_2O_3(NH_4)H + H_2O$ , dissolves in 16 parts of water of 11° F. There is a quadroxalate,  $C_2O_3(NH_4)H + C_2O_3H_2 + 2H_2O$ .

**Other Salts.**—The normal lime salt, as obtained by precipitation of lime salts with alkaline oxalate or oxalic acid, and found in plant cells, is  $C_2O_3Ca + 3H_2O$ ; but  $2H_2O$  are easily lost below 110°; the remaining  $1H_2O$  is expelled only above 200° C. Ferrous oxalate,  $C_2O_3Fe + 2H_2O$ , obtainable by precipitation of ferrous sulphate with oxalic acid, is a yellow crystalline powder. When heated it breaks up into  $CO_2$ , and finely divided metallic iron, which latter at once burns into red ferric oxide of a state of aggregation which fits it pre-eminently for the polishing of optical glasses. Ferric oxalate dissolves in oxalic acid, the solution, when exposed to the light, giving off  $CO_2$ , with precipitation of ferrous oxalate. Draper recommends it for measuring the chemical intensity of light.

Industrially oxalic acid chiefly serves the calico printers as a discharge for certain colours, which, unlike the otherwise equivalent mineral acids, does not attack the tissue. Minor quantities are used, as solution, for cleaning metallic surfaces. It has been recommended for the metallurgic precipitation of NiOxide (q.v.).

**Analysis.**—Solid metallic oxalates, when heated, are decomposed without noteworthy elimination of carbon. When heated with oil of vitriol they give off the components of the anhydride  $C_2O_3$ , as carbonic oxide and carbonic acid gases, without blackening. Oxalate solutions are precipitated by chloride of calcium; the precipitate ( $C_2O_3Ca + H_2O$ ) is insoluble in water, ammonia, ammonia salts, and acetic (though soluble in hydrochloric) acid. Even a mixture of free oxalic acid and gypsum solution deposits oxalate of lime. Oxalic acid is readily oxidized into carbonic acid by the conjoint action of dilute sulphuric acid and binoxide of manganese or permanganate of potash. In the latter case this reaction, even with small quantities, becomes visible by the discharge of the intensely violet colour of the reagent; the change, however, is slow at first; it becomes more and more rapid as the  $MnSO_4$  formed increases, and consequently goes on promptly from the first, if ready made  $MnSO_4$  be added along with the reagent. This permanganate test is readily translatable into a titrimetric method for the determination of oxalic acid in solutions. (W. D.)

**OXENSTIERNA, AXEL, COUNT OF (1583–1654),** Swedish statesman, was born at Fanö in Upland on the 16th of June 1583. He studied theology at Rostock, Wittenberg, and Jena; and in 1602, having spent some time in visiting German courts, he returned to Sweden to take the oath of allegiance to Charles IX., whose service he entered. In 1606 he was sent as ambassador to the court of Mecklenburg, and in 1609 he became a member of the Swedish senate. When Gustavus Adolphus succeeded to the throne, in 1611, Oxenstierna was appointed chancellor, and in 1613 he was plenipotentiary in the negotiations for the conclusion of peace between Sweden and Denmark. In 1614 he went with the king to Livonia, and helped to bring about the cessation of hostilities between Sweden and Russia. After the intervention of Gustavus in the Thirty Years' War, Oxenstierna was made governor-general of all the districts in Prussia which had been overrun by the Swedes; and, when the Imperialists were preparing to besiege Stralsund, he negotiated with the duke of Pomerania for the substitution of Swedish for Danish troops in the town, going subsequently to Denmark to obtain the sanction of the Danish king. While Gustavus pushed on to Franconia and Bavaria, Oxenstierna was entrusted with the supreme direction of affairs, both political and military, in the Rhine country, and he took up his headquarters at Mainz. In 1632, when Gustavus fell at the battle of Lützen, the responsibility for the maintenance of the Protestant cause fell chiefly upon Oxenstierna; and in one of the greatest crises in the history of the world he displayed splendid courage, discretion, and resource. At a congress held in Heilbronn he was appointed director of the evangelical confederation, and in this capacity he went

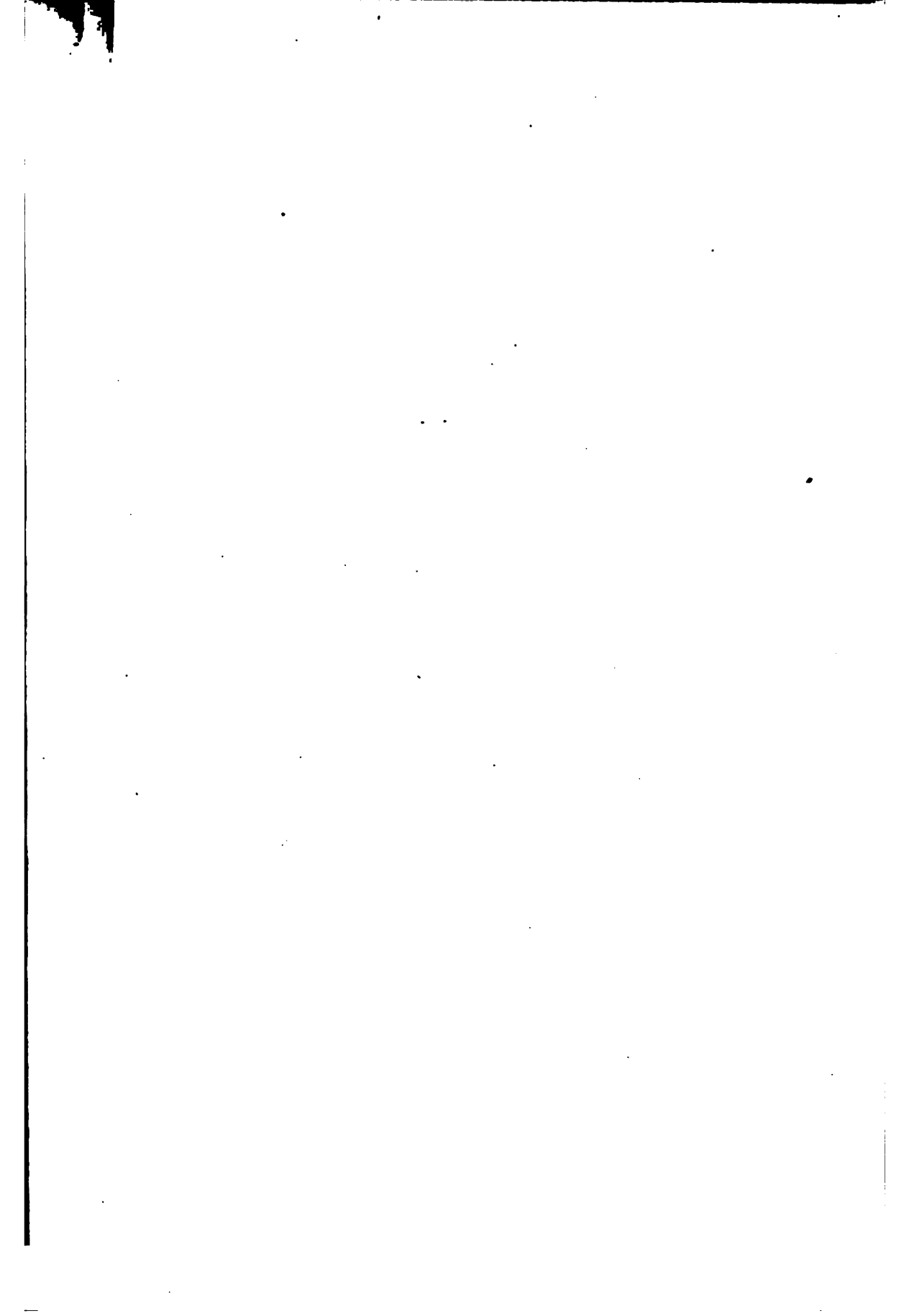



VOL. XVIII. OXFORD, BUCKINGHAM, & BÉRKS. PLATE I.





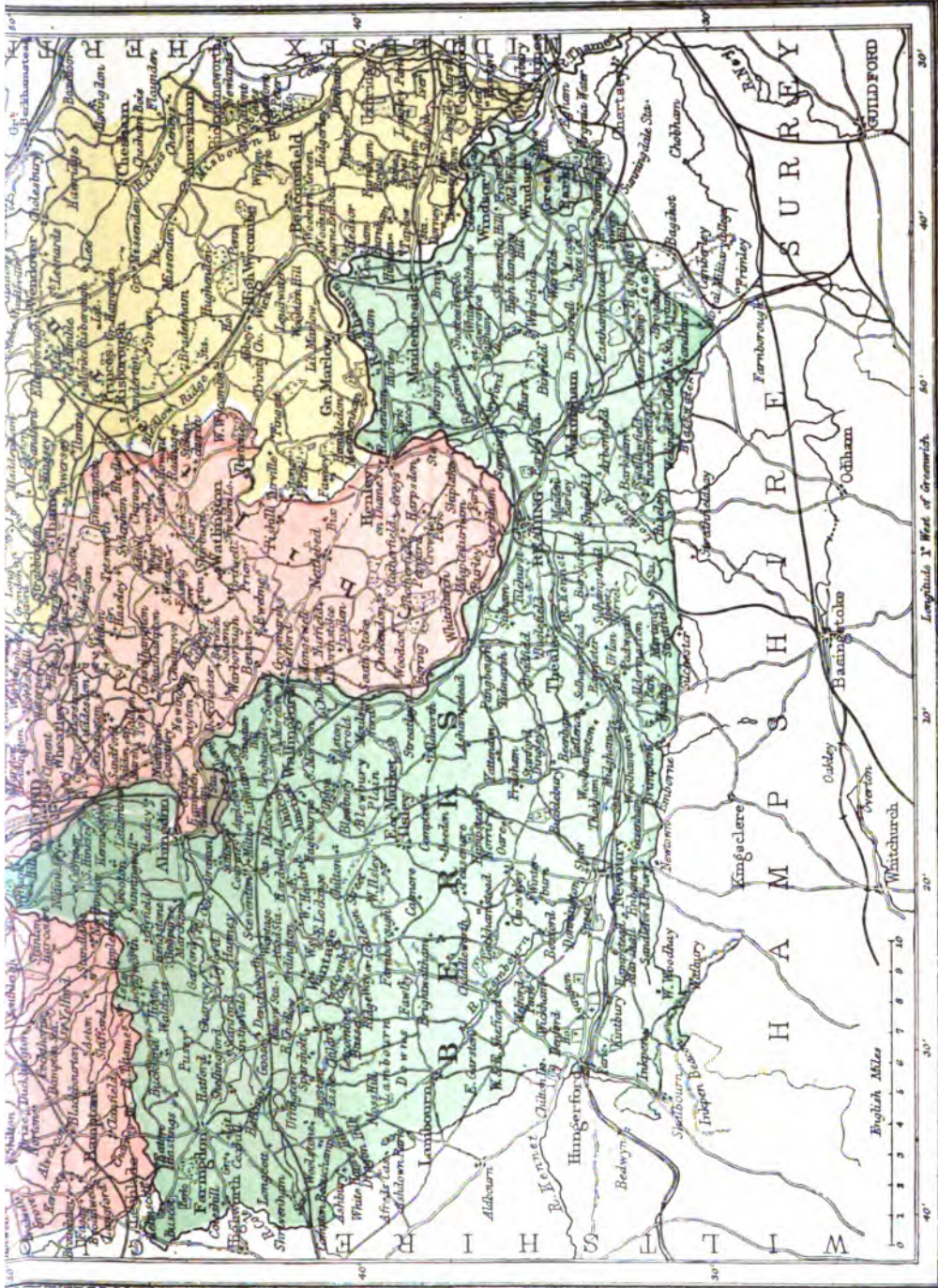

ENCYCLOPEDIA BRITANNICA, NINTH EDITION.

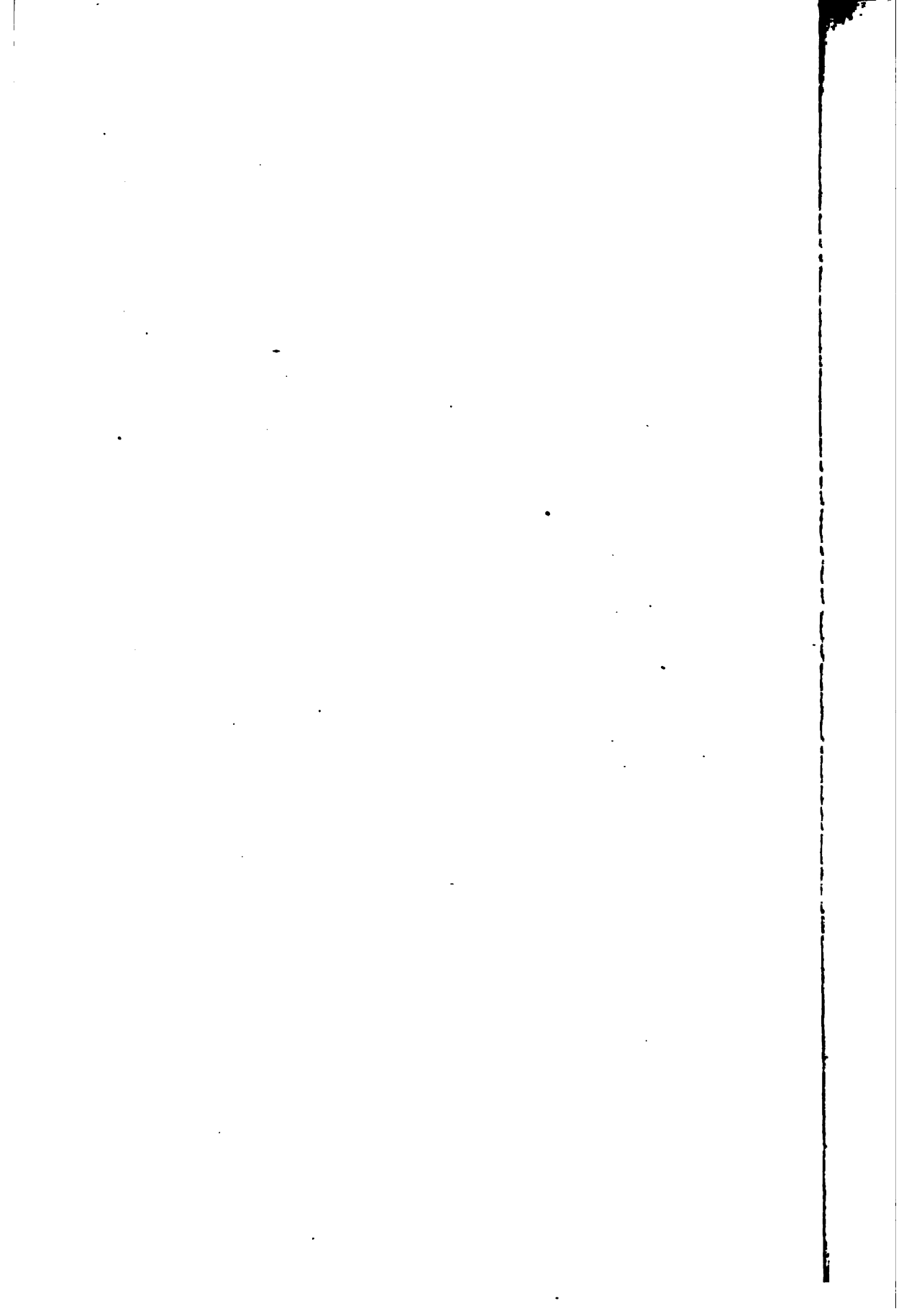

to France and Holland to secure the aid of these countries against the emperor. On his return he found the Protestants in a very desponding mood. The battle of Nördlingen had been lost; the allies distrusted one another; the troops were dissatisfied and resented any attempt to subject them to strict discipline. Oxenstierna laboured indefatigably to restore the confidence of his party, and to a large extent he succeeded. He then returned, in 1636, to Sweden, where he resigned his exceptional powers and resumed his place in the senate as chancellor of the kingdom. He acted also as one of five guardians of Queen Christina, whom he carefully instructed in what seemed to him the true methods of administration. Oxenstierna had the reputation of being one of the wisest statesmen of his age, and during his absence from his country he had drawn up the scheme of a system of government which had been accepted in 1634 by the Swedish estates. Abroad he upheld vigorously the honour of Sweden, and at home he maintained strict economy in public expenditure, while encouraging, according to the ideas of his time, the development of industry and the arts. In 1645, when he went back to Sweden after taking part in the negotiations with Denmark at Brömsebro, he was raised to the rank of count by the queen. He died on the 28th of August 1654.

See Lundblad, *Svensk Piutarch*, 1824.

OXFORD, or Oxon, an inland county of England, is bounded N.E. by Northamptonshire, N.W. by Warwickshire, W. by Gloucestershire, S.S.W. and S.E. by Berks, and E. by Bucks. In shape it is very irregular, its breadth varying from about 7 to 27½ miles, and its greatest length being about 52 miles. The total area is 483,621 acres, or about 756 square miles. The character of the scenery varies greatly in different districts. The Chiltern Hills cross the south-western extremity of the county from north-east to south-west. On the west side of the ridge Nettlebed Hill expands into Nettlebed Common, an extensive table-land, reaching at some points nearly 700 feet above sea-level. The Chiltern district is supposed to have been at one time covered by forest, and there are still many fine beeches, as well as oak and ash trees, although for the most part the district is now utilized as a sheep-walk or as arable land. Camden mentions the woods of Oxfordshire as a special feature of the county. The forest of Wychwood extended to 3735 acres of forest proper. In the district of Staunton St John there are considerable tracts of natural woodland. The most extensive of the recent plantations is the great belt at Blenheim. Immediately to the east of the city of Oxford a range of hills stretches between the valleys of the Thames and Cherwell, the highest point being Shotover Hill, 560 feet. In the central district the surface is less varied, and along the rivers there are extensive tracts of flat land, but the finely cultivated fields and the abundance of wood lend an aspect of richness to the landscape. The northern part of the county is flat and bare, its bleakness and monotony being increased in some districts by the stone fences. Wychwood has been recently disafforested by statute.

Oxfordshire abounds in streams and watercourses, the majority of which belong to the basin of the Thames, which skirts the whole southern border of the county, forming for the most part of its course the boundary with Berks. In the earlier part of its course it is called the Isis. Before reaching the city of Oxford it receives the Windrush, and the united waters of the Evenlode and Glyme. It then divides into various channels, but these soon unite, and the river flowing round the city receives the united streams of the Cherwell and the Ray, and passes south-east to Dorchester, where it is joined by the Thame. From this point it is called the Thames. The

Windrush and Evenlode both flow south-east from Gloucestershire; the Cherwell traverses the whole length of the county south from Northamptonshire; and the Thame crosses its south-east corner from Bucks. The Thames is navigable for small craft to Gloucestershire, and for vessels of considerable burden to Oxford. The Oxford Canal, 91 miles long, begun in 1769 and finished in 1790, enters the north-eastern extremity of the county near Claydon, and following the course of the Cherwell passes south to the city of Oxford.

*Geology.*—The low ground in the north-west, along the vale of Moreton, on the banks of the Cherwell as far as Steeple Aston, and along the banks of the Evenlode, is occupied by the blue clays of the Lower Lias, the higher regions being occupied by the Middle Lias. The Lower Lias contains beds of hard shelly limestone called Banbury marble, which is worked into chimney-pieces; and associated with the blue limestone of the Middle Lias there is a valuable deposit of brown hæmatite iron which is largely worked at Adderbury near Banbury, the total quantity obtained in 1882 being 8614 tons, valued at £1507. At one time the marlstone was covered by the Upper Lias clays, but these are now found only in isolated strips and patches. Beds of Oolite, called Northampton Sands, rest on the higher ridges above the Upper Lias, and the Great Oolite is exposed on both sides of the Evenlode and extensively quarried for building purposes, the upper beds forming also a white limestone containing numerous fossils. Forest marble occupies the greater part of Wychwood Forest, Blenheim Park, and adjoining regions. A wide extent of flat uninteresting country in the south-west, stretching as far east as the city of Oxford, belongs to the Oxford clay. Coral rag, Kimmeridge clay, and white limestone occur at different places in the neighbourhood of the Thames. There are also various outliers of Upper and Lower Greensand. At the junction of the Chalk with the Greensand there is a line of springs which have determined the sites of numerous villages. Chalk forms the ridges of the Chiltern Hills, and Upper Chalk with flint extends eastward a considerable distance beyond them. In the northern and eastern districts there are large accumulations of drift along all the old river valleys; and a considerable breadth of flat country on the banks of the Thames and Cherwell is occupied by alluvial deposits. Ochre of remarkably fine quality is obtained from Shotover Hill.

*Climate, Soil, and Agriculture.*—The climate is salubrious and dry, but generally colder than the other southern districts of England, especially in the bleak and exposed regions of the Chilterns. Crops are later in the uplands than in more northerly situations at a lower elevation. Agriculture is in a fairly advanced condition, but the possibilities of improvement are not by any means exhausted, as the soil is on the whole above the average in fertility. In the northern districts there is a strong yet friable loam, well adapted for all kinds of crops. The centre of the county is occupied for the most part by a good friable but not so rich soil, formed of decomposed sandstone, chalk, and limestone. A large district in the south-east is occupied by the chalk of the Chiltern Hills, at one time covered by a forest of beech, but now partly arable and partly used as sheep-walks. The remainder of the county is occupied by a variety of miscellaneous soils ranging from coarse sand to heavy tenacious clay, and occasionally very fertile.

According to the agricultural returns of 1883, as many as 417,509 acres, or about eight-ninths of the total of the county, were under cultivation, corn crops occupying 152,457 acres, green crops 52,451, rotation grasses 44,472, and permanent pasture 153,998. Wheat and barley, with 51,796 acres and 47,611 acres respectively, occupy the largest areas among corn crops, and oats and beans come next with 31,771 and 14,389. Potatoes are not much grown, but turnips occupy as many as 34,618 acres. The most common course of crops on lighter soils is a four years' rotation, sometimes lengthened to six years with pease, oats, or similar crops. On heavier soils the course is first turnips or other roots, second barley or oats, third three or more years of clover and grass seed, fourth wheat, and finally beans. Along the smaller streams there are very rich meadows for grazing, but those on the Thames and Cherwell are subject to floods. On the

hills there are extensive sheep pastures. Horses in 1883 numbered 17,454, of which 13,716 were used solely for purposes of agriculture. The number of cattle was 80,209, of which 16,914 were cows and heifers in milk or in calf. The dairy system prevails in many places, but the milk is manufactured into butter, little cheese being made. The improved shorthorn is the most common breed, but Alderney and Devonshire cows are largely kept. Sheep numbered as many as 270,288, of which 157,243 were one year old and upwards. Southdowns are kept on the lower grounds, and Leicester and Cotswolds on the hills. Pigs in 1883 numbered 44,682, the county being famous for its "brawn."

According to the latest return, the land was divided among 10,177 proprietors, possessing 452,232 acres, at an annual value of £1,078,346, an average per acre of about £2. 7s. Of the owners, 6833 possessed less than one acre, and the following 10 upwards of 5000 acres, viz., the duke of Marlborough, 21,945; earl of Ducie, 8799; earl of Abingdon, 8174; M. P. W. Boulton, 7946; Sir H. W. Dashwood, 7616; earl of Jersey, 7043; Edward W. Harcourt, 6721; earl of Macclesfield, 5491; Viscount Dillon, 5444; and Lord F. G. Churchhill, 5352. Upwards of 30,000 acres were held by various colleges of Oxford, the largest owner being Christ Church, 4837 acres.

**Manufactures.**—Blankets are manufactured at Witney, and tweeds, girths, and horsecloths at Chipping Norton. There are paper mills at Hampton-Gay, Shipplake, Sandford-on-Thames, Wolvercot, and Eynsham. Agricultural implements and portable engines are made at Banbury, and gloves at Woodstock, where the polished steel work has long ago ceased. A large number of women and girls are employed in several of the towns and villages in the lace manufacture.

**Railways.**—The county is traversed by several branches of the Great Western, which skirts its borders, and by the East Gloucestershire and the London and North-Western Railways.

**Administration and Population.**—Oxfordshire comprises fourteen hundreds, the municipal boroughs of Banbury (3600) and Chipping Norton (4167), the greater part of the city of Oxford, of which the remainder is in Berkshire, and a small portion of the municipal borough of Abingdon, of which the remainder is also in Berkshire. It has one court of quarter sessions, and is divided into ten petty and special sessional divisions. The boroughs of Abingdon and Banbury and the city of Oxford have commissions of the peace and separate courts of quarter sessions. For parliamentary purposes the county is not divided; it returns three members, having previous to the Reform Act of 1832 returned only two. The borough of Woodstock returns one member; and there are parts of four other boroughs within the county, Oxford city returning two members, and Abingdon, Banbury, and Wallingford one each. The university of Oxford also returns two members. The county contains 292 civil parishes, with parts of seven others. It is almost entirely in the diocese of Oxford. The population in 1801 was 111,977, which by 1841 had increased to 163,143, by 1851 to 170,439, by 1871 to 177,976, and by 1881 to 177,559, of whom 88,025 were males and 91,534 females. The average number of persons to an acre was 0.37, and of acres to a person 2.69.

**History and Antiquities.**—At the Roman invasion the district was inhabited by the Dobuni. To this early British period probably belong the circles of stones and cromlechs near Chipping Norton, the cromlechs called the "Hoarstones" at Etonstone, and the scattered stones called the Devil's Quoits at Stanton-Harcourt. Icknield Street crossed the centre of the county from Goring in the south-west to Chinnor in the north-east, and joined Watling Street in Northamptonshire. Akeman Street crossed the county from east to west, entering it from Bucks at Ambroden, and passing through Chesterton, Kirtlington, Blenheim Park, Stonesfield, and Asthall to Gloucestershire. Between Mongewell and Nuffield there is a vallum with embankment 2½ miles in length called Grimes Dyke or Devil's Ditch; and there are remains of another with the same name between the Glyme and the Evenlode near Ditchley. Traces still exist of Roman and British camps, and on the east side of the Cotswolds the square and the round camps lie together in pairs. Numerous Roman coins have been found at Dorchester, and tessellated pavements at Great Tew and Stonesfield. For a long time Oxford was the residence of the monarchs of Mercia. Cuthred of Wessex in 753 disowned the overlordship of Ethelbald of Mercia, whom he defeated at Burford. From this time a portion of Oxfordshire seems to have been subject to Wessex, but Offa of Mercia inflicted in 779 a severe defeat on the West Saxons under Cynwulf, after which Oxfordshire probably became Mercian. The district of Oxford was frequently the scene of conflict during the long contests between the Saxons and the Danes, the latter of whom reduced the city of Oxford four times to ashes, and in the 11th century occupied nearly the whole region. In 1087 the insurgent nobles defeated the earl of Oxford at Radcot Bridge near Banbury. In 1469 the farmers and peasants of Yorkshire, to the number of 15,000, under the leadership of Robin of Redesdale, marched to Banbury, and defeated and captured the earl of Pembroke at Danes Moor on the borders of Oxford. During the civil wars the county

was frequently entered by the armies both of the Parliament and the king, the more important incidents being the seizing of Oxford, Banbury, and Broughton by the Royalists; the assembling of the adherents of the king at the city of Oxford in 1644; the capture of the city by Fairfax in 1646; the surprise of the Parliamentarians by Rupert at Caversham; their repulse at Chalgrove Field, where Hampden received his death-wound; and the defeat of the Royalist forces by Cromwell at Lalip Bridge.

Some portions still remain of the old Norman castle at Oxford; there are traces of a moat at Banbury; of the castle at Bampton, the seat of Aylmer de Valence in 1313, there are a chamber and other fragments; and Broughton Castle is a good moated house of various periods. Among old mansions, mention may be made of Shirburn Castle, Maplehurst House, Chastleton House, Rousham Park, Crowley Park, Hardwick House, Shipton Court, Stonor Park, Stanton-Harcourt Manor House, and Wroxton Abbey. In regard to Burford Priory, the High Lodge at Blenheim Park, and the old manor houses of Holton and Minster Lovell, the interest is chiefly historical. The most interesting churches, in addition to those in the city of Oxford, are Ifley, Norman, one of the finest specimens of early ecclesiastical architecture in England; Thame, with tombs and brasses; Bampton, mostly transitional from Early English and Decorated; Kidlington, Decorated, with a chancel and tower of earlier date; Ewelme, Perpendicular; Adderbury, with a chancel built by William of Wykeham; Bloxham, with spire said to have been erected by Wolsey; Burford, Norman and later; Chipping Norton, with brasses of the 14th century; Dorchester, once an abbey church; Stanton-Harcourt, with Early English chancel; Witney, Early English and Decorated, with Norman doorway. Among the religious foundations in addition to those in the city were a college and hospital at Banbury; an abbey of Austin canons at Bicester; a Cistercian abbey at Bruern; a hospital at Burford; an Austin cell at Caversham; an alien priory at Charlton-on-Otmoor; a Gilbertine priory at Clattercote; an alien priory of Black monks at Cogges; an Austin priory at Cold Norton; a hospital at Crommarsh; a priory of Austin canons at Dorchester; a hospital at Ewelme; a Benedictine abbey at Eynsham; a priory of Austin nuns at Gosling; a preceptory at Gosford; a Benedictine house at Milton; an alien priory at Minster Lovell; an abbey of Austin canons at Osney; a preceptory at Sandford-on-Thames; a Cistercian abbey at Thame; an establishment of the Mathurins at Tuffield; a hospital at Woodstock; and a house of Austin canons at Wroxton. There was a bishopric at Dorchester as a West Saxon see from 684 to 706, which was restored towards the close of the 9th century as a Mercian see. The bishopric was transferred to Lincoln in 1067, from which Oxfordshire was separated and erected into a see in 1545. The diocese was enlarged by the addition of Berks in 1836 and of Bucks in 1846.

See Plot, *Natural History of Oxfordshire*, 1671; Walker, *Flora of Oxfordshire*, 1823; Staddon, *Antiquities of Oxfordshire*, 1829; *Downing Book Pavilion*, 1862; Davport, *Local Government and Etc. Shortly of Oxford*, 1868; 14, *Oxfordshire Annals*, 1869; Phillips, *Geology of Oxford and the Thames Valley*, 1871.

**OXFORD**, the county town of Oxfordshire, a cathedral city, a municipal and parliamentary borough, and the seat of a famous university, is situated at a distance of 45 miles west-north-west from London, in the centre of the south midland district. It lies for the most part on a low ridge between the rivers Thames (locally called the Isis) and Cherwell, immediately above their junction. The soil is gravel lying over extensive beds of Oxford clay. From some points of view the city seems to be surrounded with hills, a line of which runs from Wytham Hill (539 feet) to Cumnor Hurst (515 feet) and Stoneheath (535 feet) on the west of the Thames valley, while on the east Headington Hill approaches still closer, with Shotover (560 feet) behind it. The river bed is about 180 feet above sea-level. Both the Thames and Cherwell valleys are liable to floods, especially in winter and spring.

**University and City Buildings.**—The view of the city, whether from the Abingdon road and Hinksey Hills, or from the old approach from London by Headington, or from the top of the Radcliffe, is a sight not to be forgotten. The towers and spires, numerous and yet varied in character, the quadrangles old and new with their profusion of carved stonework, the absence of large factories and tall chimneys, the groves and avenues of trees, the quiet college gardens, the well-watered valleys and encircling hills—all these combine to make Oxford the fairest city in England. The first place in importance as well as grandeur is taken by the buildings of the university, which will be briefly described in order.



First among the institutions ranks the Bodleian Library (see LIBRARIES, vol. xiv. p. 519). This noble home of study consists in the first place of the quadrangle once known as the "Schools"—containing a Jacobean gateway tower, erected 1613-18, which exemplifies the so-called five orders of architecture—and the upper part of an H-shaped building immediately adjoining. In this older part the manuscripts and most of the printed books are preserved; the fabric of the central part of the H dates from the 15th century, when it housed the library given by Humphrey, duke of Gloucester; while the contents and fittings, even to the readers' seats, have been hardly altered since the days of Charles I. The present library, founded by Sir Thomas Bodley in 1602, has since 1610 had the right to receive a copy of every book published in the United Kingdom, and its growth has been accelerated by donations from Selden, Rawlinson, Malone, Gough, Douce, and others. The modern books are contained in the adjacent circular building known as the "Camera Bodleiana" or "Radcliffe," built 1737-49 by James Gibbs with money left by Dr Radcliffe to erect and endow a scientific library. The Radcliffe Library proper was removed in 1861 to the New Museum. The height of the dome is 140 feet. The Bodleian at present gives a home to the Folger and Arundel marbles, including the famous Parian Chronicle, to a number of models and pictures, to the Hope collection of 200,000 engraved portraits, and in the tower to the archives of the university. The Divinity School, immediately below the older reading-room of the Bodleian, with its beautiful roof and pendants of carved Caen stone, was finished in 1480, and is still the finest room in Oxford. The Proscholium, a rare example of an original ambulatory, adjoins it on the east, and the Convocation House on the west. To the north of these is the Sheldonian Theatre, built at the expense of Archbishop Sheldon from the designs of Sir Christopher Wren, and opened in 1669. The annual Act or "Encenia," a commemoration of benefactors, accompanied by the recitation of prize compositions and the conferment of honorary degrees, has almost invariably been held in this building. It contained also the University Press from 1669 until, in 1713, the Clarendon Building, a conspicuous object in Broad Street, was erected to contain the growing establishment, which was finally moved in 1830 to the present Clarendon Press; the Building is now used for university offices. The Ashmolean Museum, which also faces Broad Street, is an unpretentious edifice, the first public museum of curiosities in the kingdom,—founded by Elias Ashmole, and opened in 1683. The nucleus was formed by the collections of John Tradescant, and not till lately has the museum been made to serve a scientific purpose.

It contains models, ethnographical collections, English and Egyptian antiquities, and miscellaneous curiosities. The last and not the least of this central group of university buildings is the church of St Mary the Virgin in the High Street, which derives peculiar interest from its long connexion with academic history. Here were held the disputations preparatory to a degree; here, time out of mind, the university sermons have been preached; and the north-east corner is the ancient seat of the Houses of Convocation and Congregation. Round it were the earliest lecture-rooms, and its bell was the signal for the gathering of the students, as St Martin's for the townsmen. It has memories too of Wickliffe, of Cranmer, Latimer, and Ridley, of Laud, of Newman, and of Pusey. The tower and spire, of which the height is about 190 feet, date from 1400, the chancel and nave from the succeeding century. The design of the porch was the ground of one of the articles

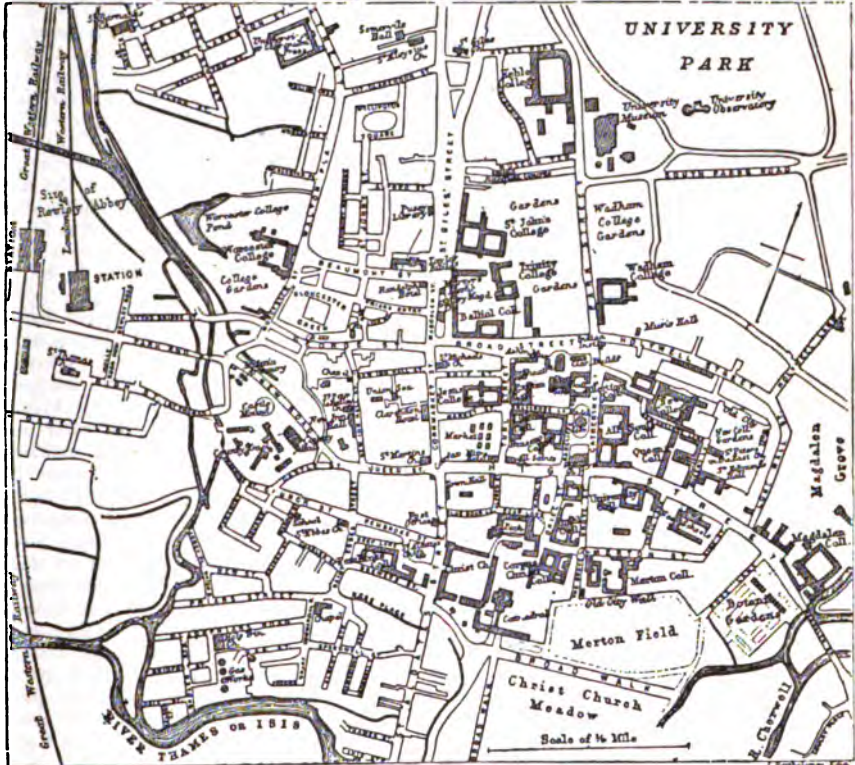

Plan of Oxford

in the impeachment of Laud. Farther down on the south side of the High Street (the curve of which, lined with colleges and churches in its course from the centre of the city at Carfax, leads with beautiful effect to Magdalen tower and bridge) is an extensive building completed in 1882, known as the New Examination Schools, on the site of the old Angel Hotel. The architect was Mr T. G. Jackson, the style Jacobean Gothic. The size and elaborate decoration of the rooms, which form three sides of an oblong quadrangle with an entrance hall opening on the street, well adapt them for the lighter as well as the graver uses of the university. Farther on, and close to the Cherwell, is the Botanic Garden, the first of its kind in England, opened in 1683, the design having been supplied by Inigo Jones. The study of plants is unfortunately carried on at a great distance from the home of the other branches of natural history and science, the New Museum, which was built between 1855 and 1860 in the south-west

in the impeachment of Laud. Farther down on the south side of the High Street (the curve of which, lined with colleges and churches in its course from the centre of the city at Carfax, leads with beautiful effect to Magdalen tower and bridge) is an extensive building completed in 1882, known as the New Examination Schools, on the site of the old Angel Hotel. The architect was Mr T. G. Jackson, the style Jacobean Gothic. The size and elaborate decoration of the rooms, which form three sides of an oblong quadrangle with an entrance hall opening on the street, well adapt them for the lighter as well as the graver uses of the university. Farther on, and close to the Cherwell, is the Botanic Garden, the first of its kind in England, opened in 1683, the design having been supplied by Inigo Jones. The study of plants is unfortunately carried on at a great distance from the home of the other branches of natural history and science, the New Museum, which was built between 1855 and 1860 in the south-west

corner of the Park. The architects were Deane and Woodward, and the cost about £150,000. In it are gathered the numerous scientific collections of the university, from the time of Tradescant and Ashmole to that of the munificent donations of Mr Hope. The general plan is a central hall covered by a glass roof resting on iron columns. The lecture-rooms and Radcliffe Library surround this on both floors. The chief adjuncts to this building are to the south-west a laboratory, an imitation of the shape of the Glastonbury Kitchen, to the south a chemical laboratory, and to the north-west the Clarendon laboratory of physical science. At a short distance to the east in the Park is the University Observatory (1873), consisting of two dome-shaped buildings connected by lecture-rooms (see OBSERVATORY). The Clarendon Press in Walton Street is probably the best appointed of provincial establishments. Founded partly with the profits arising from the copyright of Clarendon's *History of the Rebellion*, the Press was for long, as we have seen, established in the Clarendon Building. Of the present classical building, completed from Robertson's designs in 1830, the chief part forms a large quadrangle. The south side is entirely devoted to the printing of Bibles and prayer-books. All the subsidiary processes of type-founding, stereotyping, electrotyping, and the like are done at the Press, and the paper is supplied from the University Mills at Wolvercote. Printing in Oxford dates from "1468" (1478), but ceased after 1486 until 1685, except in 1517, 1518, and 1519. The first university printer was Joseph Barnes, in 1585. The Press is to a large extent a commercial firm, in which the university has a preponderating influence, as well as prior claims in the case of its own works. It is managed by the partners, and governed by eleven delegates. Returning towards the centre of the city by St Giles's, we pass on the right the Taylor Building, partly devoted to the university gallery of pictures, which contains more than two hundred and seventy sketches and drawings by Michelangelo and Raphael, besides a Turner collection and individual paintings of interest. The rest of the building is divided between the Ruskin School of Drawing and the Taylor Library, which consists chiefly of books in modern European languages. The plan and architecture is Grecian, designed by Cockerell, and completed in 1849. Close by is the Martyrs' Memorial (1841), commemorating the burning of Cranmer, Latimer, and Ridley. It resembles in shape the Eleanor crosses, and is 73 feet in height; it was the first work which brought Sir George Gilbert Scott into notice.

The colleges may now be described, and for convenience of reference in alphabetical order (see also *UNIVERSITIES*). All Souls College (*Collegium Omnium Animarum*) occupies a central position, with fronts to Radcliffe Square and the High Street. The chief points of interest are the magnificent reredos in the chapel, coeval with the college, but lost sight of since the Reformation until discovered and restored in 1872-76; the Codrington Library, chiefly of works on jurisprudence; and the turret (1720) designed by Hawksmoor. The west front is due to Sir Christopher Wren. Founded in 1437 by Archbishop Chichele, with sixteen law fellows out of a foundation of forty, the college has always had a legal character which, combined with an almost entire absence of undergraduates, sufficiently marks it off from all the others. The name records the ancient duty of praying for all who fell in the French wars of the early 15th century. Balliol College, at present the largest in numbers, is also among the oldest. In 1282 the Lady Dervorgilla, widow of John de Balliol, gave effect to his wishes by issuing statutes to a body of students in Oxford who two years later settled on the present site of the college. The buildings are diverse in

style and date, the two most striking being the newest, the chapel built in 1856-57, in modern Gothic, by Butterfield, and the handsome hall erected by Waterhouse in 1876. The King's Hall and College of Brasenose (*Collegium Arnei Nani*) is the combined work of William Smith, bishop of Lincoln, and Sir Richard Sutton. The front quadrangle is among the most regular and, taken in connexion with the Radcliffe and St Mary's church, among the most picturesque in Oxford, remaining exactly as it was built at the foundation of the college in 1509, except that the third story was added, as in several other colleges, in the time of James I. The library and chapel date from the Restoration; the roof of the latter shows some rich wooden fan-tracery. The name is that of one of the old halls absorbed into the new foundation, and probably signifies brew-house (from *bracinarum*, malt, and *-house*), but is popularly connected with a brazen knocker above the gate, said to have been brought from Stamford after the migration of the university thither in 1334; it is, however, first found in the 13th century. Christ Church (*Ædes Christi*), the greatest and most imposing college, and projected on a still larger scale as Cardinal College by its first founder, Wolsey, was established by Henry VIII. in 1525. It is of a peculiar dual character, the cathedral being wholly within its precincts, and partly used as the chapel of the house, while the cathedral chapter shares in the government of the whole society. The dean presides over both institutions. The lower part of the great gateway known as Tom Tower is Wolsey's design, the upper and incongruous part is by Wren; the large bell, weighing 7-tons 12 cwt., daily gives the signal for closing all the college gates by one hundred and one strokes at 9.5 P.M. The chief quadrangle, measuring 264 feet by 261 feet, was designed to have cloisters. The present classical buildings of Peckwater quadrangle are not of earlier date than 1705; the library on the south side was built in 1716-61. The latter contains valuable pictures and engravings not yet sufficiently known, as well as extensive collections of books. The hall (built in 1529), from its size (115 feet by 40 feet), the carving of the oak roof, the long lines of portraits, and the beauty of the entrance staircase, is one of the sights of Oxford. The meadow buildings were erected in 1862-66. It is commonly said that the three great English religious revivals sprang from Christ Church, Wickliffe having been warden of Canterbury Hall, now part of the house, John Wesley a member of the college, and Pusey a canon. Corpus Christi College was founded in 1516 by Bishop Richard Fox, who expressly provided for the study of Greek and Latin; nor have classical traditions ever left the "garden of bees," as the first statutes term it. The chief ornament of the college is the library, which is rich in illuminated and early English MSS., and in early printed books. Exeter College may be said to have been founded (as Stapeldon Hall) in 1314, by Walter de Stapeldon, bishop of Exeter; but Sir William Petre in 1566 largely added to the original endowment. Most of the buildings date from the present century; the chapel, the proportions of which resemble those of the Sainte Chapelle at Paris, was built in 1856-59 by Sir G. Gilbert Scott, the hall in 1818, the Broad Street front in 1855-58. The secluded gardens are beautifully situated beneath the shadow of the Divinity School and Bodleian. Hertford College, founded in 1874, is on a site of old and varied history. From the 13th century until 1740 it was occupied by Hart or Hertford Hall; at the latter date Dr Richard Newton refounded the hall with special statutes of his own framing as Hertford College. In 1822 the society of Magdalen Hall, after the fire at their buildings near Magdalen College, migrated thither, and finally the

hall was merged in the new college which owes its existence to the munificence of Mr T. C. Baring. The Welsh College, Jesus, dates from 1571, having been founded by Dr Hugh Price. Sir Leoline Jenkins, principal at the Restoration, was a conspicuous benefactor. The present buildings are of various dates. The direct connexion with the Principality extends to a moiety of the fellows and a majority of the scholars. Keble College is a testimony to the wide-felt reverence for the character and principles of the Rev. John Keble, who died in 1866. In his memory the college was founded with a special view to economical life and Christian training, based on the principles of the Church of England. Since its opening in 1870 its growth has been continuous: The buildings are the design of Keble's friend Butterfield; the richly ornamented chapel, the gift of Mr William Gibbs, was completed in 1876, and the library and hall in 1878. The style is Italian Gothic, the material to a large extent red brick relieved by white stone, and in the chapel by marble and mosaics. Bishop Richard Flemmyng founded Lincoln College in 1427, with the object, it is believed, of opposing the doctrines of Wickliffe. Like Exeter and Jesus it boasts a second founder in Thomas de Rotherham, also bishop of Lincoln, in 1478. The library is of considerable value, both for MSS. and books. The painted windows in the chapel were procured from Italy in the 18th century. Magdalen College is the most beautiful and the most complete in plan of all the colleges. The extensive water-walks in the Cherwell meadows, the deer park, the cloisters with their ivy-grown walls and quaint emblematic sculptures, the rich new buildings of pure Gothic, and, above all, the tower, combine in this conspicuous result. William Patten, better known as William of Waynflete, bishop of Winchester, established the college in 1456 for a president, forty fellows, and thirty scholars with chaplains and a full choir. The cloister quadrangle was first built in 1473, and the chapel in 1474-80; the latter has a decorated interior, an altarpiece of Christ bearing the Cross similar to that in Bolton Abbey, and painted windows. The tower, of exquisite proportions and harmony of detail, was commenced in 1492, and reached its full height of 145 feet in 1505; it stood for a few years isolated as a campanile. The custom of singing a hymn on the top at 5 A.M. on May-day has been kept up by the choir since the time of Henry VII. The meadow buildings date from 1733. The monuments and library are valuable, the former containing some 14,000 deeds, chiefly of religious houses suppressed at the Reformation. The high-handed attempt of James II. to force a president on the college in 1688 is matter of history. Merton College is in a very definite sense the oldest; the earliest extant statute were given in 1264 by Walter de Merton, and before 1274 it was settled in Oxford. The statutes were a model for all the more ancient colleges both in Oxford and Cambridge. The founder's special intention was to benefit the order of secular priests, and the first century of his society was more prolific of great names than any similar period in any college. The fine chapel, which is also the parish church of St John the Baptist, rose gradually between 1330 and 1450, the tower belonging to the later part. The hall, of the 14th century, was thoroughly restored in 1872. The library, built about 1319, is the oldest existing library in England. To the east lie the quiet well-wooded gardens, still bounded on two sides by the city wall. New College, or more properly the college of St Mary Winton, is the magnificent foundation of William of Wykeham, who closely connected it with his other great work Winchester School. Its name is still significant, for the first statutes marked a new departure, in the adaptation of monastic buildings and

rules to the requirements of a less fettered body of students; and they, like those of Merton, were imitated by succeeding societies. The foundation-stone was laid in 1380, and the hall, chapel, and front quadrangle are of that period, except that the third story of the latter was added in 1674. The chapel is noteworthy for the west window, designed by Sir Joshua Reynolds, and the Flemish windows on the south side; the roof was renewed in 1880. The tower is built on one of the bastions of the city wall, and faces the new buildings in Holywell Street, erected in 1872-75. The gardens and cloisters are among the most picturesque sights of Oxford, the former encompassed on the north and east by the city wall, still almost perfect. Oriel College was founded by Adam de Brome in 1324, and reconstituted by Edward II. in 1326. The present buildings chiefly date from the first half of the 17th century. The Tractarian movement is closely connected with the college of Newman and Keble. Pembroke College (1624) derives its name from the chancellor of the university at the time when it was established by Richard Wightwick, partly by means of a legacy from Thomas Tesdale. The library contains many memorials of Dr Johnson, who was a member of the college. Queen's College, so called from its first patroness, Queen Philippa, was founded in 1340 by Robert de Eglesfield, whose name is commemorated yearly in the custom of presenting a needle and thread ("aiguille et fil," a rebus) to each fellow on New-Year's Day. The present buildings are not older than the Restoration, while the front dates from the middle of the last century, and the west part of the front quadrangle was rebuilt after a disastrous fire in 1778. The interior of the chapel, which is classical in style, with an apse, exhibits some fine wood-carving and windows. Queen's possesses the largest and most valuable collegiate library of printed books, chiefly owing to the munificence of Bishop Barlow in 1691 and of Dr Robert Mason in 1841. On Christmas Day a boar's head is brought into the hall to the accompaniment of an ancient carol. St John the Baptist's College was the work of Sir Thomas White, a London merchant, in June 1555. Archbishop Laud was closely connected with it, and built, almost entirely at his own expense, the second quadrangle, including the library; his body rests within the college. The chapel and other parts of the buildings belonged to the earlier foundation of St Bernard's College. The large gardens are skilfully laid out in alternate lawns and groves. Trinity College, founded in February 1555 by Sir Thomas Pope, was the first post-Reformation college and the first established by a layman. The library is the original one of Durham College, in which Richard de Bury's books were deposited in the 14th century. The gardens are extensive, including a fine lime-tree avenue. University College, the proper title of which is the Great Hall of the University (*Collegium Magna Aula Universitatis*), is generally accounted the oldest college, although its connexion with Alfred is wholly legendary. It received the first endowment given to students at Oxford in 1249 from William of Durham, but its first statutes date from 1280, and its tenure of the present site from about 1340. None of the present buildings are older than the 17th century. The detached library was built in 1860. Wadham College was founded in 1610 by Dorothy Wadham, in pursuance of the designs of her husband Nicholas, who died in 1609. The college buildings, made of exceptionally firm stone, have been less altered than those of any other college. The chapel exhibits a surprisingly pure Gothic style considering its known date, the early part of the 17th century. The meetings held in this college after the Restoration by Dr Wilkins, Bishop Sprat, Sir Christopher Wren, and others directly led to the institu-



tion of the Royal Society. The gardens lie to the north and east. Worcester College, which has recently celebrated the sixcentenary of its first building in 1283 as Gloucester Hall, was at first a place of study for Benedictines from all parts of the country, until it was dissolved at the Reformation, when the buildings passed to the see of Oxford. In 1560 the founder of St John's College reopened it as St John the Baptist's Hall, but after changing fortunes, and an attempt in 1689 to form it into a college for students of the Greek Church, it came in 1714 into the hands of the trustees of Sir Thomas Cooke, who founded the present college. The garden front still retains the antique style of Gloucester Hall, looking over the extensive gardens and pond. The other buildings rose at various periods in the 18th century, while the splendid interior decoration of the chapel, with its profusion of marble, inlaid wood, and painted panel-work, designed by Burgess, was completed in 1870.

Until Laud's time the number of private halls was considerable; by him five only were allowed to survive:—Magdalen Hall, now merged in Hertford College; St Mary Hall, founded in 1333, now destined to be absorbed into Oriol, as New Inn Hall into Balliol, and St Alban Hall into Merton; and St Edmund Hall, which, though closely connected with Queen's College, is likely to maintain a separate existence.

The public buildings of the city, as distinct from the university, do not require a detailed notice. The town-hall dates from 1752, the corn exchange and post-office from 1863 and 1882 respectively. The chief hospital is the Radcliffe Infirmary, opened in 1770, and due to the same liberal benefactor who has been mentioned in connexion with the Radcliffe Library, and who left funds for the erection of the large and important Radcliffe Observatory, completed in 1795. There are two ladies' halls, Lady Margaret's and Somerville, and High Schools for boys and girls. Port Meadow is a large pasture to the north-west of the city, which has belonged from time immemorial to the freemen of the city. An extensive system of drainage has been recently carried out, involving the formation of a sewage farm at Littlemore. Water is supplied from large covered tanks on Headington Hill, into which the water is forced from reservoirs at New Hinksey. The University Park, comprising 80 acres, is beautifully situated on the banks of the Cherwell.

The diocese of Oxford now includes the three "home counties" of Berkshire (originally in the diocese of Wessex, then till 1836 in that of Sherborne or Salisbury), Buckinghamshire (until 1845 under the see of Lincoln), and Oxfordshire (formerly in the dioceses of Dorchester, Winchester, or Lincoln). The patents for the formation of the bishopric bear dates of 1542 and 1546. The cathedral, already mentioned as part of Christ Church, was at first the church of St Frideswide, begun so far as the present buildings are concerned in about 1160, and forming "a fine example of Late Norman and Transitional work of early character." The nave is pure Norman; the choir, with its richer ornament and delicate pendants, is the Transitional part; the present remarkable east end, having a circular window over two smaller round-headed ones, is believed to be a restoration of the original design. Part of the western end of the nave was destroyed by Wolsey to allow the large quadrangle to be formed. Within the cathedral the most noteworthy objects are the 15th century "shrine of St Frideswide," the modern reredos, and the bishop's throne, a memorial of Bishop Wilberforce. The stained glass is of different styles. The octagonal spire, 144 feet high, is of a peculiar pitch. The chapter-house on the south side of the nave, and the fine doorway leading from it to the cloisters, are early 13th-century

work. Of the numerous pariah churches some have already been noticed. All Saints was built early in the 18th century, from designs by Dean Aldrich, in a classical style, but with much originality of detail; St Philip and St James's and St Parnabas's are among the most recent, the latter being in imitation of Italian style with separate campanile. The Roman Catholic church of St Aloysius in St Giles's was opened in 1875.

*History.*—The legends connecting the city with Brute the Trojan, Mempic, and the Druids are not found before the 14th century, and are absolutely without foundation. The name, which is found in the 10th century as *Oxenford*, and in the 11th as *Oxenford*, the Welsh (more modern) *Rhydychain*, points to a ford for oxen across the shallow channels of the divided river near Folly Bridge, though many on theoretical grounds connect the first part of the word with a Celtic root signifying water, comparing it with Ouse, Osney, Exford, and even Isia. The nucleus of the town was probably a nunnery, afterwards a house of secular canons, founded in honour of St Frideswide or in before the 9th century, on the site of the present cathedral. After the peace of Wedmore (886) Oxford became a border town between Mercia and Wessex, and coins of Alfred with the legend *OXANAFORDA* (on some types *OXANAFORDA*) seem to prove that a mint was established there before the close of that century. The earliest undoubted mention of the city is in the English Chronicle under the year 912, when Edward the Elder made London and Oxford a part of his own kingdom of Wessex. To this period probably belongs the castle mound, still a conspicuous object on the New Road between the railway stations and the city, and similar to those found at Warwick and Marlborough. The subsequent notices of Oxford in the Chronicle before the Conquest prove the rapidly increasing importance of the place, both strategically as the chief stronghold of the valley of the upper Thames—as when the Danes attacked and burned it in 1009 and Sweyn took hostages from it and Winchester in 1013—and politically as a meeting-place for gemots in which the interests of north and south England were alike affected. Witanagemots were held there in 1015, when two Danish thegns were treacherously murdered; in 1086, when Harold was chosen king; and in 1065. In 1018, when Cnut first became king of all England, he selected the same spot for the confirmation by Danes and English of "Edgar's law." But the murder of King Edmund in 1016 and the death of Harold in 1039 seem to have given rise to the saying that it was ill-omened for the kings of England to enter or reside at Oxford. The Domesday survey of Oxford (c. 1086) is more than usually complete, and from it we gather that about six-sevenths of the town was held in equal proportions by ecclesiastical owners, by Norman followers of the king, and by citizens, one-seventh being in the king's hands. The priory church of St Frideswide, and the churches of St Mary the Virgin, St Michael, St Peter in the East, and St Ebbe are mentioned; from other sources it is known that St Martin's at Carfax was in existence, and not less than seven more before the close of the century. It is a curious fact that, while two hundred and forty-three houses (*domi*) paid tax, no less than four hundred and seventy-eight were waste (*castis*), and even of the *manisons* one hundred and ninety-one were habitable and not fewer than one hundred and six waste. Oxford grew steadily when governed by the strong hand of Robert d'Oili (1070-1119 f). The existing remains which may be attributed to his building are the castle tower containing the church of St George and a crypt, the crypt and part of the church of St Peter's in the East, and the tower of St Michael's; but it is known that he repaired other churches and built bridges. His nephew founded the abbey of Osney, for Augustinian canons, in 1129. During the 12th century Beaumont Palace, built by Henry I. outside the north wall of the city, was a favourite royal residence, and the birthplace both of Richard I. and of John. In the charter granted by Henry I. the privileges of the town rank with those of London, and a large Jewry was formed near the site of the present town-hall. The flight of the empress Matilda from the castle over the ice-bound river to Abingdon in 1142, when besieged by Stephen, is a well-known incident. If we may trust the Osney Chronicle it is in 1183 that we find the first traces of organized teaching in Oxford, the germ of the great university which was destined to far outstrip the city in privileges, wealth, and fame (see *UNIVERSITIES*). During the 13th century parliaments were often held in the town, notably the Mad Parliament in 1258, which led to the enactment of the "Provisions of Oxford." But this time also witnessed the beginning of the long struggle between the town and university, which produced serious riots, culminating on St Scholastica's day in 1354, and finally subjected the former to serious curtailment of its powers and jurisdiction. History has preserved the names of several heroes in the struggle for civic independence, but the issue was never doubtful, and the annals of the city in succeeding centuries admit of briefer narration. The religious orders found their way early

into Oxford:—in 1221 the Dominicans (whose settlement near the site of the present gas-works is still attested by Blackfriars Street, Procter's Bridge, and Friar's Wharf); in 1224 the Franciscans (who built their house near Paradise Square); soon after 1240 the Carmelites (near Worcester College, to which Friar's Entry led); and in 1252 the Austin Friars, who settled near what is now Wadham College. The greater orders were not less firmly established,—the Cistercians at Rewley Abbey (*de Regali loco*, founded about 1280), the Benedictines scarcely later at Gloucester Hall and Durham College, now Worcester and Trinity College respectively. In the 13th and 14th centuries, as the university grew, an increasing number of students gathered in Oxford, filling the numerous halls and swelling the size, 'if not the wealth, of the place. The total of students in Henry III.'s time was placed at thirty thousand in contemporary records seen by Thomas Gascoigne, but this can only be an exaggeration or a mistake. The town was frequently ravaged by plagues, and generally shared in the exhaustion and inactivity which marked the 15th century. The Reformation was unaccompanied by important incidents other than those which affected the university and the sea; but after the troubles of Mary's reign Oxford again began to revive under the personal favour of Elizabeth, which was continued by the Stuart kings. In the civil war Oxford becomes suddenly prominent as the headquarters of the Royalist party and the meeting-place of the king's parliament. It was hither that the king retired after Edgehill, the two battles of Newbury, and Naseby; from here Prince Rupert made his dashing raids in 1643. In May 1644 the earl of Essex and Waller first approached the city, from the east and south, but failed to enclose the king, who escaped to Worcester, returning once more after the engagement at Cropredy Bridge. The final investment of the city, when the king had lost every other stronghold of importance, and had himself escaped in disguise, was in May 1646; and on June 20 it surrendered to Fairfax. Throughout the war the secret sympathies of the citizens were Parliamentarian, but there was no conflict within the walls. In October 1644 a destructive fire burnt down almost every house between George Street and St Aldate's church. Charles II. held the last Oxford parliament in 1681, the House of Lords sitting in Christ Church Hall, the Commons in the Schools. In the first year of George I.'s reign there were serious Jacobite riots, but from that time the city becomes Hanoverian in opposition to the university, the feeling coming to a head in 1754 during a county election, which was ultimately the subject of a parliamentary inquiry. The public works which distinguish the last century have been already mentioned; the general history of the city proper presents few features of interest. Since the first railway (from Didcot) in 1844 its rate of progress has been accelerated, and it has at length vindicated for itself a vigorous and independent municipal life.

Oxford grew up, as has been seen, on the slope leading from the ford near Folly Bridge to Carfax. Its earliest trade must have been twofold, partly with London by way of the Thames, and partly with the west by the ford. No Roman road of importance passed within three miles of the future town, and the Chiltern Hills prevented a direct road to the metropolis. The first mention of a town is in "seo burhwaru" in the English Chronicle *sub anno* 1013, and of its trade in the toll paid to the abbot of Abingdon by passing barges from the 11th century (*Abingdon Chron.*, vol. ii. p. 119). When the Domesday survey was made all the churches except St Mary Magdalen were within the line of walls. Mr James Parker estimates the population at that time to have been "not more than 1700," occupying one hundred and ninety-one mansions and two hundred and forty-three houses. By the close of the 11th century the castle had been partly built, and the walls enclosed a space roughly of the shape of a parallelogram, its greater length lying nearly east and west, dominated by the castle at its western extremity. In Elizabeth's time, as Ralph Agas's view shows, nine-tenths of the city was still intra-mural. In 1789 the population was about 8800, but more than half lived outside the walls; in 1831, 20,650; in 1881 the municipal borough comprised 35,264, the local board district 38,289, exclusive of about 3000 members of the university. The chief extensions have been towards the north, including both the fashionable quarter beyond the parks and the poorer suburb of Jericho, and on the south-east, where St Clement's and Cowley St John have greatly increased. The newly built low-lying districts of Osoney town with Botley to the west, and Grandpont with New Hinksey to the south, are comparatively unhealthy, contrasting in that respect with the houses rising on Headington Hill. The trade of the city has always been varied rather than extensive; there has never been a staple produce, and the few manufactures are of recent introduction. Oxford being an agricultural centre has an important market, but the alternations of university terms and vacations affect the steadiness of general business. The first charter known is one of Henry I., not now extant, mentioning a merchants' guild (*gilda mercatoria*). That of Henry II. specially connects the citizens with London, *quia ipse ad clivum Londinensem sunt de uno et eadem consuetudine ad loca de libertate*. They were to be bütlers with the letter at the king's

coronation—a privilege still retained by their representative. The earliest governing body was the mayor and burgesses; aldermen were added in 1255, and the full institution from 1605 until 1835 consisted of a mayor, two bailiffs, four aldermen, eight assistants, and twenty-four common council men, together with a high steward, recorder, town-clerk, and inferior officers. At present the government is in the hands of a high steward, recorder, sheriff, and corporation, the latter consisting of a mayor, ten aldermen, and thirty councillors. For the election of the last two classes the city is divided into five wards. There is a local board of forty-seven members and a school board of seven. From the earliest times the city has been represented by two burgesses in parliament.

The chief authorities for the general history of Oxford are the works of Antony Wood, viz., the *Hist. and Antiqu. of the University*, 1792-96 (in Latin 1874), *Hist. and Antiqu. of the Colleges and Halls*, 1790-96, and the *Account and Present State of the City*, 1778; and Ingram, *Memorials of Oxford*, 1837 and 1847. There are good local directories and guides. Of a more special kind are James Parker's sketch of the early *History of Oxford*, 1871; Turner, *Selections from the Records of the City*, 1879; Phillips, *Geology of Oxford*, 1871; and the accounts of All Souls, Exeter, and Magdalen Colleges by Burrows, Boase, and Bloxam respectively. The Oxford Historical Society publishes works bearing on the history of the place. The history of the university will be found under *UNIVERSITY*. (F. M.)

OXFORD, ROBERT HARLEY, FIRST EARL OF (1661-1724), the eldest son of Sir Edward Harley, a prominent landowner in Herefordshire, was born in Bow Street, Covent Garden, London, 5th December 1661. His school days were passed near Burford, in Oxfordshire, in a small school which produced at the same time a lord high treasurer, a lord high chancellor, and a lord chief justice of the common pleas. The principles of Whiggism and Nonconformity were instilled into his mind at an early age, and if he changed the politics of his ancestors he never formally abandoned their religious opinions. At the Revolution of 1688 Sir Edward and his son raised a troop of horse in support of the cause of William III., and took possession of the city of Worcester in his interest. The family zeal for the Revolution recommended Robert Harley to the notice of the Boscawen family, and led to his election, in April 1689, as the parliamentary representative of Tregony, a borough under their control. He remained its member for one parliament, when he was elected by the constituency of New Radnor, and he continued to represent it until his elevation to the peerage in 1711. From the first he gave great attention to the conduct of public business, bestowing especial care upon the study of the forms and ceremonies of the House, and acquiring from his labours that distinction which a knowledge of parliamentary precedents always bestows. This reputation marked him out as a fitting person to preside over the debates of the House, and from the general election of February 1701 until the dissolution of 1705 he held with general approbation the office of speaker. For a part of this period, from 18th May 1704, he combined with the speakership the duties of a principal secretary of state, displacing in that office the Tory earl of Nottingham, a circumstance which may have impelled that haughty peer to join the Whigs, some years later, in opposition to the treaty of Utrecht. At the time of his appointment as secretary of state Harley had given no outward sign of dissatisfaction with the Whigs, and it was mainly through Marlborough's good opinion of his abilities that he was admitted to the ministry. For some time, so long indeed as the victories of the great English general cast a glamour over the policy of his friends, and the constituencies were enthusiastic in support of a war policy, Harley continued to act loyally with his colleagues. But in the summer of 1707 it became evident to Godolphin that some secret influence behind the throne was opposing his wishes and shaking the confidence of the queen in her ministers. The sovereign had resented the intrusion into the administration of the impetuous earl of Sunderland, and had persuaded herself that the safety of the church depended on the fortunes of the Tories. These convictions were strengthened in her mind by the new favourite Abigail

Hill (a relative of the duchess of Marlborough through her mother, and of Harley on her father's side), whose soft and silky ways contrasted only too favourably in the eyes of the queen with the haughty manners of her old friend, the duchess of Marlborough. Both the duchess and Godolphin communicated to Marlborough their belief that this change in the disposition of the queen was due to the sinister conduct of Harley and his relatives, and the persistent protestations of the accused persons to the contrary were accepted with an ill grace. Although Harley was for the present permitted to remain in his office, subsequent experience convinced the chiefs of the Government of the necessity for his dismissal, and an occurrence which showed the remissness of his official conduct, if it did not prove his treachery to the nation, furnished them with an opportunity for carrying out their wishes. An ill-paid and poverty-stricken clerk in Harley's office was detected in furnishing the enemy with copies of many documents which should have been kept from the knowledge of all but the most trusted advisers of the court, and it was found that through the carelessness of the head of the department the contents of such papers became the common property of all in his service. The queen was thereupon informed that Godolphin and Marlborough could no longer serve in concert with a minister whom they distrusted, and of whose incapacity there were such proofs. They did not attend her next council, and when Harley proposed to proceed with the business of the day one of their friends drew attention to their absence, when the queen found herself forced (11th February 1708) to accept the resignation of her secret adviser. At that time it seemed as if Harley's fortunes had sunk for ever.

Harley went out of office, but his cousin, who had now become Mrs Masham, remained by the side of the queen, and contrived to convey to her mistress the views of the ejected minister. Every device which the defeated ambition of a man whose strength lay in his aptitude for intrigue could suggest for hastening the downfall of his adversaries was employed without scruple, and not employed in vain. The cost of the protracted war with France, the danger to the national church, the chief proof of which lay in the prosecution of Sacheverell, were the weapons which he used to influence the masses of the people. Marlborough himself could not be dispensed with, but his proud spirit was insulted in a thousand ways, and his relations were dismissed from their posts in turn. When the greatest of these, Lord Godolphin, was sent into private life, five commissioners to the treasury were appointed (10th August 1710), and among them figured Harley as chancellor of the exchequer. It was the aim of the new chancellor to frame an administration from the moderate members of both parties, and to adopt with but slight changes the policy of his predecessors; but his efforts were doomed to disappointment. The Whigs refused to join in an alliance with the man whose rule began with the retirement from the treasury of the finance minister idolized by the city merchants, and the Tories, who were successful beyond their wildest hopes at the polling booths, could not understand why their leaders should pursue a system of government which copied the faults of their political opponents. The clamours of the wilder spirits of the party, the country members who met at the "October Club," began to be re-echoed even by those who were attached to the person of Harley, when, through an unexpected event, his popularity was restored at a bound. A French refugee, the ex-abbé de la Bourlie (better known by the name of the marquis de Guiscard), was being examined before the privy council on a charge of treachery to the nation which had befriended him, when he stabbed Harley in the breast with a peacock's (March

1711). To a man in good health the wounds would not have been serious, but the minister had been for some time indisposed—a few days before the occurrence Swift had penned the prayer "Pray God preserve his health, everything depends upon it"—and the joy of the nation on his recovery knew no bounds. Both Houses presented an address to the crown, suitable response came from the queen, and on Harley's reappearance in the Lower House the speaker made an oration which was spread broadcast through the country. On the 24th May 1711 the minister became Baron Harley of Wigmore and earl of Oxford and Mortimer; before the month was ended he was created lord treasurer, and in the following year he became a knight of the Garter. Well might his friends exclaim that he had "grown by persecutions, turnings out, and stabbings."

With the sympathy which this attempted assassination had evoked, and with the skill which the lord treasurer possessed for conciliating the calmer members of either political party, he passed through several months of office without any loss of reputation. He rearranged the nation's finances, and continued to support her generals in the field with ample resources for carrying on the campaign, though his emissaries were in communication with the French king, and were settling the terms of a peace independently of England's allies. After many weeks of vacillation and intrigue, when the negotiations were frequently on the point of being interrupted, the preliminary peace was signed, and in spite of the opposition of the Whig majority in the Upper House, which was met by the creation of twelve new peers, the much-vaunted treaty of Utrecht was at last brought to a conclusion. While these negotiations were under discussion the friendship between Oxford and St John was fast changing into hatred. The latter had resented the rise in fortune which the stabs of Guiscard had secured for his colleague, and when he was raised to the peerage with the title of Baron St John and Viscount Bolingbroke, instead of with an earldom, his resentment knew no bounds. The royal favourite, whose husband had been called to the Upper House as Baron Masham, deserted her old friend and relation for his more vivacious rival. The Jacobites found that, although the lord treasurer was profuse in his expressions of good will for their cause, no steps were taken to ensure its triumph, and they no longer placed reliance in promises which were repeatedly made and repeatedly broken. Even Oxford's friends began to complain of his habitual dilatoriness, and to find some excuse for his apathy in ill health, aggravated by excess in the pleasures of the table and by the loss of his favourite child. By slow degrees the confidence of Queen Anne was transferred from Oxford to Bolingbroke; on the 27th July 1714 the former surrendered his staff as lord treasurer, and on the 1st August the queen died.

On the accession of George I. the defeated minister retired to Herefordshire, but a few months later his impeachment was decided upon and he was committed to the Tower. After an imprisonment of nearly two years the prison doors were opened, and he was allowed to resume his place among the peers, but he took little part in public affairs, and died almost unnoticed 21st May 1724. Harley's political fame may now be dimmed by time, his statesmanship may seem but intrigue and finesse, but his character is set forth in the brightest colours in the poems of Pope and the prose of Swift. The Irish dean was his discriminating friend in the hours of prosperity, his unswerving advocate in adversity. The books and manuscripts which the first earl of Oxford and his son collected were among the glories of their age. The manuscripts became the property of the nation; the books were sold to a bookseller called Osborne, and described in

a printed catalogue of four volumes, part of which was the work of Dr Johnson. In the recollection of the Harleian manuscripts, the Harleian library, and the *Harleian Miscellany*, the family name will never die. (w. P. C.)

**OXUS.** This river rises in the lofty table-lands which are intercepted between the two great mountain ranges of central Asia, the Thian Shán and the Hindú Kúsh, in the region where they approach each other most closely. It flows westwards through a broad valley, receiving numerous affluents from the mountain ranges on either side; then bending to the north-west it traverses the arid deserts of western Turkestan on the borders of Bokhara, descends into and fertilizes the rich oasis of Khiva, and finally disembogues at the southern extremity of the Sea of Aral. Its course is roughly parallel to that of its sister river the Jaxartes, which rises to the north of the Thian Shán water-parting, and disembogues at the northern extremity of the Sea of Aral.

The name Oxus is that by which the river is mentioned in the writings of the ancient Greek historians. In the older traditions of the Parsi books it is named the Vehrd, in some form of which originates the classical name which we find it most convenient to use, and also it may be presumed the names of various territories on the banks of its upper waters, such as Wakhan, Wakheh, and Washgird, which are no doubt identical in formation, if not in application, with the classical Oxiani, Oxii, and Oxi-Petra. The classical names have long ceased to be known to the inhabitants of the country. In early Mohammedan history the river was usually styled Al-Nahr, whence the title Ma wará 'l Nahr, or "beyond the river," which came to be bestowed on a province of Persia lying to the north of the Oxus, and which in modern use has been rendered Transoxiana. In subsequent Mohammedan writings Al-Nahr gives place to Jaihún, corresponding to the Gihon of the Mosaic garden of Eden. And now the river is known by Asiatics as the Amú Daria, a name of which the origin is uncertain.<sup>1</sup>

In the most remote ages to which written history carries us, the regions on both sides of the Oxus were subject to the Persian monarchy. Of their populations Herodotus mentions the Bactrians, Chorasmians, Sogdians, and Saces as contributing their contingents to the armies of the great King Darius. The Oxus figures in Persian romantic history as the limit between Iran and Turan, but the substratum of settled population to the north as well as the south was probably of Iranian lineage. The valley is connected with many early Magian traditions, according to which Zoroaster dwelt at Balkh, where, in the 7th



Sketch Map of the Oxus.

century B.C., his proselytizing efforts first came into operation. Buddhism eventually spread widely over the Oxus countries, and almost entirely displaced the religion of Zoroaster in its very cradle. The Chinese traveller Hwen Tsang, who passed through the country in 630-644 A.D., found Termodh, Khulm, Balkh, and above all Bamián, amply provided with monasteries, stirpae, and

colossal images, which are the striking characteristics of prevalent Buddhism; even the Pamir highlands had their monasteries.

Christianity penetrated to Khorásán and Bactria at an early date; episcopal sees are said to have existed at Merv and Samarkand in the 4th and 5th centuries, and Cosmas (c. 545) testifies to the spread of Christianity among the Bactrians and Huns.

Bactria was long a province of the empire which Alexander the Great left to his successors, but the Greek historians give very little information of the Oxus basin and its inhabitants. About 250 B.C. Theodotus, the "governor of the thousand cities of Bactria," declared himself king, simultaneously with the revolt of Arsaces which laid the foundation of the Parthian monarchy. The Greco-Bactrian dominion was overwhelmed entirely about 126 B.C. by the Yüéchi, a numerous people of Tibet who had been driven westwards from their settlements on the borders of China by the Hiongnu, the Huns of Deguignes. From the Yüéchi arose, about the Christian era, the great Indo-Scythian dominion which extended across the Hindú Kúsh southwards, over Afghanistan and Sind. The history of the next five centuries is a blank. In 571 the Haiáthalah of the Oxus, who are supposed to be descendants of the Yüéchi, were shattered by an invasion of the Turkish khakan; and in the following century the Chinese pilgrim Hwen Tsang found the former empire of the Haiáthalah broken up into a great number of small states, all acknowledging the supremacy of the Turkish khakan, and several having names identical with those which still exist. The whole group of states he calls Tukhára, by which name in the form Tokháristan, or by that of Haiáthalah, the country continued for centuries to be known to the Mohammedans. At the time of his pilgrimage Chinese influence had passed into Tokháristan and Transoxiana. Yasdegird, the last of the Sasanian kings of Bokhara, who died in 651, when defeated and hard pressed by the Saracens, invoked the aid of China; the Chinese emperor, Taitsung, issued an edict organizing the whole country from Ferghana to the borders of Persia into three Chinese administrative districts, with 126 military cantonments, an organization which, however, probably only existed on paper.

In 711-12 Mohammedan troops were conducted by Kotaiba, the governor of Khorásán, into the province of Khwárizm (Khiva), after subjugating which they advanced on Bokhara and Samarkand, the ancient Sogdiana, and are said to have even reached Ferghana and Kashgar, but no occupation then ensued. In 1016-25 the government of Khwárizm was bestowed by Sultan Mahmud of Ghazni upon Altúnash, one of his most distinguished generals.

Tokháristan in general formed a part successively of the empire or the Sasanian dynasty of Bokhara (terminated 999 A.D.), of the Gharnavi dynasty, of the Seljukian princes of Persia and of Khorásán, of the Ghori or Shansabany kings, and of the sultans of Khwárizm. The last dynasty ended with Sultan Jalal-ud-din, during whose reign (1221-31) a division of the Moghul army of Jenghis Khan first invaded Khwárizm, while the khan himself was besieging Bamián; Jalal-ud-din, deserted by most of his troops, retired to Ghazni, where he was pursued by Jenghis Khan, and again retreating towards Hindustan was overtaken and driven across the Indus.

The commencement of the 16th century was marked by the rise of the Uzbek rule in Turkestan. The Uzbeks were no one race, but an aggregation of fragments from Turks, Mongols, and all the great tribes constituting the hosts of Jenghis and Batu. They held Kúndú, Balkh, Khwárizm, and Khorásán, and for a time Badakhshán also; but Badakhshán was soon won by the emperor Baber, and in 1529 was bestowed on his cousin Suliman, who by 1555 had established his rule over much of the region between the Oxus and the Hindú Kúsh. The Moghul emperors of India occasionally interfered in these provinces, notably Shah Jehan in 1646; but, finding the difficulty of maintaining so distant a frontier, they abandoned it to the Uzbek princes. About 1765 the wazir of Ahmed Shah Abdali of Cabul invaded Badakhshán, and from that time until now the domination of the countries on the south bank of the Oxus from Wakhan to Balkh has been a matter of frequent struggles between Afghans and Uzbeks.

The Uzbek rule in Turkestan has during the last twenty years been rapidly dwindling before the growth of Russian power. In 1863 Russia invaded the Khokand territory, taking in rapid succession the cities of Turkestan, Chemkend and Taashkend. In 1866 Khojend was taken, the power of Khokand was completely crushed, a portion was incorporated in the new Russian province of Turkestan, while the remainder was left to be administered by a native chief almost as a Russian feudatory; the same year the Bokharians were defeated at Irdjar. In 1867 an army assembled by the amir of Bokhara was attacked and dispersed by the Russians, who in 1868 entered Samarkand, and became virtually rulers of Bokhara. In 1878 Khiva was invaded, and as much of the khanate as lay on the right bank of the Oxus was incorporated into the Russian empire, a portion being afterwards made over to Bokhara. Russia acquired the right of the free navigation of the Oxus throughout its entire course, on the borders of both Khiva and Bokhara. The administration of the whole of the states on the right bank of the Oxus, down to the Russian boundary line at Ichka

<sup>1</sup> Natives of western India hold that it implies "mother" of rivers, in correlation with Abi-sán or "father of rivers," a title which is frequently given to its great southern neighbour, the river Indus.

Yar, is now in the hands of Bokhara, including Karategin—which the Russians have transferred to it from Khokand—and Darwáz at the entrance to the Pamir highlands. At the present time the states on the left bank of the Oxus, from its sources in the Panjah river down to the town and ferry of Khwájá Saleh, are mainly subject to Afghanistan; from Khwájá Saleh to the frontiers of Khiva and Russia at Ichka Yar the left bank of the Oxus is subject to Bokhara; from the same point the Afghan boundary is supposed to stretch across the Dasht-i-chul plains of the Turkomans, above Maimána, to Sarakhs, where it meets the Persian frontier.

The regions in which the Oxus takes its birth, and through which it passes until it becomes lost in the Sea of Aral, may be divided into upper, middle, and lower; the upper is constituted by the highlands between the Thián Shán and the Hindú Kúsh ranges, and the middle by the plains and uplands which are situated in the broad valley between the western prolongations of the same ranges; the lower lies in the plains of western Turkestan. Descriptions of the chief provinces and states in the middle and lower regions will be found under AFGHAN TURKESTAN (vol. i. p. 241), including the eastern khanates of Kúndúz, Zhúlím, Balkh, and Akcha, and the Chahár Wiláyat, or Four Domains, viz., the western khanates of Sir-i-púl, Shibrghán, Andkhú, and Maimána; also under BADAKHSHÁN, KARATEGIN, HISSAR, BOKHARA, and KHIVA; accounts have also been already given of BACTRIA, BALKH, and BAMIÁN. Here we shall only treat of the highland regions of the Oxus, and the river itself in its downward course to the Sea of Aral, postponing all other matter to the article TURKESTAN (see also the map of Turkestan).

For a right understanding of the highland region, notice must be taken of its position relatively to the two great longitudinal systems of mountains, the Thián Shán and the Indian Caucasus, and their respective prolongations east and west, which form such a prominent feature in the physical geography of the continent of Asia. These mountain systems include between them a belt of tablelands of varying breadth, and generally of considerable altitude. The forces of nature by which both the mountains and the intermediate tablelands were primarily evolved from the earth's crust appear to have acted concurrently over the entire region, but with greatest elevating effect along the northern edge of the Caucasus; for, though the highest peaks of the Hindú Kúsh and the Himalayan ranges are more frequently met with on spurs some distance to the south than on the northern water-parting, the elevated masses are here of greatest magnitude; here there are mountains whose peaks rise to great altitudes above the sea-level, but which are comparatively insignificant differentially, the visible height above the surrounding tablelands being rarely more than a third, and often less than a tenth, of the height above the sea; and here there are passes across great ranges of which the level is barely distinguishable from that of the surrounding tablelands, so that the traveller may cross a great water-parting without being aware of it, a tussock of grass deciding the course of the waters, whether towards the frontiers of China or of Europe or towards the Indian Ocean.

The elevated mass which forms a bridge between the Thián Shán and the Hindu Caucasus, in the quarter where they approach each other most closely, constitutes the governing geographical and political feature of these regions, and gives birth to all the principal sources of the Oxus. A happy instinct has led the inhabitants to call it the Bam-i-dúnía, or Roof of the World; modern European geographers have called it the "heart of Asia," the "central boss of Asia." It is the Tsungling of Chinese writers, the northern Imaus of Ptolemy, the Mountain Parnassus of Aristotle, "the greatest of all that exist toward the winter sunrise." The geographical indications of the Puranas, considered in any but a fabulous light,

point to it as Méru, the scene of the primeval Aryan paradise. Old Parsi traditions point to it as the origin and nucleus of the Aryan migrations. And it is here that the Mohammedan invaders are shown, by their identification of the great rivers with the Gihon and Pison of the Mosaic narrative, to have believed that the terrestrial paradise, the cradle of the human race, was situated.

Few regions can present claims to interest and just curiosity so strong and various as this one. Its past history is interwoven with that of all the great Asiatic conquerors, and its position on the rapidly narrowing borderland between the British and the Russian dominions gives it additional interest at the present time. But its geography is most intricate and complicated, and has long been a fruitful subject of controversy. The region is intersected with mountain ridges and depressed river beds which are alike difficult to cross; its altitude is unfavourable for the growth of cereals, and it mostly lies buried in snow for half the year; it is, moreover, sparsely inhabited, and does not produce sufficient food for the requirements of the inhabitants. It interposes a formidable barrier between eastern and western Turkestan across the ancient highway from Europe to China; and, though this barrier has been repeatedly crossed, the extant narratives of the journeys and descriptions of the routes present only occasional glimmerings of truth amidst a mass of error and confusion, and are at times barely available for sober inquiry; genuine facts of observation have been so mixed up with erroneous information that it has become impossible to reconcile conflicting statements or separate the true from the false. Thus within the last quarter of a century maps have been published by eminent geographers in England and Germany in which the great cities of eastern Turkestan are placed 3° to 4°, or over 200 miles, too far to the west, and the limits of the "heart of Asia" are materially narrowed.

The interest attaching to the region has even led to the fabrication of spurious documents which have darkened the mist already enveloping it, and have betrayed eminent geographers into error and confusion.<sup>1</sup>

While geography remained under the spell of these mischievous fictions, research was impeded, and an insurmountable obstacle placed in the way of the true delineation of the region; doubt was even thrown on the accuracy of the work of genuine explorers. But within the last decade the mist in which the "Roof of the World" had so long been enveloped has been largely dispelled by the labours of Russian and British officers, and also by natives of India trained to geographical exploration and employed in connexion with the operations of the Great Trigonometrical Survey of India. In some parts there is still much doubt and uncertainty, but enough is now known to furnish the geographical student with a fairly accurate idea of the general course of the rivers and configuration of the tablelands and mountains.

Two systems of rivers give birth to the sources of the

<sup>1</sup> Thus early in the present century certain papers were lodged in the secret archives of the Russian Foreign Office which purported to give an account of two unpublished records of exploration in this obscure region, one by a German traveller, Georg Ludwig von —, said to have been an employé of the Anglo-Indian Government, the other by a Chinese traveller. They were brought to light in 1861, and excited the curiosity of all who were interested in the geography of this region. A few years afterwards it was discovered that a parallel mass of papers, embodying much of the same peculiar geography and nomenclature, but purporting to be the report of a Russian expedition sent through Central Asia to the frontiers of India, existed in the London Foreign Office. All three documents bear indubitable traces of having been fabricated for sale to the British and the Russian Governments by an acute geographer who, while availing himself of such genuine data as were actually within his reach, did not scruple to draw on his own imagination for the filling up of all blanks.

Oxus, one to the north rising in and around the Alai plateau, the other to the south rising in the Pamir plateaus, of which there are several. The two systems are divided by a great chain of mountains known locally as the Kizil-yart range, but called by Fedchenko (looking from the north) the Trans-Alai range, and by recent Russian surveyors the Peter the Great range; it lies from east to west on the southern border of the Alai plateau, and throws out spurs westwards to Darwáz; its medium height above the sea-level is 18,000 or 19,000 feet, with occasional peaks rising to 25,000 feet. Of the Oxianian affluents to its north and west the principal are the Wákhsh or Súrkh-áb (= the Kizil-su = the Red River), rising in the Alai, and the Múksú and Khing-áb rivers, which join the Wákhsh in the district of Karategin.

The system of southern affluents is, however, the most important of the two politically as well as geographically, comprising as it does the water-partings which define the boundaries between China, Afghanistan, and Bokhara, and all the rivers of what is generally known as the Pamir region. The name Pamir is suggested by Bournouf to have been derived from Úpa-Méru, meaning the lands "beyond the mountain of Meru"; a later and more probable suggestion, by Major Trotter, is that it is the Khirgis equivalent of Bám-i-dúnia. It means simply an elevated steppe or plateau. By the people of the country it is not applied, as European geographers apply it, to the entire region, which is one of mountains as well as table-lands, but to each of the plateaus with the addition of a distinctive designation. Thus there is the Pamir-Kalán (great), the Pamir-Khúrd (little), the Pamir-Alichúrd, the Pamir-Khargoshi (of the hare), the Pamir-Sarez (of the water-parting), and the Pamir-Bangkul, on which the Rangkul lake is situated. There is also another, the Pamir-i-Shiva, which, though only recently brought prominently to the notice of European geographers, is of considerable magnitude, elevation, and importance; it lies in that part of Badakhshán which is enclosed to the north and east by the Panjah river, and to the south and west by a spur from the Hindú Kúsh range. This spur is an offshoot from the vicinity of the Trick Mir peak (25,400 feet) north of Chitral; it lies between Faizabad and Ishkashim, sinks to 10,900 feet at the Zebak pass, and then again, ascending to higher altitudes, trends to the north-west, and strikes the western spurs of the Kizil-yart range in the Darwáz district; it forms the water-parting between the Kokcha river of southern Badakhshán and the Panjah river. Though a spur from the main range, it is of itself an important range, and has some claim to be regarded as the western boundary of the Pamir table-lands, as it lies immediately over the Shiva Pamir; if the claim be admitted, the breadth of the elevated barrier between the plains of eastern and western Turkestan will be found to be about 250 miles, whereas geographers have hitherto accorded to the Pamir plateau a breadth of only 100 miles. The Panjah river flows downwards through the region where the spurs of this western bounding range meet those of the Kizil-yart range, passing between narrow and precipitous gorges which form a natural gateway to the highlands, though one which in many parts is barely accessible, or has to be quitted altogether for the easier mountain passes on either hand.

The most elevated portion of the highlands occurs on the north-east border, above the plains of Kashgar and Yarkand. Here a chain of mountains, interwoven with the Thián Shán and the Kizil-yart ranges, trends to the east and south-east, and throws up peaks of great height, culminating in Tagharma (25,500 feet); viewed from the plains to the east, it seems to form part of a great chain—the Beltú Tágh of Humboldt—which connects the Thián Shán range with the Hindú Kúsh; but it is broken

through by rivers, and terminates over the plains of the Sarikol district. The line of water-parting which constitutes the real connexion between the Thián Shán and the Hindú Kúsh lies more to the west, in hills which, emanating from the Kizil-yart range, pass between the Rangkul Pamir and the Kizil-yart plain, and then bending southwards strike an angle of the Hindú Kúsh range on the borders of the Sarikol and Kanjút districts; they are probably nowhere of any great altitude above the general level of the table-lands; but they are of importance in that they may be regarded as the natural boundary between the states of eastern Turkestan now subject to China, and those of western Turkestan subject to Afghanistan and Bokhara.

The best known river of the Pamir plateaus is the Panjah,<sup>1</sup> which receives all the other rivers of this region before it enters the plains; above Kila Panjah it has two important affluents, one from the east rising in Kanjút, and probably about 120 miles long, the other from the north-east rising in the lake of the Great Pamir (Wood's Lake Victoria), and about 80 miles long. From the point of junction to Kila-Bár-Panjah is 140 miles,<sup>2</sup> here the united waters of the Sochá and Shákh dara rivers from the east are received; 33 miles lower down, near Kila Wámar, the Bártang river, also from the east, is received. The upper source of the Bártang is the Ak-sú (white water) river, which rises in the Oikúl or Gazkul lake of Little Pamir, and, winding round the highlands, passes through the Sarez Pamir, where its name changes to the Murghábi (water fowl), which lower down becomes Bártang (narrow passage). The Ak-sú-Bártang is probably the longest of the Pamir rivers; its length exceeds 330 miles, while that of the Panjah from the source of its longest affluent down to the Bártang junction is probably under 300 miles; thus it has been claimed as constituting, rather than the Panjah, the proper boundary line between Afghanistan and Bokhara. About 120 miles below Kila Wámar the Panjah debouches into the plains after receiving the Wanjáb river of Darwáz on its right bank, and the Kof (Kufau) river coming from the Shiva Pamir on its left bank. Fifty miles farther on it receives on its right bank the Yákhst river conveying the waters of a system of valleys lying between the Panjah and the Wákhsh rivers, the courses of which are here nearly parallel; 18 miles onwards it receives (left bank) the Kokcha river of southern Badakhshán, and at this point it loses its individuality and becomes the Amú river; 80 miles to the west the Amú receives the Wákhsh or Súrkh-áb river, when the whole of the waters of the Oxianian highlands are brought together into one channel.

Returning to the highlands, we briefly notice the principal lakes. Chief of all is the Great Kárákul—the Dragon Lake of Chinese writers; it stands in the Khargoshi Pamir, has an area of about 120 square miles, and an altitude of 12,800 feet; it was long regarded as the source of the Oxus, but has recently been found to have no outlet. The Little Kárákul and the Búlankúl lakes, areas 15 and 8 square miles, on the Kizil-yart plateau, are probably over 13,000 feet. The Rangkul lake, area 15 square miles, is 12,800 feet. Wood's Victoria, the lake of the Great Pamir, height 13,900 feet, has an area of 25

<sup>1</sup> The name Panjah is conjectured to be derived from a confluence of five rivers; but more probably it is taken from the well-known fort of the same name, which is situated a little below the junction of the two upper affluents of the river. The fort derives its name either from the circumstance of its being built on five mounds, or from a sacred edifice in the vicinity erected over a stone bearing the supposed impress of the palm and fingers (panjah) of Hazrat Ali, the son-in-law of Mohammed; lower down the river, in Shighnan, there is a fort built over a similar mark and called the Kila-Bár-Panjah ("the fort over the panjah").



square miles. The *Yashil-Kúl*, area 16 square miles, height 12,550 feet, is in the *Alichúr Pamir*, where in 1759 the Chinese troops surprised and defeated the *Khawjas* of *Badakhán*. The great *Shiva-Kúl*, lately visited by *Dr Regel*, has, according to him, an area exceeding 100 square miles, and an altitude of 11,800 feet, and *Wood* alludes to it as of considerable magnitude. There are numerous small lakes, of which the most important is the *Oikul* (13,100 feet), the source of the *Ak-sú* river, in the *Little Pamir*.

Hill ranges crop up out of the table-lands in various quarters; their general direction is from north-east to south-west; they form the boundaries between the several *Pamirs* and the principal water-partings between the valleys. The portion of the *Hindú Kúsh* range which lies immediately to the south of this region is of very varying altitude, sinking at the *Baroghil* pass to 12,000 feet, or only 1000 feet above the adjoining table-lands, but rising to heights of 22,600 to 25,400 in peaks to the west of that pass.

In 1872 the *Panjah* river was adopted by the British and the Russian Governments as the line of boundary between *Bokhara* and *Afghanistan*. But rivers which are readily crossed, and pass through valleys both sides of which have much of life in common, rarely serve as boundaries between the people residing on the opposite banks. The *Panjah* river has been found to divide no less than four states, *Wákhán*, *Shighnán*, *Roshán*, and *Darwáz*, into two parts each; the first three of these are claimed by *Afghanistan* and the fourth by *Bokhara*, by whom they are administered—or at least are attempted to be administered—without regard to the conventional boundary line of the *Panjah*; presumably, therefore, this line will have to be abandoned for the lines of water-parting along the hill ranges which form the natural boundaries of the several states.

The *Pamir* plateaus are generally covered with a rich soil which affords very sweet and nourishing grasses, though at too great an altitude for husbandry; there is an unlimited extent of summer pasture lands for the *Khingis* and other nomad tribes and the herdsmen of the surrounding districts. But for the plentiful supply of food for cattle which these regions afford during several months of the year, they could never have been crossed by the great armies and hordes which are said to have passed over them. The culturable areas are small, and are usually restricted to narrow ledges on the margins of the rivers, which, however, when well cultivated and manured yield rich returns; food stuffs have to be largely obtained from the plains below; mulberry trees thrive well and are much prized, because their unripened berries are ground to flour and form a serviceable article of food.

*Wákhán* contains some twenty-five scattered villages with about as many houses in each, and a population estimated at 3000 souls. *Shighnán* and *Roshán* may at present be regarded as one state, as they are governed by one ruler; the valleys of *Sochán-o-Gúnd* and *Shakhdara* belong to the former, and that of *Bártang* to the latter (villages, 234; houses, 4477; souls, 22,000). *Darwáz* is famous for its difficult roads, called "averings," which are carried along the faces of perpendicular precipices, on planks resting on iron bolts driven into the rock; the roads are, however, said to be much improved since the state came under *Bokhara*. *Darwáz* extends over the valley of the *Khingáb* river to the north as well as over the valley of the lower *Panjah*. It has three *amlakdarates* on the *Khingáb*—Upper *Wakhia*, Lower *Wakhia*, and *Khulás*—and one, *Sagridasht*, on an affluent of the *Khingáb*, containing 84 villages with 2458 habitations; it has also three subdivisions on the *Panjah*—south-eastern or

upper *Darwáz* terminating at *Kila Khúm*, south-western *Darwáz* terminating at *Zigor*, and lower *Darwáz*—which contain 31 villages with 896 habitations on the right bank, including those of the *Wanjáb* affluent, and 45 villages with 1379 habitations on the left bank, including those of the *Kufan* river, which comes from the *Shiva Pamir*.

Russian officers have found that at the point where the *Panjah* enters the plains the level is about 1800 feet above the mean sea, or 12,100 feet below the sources of the river in *Lake Victoria*; 50 miles lower down, at the junction with the *Kokcha*, where the *Panjah* merges into the *Amú Daria*, the height is given as 1000 feet; at *Kilif* (214 miles) it is 730 feet; and at *Chahárjúi* (203 miles), 510 feet,—thence the length of the course of the river to the *Sea of Aral* is somewhat over 500 miles. The *Aral* is 158 feet above the mean sea-level. Thus the average slope of the *Amú* is about 14 inches in the mile above and 8 inches below *Chahárjúi*. The river has been reported to be navigable for steamers up to the junction with the *Wákhsh* or *Surkháb*; and in 1878 a Russian steamer ascended it up to *Khwája Sáleh*, at the junction of the boundaries of *Bokhara* and *Afghanistan*.

The testimony of antiquity is almost unanimous in representing the *Oxus* as having once flowed into the *Caspian Sea*. *Herodotus* asserts that in his day the *Jaxartes* also entered the *Caspian*, but this statement is so highly improbable that it throws much doubt on his geographical accuracy as regards these regions. Greek historians also mention a river *Ochus* to the south of the *Oxus*, flowing towards the *Caspian*, into which it is supposed to have fallen either directly or after joining a branch of the *Oxus*; *Strabo* says that both this river and the *Oxus* were crossed by *Alexander* in marching from *Samarkand* to *Merv*. Maps recently published by both English and Russian geographers show the supposed ancient beds of the two rivers in the *Turkmani* deserts, the *Oxus* flowing southwards from the province of *Khiva* and joining the *Caspian* below the *Balkhan Bay*, the *Ochus* flowing from east to west in a lower latitude, and possibly striking the *Oxus* before it turns towards the *Caspian*. The first is called the old *Oxus* in English and the *Uzboi* in Russian maps; the second is called the *Ongús* in Russian and the *Chahárjúi* in English maps, and is sometimes drawn as if it had been a bifurcation from the *Oxus* at some point near *Chahárjúi*. But the recent explorations of the Russian engineer *Leszar* have shown that what hitherto has been taken for the dry bed of the *Ochus* is not the bed of a river, but merely a natural furrow between sand-hills, that it cannot be the continuation either of a river from the east bifurcating from the upper *Oxus* or of the *Tejend* river from the south as has been supposed, and also that it does not join the *Uzboi*, but ceases at a distance of fully 60 miles from the ancient bed of that river. Thus the bed of the *Ochus* has still to be discovered.

As regards the *Oxus*, some eminent geographers are of opinion that it has disembogued into the *Aral Sea* from time immemorial as at this day; other geographers of equal weight have asserted that the *Aral* has fluctuated at different periods of history between the condition of a great inland sea and that of a reedy marsh, according to the varying course of its two feeders the *Jaxartes* and the *Oxus*. Now the position and height of the head of the delta of the *Oxus* relatively to the *Aral* and the *Caspian Seas* are such that comparatively slight changes in the relations of the river to its banks and bed would readily divert its course from one sea to the other. *Khwája-ili*, at the head of the delta, is 217 feet above the mean sea; the *Aral* is 158 feet above and the *Caspian* 85 feet below the mean sea. The length of channel from *Khwája-ili* to the *Aral* is 110 miles, with a fall of 59 feet, or about 6 inches

in the mile; the length of channel from the town of Urganj near Khwaja-ili to the Caspian is about 600 miles, with a fall of (say) 300 feet, or also about 6 inches to the mile. Thus the degree of slope is much the same in both directions, and consequently the blocking of the channel towards one sea—either naturally as by an accidental deposit of silt, or artificially by the construction of dams for the diversion of the river—would most probably be soon followed by a flow of water towards the other sea. The writings of Strabo, Pliny, and Ptolemy indicate that from 500 A.C. to 600 A.D. the Oxus flowed into the Caspian. About 605 a great change is said to have taken place, which turned the full stream of the Oxus into the Aral. In subsequent years dams were constructed for irrigation purposes which prevented the stream from reverting to the Caspian. In 1221, during the siege of Urganj by the Turks, the dams were purposely broken down, and the stream was allowed to find its way back to the Uzboi, which had been deserted for several centuries. But by 1643 the Oxus is said to have been again debouching into the Aral, as at the present time.

*Authorities.*—Colonel Yule's "Essay" in Wood's *Oxus*, 2d ed.; Id., "Papers connected with the Upper Oxus Regions," in *Jour. Roy. Geog. Soc.*, xlii.; Sir Henry Rawlinson, *England and Russia in the East*; Id., Review of Yale's "Marco Polo," in *Edin. Rev.*, January 1873; Id., "Monograph on the Oxus," in *Jour. Roy. Geog. Soc.*, xiii.; Id., "Notes on the Oxus," in *Proc. Roy. Geog. Soc.*, xx.; Id., "Road to Merv," in *Proc. Roy. Geog. Soc.*, March 1879; Fin, *Mahomedan History*; Lenz, *Ancient Course of the Amudaria*, translated from German by C. G.; Arendarenko, *Darvuds and Karataghin*, translated from Russian *Military Journal* by E. M.; General Walker, *Map of Turkistan*, 4th ed., 1883; "The Russian Pamir Expedition," in *Proc. Roy. Geog. Soc.*, March 1884. (J. T. W.)

OXYGEN. See CHEMISTRY, vol. v. p. 479 sq.

OXYHYDROGEN FLAME. Hydrogen gas readily burns in oxygen or air with formation of vapour of water. The quantity of heat evolved, according to Thomsen, amounts to 34116 units for every unit of weight of hydrogen burned, which means that, supposing the two gases were originally at the temperature of, say, 0° C., to bring the hot steam produced into the condition of liquid water of 0° C., we must withdraw from it a quantity of heat equal to that necessary to raise 34116 units of weight of liquid water from 0° to 1° C. This heat-disturbance is quite independent of the particular mode in which the process is conducted; it is the same, for instance, whether pure oxygen or air be used as a reagent, being neither more or less than the balance of energy between 1 part of hydrogen plus 8 parts of oxygen on the one hand and 9 parts of liquid water on the other. The temperature of the flame, on the other hand, does depend on the circumstances under which the process takes place. It obviously attains its maximum in the case of the firing of pure "oxyhydrogen" gas (we mean a mixture of hydrogen with exactly half its volume of oxygen, the quantity it combines with in becoming water). It becomes less when the "oxyhydrogen" is mixed with excess of one or the other of the two co-reagents or an inert gas such as nitrogen, because in any such case the same amount of heat spreads over a larger quantity of matter. To calculate the "calorific effect," we may assume that, in any case, for every 1 grain of hydrogen burned  $9 \times 637 = 5733$  units of heat are spent in the conversion of the 9 grains of liquid water (theoretically imagined to be) produced into steam of 100° C., and that only the rest of  $34116 - 5733 = 28383$  units is available for heating up the products of combustion. Now the specific heat of steam (from 120 to 220° C.) has been found to be equal to 0.4805 units; hence, on the basis of certain obvious (but bold) assumptions, in the firing of 9 grains of oxyhydrogen gas, as every  $9 \times 0.4805$  units of heat correspond to an

increase of 1° C. in temperature, the temperature of the flame should be by  $28383 \div 9$  times 0.4805 (or 6664° C.) higher than 100°, or equal to 6664° C.

Let us now consider the case of 1 grain of hydrogen mixed with the quantity of air containing 8 grains of oxygen, i.e., the case of 1 grain hydrogen mixed with 8 grains of oxygen and 26.78 grains of nitrogen. Here the temperature  $t$  of the flame will be governed by the equation,  $28383 = (t - 100) \times 9 \times 0.4805 + t \times 26.78 \times 0.2438$ , —the last coefficient being the specific heat of nitrogen. Thus  $t = 2655$ ° C., as against the 6664° obtained with pure oxygen. But one of our tacit assumptions is obviously untenable; ready-made vapour of water, if subjected to even the less of the two temperatures, would suffer far-going dissociation involving an absorption of heat and consequently a depression of temperature. Hence supposing a mass of oxyhydrogen gas to have been kindled, as soon as the temperature has passed a certain point the progress of the process of combination will be checked by that of the corresponding dissociation, which latter, as the combustion progresses, will go on at a greater and greater rate, or until it just compensates the effect of the process of combination. That is to say, as soon as through the combustion of a certain fraction of the oxyhydrogen a certain temperature (far less than 6664° C.) has been produced, there is no further increase of temperature, and the uncombined gas-residue would remain unchanged, if it were not for the practically unavoidable loss of heat by radiation and conduction, which enables it to become water.

This interesting matter was inquired into experimentally by Bunsen. He exploded fulminating gas mixtures in a close vessel constructed so that the maximum tension attained by the gas-contents during the combustion could be observed and measured, and from this value and the analytical data he calculated the maximum temperature and the proportion of gas-mixture which had assumed the form of a chemical compound at the moment when the maximum temperature prevailed. He found (a) for the case of pure oxyhydrogen gas—maximum temperature = 2844° C., fraction of burned gas at the respective moment 0.337; (b) for the case of a mixture of 1 volume of oxygen, 2 volumes of hydrogen, and 3.78 of nitrogen (very nearly the same as one volume of oxygen in the shape of air)—maximum temperature = 2024° C., burned gas corresponding = 0.547 of the potential water. Hence we see that the temperature of a pure oxyhydrogen flame is not so much above that produced in the combustion of hydrogen by air as we should have concluded from our calculations. But, whatever the exact numerical value may be, it has long been known that the calorific effect of an oxyhydrogen flame exceeds that of any furnace, and the effect has long been put to practical use in the oxyhydrogen lamp.

The most efficient form of this instrument is that which was given to it long ago by Newman, who pumps pure oxyhydrogen into a strong copper reservoir under 2 to 3 atmospheres' pressure lets the gas stream out of a narrow nozzle, and kindles it. The nozzle in the original apparatus consisted of a glass tube about 4 inches long and of  $\frac{1}{8}$ -inch bore. Newman worked long with this apparatus without any accident occurring; but when he once came to substitute a tube of  $\frac{1}{8}$ -inch bore the flame travelled back and the apparatus burst like a bomb-shell. Of the many safety arrangements suggested we will mention only that of Hare, who inserts a plug of (microscopically) porous copper between reservoir and nozzle, and forces the gas through this plug by applying a sufficient pressure. The plug of course acts on the principle of the Davy lamp, and offers protection as long as it has not got heated. But it may get hot without the operator noticing it, and probably has done so occasionally. At any rate, the use of ready mixed oxyhydrogen has long been given up in favour of the very oldest form of lamp, which was invented, before Newman's, by Hare. Hare's lamp, in all essential points, is our present gas-blowpipe as used for glass-blowing. The fuel (hydrogen, or coal-gas, which works as well) streams out of the annular space between two co-

aria tubes, while oxygen is being blown into the hydrogen flame through the central tube. The calorific effect of a Hare's lamp is of course less than that of Newman's, but still exceeds that of any ordinary fire; it is inferior only to that of the electric arc. Platinum fuses in the flame with facility, and silica and alumina (though absolutely infusible in the metallurgist's sense) run into viscid glasses. Notwithstanding its enormous temperature, an oxyhydrogen flame emits only a feeble light; but this arises only from the absence in it of good radiators. We need only communicate its high temperature to some non-volatile and infusible solid, and a considerable portion of the heat is converted into radiant energy which streams forth as a dazzling white light. In the oxyhydrogen lamp as used in connexion with the magic lantern or the "solar" microscope, a bit of lime fixed to an upright wire serves as a radiator. Magnesia is said to be better, and it has been said that zirconia excels both. Now that the electric light is coming into general use, the oxyhydrogen lamp as a source of light will soon be a thing of the past. It is sure, however, to survive as a powerful producer of intense heat, and not for scientific purposes only. Thanks to the pioneering activity of Deville and Debray, it has found its way into the platinum works, and will hold its ground there until it may be superseded by the electric arc. The soldering together of the several parts of a platinum apparatus is now done "autogenically" (i.e., without the interposition of any foreign "soldar") by means of the oxyhydrogen blowpipe,—a great improvement over the old process of soldering with gold, which stripped the platinum-work of its most valuable character, namely, its relative infusibility. (W. D.)

OXYNOTUS, the name of a genus of birds now ascertained to be peculiar to two of the Mascarene Islands—Mauritius and Réunion (Bourbon)—where the name of *Cuisinier* is applied to them, and remarkable for the fact, almost if not quite unique in Ornithology,<sup>1</sup> that, while the males of both species are almost identical in appearance, the females are wholly unlike each other. Though the habits of the Mauritian species, *O. rufiventris*, have been very fairly observed, there seems to be nothing in them that might account for the peculiarity. The genus *Oxynotus* is generally placed in the group known as *Campophagidae*, most or all of which are distinguished from the *Laniidae* (to which they seem nearly allied) by the feathers on the lower part of the back and on the rump having the basal portion of the shaft very stiff and the distal portion soft—a structure which makes that part of the body, on being touched by the finger, feel as though it were beset with blunt prickles. Hence the name of the genus conferred by Swainson, and intended to signify "prickly back." The males, which look rather like miniature Grey Shrikes (*Lanius excubitor* and others), are—except on close examination, when some slight differences of build and shade become discernible—quite indistinguishable; but the female of the one species has a reddish-brown back, and is bright ferruginous beneath, while the female of the other species is dull white beneath, transversely barred, as are the females of some Shrikes, with brown. Both sexes of each species, and the young of one of them, are described and figured in *The Ibis* for 1866 (pp. 275-280, pls. vii. and viii.). (A. N.)

OYER AND TERMINER, in English law, is one of the commissions by which a judge of assize sits (see ASSIZE). By the commission of oyer and terminer the commissioners (in practice the judges of assize, though other persons are named with them in the commission) are commanded to make diligent inquiry into all treasons, felonies, and misdemeanours whatever committed in the counties specified in the commission, and to hear and determine the same according to law. The inquiry is by means of the grand jury; after the grand jury has found the bills submitted to it, the commissioners proceed to hear and determine (oyer and terminer) by means of the petty jury. The words oyer and terminer are also used to

denote the court which has jurisdiction to try offences within the limits to which the commission of oyer and terminer extends.

By 7 Anne c. 21 the crown has power to issue commissions of oyer and terminer in Scotland for the trial of treason and misprision of treason. Three of the lords of judiciary must be in any such commission. An indictment for either of the offences mentioned may be removed by certiorari from the court of oyer and terminer into the court of judiciary.

In the United States oyer and terminer is the name given to courts of criminal jurisdiction in some States, e.g., New York, New Jersey, Pennsylvania, and Georgia.

OYSTER. The use of this name in the vernacular is equivalent to that of *Ostrea* in zoological nomenclature; there are no genera so similar to *Ostrea* as to be confounded with it in ordinary language. *Ostrea* is a genus of Lamellibranch Mollusca, belonging to the third order *Monomya*, the valves of its shell being closed by a single large adductor muscle. The degeneration produced by sedentary habits in all lamellibranchs has in the oyster reached its most advanced stage. The muscular projection of the ventral surface called the foot, whose various modifications characterize the different classes of *Mollusca*, is almost entirely aborted. The two valves of the shell are unequal in size, and of different shape; the left valve is larger, thicker, and more convex, and on it the animal rests in its natural state. This valve, in the young oyster, is attached to some object on the sea-bottom; in the adult it is sometimes attached, sometimes free. The right valve is flat, and smaller and thinner than the left. In a corresponding manner the right side of the animal's body is somewhat less developed than the left, and to this extent there is a departure from the bilateral symmetry characteristic of lamellibranchs.

The organization of the oyster, as compared with that of a typical lamellibranch such as *Anodon* (see MOLLUSCA), is brought about by the reduction of the anterior part of the body accompanying the loss of the anterior adductor, and the enlargement of the posterior region. The pedal ganglia and auditory organs have disappeared with the foot, at all events have never been detected; the labial ganglia are very minute, while the parieto-splanchnic are well developed, and constitute the principal part of the nervous system.

According to Spengel the pair of ganglia near the mouth, variously called labial or cerebral, represent the cerebral pair and pleural pair of a gastropod combined, and the parieto-splanchnic pair correspond to the visceral ganglia, the commissure which connects them with the cerebro-pleural representing the visceral commissure. Each of the visceral ganglia is connected or combined with an olfactory ganglion underlying an area of specialized epithelium, which constitutes the olfactory organ, the osphradium. This view (which, it may be pointed out, differs from that given under MOLLUSCA) alone admits of a satisfactory comparison between the lamellibranch and the gastropod; if the parieto-splanchnic were merely an olfactory ganglion its connexion by a commissure with its fellow would be an abnormality, and the olfactory ganglion in the lamellibranch would innervate the gills, adductor muscle, mantle, and rectum, parts which in gastropods are innervated from the visceral ganglia. The heart and pericardial chamber in the oyster lie along the anterior face of the adductor muscle, almost perpendicular to the direction of the gills, with which in *Anodon* they are parallel. In *Anodon* and the majority of lamellibranchs the ventricle surrounds the intestine; in the oyster the two are quite independent, the intestine passing above the pericardium. The renal organs of the oyster were discovered by Hoek to agree in their morphological relations with those of other lamellibranchs.

<sup>1</sup> The only other instance cited by Darwin (*Descent of Man*, ii. pp. 192, 193) is that of two species of *Paradisea*; but therein the males differ from one another to a far greater degree than do those of *Oxynotus*.

The generative organs of the oyster consist of a system of branching cavities on each side of the body lying immediately beneath the surface. All the cavities of a side are ultimately in communication with an efferent duct opening on the surface of the body a little above the line of attachment of the gills. The genital opening on each side is situated in a depression of the surface into which the renal organ also opens. The genital products are derived from the cells which line the cavities of the genital organs. The researches of Hoek have shown that in the same oyster the genital organs at one time produce ova, at another spermatozoa, and that consequently the oyster does not fertilize itself. How many times the alternation of sex may take place in a season is not known. It must be borne in mind that in what follows the species of the European coast, *Ostrea edulis*, is under consideration. The ova are fertilized in the genital duct, and before their escape have undergone the earliest stages of segmentation. After escaping from the genital aperture they find their way into the infra-branchial part of the mantle cavity of the parent, probably by passing through the supra-branchial chamber to the posterior extremity of the gills, and then being conducted by the inhalent current caused by the cilia of the gills into the infra-branchial chamber. In the latter they accumulate, being held together and fastened to the gills by a white viscid secretion. The mass of ova thus contained in the oyster is spoken of by oyster fishers as "white spat," and an oyster containing them is said to be "sick." While in this position the ova go through the series of changes figured in vol. xvi. p. 638 (fig. 6). At the end of a fortnight the white spat has become dark-coloured from the appearance of coloured patches in the developing embryos. The embryos having then reached the condition of "trochospheres" escape from the mantle cavity and swim about freely near the surface of the water among the multitude of other creatures, larval and adult, which swarm there. The larvae are extremely minute, about  $\frac{1}{16}$  inch long and of glassy transparency, except in one or two spots which are dark brown. From the trochosphere stage the free larvae pass into that of "veligers." How long they remain free is not known; Prof. Huxley kept them in a glass vessel in this condition for a week. Ultimately they sink to the bottom and fix themselves to shells, stones, or other objects, and rapidly take on the appearance of minute oysters, forming white disks  $\frac{1}{16}$  inch in diameter. The appearance of these minute oysters constitutes what the fishermen call a "fall of spat." The experiment by which Hoek conclusively proved the change of sex in the oyster was as follows. In an oyster containing white spat microscopic examination of the genital organs shows nothing but a few unexpelled ova. An oyster in this condition was kept in an aquarium by itself for a fortnight, and after that period its genital organs were found to contain multitudes of spermatozoa in all stages of development.

The breeding season of the European oyster lasts from May to September. The rate of growth of the young oyster is, roughly speaking, an inch of diameter in a year, but after it has attained a breadth of 3 inches its growth is much slower. Prof. Möbius is of opinion that oysters over twenty years of age are rare, and that most of the adult Schlesswig oysters are seven to ten years old.

The development of the American oyster, *O. virginiana*, and of the Portuguese oyster, *O. angulata*, is very similar to that of *O. edulis*, except that there is no period of incubation within the mantle cavity of the parent in the case of these two species. Hence it is that so-called artificial fertilization is possible; that is to say, the fertilization may be allowed to take place in a tank or aquarium in which the conditions are under control. But if it is possible to procure a supply of spat from the American oyster by keeping the swarms of larvae in confinement, it ought to be pos-

sible in the case of the European oyster. All that would be necessary would be to take a number of mature oysters containing white spat and lay them down in tanks till the larvae escape. This would be merely carrying oyster culture a step further back, and instead of collecting the newly fixed oysters, to obtain the free larvae in numbers and so insure a fall of spat independently of the uncertainty of natural conditions.

Natural beds of oyster occur on stony and shelly bottoms at depths varying from 3 to 20 fathoms. In nature the beds are liable to variations, and, although Prof. Huxley is somewhat sceptical on this point, it seems that they are easily brought into an unproductive condition by over-dredging. Oysters do not flourish in water containing less than 3 per cent. salt; and hence they are absent from the Baltic. The chief enemies of oysters are the dog-whelk, *Purpura lapillus*, and the whelk-tingle, *Murex urinaceus*, which bore through the shell's. Starfishes swallow oysters whole. *Ciona*, the boring sponge, destroys the shells and so injures the oyster; the boring annelid *Leucodora* also excavates the shell.

The wandering life of the larvae makes it uncertain whether any of the progeny of a given oyster-bed will settle within its area and so keep up its numbers. It is known from the history of the Laimford beds that the larvae may settle 5 miles from their place of birth.

The genus *Ostrea* has a world-wide distribution, in tropical and temperate seas; seventy species have been distinguished. Its nearest allies are *Anomia* among living forms, *Crypsinus* among fossils. For the so-called Pearl-Oyster see PEARL. (J. T. C.)

### Oyster Industry.

The oyster industry of the world is seated chiefly in the United States and France. Great Britain has still a few natural beds remaining, and a number of well-conducted establishments for oyster culture. Canada, Holland, Italy, Germany, Belgium, Spain, Portugal, Denmark, Norway, and Russia have also oyster industries, which are comparatively insignificant, and in the case of the two countries last named, hardly worthy of consideration in a statistical statement. Recent and accurate statistics are lacking except in two or three instances. A brief review by countries in the order of their importance is here presented.

**United States.**—This is by far the most extensive of the fishery industries of the country, yielding products three times as valuable as those of the cod fishery and six times those of the whale fishery. In 1880 it employed 52,805 persons, and yielded 22,195,370 bushels, worth to the fishermen \$9,084,861. On 13,047,922 bushels there is a rise of value in passing from producers to market, which amounts to \$4,368,991, and results either from replanting or from packing in tin cans. The value of the capital invested in the industry is returned as \$10,583,295. There are employed 4155 vessels, valued at \$3,528,700, and 11,930 boats. The actual fishermen number 38,249, the shoremen 14,556. Fully 80 per cent. of the total yield is obtained from the waters of Chesapeake Bay.<sup>1</sup>

**France.**—The oyster industry of France employed in 1881 29,431 men, women, and children in the parks, beds, and preserves. The number of such establishments upon the public domain was 22,364, with an area of 19,891 acres, and 970 establishments upon private property, with an area of 926 acres. From these 374,985,770 oysters were dredged during the season of 1880-81, from September 1 to June 15, worth 3,061,763 francs, while the total number of oysters disposed of during this period amounted to 680,372,750, worth 17,951,114 francs. This total includes the oysters dredged in the sea as well as those gathered from the artificial breeding-grounds or parks.

**Great Britain.**—A brief discussion of the British oyster fisheries may be found under FISHERIES, vol. ix. p. 265. A recent estimate<sup>2</sup> gives the total value of the oysters obtained from British seas at £2,000,000, worth 2d. each, or, perhaps, 240,000,000 in all. An extensive import trade is carried on with the United States, which has grown up within the past decade, as is shown by the following statement<sup>3</sup> of import values:—1874, \$41,419;

<sup>1</sup> The statistical summary prepared for the Fisheries Division of the Tenth Census by Mr Ernest Ingersoll shows the details, by States, of the oyster industry of the whole country.

<sup>2</sup> Bouchon-Brandely stated in 1877 that the industry of oyster culture in France supported a maritime population of 200,000. It is difficult to reconcile this statement with the official statistics.

<sup>3</sup> That of Mr James G. Bertram in *Brit. Quart. Rev.* for January 1883.

<sup>4</sup> Derived from the records of the United States Treasury.

1875, \$38,783; 1876, \$99,012; 1877, \$121,801; 1878, \$254,815; 1879, \$306,941; 1880, \$366,403; 1881, \$414,584; 1882, \$372,111; 1883, \$371,497.

**Holland.**—Since 1870 the beds in the province of Zealand have been greatly enriched by careful methods of culture and protection; and in 1881 the product amounted to 2,800,000 oysters, worth about 1,350,000 guilders.<sup>1</sup> About half the product of the Dutch oyster fishery is sent to England, and large quantities of the young oysters are laid down to fatten in the English oyster-beds.

**Germany.**—Germany has a small oyster industry on the west coast of Schleswig-Holstein.<sup>2</sup> According to Linden, in, the largest annual product of these beds has rarely exceeded 4,000,000 oysters. From 1859 to 1879 they were rented to a company in Flensburg for an annual payment of 80,000 marks. In 1879 the lease was transferred to a Hamburg firm, who paid for that year 168,000 marks.

**Italy.**—Oyster culture in Italy, according to Bouchon-Brandely,<sup>3</sup> is carried on in only one locality, Taranto, though small quantities of natives are obtained from the Gulfs of Genoa and Naples, from the coasts of the Adriatic, and from the ponds of Corsica. The sea of Taranto is leased by the city to a company that pays an annual rent of 38,000 francs. The product of this body of water is estimated variously at from 6,000,000 to 10,000,000 oysters yearly. The entire annual product of Italy does not probably exceed 20,000,000 oysters, valued at about £40,000.

**Belgium.**—Oyster culture is carried on upon a small scale at Ostend. There being no native beds, the seed oysters are brought from England, a practice which, according to Lindeman, originated as early as 1765. The product probably does not exceed 10,000 bushels a year, and is consumed chiefly in Germany and Holland, though there is a small exportation.

**Spain.**—According to a recent report by Don Francisco Sola, there are forty-three establishments in Spain for the cultivation of oysters and other shell-fisheries. The amount of oysters annually produced is estimated at 167,673 kilogrammes (368,880 lb), valued at 50,296 pesetas (about £2000). These are exported to Algiers, France, Portugal, and South America.

**Portugal.**—There appear to be no statistics for Portugal. Considerable quantities of seed oysters are planted at present in the Bay of Arcachon and elsewhere in France, and in England the Anglo-Portuguese oyster is apparently growing in favour.<sup>4</sup>

**Denmark.**—The very insignificant oyster fishery of Denmark has its seat chiefly in the Limfjord and at Frederikshaven. All the oyster-beds, being Government property, are carefully protected by law. Statistics for late years are not accessible. In 1847 the product of the Frederikshaven beds was about 200,000 oysters; but the yield of late years has been much smaller. The Limfjord beds were discovered about 1851. From 1876 to 1881 the Danish oyster fisheries were leased to a firm in Hamburg, which paid 240,000 kroner (£13,000) as yearly rental.

**Russia.**—Grimm states that a species of oyster, *Ostrea adriatica*, is found in considerable numbers along the coast of the Crimea, and is the object of a considerable trade. Oysters brought from Theodosia coast in St Petersburg about 8s. sterling the score.

**Norway.**—The average value of the yield for the five years ending 1881 was 7600 kroner (£420). The quantity produced in 1881 was 267 hectolitres (735 bushels), valued at 7000 kroner (£390). The industry is seated for the most part in the districts of southern Trondhjem and Jarlsberg, the product of the latter province being nearly half that of all Norway.

Subjoined is a rough estimate of the total number of oysters obtained annually from the sea (North America, 5,572,000,000; Europe, 2,331,300,000):—

United States <sup>5</sup> .....	5,550,000,000	Germany.....	4,000,000
Canada.....	25,000,000	Belgium.....	2,500,000
France.....	380,400,000	Spain.....	1,000,000
Great Britain.....	1,600,000,000	Portugal.....	800,000
Holland.....	21,800,000	Denmark.....	200,000
Italy.....	20,000,000	Russia.....	250,000
		Norway.....	250,000

<sup>1</sup> Hubrecht, "Oyster Culture and Oyster Fisheries of the Netherlands" (conference paper, International Fisheries Exhibition); Hoek, "Ueber Austernzucht in den Niederlanden" (circular 2, Deutsche Fischeret-Verein, 1879; translated in Report of the United States Fish Commission, part viii. pp. 1029-35).

<sup>2</sup> Möbius, *Die Austern und die Austernwirtschaft* (1877), pp. 126; translated in Report of the United States Fish Commission, part viii. pp. 683-751).

<sup>3</sup> *Rapport au Ministère de l'Instruction sur la pisciculture en France et l'Ostriculture dans la Méditerranée* (Paris, 1878); the portion relating to oyster culture in the Mediterranean is translated in the Report of the United States Fish Commission, part viii. pp. 907-28.

<sup>4</sup> See Renaud, *Notice sur l'États Portugaises et Françaises cultivées dans la Baie d'Arcachon*; translated in the Report of the United States Fish Commission, part viii. pp. 931-41.

<sup>5</sup> On basis of 250 oysters to the bushel. The number varies from 150 to 400.

The oyster industry is rapidly passing from the hands of the fisherman into those of the oyster culturist. The oyster being sedentary, except for a few days in the earliest stages of its existence, is easily exterminated in any given locality; since, although it may not be possible for the fishermen to rake up from the bottom every individual, wholesale methods of capture soon result in covering up or otherwise destroying the oyster banks or reefs, as the communities of oysters are technically termed. The main difference between the oyster industry of America and that of Europe lies in the fact that in Europe the native beds have long since been practically destroyed, perhaps not more than 6 or 7 per cent. of the oysters of Europe passing from the native beds directly into the hands of the consumer. It is probable that 60 to 75 per cent. are reared from the spat in artificial parks, the remainder having been laid down for a time to increase in size and flavour in shoal waters along the coasts. In the United States, on the other hand, from 30 to 40 per cent. are carried from the native beds directly to market. The oyster fishery is everywhere, except in localities where the natural beds are nearly exhausted, carried on in the most reckless manner, and in all directions oyster grounds are becoming deteriorated, and in some cases have been entirely destroyed. It remains to be seen whether the Government of the States will regulate the oyster fishery before it is too late, or will permit the destruction of these most important reservoirs of food. At present the oyster is one of the cheapest articles of diet in the United States; and, though it can hardly be expected that the price of American oysters will always remain so low, still, taking into consideration the great wealth of the natural beds along the entire Atlantic coast, it seems certain that a moderate amount of protection will keep the price of seed oysters far below European rates, and that the immense stretches of submerged land especially suited for oyster planting may be utilized and made to produce an abundant harvest at much less cost than that which accompanies the complicated system of culture in vogue in France and Holland.

The most elaborate system of oyster culture is that practised at Arcachon and elsewhere in France, and, to a limited extent since 1865, on the island of Hayling, near Portsmouth, in England. The young oysters, having been collected in the breeding season upon tiles or hurdles, are laid down in artificial ponds, or in troughs, where the water is supplied to them at the discretion of their proprietors. The oysters are thus kept under control like garden plants from the time they are laid down to that of delivery to commercial control. The numerous modifications of this system are discussed in various recent reports.<sup>6</sup>

The simplest form of oyster culture is the preservation of the natural oyster-beds. Upon this, in fact, depends the whole future of the industry, since it is not probable that any system of artificial breeding can be devised which will render it possible to keep up a supply without at least occasional recourse to seed oysters produced under natural conditions. It is the opinion of almost all who have studied the subject that any natural bed may in time be destroyed by overfishing (perhaps not by removing all the oysters, but by breaking up the colonies, and delivering over the territory which they once occupied to other kinds of animals), by burying the breeding oysters, by covering

<sup>6</sup> See especially the following English parliamentary papers:—Report of the Commissioners appointed to inquire into the Present State of the Oyster Fisheries of France, England, and Ireland, 1870; Report of the Select Committee appointed to inquire what are the Reasons for the Present Scarcity of Oysters, &c., 1876; Report on the Principal Oyster Fisheries of France, with a short description of the System of Oyster Culture pursued at some of the most important places, &c., 1878.

up the projections suitable for the reception of spat, and by breaking down, through the action of heavy dredges, the ridges which are especially fitted to be seats of the colonies.<sup>1</sup> The immense oyster-beds in Pocomoke Sound, Maryland, have practically been destroyed by over-dredging and many of the other beds of the United States are seriously damaged. The same is doubtless true of all the beds of Europe. It has also been demonstrated that under proper restriction great quantities of mature oysters, and seed oysters as well, may be taken from any region of natural oyster-beds without injurious effects. Parallel cases in agriculture and forestry will occur to every one. Möbius, in his most admirable essay *Die Auster und Die Austernwirtschaft*, has pointed out the proper means of preserving natural beds, declaring that, if the average profit from a bed of oysters is to remain permanently the same, a sufficient number of mother oysters must be left in it, so as not to diminish the capacity of maturing. He further shows that the productive capacity of a bed can only be maintained in one of two ways:—(1) by diminishing the causes which destroy the young oysters, in which case the number of breeding oysters may safely be decreased; this, however, is practicable only under such favourable conditions as occur at Arcachon, where the beds may be kept under the constant control of the oyster-culturist; (2) by regulating the fishing on the natural bed in such a manner as to make them produce permanently the highest possible average quantity of oysters. Since the annual increase of half-grown oysters is estimated by him to be four hundred and twenty-one to every thousand full-grown oysters, he claims that not more than 42 per cent. of these latter ought to be taken from a bed during a year.

The Schleswig-Holstein oyster-beds are the property of the state, and are leased to a company whose interest it is to preserve their productiveness. The French beds are also kept under Government control. Not so the beds of Great Britain and America, which are as a general rule open to all comers,<sup>2</sup> except when some close-time regulation is in force. Prof. Huxley has illustrated the futility of "close-time" in his remark that the prohibition of taking oysters from an oyster-bed during four months of the year is not the slightest security against its being stripped clean during the other eight months. "Suppose," he continues, "that in a country infested by wolves, you have a flock of sheep, keeping the wolves off during the lambing season will not afford much protection if you withdraw shepherd and dogs during the rest of the year." The old close-time laws were abolished in England in 1866, and returned to in 1876, but no results can be traced to the action of parliament in either case. Prof. Huxley's conclusions as regards the future of the oyster industry in Great Britain are doubtless just as applicable to other countries,—that the only hope for the oyster consumer lies in the encouragement of oyster-culture, and in the development of some means of breeding oysters under such conditions that the spat shall be safely deposited. Oyster culture can evidently be carried on only by private enterprise, and the problem for legislation to solve is how

to give such rights of property upon those shores which are favourable to oyster culture as may encourage competent persons to invest their money in that undertaking. Such property right should undoubtedly be extended to natural beds, or else an area of natural spawning territory should be kept under constant control and surveillance by Government, for the purpose of maintaining an adequate supply of seed oysters.

The existing legislation in the United States is thus admirably summarized by Lieutenant Francis Winslow:—

"The fishery is regulated by the laws of the various States, the Federal Government exercising no control, and consequently the conditions under which the pursuit is followed are many and various. At the present time the laws relating to the oyster fishery may be said to be based upon one of two general principles. The first, the basis for the regulations of most of the States, considers the oyster-beds to be inalienable common property. Laws based upon this principle are generally of a protective nature, and are in reality regulations of the State, made by it in its capacity of guardian of the common property. The second principle assumes the right of the State to dispose of the area at the bottom of its rivers, harbours, and estuaries, and, having disposed of it, to consider the lessee or owner as alone responsible for the success or failure of his enterprises, and the State in no way called upon to afford him other assistance than protection in legitimate rights. In general terms, under the first principle the beds are held in common; under the second, in severalty. But one State permits the pre-emption of an unlimited tract of bottom, and the holding of it in fee—the State of Connecticut. Rhode Island leases her ground for a term of years, at \$10 per acre; but the person holding an area has no legal power of disposing of it beyond the limits of the lease. Massachusetts, New York, New Jersey, Maryland, and Virginia all permit pre-emption of small tracts by individuals for indefinite periods, and on the coast of Long Island the various towns along the shore lease tracts of considerable extent to private cultivators.

"Various restrictions are also placed upon the time and manner of conducting the fisheries. Some of the States, notably Virginia, prohibit entirely the use of the dredge or scrape; others, notably New Jersey, prohibit such use in some localities, and permit it in others. All the States, with one exception, forbid the use of steam vessels or machinery, or fishing by other than the open inhabitant. Connecticut again forms the exception, and quite a large fleet of steam dredging vessels are employed on her beds.

"The laws of the various States have several common features. All general fishing is suspended during the summer months. No night fishing is permitted. No steamers are allowed to be used. No proprietary rights to particular areas are given beyond the right to 'plant' a limited number of oysters on bottom adjoining land owned by the planter, and peace officers and local authorities are charged with execution of laws relating to the fishery. In a few States or localities Buoys are required to be obtained for each fishing vessel; and in one State, Maryland, a regular police force and fleet of vessels are maintained to support the law. These regulations are easily evaded, except those relating to the steamers and pre-emption of ground. Naturally, no one will put down oysters without being able to protect them; and steamers are too readily detected to make their illegal employment possible. In Connecticut and Rhode Island, the beds being virtually private property, there is no restriction of the fishery, except that it shall not be conducted at night."

The method of gathering oysters is simple, and much the same in all parts of the world, the implements in use being nippers or tongs with long handles, rakes, which are simply many-pronged nippers, and dredges. The subjoined account of the American method is abridged from that of Lieutenant Winslow:—

The character of the vessel or boat used depends in a measure upon the means of the fisherman and the consistency of his employment, and is so influenced by the character of the oyster ground, its location, and the laws governing the fishing. The last-named condition also decides the implement to be used; when permitted, it is the dredge—either the anonymous one employed by the steamers, the smaller toothed rake-dredge, or smooth-scrape. When dredging is prohibited, the tongs, or nippers, with two handles, sometimes 30 feet long, are used. The dredges are usually worked by an apparatus termed a "winder," many forms of which are employed, the best and most recent form being so designed that it, while resting in, the dredge should "hang," that is, become immovably fixed by some character on the bottom; the drum is an automatic device, throwing out of gear, and the dredge-rope allowed to run out. Small craft use a more simple and less expensive description of winch, and frequently haul in by hand, while the steam dredgers have powerful machinery adapted for this special purpose. The number of men employed varies with the size of the craft; two, three, and four men are sufficient on board the smaller dredgers, while the larger carry ten and twelve.

While a great many oysters are transported in the shell to markets distant from the seaboard, the largest part of the inland consumption is of "opened" or "shucked" oysters, and nearly every oyster dealer along the coast employs a larger or smaller number of persons to open the oysters and pack and ship the meats. Some of these establishments are small, having as few as half a dozen people engaged; others are large buildings or sheds, and employ hundreds of "shuckers." After having been removed from their shells and thoroughly washed, the oysters thus dealt with are transferred either to small cans, holding a quart of oysters, or to barrels, kegs, or tubs; when packed in tubs, kegs, or barrels, they go in bulk, with a large piece of ice; when packed in the tin cans, the cans are arranged in two rows inside of a long box, a vacant space being left in the centre, between the rows, in which is placed a large block of ice. The cans are carefully soldered up before packing, and together with the ice are laid in sawdust. Oysters packed in this way can, in cool weather, be kept a week or more, and sent across the continent, or to the remote western towns.

The steaming process is that by which the "cove" oysters are prepared. The term "cove" is applied to oysters put up in cans, hermetically sealed, and intended to be preserved an indefinite time. The trade in coves is confined principally to the Chesapeake region, and the process of preparing them is as follows. The oysters, usually the smaller size, are taken from the vessels and placed in cans of iron frame-work, 6 or 8 feet long. These cans run on a light iron track, which is laid from the wharf through the "steam-chest" or "steaming-box" to the shucking shed. As soon as a can is filled with oysters (in the shell) it is run into the steam-chest, a rectangular oak box, 18 to 20 feet long, lined with sheet iron and fitted with appliances for turning in steam; the doors, which work vertically and shut closely, are then let down, the steam admitted, and the oysters

<sup>3</sup> Catalogue of the Economic Mollusca exhibited by the United States National Museum at the International Fisheries Exhibition, London, 1883.

<sup>1</sup> Even Prof. Huxley, the most ardent of all opponents of fishery legislation, while denying that oyster-beds have been permanently annihilated by dredging, practically admits that a bed may be reduced to such a condition that the oyster will only be able to recover its former state by a long struggle with its enemies and competition,—in fact that it must re-establish itself much in the same way as they have acquired possession of new grounds in Jutland, a process which, according to his own statement, occupied thirty years. (Lecture at the Royal Institution, May 11, 1883, printed with additions in the *English Illustrated Magazine*, 1. pp. 47-55, 112-21).

<sup>2</sup> Connecticut has within a few years greatly benefited its oyster industry by giving to oyster-culturists a fee simple title to the lands under control by them.



left for ten or fifteen minutes. The chest is then opened and the cars run into the shucking shed, their places in the chest being immediately occupied by other cars. In the shed the cars are surrounded by the shuckers, each provided with a knife and a can arranged so as to hook to the upper bar of the iron frame-work of the car. The steaming having caused the oyster shells to open more or less widely, there is no difficulty in getting out the meats, and the cars are very rapidly emptied. The oysters are then washed in lead water and transferred to the "fillers" table. The cans, having been filled, are removed to another part of the room and packed in a cylindrical iron crate or basket, and lowered into a large cylindrical kettle, called the "process kettle" or "tab," where they are again steamed. After this they are placed, crate and all, in the "cooling tub," and when sufficiently cool to be handled, the cans are taken to the soldering table, and there "capped"—that is, are hermetically closed. From the "cappers" they are transported to another department, labelled, and packed in boxes for shipment. The whole steaming process will not occupy an hour from the time the oysters leave the vessel until they are ready for shipment.

The extension of the area of the natural beds is the second step in oyster culture. As is well known to zoologists, and as has been very lucidly set forth by Prof. Möbius in the essay already referred to, the location of oyster banks is sharply defined by absolute physical conditions. Within certain definite limits of depth, temperature, and salinity, the only requirement is a suitable place for attachment. Oysters cannot thrive where the ground is composed of moving sand or where mud is deposited; consequently, since the size and number of these places are very limited, only a very small percentage of the young oysters can find a resting-place, and the remainder perish. Möbius estimates that for every oyster brought to market from the Holstein banks, 1,045,000 are destroyed or die. By putting down suitable "culch" or "stools" immense quantities of the wandering fry may be induced to settle, and are thus saved. As a rule the natural beds occupy most of the suitable space in their own vicinity. Unoccupied territory may, however, be prepared for the reception of new beds, by spreading sand, gravel, and shells over muddy bottoms, or, indeed, beds may be kept up in locations for permanent natural beds, by putting down mature oysters and culch just before the time of breeding, thus giving the young a chance to fix themselves before the currents and enemies have had time to accomplish much in the way of destruction.

The collection of oyster spat upon artificial stools has been practised from time immemorial. As early as the 7th century, and probably before, the Romans practised a kind of oyster culture in Lake Avernus, which still survives to the present day in Lake Fusaro. Piles of rocks are made on the muddy bottoms of these salt-water lakes, and around these are arranged circles of stakes, to which are often attached bundles of twigs. Breeding oysters are piled upon the rookeries, and their young become attached to the stakes and twigs provided for their reception, where they are allowed to remain until ready for use, when they are plucked off and sent to the market. A similar though ruder device is used in the Poquonnock river in Connecticut. Birch trees are thrown into the water near a natural bed of oysters, and the trunks and twigs become covered with spat; the trees are then dragged out upon the shore by oxen, and the young fry are broken off and laid down in the shallows to increase in size. In 1858 the method of the Italian lakes were repeated at St Brieuc under the direction of Prof. P. Coete, and from these experiments the art of artificial breeding as practised in France has been developed. There is, however, a marked distinction between oyster culture and oyster breeding, as will be shown below. The natural beds of France in the Bay of Arcaehon, near Auray in Brittany, near Cahcale and Granville in Normandy, and elsewhere, are, however, carefully cultivated, as it is necessary that they should be, for the support of the breeding establishments.<sup>1</sup>

More or less handling or "working" of the oysters is necessary both for natural and transplanted beds. The most elaborate is that which has been styled the "English system," which is carried on chiefly near the mouth of the Thames, by the Whitstable and Colchester corporations of fishermen and others. This consists in

laying down beds in water a fathom or more in depth at low water and constantly dredging over the grounds, even during the close time, except during the period when the spat is actually settling. By this means the oysters are frequently taken out of the water and put back again, and it is claimed that in this way their enemies are baffled and the ground put in better condition to receive the spat. As a matter of fact, however, the oysters have not for many years multiplied under this treatment, and the system is practically one of oyster-parking rather than one of oyster-culture. One of the advantages of the frequent handling is that the fishermen, in putting the oysters back, can assort them by size, and arrange them conveniently for the final gathering for market purposes.

American oyster culture, as practised in the "East River" (the western end of Long Island Sound), in eastern Connecticut, and to some extent in Long Island and New Jersey, is eminently successful and profitable, and there seems to be no reason to doubt its permanence, conducted as it is in close proximity to the natural beds, and with due regard for preservation. In the Long Island Sound alone, in 1879, the labours of 1714 men produced 997,000 bushels, or perhaps 250,000,000 of native oysters, valued at \$847,925, while all France produced in the following season 375,000, worth about \$412,000. There was also a side product of 450,000 bushels (122,000,000) of transplanted oysters, worth \$850,000, handled by the same men in the American beds, while France employed an additional force of 28,000 people to produce 305,000,000 artificially bred oysters, worth \$3,179,000. The Long Island Sound system consists simply in distributing over the grounds, just before the spawning season, quantities of old oyster shells to which the young oysters become attached, and left undisturbed for from three to five years, when, having reached maturity, they are dredged for use. Spawning oysters are frequently put down in the spring, two months before the ground is shelled; this is done even when the natural beds are near, but is not so essential as when a rather remote piece of bottom is to be colonized.<sup>2</sup>

An excellent summary of the methods of planting in different parts of the United States may be found in Winalow's paper already quoted.

The laying down or temporary deposit of dredged oysters in estuaries on floats or in tanks, to fatten, increase in size, or improve in flavour, is a concomitant of oyster culture, and may be used in connexion with any of the systems above referred to. It is in no sense oyster culture, since it has no relation to the maintenance of the supply. A system of this kind has been practised since the 16th century at Marenes and La Tremblade on the west coast of France, where oysters from natural beds are placed in shallow basins communicating with the sea during the spring tides, and where they obtain food which gives them a green colour and a peculiar flavour much esteemed by Parisian epicures.<sup>3</sup> Similar methods of parking are practised at Cancals and Granville.

In England, brood oysters are laid down in fattening beds on the coast of Essex and in the Thames estuary, where they acquire delicacy of flavour, and to some extent, especially in the Thames, the green colour already referred to. Belgium has also, near Ostend, fattening beds supplied with foreign spat, chiefly from England.

In the United States an extensive business is carried on in laying down seed oysters from the Chesapeake Bay in the estuaries of southern New England and the Middle States.

Oyster-culturists practise in many places what is called "plumping," or puffing up oysters for market by exposing them for a short time to the effects of water fresher than that in which they grow. By this process the animal does not acquire any additional matter except the water, which is taken up in great amount, but it loses a part of its saltness, and, in flavour, becomes more like an oyster from brackish waters.

There are large oyster reservoirs at Husum in Schleswig-Holstein, and at Ostend, which serve the double purpose of fattening the oysters and of keeping a uniform supply for the markets at times unsuited to the prosecution of the fishery.

The artificial impregnation of oyster eggs has been successfully accomplished by many experimenters, and in 1883 Mr John A. Ryder of the United States Fish Commission succeeded in conflating the swimming embryos in collectors until they had formed their shells and become fixed. The utility of this experiment seems to consist in the greater facility which it gives to oyster-culturists in securing a sure supply of spat, independent of the vicissitudes which currents and changes of weather entail upon those who rely upon its deposit under natural conditions. The spat thus secured can be reared either by the American, English, or French systems. It is not probable that the common European species, *Ostrea edulis*, can be so readily handled by this method as the Portuguese species, *Ostrea angulata*, or the American, *Ostrea virginica*, though this can only be determined by trial. For the details of Mr Ryder's experiment, see the *Bulletin* of the United States Fish Commission, vol. ii. pp. 281-94. (G. B. G.)

<sup>1</sup> *The Oyster Industry*, by Ernest Ingersoll (Washington, 1881).

<sup>2</sup> Möbius, *Die Auster und Die Austernzucht*; and De Bon, *Ostriculture en 1875*.

<sup>3</sup> See *Report of the United States Fish Commission*, part viii. pp. 730-41, 753-59, 885-903, 931-41.

**OYSTER-CATCHER**, a bird's name which does not seem to occur in books until 1731, when Catesby (*Nat. Hist. Carolina*, i. p. 85) used it for a species which he observed to be abundant on the oyster-banks left bare at low water in the rivers of Carolina, and believed to feed principally upon those mollusca. In 1776 Pennant applied the name to the allied British species, which he and for nearly two hundred years many other English writers had called the "Sea-Pie." The change, in spite of the misnomer—for, whatever may be the case elsewhere, in England the bird does not feed upon oysters—met with general approval, and the new name has, at least in books, almost wholly replaced what seems to have been the older one.<sup>1</sup> The Oyster-catcher of Europe is the *Hematopus*<sup>2</sup> *ostralegus* of Linnaeus, belonging to the group now called *Limicola*, and is generally included in the Family *Charadriidae*; though some writers have placed it in one of its own, *Hematopodidae*, chiefly on account of its peculiar bill—a long thin wedge, ending in a vertical edge. Its feet also are much more fleshy than are generally seen in the Plover Family. In its strongly-contrasted plumage of black and white, with a coral-coloured bill, the Oyster-catcher is one of the most conspicuous birds of the European coasts, and in many parts is still very common. It is nearly always seen paired, though the pairs collect in prodigious flocks; and, when these are broken up, its shrill but musical cry of "tu-lup," "tu-lup," somewhat pettishly repeated, helps to draw attention to it. Its wariness, however, is very marvellous, and even at the breeding-season, when most birds throw off their shyness, it is not easily approached within ordinary gunshot distance. The hen-bird commonly lays three clay-coloured eggs, blotched with black, in a very slight hollow on the ground, not far from the sea. As incubation goes on the hollow is somewhat deepened, and perhaps some haulm is added to its edge, so that at last a very fair nest is the result. The young, as in all *Limicola*, are at first clothed in down, so mottled in colour as closely to resemble the shingle to which, if they be not hatched upon it, they are almost immediately taken by their parents, and there, on the slightest alarm, they squat close to elude observation. This species occurs on the British coasts (very seldom straying inland) all the year round; but there is some reason to think that those we have in winter are natives of more northern latitudes, while our home-bred birds leave us. It ranges from Iceland to the shores of the Red Sea, and lives chiefly on marine worms, crustacea, and such mollusca as it is able to obtain. It is commonly supposed to be capable of prizing limpets from their rock, and of opening the shells of mussels; but, though undoubtedly it feeds on both, further evidence as to the way in which it procures them is desirable. Mr Harting informs the writer that the bird seems to lay its head sideways on the ground, and then, grasping the limpet's shell close to the rock between the mandibles, use them as scissor-blades to cut off the mollusc from its sticking-place. The Oyster-catcher is not highly esteemed as a bird for the table.

Differing from this species in the possession of a longer

<sup>1</sup> It seems however very possible, judging from its equivalents in other European languages, such as the Frisian *Oestervischer*, the German *Austernmann*, *Austernfischer*, and the like, that the name "Oyster-catcher" may have been not a colonial invention but indigenous to the mother-country, though it had not found its way into print before. The French *Hutrier*, however, appears to be a word coined by Brisson. "Sea-Pie" has its analogues in the French *Pie-de-Mer*, the German *Neerlester*, *Seelester*, and so forth.

<sup>2</sup> Whether it be the *Hematopus* whose name is found in some editions of Pliny (lib. x. cap. 47) is at best doubtful. Other editions have *Himantopus*; but Hardouin prefers the former reading. Both words have passed into modern ornithology, the latter as the generic name of the *BUTLE* (g.a.); and some writers have blended the two in the strange and impossible compound *Himantopus*.

bill, in having much less white on its back, in the paler colour of its mantle, and in a few other points, is the ordinary American species, already mentioned, *Hematopus palliatus*. Except that its call-note, judging from description, is unlike that of the European bird, the habits of the two seem to be perfectly similar; and the same may be said indeed of all the other species. The Falkland Islands are frequented by a third, *H. leucopus*, very similar to the first, but with a black wing-lining and paler legs, while the Australian Region possesses a fourth, *H. longirostris*, with a very long bill as its name intimates, and no white on its primaries. China, Japan, and possibly eastern Asia in general have an Oyster-catcher which seems to be intermediate between the last and the first. This has received the name of *H. oculans*; but doubts have been expressed as to its deserving specific recognition. Then we have a group of species in which the plumage is wholly or almost wholly black, and among them only do we find birds that fulfil the implication of the scientific name of the genus by having feet that may be called blood-red. *H. niger*, which frequents both coasts of the northern Pacific, has, it is true, yellow legs, but towards the extremity of South America its place is taken by *H. ater*, in which they are bright red, and this bird is further remarkable for its laterally compressed and much upturned bill. The South African *H. capensis* has also scarlet legs; but in the otherwise very similar bird of Australia and New Zealand, *H. unicolor*, these members are of a pale brick-colour. (A. N.)

**OZAKA**, or **OSAKA**, one of the three imperial cities of Japan (Kioto and Tokio or Yedo being the other two), is situated in a plain in the province of Setsu or Sesshu, measuring about 20 miles from north to south and from 15 to 20 miles east and west, and bounded, except towards the west, where it opens on Idzuminada Bay, by hills of considerable height. It lies on both sides of the Yodogawa, or rather of its headwater the Aji (the outlet of Lake Biwa), and is so intersected by river-branches and canals as to suggest a comparison with Venice or Stockholm. River steamers ply between Ozaka and its port Hiogo or Kobe, and a railway between the two places, opened in 1873, has since been extended to Kioto and farther. The streets are not very broad, but for the most part they are regular and well kept; the houses, about 20 or 25 feet in height, are all built of wood. Shin-sai Bashi Suji, the principal thoroughfare, leads from Kitahama, the district lying on the south side of the Tosabori, to the iron suspension bridge (Shin-sai Bashi) over the Dotom-bori. The foreign settlement is at Kawaguchi at the junction of the Shirinashi-gawa and the Aji-Kawa. It is almost deserted by the foreign merchants, who prefer to have their establishments at Kobe, but it is the seat of a number of European mission stations. Though the Buddhist temples of Ozaka number 1380 and the Shinto temples 538, few of them are of much note. The Buddhistic Tennoji, founded by Shotoku Tai-shi, and restored in 1664, covers an immense area at the south-east corner of the city, and has a fine pagoda from which an admirable view of the country is obtained. Two other Buddhist temples, which form a conspicuous object in the heart of the city, are occupied, one as a Government hospital and the other as a Government school. The principal secular buildings are the castle, the mint, and the arsenal. The castle was founded in 1584 by Hideyoshi; the enclosed palace, "probably the finest building Japan ever saw," survived the capture of the castle by Iyeyasu, and in 1867 and 1878 witnessed the reception of the foreign legations by the Tokugawa shoguns; but in the latter year it was fired by the Tokugawa party. Externally the whole castle is protected by a double enceinte of high and massive walls and broad moats—the outer moat from 80 to 120 yards across and

from 12 to 24 feet deep. Huge blocks of granite 40 feet by 10 or 20 feet occur in the masonry. The mint, erected by T. J. Waters, and organized by Major T. W. Kinder and twelve European officials, covers an area of 40 acres, and employs about 600 persons. It was opened in 1871. Both cannon and guns are manufactured in the arsenal. Apart from these Government establishments Ozaka is the seat of great industrial activity, possessing iron foundries, copper foundries, and rolling mills, antimony works, large glass works, paper mills, a sugar refinery, a cotton spinning mill, rice mills, an oil factory, sulphuric acid works, match factories, soap works, saké distilleries, a brewery (after the German pattern), shipyards, &c. Bronzes, sulphuric acid, and matches are among its chief exports. In the surrounding district large quantities of rape-seed are grown. The population in 1872 was 271,992; in 1877, 284,105.

Ozaka owes its origin to Ren-nio Sho-nin, the 8th head of the Shin-Shin sect, who in 1495-6 built, on the site now occupied by the castle, a temple which afterwards became the principal residence of his successors. In 1580, after ten years' successful defence of his position, Ken-nio, the 11th "abbot," was obliged to surrender; and in 1588 the victorious Hideyoshi made Ozaka his capital. The town was opened to foreign trade in 1688.

**OZANAM, ANTOINE FRÉDÉRIC (1813-1853)**, the greatest name, as far as literary and historical criticism is concerned, of the Neo-Catholic movement in France during the first half of the 19th century, was born at Milan on April 13, 1813. His family is said (as the name suggests) to have been of Jewish extraction, and has a circumstantial though possibly fabulous genealogy of extraordinary length. At any rate it had been settled in the Lyonnais for many centuries. In the third generation before Frédéric it had reached distinction through Jacques Ozanam, a mathematician of eminence. The critic's father, Antoine Ozanam, served in the armies of the republic, but could not stomach the empire, and betook himself to commerce, teaching, and finally medicine. The boy was brought up at Lyons, and was strongly influenced by one of his masters, the Abbé Noirot. His conservative and religious instincts showed themselves early, and he published a pamphlet against Saint-Simonianism in 1831, which attracted the attention of Lamartine. He was then sent to study law in Paris, where he fell in with the Ampère family, and through them with excellent literary society. He also came under the influence of the Abbé Gerbet, the soberest and most learned member of the religious school of Lamennais and Lacordaire. Ozanam, however, though he joined with all the fervour of youth in the Neo-Catholic polemic, never underwent the uncomfortable experiences of the direct followers of Lamennais. His journal (for in those years every one was a journalist) was not the *Avenir*, but the more orthodox *Tribune Catholique* of Bailly, and he with some other young men founded the famous society of St Vincent de Paul, which was occupied in practical good works. Meanwhile he did not neglect his studies. He was called to the bar, and in 1838 won his doctor's degree in letters with a thesis on Dante, which was the beginning of his best-known book. A year later he was appointed to a professorship of commercial law at Lyons, and in another year assistant professor to Fauriel at the Sorbonne. On this latter precarious endowment he married, and visited Italy on his wedding tour. At Fauriel's death in 1844 he succeeded to the full professorship of foreign literature, and his future was thereby tolerably assured. He had, however, by no means a strong constitution, and he tried it severely by combining with his professorial work a good deal of literary occupation, while he still continued his custom of district-visiting as a member of the society of St Vincent de Paul. The short remainder of his life was extremely busy, though it was relieved at intervals by

visits to Italy, Brittany, England, and other places. He produced numerous books, and during the revolution of 1848 (of which, like not a few of his school, he took an unduly sanguine view) he once more became a journalist in the *Ère Nouvelle* and other papers for a short time. He was in London at the time of the Exhibition of 1851. In little more than two years from that date he died of consumption (which he had vainly hoped to cure by visiting Italy) on September 8, 1853, at the age of forty.

Ozanam deserves the phrase which has been attached to his name at the beginning of this article. He was more sincere, more learned, and more logical than Chateaubriand, less of a political partisan and less of a literary sentimentalist than Montalembert. Whether his conception of a democratic Catholicism was a possible one is of course a matter of opinion, and it may be frankly admitted that, well as he knew the Middle Ages, he looked at them too exclusively through the spectacles of a defender of the papacy. He confessed that his object was to "prove the contrary thesis to Gibbon's." And no doubt any historian, literary or other, who begins with the desire to prove a thesis is sure to go more or less wrong. But his pictures were not so much coloured by his prepossessions as some contemporary pictures on the other side, and he had not only a great knowledge of mediæval literature, but also a strong and appreciative sympathy with mediæval life.

His chief works (collected in 1855-58) were *Bacon et St Thomas de Cantorbéry*, 1836; *Dante et la Philosophie Catholique*, 1839 (2d ed., enlarged, 1845); *Études Germaniques*, 1847-49; *Documents inédits pour servir à l'Histoire d'Italie*, 1850; *Les Poètes Français*, 1852. There is an interesting life of him in English by K. O'Meara (2d ed., London, 1878).

**OZOCERITE**, or **OZOKERITE** (ὄζωρ, odour-emitting, and κηρός, wax; smelling wax, mineral wax), is a combustible mineral which may be designated as crude native PARAFFIN (*q.v.*), found in many localities in varying degrees of purity. The only commercial sources of supply however are in Galicia, principally at Boryslaff and Dzwieniaax. Hofstädter in 1854 examined an ozocerite from "Boristoff near Drohobiez," Galicia; he found it to consist chiefly of hydrocarbon which, after crystallization from alcohol, exhibited the composition  $CH_2$  of the olefines; this, however, is quite compatible with their being really "paraffins,"  $C_nH_{2n+2}$  which latter formula for a large  $n$  coincides practically with  $C_nH_{2n}$ . At and near Baku and in other places about the Caspian Sea, soft oily native paraffins, known as "nefto-gil" or "nefte-degil" and "kir," are found with other petroleum products. The theory of the formation of ozocerite now generally accepted is that it is a product of the decomposition of organic substances, which was originally like petroleum, but has lost its more volatile components by volatilization. All native petroleum in fact, like crude paraffin oil, holds solid paraffin in solution.

Galician ozocerite varies in consistence from that of a rather firm and hard wax to that of a soft adherent plastic mass, and in colour from yellow to a dark (almost black) green. Its melting-point ranges from  $58^\circ$  to  $98^\circ$  C. ( $136^\circ$  to  $208^\circ$  Fahr.); the extra high melting point of the paraffin extracted from it is one of its distinguishing features. Besides the earthy impurities which are always associated with the mineral as found in the "nefts" containing it, it is mixed with liquid hydrocarbons, resinous oxygenated compounds, and water. In the following table columns I. and II. show the yield in two distillations of a superior quality of the ozocerite of Boryslaff, as given by Perutz.

	I.	II.
Benzene .....	5.67	0.27
Naphtha .....	3.67	11.00
Paraffin .....	82.33	78.32
Pyrene and chrysenes.....	2.05	...
Coke and loss.....	5.59	8.28
Water.....	0.33	2.13

The purified paraffin of ozocerite makes excellent candles, which are said to give more light, weight for weight, than

those made from ordinary paraffin, besides being less easily fusible. Under the name of ceresin or ozocerotin a large proportion of the high-melting paraffin extracted from the mineral goes into commerce, to be used chiefly for the adulteration of beeswax. The various methods of refining used furnish certain proportions of soft paraffin, and of heavy and light oils as bye-products, which take their place in commerce beside the corresponding products from shale and petroleum.

A kind of mineral wax known as idrialine accompanies the mercury ore in Idria. According to Goldschmidt it can be extracted by means of xylol, amyl-alcohol, or turpentine, and also, without decomposition, by distillation in a current of hydrogen or carbonic acid. It is a white crystalline body, very difficultly fusible, boiling above 440° C. (824° F.), of the composition  $C_{40}H_{80}O$ . Its solution in glacial acetic acid, by oxidation with chromic acid, yielded to Goldschmidt a red powdery solid and a fatty acid fusing at 62° C., and exhibiting all the characters of a mixture of palmitic and stearic acids.

OZONE has been defined and to some extent discussed under the heading CHEMISTRY, vol. v. p. 481.

From the time of Van Marum (1785) at least it was known that the passage of electric sparks through air is accompanied by the production of a peculiar smell; but the cause of this remained unknown until 1840, when Schönbein observed that a similar smell is exhibited by electrolytic oxygen (as obtained in the electrolysis of acidulated water), and also develops in the atmosphere of a vessel in which phosphorus suffers spontaneous oxidation at ordinary temperatures in the presence of water. The three kinds of odoriferous gas, he found, had the power of decomposing iodide of potassium with liberation of iodine, and they agreed also in their behaviour to other reagents, whence he concluded that in all the three cases the smell was owing to the same peculiar substance which he called *ozone* (from *ὄζειν*, to emit an odour). Numerous experiments confirmed his first impression that ozone is chemically similar to, though distinctly different from, chlorine, but he got no further towards establishing its nature. Having found, however, that dry phosphorus produces no ozone, and that ready-made ozone is destroyed by being passed through a heated glass tube, he surmised that ozone was a peroxide of hydrogen. This surmise was seemingly raised to a certainty by an investigation of Baumert's, who found that electrolytic (ozone) oxygen, when deoxygenized by heat, yields water, and ascertained that the weight of water thus produced amounted to  $H_2O = 18$  parts for every  $4I - 4 \times 127$  parts of iodine which the same quantity of gas would have liberated if it had been deoxygenized by iodide of potassium. This, if true, would prove that ozone is  $H_2O_3$ —a conclusion which passed current as an established fact, in reference to electrolytic ozone at least, until Andrews showed that Baumert's result was founded upon incorrect observations. The merit of having discovered the true elementary composition of ozone belongs to Marignac and De la Rive, who proved that it can be produced, as easily and abundantly as in any other way, by the electrification of absolutely pure oxygen gas, whence it at once followed that—unless oxygen be a compound of two or more unknown elements—ozone cannot be anything else than an allotropic modification of oxygen.

With regard to the relations of the two kinds of oxygen to one another, our present knowledge is derived mainly from the work of Andrews and Prof. Tait. The first important result which they arrived at was that the ozonization of pure oxygen gas involves a contraction, and that consequently ozone is denser than oxygen gas. Presuming (with all their contemporaries) that in the de-ozonization of oxygen by iodide of potassium all the substance of the ozone is taken up by the reagent with elimination of its equivalent of iodine, they sought to determine the density of ozone by comparing the weight of oxygen-matter which goes into the iodide of potassium with the contraction involved in the process. But they obtained variable results. As their methods became more and more perfect,

the weight of unit volume of ozone grew greater and greater, and at last stood at  $\infty$ . In other words, what they found and established finally was that the removal of ozone from oxygen by means of iodide of potassium involves no change of volume whatever, although de-ozonization by heat always leads to a (permanent) increase of volume. This result, to them and everybody else, appeared very singular; but Andrews, after a while, found the correct explanation. Supposing at a certain temperature and pressure one volume of ordinary oxygen contains  $a$  grains of matter, then one volume of ozone, being denser, contains a greater quantity of matter, say  $a+x$  grains; when the gas acts on iodide of potassium, the  $x$  grains come out as one volume of oxygen, while the  $a$  grains of surplus oxygen vanish in the iodide. In the decomposition by heat the  $a$  grains of surplus oxygen of course assume the form of  $a/s$  volumes of additional oxygen gas. It is no addition to Andrews's explanation, but merely a close translation of it into the language of Avogadro's law, to say that, if oxygen (proper) consists of molecules  $O_2$ , ozone must consist of molecules  $O_{2+s}$  (perhaps  $O_{2+1}$ ), and that in the iodide reaction this molecule breaks up into one molecule of oxygen gas and  $s$  atoms of oxygen which go to the reagent. What did constitute a new discovery was Berthelot's important observation that the conversion of ozone into ordinary oxygen involves an evolution of heat which amounts to 29,600 units for every 16 parts of oxygen matter available for the liberation of iodine from iodide of potassium. What the real density of ozone is was made out with a high degree of probability by Sorot. He took two equal volumes of the same supply of ozonized oxygen, and in one determined the contraction produced by shaking with oil of turpentine (which he assumes to take away the ozone as a whole), while the other served for the (direct or indirect) determination of the expansion involved in the destruction of the ozone by heat. He found this increase to amount to half a volume for every one volume of ozone present; hence one volume of ozone contains the matter of one and a half volumes of ordinary oxygen, i.e., its density is 1.5 (if that of ordinary oxygen is taken as unity), and its molecular weight is  $\frac{1}{2} \times O_2 = O_3$ . To check this result Sorot determined the rate at which ozone diffuses into air, and compared it with the rate, similarly determined, for carbonic acid. From the two rates, on the basis of Graham's law, he calculated the ratio of the density of ozone to that of carbonic acid, and found it in satisfactory accordance with  $O_3 \cdot CO_2 = 48 : 44$ . From the facts that ozone is destroyed (i.e., converted into  $O_2$ ) at 270° (Andrews and Tait), and that this reaction is not reversible, it at once follows that it is impossible to convert oxygen completely into ozone by electric sparks. Supposing the ozonization to have gone a certain way, each additional spark, besides producing ozone, will destroy some of that previously produced.

From Clerk Maxwell's notion concerning the distribution of temperatures amongst the molecules of a gas, it would follow that ozonized oxygen, even at ordinary temperatures, will gradually relapse into the condition of plain oxygen, because, although the temperature as indicated by the thermometer may be only 20° C. (say), there are plenty of molecules at temperatures above the temperature of incipient dissociation (which of course lies below 270°), and any ozone once destroyed will never come back. But, be this as it may, the lower the temperature of the oxygen treated with sparks the greater the chance of the ozone formed to remain alive. This idea forms the basis of an important research by Hautefeuille and Chappuis, who, by operating upon oxygen at very low temperatures, produced unprecedentedly large percentages of ozone. By operating at 0° C. they produced a gas containing 14.9 per cent. by weight of ozone (presumably reckoned as  $O_3$ ), while at -23° the percentage rose to 21.4%. They subsequently (1882; *Compt. Rend.*, xciv. p. 1249) succeeded in producing even liquid ozone, by applying a pressure of 135 atmospheres to richly ozonized oxygen at -100° C. (the boiling point of liquefied ethylene). Liquid ozone is of a dark indigo-blue colour, which, as they tell us, is distinctly visible even in ordinary ozonized oxygen if it is viewed in tubes about one metre long.

According to Carius the coefficient of absorption of ozone by water of +1° C. is about 0.8; that is to say, one volume of water of 1°, if shaken with excess of pure ozone at 1° and a pressure of 760 mm., would absorb 0.8 volume of ozone measured dry at 0° and 760 mm. pressure. But it is not certain that Carius's determinations are correct.

*Antozone*.—According to a now obsolete notion of Schönbein's, ordinary oxygen gas is a compound of two kinds of oxygen of which one is positively and the other negatively electrical. Ordinary ozone would be a mixture of the two in equal parts; but certain peroxides, according to Schönbein, contain the one kind, others the other. He supported his view by many ingenious experimental arguments. Meissner and others, while adopting Schönbein's idea, somehow drifted into the notion that Schönbein's two kinds of oxygen correspond to two different substances, of which ordinary ozone is one. They naturally searched for the other, and of course did not fail to discover it; but their "antozone," when critically looked into, turned out to be peroxide of hydrogen. (W. D.)

## P

**P** is the sixteenth letter of our alphabet. In the origins' Phœnician form (see ALPHABET) it was not unlike a crook. In Greece it became angular ( $\rho$ ), and later the downward strokes were made equal in length ( $\Pi$ ), though in the old Corinthian the rounded form still occurs, closely resembling the Phœnician type. In old Latin the angular form is found, as in Greece, but also the form with which we are familiar, with the bottom of the curve joined to the straight line. The old guess that P was at first a rude sketch of a mouth must be abandoned unless we are prepared to credit the Phœnicians with having so far anticipated Mr Melville Bell's "visible speech."

The sound it denotes is a closed labial, differing from *b* as a surd from a sonant; it is heard only when the lips open; there is then a percussion as the breath escapes, which constitutes the sound. The difference between breath and voice can be easily seen in the production of the two sounds, *p* and *b*. When the lips are closed—as they must be closed (exactly in the same way) for each of the sounds—if we then try to articulate *p*, no effort can produce any kind of sound till the lips open; the chordæ vocales do not vibrate, and there is therefore nothing in the mouth but mere breath. But if we make as though we would sound *b*, while still keeping the lips shut, a certain dull sound is quite audible, produced by the vocalized breath (or voice) within the mouth; and the action of the top of the larynx in producing this sound may be distinctly felt. Of course this sound is not a *b*; that does not come till the lips part.

It is noteworthy how very small is the number of pure English words which begin with *p*. Such words correspond to words which began with *b* in Greek, Latin, and other members of the parent Aryan speech; and these are equally few. Nearly all the words which we have in English beginning with *p* are therefore borrowed, such as "pain," "pair," "police," which came to us from France; others are scientific terms, oftenest modelled upon the Greek. The reason of this deficiency of words in the parent language commencing with *b* is not easy to find.

The Latins denoted the sound of Greek  $\phi$  by the double symbol *ph*; this is a *p* followed by a slight breathing, not so strong as an *h*; thus "philosophia" was pronounced not as we now pronounce it, but rather like "philosoph'ia." But this sound eventually passed into the *f*-sound, and it is so written in Italian (*e.g.*, "filosofia"); French and English have kept the old spelling, but not the sound. So here, as elsewhere, we have quite unnecessarily two symbols, *ph* and *f*, expressing the same sound.

PACCHIA, GIROLAMO DEL, and PACCHIAROTTO (or PACCHIAROTTI), JACOPO. These are two painters of the Siennese school, whose career and art-work have been much misstated till late years. One or other of them produced some good pictures, which used to pass as the performance of Perugino; reclaimed from Perugino, they were assigned to Pacchiarotto; now it is sufficiently settled that the good works are by G. del Pacchia, while

nothing of Pacchiarotto's own doing transcends mediocrity. The mythical Pacchiarotto who worked actively at Fontainebleau has no authenticity.

Girolamo del Pacchia, son of a Hungarian cannon-founder, was born, probably in Siena, in 1477. Having joined a turbulent club named the Bardotti, he disappeared from Siena in 1535, when the club was dispersed, and nothing of a later date is known about him. His most celebrated work is a fresco of the Nativity of the Virgin, in the chapel of S. Bernardino, Siena, graceful and tender, with a certain artificiality. Another renowned fresco, in the church of St Catherine, represents that saint on her visit to St Agnes of Montepulciano, who, having just expired, raises her foot by miracle. In the National Gallery of London there is a Virgin and Child. The forms of G. del Pacchia are fuller than those of Perugino (his principal model of style appears to have been in reality Franciabigio); the drawing is not always unexceptionable; the female heads have sweetness and beauty of feature; and some of the colouring has noticeable force.

Pacchiarotto was born in Siena in 1474. In 1530 he took part in the conspiracy of the Libertini and Popolani, and in 1534 he joined the Bardotti. He had to hide for his life in 1535, and was concealed by the Observantine fathers in a tomb in the church of St John. He was stuffed in close to a new-buried corpse, and got covered with vermin and dreadfully exhausted by the close of the second day. After a while he resumed work; he was exiled in 1539, but recalled in the following year, and in that year or soon afterwards he died. Among the few extant works with which he is still credited is an Assumption of the Virgin, in the Carmine of Siena.

PACHECO, FRANCISCO (1571-1654), Spanish painter and art historian, born at Seville in 1571, was the pupil of Luis Fernandez, and a diligent and prolific workman. Favourable specimens of his style are to be seen in the Madrid picture gallery, and also in two churches at Alcalá de Guadaíra near Seville; they are characterized by careful drawing and correct if somewhat feeble composition, but prove that he was no colorist. He attained great popularity, and about the beginning of the 17th century opened an academy of painting which was largely attended. Of his pupils by far the most distinguished was Velazquez, who afterwards became his son-in-law. From about 1625 he gave up painting and betook himself to literary society and pursuits; the most important of his works in this department is a treatise on the art of painting (*Arte de la Pintura: su anteguedad y grandezas*, 1649), which, although characterized by prolixity and pedantry of style, and often nonsensical enough in its theories, is of considerable value for the information it contains, especially on matters relating to Spanish art. He died in 1654.

PACHOMIUS, or PACHUMIUS. See MONACHISM, vol. xvi. pp. 699, 700.

PACHYDERMATA. See MAMMALIA.

## PACIFIC OCEAN

**T**HE ancient world was ignorant of the existence of the vast expanse of water now known as the Pacific Ocean. In Ptolemy's map of the world, constructed in the 2d century of our era (see MAP, vol. xv. Pl. VII.), this fact is clearly brought out, for the only space which might possibly represent the Pacific is the Magnus Sinus,

a sea so limited in extent, and represented in such a position, that it probably stands for the Gulf of Siam in the Indian Ocean.

Vague reports of a great ocean lying beyond China were current in Europe as early as the period of Arabian supremacy in learning. Indeed an Arab merchant named

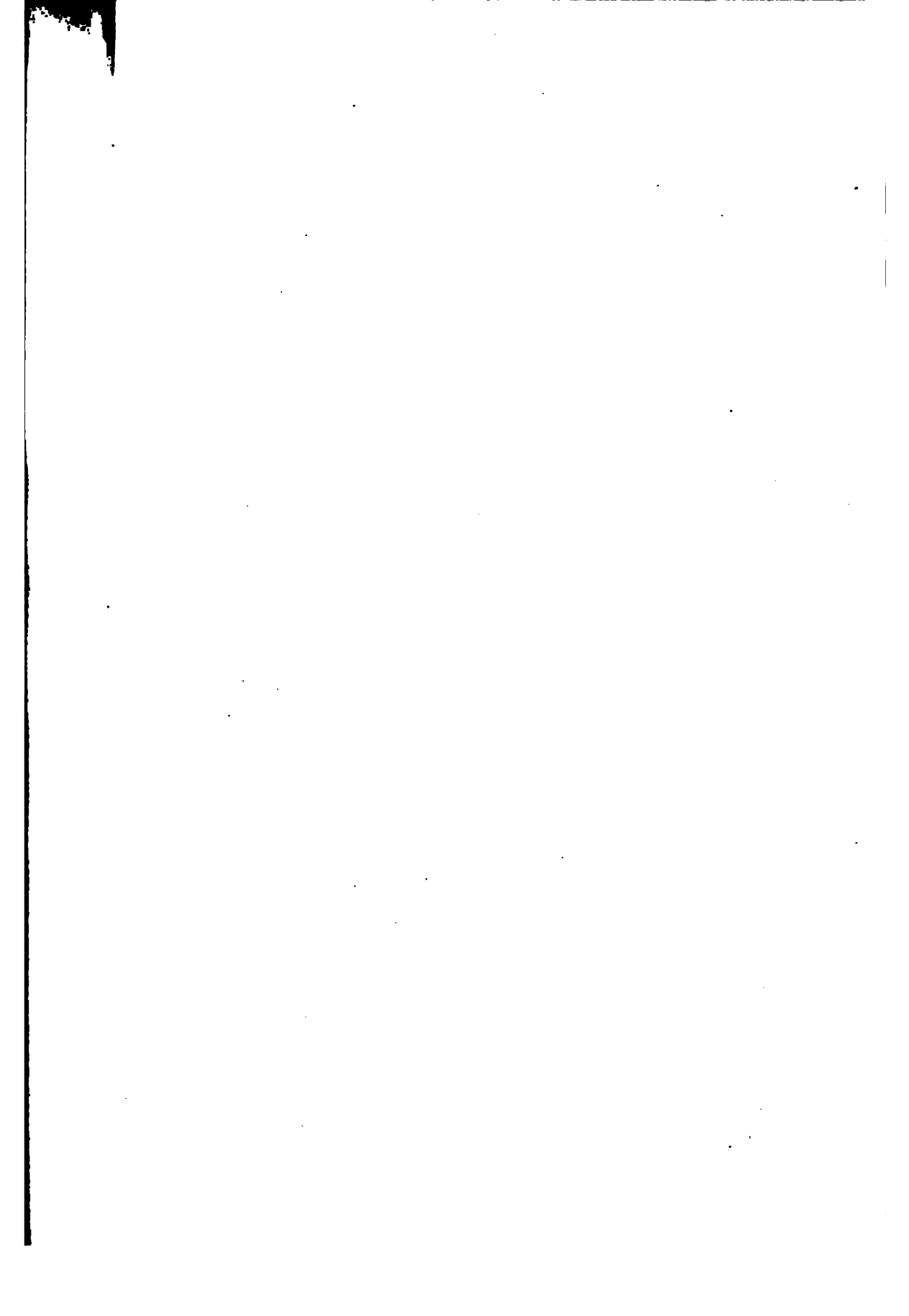
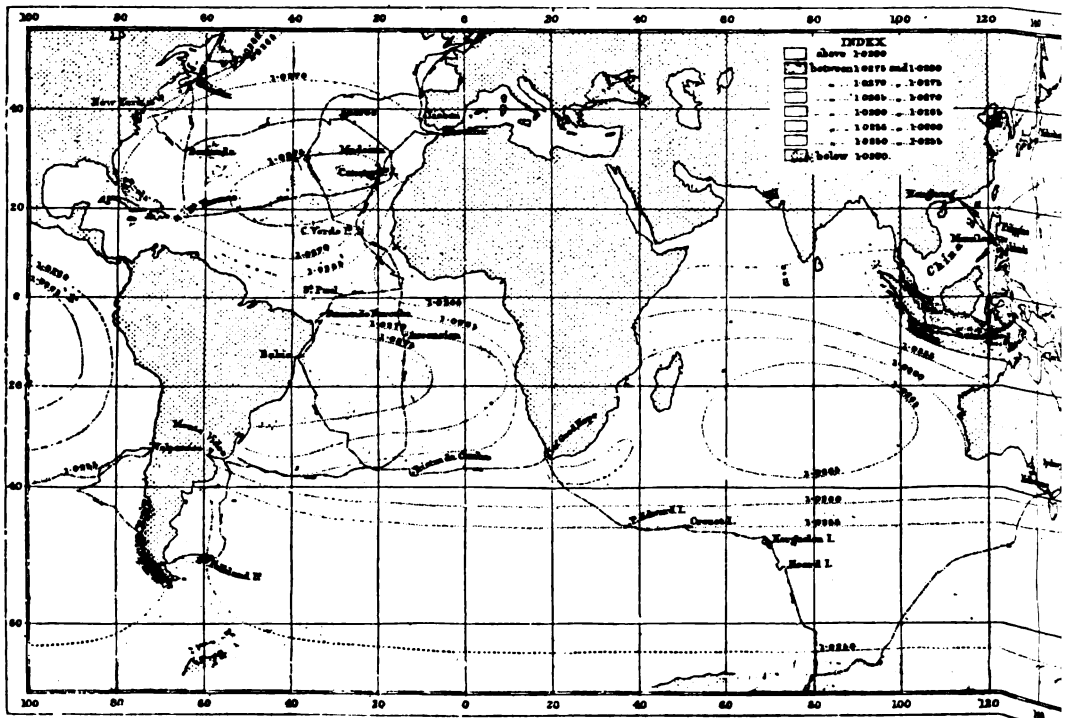
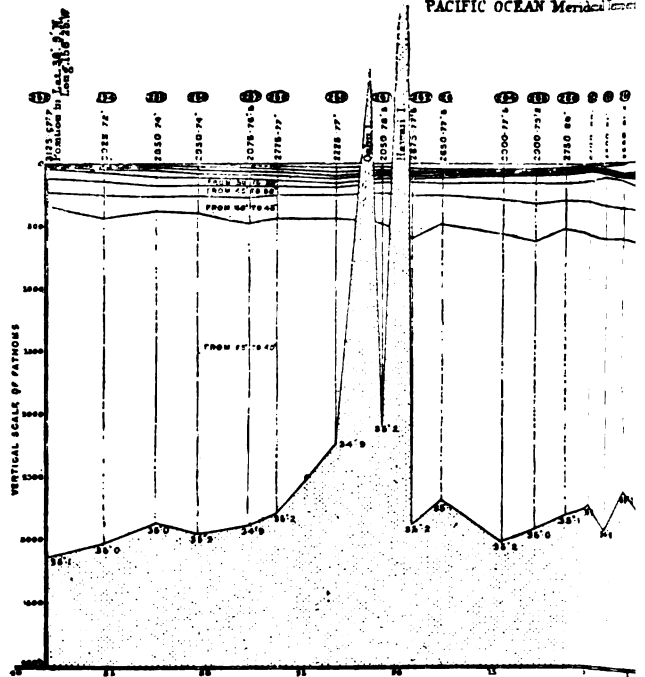
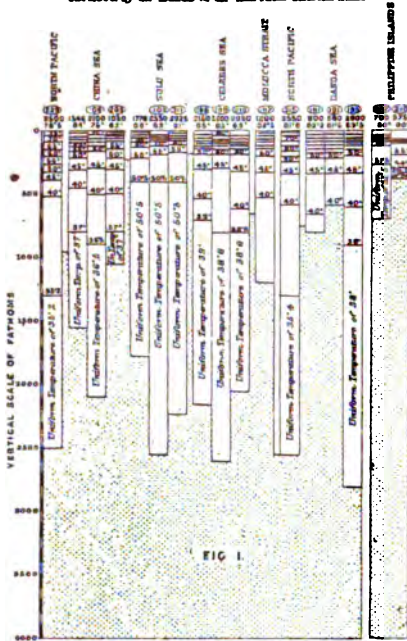



Diagram showing the Distribution of Temperature in the Seas enclosed by the Islands of the EASTERN ARCHIPELAGO



Vertical Temperature Section From the Parallel of 38° N. to the Parallel of 40° S.

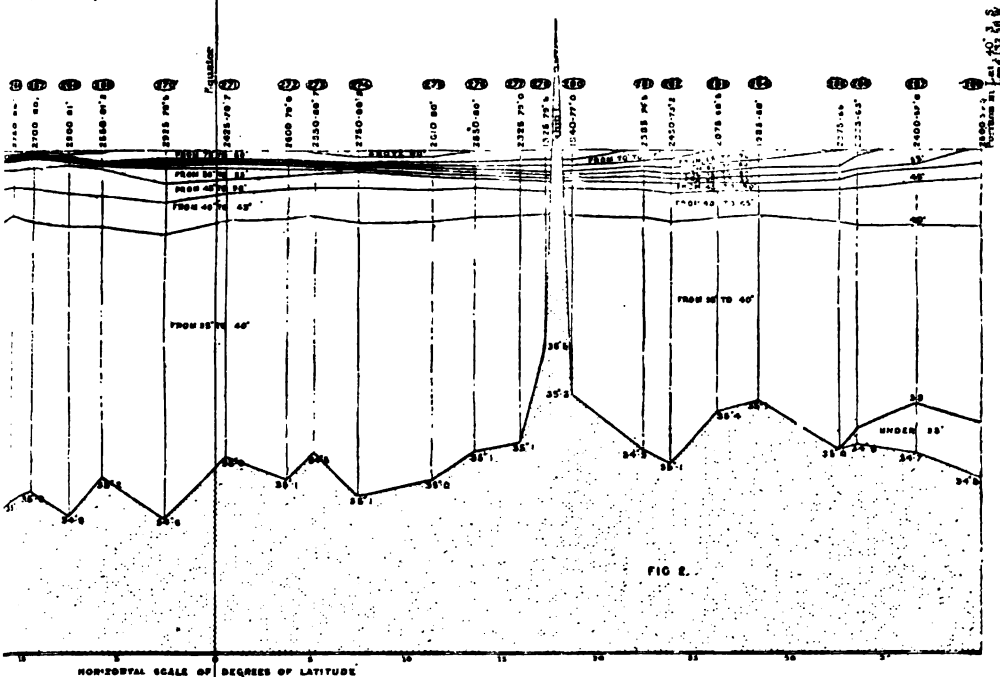
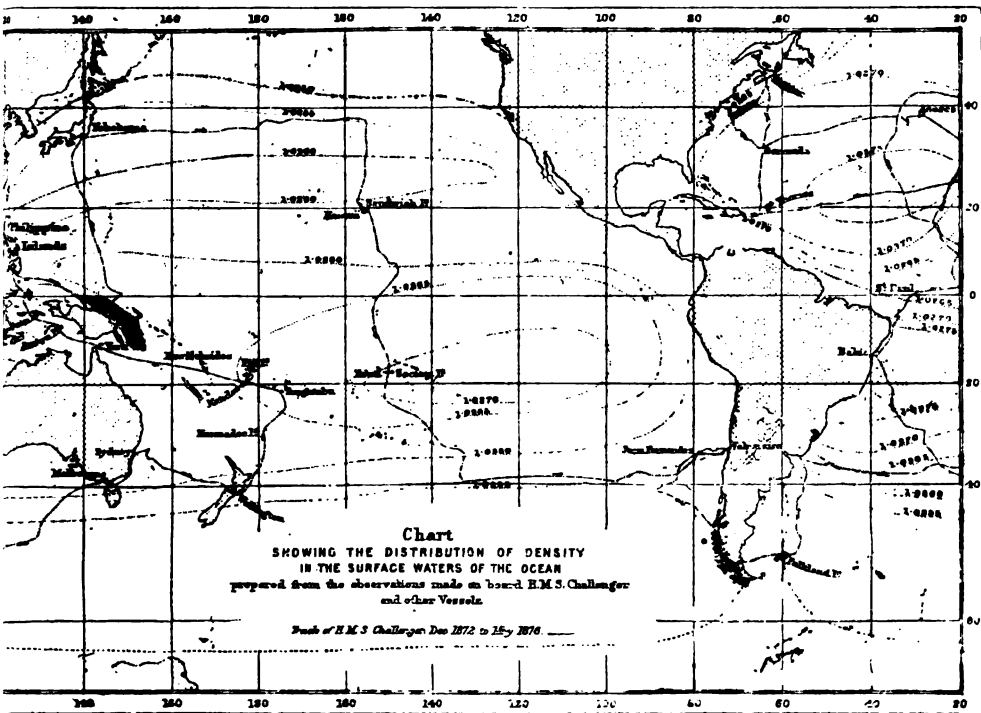
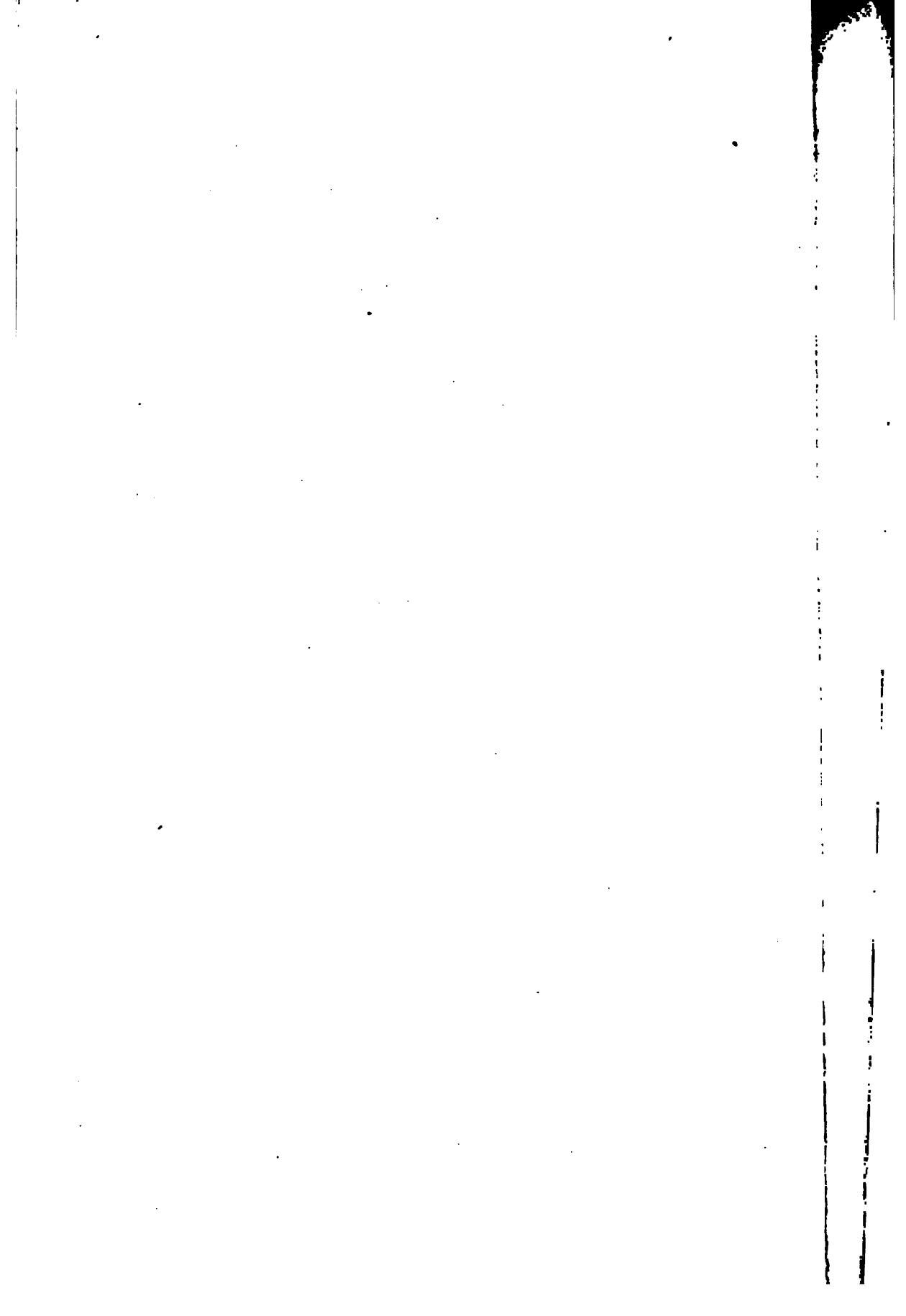
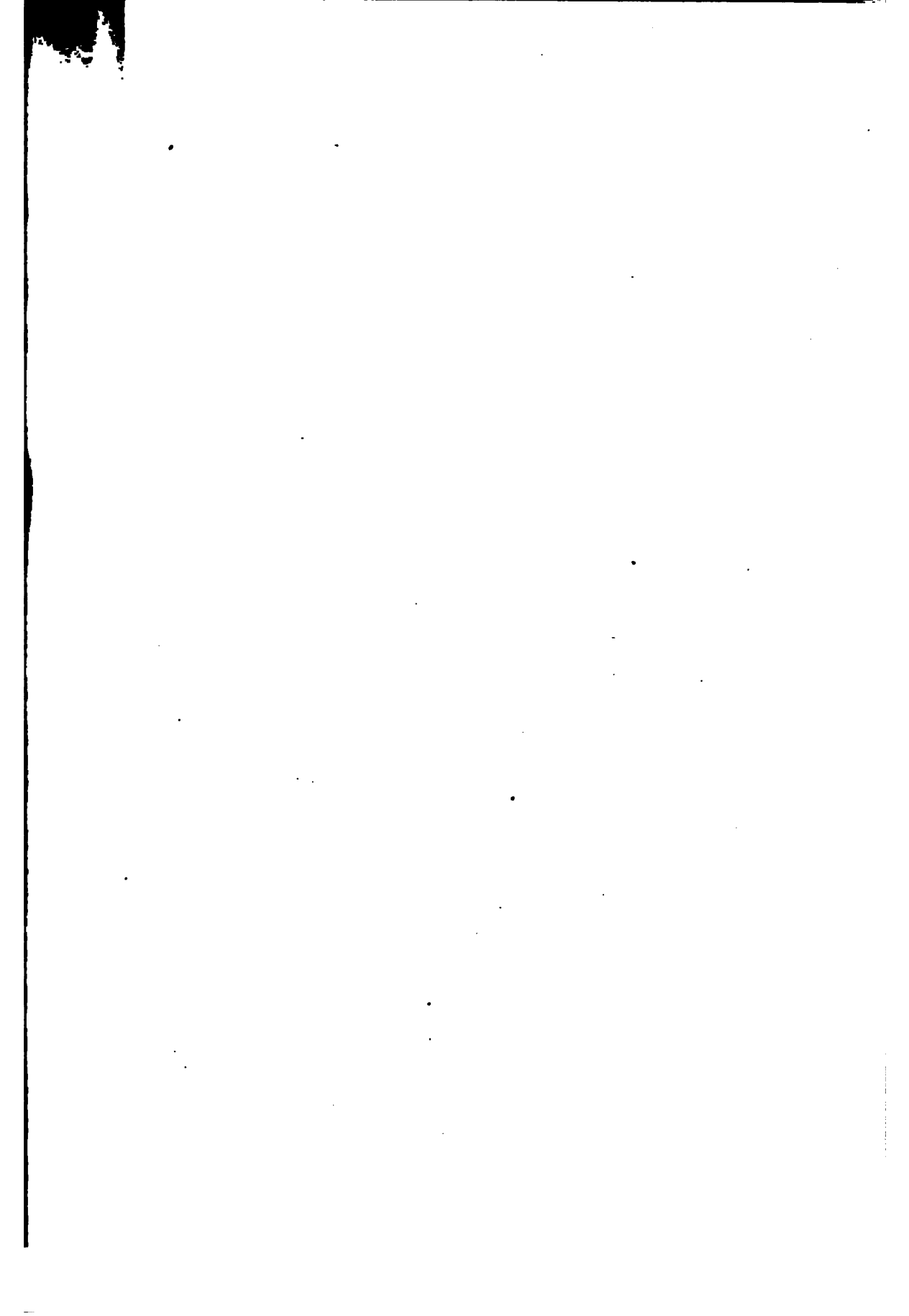
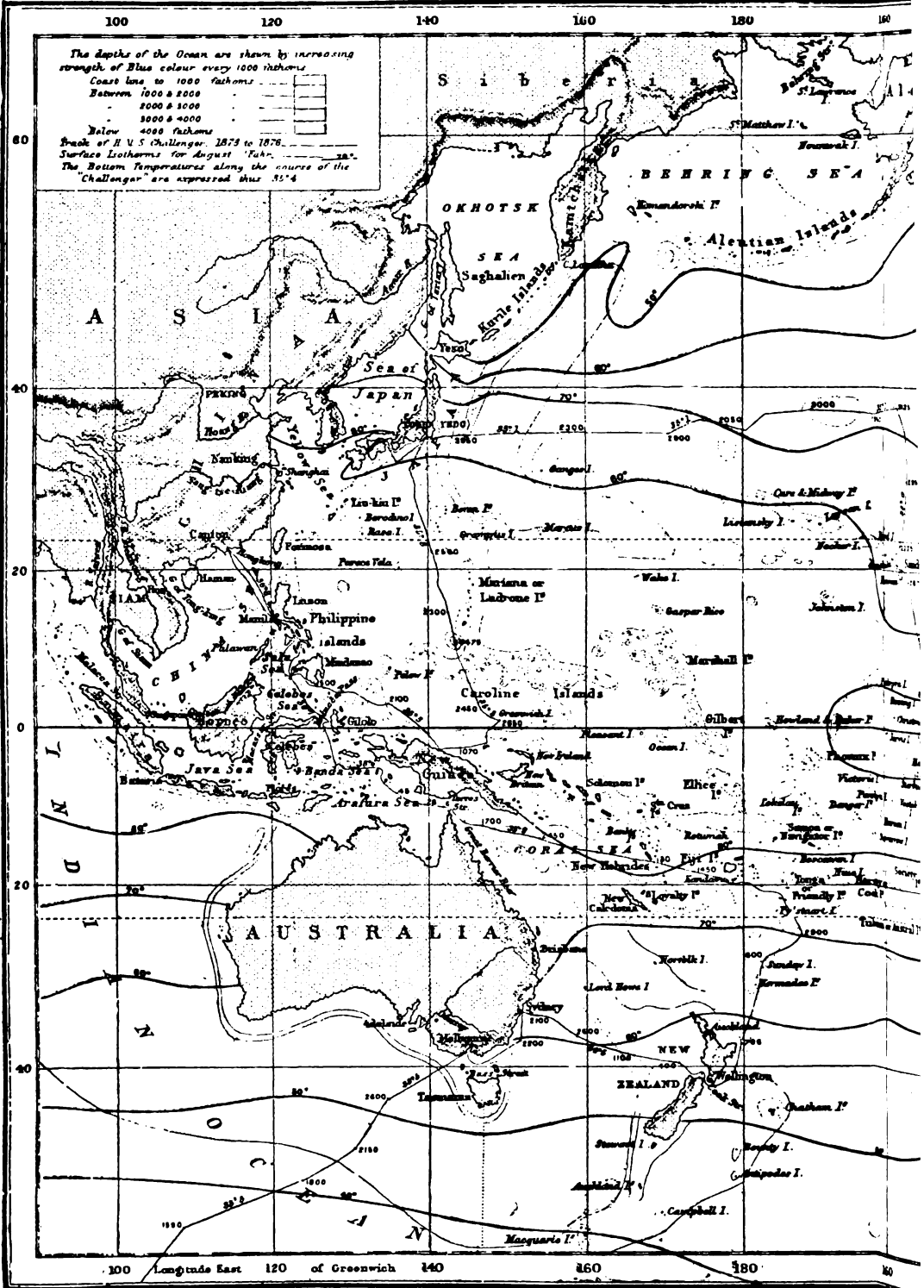

FIG. 2.









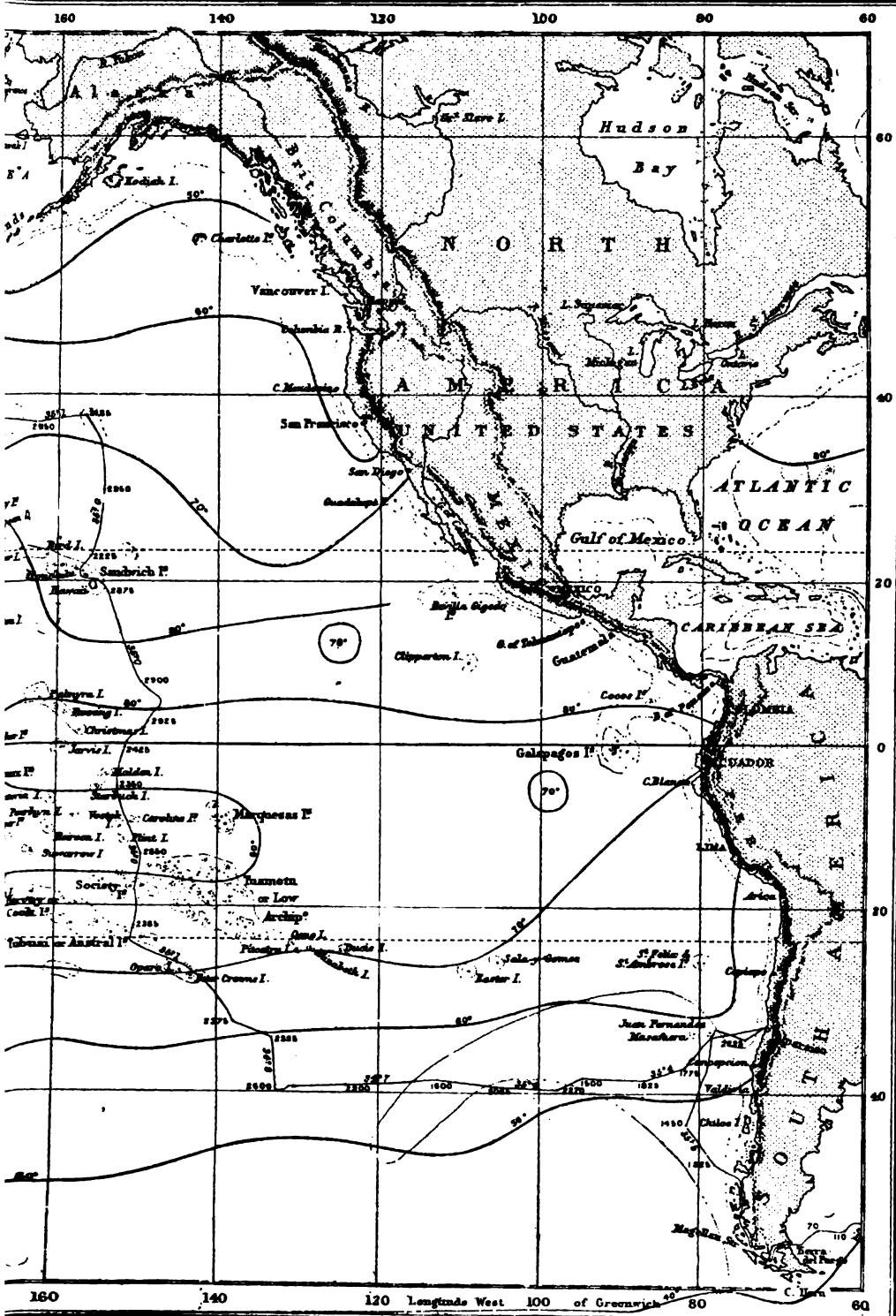



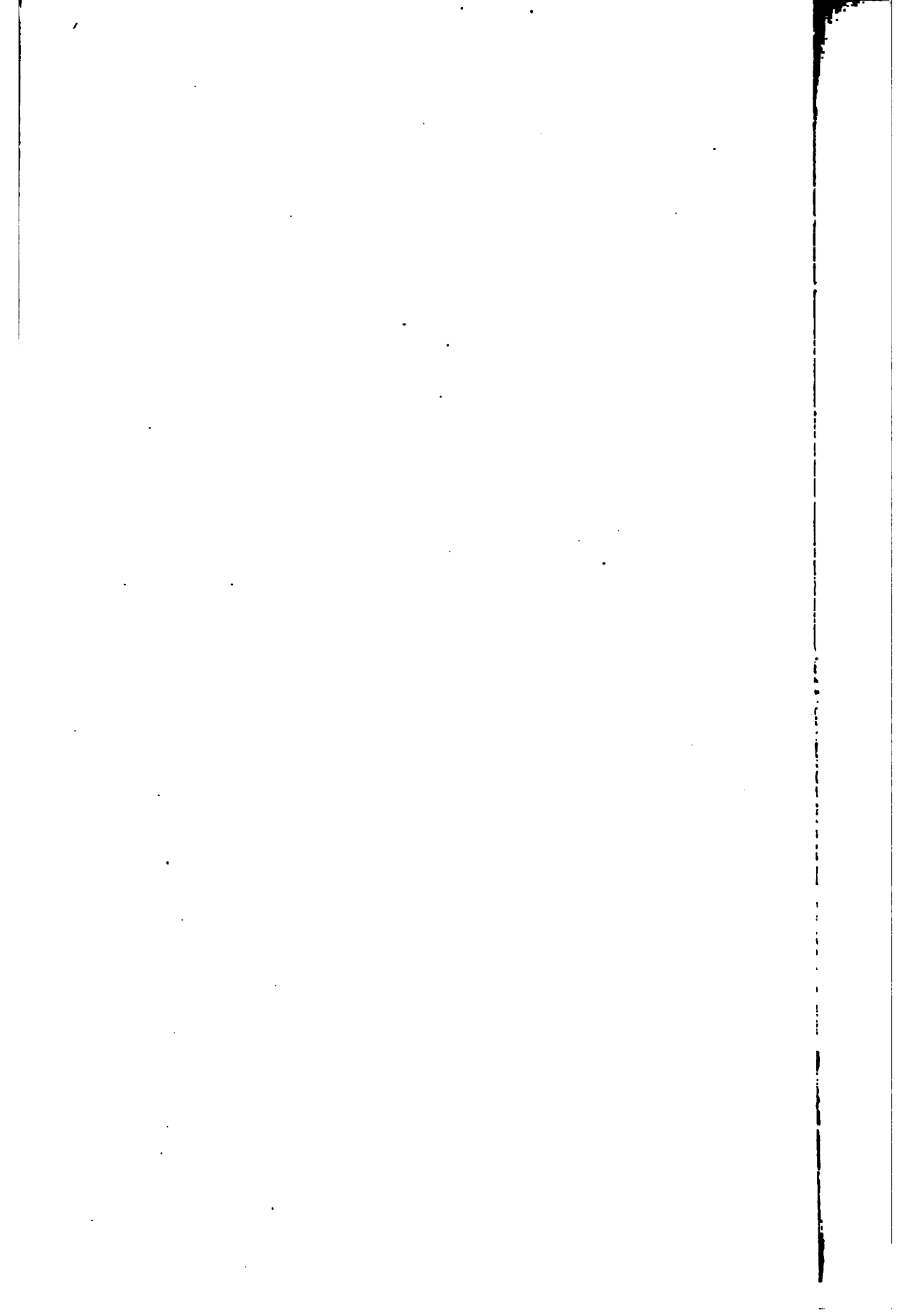

Sulaiman, who visited China in the 9th century, declared that he had sailed upon it. But for several hundred years the reports continued so uncertain, and were so loaded with the wild extravagance of travellers' tales of the period, that it is difficult to get at the facts from which they probably took their origin. During the 13th and 14th centuries Marco Polo and his successors travelled far to the East and came to an ocean of the extent of which they were ignorant, but they partially explored its western coasts. The East was the region towards which all the commerce and enterprise of the Middle Ages tended, and it was the hope of finding a safer and shorter sea route to India that led the Spanish court in 1492 to furnish Columbus with a fleet for the exploration of the Western Ocean. Although convinced of the spherical form of the earth, he greatly underrated its size, and, accepting the popular estimate of the great breadth of the Asiatic continent, he set out on his voyage confident of soon reaching "the Indies." The glowing descriptions of his discoveries in that strange new world of the West that rose up before him to bar his advance immediately attracted the attention of adventurous Spanish mariners. Headed by Columbus himself, they cruised intrepidly amongst the Caribbean Islands, still lured by the hope of discovering some western passage to the coveted East. Columbus found that what he at first considered a labyrinthine archipelago was a continent of vast extent, but not Asia, and he died without knowing what lay beyond. Spain and Portugal were the rival maritime powers at that time, and both took up the search for new countries with great ardour. Pope Alexander VI, in 1493, fearing that the two nations would quarrel over their colonies, assigned all the new lands that might be discovered west of the Azores to Spain, and all east of these islands to Portugal. The Portuguese accepting the gift followed Vasco da Gama in opening up the road to India by the Cape of Good Hope, and pushed forward their trading and piratical excursions into the west Pacific far beyond the Spice Islands. The Spaniards confined themselves to the New World, visiting, naming, and plundering the West India Islands and the headlands of Central America. On the 29th of September 1513 Vasco Núñez de Balboa, the leader of a Spanish party exploring the Isthmus of Panama, saw, from the summit of a mountain, a vast ocean stretching to the west—the very ocean of whose existence Columbus was certain, and which he had so long tried vainly to discover. Because he first saw it on Michaelmas day, Balboa named it the *Golfo de San Miguel*. Magellan, following the east coast of America farther to the south than any previous explorer, sailed on, in spite of terrific storms, until he found the strait which now bears his name, and, steering carefully through it, on the 27th of November 1520 he swept into the calm waters of that new sea on which he was the first to sail, and which he named the *Mar Pacifico*.

The victories of Cortez in Mexico about the same date opened the way for the exploration of the west coast of America, where Pizarro's conquest of Peru in 1526 gave the Spaniards a firm footing. From this time an intermittent trade sprang up between Europe and the Pacific through Magellan Strait, and latterly round Cape Horn. Before long English fleets, attracted more by the prospects of plundering Spanish galleons than of discovering new territories, found their way into the Pacific. Sir Francis Drake, like Balboa, saw the ocean from the Isthmus of Panama. He entered the Pacific in September 1577, being the first Englishman to sail upon it; some months later he sailed across it to the Moluccas. Alvaro de Mardana, who preceded him, had discovered the Solomon Islands in 1567.

Tasman, Roggewein, Dampier, and other explorers of the

17th century discovered Australia, New Zealand, Tasmania, and many smaller groups of islands. During the 18th century the voyages of Anson, Bass, Behring, the two Bougainvilles, Broughton, Byron, Cook, La Pérouse, and many more practically completed the geographical exploration of the Pacific Ocean. In the beginning of that century the Pacific had a curious fascination for commercial speculators, and the ill-fated Scottish colony founded at Darien in 1698 seemed only to prepare the way for the English South Sea bubble that burst in 1720. All the navigators who explored these seas believed in the existence of a north-west passage between the Atlantic and Pacific, and made attempts to find it; but its discovery baffled all enterprise until 1850, when Maclure proved that there was such a channel, but that the ice prevented its being of any commercial utility. In the present century D'Entrecasteaux, Krusenstern, Beechy, Fitzroy, and Bennet have taken the lead amongst geographical explorers in the Pacific, although the ranks contain many names scarcely less worthy of remembrance. Within recent years several purely scientific exploring expeditions and British surveying vessels have examined the Pacific, investigating its depth, the nature and form of the bottom, the temperature of the water at various depths and its density, as well as the marine fauna and flora. Of those expeditions the voyages of the "Challenger," "Gazelle," and "Tuscarora" are the most important.<sup>1</sup>

*Extent.*—The Pacific Ocean<sup>2</sup> is bounded on the N. by Behring Strait and the coasts of Russia and Alaska, on the E. by the west coasts of North and South America; on the S. the imaginary line of the Antarctic Circle divides it from the Antarctic Ocean, while its western boundary is the east coast of Australia, the Malay Archipelago separating it from the Indian Ocean, and the eastern coasts of the Chinese empire. Some modern geographers place the southern limit of the Atlantic, Pacific, and Indian Oceans at the 40th parallel, and name the body of water which surrounds the earth between that latitude and the Antarctic Circle the Southern Ocean.<sup>3</sup>

Although differing from the Atlantic in its general form, being more nearly land-locked to the north, the Pacific resembles it in being open to the south, forming, in fact, a great projection northwards of that vast southern ocean, of which the Atlantic is another arm.

The Pacific is the largest expanse of water in the world, covering more than a quarter of its superficies, and comprising fully one-half of its water surface. It extends through 132 degrees of latitude, in other words, it measures 9000 miles from north to south. From east to west its breadth varies from about 40 miles at Behring Strait, where Asia and America come within sight of each other, to 8500 miles between California and China on the Tropic of Cancer, and to more than 10,000 miles on the Equator between Quito and the Moluccas, where the ocean is widest. The area has been variously estimated at from 50,000,000 to 100,000,000 square miles; but, defining its boundaries as above, Keith Johnston, from careful measurements, estimated it, with probably a near approach to the truth, at 67,810,000 square miles.

<sup>1</sup> The principal ocean tracks followed by trading vessels in the Pacific are three:—(1) round Cape Horn and along the South American coast—the great rush to California on the discovery of gold in 1847 led to the establishment of lines of fast clippers by this route and of steamers from Panamá to San Francisco; (2) from San Francisco to China a regular service was established in 1867; (3) the mails began to be carried from Australia to San Francisco in 1873 and to Panama in 1866. The trade with the Pacific will no doubt be greatly increased when the Panama ship-canal is opened for traffic.

<sup>2</sup> Formerly called the South Sea, and sometimes still so named by the French and Germans (*la Mer du Sud*; *Südassee*, *Australocean*), with whom, however, *La Mer (L'Océan) Pacifique*, and *Grosser Ocean* or *Stilles Meer* are the more usual designations.

*Coasts, Seas, &c.*—The coast-line of the Pacific and Indian Oceans, taken together, only amounts to 47,000 miles; that of the Atlantic alone measures 55,000, the smaller ocean more than making up for its less extent by its numerous inland seas and inlets of smaller size. Speaking broadly, the eastern boundary of the Pacific is rugged, barren, mountainous, and singularly free from indentations, while its western shores are low, fertile, and deeply indented with gulfs and partially enclosed seas. Behring Strait unites the Arctic Ocean with the Sea of Kamchatka, or Behring Sea, which is bounded on the east by the irregular, low, swampy shores of Alaska, and on the south by the Alaskan peninsula and the Aleutian Islands. Along British North America the coast is rugged, rocky, considerably indented, and, between the parallels of 50° and 60° N. lat., fringed with islands. The largest of these are Vancouver Island in the Gulf of Georgia, Queen Charlotte Island, Prince of Wales Island, and the islands of King George III's Archipelago. The Gulf of California runs northwards in the Mexican coast, reaching from 23° to 32° N. lat. It is the one important inlet on the whole west coast of America,—the only others which are worth naming being the Gulf of Panama and the Gulf of Guayaquil. The Mexican shore is low, and contrasts with the coasts to the north and to the south, which are generally steep and rocky, though there are occasional sandy beaches in Peru and Chili. The breadth of the plain between the Rocky Mountains and the sea gradually diminishes towards the south, and the mountain chain of the Andes runs close along the west coast of South America to the very extremity of the continent.

A series of volcanoes, active and extinct, runs round the Pacific, commencing at Cape Horn, passing along the Andes and Rocky Mountains, crossing from the American continent by the Aleutian Islands to Kamchatka, and thence southwards by Japan and the East Indian Archipelago to New Zealand. Earthquakes are frequent all along this line.

There are few islands near the American coast north of Patagonia, and these are small and unimportant; but south of the 40th parallel there is a complete change. The end of the continent seems as if it had been shattered; there are abrupt bays and jagged chasms; archipelagos of small islands rise up in splintered fragments along the shore. The Strait of Magellan forms a tortuous channel between the mainland and the rocky storm-beaten islands of Tierra del Fuego.

The coast-line on the Asiatic side is longer and greatly diversified. In the north the Sea of Okhotsk is cut off from Behring Sea by the peninsula of Kamchatka, from the extremity of which a chain of islands extends to the borders of the Antarctic Ocean. These islands are of all sizes, ranging from small islets to the island continent of Australia. The island chain hangs in loops along the Asiatic coast, each loop including an almost land-locked sea. These partially enclosed seas are more or less completely cut off from the general oceanic circulation, and they consequently differ considerably from the open ocean as regards the temperature of the water, specific gravity, fauna and flora, and nature of the deposits. The Kurile Islands run from Kamchatka to Japan, cutting off the Sea of Okhotsk. The great Japanese Islands, with Saghalien to the north and the Chinese coast on the west, enclose the Sea of Japan, leaving it in communication with the Sea of Okhotsk by the Channel of Tartary to the north, with the ocean on the west by the Straits of La Pérouse and Sangar, and on the south by the Straits of Corea. The Yellow Sea runs into the Chinese coast, and is divided from the Sea of Japan by the peninsula of

Corea. The China Sea, with the two great gulfs of Tonquin and Siam, is marked off from the Indian Ocean by the peninsula of Malacca—remarkable because it runs in the same direction as the other two peninsulas of the Pacific, Kamchatka and Corea—and the islands of Sumatra and Java, while Borneo and the Philippine Islands separate it from the Pacific. Between the south coast of China and the north of Australia the East Indian Archipelago cuts up the ocean into a network of small seas and narrow channels. The seas are named the Celebes, the Banda, the Sulu, the Java, the Flores, and the Arafura. The more important of the sea passages between the islands are the Straits and Channel of Formosa, which lead northward from the Pacific to the China Sea; the Strait of Macassar between Borneo and Celebes; Molucca Passage between Celebes, the Moluccas, and Jilolo; and Torres Strait between New Guinea and Australia. The east coast of Australia is, as a rule, steep and rocky; there are few inlets, and none of them compare in size with the Gulf of Carpentaria on the north coast. Moreton Bay and Port Jackson are two of the best harbours, and as a haven the latter has few equals in the world. The Great Barrier Reef lies off this coast for a length of more than a thousand miles, the distance between it and the shore varying from 60 to 100 miles. Bass Strait separates Australia from Tasmania on the south; and the two main islands of New Zealand, separated by Cook Strait, lie to the south-east of the continent. The Gulf of Hauraki, the Bay of Plenty, and Pegasus Bay are the chief inlets in these islands.

*River-System.*—The drainage area of the Pacific Ocean is estimated at 8,660,000 square miles, while that of the Atlantic amounts to more than 19,000,000; the chief reason for this disparity is that only half a million square miles of the American continent are drained into the Pacific, the remaining six and a half millions being connected with the Atlantic river-system, and it is estimated that only one-seventh of the area of the Asiatic continent drains into the Pacific Ocean. The huge wall of the Andes practically reduces the Pacific rivers of South America to the rank of mountain streams; the Biobio and the Maypu in Chili are the only ones exceeding 100 miles in length,—the former having a course of 180, the latter of 160 miles. The Rocky Mountain chain, which forms the watershed of North America, runs parallel to the Pacific coast at a distance of about 1000 miles, and the Cascade and minor ranges which skirt the shore are broken through in several places to give passage to rivers that are, in some cases, of considerable size. The Colorado rises in the State of that name, at the base of the Rocky Mountains, flows south-west through Utah and Arizona, and falls into the head of the Gulf of California. Its course measures about 1100 miles, and it drains a rugged and barren area of 170,000 square miles. California has only one river, the Sacramento, 420 miles long. The Oregon (or Columbia) is formed by the union of two streams rising in the Rocky Mountains, one in British Columbia, the other in Idaho. It is a swift-flowing river, full of rapids and cataracts, and, though it is only 750 miles long, the area which it drains is greater by one-seventh than that drained by the Colorado. The ebb and flow of the tide are perceptible for a hundred miles from the mouth of the Oregon, and the river is navigable for that distance. The Frazer, which has a length of 600 miles, flows southward through British Columbia from the Rocky Mountains, and enters the sea in the Gulf of Georgia opposite Vancouver Island, carrying off the rainfall of 98,000 square miles. The northern limit of the American mountain chains is marked by the rise of the great river Yukon, which traverses Alaska; and, after a run of more than 2000 miles, it enters

Behring Sea opposite the island of St Lawrence. Its tributaries have not been fully explored, so the area which they intersect is unknown, but probably it is very large.

The Asiatic division of the Pacific river-system is very much more extensive than the American, and includes many streams of great size and of considerable commercial importance. In the north the Amur is more than 2000 miles long, and it receives many tributaries, which rise on the north in the Stanovoi mountains, and on the west and south on the borders of the great table-land of the Gobi, the central Asiatic desert; altogether its basin measures nearly 900,000 square miles. The Hoang-ho (Hwang-ho or Whang-ho) and the Yangtze-keang both rise near the Kuen-lun mountains of Tibet amongst the extensive terraces which form the eastern slope of the great table-land of Central Asia. The Hoang-ho has a length of 2600 miles, and in its course it sweeps in a northerly curve close to the In-Shan mountains; then, after being crossed repeatedly by the Great Wall of China, it turns sharply to the south, and finally runs due east into the Yellow Sea. The Yangtze-keang follows a southward direction from its source, but ultimately turns to the north-east and enters the Yellow Sea not far from the mouth of the Hoang-ho. It is one of the longest rivers in the world, for, including its windings, it measures 3200 miles from its source to the sea. These two rivers drain more than a million and a quarter square miles; and it is principally owing to the large amount of suspended matter which they carry down that the sea into which they fall is called the Yellow Sea. The other rivers of importance are the Choo-keang, the Mekong, and the Menam. The last two run into the Gulf of Siam, after watering the peninsula of Siam and Cochin China. Few rivers enter the Pacific on the east coast of Australia, and in consequence of the proximity of the mountains to the shore they are short and unimportant.

*Atmospheric Pressure and Prevailing Winds.*—When the mean atmospheric pressure for the year over the entire surface of the world is considered, it is found that there are two broad belts of high pressure which encircle the globe, one on each side of the equator. There is a wide area of slowly diminishing pressure between them, including a narrow central band along which the barometric readings attain a minimum. Two other regions of low pressure surround the poles, and extend to a considerable distance. That around the North Pole is connected with an area of still lower pressure over the North Pacific, and there is another permanent depression, which is even deeper, in the vicinity of Iceland. Atmospheric pressure is the fundamental meteorological phenomenon, and the mean pressure for the year affords a clue to the cause of all such regular and continuous phenomena as trade winds and ocean currents, and to the distribution of temperature. Similarly a study of the isobars at different seasons throws light upon all periodical occurrences in the way of winds and currents.

A low barometer is always accompanied by a high percentage of atmospheric aqueous vapour; consequently the equatorial belt of continuous low pressure is a region of almost continuous rain, excessive cloud, and constant calm or light variable winds. The effect of a difference in atmospheric pressure being established between two places is to produce a flow of air from the region of high towards that of low pressure, and the winds in their turn largely determine the surface movements or drift currents of the ocean. The region of calms between the north and south trades in the Pacific is both narrower, more irregular, and less clearly marked than the corresponding belt in the Atlantic. In the East Pacific it lies, at all seasons, considerably north of the equator; but during the southern

summer it is found south of the line in the western parts of the ocean, and disappears entirely in the northern summer, as the calms of the Indian Ocean do also. The reason of the southern position of the west end of the calm belt seems to be the simultaneous occurrence of low atmospheric pressure in the interior of Australia and an exceptionally high barometer in Asia. In the southern winter the depression over Asia and the increase of pressure over Australia form an unbroken barometric gradient, and the result is that the calms are replaced by a southerly breeze of great regularity. The region of calms included between the zones of the two trade winds, and towards which they blow, is not the only one with which they are associated; for the opposite meteorological conditions that characterize the northern border of the north-east trades and the southern margin of the south-east winds produce two fringing bands of calms. These regions are characterized by a high barometer, a sunny sky, and occasionally sudden squalls,—contrasting with the depressed barometer and dull, wet weather of the equatorial region. In January the low atmospheric pressure over the North Pacific produces winds which affect the climatological conditions of the shores in very different ways. At Vancouver Island the prevailing wind is south-west, and consequently the winter on the shores of British Columbia is mild and moist. The opposite coast of Asia is visited during the same season by northerly winds,—north-east in Alaska, north-north-east in Kamchatka, and north-west in Japan; and, as a result, the weather in these regions in winter is dry and bitterly cold. The West Pacific and the Indian Ocean are the regions of monsoons,—winds that blow as steadily as the trades, but which change their direction with the season. During the periods of transition the steady breeze gives place to variable winds, occasional calms, and sometimes terrific hurricanes. The general direction of the monsoons in the Pacific between April and October is southerly and south-easterly, and from November to April they blow from the north-east, and on nearing the continent of Asia from the north-west. Monsoonal winds are found connected with all continents; they are produced by the great differences in the temperature and pressure which prevail over the land at different seasons as compared with the adjacent ocean. The monsoons give rise to oceanic currents which flow in the same direction as the wind, and like it run opposite ways during alternate half years. Although the velocity of the wind over the open sea is always greater than that near shore or on land, it was shown by the observations of the "Challenger," in the Pacific and other oceans, that there is no distinct diurnal variation in the wind's force at sea, though very decided periods of maxima and minima were noticed in the vicinity of land (see METEOROLOGY, vol. xvi. p. 125).

*Currents.*—The system of surface circulation in the Pacific is much more complicated and less clearly defined than that in the Atlantic, as might be expected from the less constant character of the winds. The latter ocean has two wide channels of communication with the Arctic Sea, while, so far as currents are concerned, the Pacific is land-locked to the north—Behring Strait being narrow and shallow; consequently water enters the Pacific almost entirely from the south, where there is uninterrupted communication with the Antarctic Ocean. There is no direct information as to the movements of ocean water at depths greater than 200 or 300 fathoms; it is known, however, from indirect evidence, that movements do occur. Although the subject of under-currents at depths less than those just mentioned has been extensively studied, it is only with respect to surface currents that anything very definite is as yet known.

The vast extent of the Pacific Ocean gives full scope for the current-producing action of tides and winds, while the smooth continental boundary on its eastern side, the numerous groups of islands which break its surface, and its indented western coast, combine to modify the direction of the main streams and to produce innumerable minor currents, some permanent, and others varying from time to time in velocity and direction. The chief cause of these currents is believed to be traceable to the direct or indirect action of wind; but here it is proposed to refer merely to their general geography and physical effects, without discussing the theory of their formation.

A general surface drift of the cold waters of the Antarctic Ocean, having a temperature lower than 40° Fahr. at all seasons, bears north-east towards Cape Horn, where it divides into two branches; one, the Cape Horn current, passes on into the Atlantic, and the other sweeps northward along the west coast of South America until it strikes the Peruvian shore, which deflects it westward. The cooling effect of this current on the water all along the coast is illustrated very clearly by the abrupt northward turn of the isothermals (see METEOROLOGY, figs. 8 and 9), which is more conspicuous in the chart for the southern winter than in that for the summer. In summer, however, there is a more striking evidence of this current's cooling power to be seen in the arrangement of the isothermals. The northern line of 70° Fahr. reaches as far south as 18° N. lat., and that of 80° makes a short loop from 18° N. to the equator; but the southern isothermal of 80° does not touch the American coast at all, and that of 70° lies farther from the equator than 30° S. lat., so that the increase of temperature from the south is very gradual; so much so that at the Galapagos Islands, under the equator, the temperature of the surface water is only 70°, while a few hundred miles to the west it is over 80°. Penguins—essentially Antarctic birds—are found living on the shores of these islands. In consequence of this current, the highest surface temperature at all seasons of the year is found distinctly to the north of the equator in the eastern Pacific.

The Peruvian current forms the southern fork of the great equatorial current, which runs due west. This current is very broad, and divided by a narrow counter-current flowing in an opposite direction through its centre. The two branches of the equatorial current occupy very approximately the two areas of falling barometer between the north and south belts of high pressure and the central trough of minimum barometric readings. This difference of atmospheric pressure on each side produces the north-east and south-east trade winds, and to these the current probably owes its regularity and constant direction. The counter-current lies in the narrow belt of low barometric pressure to which the trades blow, and probably originates from the banking up of the waters to the westward. Its rate and position consequently vary greatly at different times of the year. The "Challenger," on her cruise between the Sandwich and Society Islands, found these currents to run with considerable force. In the "Narrative" of the cruise (chap. xviii.) the fact is alluded to thus:—

"From Hawaii Island to the 10th parallel the direction of the current was westerly, and its average velocity 18 miles per day, ranging from 10 to 23 miles. From the 10th to the 6th parallel the direction was easterly, and its average velocity 31 miles per day, ranging from 7 to 54 miles per day. From the 6th parallel of north latitude to the 10th parallel of south latitude the direction was again westerly, and the average velocity 35 miles per day, ranging from 17 to 70 miles per day. From thence to Tahiti the general tendency of the current was westerly, but its velocity was variable. The axis of greatest velocity of the counter-equatorial current was between the 7th and 8th parallels of north latitude. The axis of greatest velocity of the equatorial current was on the parallel of 2° north, where its speed amounted to 3 miles per hour."

The equatorial current strikes on the East Indian Archipelago, where it is split up by the narrow channels and shallow waters, and diverted into numberless minor currents. The two main divisions, which have acquired a high temperature from prolonged exposure to the tropical sun, ultimately leave the archipelago; the southern arm curves southwards, carrying its warm water to the east coast of Australia and to New Zealand, whence it is diverted towards the east, and becomes merged again in the general north-easterly antarctic drift. The north equatorial current, which varies in volume and velocity with the monsoons, strikes the coast of Asia between the Philippines and Japan, and is deflected in a north-easterly direction as the Kuro-Siwo or Japan current—wholly a warm oceanic river during the S.E. monsoon similar to the Gulf Stream of the Atlantic. The Japan current sends many branches into the inland seas and channels of the north-eastern coast of Asia, but the main body of water flows northward until it bifurcates in 40° N. lat., sending one fork among the Kurile Islands and along the Kamchatka peninsula into Behring Sea, whence it escapes by Behring Strait into the Arctic Ocean. A small counter-current of arctic water flows southward through Behring Sea, but it is not of sufficient volume to make its influence felt very decidedly on the general temperature of the surface water in the vicinity. The second and larger branch of the Japan current crosses the North Pacific, and, curving southward by Alaska and British Columbia, part of it returns as the north equatorial current, while the rest forms the variable Mexican current that runs along the coasts of California and Mexico.

The general direction of surface circulation in the Pacific may be remembered by supposing the ocean divided into a northern and southern half by the equatorial counter-current. In the northern half the water circulates in the direction of the hands of a watch, i.e., it passes up the west coast and down the east, while in the southern half the rotation is in the opposite direction—down the west coast and up the east; but the latter half does not exhibit the complete cycle so distinctly as the former. The centre of each area of circulation is occupied by a small Sargasso Sea, the northern being the more clearly defined, but neither approaches the well-known Sargasso Sea of the North Atlantic either in definiteness, extent, or amount of weed.

*Temperatures of Surface Water.*—The distribution of temperature in the surface water of the Pacific varies considerably during the year. The equatorial region is of course comparatively little affected by the change of season, but there is a general rise of temperature in the northern parts of the ocean, and a fall in the southern, during the northern summer, and a similar rise in the south and fall in the north during winter. The charts exhibit a general northward move in the isothermals during the former season, and a southward tendency in the latter. The change in the position of the lines is greatest in the temperate zones. The charts of ocean surface temperature (see METEOROLOGY, figs. 8, 9) for February and August show the direction of the isothermals at two opposite seasons; and reference to them will make it plain that in temperate regions the lines of equal temperature follow the parallels of latitude much more closely in the Pacific than in the Atlantic, while their displacement with the change of season takes place in a direction nearly north and south. There are notable instances of divergence from these rules, such as the peculiarity of the isothermal of 80° already alluded to. Another circumstance is the fact that the temperature of the surface water on the western side of a great continent is much lower than that on the eastern side in the same latitude; it seems as if the west side of

a continent attracted the isothermals, making them converge towards the equator. It has already been pointed out that these effects are due to the winds and the cold currents which strike the western continental shores and run along the coasts. The surface temperature of the Pacific, between the latitudes of 45° N. and 45° S., nowhere at any season falls below 50°. In August the southern isotherm of 50° remains close to the 50th parallel, not diverging more than a degree or two on either side. Between the 45th parallels and the northern and southern limits of the ocean the temperature is almost always below 50°. The southern isotherm of 40° is remarkable for its constant position all the year round, between latitudes 55° and 58°,—a result brought about by the gigantic antarctic icebergs which prevent the surface temperature of the water from rising during the southern summer.

The northern and southern "isocrymes" of 68°, that is the lines which pass over water which has a mean temperature of 68° during the coldest months of the year, lie, according to Dana (*Corals and Coral Islands*, 1872), between the latitudes of 20° and 30° on each side of the equator, except in the neighbourhood of the South-American coast, where the isocryme runs north in a loop beyond the equator,—a consequence of the cooling effect of the Peruvian current. These isocrymes mark out an area of great importance; for the reef-building corals are confined within it.

The highest temperature which sea water has been observed to attain is 90° F., and water of this temperature is only met with in the Red Sea. The maximum in the Pacific in the month of August is reached in the boundary between it and the Indian Ocean (in the Malay Archipelago) and in a narrow strip along the Mexican coast; in both these regions the thermometer immersed in the surface water registers 85° as a mean. There is a considerable area which in August stretches between New Guinea and Japan, from 10° S. to nearly 30° N., where the surface temperature reaches 84°, but these are exceptional temperatures.

When the "Challenger" was cruising in the South Pacific—in 1874 and 1875—the water was found to be uniformly warmer than the air, the difference in temperature between the two averaging 1°·5 to 2° Fahr. In the North Pacific, between the latitudes of 30° and 40°, on the other hand, the atmospheric temperature is about half a degree higher than that of the surface water. Such differences may be explained by considering the effect of warm and cold currents, which alter the temperature of the water much more rapidly than that of the air, and of warm and cold winds, which affect the atmosphere more quickly than the ocean.

**Deep-Sea Temperature.**—The serial temperature soundings of the "Challenger" in the Pacific give a very good idea of the distribution of temperature in the deeper waters. There seems to be a slow massive movement of water from the Antarctic Ocean into the Pacific, which is not confined to the surface currents, but affects the whole mass of water down to the bottom. The rate of this motion is quite unknown. In the open sea, far from coasts and barriers, the temperature of the water continually decreases as the depth increases. This is only true for the open ocean, fully exposed to the effects of the mass movement of the water; there is a very different distribution of temperature in enclosed seas such as those of the Western Pacific, or even in the ocean when a barrier presents itself to the moving water. The difference, which is brought out by the diagram (Plate II. fig. 1), is due to the fact that when a barrier exists it retards the motion of the lower portion of the water, which has the lowest temperature, while the higher passes on over it, and fills up the

area beyond with water at the uniform temperature of the great ocean at the point to which the top of the ridge or obstruction reaches. In the Sulu Sea, for instance, the diagram shows<sup>1</sup> that the temperature falls steadily and rapidly from 80° at the surface to 50°·5 at 400 fathoms, and then continues at 50°·5 right down to the bottom in 2500 fathoms, instead of sinking to somewhere about 35°, as it is observed to do in the open ocean at that depth. The inference is that the Sulu Sea is surrounded by a ridge rising to at least about 400 fathoms from the surface, which prevents the great ocean circulation from having its cooling effect, and soundings indicate that this is really the case. A study of the temperature phenomena, such as those just referred to, points out with considerable certainty the existence and height of barriers and ridges in many parts of the ocean, where their presence has not been detected by actual soundings.<sup>2</sup>

During the cruise of the "Challenger" the bottom temperature over the North Pacific was found to be 35°·1; south of the Sandwich Islands it fell to 35°; in the Low Archipelago it again rose to 35°·1; on the 40th parallel it fell to 34°·7 in the deep water, but rose to 35°·4 and 35°·5 in the shallow water of the Patagonian elevation. The thermometer registered 34°·5 at the bottom between Australia and New Zealand; while in that part of the ocean to the north-east of Australia known as the Coral Sea, although the depth was the same (about 2500 fathoms), the bottom temperature was as high as 35°·9. The variations of temperature in the enclosed seas of the Eastern Archipelago were found to be considerable, and nearly all those seas show the phenomenon of constant temperature from an intermediate point to the bottom, consequent on the existence of barriers. The chief details of the thermal conditions of these seas are represented graphically in the diagram (Plate II. fig. 1). Between the Caroline Islands and Japan the bottom temperature was 35°·3. The bottom temperature in the Pacific is on the average about 1° F. lower than that in the Atlantic.

The temperature of the water at the depth of 300 fathoms is nearly the same (40° to 45°) over the whole of the North Pacific, but above 300 fathoms the water is warmer in the western than in the central portion, while below that depth it is colder in the former than in the latter. The same phenomenon is noticed between the latitudes of 34° S. and 40° S., but here 700 fathoms marks the plane of constant temperature. Between 33° N. and 40° S. the temperature of the water above 200 fathoms is higher in the North than in the South Pacific, whilst from 200 to 1500 fathoms it is lower in the North, and below the latter depth the condition reverts to what it was above 200 fathoms.

The diagram (Plate II. fig. 2) exhibits the bathymetrical distribution of temperature in a section of the Pacific from a position in 88° 9' N. lat. and 156° 25' W. long. to one in 40° 8' S. lat. and 182° 58' W. long. as determined by H.M.S. "Challenger" in 1875, and may be compared with similar diagrams of the ATLANTIC (see vol. iii. p. 28). In order to separate the isothermals in the first 200 fathoms sufficiently the scale of depths required to be made large, while in order that the length of the diagram might be kept within reasonable bounds the scale of latitude was made very much smaller. The result of this is to exaggerate the inequalities of the sea bottom, making the slopes very much steeper than they are; this effect is best seen in the way in which islands are represented. The rapid falling off of temperature in the first few hundred fathoms, and then its very slow but steady decrease to the bottom are to be observed, and the fact that latitude has a great effect on the surface temperature, but

<sup>1</sup> The encircled numbers in the diagrams (Plate II. figs. 1 and 2) indicate the "Challenger" stations.

<sup>2</sup> An excellent example of the existence of a submarine barrier being pointed out by a wide divergence in the temperature in contiguous areas of the ocean is met with in the Faroe Channel (see *NORWEGIAN SEA*, vol. xvii. p. 594, and *NORTH SEA*, p. 564, fig. 1).



none at considerable depths, for the isotherm of 40° is constantly between 300 and 400 fathoms, and also that depth alone determines the bottom temperature in the open ocean, the coldest water occurring as a matter of fact under the equator in the deepest troughs open to the south.

*Density of the Water.*—The specific gravity of ocean water is an index of its salinity, since the researches of various chemists, foremost amongst whom are Forchhammer and Dittmar, have shown conclusively that the percentage composition of the salts in sea water is the same in all parts of the ocean, so far at least as regards the principal constituents. Mr J. Y. Buchanan made continuous observations on the specific gravity of sea water during the whole voyage of the "Challenger," and has published a very valuable paper on the distribution of salt in the ocean in the "Challenger" Reports (*Phys. Chem. Chall. Exp.*, vol. i. part ii.). The chart in Plate II. showing the geographical distribution of surface density is copied from that paper. The percentage of total salts in sea water, as deduced from the specific gravity, is, according to Buchanan and Dittmar—

Density.....	1.025	1.026	1.027	1.028
Percentage.....	3.3765	3.5049	3.6343	3.7637

The density of the water in different parts of the ocean must obviously change to a certain extent with the season; and it is not only the surface density that is affected in this way; any cause which promotes evaporation tends to increase the salinity of surface water, while any conditions that effect condensation of aqueous vapour produce dilution. For instance, in the China Sea during the month of November, at the end of the south-west monsoon, which is a moist wind accompanied by much rain, the specific gravity observed was 1.02518, and two months later, after the dry north-east monsoon had been blowing for some time, evaporation had proceeded so far that the specific gravity had risen to 1.02534. The climate is the principal factor in determining surface salinity, and the causes which produce well-marked climatic conditions have an equally apparent effect on the density of the water. Thus there are two zones of comparatively high density encircling the globe in the region of the north-east and south-east trade winds, which are dry and promote rapid evaporation; and similarly the region of calms and rain between the trades is distinguished by the low specific gravity of the water. North and south of these areas there are two zones where the salinity maintains a mean value, in consequence of there being a balance between evaporation and condensation; and round the poles there are areas of concentration brought about by the freezing of the sea water and the separation of salt, which of course increases the salinity of the water remaining unfrozen.

The distribution of density differs considerably in the two great oceans. In the Atlantic there are two areas of high specific gravity, one in the north, the other in the south; while in the Pacific there is only one, situated in the southern division of the ocean in the neighbourhood of the Society Islands. It is neither so large as those of the Atlantic, nor has it so high a specific gravity. The density of the concentration areas in the Atlantic, taking pure water at 4° C. as unity, is 1.02750; that in the saltiest portion of the Pacific is only 1.02706. In the North Pacific the salinity is less than in the South, and its distribution is much more uniform. The density in this region never exceeds 1.02650, and the minimum, in the rainy region of the equatorial counter current, is as low as 1.02485. The South Pacific has water of a relatively high density, its maximum being 1.02750. The water of the seas of the Eastern Archipelago, in the western basin of the Pacific, although exposed to the full force of an equatorial sun, and possessed of a very high surface temperature, is yet surprisingly fresh. The specific

gravity varies considerably with the season, but the average for the year over the greater part of these seas is under 1.02550; and there is a large area surrounding the islands of Java and Sumatra where the dilution is greater, the hydrometer only indicating 1.02500. The weak salinity of these waters is largely to be attributed to the extreme humidity of the atmosphere, the frequent and heavy rains, and the fact that so many lofty and extensive islands, where the annual rainfall rises above 200 inches, drain into the seas. Water of such a degree of dilution is not met with anywhere else, except near the mouths of rivers and in the vicinity of melting ice, and, as a temporary phenomenon, after prolonged rain in the tropics.

In regions where there is decided and continuous concentration in progress, the specific gravity of the water is greatest at the surface and decreases as the depth increases, down to about 800 or 1000 fathoms, after which the density increases slowly with the depth until the bottom is reached. The density of the bottom water of the Pacific is almost the same everywhere; it only varies from 1.02570 to 1.02590; and the same value holds for the South Atlantic. The North Atlantic has denser water at the bottom, varying from 1.02616 to 1.02632. In those regions where the surface water is being constantly diluted, as is the case in the equatorial belt of calms, the density increases with the depth down to between 50 and 100 fathoms; where there is a maximum, from which the density diminishes, as in the other case, to about 1000 fathoms, and afterwards increases slowly down to the bottom. There is a striking resemblance between the direction of the isohalines, or lines of equal salinity, and of the isothermals; but the parallelism breaks down, of course, in the case of a subsurface maximum.

*Depth.*—For a long time the opinion that the Pacific was a comparatively shallow ocean was entertained by geographers, and it is only the recent soundings of the "Challenger," "Tuscarora," "Gazelle," and other surveying ships that have succeeded in dispelling the illusion. It is now known that the average depth of the Pacific is greater than that of the Atlantic, and that areas of deeper water occur in it than in any other part of the globe. A line running along the western shores of the two Americas and along the eastern shores of the Asiatic continent more or less closely follows a great circle of the globe. On the one side of this line there are the continental masses of the Americas and of Europe and Asia, with an average height of about 800 feet above the level of the sea; and on the other side the vast oceanic depression of the Pacific, with an average depth of about 2500 fathoms. The average level of the continental area may thus be regarded as about three miles above the Pacific depression.

The attempt to divide the ocean into sharply defined basins is more or less unsatisfactory; and for the consideration of the depth it is better to view the Pacific as marked off into two portions by an imaginary line passing through Honolulu and Tahiti, on the meridian of 150° W.

The eastern half is remarkable for the comparative absence of islands and the uniform nature of its depth. With the exception of the narrow strip of shallow water surrounding the Aleutian Islands and running along the American coast, the sounding line shows an average depth of from 2000 to 3000 fathoms undiversified by remarkable elevations or depressions, between the northern limit of the ocean and 50° S. lat. There is a great submarine plateau extending from the Patagonian coast (in 76° W. long.) in a westerly direction to 120° W. long., which rises to between 2000 and 1000 fathoms of the surface. This elevated area diminishes in breadth as it proceeds westward, but it is supposed by some authorities to be

connected with the shallow water surrounding the Low Archipelago and the Marquesas Islands (groups which are bisected by the 140th meridian of west longitude) and the Society Islands. If this be the case there is an almost continuous area of elevation stretching between Patagonia and Japan. It has been remarked that many of the submerged plateaus of the Pacific have a south-east to north-west trend. The "Challenger" examined the depth of the eastern half of the Pacific in 1875, along a line which extended from 38° N. lat. on the 160th meridian south-east to the Sandwich Islands, and then as nearly as possible along the 150th meridian to the Society Islands in 23° S. lat. From this point the course was again south-east to the 40th parallel of south latitude, which was followed eastward to the Patagonian coast, a visit to Juan Fernandez forming a northward digression. The depth was ascertained at fifty points along this route, and it was found to vary on the whole from 2000 to 3000 fathoms. There were two soundings of over 3000 fathoms between latitudes 38° and 36° N., and one a little to the south of the Sandwich Islands. Between the meridian of 120° W. and the coast of America the soundings showed the depth to vary considerably as the ship was in deep water or over the submerged Patagonian plateau. The actual numbers observed proceeding eastward from 120° W. long. were in fathoms:—2250, 1600, 2025, 2270, 1500, 1825, 1775, 1375, 2160, 2225, 1450, 1325. The soundings made by the United States ship "Tuscarora" during 1874 were much more numerous, closer together, and extended along several lines, but the general result was similar to that of the "Challenger" observations. The results of all recent observations are shown on Plate III.

The western half of the Pacific Ocean is a complete contrast to the eastern. Archipelagos and scattered islands are exceedingly numerous; the depth of the ocean is by no means uniform, for shallows and areas of unusual depth occur scattered over it at irregular intervals. Along the Asiatic coast and between the island groups there are a number of partially enclosed seas, and these are separated from the great ocean by submarine plateaus of sufficient extent and height to warrant the supposition that a moderate upheaval would extend the Asiatic continent as far south as Australia, transforming the seas into inland salt lakes. Considerations of the peculiar animal and vegetable life of New Zealand and Australia lend some degree of probability to the speculation that these islands were joined to the main continent of Asia at some very remote period; and it is even possible to trace the submerged coast-line of the great continent which then existed. This line separates the very deep water of the West Pacific from the shallower water of the inland seas and archipelagos; it runs from Kamchatka, over Japan, Formosa, the Philippines, New Guinea, to Australia and New Zealand. The most conspicuous peculiarity of the West Pacific is the very deep water lying in a crescent shape to the east of the Kurile Islands and Japan. It extends from 50° N. lat. to nearly 20° N. lat., although it is of no great breadth. The average depth of this area is nearly 4000 fathoms, and a narrow strip of still more abysmal depths runs along its western margin, like a ditch across the entrance to the Sea of Okhotsk; here the United States ship "Tuscarora" found depths of over 4600 fathoms. The course of the "Challenger" led her to explore the seas of the Eastern Archipelago pretty thoroughly, and she carried a line of soundings from the archipelago to Japan, and thence eastward across the Pacific, crossing the area of great depth about the centre, off Nippon, where two soundings of 3950 and 3625 fathoms respectively were obtained. Like the East Pacific, the western division of the ocean has an average depth of from 2000 to 3000 fathoms, although a

great number of small depressions exist where the depth is greater, and detached areas of shallower water occur still more frequently. Many of the islands rise from depths of about 3000 fathoms, forming isolated mountains springing from the bed of the ocean, and several peaks which do not rise to the surface have been detected. More usually a number of islands are bound together by submarine elevations, frequently within a few hundred fathoms of the surface, over wide areas. Although the greater part of the sea surrounding New Zealand, the north of Australia, and the adjacent islands is under 1000 fathoms in depth, there are areas of great depression amongst the islands, and some very deep channels. In 1875 when sounding in the channel between the Carolines and Ladrones, the "Challenger" met with the deepest water of the cruise, 4475 fathoms, or about five miles and a quarter; and this is the greatest depth from which a specimen of the bottom has hitherto been obtained. This abysmal depth only extends over a relatively small area, for the two nearest "Challenger" stations, one to the north and one to the south, had depths of 2300 and 1850 fathoms respectively.

The seas branching off from the Pacific are usually relatively shallow. Behring Sea on the north has extremely shallow water in its north-eastern half, where there is a depth of under 100 fathoms; in the south-western portion the depth increases rapidly to between 1000 and 2000 fathoms, except round the coasts and the Aleutian Archipelago. The Sea of Okhotsk is still shallower: much of it is within the 100 fathom line; and in its deepest part it does not attain 1000 fathoms. The Yellow Sea is entirely within the hundred fathom line; while the Sea of Japan, only separated from it by the Korean Peninsula, is not inferior in depth to the open ocean, its average depth being from 2000 to 3000 fathoms. The western portion of the Pacific, which lies between the Philippines and the Carolines and Ladrones, is also very deep, its mean depth approaching 3000 fathoms. This sea is of importance, since it is to the Pacific what the Gulf of Mexico is to the Atlantic—the source of its great northern thermal current. The fact that the temperature at 1500 fathoms over the whole of the North Pacific does not differ by more than 0·5 F. from that at the bottom appears to indicate that this portion is cut off from the southern division by a ridge rising to within 1500 fathoms of the surface. The existence of such a barrier cannot be said to be proved, but the indications lead to the supposition that it may extend from Japan to the equator, through the Bonin the Ladrones, and the Caroline Islands.

Taken altogether, so far as present knowledge goes, the bed of the Pacific is more uniform than that of the Atlantic; and its changes of level are less abrupt. Its depth is, on an average, greater, and appears to be more evenly distributed than in the Atlantic, but this apparent greater uniformity may be partly due to the fact that the latter ocean, both on account of its smaller size and its greater commercial importance, has been much more carefully surveyed, and its bathymetrical conditions more exactly ascertained.

#### DEPOSITS.

The explorations of the "Challenger," "Tuscarora," and other surveying ships have in recent years given a great amount of information respecting the nature of the deposits now forming over the floor of the ocean, and the specimens collected by these expeditions have been made the subject of a careful investigation by Messrs Murray and Benard. The great extent and depth of the Pacific Ocean make it the most suitable field for the study of the varieties of deep-sea deposits and the conditions under which they are found. The various kinds of deposits, all of which are found in the Pacific Ocean, are classed as follows:—

Terrigenous deposits.	Shore formations.	Found in inland seas and along the shores of continents.
	Blue mud.	
	Green mud and sand.	
	Red mud.	
Pelagic deposits.	Coral mud and sand.	Found around oceanic islands and along the shores of continents.
	Coralline mud and sand.	
	Volcanic mud and sand.	
	Red clay.	
	<i>Globigerina</i> ooze.	Found in the abyssal regions of the oceanic basins.
	Pteropod ooze.	
	Diatom ooze.	
	Radiolarian ooze.	

The *terrigenous deposits* are found in more or less close proximity to the land, and are chiefly made up of the triturated fragments carried down into the ocean by rivers, or worn away from the coasts by waves or currents. Those found in the deeper water surrounding the land differ from the sands, gravels, and shingles of the shore and shallow water chiefly in the smaller size of the grains and the greater abundance of clayey matter and remains of oceanic organisms. As, however, the water becomes still deeper and the distance from land greater, the deposits assume, more and more, a deep-sea character until they pass into a true pelagic deposit.

The principal mineralogical constituents of the terrigenous deposits near continental land are isolated fragments of rocks and minerals coming from the crystalline and schisto-crystalline series, and from the clastic and sedimentary formations; according to the character of the nearest coasts they belong to granite, diorite, diabase, porphyry, &c., crystalline schists, ancient limestones, and the sedimentary rocks of all geological ages, with the minerals which come from their disintegration, such as quartz, monoclinic and triclinic feldspars, hornblende, augite, rhombic pyroxene, olivine, muscovite, biotite, titanite and magnetic iron, tourmaline, garnet, epidote, and other secondary minerals. The trituration and decomposition of these rocks and minerals give rise to materials more or less amorphous and without distinctive characters, but the origin of which is indicated by association with the rocks and minerals just mentioned.

Mixed with these are found in many places phosphatic nodules, large quantities of glauconite, and minerals arising from chemical action probably in presence of organic matter.

*Blue mud* is the most extensive deposit now forming around the great continents and continental islands, and in all enclosed or partially enclosed seas. It is characterized by a slaty colour, which passes in most cases into a thin layer of a reddish colour at the upper surface. These deposits are coloured blue by organic matter in a state of decomposition, and frequently give off an odour of sulphuretted hydrogen. When dried, a blue mud is greyish in colour, and rarely or never has the plasticity and compactness of a true clay. It is finely granular, and occasionally contains fragments of rocks 2 cm. in diameter; generally, however, the minerals which are derived from the continents, and are found mixed up with the muddy matter in these deposits, have a mean diameter of 0.5 mm. and less. Quartz particles, often rounded, play the principal part; next come mica, feldspar, augite, hornblende, and all the mineral species which come from the disintegration of the neighbouring lands, or the lands traversed by rivers which enter the sea near the place where the specimens have been collected. These minerals make up the principal and characteristic portion of blue muds, sometimes forming 80 per cent. of the whole deposit. Glauconite, though generally present, is never abundant. The remains of calcareous organisms are at times quite absent, but occasionally they form over 50 per cent. The latter is the case when the specimen is taken at a considerable distance from the coast and at a moderate depth. These calcareous fragments consist of bottom-living and pelagic *Foraminifera*, Mollusca, *Polysia*, *Serpula*, Echinoderms, Alcyonarian spicules, Corals, &c. The remains of Diatoms and Radiolarians are usually present. Generally speaking, as the shores are approached the pelagic organisms disappear; and, on the contrary, as we proceed seawards the size of the mineral grains diminishes, and the remains of shore and coast organisms give place to pelagic ones, till finally a blue mud passes into a true deep-sea deposit. In those regions of the ocean affected with floating ice, the colour of these deposits becomes grey rather than blue at great distances from land, and is further modified by the presence of a greater or less abundance of glaciated blocks and fragments of quartz. These deposits are found along the coasts of North and South America, and in all the enclosed and partially enclosed seas, such as the Japan Sea, China Sea, Arafura Sea, Sulu Sea, Banda Sea, Celebes Sea, Sea of Okhotsk, &c.

At some points in the same regions are found *green muds* and *sands*, which, as regards their origin, composition, and distribution near the shores of continental land, resemble the blue muds. They are largely composed of argillaceous matter and mineral particles of the same size and kind as the blue muds. Their chief characteristic is the presence of a considerable quantity of glauconitic grains, either isolated or united into concretions by a brown argillaceous matter. The *Foraminifera* and fragments of Echinoderms and other organisms in these muds are frequently filled with glauconitic substance, and beautiful casts of these organisms remain after

treatment with weak acid. At times there are few calcareous organisms in these deposits, and at other times the remains of Diatoms and Radiolarians are abundant. When these muds are dried they become earthy and of a grey-green colour. They frequently give out a sulphuretted hydrogen odour. The green colour appears sometimes to be due to the presence of organic matter, probably of vegetable origin, and to the reduction of peroxide of iron to protoxide under its influence. The green sands differ from the muds only in the comparative absence of the argillaceous and other amorphous matter, and by the more important part played by the grains of glauconite, to which the green colour is chiefly due. *Red mud* is found where quantities of ochreous matter are brought down by rivers and deposited along the coast, as in the Yellow Sea, but it is most characteristic in the Atlantic off the Brazil coast of America.

In addition to the terrigenous deposits above referred to, volcanic muds and sands and coral muds and sands are found around the shores of oceanic islands either of volcanic or coral origin. The *volcanic muds and sands* are black or grey, and when dried are rarely coherent. The mineral particles are generally fragmentary, and consist of lapilli of the basic and acid series of modern volcanic rocks, which are scoriaceous or compact, vitreous or crystalline, and usually present traces of alteration. The minerals are sometimes isolated, sometimes surrounded by their matrix, and consist principally of plagioclases, sanidine, amphibole, pyroxene, biotite, olivine, and magnetic iron; the size of the particles diminishes with distance from the shore, but the mean diameter is generally 0.5 mm. Glauconite does not appear to be present in these deposits, and quartz is also very rare or absent. The fragments of shells and rocks are frequently covered with a coating of peroxide of manganese. Shells of calcareous organisms are often present in great abundance, and render the deposit of a lighter colour. The remains of Diatoms and Radiolarians are usually present.

*Coral muds* frequently contain as much as 95 per cent. of carbonate of lime, consisting of fragments of Corals, calcareous algae, *Foraminifera*, *Serpula*, Mollusca, and remains of other lime-secreting organisms. There is a large amount of amorphous calcareous matter, which gives the deposit a sticky and chalky character. The particles may be of all sizes according to the distance from the reefs, the mean diameter being 1 to 2 mm., but occasionally there are large blocks of coral and large calcareous concretions; the particles are white and red. Remains of siliceous organisms seldom make up over 2 or 3 per cent. of a typical coral mud. The residue consists usually of a small amount of argillaceous matter, with a few fragments of feldspar and other volcanic minerals; but off barrier and fringing reefs facing continents there may be a great variety of rocks and minerals. Beyond a depth of 1000 fathoms off coral islands the debris of the reefs begins to diminish, and the remains of pelagic organisms to increase; the deposit becomes more argillaceous, of a reddish or rose colour, and gradually passes into a *Globigerina* ooze or a red clay. *Coral sands* contain much less amorphous matter than coral muds, but in other respects they are similar, the sands being usually found nearer the reefs and in shallower water than the muds, except inside lagoons. In some regions the remains of calcareous algae predominate, and in these cases the name *coralline mud* or *sand* is employed to point out the distinction.

The extent and peculiarities of the region in which these terrigenous deposits are laid down are interesting. It extends from high-water mark down, it may be, to a depth of over 4 miles, and in a horizontal direction from 60 to perhaps 800 miles seawards, and includes all inland seas, such as the North Sea, Norwegian Sea, Mediterranean Sea, Red Sea, China Sea, Japan Sea, Caribbean Sea, and many others. It is the region of change and of variety with respect to light, temperature, motion, and biological conditions. In the surface waters the temperature ranges from 80° F. in the tropics to 28° F. in the polar regions. From the surface down to the nearly ice-cold water found at the lower limits of the region in the deep sea there is in the tropics an equally great range of temperature. Plants and animals are abundant near the shore, and animals extend in relatively great abundance down to the lower limits of the region, now marked out by these terrigenous deposits. The specific gravity of the water varies much, and this variation in its turn affects the fauna and flora. In the terrigenous region tides and currents produce their maximum effect, and these influences can in some instances be traced to a depth of 800 fathoms, or nearly 2000 feet. The upper or continental margin of the region is clearly defined by the high-water mark of the coast-line, which is constantly changing through breaker action, elevation, and subsidence. The lower or abyssal margin passes in most cases insensibly into the abyssal region, but may be regarded as ending where the mineral particles from the neighbouring continents begin to disappear from the deposits, which then pass into an organic ooze or a red clay.

The area covered by terrigenous deposits has been called the "transitional" or "critical area," and is estimated at about

two-eighths of the earth's surface, while the continents cover three-eighths, and the deep-sea deposits of the abyssal regions, which will now be considered, cover the remaining three-eighths.

The true deep-sea deposits may be divided into two classes, viz., those in which the organic elements predominate, and those in which the mineral constituents play the chief part. Belonging to the former class there are *Globigerina*, Pteropod, Diatom, and Radiolarian Oozes, and to the latter Red Clay.

*Globigerina oozes* is the name given to all those truly pelagic deposits containing over 40 per cent. of carbonate of lime which consist principally of the dead shells of pelagic *Foraminifera* (*Globigerina*, *Orbulina*, *Pulvinulina*, *Pullenia*, *Sphaeroidina*) and coccoliths and rhabdoliths. In some localities this deposit contains 95 per cent. of carbonate of lime. The colour is milky white, yellow, brown, or rose, the varieties of colour depending principally on the relative abundance in the deposit of the oxides of iron and manganese. This ooze is fine grained; in the tropics some of the *Foraminifera* shells are macroscopic. When dried it is pulverulent. Analyses show that the sediment contains, in addition to carbonate of lime,

phosphate and sulphate of lime, carbonate of magnesia, oxides of iron and manganese, and argillaceous matters. The residue is of a reddish-brown tinge. Lapilli, pumice, and glassy fragments, often altered into palagonite, seem always to be present, and are frequently very abundant. The mineral particles are generally angular, and rarely exceed 0.08 mm. in diameter; monoclinic and triclinic felspar, augite, olivine, hornblende, and magnetite are the most fre-

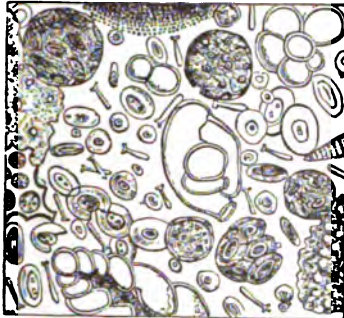

FIG. 1.—The finer particles of a *Globigerina* Ooze, showing Coccoliths, Cocco-spheres, and Rhabdoliths.

quartz. When quartz is present, it is in the form of minute, rounded, probably wind-borne grains, often partially covered with

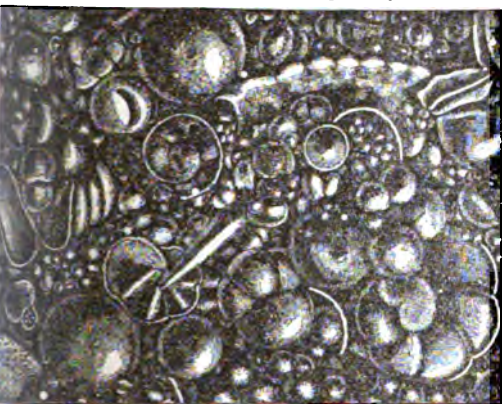

FIG. 2.—*Globigerina* Ooze from 1900 fathoms.

oxides of iron. More rarely there are white and black particles of mica, bronxite, actinolite, chromite, glauconite, and cosmic dust. Siliceous organisms are probably never absent, sometimes forming 20 per cent. of the deposit, while at other times they are only recognizable after careful microscopic examination. In some regions the frustules of Diatoms predominate, in other the skeletons of Radiolarians.

Pteropod ooze differs in no way from a *Globigerina* ooze except in the presence of a greater number and variety of pelagic organisms, and especially in the presence of Pteropod and Heteropod shells, such as *Diacria*, *Alvania*, *Styliola*, *Carinaria*, &c. The shells of the more delicate species of pelagic *Foraminifera* and young shells are also more abundant in these deposits than in a *Globigerina* ooze. It must be remembered that the name "Pteropod ooze" is not intended to indicate that the deposit is chiefly composed of the shells of these Mollusca, but, as their presence in a deposit is characteristic and has an important bearing on geographical and bathymetrical distribution, it is desirable to emphasize the presence of these shells in any great abundance. It may be pointed out that there is a very considerable difference between a *Globigerina* ooze or a Pteropod ooze situated near continental shores and

deposits bearing the same names situated toward the centres of oceanic areas, with respect both to mineral particles and to remains of organisms.

Diatom ooze is of a pale straw colour, and is composed principally of the frustules of Diatoms. When dry it is a dirty white siliceous flour, soft to the touch, taking the impression of the fingers, and contains gritty particles which can be recognized by the touch. It contains on an average about 25 per cent. of carbonate of lime, which exists in the deposit in the form of small *Globigerina* shells, fragments of Echinoderms and other organisms. The residue is pale white and slightly plastic; minerals and fragments of rocks are in some cases abundant; these are volcanic, or, more frequently, fragments and minerals coming from continental rocks and transported by glaciers. The fine washings consist essentially of particles of Diatoms along with argillaceous and other amorphous matter. It is estimated that the frustules of Diatoms and skeletons of siliceous organisms make up more than 50 per cent. of this deposit. It has been already mentioned that Radiolarians are seldom, if ever completely absent from marine deposits. In some regions they make up a considerable portion of a *Globigerina* ooze, and are also found in Diatom ooze and in the terrigenous deposits of the deeper water surrounding the land. In some regions of the Pacific, however, the skeletons of these organisms make up the principal part of the deposit, to which the name *Radiolarian ooze* has been given. The colour is reddish or deep brown, due to the presence of the oxides of iron and manganese. The mineral particles consist of fragments of pumice, lapilli, and volcanic minerals, rarely exceeding 0.07 mm. in diameter. There is not a trace of carbonate of lime in the form of shells in some samples of Radiolarian ooze, but other specimens contain 20 per cent. of carbonate of lime derived from the shells of pelagic *Foraminifera*. The clayey matter and mineral particles are the same as those found in the red clays, which will now be described.



FIG. 3.—Diatom Ooze from 1900 fathoms in the Antarctic Ocean.

Of all the deep-sea deposits red clay is the one which is distributed over the largest areas in the modern oceans. It might be said that it exists everywhere in the abyssal regions of the ocean basins, for the residue in the organic deposits which have been described under the names *Globigerina*, Pteropod, Diatom, and Radiolarian oozes is nothing else than the red clay. However, this deposit only appears in its characteristic form in those areas where the terrigenous minerals and calcareous and siliceous organisms disappear to a greater or less extent from the bottom. It is in the central regions of the Pacific that the typical examples are met with. Like other marine deposits, this one passes laterally, according to position and depth, into the adjacent kind of deep-sea ooze, clay, or mud.

The argillaceous matters are of a more or less deep brown tint from the presence of the oxides of iron and manganese. In the typical examples no mineralogical species can be distinguished by the naked eye, for the grains are exceedingly fine and of nearly uniform dimensions, rarely exceeding 0.05 mm. in diameter. It is plastic and greasy to the touch; when dried it forms lumps so coherent that considerable force must be employed to break them. It gives the brilliant streak of clay, and breaks down in water. The prognostic properties show that it is not a pure clay, for it fuses easily before the blowpipe into a magnetic bead.

Under the term red clay are comprised those deposits in which the characters of clay are not well pronounced, but which are mainly composed of minute particles of pumice and other volcanic material



FIG. 4.—Radiolarian Ooze from 4475 fathoms in Central Pacific.

Under the term red clay are comprised those deposits in which the characters of clay are not well pronounced, but which are mainly composed of minute particles of pumice and other volcanic material



which, owing to their relatively recent deposition, have not undergone great alteration. If the analyses of red clay are calculated, it will be seen, moreover, that the silicate of alumina present as clay ( $2SiO_2 \cdot Al_2O_3 + 2H_2O$ ) comprises only a relatively small portion of the sediment; the calculation shows always an excess of free silica, which is attributed chiefly to the presence of siliceous organisms.

Microscopic examination shows that a red clay consists of argillaceous matter, minute mineral particles, and fragments of siliceous organisms. The mineral particles are for the greater part of volcanic origin, except in those cases where continental matters are transported by floating ice, or where the sand of deserts has been carried to great distances by winds. These volcanic minerals are the same constituent minerals of modern eruptive rocks enumerated in the description of volcanic muds and sands; in the great majority of cases they are accompanied by fragments of lapilli and of pumice more or less altered. Vitreous volcanic matters belonging to the acid and basic series of rocks predominate in the regions where the red clay has its greatest development; and it will be seen presently that the most characteristic decompositions which there take place are associated with pyroxyenic lavas.

Associated with the red clay are almost always found concretions and microscopic particles of the oxides of iron and manganese, to which the deposit owes its colour. Again, in the typical examples of the deposit, zeolites in the form of crystals and crystalline spherules are present, along with metallic globules and silicates which are regarded as of cosmic origin. Calcareous organisms are so generally absent that they cannot be regarded as characteristic. On the other hand, the remains of Diatoms, Radiolarians, and Sponge spicules are generally present, and are sometimes very abundant. The ear-bones of various Cetaceans, as well as the remnants of other Cetacean bones and the teeth of sharks, are, in some of the typical samples far removed from the continents, exceedingly abundant, and are often deeply impregnated with, or embedded in thick coatings of, the oxides of iron and manganese. Over six hundred sharks' teeth, belonging to the genera *Carcharodon*, *Oxyrhina*, and *Lamna*, and one hundred ear-bones of whales, belonging to *Ziphius*, *Balenoptera*, *Balena*, *Orcas*, and *Delphinus*, along with fifty fragments of other bones, have been obtained in one haul of the dredge in the Central Pacific. The remains of these vertebrates have seldom been dredged in the organic ooze, and still more rarely in the terrigenous deposits.

The abyssal region, in which the true pelagic deposits above described are laid down, shows a marked contrast with the "transitional" or "critical area" where the terrigenous deposits are found. The former area comprises vast undulating plains from 2 to 5 miles beneath the surface of the sea, the average being about 3 miles, here and there interrupted by huge volcanic cones (the oceanic islands). No sunlight ever reaches these deep cold tracts. The range of temperature over them is not more than 7°, viz., from 31° to 38° F., and is apparently constant throughout the whole year in each locality. Plant life is absent, and, although animals belonging to all the great types are present, there is no great variety of form nor abundance of individuals. Change of any kind is exceedingly slow.

Leaving out of view the coral and volcanic muds and sands which are found principally around oceanic islands, the blue muds, green muds and sands, red muds, together with all the coast and shore formations, are situated along the margins of the continents and in enclosed and partially enclosed seas. The chief characteristic of these deposits is the presence in them of continental debris. The blue muds are found in all the deeper parts of the regions just indicated, and especially near the embouchures of rivers. Red muds do not differ much from blue muds except in colour, due to the presence of ferruginous matter in greater abundance, and they are found under the same conditions as the blue muds. The green muds and sands occupy, as a rule, portions of the coast where detrital matter from rivers is not apparently accumulating at a rapid rate, viz., on such places as the Agulhas Bank, off the east coast of Australia, off the coast of Spain, and at various points along the coast of America. In the tropical and temperate zones of the great oceans, which occupy about 110° of latitude between the two polar zones, at depths where the action of the waves is not felt, and at points to which the terrigenous materials do not extend, there are now forming vast accumulations of *Globigerina* and other pelagic *Foraminifera*, *Coccolitha*, *Rhabdolitha*, shells of pelagic Molluscs, and remains of other organisms. These deposits may perhaps be called the sediments of median depths and of warmer zones, because they diminish in great depths and tend to disappear towards the poles. This fact is evidently in relation with the surface temperature of the ocean, and shows that pelagic *Foraminifera* and Molluscs live in the superficial waters of the sea, whence their dead shells fall to the bottom. *Globigerina* ooze is not found in enclosed seas nor in polar latitudes. In the southern hemisphere it has not been met with south of the 50th parallel. In the Atlantic it is deposited upon the bottom at a very high latitude below the warm waters of the Gulf Stream, and is not observed under the cold descending polar current which

runs south in the same latitude. These facts are readily explained if it be admitted that this ooze is formed chiefly by the shells of surface organisms, which require an elevated temperature and a wide expanse of sea for their existence.

The distribution of oceanic deposits may be summarized thus. (1) The terrigenous deposits—blue muds, green muds and sands, red muds, volcanic muds and sands, coral muds and sands—are met with in those regions of the ocean nearest to land. With the exception of the volcanic muds and sands and coral muds and sands around oceanic islands, these deposits are found only lying along the borders of continents and continental islands, and in enclosed and partially enclosed seas. (2) The organic ooze and red clay are confined to the abyssal regions of the ocean basins; a Pteropod ooze is met with in tropical and subtropical regions in depths less than 1800 fathoms, a *Globigerina* ooze in the same regions between the depths of 500 and 2800 fathoms, a Radiolarian ooze in the central portions of the Pacific at depths greater than 2500 fathoms, a Diatom ooze in the Southern Ocean south of the latitude of 45° south, a red clay anywhere within the latitudes of 45° north and south at depths greater than 2200 fathoms.

As long as the conditions of the surface are the same, it might be expected that the deposits at the bottom would also remain the same. In showing that such is not the case, an agent must be taken into account which is in direct correlation with the depth. It may be regarded as established that the majority of the calcareous organisms which make up the *Globigerina* and Pteropod ooze live in the surface waters, and it may also be taken for granted that there is always a specific identity between the calcareous organisms which live at the surface and the shells of these pelagic creatures found at the bottom. *Globigerina* ooze is found in the tropical zone at depths which do not exceed 3400 fathoms, but when depths of 8000 fathoms are explored in this zone of the Atlantic and Pacific there is found an argillaceous deposit without, in many instances, any trace of calcareous organisms. Descending from the "submarine plateaus" to depths which exceed 2250 fathoms, the *Globigerina* ooze gradually disappears, passing into a greyish marl, and finally is wholly replaced by an argillaceous material which covers the bottom at all depths greater than 2900 fathoms.

The transition between the calcareous formations and the argillaceous ones takes place by almost insensible degrees. The thinner and more delicate shells disappear first. The thicker and larger shells lose little by little the sharpness of their contour and appear to undergo a profound alteration. They assume a brownish colour, and break up in proportion as the calcareous constituent disappears. The red clay predominates more and more as the calcareous element diminishes in the deposit. Recollecting that the most important elements of the organic deposits have descended from the superficial waters, and that the variations in contour of the bed of the sea cannot of themselves prevent the debris of animals and plants from accumulating upon the bottom, their absence in the red clay areas can only be explained by the hypothesis of decomposition.

Pteropod ooze, it will be remembered, is a calcareous organic deposit, in which the remains of Pteropods and other pelagic Molluscs are present, though they do not always form a preponderant constituent, and it has been found that their presence is in correlation with the bathymetrical distribution.

In studying the nature of the calcareous elements which are deposited in the abyssal areas, it has been noticed that, like the shells of the *Foraminifera*, those of the Thecosomatous *Pteropoda*, which live everywhere in the superficial waters, especially in the tropics, become fewer in number in the deposit as the depth increases. It has just been observed that the shells of *Foraminifera* disappear gradually along a series of soundings from a point where the *Globigerina* ooze has abundance of carbonate of lime, towards deeper regions; but it is also noticed that, when the sounding-rod brings up a graduated series of sediments from a declivity descending into deep water, among the calcareous shells those of the Pteropods and Heteropods disappear first in proportion as the depth increases. At depths less than 1400 fathoms in the tropics a Pteropod ooze is found with abundant remains of Heteropods and Pteropods; deeper soundings then, give a *Globigerina* ooze without these Molluscan remains; and in still greater depths, as has been said above, there is a red clay in which calcareous organisms are nearly, if not quite, absent.

In this manner, then, it is shown that the remains of calcareous organisms are completely eliminated in the greatest depths of the ocean. For if such be not the case, why are all these shells found at the bottom in the shallower depths, and not at all in the greater depths, although they are equally abundant on the surface at both places? There is reason to think that this solution of calcareous shells is due to the presence of carbonic acid throughout all depths of ocean water. It is well known that this substance, dissolved in water, is an energetic solvent of calcareous matter. The investigations of Buchanan and Dittmar have shown that carbonic acid exists in a free state in sea water, and Dittmar's analyses also show

that deep-sea water contains more lime than surface water. This is a confirmation of the theory which regards carbonic acid as the agent concerned in the total or partial solution of the surface shells before or immediately after they reach the bottom of the ocean, and is likewise in relation with the fact that in high latitudes, where fewer calcareous organisms are found at the surface, their remains are removed at lesser depths than where these organisms are in greater abundance. It has been shown that sea water itself has some effect in the solution of carbonate of lime, and further it is probable that the immense pressure to which water is subjected in great depths may have an influence on its chemical activity. Objections have been raised to the explanation here advanced, on account of the alkalinity of sea water, but it may be remarked that alkalinity presents no difficulty which need be here considered (Dittmar, *Phys. Chem. Chall. Exp.*, part 1, 1884).

This interpretation also explains how the remains of Diatoms and Radiolarians (surface organisms like the *Foramsinifera*) are found in greater abundance in the red clay than in a *Globigerina* ooze. The action which suffices to dissolve the calcareous matter has no effect upon the silica, and so the siliceous shells accumulate. Nor is this view of the ooze opposed to the distribution of the Pteropod ooze. At first it would be expected that the *Foramsinifera* shells, being smaller, would disappear from a deposit before the Pteropod shells; but if it be remembered that the latter are very thin and delicate, and for the quantity of carbonate of lime present, offer a larger surface to the action of the solvent than the thicker, though smaller, *Globigerina* shells, this apparent anomaly will be explained.

The origin of these vast deposits of clay is a problem of the highest interest. It was at first supposed that these sediments were composed of microscopic particles arising from the disintegration of the rocks by rivers and by the waves on the coasts. It was believed that the matters held in suspension were carried far and wide by currents, and gradually fall to the bottom of the sea. But the uniformity of composition presented by these deposits was a great objection to this view. It can be shown that mineral particles, one of the smallest dimensions, continually set adrift upon disturbed waters must, owing to a property of sea water, eventually be precipitated at no great distance from land. It has also been supposed that these argillaceous deposits owe their origin to the inorganic residue of the calcareous shells which are dissolved away in deep water, but this view has no foundation in fact. Everything seems to show that the formation of the clay is due to the decomposition of fragmentary volcanic products, whose presence can be detected over the whole floor of the ocean.

These volcanic materials are derived from floating pumice, and from volcanic ashes ejected to great distances by terrestrial volcanoes, and carried far by the winds. It is also known that beds of lava and of tufa are laid down upon the bottom of the sea. This assemblage of pyrogenic rocks, rich in silicates of alumina, decomposes under the chemical action of the water, and gives rise, in the same way as do terrestrial volcanic rocks, to argillaceous matters, according to reactions which can always be observed on the surface of the globe, and which are too well known to need special mention here.

The universal distribution of pumice over the floor of the ocean is very remarkable, and would at first appear unaccountable; but when the fact that pieces of pumice have been known to float in sea water for a period of over three years before becoming sufficiently waterlogged to sink is taken into consideration, it will be readily understood how fragments of this material may be transported by winds and currents to an enormous distance from their point of origin before being deposited upon the bottom. Fragments of pumice are dredged in the greatest profusion in the red clay of the Central Pacific, and much less abundantly in the orange ooze and terrigenous deposits. This is owing to the rate of deposition being much slower in the former than in the latter, where the rapid accumulation of calcareous and siliceous organisms and continental debris masks their presence.

The detailed microscopic examination of hundreds of soundings has shown that the presence of pumice, of lapilli, of silicates, and of other volcanic minerals in various stages of decomposition can always be demonstrated in the argillaceous matter.

In the places where the red clay attains its most typical development, the transformation of the volcanic fragments into argillaceous matter may be followed step by step. It may be said to be the direct product of the decomposition of the basic rocks, represented by volcanic glasses, such as hyalomelan and tachylite. This decomposition, in spite of the temperature approximating to zero (32° F.), gives rise, as an ultimate product, to clearly crystallized minerals, which may be considered the most remarkable products of the chemical action of the sea upon the volcanic matters undergoing decomposition. These microscopic crystals are zeolites lying free in the deposit, and are met with in greatest abundance in the typical red-clay areas of the Central Pacific. They are simple, twinned, or spheroidal groups, which scarcely exceed half a millimetre in diameter. The crystallographic and chemical study of them shows that they must be referred to christianite. It is known how easily the zeolites crystallize in the pores of eruptive rocks in process of

decomposition; and the crystals of christianite, which are observed in considerable quantities in the clay of the centro of the Pacific

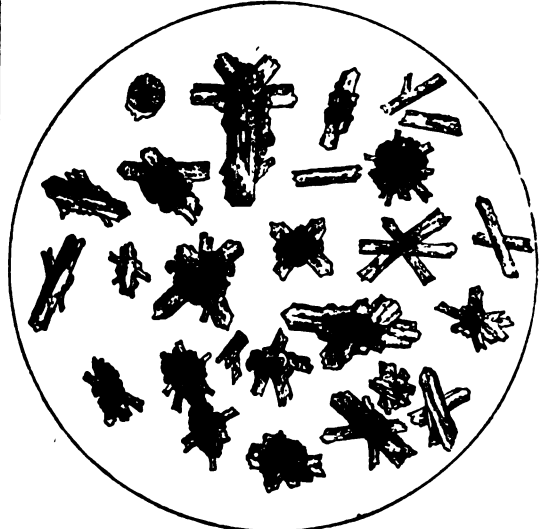

FIG. 5.—Crystals of Christianite from the deep water of the Pacific.

(fig. 5), have been formed at the expense of the decomposing volcanic matters spread out upon the bed of that ocean.

In connexion with this formation of zeolites, reference may be made to a chemical process which gives rise to the formation of nodules of manganiferous iron. These nodules are almost universally distributed in oceanic sediments, but are met with in the greatest abundance in the red clay. This association tends to show a common origin. It is exactly in those regions where there is an accumulation of pyroxenic lavas in decomposition, containing silicates with a base of manganese and iron, such for example as augite, hornblende, olivine, magnetite, and basic glasses, that manganese nodules occur in greatest numbers. In the regions where the sedimentary action, mechanical and organic, is, as it were, suspended, and where everything shows an extreme slowness of deposition,—in these calm waters favourable to chemical reactions, ferro-manganiferous substances form concretions around organic and inorganic centres.

These concentrations of ferric and manganic oxides, mixed with argillaceous materials whose form and dimensions are extremely variable, belong generally to the earthy variety or wad, but pass sometimes, though rarely, into varieties of hydrated oxide of manganese with distinct indications of radially fibrous crystallization. The interpretation necessary, in order to explain this formation of manganese nodules, is the same as that admitted in explanation of the formation of coatings of this material on the surface of terrestrial rocks. These salts of manganese and iron, dissolved in water by carbonic acid, then precipitated in the form of carbonate of protoxide of iron and manganese, become oxidized, and give rise in the calm and deep oceanic regions to more or less pure ferro-manganiferous concretions. At the same time it must be admitted that rivers may bring to the ocean a contribution of the same substances.

Among the bodies which, in certain regions where red clay predominates, serve as centres for these manganiferous nodules are the remains of vertebrates. These remains are the hardest parts of the skeleton—tympanic bones of whales, beaks of *Siphias*, teeth of sharks; and, just as the calcareous shells are eliminated in great depths, so all the remains of the larger vertebrates are absent, except the most resistant portions. These bones often serve as a centre for the manganese iron concretions, being frequently surrounded by layers several



FIG. 6.—Section of a Manganese Nodule, enclosing tympanic bone of a whale, from 2300 fathoms, South Pacific.

1 For the composition of these manganese nodules, see MARGULIERS, vol. XV, p. 47.

centimetres in thickness (fig. 6). In the same dredgings in the red-clay areas some sharks' teeth and Cetacean ear-bones, some of which belong to extinct species, are surrounded with thick layers of the manganese, and others with merely a slight coating.

The cosmic spherules incidentally referred to under the description of red clay may be here described in greater detail. If a magnet be plunged into an oceanic deposit, especially a red clay from the central parts of the Pacific, particles are extracted, some of which are magnetite from volcanic rocks, to which vitreous matters are often attached; others again are quite isolated, and differ in most of their properties from the former. The latter are generally round, measuring hardly 0.2 mm., usually smaller; their surface is quite covered with a brilliant black coating having all the properties of magnetic oxide of iron; often there may be noticed clearly marked upon them cup-like depressions (figs. 7 and 8). If these spherules be broken down in an agate mortar, the brilliant black coating easily falls away and reveals white or grey metallic malleable nuclei, which may be beaten out by the pestle into thin lamellæ. This metallic centre, when treated with an acid solution of sulphate of copper, immediately assumes a coppery coat, thus showing that it is native iron. But there are some malleable metallic nuclei extracted from the spherules which do not give this reaction; they do not take the copper coating.



Fig. 7.

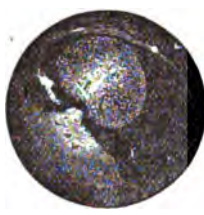

Fig. 8.

FIG. 7.—Black Spherule with Metallic Nucleus ( $\times 60$ ). This spherule covered with a coating of black shining magnetite represents the most frequent shape. The depression here shown is often found at the surface of these spherules. From 2375 fathoms, South Pacific.

FIG. 8.—Black Spherule with Metallic Nucleus ( $\times 60$ ). The black external coating of magnetic oxide has been broken away to show the metallic nucleus represented by the clear part at the centre. From 3150 fathoms.

Chemical reactions show that they contain cobalt and nickel; very probably they constitute an alloy of iron and these two metals, such as is often found in meteorites, and whose presence in large quantities hinders the production of the coppery coating on the iron. G. Rose has shown that this coating of black oxide of iron is found on the periphery of meteorites of native iron, and its presence is readily understood when their cosmic origin is admitted. Indeed, these meteoric particles of native iron in their transit through the air must undergo combustion, and, like small portions of iron from a smith's anvil, be transformed either entirely or at the surface only into magnetic oxide, and in the latter case the nucleus is protected from further oxidation by the coating which thus covers it.

One may suppose that meteorites in their passage through the atmosphere break into numerous fragments, that incandescent particles of iron are thrown off all round them, and that these eventually fall to the surface of the globe as almost impalpable dust, in the form of magnetic oxide of iron more or less completely fused. The luminous train of falling stars is probably, due to the combustion of these innumerable particles resembling the sparks which fly from a ribbon of iron burnt in oxygen, or the particles of the same metal thrown off when striking a flint. It is easy to show that these particles in burning take a spherical form, and are surrounded by a layer of black magnetic oxide.

Among the magnetic grains found under the same conditions as those just described are other spherules, which are referred to the *chondres*, so that, if the interpretation of a cosmic origin for the magnetic spherules with a metallic centre were not established in a manner absolutely beyond question, it almost becomes so when their association with the silicate spherules, which will now be described, is taken into account. It will be seen by the microscopic details that these spherules have quite the constitution and structure of *chondres* so frequent in meteorites of the most ordinary type, and on the other hand they have never been found, as far as is known, in rocks of a terrestrial origin; in short, the presence of these spherules in the deep-sea deposits, and their association with the metallic spherules, are matters of prime importance.

Among the fragments attracted by the magnet in deep-sea deposits are distinguished granules slightly larger than the spherules with the shining black coating above described. These are yellowish-brown, with a bronze-like lustre, and under the microscope it is noticed that the surface, instead of being quite smooth, is grooved by thin lamellæ. Their dimensions never attain a millimetre, generally they are about 0.5 mm. in diameter; they

are never perfect spheres, as in the case of the black spherules with a metallic centre; and sometimes a depression more or less marked is to be observed in the periphery. When examined by the microscope it is observed that the lamellæ which compose them are applied the one against the other, and have a radial eccentric disposition. It is the leafy radial structure (*radialblättrig*), like that of the chondres of bronzite, which predominates in these spherules. The serial structure of the chondres with olivine is observed, much less rarely, and indeed there is some doubt about the indications of this last type of structure. Fig. 9 shows the characters and texture of one of these spherules magnified 25 diameters. On account of their small dimensions, as well as of their friability due to their lamellar structure, it is difficult to polish one of these spherules, and it has been necessary to study them with reflected light, or to limit the observations to the study of the broken fragments.

These spherules break up following the lamellæ, which latter are seen to be extremely fine and perfectly transparent. In rotating between crossed nicols they have the extinctions of the rhombic system, and in making use of the condenser it is seen that they have one optic axis. It is observed also that when several of these lamellæ are attached they extinguish exactly at the same time, so that everything tends to show that they form a single individual.

In studying these transparent and very thin fragments with the aid of a high magnifying power, it is observed that they are dotted with brown-black inclusions, disposed with a certain symmetry, and showing somewhat regular contours; these inclusions are referred to magnetic iron, and their presence explains why these spherules of bronzite are extracted by the magnet. It should be observed, however, that they are not so strongly magnetic as those with a metallic nucleus.

They are designated bronzite rather than enstatite, because of the somewhat deep tint which they present; they are insoluble in hydrochloric acid. Owing to the small quantity of substance, only a qualitative analysis could be made, which showed the presence in them of silica, magnesia, and iron.

The study of deep-sea deposits suggests some interesting conclusions. It has been said that the debris carried away from the land accumulates at the bottom of the sea before reaching the abyssal regions of the ocean. It is only in exceptional cases that the finest terrigenous materials are transported several hundred miles from the shores. In place of layers formed of pebbles and clastic elements with grains of considerable dimensions, which play so large a part in the composition of emerged lands, the great areas of the ocean basins are covered by the microscopic remains of pelagic organisms, or by the deposits coming from the alteration of volcanic products. The distinctive elements that appear in the river and coast sediments are, properly speaking, wanting in the great depths far distant from the coasts. To such a degree is this the case that in a great number of soundings, from the centre of the Pacific for example, no mineral particles on which the mechanical action of water had left its imprint have been distinguished, and quartz is so rare that it may be said to be absent. It is sufficient to indicate these facts in order to make apparent the profound differences which separate the deposits of the abyssal areas of the ocean basins from the series of rocks in the geological formations. As regards the vast deposits of red clay, with its manganese concretions, its zeolites, cosmic dust, and remains of vertebrates, and the organic cozes which are spread out over the bed of the Central Pacific, Atlantic, and Indian Oceans, have they their analogues in the geological series of rocks? If it be proved that in the sedimentary strata the true pelagic sediments are not represented, it follows that deep and extended oceans like those of the present day cannot formerly have occupied the areas of the present continents, and as a corollary the great lines of the oceanic basins and continents must have been marked out from the earliest geological ages.

Without asserting that the terrestrial areas and the areas covered by the waters of the great ocean basins have had their main lines marked out since the commencement of geological history, it is a fact proved by the evidence of the pelagic sediments that these areas have a great antiquity. The accumulation of sharks' teeth, of the ear-bones of Cetaceans, of manganese concretions, of zeolites, of volcanic material in an advanced state of decomposition, and of cosmic dust, at points far removed from the continents, tends to prove this. There is no reason for supposing that the parts of the ocean where



FIG. 9.—Spherule of Bronzite ( $\times 25$ ), from 3500 fathoms in the Central South Pacific, showing many of the peculiarities belonging to chondres of bronzite or enstatite.



these vertebrate remains are found are more frequented by sharks or Cetaceans than other regions where they are never, or only rarely, dredged from the deposits at the bottom. When it is remembered also that these ear-bones, teeth of sharks, and volcanic fragments are sometimes incrustated with two centimetres of manganese oxide, while others have a mere coating, and that some of the bones and teeth belong to extinct species, it may be concluded with great certainty that the clays of these oceanic basins have accumulated with extreme slowness. It is indeed almost beyond question that the red-clay regions of the Central Pacific contain accumulations belonging to geological ages different from our own. The great antiquity of these formations is likewise confirmed in a striking manner by the presence of cosmic fragments, the nature of which has been described. In order to account for the accumulation of all these substances in such relatively great abundance in the areas where they were dredged, it is necessary to suppose the oceanic basins to have remained the same for a vast period of time.

The sharks' teeth, ear-bones, manganese nodules, altered volcanic fragments, zeolites, and cosmic dust are met with in greatest abundance in the red clays of the Central Pacific, at that point on the earth's surface farthest removed from continental land. They are less abundant in the Radiolarian ooze, are rare in the *Globigerina*, Diatom, and Pteropod ooze, and have been dredged only in a few instances in the terrigenous deposits close to the shore. These substances are present in all the deposits, but owing to the abundance of other matters in the more rapidly forming deposits their presence is masked, and the chance of dredging them is reduced. The greater or less abundance of these materials, which are so characteristic of a true red clay, may be regarded as a measure of the relative rate of accumulation of the marine sediments in which they lie. The terrigenous deposits accumulate most rapidly; then follow in order Pteropod ooze, *Globigerina* ooze, Diatom ooze, Radiolarian ooze, and, slowest of all, red clay.

From the data now advanced it appears possible to deduce other conclusions important from a geological point of view. In the deposits due essentially to the action of the ocean, the great variety of sediments which may accumulate in regions where the external conditions are almost identical is very striking. Again, marine faunas and floras, at least those of the surface, differ greatly, both with respect to species and the relative abundance of individuals, in different regions of the ocean; and, as their remains determine the character of the deposit in many instances, it is legitimate to conclude that the occurrence of organisms of a different nature in several beds is not an argument against the synchronism of the layers which contain them. In this connexion may be noted the fact that in certain regions of the deep sea no appreciable formation is now taking place. Hence the absence, in the sedimentary series, of a layer representing a definite horizon must not always be interpreted as proof either of the emergence of the bottom of the sea during the corresponding period, or of an ulterior erosion.

The small extent occupied by littoral formations, especially those of an arenaceous nature, and the relatively slow rate at which such deposits are formed along a stable coast, are matters of importance. In the present state of things there does not appear to be anything to account for the enormous thickness of the clastic sediments making up certain geological formations, unless the exceptional cases of erosion which are brought into play when a coast is undergoing constant elevation or subsidence are considered. Great movements of the land are doubtless necessary for the formation of thick beds of transported matter like sandstones and conglomerates. Arenaceous formations of great thickness require seas of no great extent and coasts subject to frequent oscillations, which permit the shores to advance and retire. Along these, through all periods of the earth's history, the great marine sedimentary phenomena have taken place.

The continental geological formations, when compared with marine deposits of modern seas and oceans, present no analogues to the red clays, Radiolarian, *Globigerina*, Pteropod, and Diatom ooze. On the other hand, the terrigenous deposits of lakes, shallow seas, enclosed seas, and the shores of the continents reveal the equivalents of the chalks, greensands, sandstones, conglomerates, shales, marls, and other sedimentary formations. Such formations as certain Tertiary deposits of Italy and the Radiolarian earth from Barbados, where pelagic conditions are indicated, must be regarded as having been laid down rather along the border of a continent than in a true oceanic area. The white chalk is evidently not a deep-sea deposit, for the *Foramsifera* and fragments of other organisms of which it is largely composed are similar to those found in comparatively shallow water not far from land. The argillaceous and calcareous rocks recently discovered by Dr Guppy in the upraised coral islands in the Solomon group are identical with the deposits now forming around oceanic islands. Regions situated similarly to enclosed and shallow seas and the borders of the present continents appear to have been, throughout all geological ages, the theatre of the greatest and most remarkable changes; in short, all, or nearly all, the sedimentary rocks of the continents would seem to have been built up in areas like these now occupied by the terrigenous deposits.

During each era of the earth's history the borders of some lands have sunk beneath the sea and been covered by marine sediments, while in other parts the terrigenous deposits have been elevated into dry land, and have carried with them a record of the organisms which flourished in the sea of the time. In this transitional area there has been throughout a continuity of geological and biological phenomena.

From these considerations it will be evident that the character of a deposit is determined much more by distance from the shore of a continent than by actual depth; and the same would appear to be the case with respect to the fauna spread over the floor of the present oceans. Dredgings near the shores of continents, in depths of 1000, 2000, or 3000 fathoms, are more productive both in species and individuals than dredgings at similar depths several hundred miles seawards. Again, among the few species dredged in the abyssal areas farthest removed from land, the majority show archaic characters, or belong to groups which have a wide distribution in time as well as over the floor of the present oceans. Such are the *Hexactinellida*, *Brachiopoda*, Stalked Crinoids and other Echinoderms, &c.

As already mentioned, the "transitional area" is that which now shows the greatest variety in respect to biological and physical conditions, and in past time it has been subject to the most frequent and the greatest amount of change. The animals now living in this area may be regarded as the greatly modified descendants of those which have lived in similar regions in past geological ages, and some of whose ancestors have been preserved in the sedimentary rocks as fossils. On the other hand, many of the animals dredged in the abyssal regions are most probably also the descendants of animals which lived in the shallower waters of former geological periods, but migrated into deep water to escape the severe struggle for existence which must always have obtained in shallower waters influenced by light, heat, motion, and other favourable conditions. Having found existence possible in the less favourable and deeper water, they may be regarded as having slowly spread themselves over the floor of the ocean, but without undergoing great modifications, owing to the extreme uniformity of the conditions and the absence of competition. Or it may be supposed that, in the depressions which have taken place near coasts, some species have been gradually carried down to deep water, have accommodated themselves to the new conditions, and have gradually migrated to the regions far from land. A few species may thus have migrated to the deep sea during each geological period. In this way the origin and distribution of the deep-sea fauna in the present oceans may in some measure be explained. In like manner, the pelagic fauna and flora of the ocean is most probably derived originally from the shore and shallow water. During each period of the earth's history a few animals and plants have been carried to sea, and have ultimately adopted a pelagic mode of life.

#### ISLANDS.

The Pacific Ocean is distinguished from the Atlantic by the greater number of small island groups that diversify its surface. The continental islands, lying along the coasts of America and Asia, have been referred to in speaking of the coasts; the islands of the Malay Archipelago, Australia, New Zealand, and probably New Caledonia belong to the same class. The true oceanic islands on the other hand have no direct geological connexion with the continents; the older sedimentary and metamorphic rocks appear to be quite absent, the islands being either of eruptive or coral formation. The fauna and flora of the oceanic islands present a considerable amount of uniformity, though each island or important group of islands has its peculiar species. There is an entire absence of terrestrial Mammalia. The genera and species are few in number when compared with those of the continents and continental islands from which they would appear to have been originally derived by immigration, and subsequently to have undergone modification. Recent researches appear also to show that the dredgings around oceanic islands yield fewer genera and species than dredgings at similar depths along the shores of continents, although the numbers of individuals of a few species may be extraordinarily abundant.

The most northern oceanic group is the Hawaiian Archipelago or Sandwich Islands (see vol. xi. p. 528), stretching for about 340 miles between the latitudes of 18° 52' and 22° 15' N., and the meridians of 154° 42' and 160° 33' W.; it consists of eight large islands—Hawaii (Owhyhee), Maui (Mowee), Kahulani (Tahooroway), Lanai

(Ranai), Molokai (Morotoi), Oahu (Woahoo), Kauai (Atooi), and Niihan (Oneehooov), and four small barren islets, the entire area being 6100 square miles. The islands of this group are mountainous, and abound in active volcanoes; the great lake of fire, Kilauea, on the east side of the Mountain of Mauna Loa (13,760 feet) in Hawaii is probably the largest active crater in the world, while one of the largest known extinct craters is that of Mauna Haleakala ("The House of the Sun") in Maui, at a height of 10,200 feet above the sea; it is 12 miles in circumference. The Hawaiian Islands being within the zone of coral formation are surrounded by fringing reefs, and there is abundant evidence that gradual upheaval has taken place over the whole area which they occupy. There are beds of coral limestone in Molokai at a height of 400 feet, and in Kauai coral sand is found at an elevation of 4000 feet above the sea; in many other islands coral and lava are found interstratified.

The three groups of the Bonin Islands known as the Parry, Beechy, and Coffin groups are composed of high rocky islets of a bold and fantastic outline, and are situated between 26° and 27° N. lat.

The Ladrões or Mariana Islands (see vol. xiv. p. 199) have a total area of 395 square miles; they stretch for nearly 450 miles between 13° and 20° N. lat. and 144° 37' and 145° 55' E. long. These islands are all of volcanic origin, and their mountains contain several active volcanoes.

The Caroline Archipelago (see vol. . p. 125) lies about 170 miles to the south of the Ladrões, and, together with the Pelew Islands, has an area of 877 square miles. The Carolines embrace forty distinct island groups, five of which are basaltic and mountainous, though surrounded by coral reefs; the remaining thirty-five groups are entirely of coral formation, and do not rise much above the sea-level. The Pelew Islands resemble the Carolines in their physical characters; they present peculiarities in the arrangement of atolls which will be alluded to below.

The Marshall Islands (see MICRONESIA, vol. xvi. p. 256) consist of two chains running parallel to each other, and composed of fourteen and seventeen small groups respectively. They lie to the eastward of the Carolines, and are entirely of organic formation.

The Gilbert Archipelago (see vol. xvi. p. 256) is cut by the equator. It contains sixteen groups of small coral islands, low and barren, but densely populated.

In the South Pacific oceanic islands are scattered with the greatest profusion over a region between 5° and 25° S. lat. and 180° to 120° W. long. The northern part of the shallow water surrounding Australia, New Zealand, and the Malay Archipelago is occupied by the Solomon Islands, the New Hebrides, the bold rocky and mountainous islands of Fiji with fine barrier reefs, the Friendly Islands, and Samoa or the Navigators' Islands. Farther to the south there are the Society Islands, including Tahiti; they are lofty, of volcanic origin, and surrounded by very perfect barrier reefs. The Marquesas or Mendana Archipelago, farther to the north, also consists of volcanic islands, but they are not fringed by reefs.

The volcanic group of the Galapagos Archipelago is situated under the equator at a distance of 500 or 600 miles from the west coast of South America; it has been minutely described by Darwin.

The extensive Low or Paumotu Archipelago lies to the south-east of the Society Islands, and runs parallel to them. It consists of about eighty atolls, some of them of large size, and all typical examples of this form of coral island.

The total area of the islands of the Pacific is exceedingly small, especially when the vast number of groups that stud the ocean is taken into consideration.

## THEORY OF CORAL ISLANDS.

The origin of coral islands was specially studied by Darwin during the voyage of the "Beagle" in 1831-36, and he shortly afterwards published a theory on the subject which has been fully detailed in the article CORAL (vol. vi. p. 377). This theory was so simple, and it appeared so complete, that it acquired universal acceptance; and the continuous action of subsidence in promoting the development of fringing reefs into barriers, and of barriers into atolls, was long unquestioned. In 1851 L. Agassiz<sup>1</sup> expressed the opinion that the theory of subsidence was insufficient to explain the formation of the coral reefs and keys of Florida. In 1863 Carl Scaper stated that an attentive study of the Pelew Islands showed the complete inadequacy of this theory, and in 1868 he reiterated his convictions.<sup>2</sup>

In 1880 Mr John Murray published an abstract of his "Challenger" observations,<sup>3</sup> and gave a theory of coral island formation which claims to account for all the phenomena without calling in the aid of subsidence. It is pointed out that, with hardly an exception, the oceanic islands are of volcanic origin, and it is assumed that the various peaks which deep-sea soundings have shown to be scattered over the bed of the ocean, and rising to within various distances of the surface, are also, primarily, of volcanic origin. There is no evidence of any extensive submerged continent or mass of land such as Darwin's theory requires. Whether built up sufficiently high to rise above the surface of the sea and thus form islands, or brought up only to varying heights below the sea-level, these volcanic eminences tend to become platforms on which coral reefs may be formed. The erosive action of waves and tides tends to reduce all volcanic summits down to the lower limit of breaker action, thus producing platforms on which barrier reefs and atolls may spring up. Again, submarine eminences may be brought up to the zone of the reef builders by the deposit of volcanic and organic detritus falling from the surface, as well as through the agency of organisms secreting lime and silica, which live in profusion at great depths, especially on the tops of submarine peaks and banks. The great profusion of life in the tropical surface waters is insisted upon, and it is pointed out that this pelagic life supplies the reef-building corals with food, and that, when these surface creatures die and their shells fall to the bottom, they carry down with them sufficient organic matter to furnish food to the animals living on the floor of the ocean. As the result of tow-net experiments in the tropics Mr Murray estimated that, in the surface waters of the ocean, there were in a mass 1 mile square by 100 fathoms, 16 tons of carbonate of lime existing in the form of shells of pelagic *Foraminifera* and Mollusca. In this way it is urged that submarine banks are continually being brought within the zone of reef-building corals. Darwin admitted that reefs not to be distinguished from atolls might be formed on such submarine banks, but the improbability of so many submerged banks existing caused him to dismiss this explanation without further consideration. He was not, however, aware of the great number of submerged cones which recent soundings have made known, nor of the enormous abundance of minute calcareous organisms—such as calcareous algae, *Foraminifera*, and Mollusca in the surface waters—and of the comparatively rapid rate at which their remains might accumulate on the sea bottom. Nor had he any idea of the comparatively great abundance of animals living at considerable depths.

Coral-reef builders starting on a bank, whether formed by elevation or subsidence, by erosion or the upward growth of deep-sea deposits composed largely of organic remains, tend ultimately to assume the atoll or barrier form. When the coral reef or colony approaches the surface, the central portions are gradually placed at a disadvantage as compared with the peripheral parts of the mass, in being farther removed from the food supply which is brought by the oceanic currents, and consequently dwindle and die. In proportion as the reef approaches the surface, the centre becomes cut off from the food supply and the conditions become increasingly ungenial. At last an outer ring of vigorously growing reef corals encloses a central lagoon. The windward side of the reef grows most vigorously, not because of a larger supply of oxygen and greater aeration of the water, but because that is the direction in which the oceanic currents bring the food to the reef. As the atoll extends seawards from vigorous growth the lagoon becomes larger, chiefly from the removal of lime in solution by the action of the carbonic acid in sea water which flows in and out at each tide. This solvent action of sea water on dead calcareous organisms was shown by the "Challenger's" observations to be universal.

Mr Murray reverses the order of growth as given by Darwin for the groups in the Indian Ocean. He regards the Laccadive, Caroline, and Chagos archipelagos as various stages in the growth of coral reefs towards the surface, and he explains the various appear-

<sup>1</sup> Bull. Mus. Comp. Zool., vol. 1.

<sup>2</sup> Verhandl. Physik. Med. Gesellsch. Würzburg, Feb. 1, 1868.

<sup>3</sup> Proc. Roy. Soc. Edin., vol. x. p. 505.

ances in the Maldive group of atolls without any necessity for disjuncture by oceanic currents as argued by Darwin. Precisely the same explanation is applied to the case of a barrier reef. It commences in the shallow water near the shore, and afterwards extends seawards on a talus built up of lumps of coral broken off by the surf. A very careful examination of the barrier reef at Tahiti was made by Lieutenant Swire of H.M.S. "Challenger" and Mr Murray, and they found that such an explanation was completely justified by the form and nature of the reef. There was much dead coral on the inner side of the barrier, which in many places was perpendicular or even overhanging; while, on the contrary, the outer surface was all alive, and sloped gradually seawards. A section of it, drawn to a true scale, is given in fig. 10.

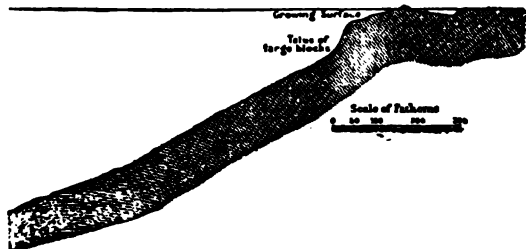

FIG. 10.—Section across the Barrier Reef, Tahiti.

This section shows that a ledge, over which there is a depth of from 30 to 40 fathoms of water, runs out for 250 yards from the edge of the reef. This ledge is covered with luxuriant heads and masses of coral. Beyond it there is a steep irregular slope at an angle of about 45°, the talus being formed apparently of coral masses broken off from the ledge, and piled up; this slope is covered with living Sponges, Alcyonarians, Hydroids, *Polyzoa*, *Trematopora*, and other forms of life. The angle of inclination then decreases to 30°, and the ground is covered with coral sand; and beyond 500 yards from the edge of the reef the declivity is

insignificant, only 6°, and there is a bed of mud containing volcanic and coral sand mixed with Pteropod and other shells, in 500 fathoms of water. The vast perpendicular wall of coral limestone descending into unfathomable depths, which has been supposed usually to mark the outside of a coral reef, has always been looked upon as a conclusive proof of great subsidence having taken place; but the depth and the slope of such limestone walls have been greatly exaggerated, and no means have been taken to ascertain beyond doubt that the rock is formed of coral throughout. The probability is that only the upper portion of such a wall is true coral limestone; and Dr Guppy has recently shown that this is actually the case in some upraised coral islands of the Solomon group. Upheaval has taken place to a considerable extent in the oceanic islands, and more extended examination of the limestone cliffs of other coral islands will probably lead to the discovery of many such cases. Mr Murray holds that the characteristic form of barrier reefs and atolls is in no way dependent on subsidence, that subsidence is not the cause of their peculiar features, that these reefs may be met with indifferently in stationary areas, in areas of subsidence, and in areas of elevation, and that elevation and subsidence only modify in a minor way the appearance of the islands.

The chief phenomena are accounted for—(1) by a physiological fact,—the very vigorous growth of the reef-forming species on the outer or seaward face of the reef where there is abundance of food, and the much less vigorous growth, and even death, of these species on the inner parts of the reefs and in the lagoons, where there is much less food, and where there are other conditions inimical to growth; and (2) by a physical and chemical fact,—the removal of lime in suspension and in solution from the inner portions of the reefs and from the lagoons, where much dead coral is exposed to the action of sea water containing carbonic acid, the result being the formation, the deepening, and the widening of lagoons and lagoon channels.

For further information on subjects referred to in this article see John Murray, "On the Structure and Origin of Coral Reefs and Islands," *Proc. Roy. Soc. Edin.*, vol. x. p. 505; Alex. Agassiz, "On the Tortugas and Florida Reefs," *Trans. Amer. Acad.*, vol. xi. (1833); Archd. Geikie, "The Origin of Coral Reefs," *Nature*, vol. xxix. pp. 107 and 124; John Murray and A. Renard, "On the Nomenclature, Origin, and Distribution of Deep-Sea Deposits," *Proc. Roy. Soc. Edin.*, vol. xli. p. 495 (1854); John Murray and A. Renard, "On the Microscopic Characters of Volcanic Ashes and Cosmic Dust, and their Distribution in the Deep-Sea Deposits," *Proc. Roy. Soc. Edin.*, vol. xli. p. 474, 1854. (J. MU.)

PACUVIUS, MARCUS (219–129 B.C.), was the second in order of time of the three tragic poets who wrote for the Roman stage in the 2d century B.C. His life was so long that he might be described as a contemporary of all the writers who flourished during the first period of Roman literature. He was born in 219 B.C., when Livius Andronicus and Nævius were introducing their imitations of the Greek tragic and comic drama to Roman audiences; he was recognized as the chief tragic poet about the time when Cæcilius, and after him Terence, were the flourishing authors of Latin comedy; he continued to produce his tragedies till the advent of the younger poet Accius, who lived on till the youth of Cicero; and he died in the year (129 B.C.) when Lucilius first appeared as an author. He stood in the relation of nephew as well as pupil to Ennius, by whom Roman tragedy was first raised to a position of influence and dignity. In the interval between the death of Ennius (169) and the advent of Accius, the youngest and most productive of the tragic poets, he alone maintained the continuity of the serious drama, and perpetuated the character first imparted to it by Ennius. Like Ennius he probably belonged to the Oscan stock, and was born at Brundisium, which had become a Roman colony in 244 B.C. To this origin may be attributed the fact that he never attained to that perfect idiomatic purity of style which was the special glory of the early writers of comedy, Nævius and Plautus.<sup>1</sup> The fame of his uncle Ennius may probably have drawn him to Rome, and may have induced him to devote himself to the composition of tragedy. But he obtained distinction also as a painter; and the elder Pliny mentions a work of his which in his time was still to be

seen in the temple of Hercules in the *forum boarium*. His relationship to the friend of the great Scipio would naturally recommend him to the consideration of the eminent men of the next generation, who fostered the new literature in his spirit; and thus Cicero, in the *De Amicitia*, represents C. Lælius as speaking of him as "hospitis et amici mei." He was less productive as a poet than either Ennius or Accius; and we hear of only about twelve of his plays, founded on Greek subjects (among them the *Antiope*, *Teucer*, *Armorum Judicium*, *Dulorestes*, *Chryses*, *Niptra*, &c., most of them on subjects connected with the Trojan cycle), and one "Prætexta," *Paulus*, written in connexion with the triumph of L. Æmilius Paulus, for his victory at Pydna, celebrated in the year 167 B.C., as the *Clastidium* of Nævius and the *Ambracia* of Ennius were written in commemoration of great military successes in their time. He continued to write tragedies till the age of eighty, when he exhibited a play in the same year as Accius, who was then thirty years of age. He retired to Tarentum for the last years of his life, and a story is told by Gellius of his being visited there by Accius on his way to Asia, who read to him one of his plays, which was famous in after times, the *Atrous*. The story is probably, like that of the visit of the young Terence to the veteran Cæcilius, due to the invention of later grammarians; but it is invented in accordance with the traditionary criticism of the distinction between the two poets, the older being characterized rather by cultivated accomplishment, the younger by vigour and animation.

"Ambigitur quoties uter utro sit prior, aufert  
Pacuvius docti famam senis, Accius alti."<sup>2</sup>

He died at the age of ninety, having lived through the long period from the beginning of the Second Punic War

<sup>1</sup> *Ætatis illius ista fuit laus tanquam innocentie sic Latine loquendi; nec omnium tamen; nam illorum sequales Cæcilius et Pacuvium male locutos videmus; sed omnes tum fere, qui nec extra urbem hanc vixerant nec eos aliquis barbarie domestica infuscaverat, recte loquebantur (Cicero, *Brutus*, 74).*

<sup>2</sup> Horace, *E.*, li. 1, 54, 55.

till after the first outbreak of the revolutionary forces, in the tribunate of Tib. Gracchus, which led ultimately to the overthrow of the republic. His epitaph, said to have been composed by himself, is quoted by Aulus Gellius, with a tribute of admiration to its "modesty, simplicity, and fine serious spirit."

"Adlocuta, tam etiam properas, te hac senua rogit  
Ut se aspicias, deinde quod scriptum 'est legas.  
Hic sentit poeta Pacuvi Marci sita  
Uma. Hoc volebam necesse no esse. Vale."<sup>1</sup>

Cicero, who frequently quotes passages from him, with great admiration, appears to rank him first among the Roman tragic poets, as Ennius among the epic, and Cæcilius among the comic poets (Cic., *De Opt. Gen. Or.*, 1). If a rough parallel might be drawn between the three great original Greek tragic poets and their three Roman imitators, we might perhaps recognize in the imaginative mysticism and soldierly spirit of Lænius an affinity to Æschylus, in the mellow wisdom of Pacuvius to Sophocles, and in the oratorical talent and power of moving the passions attributed to Accius a nearer approach to the genius of Euripides. The office performed by the Roman tragic poets to Roman culture was not only to familiarize their countrymen with the creations of Greek genius, and the heroes and heroines of Greek legend, but to be the moral teachers and moral philosophers of a time before the introduction of definite ethical speculation. The fragments of Pacuvius quoted by Cicero in illustration of enforcement of his own ethical teaching appeal, by the fortitude, dignity, and magnanimity of the sentiment expressed in them, to what was noblest in the Roman temperament. They are inspired also by that fervid and steadfast glow of spirit which underlay the strong self-control of the Roman character, and which was the most powerful element in Roman oratory. They reveal also a gentleness and humanity of sentiment which it was the highest office of the new drama to blend with the severe gravity of the original Roman character. So far too as the Romans were capable of taking interest in speculative questions, the tragic poets contributed to stimulate curiosity on such subjects, and they anticipated Lucretius in using the conclusions of speculative philosophy as well as of common sense to assail some of the prevailing forms of superstition. Among the passages quoted from Pacuvius are several which indicate a taste both for physical and ethical speculation, and others which expose the pretensions of religious imposture, &c. —

"Nam isti qui linguam ævum intelligunt,  
Pisquæ ex æthero jecore spantiam quam ex seræ,  
Magis audientem quam assuetandam censeo."

These poets aided also in developing that capacity which the Roman language subsequently displayed of being an organ of oratory, history, and moral disquisition. The literary language of Rome was in process of formation during the 2d century B.C., and it was in the latter part of this century that the series of great Roman orators, with whose spirit Roman tragedy has a strong affinity, began. But the new creative effort in language was accompanied by considerable crudeness of execution, and the novel word-formations and varieties of inflexion introduced by Pacuvius exposed him to the ridicule of the satirist Lucilius, and, long afterwards, to that of his imitator Persius. But, notwithstanding the attempt to introduce an alien element into the Roman language, which proved incompatible with its natural genius, and his own failure to attain the idiomatic purity of Nævius, Plautus, or Terence, the fragments of his dramas are sufficient to prove the service which he rendered to the formation of the literary language of Rome, as well as to the culture and character of his contemporaries.

The best account of Pacuvius is to be found in the *Römische Tragödie* of O. Ribbeck, and the best collection of his "Fragments" in the *Tragicorum Latinorum Reliquiæ* of the same author. (W. Y. S.)

PADANG. See SUMATRA.

PADERBORN, an ancient town of Prussia, the seat of a Roman Catholic bishop, is situated in the province of Westphalia and district of Minden, 60 miles to the south-west of Hanover. It derives its name (Latin, *Paderæ Fontes*) from the springs of the Pader, a small affluent of the Lippe, which rise in or close to the town under the cathedral to the number of nearly two hundred, and with such force as to drive several mills within a few yards of their source. The most prominent building is the cathedral,

<sup>1</sup> "Young man, though thou art in haste, this stone entreats thee to look at it, and then to read what is written. Here are laid the bones of the poet M. Pacuvius. This I desired to be not unknown to thee. Farewell."

<sup>2</sup> "For they who understand the notes of birds, and derive their wisdom more from examining the livers of other beings than from their own (wit), I think should be rather heard than listened to."

the western part of which dates from the 11th, the central part from the 12th, and the eastern part from the 13th century. The exterior is imposing, but heavy, and marred by a want of harmony arising from the successive stages of its construction. Among other treasures of art it contains the silver coffin of St. Liborius, a substitute for one which was coined into dollars in 1622 by Duke Christian of Brunswick. The externally insignificant chapel of St. Bartholomew ranks among the most interesting buildings in Westphalia, dating as it does from 1017, and possessing the characteristic features of the architecture of that early period. The old Jesuit church and the chapel of the convent of Abdinghof are also interesting. The town-hall is a picturesque edifice of the Renaissance. Paderborn formerly possessed a university, with the two faculties of theology and philosophy, but it was closed in 1819. The Roman Catholic gymnasium, however, enjoys a considerable reputation, and there are several other schools, hospitals, and religious endowments, as well as an historical and antiquarian society. The manufactures of Paderborn are unimportant, but the trade in grain, cattle, fruit, and wool has attained considerable dimensions since the opening of the Westphalian railway. The population in 1880 was 14,689 (12,602 Roman Catholics).

Paderborn is indebted for its development to Charlemagne, who discerned the favourable situation of the village of Patriabrunnen, and made it the capital of a bishopric. He frequently visited it, receiving the conquered Saxons here at a diet in 777 and at a later period the Saracen ambassadors from Saragossa and the suppliant Pope Leo III. Several diets were also held here by the Saxon emperors. About the year 1000 the town was enlarged by Bishop Meinwerk and surrounded with walls. It afterwards joined the Hanseatic League, received many of the privileges of a free imperial town, and endeavoured to assert its independence of the bishops. The citizens gladly embraced the doctrines of the Reformation, but the older faith was re-established by Bishop Theodore, who took the town by force in 1604. The ecclesiastical principality of Paderborn, which had an area of close on 1000 square miles, was secularized in 1803 and handed over to Prussia. The bishop, however, was allowed to retain his spiritual jurisdiction. From 1807 to 1814 the territory was included in the kingdom of Westphalia.

PADIHAM, a township of Lancashire, is situated in a wild and dreary district on the precipitous banks of the Calder, and on the Lancashire and Yorkshire Railway, 5 miles south-east from Whalley and 4 north-east from Accrington. It possesses large cotton mills, and both stone and coal are wrought in the immediate neighbourhood. The church of St. Leonard, founded before 1451, was frequently altered before it was rebuilt in 1866-68, in the Perpendicular style, at a cost of £11,000. There is a national school connected with a very old endowment. Padinam in 1251 was a manor in the possession of Edmund de Laci. The population of the urban sanitary district of Padiham and Hapton (area 950 acres) in 1871 was estimated at 7361, and in 1881 it was 8974.

PADILLA, JUAN LOPEZ DE, insurrectionary leader in the "guerra de las comunidades" in which the commons of Castile made a futile stand against the arbitrary policy of Charles V. and his Flemish ministers, was the eldest son of the commendator of Castile, and was born in Toledo towards the close of the 15th century. After the cities, by their deputies assembled at Avila, had vainly demanded the king's return, due regard for the rights of the cortes, and economical administration, to be entrusted to the hands of Spaniards, it was resolved to resort to force, and the "holy junta" was formed, with Padilla at its head. An attempt was first made to establish a national government in the name of the imbecile Joanna, who was then residing at Tordeillas; with this view they took possession of her person, seized upon the treasury books, archives, and seals of the kingdom, and stripped Adrian of his regency. But the junta soon alienated the nobility

by the boldness with which it asserted democracy and total abolition of privilege, while it courted defeat in the field by appointing to the supreme command of its forces not Padilla but Don Pedro de Giron, who had no recommendation but his high birth. After the army of the nobility had recaptured Tordeillas, Padilla did something to retrieve the loss by taking Torrelobaton and some other towns. But the junta, which was not fully in accord with its ablest leader, neutralized this advantage by granting an armistice; when hostilities were resumed the commons were completely defeated near Villalar (April 23, 1521), and Padilla, who had been taken prisoner, was publicly executed on the following day. His wife, Doña Maria Pacheco de Padilla, bravely defended Toledo against the royal troops for six months afterwards, but ultimately was compelled to take refuge in Portugal.

**PADUA** (Lat., *Patavium*; Ital., *Padova*), a city of north Italy, in 45° 24' N. lat. and 11° 50' E. long., on the river Bacchiglione, 25 miles W. of Venice and 18 miles S.E. of Vicenza, with a population in 1881 of 70,753. The city is a picturesque one, with arcaded streets and many

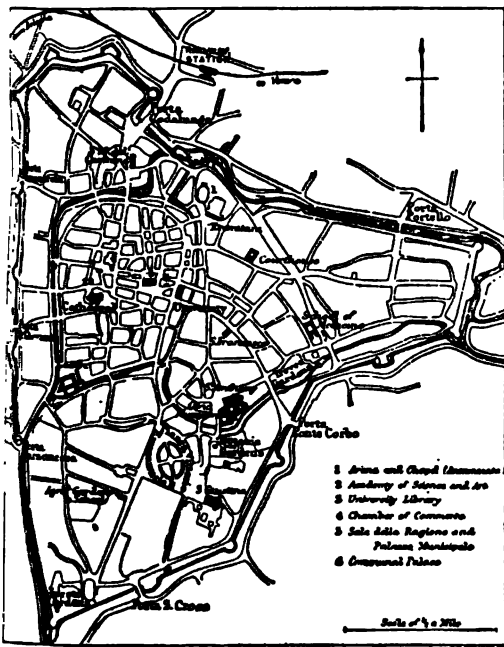

Plan of Padua.

bridges crossing the various branches of the Bacchiglione, which once surrounded the ancient walls. The Palazzo della Ragione, with its great hall on the upper floor, is reputed to have the largest roof unsupported by columns in Europe; the hall is nearly rectangular, its length 267½ feet, its breadth 89 feet, and its height 78 feet; the walls are covered with symbolical paintings in fresco; the building stands upon arches, and the upper story is surrounded by an open loggia, not unlike that which surrounds the basilica of Vicenza; the Palazzo was begun in 1172, and finished in 1219; in 1306 Fra Giovanni, an Augustinian friar, covered the whole with one roof; originally there were three roofs, spanning the three chambers into which the hall was at first divided; the internal partition walls remained till the fire of 1420, when the Venetian architects who undertook the restoration removed them, throwing all three compartments into one, and forming the present great hall. In the Piazza dei Signori is the beautiful loggia called the Gran Guardia,

begun in 1493 and finished in 1526, and close by is the Palazzo del Capitano, the residence of the Venetian governors, with its great door, the work of Falconetto of Verona, 1532. The most famous of the Paduan churches is the basilica dedicated to Saint Anthony, commonly called Il Santo; the bones of the saint rest in a chapel richly ornamented with carved marbles, the work of various artists, among them of Sansovino and Falconetto; the basilica was begun about the year 1230, and completed in the following century; tradition says that the building was designed by Niccola Pisano; it is covered by seven cupolas, two of them pyramidal. On the piazza in front of the church is Donatello's magnificent equestrian statue of Erasmo da Narni, the Venetian general (1438-41). The Eremitani is an Augustinian church of the 13th century, distinguished as containing the tombs of Jacopo (1324) and Ubertino (1345) da Carrara, lords of Padua, and for the chapel of Sts James and Christopher, illustrated by Mantegna's frescoes. Close by the Eremitani is the small church of the Annunziata, known as the Madonna dell' Arena, whose inner walls are entirely covered with paintings by Giotto. Padua has long been famous for its university, founded by Frederick II. in 1238. Under the rule of Venice the university was governed by a board of three patricians called the Riformatori dello Studio di Padova. The list of professors and alumni is long and illustrious, containing, among others, the names of Bembo, Sperone Speroni, Veselius, Acquapendente, Galileo, Pomponazzi, Pole, Scaliger, Tasso, and Sobieski. The place of Padua in the history of art is nearly as important as her place in the history of learning. The presence of the university attracted many distinguished artists, as Giotto, Lippo Lippi, and Donatello; and for native art there was the school of Squarcione (1394-1474), whence issued the great Mantegna (1431-1506).

Padua claims to be the oldest city in north Italy; the inhabitants pretend to a fabulous descent from the Trojan Antenor, whose relics they recognized in a large stone sarcophagus exhumed in the year 1274. Their real origin is involved in that obscurity which conceals the ethnography of the earliest settlers in the Venetian plain; but it is supposed that they were either Paphlagonians or Etruscans. Padua early became a populous and thriving city, thanks to its excellent breed of horses and the wool of its sheep. Its men fought for the Romans at Cannae, and the city became so powerful that it was reported able to raise two hundred thousand fighting men. Abano in the neighbourhood was made illustrious by the birth of Livy, and Padua was the native place of Valerius Flaccus, Asconius Pedianus, and Thrasea Petaus. Padua, in common with north-eastern Italy, suffered severely from the invasion of the Huns under Attila (452). It then passed under the Gothic kings Odoacer and Theodoric, but made submission to the Greeks in 540. The city was seized again by the Goths under Totila, and again restored to the eastern empire by Narzes in 568. Following the course of events common to most cities of north-eastern Italy, the history of Padua falls under eight heads:—(1) the Lombard rule, (2) the Frankish rule, (3) the period of the bishops, (4) the emergence of the commune, (5) the period of the despots, (6) the period of Venetian supremacy, (7) the period of Austrian supremacy, and finally (8) the period of united Italy. (1) Under the Lombards the city of Padua rose in revolt (601) against Agilulph, the Lombard king, and, after suffering a long and bloody siege, was stormed and burned by him. The city did not easily recover from this blow, and Padua was still weak when the Franks succeeded the Lombards as masters of north Italy. (2) At the diet of Aix-la-Chapelle (828) the duchy and march of Friuli, in which Padua lay, was divided into four counties, one of which took its title from that city. (3) During the period of episcopal supremacy Padua does not appear to have been either very important or very active. The general tendency of its policy, throughout the war of investitures, was imperial and not Roman, and its bishops were, for the most part, Germans. (4) But under the surface two important movements were taking place. At the beginning of the 11th century the citizens established a constitution composed of a general council or legislative assembly and a *crodenza* or executive; and during the next century they were engaged in wars with Venice and Vicenza for the right of water-way on the Bacchiglione and the Brenta,—so that, on the one hand, the city grew in power and self-reliance, while, on the other, the great families of Camposampiero, D'Este,

and Da Romano began to emerge and to divide the Paduan district between them. The citizens, in order to protect their liberties, were obliged to elect a podestà, and their choice fell first on one of the D'Este family (c. 1175). The temporary success of the Lombard league helped to strengthen the towns; but their ineradicable jealousy of one another soon reduced them to weakness again, so that in 1286 Frederick II. found little difficulty in establishing his vicar Ezzelino da Romano in Padua and the neighbouring cities, where he practised frightful cruelties on the inhabitants. When Ezzelino met his death, in 1259, Padua enjoyed a brief period of rest and prosperity: the university flourished; the basilica of the saint was begun; the Paduans became masters of Vicenza. But this advance brought them into dangerous proximity to Can Grande della Scala, lord of Verona, to whom they had to yield in 1311. (5) As a reward for freeing the city from the Scalas, Jacopo da Carrara was elected lord of Padua in 1318. From that date till 1405, with the exception of two years (1388-90) when Gian Galeazzo Visconti held the town, nine members of the Carrara family succeeded one another as lords of the city. It was a long period of restlessness, for the Carrarais were constantly at war; they were finally extinguished between the growing power of the Visconti and of Venice. (6) Padua passed under Venetian rule in 1405, and so remained, with a brief interval during the wars of the league of Cambray, till the fall of the republic in 1797. The city was governed by two Venetian nobles, a podestà for civil and a captain for military affairs; each of these was elected for sixteen months. Under these governors the great and small councils continued to discharge municipal business and to administer the Paduan law, contained in the statutes of 1276 and 1362. The treasury was managed by two chamberlains; and every five years the Paduans sent one of their nobles to reside as nuncio in Venice, and to watch the interests of his native town. (7 and 8) After the fall of the Venetian republic the history of Padua follows the history of Venice during the periods of French and Austrian supremacy, and must be sought for in the article ITALY. In 1866 the battle of Königgratz gave Italy the opportunity to shake off the last of the Austrian yoke, when Venetia, and with Venetia Padua, became part of the united Italian kingdom.

See *Chronicon Paduanum* (in Muratori's *Ann. Med. Æv.*, vol. iv.); *Relandus* and *Monaco Padovano* (Muratori's *Res. Ital. Scrip.*, vol. viii.); *Christorum Historia* (ibid., vol. xii.); *Gastari, Storia Padovana* (ibid., vol. xvii.); *Vergertus, Vita Carvartianum Principum* (ibid., vol. xvi.); *Verci, Storia della Marca Trevigiana*; *Gennari, Annali di Padova*; *Cittadella, Storia della dominazione Carrarese*; *Litta, Famiglia Celebri*, s.v. "Carrarais"; *Cantu, Illustrazione Grande del Lombardo-Veneto*; *Gonzatti, La Basilica di Santi Antonio di Padova*. (H. F. B.)

**PADUCAH**, a city of the United States, the capital of M'Cracken county, Kentucky, on the south bank of the Ohio, at the mouth of the Tennessee river, is, next to Louisville, the most important commercial point in Kentucky. It is on the Chesapeake, Ohio, and South-Western railroads, and is the terminus for five lines of steamboats plying respectively to Evansville (Ind.), Cairo (Ill.), St Louis (Mo.), Nashville (Tenn.) and Florence (Ala.), and a regular stopping point for other lines plying on the Ohio, Tennessee, and Mississippi rivers. It ships tobacco, whisky, pork, lumber, flour, and grain, and contains a number of tobacco factories and warehouses, marine-ways for the building and repair of steamboats, and manufactories of furniture, hubs and spokes, harness, leather, soap, and brooms. Laid out in 1827, Paducah was incorporated as a town in 1830, and as a city in 1856. The population was 2428 in 1830, 4590 in 1860, 6866 in 1870, and 8036 in 1880.

**PÆONY** (*Pœonia*), a genus of *Ranunculaceæ* remarkable for their gorgeous flowers, constructed almost exactly on the same lines as those of the common buttercup except as regards the pistil, which in the pœonies consists of two or more separate carpels each containing several seeds, and surrounded at the base by a fleshy cup or disk, which grows up around the carpels. The receptacle of the flower, moreover, instead of being flattish or somewhat convex, is in pœonies a little depressed in the centre, so that the stamens become somewhat perigynous as in water-lilies (*Nymphæa*) or roses (*Rosa*). The carpels when ripe form dry follicles, splitting along one edge so as to expose the numerous shining black seeds, provided with a small fleshy aril. There are but few species, natives of the northern hemisphere of the Old World, and divisible into two main groups—those with herbaceous stems dying down in winter,

and those with shrubby stems (Moutan or Tree Pœonies). The herbaceous pœonies have tuberous roots like those of a dahlia, and bold, much-divided leaves. Their magnificent cup-like flowers are, in different varieties, of all shades of colour from white to clear yellow (*P. Wittmanniana*), rose-coloured, and richest crimson. A blue pœony has yet to be introduced. There is little reason to doubt that this desideratum will be fulfilled, for in larkspurs and aconites and columbines, closely related genera, we have a similar range in colour to that of the pœony, together with intense blue. The writer has also seen a Chinese drawing representing a blue pœony, and, although too much stress must not be laid on that circumstance, yet it must be remembered that the correctness of some representations of Chinese plants formerly considered fanciful has been proved by the subsequent introduction of the plant, e.g., *Dielysia spectabilis*. The Moutan or tree pœonies have an erect bushy stem, from which the bark peels off in flakes; the foliage is divided as in the commoner kinds, and more or less glaucous. The flowers are remarkable for the extreme delicacy of tint, and botanically by the large development of the disk above mentioned. Moutan pœonies are natives of China. In gardens a large variety of pœonies are cultivated, chiefly of hybrid origin; and one of the European species, *P. corallina*, has been found naturalized on an island in the mouth of the Severn, to which it is supposed to have been introduced.

**PÆSTUM** (*Πορεύωρια*, *Posidonia*, mod. *Pesto*), a Greek city in Lucania, Magna Græcia, near the sea, and about 5 miles south of the river Silarus (Salso). It is said by Strabo (v. p. 251) to have been founded by Troezenian and Achaean colonists from the still older colony of Sybaris, on the Gulf of Tarentum; this probably happened not later than about 600 B.C. Herodotus (i. 167) speaks of it as being already a flourishing city in about 540 B.C., when the neighbouring city of Velia was founded. The name Posidonia was derived from Poseidon, the deity principally worshipped by the Troezenians. For many years the city maintained its independence, though surrounded by the hostile native inhabitants of Lucania. Autonomous coins were struck of which many specimens now exist.

Fig. 1 shows a didrachm of the 6th century B.C., an interesting example of archæolo Greek art. It is struck on a broad thin flan,

with guilloche pattern round the border. The obverse has a figure of Poseidon, with the trident, with the chlamys hung across his shoulders. The reverse has the same figure *in-cuse*. Both sides have the legend (retrograde) in relief, ΜΟΡ ΠΟΞ.

Archaic forms of Σ and Π are used. Later silver coins (see fig. 1) have the same figure of Poseidon on the obverse, and a bull on the reverse, both in relief, with the legend ΠΟΞ ΣΑΑΝΣΑΤΑΜ (ΠΟΞΕΙΑΝΙΑΤΑΞ), in which the archaic Μ for Σ and Σ for Π occur. Bronze coins of the Roman period have the legend ΠΑΞ (παιονος).

After long struggles for independence the city fell into the hands of the native Lucanians (who nevertheless did not expel the Greek colonists), and in 273 B.C. it became a municipal town under the Roman rule, the name being changed to the Latin form Pæstum. The neighbourhood was then healthy, highly cultivated, and celebrated for its flowers; the "twice blooming roses of Pæstum" are mentioned by Virgil (*Geor.*, iv. 118), Ovid (*Met.*, xv. 708), Martial (iv. 41, 10; vi. 80, 6), and other Latin poets. Its present deserted and malarious state is probably owing



FIG. 1.—Two types of silver coins of Posidonia. The larger one, the earlier type, is thin, and is incuse on the reverse. The smaller one is much thicker, and is in relief on both sides. Their weight is nearly the same.



to the silting up of the mouth of the Silarus, which has overflowed its bed, and converted the plain into unproductive marshy ground. Herds of buffaloes, and the few peasants who watch them, are now the only occupants of this once thickly populated and garden-like region. In the 9th century Pæstum was sacked and partly destroyed by Arab invaders; in the 11th century it was further dismantled by Robert Guiscard, and in the 16th century was finally deserted. The ruins of Posidonia are, however, among the most interesting of the Hellenic world. Remains of the city wall, sufficient to indicate the whole circuit (an irregular polygon about 3 miles round), still exist. The lower part of one of the gates, a fine specimen of Greek masonry, is still fairly perfect. This is a large square tower with inner and outer doorways, and on each side a projecting bastion, semicircular in plan; the whole is skilfully arranged so as to thoroughly command the doorways. A ditch, about 40 feet outside the wall, gave additional security. The main wall is 16 feet 6 inches thick. The general design of this fortification much resembles the very perfectly preserved walls and towers of Messene in the Peloponnus. For plan and description of this gate see a paper by T. L. Donaldson, *Museum of Classical Antiquities*, vol. i. p. 35, 1851. Outside the north gate there is a long street of tombs, some of which have been excavated, and have yielded a number of interesting arms, vases, and mural paintings, mostly now in the museum at Naples. The chief glory of Posidonia is its wonderful group of three well-preserved Doric temples.

The largest of these, conjecturally called the "Temple of Poseidon," is on the whole the most complete Greek temple now existing, and, judging from other specimens of the Doric style, can hardly be later than 500 B.C. The characteristics which point to its remote age are the shortness (comparatively speaking) of the columns, their rapid diminution, the complete absence of entasis, the great projection of the capitals, and the massiveness of the entablature. Another peculiarity is that the columns have twenty-four flutes, while other Doric examples rarely exceed twenty. The columns on the flanks are fourteen in all, about an average number for a Doric hexastyle temple. Fig. 2 gives the plan, in which there is nothing

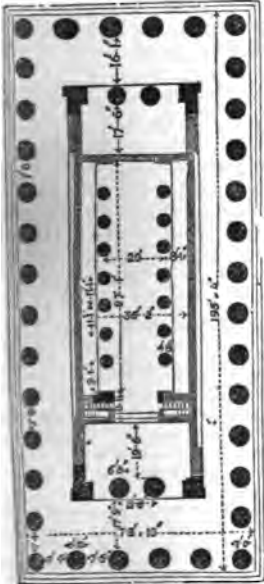

FIG. 2. Plan of the Great Temple. The shaded part does not now exist.

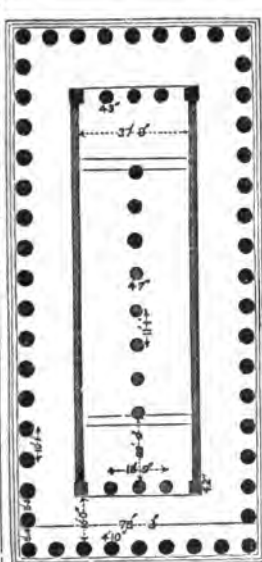

FIG. 3. Plan of the (so-called) Basilica.

conjectural; the only serious loss is the absence of the greater part of the cella wall, and some of the upper range of interior columns; the seven columns of this upper order which still remain *in situ* are specially valuable, as no other temple still possesses any of them. The peristyle columns are 6 feet 10 inches in diameter at the base,

except those at the angles, which measure 7 feet. The intercolumniation at the angles is closer than elsewhere, after the usual Doric rule. The height of the columns, including capitals, is 29 feet. The stylobate consists of three steps, and the cella floor is four steps above the peristyle pavement, i.e., nearly 5 feet, an unusual height. Indications still exist of the stairs leading to the roof or to the upper floor, which probably formed the internal ceiling over the aisles. The main dimensions of the building are, on the top step of the stylobate, nearly 196 feet in length by 79 feet wide, more than double the length of the celebrated temple of Ægina, though not quite double the width.

The material of which this and the other temples are built is a coarse calcareous stone from the neighbouring hills, formed by water deposit. None of this stone was, however, left exposed. The whole building, inside and out, like that at Ægina and other places, was carefully covered with a fine hard stucco formed of lime and pounded white marble, which took a high polish, and could hardly have been distinguished from real marble. On this was painted the usual coloured ornaments with which all important Greek buildings appear to have been decorated.

Archaisms of style, like those in this temple, are also to be found in the scanty remains still existing of the temples at Corinth and Ortygia (Syracuse), the latter probably an even earlier example of the Doric style. The other temples, though fine and well-preserved, are inferior both in size and interest. Though Greek in their general outline, and of the Doric order, yet the details, such as cornices, shafts, and capitals, are debased in style, and can hardly belong to the autonomous period of Posidonia; more probably they were built under the native Lucanian or Roman domination, while Hellenic traditions still lingered among the people. The larger of these, popularly called "the Basilica," is quite unique in plan (see fig. 3). It has nine columns (an unequal number) on its front, and a range of columns down the centre of the cella. It is pseudo-dipteral, and has eighteen columns on the flanks; all that is black in the plan still remains. The columns are very ungraceful in shape, with an extravagant amount of entasis, and a curious circlet of leaves immediately under the echinus. The most probable explanation of the strange arrangement of the cella is that the temple was dedicated to two deities—each half containing one statue.

The third temple, popularly called that of Ceres, is hexastyle peripteral, about 108 feet by 48 on the top of the stylobate, with thirteen columns on the flanks. In plan it is abnormal in having an open vestibule within the peristyle. There is an opisthodomos behind the cella. Its details throughout are very debased and un-Hellenic.

Both these latter buildings offer a striking contrast to the pure and severe Doric of the great temple. Ruins and traces of several other buildings within the city wall still exist, all apparently of the Roman period. Part of an amphitheatre, and of what may have been a circus, can be distinguished, as well as ruins of an aqueduct outside the city. Various mounds and other inequalities in the ground suggest that much still remains hidden, and that Pæstum would probably afford a rich harvest to the careful explorer, while a very simple system of drainage might again restore to this once fertile plain its long-lost wholesomeness of air and richness of soil.

See Strabo, v. and vi.; Wilkins, *Magna Græcia*, 1807; Piranesi, *Ville de Pæstum*, Rome, 1778; Major, *Ruins of Pæstum*, 1768; La Gardette, *Ruines de Pæstum*, 1779; Bötticher, *Die Tektone der Hellenen*, 1844-52, vol. II. p. 322, and plates; Ferguson, *The Parthenon*, 1883, p. 63; Labrousse, *Les Temples de Pæstum*, 1877. This last work has the best and most accurate drawings, specially executed for the Paris Ecole des Beaux Arts. (J. H. M.)

PAEZ, JOSÉ ANTONIO, one of the leaders of the struggle for South-American independence, and the first president (1830-38) of the republic of Venezuela, was born of Indian parents in the neighbourhood of Acarigua in the province of Barinas, and died in exile at New York, May 6, 1873. His military career, which began about 1810, was distinguished by the defeat of the Spanish forces at Mata de la Miel (1815), at Montecal and throughout the province of Apure (1816), and at Puerto Cabello (1823). At first he acted in concert with BOLÍVAR (*q.v.*), but in 1829 he procured the secession of Venezuela from the republic of Colombia. For his later life see VENEZUELA. His autobiography was published at New York in 1867-69, and his son Ramon Paez (otherwise known as an author) wrote *Public Life of J. A. Paez* (1864).

PAEZ, PEDRO (1564-1622), Jesuit missionary to Abyssinia, was born at Olmedo in Old Castile in 1564. Having entered the Society of Jesus, he was set apart for foreign mission service, and sent to Goa in 1588. Within a year he was despatched from that place along with a

fellow missionary to Abyssinia, but having fallen into the hands of pirates at Ormuz he was detained in that neighbourhood for seven years as a galley slave. Having been redeemed by his order in 1596, he next spent some years in mission work at Diu and Cambaya and other places on the west coast of India, and it was not until 1603 that he reached his original destination, landing at the port of Massowah. At the headquarters of his order in Fremona, he soon acquired the two chief dialects of the country, translated a catechism, and set about the education of some Abyssinian children. He also established a reputation as a preacher, and, having been summoned to court, succeeded in vanquishing the native priests and in converting Za-Denghel, the king, who wrote to the pope and the king of Spain for more missionaries, an act of zeal which involved him in civil war, and ultimately cost him his life (October 1604). Under the succeeding sovereign the influence of Paez became still greater, not only the king but the nobility having abjured Paganism and accepted Christianity. Paez, who is said to have been the first European to visit the Abyssinian Nile, died of fever in 1622. See *ABYSSINIA*, vol. i. p. 65.

PAGANINI, NICOLÒ (1784-1840), the most extraordinary of executants on the violin, past or present, was born at Genoa, February 18, 1784. His father, a clever amateur, imbued him with a taste for music at a very early age. He first appeared in public at Genoa, in 1793, with triumphant success. In 1795 he visited Parma for the purpose of taking lessons from A. Rolla, who, however, said that he had nothing to teach him. On returning home, he studied more diligently than ever, practising single passages for ten hours at a time, and publishing compositions so difficult that he alone could play them. After spending some years in close retirement, he started, in 1805, on a tour through Europe, astonishing the world with his matchless performances on the fourth string alone. In 1827 the pope honoured him with the Order of the Golden Spur; and, in the following year, he extended his travels to Germany, beginning with Vienna, where he created a profound sensation. He first appeared in Paris in 1831; and on June 3 in that year he played in London, at the King's Theatre. His visit to England was preluded by the most absurd and romantic stories. He was described as a political victim who had been immured for twenty years in a dungeon, where he played all day long upon an old broken violin with one string, and thus gained his wonderful mechanical dexterity. The result of this and other foolish reports was that he could not walk the streets without being mobbed. Here, as in other countries, he amassed a princely fortune, notwithstanding enormous losses caused by his unhappy propensity for speculation. In 1834 Berlioz composed for him his beautiful symphony, *Harold en Italie*. He was then at the zenith of his fame; but his health, long since ruined by excessive study, declined rapidly. In 1838 he suffered serious losses in Paris, yet generously presented Berlioz with 20,000 francs in return for his symphony. The disasters of this year increased his malady—laryngeal phthisis—and, after much suffering, he died at Nice, May 27, 1840. Paganini's style was impressive and passionate to the last degree. His *cantabile* passages moved his audience to tears, while his *tours de force* were so astonishing that a Viennese amateur publicly declared that he had seen the devil assisting him. No later violinist has as yet eclipsed his fame as an executant, though he was far from realizing the artistic perfection so nobly maintained by Spohr and Joachim. The best of his imitators was his pupil Siveri.

PAHLAVÍ, or PEBLEVI, the name given by the followers of Zoroaster to the character in which are written the ancient translations of their sacred books and some other

works which they preserve. The name can be traced back for many centuries; the great epic poet Firdausí (second half of the 10th Christian century) repeatedly speaks of Pahlavi books as the sources of his narratives, and he tells us among other things that in the time of the first Khosrau (Chosroes I., 531-579 A.D.) the Pahlavi character alone was used in Persia.<sup>1</sup> The learned Ibn Mokaffá (8th century) calls Pahlavi one of the languages of Persia, and seems to imply that it was an official language.<sup>2</sup> We cannot determine what characters, perhaps also dialects, were called Pahlavi before the Arab period. It is most suitable to confine the word, as is now generally done, to designate a kind of writing—not only that of the Pahlavi books, but of all inscriptions on stone and metal which use similar characters and are written on essentially the same principles as these books.

At first sight the Pahlavi books present the strangest spectacle of mixture of speech. Purely Semitic (Aramaic) words—and these not only nouns and verbs, but numerals, particles, demonstrative and even personal pronouns—stand side by side with Persian vocables. Often, however, the Semitic words are compounded in a way quite unsemite, or have Persian terminations. As read by the modern Zoroastrians, there are also many words which are neither Semitic nor Persian; but it is soon seen that this traditional pronunciation is untrustworthy. The character is cursive and very ambiguous, so that, for example, there is but one sign for *z*, *s*, and *r*, and one for *y*, *d*, and *g*; this has led to mistakes in the received pronunciation, which for many words can be shewn to have been at one time more correct than it is now. But apart from such blunders there remain phenomena which could never have appeared in a real language; and the hot strife which raged till recently as to whether Pahlavi is Semitic or Persian has been closed by the discovery that it is merely a way of writing Persian in which the Persian words are partly represented—to the eye, not to the ear—by their Semitic equivalents. This view, the development of which began with Westergaard (*Zendavesta*, p. 20, *note*), is in full accordance with the true and ancient tradition. Thus Ibn Mokaffá, who translated many Pahlavi books into Arabic, tells us that the Persians had about one thousand words which they wrote otherwise than they were pronounced in Persian.<sup>3</sup> For *bread* he says they wrote *LEMA*, i.e., the Aramaic *lahmá*, but they pronounced *śma*, which is the common Persian word for bread. Similarly *BERA*, the Aramaic *beśr*, flesh, was pronounced as the Persian *gōšt*. We still possess a glossary which actually gives the Pahlavi writing with its Persian pronunciation. This glossary, which besides Aramaic words contains also a variety of Persian words disguised in antique forms, or by errors due to the contracted style of writing, exists in various shapes, all of which, in spite of their corruptions, go back to the work which the statement of Ibn Mokaffá had in view.<sup>4</sup> Thus the Persians did the same thing on a much larger scale, as when in English we write *£* (libra) and pronounce "pound" or write *o* or *e* (et) and pronounce "and." No system was followed in the choice of Semitic forms. Sometimes

<sup>1</sup> We cannot assume, however, that the poet had a clear idea of what Pahlavi was.

<sup>2</sup> The passage, in which useful facts are mixed up with strange notions, is given abridged in *Fihrist*, p. 13, more fully by Yákút, iii. 925, but most fully and accurately in the unprinted *Mafátiḥ al-'olám*.

<sup>3</sup> *Fihrist*, p. 14, l. 13 *sq.*, comp. l. 4 *sq.* The former passage was first cited by Quatremère, *Jour. As.* (1835), l. 256, and discussed by Clermont-Ganneau, *Ibid.* (1866), l. 430. The expressions it uses are not always clear; perhaps the author of the *Fihrist* has condensed somewhat.

<sup>4</sup> Editions by Hoehangli and Hang (Bombay, 1870), and by Salemann (Leyden, 1878). See also J. Olshausen, "Zur Würdigung der Pahlavi-glossare," in Kuhn's *Zeit. f. vergl. Sprachforsch.*, N.F., vi. 521 *sq.*

a noun was written in its *status absolutus*, sometimes the emphatic *d* was added, and this was sometimes written as *n* sometimes as *ṛ*. One verb was written in the perfect, another in the imperfect. Even various dialects were laid under contribution. The Semitic signs by which Persian synonyms were distinguished are sometimes quite arbitrary. Thus in Persian *khvōsh* and *khvat* both mean "self"; the former is written *nṛšh* (*nafsh* or *nafsh*), the latter *vrsh* with the preposition *bē* prefixed. Personal pronouns are expressed in the dative (i.e., with prepositional *l* prefixed), thus *LK* (*lakh*) for *tu*, "thou," *LNH* (*land*) for *avā*, "we." Sometimes the same Semitic sign stands for two distinct Persian words that happen to agree in sound; thus because *ādād* is Aramaic for "this," *HNA* represents not only Persian *ē*, "this," but also the interjection *ē*, i.e., "O" as prefixed to a vocative. Sometimes for clearness a Persian termination is added to a Semitic word; thus, to distinguish between the two words for father, *pit* and *piar*, the former is written *AB* and the latter *ABTR*. The Persian form is, however, not seldom used, even where there is a quite well-known Semitic ideogram.<sup>1</sup>

These difficulties of reading mostly disappear when the ideographic nature of the writing is recognized. We do not always know what Semitic word supplied some ambiguous group of letters (e.g., *PUN* for *pa*, "to," or *HT* for *agar*, "if"); but we always can tell the Persian word—which is the one important thing—though not always the exact pronunciation of it in that older stage of the language which the extant Pahlavi works belong to. In Pahlavi, for example, the word for "female" is written *mdtak*, an ancient form which afterwards passed through *mdthak* into *mdtha*. But it was a mistake of later ages to fancy that because this was so the sign *T* also meant *D*, and so to write *T* for *D* in many cases, especially in foreign proper names. That a word is written in an older form than that which is pronounced is a phenomenon common to many languages whose literature covers a long period. So in English we still write *though* when we do not pronounce the guttural in *through*, and write *laugh* when we pronounce *laf*.

Much graver difficulties arise from the cursive nature of the characters already alluded to. There are some groups which may theoretically be read in hundreds of ways; the same little sign may be *ṣ*, *ṣ*, *ṣ*, *ṣ*, *ṣ*, *ṣ*, and the *ṣ* too may be either *h* or *kh*.

In older times there was still some little distinction between letters that are now quite identical in form, but even the fragments of Pahlavi writing of the 7th century recently found in Egypt show on the whole the same type as our MSS. The practical inconveniences to those who knew the language were not so great as they may seem; the Arabs also long used an equally ambiguous character without availing themselves of the diacritical points which had been devised long before.

Modern MSS., following Arabic models, introduce diacritical points from time to time, and often incorrectly. These give little help, however, in comparison with the so-called Pázand or transcription of Pahlavi texts, as they are to be spoken, in the character in which the *Avēdā* itself is written, and which is quite clear and has all vowels as well as consonants. The transcription is not philologically accurate; the language is often modernized, but not uniformly so. Pázand MSS. present dialectical variations according to the taste or intelligence of authors and copyists, and all have many false readings. For us, however, they are of the greatest use. To get a conception of Pahlavi one cannot do better than read the *Minibi-Kuradh* in the Pahlavi with constant reference to the

Pázand.<sup>2</sup> Critical labour is still required to give an approximate reproduction of the author's own pronunciation of what he wrote.

The coins of the later Sásanian kings, of the princes of Tabaristán, and of some governors in the earlier Arab period exhibit an alphabet very similar to Pahlavi MSS. On the older coins the several letters are more clearly distinguished, and in good specimens of well-struck coins of the oldest Sásanians almost every letter can be recognized with certainty. The same holds good for the inscriptions on gems and other small monuments of the early Sásanian period; but the clearest of all are the rock inscriptions of the Sásanians in the 3d and 4th centuries, though in the 4th century a tendency to cursive forms begins to appear. Only *r* and *v* are always quite alike. The character of the language and the system of writing is essentially the same on coins, gems, and rocks as in MSS.—pure Persian, in part strangely disguised in a Semitic garb. In details there are many differences between the Pahlavi of inscriptions and the books. Persian endings added to words written in Semitic form are much less common in the former, so that the person and number of a verb are often not to be made out. There are also orthographic variations; e.g., long *ā* in Persian forms is always expressed in book-Pahlavi, but not always in inscriptions. The unfamiliar contents of some of these inscriptions, their limited number, their bad preservation, and the imperfect way in which some of the most important of them have been published<sup>3</sup> leave many things still obscure in these monuments of Persian kings; but they have done much to clear up both great and small points in the history of Pahlavi.<sup>4</sup>

Some of the oldest Sásanian inscriptions are accompanied by a text belonging to the same system of writing, but with many variations in detail,<sup>5</sup> and an alphabet which, though derived from the same source with the other Pahlavi alphabets (the old Aramaic), has quite different forms. This character is also found on some gems and seals. It has been called Chaldeo-Pahlavi, &c. Olshausen tries to make it probable that this was the writing of Media and the other that of Persia. The Persian dialect in both sets of inscriptions is identical or nearly so.<sup>6</sup>

The name Pahlavi means Parthian, Pahlav being the regular Persian transformation of the older Parthava.<sup>7</sup> This fact points to the conclusion that the system of writing was developed in Parthian times, when the great nobles, the Pahlavans, ruled, and Media was their main seat, "the Pahlav country." Other linguistic, graphical, and historical indications point the same way; but it is still far from clear how the system was developed. We know indeed that even under the Achæmenians Aramaic writing and speech were employed far beyond the Aramaic lands even in official documents and on coins. The Eransians had no convenient character, and might borrow

<sup>1</sup> The book of the *Mainyo-i-Khard* in the original Pahlavi, ed. by Fr. Ch. Andreev, Kiel, 1882; id., *The Pázand and Sanskrit Texts*, by E. W. West, Stuttgart and London, 1871. West is the greatest living authority on Pahlavi.

<sup>2</sup> See especially the great work of F. Stolze, *Persepolis*, 2 vols., Berlin, 1852. It was De Sacy who began the decipherment of the inscriptions.

<sup>3</sup> Thus we now know that the ligature in book-Pahlavi which means "in," the original letters of which could not be made out, is for *ṣ*, "between." It is to be read *andar*.

<sup>4</sup> Thus *pa*, "son," is written *ṣ* instead of *ṣ*; *pa*, "before," is written *ṣ*, but in the usual Pahlavi it is *ṣ*.

<sup>5</sup> What the *Parthian* (p. 18 sq.) has about various forms of Persian writing certainly refers in part at least to the species of Pahlavi. But the statements are hardly all reliable, and in the lack of trustworthy specimens little can be made of them.

<sup>6</sup> This was finally proved by Olshausen, following earlier scholars; see J. Olshausen, *Parthava und Pahlav, Māda und Māh*, Berlin, 1877 (and in the *Monatsh.* of the Academy).

<sup>7</sup> For examples of various peculiarities see the notes to Noldeke's translation of the story of *Artachshir i Pāpakān*, Göttingen, 1879.

the Aramaic letters as naturally as they subsequently borrowed those of the Arabs. But this does not explain the strange practice of writing Semitic words in place of so many Persian words which were to be read as Persian. It cannot be the invention of an individual, for in that case the system would have been more consistently worked out, and the appearance of two or more kinds of Pahlavi side by side at the beginning of the Sāsānian period would be inexplicable. But we may remember that the Aramaic character first came to the Eranians from the region of the lower Euphrates and Tigris, where the complicated cuneiform character arose, and where it held its ground long after better ways of writing were known. In later antiquity probably very few Persians could read and write. All kinds of strange things are conceivable in an Eastern character confined to a narrow circle. Of the facts at least there is no doubt.

The Pahlavi literature embraces the translations of the holy books of the Zoroastrians, dating probably from the 6th century, and certain other religious books, especially the *Minū-Khradh* (see above) and the *Bundahish*.<sup>1</sup> The *Bundahish* dates from the Arab period. Zoroastrian priests continued to write the old language as a dead tongue and to use the old character long after the victory of a new empire, a new religion, a new form of the language (New Persian), and a new character. There was once a not quite inconsiderable profane literature of which a good deal is preserved in Arabic or New Persian versions or reproductions, particularly in historical books about the time before Islam.<sup>2</sup> Very little profane literature still exists in Pahlavi; the romance of Ardāshir has been mentioned above (p. 135, note 1). The difficult study of Pahlavi is made more difficult by the corrupt state of our copies, due to ignorant and careless scribes. A Pahlavi grammar is of course an impossibility. The necessary preparation for the study is a sound knowledge of New Persian, with which one easily finds the clue to the inconsiderable grammatical variations of the older language. The lexical peculiarities of the texts are more considerable, and partly due to the peculiarities of priestly thought and speech. Of glossaries, that of West (Bombay and London, 1874) is to be recommended; the large Pahlavi, Gujarati, and English lexicon of Jamsaspī Dastu. Minocheherji (incomplete, 3 vols., Bombay and London, 1877-82) is very full, but has numerous false or uncertain forms, and must be used with much caution. (THE N.)

PAINE, THOMAS (1736-1809), the author of *The Rights of Man* and *The Age of Reason*, would have had a very different kind of reputation if he had never written these works. Most of those who know him by name as a ribald scoffer against revealed religion are not aware that he has any other title to fame or infamy. But if he had never meddled with religious controversy, his name would have been remembered in the United States at least as one of the founders of their independence. He had a prominent reputation when he crossed the Atlantic to stir up the people of the Old World against monarchy and aristocracy, taking as his motto "Where liberty is not, there is my country." Even after he wrote *The Rights of Man*, if he had been guillotined by Robespierre, which he very narrowly escaped being, he might have been remembered in Britain as a clever but crazy and dangerous political enthusiast. The final verdict of history upon his usefulness would have turned on the question whether the United States did well to declare and fight for independence. But *The Age of Reason* brought his name into disrepute almost as much in the United States as in England. The career of Paine was a very extraordinary one. The son of a Quaker staymaker, of Thetford in Norfolk, he had emigrated to the American colonies somewhat late in life, after erratically trying various ways of making a living as a marine, an exciseman, a teacher of English, and acquiring a reputation in local political

clubs by extreme views and vigour in debate. Born in 1736, he was thirty-eight when he arrived in America, and he apparently went with a purpose, his combative temper attracted by the quarrel then reaching an acute stage, for he carried introductions with him from Franklin to the leaders of the resistance to the mother-country. His opportunity came when these leaders were dispirited and disposed to compromise. He then set the colonists in a flame with a pamphlet entitled *Common Sense*, a most telling array of arguments for separation and for the establishment of a republic, conveyed in strong direct unqualified language. There is a complete concurrence of testimony that Paine's pamphlet, issued on the 1st January 1776, was a turning-point in the struggle, that it roused and consolidated public feeling, and swept waverers along with the tide. The New York assembly appointed a committee to answer it, but the committee separated with the conclusion that it was unanswerable. When war was declared, and fortune at first went against the colonists, Paine, serving with Washington as a private soldier, composed by the light of camp fires a short hortative tract, *The Crisis*, which was read to the army, and seems to have had a wonderful effect in restoring a courage that was considerably impaired by defeat. Its opening words, "These are the times that try men's souls," became a battle-cry. This and other literary services were recognized by Paine's appointment in the first Congress to be secretary of the committee on foreign affairs. The republic finally established, another phase of his turbulent career was entered on. He determined to return to England, and "open the eyes of the people to the madness and stupidity of the Government." His chief effort in this propagandism was *The Rights of Man*, written as an answer to Burke's *Reflexions on the Revolutions in France*. The first part appeared in 1791, and had an enormous circulation before the Government took the alarm and endeavoured to suppress it, thereby exciting the most intense curiosity to see it even at the risk of heavy penalties. Those who know the book only by hearsay as the work of a furious incendiary would be surprised at the dignity, force, and temperance of the style; it was the circumstances that made it inflammatory. Pitt "used to say," according to Lady Hester Stanhope, "that Tom Paine was quite in the right, but then he would add, 'What am I to do? As things are, if I were to encourage Tom Paine's opinions, we should have a bloody revolution.'" Paine accordingly was indicted for treason, but before the trial came off he was elected by the department of Calais to the French Convention, and was allowed to pass into France followed by a sentence of outlawry. The first years that he spent in France form a curious episode in his life. As he knew little of the language, he could have had but little influence on affairs, but he was treated with great respect, and did what he could in the interests of moderation till he incurred the suspicion of Robespierre and was thrown into prison, escaping the guillotine by an accident. He completed the first part of the *Age of Reason* in the exciting interval between his accusation and his arrest, and put it into the hands of a friend on his way to prison. The publication of the work made an instant change in his position on both sides of the Atlantic, the indignation in the United States being as strong as in England. Washington, to whom he had dedicated his *Rights of Man*, declined to take any steps for his release from the prison of the Luxembourg, and he lay there for several months after the fall of Robespierre. The *Age of Reason* can now be estimated calmly. It was written from the point of view of a Quaker who did not believe in revealed religion, but who held that "all religions are in their nature mild and benign" when not associated with political

<sup>1</sup> The translations edited by Spiegel, the *Bundahish* by Westergaard and Justi, other Pahlavi books by Spiegel and Haug, by Hoshangji, and other Indian Pārses.

<sup>2</sup> We have also one book, the stories of *Kalllag* and *Damrag*, in a Syriac version from the Pahlavi, the latter in this case being itself taken from the Sanakri.

systems. Intermixed with the coarse unceremonious ridicule of what he considered superstition and bad faith are many passages of earnest and even lofty eloquence in favour of a pure morality founded on natural religion, fully justifying the bishop of Llandaff's saying:—"There is a philosophical sublimity in some of your ideas when speaking of the Creator of the universe." The work in short—a second part was published after his release—represents the deism of the 18th century, in the hands of a rough, ready, passionate controversialist. Paine remained in France till 1802, and then returned to America, occupying the rest of his turbulent active life with financial questions and mechanical inventions. He died in 1809.

PAINT. See PIGMENT.

PAINTING. A general examination of the place of painting among the FINE ARTS will be found under that heading. The main SCHOOLS OF PAINTING (q.v.) will form the subject of a separate article. For the history of the art, see also ARCHÆOLOGY (CLASSICAL) and the notices of individual painters. The present article is limited to a few practical notes on the methods of painting in oil and water colour, other methods being dealt with under the headings ENAMEL, ENCAUSTIC PAINTING, FUSCO, and TEMPERA.

*Painting-Room.*—The painting-room or atelier should be of sufficient dimensions to allow the artist space to retire from his work, if it is on a scale large enough to require viewing from a distance. For large decorative paintings the room must be spacious. The size and altitude of the window is of great importance. If the opening is contracted, the light and shade on the model will be broad and intense, and the colouring sombre, especially in the shadows. If abundance of light is admitted, the tendency will be more towards brightness and purity. Painters generally prefer a window with a northern or eastern aspect.

The painting-room has a great influence in determining not only the effects in the works of individual artists, but the characteristics of whole schools. Leonardo da Vinci was among the first to show partiality to indoor effects and deep shadows. Correggio, the artists of the Bolognese school, Caravaggio, Spagnoletto, and other Neapolitan and Spanish painters followed; the Dutch painter Rembrandt perhaps carried these extreme contrasts of light and shade to the greatest length. The effects thus obtained are, however, more or less artificial, and very unlike the ordinary aspect of the open daylight face of nature.

Painters, unless there happens to be some special reason to the contrary, usually work with the light to the left to prevent the shadow cast from the brush falling inwards. Some artists who seek to represent open air effects paint from their models in glass-houses, specially constructed for the purpose. The practice has much to recommend it, the diffused light enabling them to approximate more nearly to the truth of nature.

*Implements used in Painting.*—The *easel* is a frame, or rest, which supports the picture during its progress. Easels are of various kinds:—the triangular, supplied with pegs for the adjustment of the height of the work; the square, or rack easel, which is much more convenient; and the French studio easel, having a screw at the back and worked by a handle in the front, by which arrangement pictures of considerable size and weight can be raised or lowered or inclined forward with great ease. There is also a variety of light portable easels used for out-door sketching.—The *palette* is the board on which the colours are arranged to paint from; it is usually either of an oval or oblong square form, of light-coloured wood, and, to avoid inconvenience being felt from its weight, it should be thin and well balanced on the thumb. It ought

to be kept clean and the colour never allowed to dry on it.—The *palette-knife* has a pliable blade, and is used for arranging the colours on the palette, mixing tints, &c. With some painters it not unfrequently takes the place of the brush in the application of colour.—The larger kinds of *brushes* are made of hog-hair. They are either round or flat, but the latter are generally preferred, though for some purposes round ones are found to be useful. Brushes are also made of sable; these should have the property of coming to a fine point when required. Brushes of badger's hair are used for "softening" or "sweetening,"—that is, blending the colours by sweeping lightly to and fro over them while freshly laid (a practice to be avoided as much as possible). Brushes should be carefully washed after use, either in spirits of turpentine or with soap and tepid water, dried, and the hairs laid smooth with the finger and thumb. A brush in which the colour has been allowed to dry is difficult to clean, and is much injured, if not rendered entirely useless, by such negligence. Not a little depends on the good condition in which the brushes are kept.—The *mahl-stick* is used to steady the hand while painting details. It is held in the left hand, and the end of the stick, properly wadded, rests on the canvas. It should be light and firm. The old painters never used the mahl-stick when working on large pictures, and many artists dispense with it altogether. Rubens mentions being obliged to have recourse to one in his old age.—The *dais* or *throne* is a platform varying from a foot to 18 inches in height. Portrait painters, and artists who generally stand while at work, find it desirable to have the sitter or model nearly on a level with the eye.—A *mirror* hung in a convenient place in the painting-room will be found of great use. It enables the artist to detect faults in drawing to which he might otherwise be blinded from too long gazing at his work. The picture is seen in the mirror reflected in reverse, and errors consequently appear greater than they really are.—The *lay-figure*, a wooden or stuffed doll, usually life-size, is very serviceable in painting elaborate dresses and draperies. The best kinds are so constructed that they can be made to assume and retain any posture. Fra Bartolommeo first brought the lay-figure into use.

*Materials used in Painting.*—These consist of canvases, prepared panels and mill-boards, oils, varnishes, and colours.  
1. *Canvas* is the material now generally used. It is kept in rolls of various width and of three qualities—plain cloth, Roman, and ticken. It is prepared with two kinds of grounds—the hard or oil ground, and the absorbent ground. The ground is generally of a light colour; many artists prefer pure white. The grounds employed by the first oil painters were identical with those of tempera; the surface of the panel was prepared with two or three coats of size, a layer of coarse gesso was then applied, and on this at least eight layers of a finer description were spread, and the surface carefully scraped till it became smooth and white. In the Italian school of a later period, the grounds were generally composed of pipe-clay mixed with chalk. It is generally acknowledged that white grounds are in every way preferable, although it matters little whether the brightness reside in the ground or is reproduced at a subsequent stage by painting with a solid body of opaque colour over a dark ground. Velazquez and other Spanish painters used canvases prepared with a red earthy ground. The intention of priming the ground is to prevent the very rapid absorption of colours. Canvas prepared with the object of partially abstracting the oil from the first layers of colour is called "absorbent." For small cabinet pictures panels of well-seasoned mahogany are used; mill-boards, academy boards, and oil paper are serviceable for sketching from nature.

2. *Oils and Varnishes.*—The introduction of oil painting on the modern methods dates from the time of John Van Eyck. This artist introduced a varnish, probably composed of linseed or nut oil mixed with some resinous substance, which was more siccative than the oil vehicles previously in use, and possessed the property of drying without exposure to the sun or to artificial heat. The oil painting of the early Flemish masters was, strictly speaking, (oil) varnish painting: an oleo-resinous substance, such as amber varnish, was mixed with the colours, and rendered final varnishing unnecessary. The Venetian painters also adopted this vehicle. The term "vehicle" is borrowed from pharmacy. In art it is applied to the fluid used for bringing the pigments into a proper working state. Painters differ greatly as to the vehicles they employ: some use oil only; others peculiar compounds of their own, made of linseed, poppy, or walnut oils, copal or amber varnishes, drying oil and mastic, &c. Siccatif, a medium specially prepared for oil painting, is now largely used; mixed with spirits of wine, it forms a beautiful transparent varnish.

3. *Colours.*—The permanent colours are the earths and ochres and those mineral colours which bear the test of fire and lime. Colours prepared from lead and animal and vegetable substances are more or less fugitive. Artist's colours were originally kept in a dry state, and afterwards in small bladders; they are now enclosed in very convenient collapsible metal tubes.

The discoveries of modern chemistry have added largely to the simple list of colours known to the old masters, but perhaps with little advantage to their successors, for their is much truth in the maxim that "the shortest way to good colouring is through a simple palette." Pliny asserts that the ancient Greek painters employed but four colours in their works.

A large proportion of colours, such as the ochres, vermilion, ultramarine, &c., is derived from minerals; indigo, madder, gamboge, &c., from vegetable, and carmine, Indian yellow, sepia, &c., from animal substances. The artificial or chemical preparations include Prussian blue, Naples yellow, zinc white, French blue, cobalt, the lakes, &c.

The natural or true pigments are prepared for use by calcining and washing, and for oil painting are ground up in poppy or linseed oils. With two or three exceptions the pigments derived from the mineral kingdom are the most permanent, especially those containing iron or copper. Those derived from animal and vegetable substances have less permanence, but they form an important acquisition to the palette, as they not unfrequently possess a purity and brilliancy of colour which makes it almost impossible to dispense with them.

Colours are opaque or transparent. The former, on account of their solidity and opacity, are employed to represent light. For shadows and glazing transparent pigments are used. Yellow, red, and blue cannot be composed, and are called primary colours. The union of two of these in the three combinations of which alone they admit produces secondary colours. White represents light, and in oil painting the only white pigment used is white lead, prepared with great care. The ochres are the most permanent yellows. Their composition is very variable, but they may be considered true chemical combinations of clay and oxide of iron. The native ochres are yellow and red. By calcination the yellow ochres become red. Other yellows are prepared from arsenic, lead, and vegetable substances. Iron is the great colouring principle of red in nature. All the three kingdoms—mineral, animal, and vegetable—contribute to the red pigments. The first supplies vermilion and the red ochres; the second carmine, obtained from the cochineal insect; the third

the madder pigments. The principal blue pigments are ultramarine (native and artificial), cobalt, smalt, Prussian blue, and indigo. Ultramarine is the only pure primary colour; the finer specimens have neither a tinge of green on the one hand nor of purple on the other. It is obtained from the mineral lazulite or lapis-lazuli, and is probably a volcanic product, as it resists the action of fire. Its scarcity, and consequent high price, have produced many artificial imitations. These are of many qualities. The inferior are used in paper staining, the finer alone being reserved for artists' use. Cobalt is now prepared in a state of great purity, but it has the objection of appearing violet in artificial light.

In "guides to oil painting" long lists of pigments are generally given; but these serve only to perplex and embarrass. About a dozen colours, judiciously chosen, will be quite sufficient to supply the palette.

*Processes and Manipulations.*—There are various technical distinctions in the modes of applying the colours to a picture in its successive stages. *Glazing* is the laying of thinly transparent colours, diluted with a considerable quantity of vehicle, which allows the work beneath to appear distinctly through, but tinged with the colour of the glaze. The Venetian painters, Titian especially, largely employed this process, advancing their pictures as far as possible with solid, opaque colour, and upon this ground glazing repeatedly the richest and purest colours. The process of glazing is generally effected by the application of diluted transparent colour, but semi-transparent colours are also used when rendered sufficiently transparent by the admixture of a large proportion of vehicle. When carried to excess, the result is a "horny" impure dulness of surface and a heavy and dirty tone of colour. Much practice and experience are required for its proper performance. *Scumbling* resembles glazing in that a very thin coat is spread lightly over portions of the work, but the colour used is opaque instead of transparent. A hog-hair brush sparingly charged with the tint is employed. Carried to excess, scumbling produces a "smoky" appearance. *Impasting* is the term applied to laying colours in thick masses on the lights. The shadows or dark portions of a picture are painted thinly and transparently, the lights solidly, with opaque colours. Impasting gives "texture" and "surface" to the latter, and helps to produce the appearance of roundness and relief. When carried too far it produces an appearance of coarseness and affords a lodgment for dirt and varnish in what should be the brightest and purest passages in the colouring.

Irregularities of surface in such passages of a picture as it may be desirable to repaint are removed by using an instrument especially made for the purpose; but an old razor, an ordinary pocket-knife, or a piece of window glass, properly broken, will, in skilful hands, answer the purpose equally well. This process should not be attempted till the colour to be removed has hardened, otherwise the pigment will tear off and leave the surface in a condition which it will be found difficult to remedy.

It is the practice of some artists to lay the colours at first cold and pale, gradually strengthening the light and shade, and enforcing the colour in subsequent paintings. When this practice is adopted, the colours used should be as few and as simple as possible. It sometimes happens that considerable portions of the first painting are apparent through all the subsequent processes, and this early part of the work should be done with great care and judgment.

The first principle in the application of paint is to avoid unnecessary mixing, or, as it is called, "troubling" or saddening the tints, the result of which is a waxy surface and muddiness of colour. When this is avoided the touches are clear and distinct, but when the principle is carried to



excess it degenerates into manner; or it may serve as a convenient screen for the want of accurate observation and thorough execution.

Among the masters most remarkable for precision and rapidity of handling are Velazquez, Tintoretto, Veronese, and Rubens. The execution of Leonardo da Vinci is laboured. Vanderwerf, Mengs, and Denner are also instances of laboured smoothness. The three last-named belong to a class designated "the polishers,"—"little men, who did not see the whole at a time, but only parts of a whole, and thus vainly essayed to make up the whole by a smooth union of parts."

No two artists employ the same method in painting. Some attain the result aimed at by involved and complicated, others by direct and simple methods. The difference in *technique* between the work of an English artist and artists trained in French or German ateliers may be seen at a glance, and it is of little use attempting to lay down hard and fast rules on the subject. Even among the great Italian painters a wide variety of practice existed. It has been pretty well ascertained, partly from unfinished works, that Titian's method was to work out the effect of his pictures, as far as possible, with pure white, red, and black, the shadows being left cold. To prevent the yellowing of the oil, and to harden the colour, the picture was exposed to the sun, months were sometimes allowed to elapse, and then the surface of this *dead* or first colouring was rubbed down with pumice stone and fresh colours and the glazings applied, a considerable period—during which the picture was exposed to the sun—elapsing between successive applications of colour. Titian is said to have been very partial to the use of his fingers when laying on paint, particularly in flesh and glazings.

The practice of Paul Veronese was quite opposed to that of Titian. He sought almost the full effect at once by direct means and simple mixture of tints, seldom repeating his colours, and using few glazings. When the work was well advanced in this way he covered the whole with a thin coat of varnish to bring up the colours, and then retouched the lights and enforced the shadows with dexterous touches.

It is said of Reynolds, who spent half his life in experiments, that in order to discover their technical secrets he deliberately scraped away and destroyed Venetian pictures of value. The decay of so many of his works shows with how little success these experiments were rewarded.

Numerous "guides to oil painting" exist, but little real instruction or benefit is to be gained from their perusal. They abound in minute directions how to paint "trunks of trees, heaths, fields, roads, skies (grey, blue, and stormy), sunsets, sunrises, running streams and waterfalls, mountains, the smoke or steam of steamers, and chimneys of cottages," as well as "heads, flesh, backgrounds, draperies (blue, red, and black)," with lists of the proper colours to be employed for each. All this, it is hardly needful to say, is worse than useless. The surest and safest way for any one who intends to study painting seriously, or to make it his profession, is to place himself under the instruction of an artist of repute, either in his own country or in some foreign atelier; but, even after acquiring a sound technical knowledge of the processes employed in painting, it will be found that much remains to learn which no master can teach. It is said of Velazquez that "he discovered that nature herself is the artist's best teacher, and industry his surest guide to perfection, and he very early resolved neither to sketch nor to colour any object without having the thing itself before him."

*Water-Colour Painting.*—The use, in painting, of earths and minerals of different colours, diluted with water, is

of great antiquity. Painting with oils or oleo-resinous vehicles is a comparatively modern invention. Tempera, encaustic, and fresco were ancient modes of water painting. Several of the early Dutch and Flemish oil painters attained to considerable technical excellence in the separate practice of water-colour painting; little more than simple washings of water colour were employed by them, the processes which have in modern times so greatly raised and extended its scope being then unknown.

Painting in water colour owes much of its development to English artists, and may be regarded as a peculiarly national school of art. The first English water-colour painter of note, Paul Sandby, used Indian ink in the earlier stages of his drawings, finishing them with a few tints of thin colour. At this period paintings in water colour were little more than flat washes, and in the early catalogues of the Royal Academy Exhibition were designated "water-tinted" or "water-washed drawings." Improvements were gradually effected, first by varying the ground-work tint with blue and sepia, over which washes of colour, commencing with a warm generalizing tint, were struck. John Cozens was the first to substitute a mixture of indigo and Indian red in place of Indian ink as a neutral tint in the early stages of his work, a practice which was long retained. The old water-colour painters used the lead pencil or the reed pen in finishing their drawings. The first to break away from this conventional method was Girtin, who painted objects at once with the tints they appeared to possess in nature. Turner, perhaps the greatest master of the art, was closely associated with Girtin in early life, and in the course of his long career he carried water-colour painting to a degree of perfection which can scarcely be surpassed. Nearly all the great improvements which have taken place of late years in water-colour painting are due more or less to him. John Lewis, De Wint, Prout, Hunt, Cox, Harding, and Copley Fielding have all contributed to the development of the art.

*Materials used in Water-Colour Painting.*—1. *Paper.*—A great variety of papers is used, varying in texture from the extreme of roughness to hot-pressed smoothness. In many of Turner's drawings the paper is tinted. Nothing, however, seemed to come amiss to him; papers of almost any surface or texture were used. David Cox, in many of his later works, employed a rough paper made from old sail-cloth. The paper most generally used is known as "Imperial," and is made of various degrees of texture and thickness. Whatman's papers are also much esteemed.

The proper sizing of the paper is of great importance; if it is too strongly done the colours will not float or work freely, if too little they are absorbed into the fabric and appear poor and dead. In this last case, gum-arabic dissolved in warm water will improve the effect by bringing up the colour and giving greater depth and richness of tone. The paper is prepared to receive the drawing by being well sponged and stretched upon a drawing-board.

2. *Pigments.*—The permanent earthy minerals were chiefly used in ancient works, and these, with the addition of a few transparent colours, such as sepia, indigo, and Indian ink, satisfied the early water-colour painters of England. Richer and more delicate colours were gradually added, and of late years chemistry has supplied many entirely new ones. No method of giving permanency to some of the transparent yellows, carmine, and other colours obtained from the cochineal insect has yet been discovered, but the improved methods of preparing pigments from the root of the madder plant have rendered the use of carmine not so necessary. The earths and minerals are the most permanent pigments, but when employed with water they are more unmanageable, and flow less freely than the fugitive vegetable colours. Among the earlier water-colour

painters the use of opaque or "body" colour was generally considered illegitimate. Turner was the first to break through this restraint, and since his time the use of opaque colour has been carried perhaps to excess, many modern artists wilfully resigning much of the peculiar freshness and brilliancy of pure water colour for the sake of rivalling the richness and depth of oil painting.

3. *Brushes*.—Brown sable is the hair generally used; but brushes are also made of red sable and squirrel or "camel" hair. The brushes are made by the insertion of the hair into quills, the various sizes of brush being recognized by the names of the birds which supply them—eagle, swan, goose, crow, &c. Flat brushes in German—*alvier ferules* are also used.

Perhaps as great a variety of practice exists among water-colour painters as among those working in oils; each arrives at his own peculiar method by the teaching of experience. As in the case of oil painting, it would serve little purpose if the attempt was made to lay down rules and methods. All men cannot be painters, and a knowledge of the nature of the materials and of the processes employed does not necessarily carry with it ability to paint. Such essentials as a knowledge of composition, drawing, light and shade, and colour are all requisite, and these can only be obtained after years of study. If possible the guidance of some good master should be sought for at first; this will shorten the way and prevent the making of some awkward mistakes. (G. R. E.)

PAINTING, HOUSE. See BUILDING, vol. iv. p. 510; and MURAL DECORATION.

PAISIELLO, or PAESIELLO, GIOVANNI (1741–1815), one of the most talented precursors of Rossini in the Italian school of musical composition, was born at Tarento, May 9, 1741. The beauty of his voice attracted so much attention that, in 1754, he was removed from the Jesuit college at Tarento to the Conservatorio di S. Onofrio at Naples, where he studied under Durante, and in process of time rose to the position of assistant master. For the theatre of the Conservatorio he wrote some intermezzi, one of which attracted so much notice that he was invited to write two operas, *La Pupilla* and *Il Mondo al Rovescio*, for Bologna, and a third, *Il Marchese di Tulipano*, for Rome. His reputation being now firmly established, he settled for some years at Naples, where, notwithstanding the popularity of Piccini, Cimarosa, and Guglielmi, of whose triumphs he was bitterly jealous, he produced a series of highly successful operas, one of which, *L'Idolo Cinese*, made a deep impression upon the Neapolitan public. In 1776 Paisiello was invited by the empress Catherine II. to St Petersburg, where he remained for eight years, producing, among other charming works, his masterpiece, *Il Barbiere di Siviglia*, which soon attained a European reputation. The fate of this delightful opera marks an epoch in the history of Italian art; for with it the gentle suavity cultivated by the masters of the 18th century died out to make room for the dazzling brilliancy of a later period. When, in 1816, Rossini set the same libretto to music, under the title of *Almaviva*, it was hissed from the stage; but it made its way, nevertheless, and under its true title, *Il Barbiere*, is now acknowledged as Rossini's greatest work, while Paisiello's opera is consigned to oblivion,—a strange instance of poetical vengeance, since Paisiello himself had many years previously endeavoured to eclipse the fame of Pergolesi by resetting the libretto of his famous intermezzo, *La serva padrona*.

Paisiello quitted Russia in 1784, and, after producing *Il Re Teodoro* at Vienna, entered the service of Ferdinand IV. at Naples, where he composed many of his best operas, including *Nina* and *La Molinara*. After many vicissitudes, resulting from political and dynastic changes, he

was invited to Paris (1802) by Napoleon, whose favour he had won five years previously by a march composed for the funeral of General Hoche. Napoleon treated him munificently, while cruelly neglecting two far greater composers, Cherubini and Méhul, to whom the new favourite transferred the hatred he had formerly borne to Cimarosa, Guglielmi, and Piccini. But he entirely failed to conciliate the Parisian public, who received his opera *Proserpine* so coldly that, in 1803, he requested and with some difficulty obtained permission to return to Italy, upon the plea of his wife's ill health.

On his arrival at Naples Paisiello was reinstated in his former appointments by Joseph Bonaparte and Murat, but he no longer enjoyed the brilliant reputation for the attainment of which he had so industriously laboured. He had taxed his genius beyond its strength, and was unable to meet the demands now made upon it for new ideas. His prospects, too, were precarious. The power of the Bonaparte family was tottering to its fall; and Paisiello's fortunes fell with it. The death of his wife, in 1815, tried him severely. His health failed rapidly. His constitutional jealousy of the popularity of others was a continual source of worry and vexation. And on June 5, 1815, he died, a disappointed man, notwithstanding his extraordinary successes and well-earned fame.

It is impossible to believe that even the best of Paisiello's operas would be listened to at the present moment with patience, yet they abound with melodies the graceful beauty of which is still warmly appreciated. Perhaps the best known of these charming airs is the famous *Nel cor più* from *La Molinara*, immortalized by Beethoven's delightful variations. The greatest singers of the time spread the fame of this and other similar effusions throughout the length and breadth of Europe. The part of Nina conducted to one of Pasta's most splendid triumphs; and of the ninety-four operas which Paisiello is known to have composed not one can be said to have been unsuccessful. His church music was very voluminous, comprising one hundred and three masses, besides many smaller works; he also produced fifty-one instrumental compositions of more or less importance, and many detached pieces. MS. scores of many of his operas were presented to the library of the British Museum by the late Signor Dragonetti.

PAISLEY, a municipal and parliamentary burgh of Renfrewshire, Scotland, is situated on both sides of the White Cart, 3 miles from its junction with the Clyde, and on the Caledonian and the Glasgow and South-Western Railways, 7 miles west-south-west of Glasgow and 17 east-south-east of Greenock. In 1791 the river was at great expense made navigable to the town for sloops of about 30 tons burden. The old town, situated on rising ground on the west bank of the river, consists chiefly of long regular streets, and contains the principal warehouses and factories. The new town was begun towards the close of last century, and is built on level ground to the east, at one time forming the domains of the abbey. Surrounding the town there are extensive suburbs, occupied chiefly by villa residences. The river is crossed by a railway viaduct, and three bridges for carriage traffic, two of these being of iron and an old one of stone. The abbey of Paisley was founded in 1164, originally as a priory, by Walter, great steward of Scotland. Its lands were erected by James II. into a regality of which the abbot was lord, and the abbey formed the mausoleum of the Stuarts until their accession to the throne. The abbey was burned in 1307 by the English, and in 1561 by Lord Glencairn. In 1484 the grounds were surrounded by a lofty wall of hewn stone about one mile in circumference. In 1553 Claude Hamilton, a boy of ten, fourth son of the duke of Chatellerault, was made abbot *in commendam*, and in 1587 the lands

and abbey were made a temporal barony in his favour. His son was created earl of Abercorn. The abbey lands, after passing from the earl of Abercorn to the earl of Angus and thence to Lord Dundonald, were purchased in 1764 by the earl of Abercorn, with the view of making the abbey his residence, but changing his intention he let the grounds for building sites. The buildings inhabited by the monks have been totally demolished, but the nave of the abbey church is entire, and has been fitted up as a place of worship. It is one of the finest extant specimens of old ecclesiastical architecture in Scotland, and also contains several fine sculptures and monuments. The unroofed transept and the foundations of the choir enclose a burying ground. The chapel of St Mirin, forming part of the transept, and now used as the place of sepulture of the Abercorn family, contains a monument to Mary Bruce, mother of Robert II., which has been recently reconstructed. The principal secular buildings of the town are the county buildings and prison, erected in 1818 at a cost of £40,000, and afterwards extended; the John Neilson institution, opened in 1852, a handsome structure occupying a commanding position on the site of the old Roman camp; the George A. Clark town-hall, in the Gothic style, erected in 1882 at a cost of £50,000, and presented to

spinning of yarn, and, with the co-operation of a friend in Holland, originated the manufacture of fine linen thread. From 1760 till 1785 silk gauze was the principal manufacture. Muslin, cambric, and cotton thread next came into prominence. The shawl manufacture, introduced about the beginning of the present century, the speciality of which was imitation cashmere shawls—"Paisley filled plaids"—is now of minor importance. A wide range of worsted goods, mixed figured fabrics, and light figured muslins at present employ the looms. The spinning of thread and cotton is perhaps the industry for which the town is best known, although it is almost equally celebrated for its patent manufactures, including soap, starch, corn-flour, and preparations of coffee. There are also extensive bleachfields, large dye and print works, engineering works, and some shipbuilding. Since the beginning of the present century the population of the burgh (area 3530 acres) has more than trebled. In 1781 it was 11,000, which in 1791 had increased to 13,800, in 1801 to 17,026, in 1821 to 26,428, in 1831 to 31,460, in 1851 to 48,026, in 1871 to 48,257, and in 1881 to 55,642, of whom 25,832 were males and 29,810 females.

There is no doubt that on the ridge of high ground above the Cart there was a Roman fort and camp, and the supposition that Paisley was the *Vandura* of the Romans is supported by the derivation of that name, which means white water. The modern village grew up round the abbey, but the origin of the name Paisley, which was first written *Paislé*, has been disputed. About the end of the 15th century its growth had excited the jealousy of the neighbouring burgh of Renfrew, to protect it from the molestations of which Abbot Skéaw in 1488 obtained its erection into a free burgh of barony. According to this charter, granted by James IV., it obtained the privilege of returning a member to the Scottish parliament. By the Reform Act of 1833 it was created a parliamentary burgh with one representative. The burgh is governed by a provost, four bailies, a treasurer, and ten councillors. Among the eminent persons connected with Paisley are Patrick Adamson, archbishop of St Andrews; Tannahill the poet; Alexander Wilson the ornithologist; Watt, author of *Bibliotheca Britannica*; Motherwell the poet; and Professor John Wilson, "Christopher North."

See Crawford, *History of Banffshire*, 2d ed., with additions by George Robertson, 1818; *Paisley Directory*, 1833-35; Swan, *Description of the Town and Abbey of Paisley*, 1838; *Charterulary of the Monastery of Paisley*, published by the Maitland Club, 1833; David Sempie, *Saint Mirin*, 1873; *Monastery of Paisley*, 1876; J. C. Loe, *Abbey of Paisley*, 1878.

PAJOU, AUGUSTIN (1730-1809), born at Paris on 19th September 1730, was a member of the Academy and a leading sculptor of the French school during the reigns of Louis XV. and Louis XVI. His portrait busts of Buffon and of Madame Du Barry, and his statuette of Boissieu (all in the Louvre), are amongst his best works. He died at Paris May 8, 1809.

Picton, *Mélanges de la Société des bibliophiles*, 1856; Madame Du Barry, *Mémoires des œuvres de Pajou*; Barbet de Jouy *Sculptures mod. au Louvre*.

PAKHOI, or PEHAI, a city and port of China, in the west of the province of Kwang-tung, situated on a bay of the Gulf of Tong-king, formed by a peninsula running south-west from the *fu* city of Lien-chow, in 21° 30' N. lat. and 109° 10' E. long. Dating only from about 1820-30, and at first little better than a nest of pirates, Pakhoi rapidly grew into commercial importance, owing partly to the complete freedom which it enjoyed from taxation, and partly to the diversion of trade produced by the Tai-ping rebellion. The establishment of a Chinese custom-house, and the opening of the ports of Hankow and Haiphong, for a time threatened to injure its prospects; but, foreign trade being permitted in 1876-77, it began in 1879 to be regularly visited by foreign steamers. The average value of the open trade between 1880 and 1882 was £475,000 per annum, and a great deal of smuggling still takes place. Liquid indigo, sugar, aniseed and aniseed oil, cassia-lignea and cassia oil, cuttle-fish, and hides are the chief exports. With Macao especially an extensive junk trade is carried on, £77,000 worth of



Plan of Paisley.

the town; the news-room, 1808; the grammar school, in the Gothic style, 1864; the Government school of art, 1847; and the theatre. The benevolent institutions include the infirmary, the town hospital or poorhouse, the philosophical institution and humane society, the workhouse, the lunatic asylum, and Hutcheson's charity school. The Duncan Wright educational endowment provides for natives of the town several school bursaries of the value of from £5 to £10, and several college bursaries of the value of £25. The town possesses three public recreation grounds:—the Fountain Gardens of 6 acres, presented by Mr Thomas Coats in 1868, and containing an elegant structure for a museum and library erected by Sir Peter Coats in 1870; the Brodie Park, 26 acres, laid out in 1877, and presented by the late Robert Brodie of Craigiehall; and St James's Park, formed out of the race-course, which has lately been acquired by the corporation. There are statues of Wilson the ornithologist and Tannahill the poet.

Linen was manufactured at Paisley before the Union, shortly after which coarse linen cloths were succeeded by plain and figured lawns. About the beginning of the 18th century an important manufacturing industry is said to have been originated by Christian Shaw, daughter of the laird of Bargarren. She acquired great skill in the

goods being despatched for Pakhoi in the course of a year. A large number of the inhabitants (who exceed 10,000 in all) are engaged in fishing and fish-curing.

PALACKY, FRANTIŠEK (FRANCIS) (1798–1876), the Bohemian historian, was born in the year 1798 in the village of Hodelavice, in the north-eastern corner of Moravia, where his father was a schoolmaster. His ancestors had secretly remained Protestants through all the persecutions of the 17th century, and only declared themselves as such on the publication of the edict of toleration by the emperor Joseph II. His mother's name was Anna Krizan; she died in the year 1822, before her son had gained his great reputation. His father, Jiri (George), died in 1836; besides Francis they had three other sons and three daughters. Concerning the early years of the future historian we are told that he was an indefatigable reader, eagerly devouring all books which came in his way. In 1812 Palacky entered the gymnasium of Pressburg; his original intention was to become a Protestant clergyman. The national movement then going on in the country aroused the enthusiasm of the youthful student, who was induced to apply himself to the study of his native tongue by the *Essay on the Bohemian Language* of Jungmann. While in Pressburg, Palacky assisted the publicist Palkovich in his journal, *Tydenník*, and first made his appearance as an author with a translation of some of the poems of Ossian (1817), then so popular throughout Europe. After this he was for some time private tutor in various families. In 1823 Palacky removed to Prague, and formed friendships with the leading Czech literati—Jungmann, Presl, Dobrovsky, Hanka, and others. Dobrovsky introduced him to Count Sternberg, and he was appointed editor of the new *Casopis Ceskeho Musea*, which is still published. In this occupation he continued till 1838. Count Caspar Sternberg and his brother were munificent patrons of the new Bohemian Museum, which had finally been founded after many efforts. The conduct of these men was the more remarkable that the Bohemian aristocracy had then become almost entirely Germanized.

In 1829 Palacky was appointed public historiographer by the Bohemian states, and made several lengthened tours to consult documents in public libraries at Munich, Berlin, Dresden, Rome, and elsewhere. He then commenced his *History of the Bohemian People*, which has earned him the undying gratitude of his countrymen. The first volume appeared in German in 1836, but the work was carried on in the Bohemian language from 1848, and was concluded with the year 1526, the period when Ferdinand I. ascended the throne and the political independence of the Czechs ceased. Besides this Palacky obtained a prize from the Bohemian Society of Arts for his work entitled *Würdigung der alten böhmischen Geschichtschreiber*. In the year 1840 he published, in conjunction with Schafarik, *Die ältesten Denkmäler der böhmischen Sprache*. In this he appears as the champion of the early Bohemian manuscripts, the authenticity of which has been so much disputed, adopting among others the glosses in the *Mater Verborum* in the library at Prague, which have been proved to be forgeries. In the troubled year 1848 Palacky, a man of the student type, was forced into political life, but acquitted himself well. He refused to take a seat in the German parliament at Frankfort when invited to do so, on the ground that as a Czech he had nothing to do with German affairs. It was on this occasion that he uttered the memorable sentiment that so essential was Austria to the interests of Europe that, if such an empire had not existed, it would have been necessary to create one—words which were afterwards used by Jellachich as the device on his flag. Before his death, however, Palacky had changed his opinion, and despaired of any help coming from such a

source. Thus in a series of articles which he published in his old age under the title *Radhos*, he tells us—"I have thought all my life that the right would prevail, and my mistake has been in believing in the good sense and spirit of justice of the German people."

So great was the influence of Palacky at this period that he was offered a portfolio in the ministry of Fillersdorf; but in a short time the confidence placed in him by the Austrian Government was withdrawn, and he was regarded with suspicion. He soon, however, quitted politics and betook himself to his literary labours. His influence among his countrymen was now at its height. In 1860 he had the misfortune to lose his wife, whom he had married in 1827. In 1861 he was made a life member of the Austrian senate. He died in 1876, busy with literature to the end.

The great work of Palacky, his *History of the Bohemian People*, is indeed a monument of conscientious labour. His love of truth and marvellous accuracy are conspicuous on every page. To enable the Bohemians to resist the insidious attempts at their denationalization which had been steadily pursued by their enemies during the 17th and 18th centuries, it was necessary to bring before them the great past which they had been taught to forget. This Palacky has done, and his work has become a national monument. The occupation of the last years of his life was the rewriting of some of the chapters, which had seemed to him imperfectly executed, owing to the want of original documents or the censorship of the Austrian Government. In 1845 the first part of his third volume appeared, dealing with the life and religious opinions of Huss. As the work was published, it had already undergone serious mutilation at the hands of the appointed censors, but the Bohemians saw the history of Huss presented to them in its true colours; and so great was the sensation created that a Roman Catholic publicist named Helfert was commissioned to write an account of Huss and Jerome, his disciple, with the view of counteracting the effects of Palacky's work. This book duly appeared at Prague in 1857. Palacky, however, must be considered to have triumphed in the controversy. He published two other polemical works on the same subject in German: in 1868 appeared *Die Geschichte des Hussitenthums und Prof. C. Höfler*, and in 1871 another work entitled *Zur Böhmischen Geschichtschreibung*. Besides the interesting portion of his work dealing with Huss and the subsequent Hussite wars, Palacky appears to great advantage when dwelling upon the most prosperous periods of Bohemian nationality, as the reigns of Charles IV. and George Poděbrad. No pains were spared by him in his researches. Dr Kalousek tells us in his interesting memoir that, when he visited Rome in 1837 to consult the library of the Vatican, he read through 45,000 documents in ten weeks and copied 400 of them with his own hand. The work is a monument of erudition; but it may perhaps be said to be written in a somewhat dry and frigid style. It has become familiar to general readers in a German translation. Palacky also founded an historical school in Bohemia, foremost among his pupils being Vaclav Tomek and Antonin Gindely.

PALADIN (Lat., *palatinus*) literally means a courtier, a member of a royal household, one connected with a palace. The *palatinus* of the Roman emperors on the Palatine Hill supplied a name for all the royal and imperial residences in mediæval Europe, and a corresponding adjective and noun for royal officials and dependants. From being applied to the famous twelve peers of Charlemagne, the word paladin became a general term in romance for knights of great prowess.

PALEICHTHYES. See *ICHTHYOLOGY*, vol. xii. p. 685.

## PALÆOGRAPHY

**PALÆOGRAPHY** is the study of ancient handwriting from surviving examples. While epigraphy (see INSCRIPTIONS) is the science which deals with inscriptions engraved on stone or metal or other enduring material as memorials for future ages, palæography takes cognizance of writings of a literary, economical, or legal nature, written generally with stile, reed, or pen, on tablets, rolls, or books. The boundary, however, between the two sciences is not always to be exactly defined. The fact that an inscription occurs upon a hard material in a fixed position does not necessarily bring it under the head of epigraphy. Such specimens of writing as the graffiti or wall-scribbings of Pompeii and ancient Rome belong as much to the one science as to the other; for they neither occupy the position of inscriptions set up with special design as epigraphical monuments, nor are they the movable written documents with which we connect the idea of palæography. But such exceptions only slightly affect the broad distinction just specified.

The scope of this article is to trace the history of Greek and Latin palæography from the earliest written documents in those languages which have survived. In Greek palæography we have a subject which is self-contained. The Greek character, in its pure form, was used for one language only; but the universal study of that language throughout Europe, and the wide diffusion of its literature, have been the cause of the accumulation of Greek MSS. in every centre of learning. The field of Latin palæography is much wider, for the Roman alphabet has made its way into every country of western Europe, and the study of its various developments and changes is essential for a proper understanding of the character which we write.

Handwriting, like every other art, has its different phases of growth, perfection, and decay. A particular form of writing is gradually developed, then takes a finished or calligraphic style and becomes the hand of its period, then deteriorates, breaks up, and disappears, or only drags on an artificial existence, being meanwhile superseded by another style which, either developed from the older hand or introduced independently, runs the same course, and, in its turn, is displaced by a younger rival. Thus in the history of Greek writing we see the uncial hand passing from early forms into the calligraphic stage, and then driven out by the minuscule, which again goes through a series of important changes. In Latin, the capital and uncial hands give place to the smaller character; and this, after running its course, deteriorates and is superseded almost universally by the modern Italian hand dating from the Renaissance.

Bearing in mind these natural changes, it is evident that a style of writing, once developed, is best at the period when it is in general use, and that the oldest examples of that period are the simplest, in which vigour and naturalness of handwriting are predominant. On the other hand, the fine execution of a MS. after the best period of the style has passed cannot conceal deterioration. The imitative nature of the calligraphy is detected both by the general impression on the eye and by uncertainty and inconsistencies in the forms of letters. It is from a failure to keep in mind the natural laws of development and change that early dates, to which they have no title, have been given to imitative MSS.; and on the other hand, even very ancient examples have been post-dated in an incredible manner.

Down to the time of the introduction of printing,

writing ran in two lines—the set book-hand and the cursive. MSS. written in the set book-hand filled the place now occupied by printed books, the writing being regular, the lines kept even by ruling, and the pages provided with regular margins. Cursive writing, in which the letters employed were fundamentally the same as in the set hand, was necessary for the ordinary business of life. The set book-hand disappeared before the printing press; cursive writing necessarily remains.

*Materials.*—Before passing to the discussion of Greek and Latin handwriting, the materials employed and the forms which they took may be briefly noticed. The various works on palæography enumerate the different substances which have been put in requisition to receive writing. Metals, such as gold, bronze, lead, tin, have been used; leaden plates, for example, in addition to those which have been found buried with the dead and bearing inscriptions of various kinds, were also used in the Venetian states down to the 14th or 15th century as a material on which to inscribe historical and diplomatic records. The ancient Assyrians recorded their history on sun-dried or fire-burnt bricks; and inscribed potsherds or *ostraka* have been gathered in hundreds in the sands of Egypt. Such hard materials as these, however, would have no extensive use where more pliant and convenient substances, such as animal skin or vegetable growths, could be had. We have therefore practically to confine our attention to such materials as papyrus, vellum, and paper, the use of which became so universally established. But midway between the hard and soft substances, and partaking of the nature of both, stand the waxen tablets made of wood coated with wax, on which the writing was scratched with the point of the *stilus* or *graphium*. These tablets were called by the Greeks *δέλτος*, *δέλιον* or *δέλιδιον*, *πικρίδιον* or *πικρίδιον*, *πίναξ*, *πίναξίς*, &c., and in Latin *tabula* or *tabella*, or *ceræ*; and two or more, put together and connected with rings or other fastenings which served as hinges, formed a *caudex* or *codex*. A *codex* of two leaves was called *δίφυλοι* or *δίφυλλα*, *διπτυχα*; of three, *τρίφυλλα*, *τριπτυχα*; and so on. From the early specimens which have survived, and which will be examined below, the *τριπτυχα* appear to have been most commonly used. The tablets served for the ordinary affairs of life, for accounts, letters, drafts, school exercises, &c. The various references to them by classical writers need not be here repeated; but their survival to a late time should be noted. St Augustine refers to his tablets, and St Hilary of Arles also mentions their use for the purpose of correspondence; and there remains the record of a letter written in *tabella* as late as 1148 A.D. (Wattenbach, *Schriftwesen*, 2d ed., p. 46). They were very commonly used through the Middle Ages in all the west of Europe. Specimens inscribed with money accounts of the 13th and 14th centuries have survived in France; and similar documents of the 14th and 15th centuries are to be found in several of the municipal archives of Germany. Reference to their use in England occurs in literature; and specimens of the 14th or 15th century have been dug up in Ireland. Similarly in Italy their use is both recorded and proved by actual examples of the 13th or 14th century. With the beginning of the 16th century their general employment seems to have come to an end; but a few survivals of this custom of writing on wax have lingered on to modern times. It is said that sales in the fish-market of Rouen are still noted down on this material.

Among the Romans ivory was sometimes substituted for wood in the waxen tablets, as appears from passages in classical authors. The large consular diptychs are examples of the custom. The rich carvings with which these were embellished have secured their preservation in several instances; and they were often kept in the churches in the Middle Ages and inscribed with lists of bishops or abbots and benefactors.

The employment of Papyrus (*q. v.*) as an ordinary writing material in ancient Egypt, and, exported from thence, in Greece and Italy, is well known. The most ancient examples of Greek writing which will have to engage our attention are those which are found in the papyrus rolls of Egypt of the 2d century B.C. Though superseded in course of time by vellum, this material continued to be used by Greek scribes down to the 9th century. The earliest Latin writing on papyrus is contained in some fragments recovered at Herculaneum. Dating from the 5th to the 10th century are the papyrus deeds of Ravenna; and papal documents on the same substance extend from the 8th to the 11th century. Papyrus was also used for documents in France under the Merovingian kings. It was also made up into books, for the reception of literary works, in which form it was sometimes strengthened by the addition of vellum leaves which encased the quires; and, as far as can be ascertained from extant remains, it was used thus in Italy and France down to the 10th century.

Skins of animals have doubtless served as a writing material from the very earliest period of the use of letters. Instances of the use of leather in western Asia are recorded by ancient writers; and from Herodotus we learn that the Ionians applied to the later-imported papyrus the name *διφθίραι*, by which they already designated their writing material of leather. The Jews also have retained the ancient Eastern custom, and still inscribe the law upon leathern rolls. The use of parchment (*παργαμηνή, charta pergamenæ*) may be considered a revival of the ancient use of skins, now prepared by a new method attributed to Eumenes II., king of Pergamum (197-158 B.C.), who was opposed by the jealousy of the Ptolemies in his endeavours to establish a library in his capital. They forbade the export of papyrus, and so compelled him to revert to the ancient custom. The new material was prepared in such a way as to be fit to receive writing on both sides, and could thus be conveniently made up into book-form, the *σφάγιον*. The ancient name *διφθίραι* (Lat., *membrane*) was also transferred to the new invention. By common consent the name of parchment has in modern times given place to that of vellum, a term properly applicable only to calf-skin, but now generally used to describe a mediæval skin-book of any kind. Parchment is a title now usually reserved for the hard sheep-skin or other skin material on which law-deeds are engrossed.

Purple-stained vellum was used by the Romans for wrappers for their papyrus rolls. In the 3d century it is recorded that entire volumes were made of this ornamental substance and written in gold or silver; and it was against luxury of this kind that St Jerome directed his often-quoted words in his preface to the book of Job. Examples of such costly MSS. of the 6th century have survived to the present day, as the Codex Argenteus of the Gothic Gospels at Upsala, the fragments of the illustrated Genesis at Vienna, the leaves of the purple Gospels in the Cottonian Library and elsewhere, the Codex Rossanensis, lately discovered, and some others. Some richly stained leaves of the 8th century remain in the Canterbury Gospels (Royal MS., 1 E. vi.) in the British Museum. On the Continent the great impetus given to the production of

splendid MSS. under the rule of Charlemagne revived the art of staining; and several fine examples of it exist in MSS. of the 8th, 9th, and 10th centuries. At a later period, when the art was forgotten, the surface only of the vellum was painted in imitation of the older staining which soaked into the substance of the skin. Other colours besides purple were sometimes employed, particularly in the period of the Renaissance, to paint or stain vellum; but MSS. so treated are rather to be regarded as curiosities produced by the caprice of the moment.

Cotton paper (*charta bombycina*) is said to have been known to the Chinese at a remote period, and to have passed into use among the Arabs early in the 8th century. It was imported into Constantinople, and was used for Greek MSS. in the 13th century. In Italy and the West it never made much way. Rag paper came into general use in Europe in the 14th century, and gradually displaced vellum. In the 15th century MSS. of vellum and paper mixed were common. See PAPER.

With regard to the forms in which writing material was made up, the waxen tablets have already been referred to, and will be more minutely described below. Ancient papyri usually appear in the form of rolls; vellum was made up into books. The roll (*κύλιανδρος, volumen*; later, *επιγράφιον, ελιγρόν, εξέλθημα, rotulus*) was the ordinary form of written documents known to the ancients. When a work was contained in several rolls, a single roll was called *βιβλος, βιβλίον, volumen, charta*; later, *τόμος*. From the circumstance of the Bible filling many rolls it acquired such titles as *pandectes* and *bibliotheca*, the latter of which remained in use down to the 14th century. The title of the work was written at the end of the roll; and at the same place was recorded the number of columns and lines, *στίχοι*, which it contained—probably for the purpose of estimating the price. To roll and unroll was *ελεῖν* and *ἐξελείν, plicare* and *explicare*; the work unrolled and read to the end was the *liber explicitus*. Hence comes the common *explicit* written at the end of a work; and, from the analogy of *incipit liber* in titles, the word was afterwards taken for a verb, and appears in such phrases as *explicit liber, explicit, explicitæ, &c.*

The book-form was adopted from the waxen tablets, and the name *caudex* or *codex* was also taken over. It has been inferred, from the terms in which Martial speaks of vellum books, that they were articles of luxury at Rome; and, although no examples have survived from classical times, and none were found in the ruins of Herculaneum, the sumptuousness of the earliest extant volumes supports this view. The shape in which they are made up during the early centuries of the Middle Ages is the broad quarto.

The quires or gatherings of which the book was formed generally consisted, in the earliest examples, of four sheets folded to make eight leaves (*τετράς* or *τετράδιον, quaternio*), although occasionally quaterns, or quires of five sheets (ten leaves), were adopted. Sexterns, or quires of six sheets (twelve leaves), came into use at a later period. The quire-mark, or "signature," was usually written at the foot of the last page, but in some early instances (*e.g.*, the Codex Alexandrinus) it appears at the head of the first page. The numbering of the separate leaves in a quire, in the fashion followed by early printers, came in in the 14th century. Catch-words to connect the quires date back to the 12th century.

No exact system was followed in ruling the lines and in arranging the sheets when ruled. In the case of papyri it was enough to mark with the pencil the vertical marginal lines to bound the text; the grain of the papyrus was a sufficient guide for the lines of writing. With the firmer material of vellum it became necessary to rule lines to keep the writing even. These lines were at first drawn



with a hard point, almost invariably on the hair (or outer) side of the skin, and strongly enough to be in relief on the flesh (or inner) side. Marginal lines were drawn to bound the text laterally; but the ruled lines which guided the writing were not infrequently drawn right across the sheet. Each sheet should be ruled separately; but two or more sheets were often laid and ruled together, the lines being drawn with so much force that the lower sheets also received the impressions. In rare instances lines are found ruled on both sides of the leaf, as in some parts of the Codex Alexandrinus. In this same MS. and in other early codices the ruling was not always drawn for every line of writing, but was occasionally spaced so that the writing ran between the ruled lines as well as on them. In making up the quires, care was generally taken to lay the sheets in such a way that hair-side faced hair-side, and flesh-side faced flesh-side; so that, when the book was opened, the two pages before the reader had the same appearance, either the yellow tinge of the hair-side, or the fresh whiteness of the flesh-side. In Greek MSS. the arrangement of the sheets was afterwards reduced to a system: the first sheet was laid with the flesh-side downwards, so that that side began the quire; yet in so early an example as the Codex Alexandrinus the first page of a quire is the hair-side. In Latin MSS. also the hair-side appears generally to have formed the first page. Ruling with the plummet or lead-point came into ordinary use in the 12th century; red and violet inks were used for ornamental ruling in the 15th century. The lines were evenly spaced by means of prickings in the margins; in some MSS. these prickings run down the middle of the page.

Inks of various colours were employed from early times. Red is found in initial lines, titles, and colophons in the earliest vellum MSS. For purposes of contrast it was also used in glosses, as in the Lindisfarne Gospels and in the Durham Ritual. In the Carolingian period entire volumes were occasionally written with this ink. Other coloured inks—green, violet, and yellow—are also found at an early date. Writing in gold and silver was inscribed on purple vellum in ancient MSS., as has been noted above; under Charlemagne it again came into fashion. Gold was then applied to the writing of ordinary vellum MSS. It was also introduced into English MSS. in the 10th century.

With regard to writing implements, it will be here enough to note that for writing on waxen tablets the pointed *stilus* or *graphium* was used; that the reed (*κάλamos*, *calamus* or *canna*) was adapted for both papyrus and vellum, and that in Italy at least it appears to have been used as late as the 15th century; and that the quill pen can be traced back to the 6th century of our era.

#### GREEK WRITING.

The period which has to be traversed in following the history of Greek palæography begins with the 2d century B.C. and ends at the close of the 15th century. For all this long period the subject is illustrated by a fair amount of material, more or less connected in chronological sequence. Greek writing in MSS., as far as we know it from extant remains, passed through two courses,—that of the uncial or large letter, and that of the minuscule or small letter. The period of the uncial runs from the date of the earliest specimens on papyrus to the 9th century, that of the minuscule from the 9th century to the invention of printing. An established form of writing, however, cannot, any more than any other human habit, be suddenly abandoned for a new one; and we are therefore prepared to find the uncial character continue to be used after the first introduction of the smaller hand. It did in fact sur-

vive for special purposes for some three centuries after it had ceased to be the common form of book-writing. Inversely, no fully developed handwriting suddenly springs into existence; and we therefore look for the first beginnings of the minuscule hand in documents of far higher antiquity than those of the 9th century.

*Uncial.*—The term uncial has been borrowed from the nomenclature of Latin palæography<sup>1</sup> and applied to Greek writing of the larger type to distinguish it from the minuscule or smaller character. In Latin majuscule writing there exist both capitals and uncials, each class distinct. In Greek MSS. pure capital letter-writing was never employed (except occasionally for ornamental titles at a late time). As distinguished from the square capitals of inscriptions, the uncial writing has certain rounded letters, as Ε, C, ω, modifications in others, and some extending above or below the line.

Uncial Greek writing in early times is found in two forms,—the set and the cursive. In examining the set or, as it may be termed, the literary hand, we find that regard must be had to the material on which it was written. For the material has always had more or less influence on the character of the writing. To the substitution of a soft surface for a hard one, of the pen for the graving tool, we undoubtedly owe the rounded forms of the uncial letters. The square-formed capitals were more easily cut on stone or metal; the round letters more readily traced on skin or wax or papyrus with stile, reed, or pen. Again, the earliest specimens of Greek uncials are found on papyrus; and this delicate and brittle material naturally required a light style of penmanship. When the firmer material of vellum came into use, there followed a change in the style of writing, which assumed the calligraphic form, which will be considered in its place.

The earliest examples of Greek uncial writing are on papyrus, and have been discovered in Egypt and in the ruins of Herculaneum. When we turn to the literary remains with the view of following the course of the set hand, a difficulty arises at the outset; for in some of the most ancient specimens (and notably the *Εἰδόξου* referred to below) there is a fluctuation between set and cursive writing which makes it no easy matter to decide how they should be classed. In the same way, when we come to consider the first examples of cursive hand, we shall find much in them which might be termed a set cast of writing. In fact, in the period when these ancient examples were produced, the formal and cursive styles were not so distinctive as they afterwards became. For our present purpose we may class the literary works in this doubtful style of writing under the book-hand, and place the documents among the specimens of cursive.

With regard to the different dates to be assigned to these early relics, those which have been recovered from Herculaneum have a limit, after which they cannot have been written, in the year of the destruction of the city, 79 A.D. But how far before that date they may be set it is hazardous to conjecture, although the greater number probably fall within the 1st century of our era. In the case of most of the Egyptian papyri there is no such limit either way. In some instances, however, literary remains have been found in company with deeds bearing an actual date, and in two of them the documents are written on the backs of the literary papyri. The work on astronomy entitled *Εἰδόξου* *τεχνή*, among the papyri of the Louvre (*N. et Extr.*, pla. i.-x.),<sup>2</sup> is endorsed with deeds of 165 and

<sup>1</sup> St Jerome's often-quoted words, "uncialibus, ut vulgo aiunt, litteris," in his preface to the book of Job, have never been explained. Of the character referred to as "uncial" there is no doubt, but the derivation of the term is unknown.

<sup>2</sup> *Notices et Extraits des Manuscrits*, vol. xviii, Paris, 1865.

164 B.C., and may consequently be at least as old as the first half of the 2d century B.C. The writing of the text of this MS., as has been already noticed, is of a rather cursive character. But the fragments of a work on dialectics in the same collection (*N. et Extr.*, pl. xi.), which is endorsed with a deed of 160 B.C., is written in set uncials of a perfectly simple style, formed with fine and even strokes. The columns of writing lean out of the perpendicular, to the right, a peculiarity which is seen again in the orations of Hyperides (below). So far as one may venture to take this specimen as a standard whereby to judge of the age of others, a simple and fine and light stroke, without exaggeration of forms in the letters, and unrestraint in the flow of the writing seem to be the chief characteristics of this class of hand in the centuries immediately preceding the Christian era. And these characteristics are generally to be observed in all documents which there is reason to assign to this period.

Not inconsiderable fragments of the *Iliad* dating from the pre-Christian period have also come down to us. First in importance stands the fragmentary papyrus of bk. xviii., found in a tomb near Monfalat in 1849-50. It may be confidently dated as early as the 1st century B.C. The text is written in slender uncials, formed with regularity and generally upright, the inclination, if any, being to the left. This tendency to incline the letters back is a mark of age which repeats itself in the earliest forms of the set minuscule hand. Breathings and accents and various corrections have been added by a later hand in this papyrus, which is now in the British Museum (*Cat. Anc. MSS.*, i. pl. 1).<sup>1</sup> Another papyrus of a portion of the *Iliad*, on the back of which is a work of Tryphon, the grammarian, was found at the same time, but remains in private hands. Among the papyri of the Louvre are also some fragments of the *Iliad*, viz., of bk. xiii. (*N. et Extr.*, pl. xii.) and of bks. vi. and xviii. (pl. xlix.), all of a date previous to the Christian era. The fragment of bk. vi. is of particular interest as being written in a hand which is much more set and formal than is generally found in papyri, in rather narrowed letters, among which the normal form of capital A appears. In the other fragments are seen here and there accents and breathings which from all accounts are ancient, although not to be taken as the work of the first hand. Not being applied systematically, they are probably added by some teacher for instruction on particular points. But the Homeric papyrus which has hitherto had the widest reputation is that which bears the name of its former owner, Bankes, who bought it at Elephantine in 1821. It contains the greater part of the last book of the *Iliad*. The writing, however, differs very essentially from that of the other Homeric fragments just noticed. It is less free, and wants the spirit and precision of the others, and in the form of letters it approaches more nearly to the cast of those in the early MSS. on vellum. For these reasons it seems better to date this papyrus after the time of our Lord, perhaps even in the 2d century.

A fragment of papyrus containing a copy in duplicate of some lines supposed to be taken from the *Temenides* of Euripides, together with a few lines from the *Medea* and some extracts from other works, has been lately published (H. Weil, *Un Papyrus inédit de la bibl. de M. A. Firmin-Didot*, Paris, 1879). The writing is in set uncials earlier than the year 161 B.C., a document of that date having been added.

But the most important discovery hitherto made among the papyri from Egypt is that of four of the orations of the Athenian orator Hyperides, all of which are now in the British Museum. The papyrus containing the orations

for Lycophron and Euxenippus is in unusually good preservation, being 11 feet in length and having forty-nine columns of writing. Other portions of the same roll are extant, containing fragments of a third oration against Demosthenes. The writing is particularly elegant, and is evidently by a skilled penman, considerable play being exhibited in the formation of the letters, which, while still set uncials, are often linked together without raising the pen. The columns of writing incline to the right. There can be no hesitation in placing this papyrus as far back at least as the 1st century B.C. (see editions of Professor Babington, 1853; *Cat. Anc. MSS.*, pls. 2, 3; *Pal. Soc.*,<sup>2</sup> pl. 126). Of much later date, however, is the papyrus containing the funeral oration on Leosthenes, 323 B.C. The writing differs entirely from that of the other orations, being in coarsely-formed uncials, sometimes wide apart and in other places cramped together; and the forms of the letters are irregular. This irregularity is not the rough and hasty character of writing of an early age, such as that of the *Εὐδοξου ἑρμηνεία*, where, in spite of the want of regularity, it is evident that the scribe is writing a natural and practised hand. Here we have rather the ill-formed character bred of want of skill and familiarity with the style of writing. On the back is a horoscope, which has been shown to be that of a person born in 95 A.D. It was at one time assumed that this was an addition written after the oration had been inscribed on the other face of the papyrus. But from the evidence of the material itself the contrary appears to be the fact; and we may accordingly accept the theory that, as no work intended for sale would have been so written, the text of the oration probably represents a student's exercise,—a view which is also supported by the numerous faults in orthography. This specimen of writing, then, may be assigned to the 2d century of our era.

Lastly, among the discoveries in Egypt in Greek literature is the fragment of writings of the poet Alcman, now in the Louvre, which, however, appears to be not older than the 1st century B.C., the hand being light and rather sloping, and inclining in places to cursive forms. It is of interest as having scholia in a smaller hand, and a few accents and breathings added probably, as in the case of the fragment of Homer quoted above, by a teacher for the purpose of demonstration (*N. et Extr.*, pl. 1). It may be also added that some early documents are extant written in a set hand (e.g., *N. et Extr.*, pl. xvii., Nos. 12, 13).

Turning to the remains discovered at Herculaneum, it is to be regretted that there exist hardly any sufficiently trustworthy facsimiles. The so-called facsimiles engraved in the *Herculaneensis Volumina* are of no palaeographical value. They are mere lifeless representations, and only show us that the texts of the different papyri are usually written in neatly-formed and regularly-spaced uncials. The character is better shown in two autotypes (*Pal. Soc.*, pls. 151, 152) from the works of Philodemus and Metrodorus, although the blackening of the material by the action of the heated ashes threw great difficulty in the way of getting satisfactory reproductions by photography. In the first of these specimens the writing is very beautifully formed and evenly spaced, in the second it is rougher. But it is well to remember, when we have facsimiles from the Herculaneum papyri before us, that in many cases the material will have shrunk under the heat of the destroying shower, and that the writing, as we see it, may be much smaller than it was originally, and so have a more delicate appearance than when first written.

Very few waxen tablets inscribed with Greek uncial writing have survived. Two of them found at Memphis are preserved in the British Museum, and on one of them

<sup>1</sup> *Catalogue of Ancient MSS. in the British Museum—Part I., Greek.* 1881.

<sup>2</sup> Palaeographical Society, *Facsimiles*, 1872-83.

are traced some verses in large roughly-formed letters, the date of which can only be conjectured to be in the 1st century (*Verhandl. d. Philologen-Versamml. zu Würzburg*, 1869, p. 244). Another set of five tablets is in the Cabinet des Médailles at Paris, containing scribbled alphabets, and a contractor's accounts in a later and more current hand (*Rev. Archéol.*, viii. p. 461). A tablet from which the wax has worn, and which is inscribed with ink upon the wood, in characters of the 4th century, as is thought, is described in *Trans. Roy. Soc. Lit.*, 2d ser., vol. x.

With the introduction of vellum as a writing material, the uncial characters entered on a new phase. As already observed, the firmer and smoother ground offered by the surface of the vellum to the pen of the scribe would lead to a more exact and firmer style in the writing. The light touch and delicate forms so characteristic of calligraphy on papyrus gave place to a rounder and stronger hand, in which the contrast of fine hair-lines and thickened down-strokes adds so conspicuously to the beauty of the writing of early MSS. on vellum. Of such MSS., however, none have survived which are attributed to a higher antiquity than the 4th century. And here it may be remarked, with respect to the attribution to particular periods of these early examples, that we are not altogether on firm ground. Internal evidence, such, for example, as the presence of the Eusebian Canons in a MS. of the Gospel, assists us in fixing a limit of age, but when there is no such support the dating of these early MSS. must be more or less conjectural. It is not till the beginning of the 6th century that we meet with a MS. which can be approximately dated; and, taking this as a standard of comparison, we are enabled to distinguish those which undoubtedly have the appearance of greater age and to arrange them in some sort of chronological order. But these codices are too few in number to afford material in sufficient quantity for training the eye by familiarity with a variety of hands of any one period—the only method which can give entirely trustworthy results.

The earliest examples of vellum uncial MSS. are the three famous codices of the Bible. Of these, the most ancient, the Codex Vaticanus, is probably of the 4th century. The writing must, in its original condition, have been very perfect as a specimen of penmanship; but nearly the whole of the text has been traced over by a later hand, perhaps in the 10th or 11th century, and only such words or letters as were rejected as readings have been left untouched. Written in triple columns, in letters of uniform size, without enlarged initial letters to mark even the beginnings of books, the MS. has all the simplicity of extreme antiquity (*Pal. Soc.*, pl. 104). The Codex Sinaiticus (*Pal. Soc.*, pl. 105) has also the same marks of age, and is judged by its discoverer, Tischendorf, to be even more ancient than the Vatican MS. In this, however, a comparison of the writing of the two MSS. leads to the conclusion that he was wrong. The writing of the Codex Sinaiticus is not so pure as that of the other MS., and, if that is a criterion of age, the Vatican MS. holds the first place. In one particular the Codex Sinaiticus has been thought to approach in form to its possible archetype on papyrus. It is written with four columns to a page, the open book thus presenting eight columns in sequence, and recalling the long line of columns on an unfolded roll. The Codex Alexandrinus is placed in the middle of the 5th century. Here we have an advance on the style of the other two codices. The MS. is written in double columns only, and enlarged letters stand at the beginning of paragraphs. But yet the writing is generally more elegant than that of the Codex Sinaiticus. Examining these MSS. with a view to ascer-

tain the rules which guided the scribes in their work, we find simplicity and regularity the leading features; the round letters formed in symmetrical curves; ε and C, &c., finishing off in a hair-line sometimes thickened at the end into a dot; horizontal strokes fine, those of ε, Η, and O being either in the middle or high in the letter; the base of Δ and the cross-stroke of Π also fine, and, as a rule, kept within the limits of the letters and not projecting beyond. Here also may be noticed the occurrence in the Codex Alexandrinus of Coptic forms of letters (e.g., Δ, ΙΙ, alpha and mu) in the titles of books, &c., confirmatory of the tradition of the Egyptian origin of the MS.

ἸΣΚΝΩΝΣΟΥΤΤΕΡΓΑΤΩΝ  
ΤΑΣΕΝΑΛΗΘΕΙΑΚΑΘΩΣΕΝΘ  
ΛΗΝΘΑΒΟΜΕΝΑΠΟΤΟΥΠΡ

Greek Uncial (Cod. Alex.), 5th century.

(τακων σου περιτατων  
τας εν αληθεια καθως εν  
λην θαβομενα απο του π[ρ]ο[σ]τα[ς].—2 John 4.)

In the 5th century also falls the illustrated Homer of the Ambrosian Library, sadly mutilated. Some fifty fragments remain, cut out for the sake of the pictures which they contain; and all the text that is preserved is that which happened to be on the backs of these pictures. Here the writing shows differences from that of the three codices just noticed, being taller; and, to instance particular letters, the cross-stroke of ε is abnormally low down, and the shape of A and P (the latter not produced below the line) and the large bows of B are also points of difference. It has been suggested that the MS. was written in the south of Italy by a Latin scribe (*Pal. Soc.*, pls. 39, 40, 50, 51).

To the 5th century may also belong the palimpsest MS. of the Bible, known from the upper text as the Codex Ephraemi, at Paris (ed. Tischendorf, 1845), and the Octateuch, whose extant leaves are divided between Paris, Leyden, and St Petersburg—both of which MSS. are probably of Egyptian origin. Of the end of the 5th or beginning of the 6th century is the illustrated Genesis of the Cottonian Library, now unfortunately reduced to fragments by fire, but once the finest example of its kind (*Cat. Anc. MSS.*, i. pl. 8). And to about the same time belong the Dio Cassius of the Vatican (Silvestre, pl. 60) and the Pentateuch of the Bibliothèque Nationale (id., pl. 61).

In the writing of uncial MSS. of the 6th century there is a marked degeneration. The letters, though still round, are generally of a larger character, more heavily formed, and not so compactly written as in the preceding century. Horizontal strokes (e.g., in Δ, Η, Τ) are lengthened and finished off with heavy points or finials. The earliest example of this period which has to be noticed is the Dicoeoides of Vienna, which is of particular value for the study of the palæography of early vellum MSS. It is the earliest example to which an approximate date can be given. There is good evidence to show that it was written early in the 6th century for Juliana Anicia, daughter of Flavius Anicius Olybrius, emperor of the West in 472. Here we already notice the characteristics of uncial writing of the 6th century, to which reference has been made. To this century also belong the palimpsest Homer under a Syriac text, in the British Museum (*Cat. Anc. MSS.*, i. pl. 9); its companion volume, used by the same Syrian scribe, in which are fragments of St Luke's Gospel (*Ibid.*, pl. 10); the Dublin palimpsest fragments of St Matthew and Isaiah (T. K. Abbot, *Par Palimpsest. Dubl.*), written in Egypt; the fragments of the Pauline epistles from Mount Athos, some of which are at Paris and others at Moscow (Silvestre,

pls. 63, 64; Sabas, pl. A), of which, however, the writing has been disfigured by retracing at a later period; the Gospels written in silver and gold on purple vellum, whose leaves are scattered in London (Cott. MS., Titus C. xv.), Rome, Vienna, and its native home, Patmos; the fragmentary Eusebian Canons written on gilt vellum and highly ornamented, the sole remains of some sumptuous volume (*Cat. Anc. MSS.*, i. pl. 11); the Coislin Octateuch (Silvestre, pl. 65); the Genesis of Vienna, one of the very few early illustrated MSS. which have survived (*Pal. Soc.*, pl. 178). Tischendorf has given facsimiles of others, but too insufficiently for the critical study of palæography.

Reference may here be made to certain early bilingual Græco-Latin uncial MSS., written in the 6th and 7th centuries, which, however, have rather to be studied apart, or in connexion with Latin palæography; for the Greek letters of these MSS. run more or less upon the lines of the Latin forms. The best-known of these examples are the Codex Bezae of the New Testament, at Cambridge (*Pal. Soc.*, pls. 14, 15), and the Codex Claromontanus of the Pauline epistles, at Paris (*Pal. Soc.*, pls. 63, 64), attributed to the 6th century; and the Laudian MS. of the Acts of the Apostles (*Pal. Soc.*, pl. 80) of the 7th century. To these may be added the Harleian glossary (*Cat. Anc. MSS.*, i. pl. 13), also of the 7th century.

An offshoot of early Greek uncial writing on vellum is seen in the Messo-Gothic alphabet which Ulfilas constructed for the use of his countrymen, in the 4th century, mainly from the Greek letters. Of the few extant remains of Gothic MSS. the oldest and most perfect is the Codex Argenteus of the Gospels, at Upsala, of the 6th century (*Pal. Soc.*, pl. 118), written in characters which compare with purely written Greek MSS. of the same period. Other Gothic fragments appear in the sloping uncial hand seen in Greek MSS. of the 7th and following centuries.

About the year 600 Greek uncial writing passes into a new stage. We leave the period of the round and enter on that of the oval character. The letters ε, Θ, Ο, C, instead of being asymmetrically formed on the lines of a circle, are made oval; and other letters are laterally compressed into a narrow shape. In the 7th century also the writing begins to slope to the right, and accents are introduced and afterwards systematically applied. This slanting style of uncials continued in use through the 8th and 9th centuries, becoming heavier as time goes on. In this class of writing there is again the same dearth of dated MSS. as in the round uncial, to serve as standards for the assignment of dates. We have to reach the 9th century before finding a single dated MS. in this kind of writing. It is true that sloping Greek uncial writing is found in a few scattered notes and glosses in Syriac MSS. which bear actual dates in the 7th century, and they are so far useful as showing that this hand was firmly established at that time; but they do not afford sufficient material in quantity to be of really practical use for comparison (see the tables of alphabets in Gardthausen's *Griech. Pallog.*). Of more value are a few palimpsest fragments of the *Elements* of Euclid and of Gospel Lectionaries which occur also in the Syriac collection in the British Museum, and are written in the 7th and 8th centuries. There is also in the Vatican a MS. (Reg. 886) of the Theodosian code, which can be assigned with fair accuracy to the close of the 7th century (Gardth., *Gr. Pal.*, p. 158), which, however, being calligraphically written, retains some of the earlier rounder forms. This MS. may be taken as an example of transitional style. In the fragment of a mathematical treatise from Bobio, forming part of a MS. rewritten in the 8th century and assignable to the previous century, the slanting writing is fully developed. The formation

of the letters is good, and conveys the impression that the scribe was writing a hand quite natural to him.

ΠΡΩΤΑΓΓΙΛΙΑΝΤΕΣΤΕΡΕΟΥΣΧΗΛΗ  
ΠΡΟΣ ΤΗ ΜΕΤΕΩΡΩΝ ΕΥΧΕΡΕΣΤΕΡ

Greek Uncial (Mathemat. Treatise), 7th century.

(πρωτ[ο]σ] μ[α]τ[η]ματ[ων] γ[α]ρ πρωτ[ο]σ] τεωροσ] σχη[μα]τος  
προς τη μετεωρων ευχερεςτερ—)

It should be also noticed that in this MS.—a secular one—there are numerous abbreviations (Wattenbach, *Script. Gr. Specim.*,<sup>1</sup> tab. 8). An important document of this time is also the fragment of papyrus in the Imperial Library at Vienna, which bears the signatures of bishops and others to the Acts of the council of Constantinople of 680. Some of the signatures are in slanting uncials (Wattenb., *Script. Gr. Specim.*, tabb. 12, 13; Gardth., *Gr. Pal.*, tab. 1). Of the 8th century is the collection of hymns (Brit. Mus., Add. MS. 26113) written without breathings or accents (*Cat. Anc. MSS.*, i. pl. 14). To the same century belongs the Codex Marcianus, the Venetian MS. of the Old Testament, which is marked with breathings and accents. The plate reproduced from this MS. (Wattenb., *Script. Gr. Specim.*, tab. 9) contains in the second column a few lines written in round uncials, but in such a laboured style that nothing could more clearly prove the discontinuance of that form of writing as an ordinary hand. In the middle of the 9th century at length we find a MS. with a date in the Psalter of Bishop Uspensky of the year 862 (Wattenb., *Script. Gr. Specim.*, tab. 10). A little later in date is the MS. of Gregory of Nazianzus, written between 867 and 886 (Silvestre, pl. 71); and at the end of the 9th or beginning of the 10th century stands a lectionary in the Harleian collection (*Cat. Anc. MSS.*, i. pl. 17). But by this time minuscule writing was well established, and the use of the more inconvenient uncial was henceforth confined to church-service books. Owing to this limitation uncial writing now underwent a further calligraphic change. As the 10th century advances the sloping characters by degrees become more upright, and with this resumption of their old position they begin in the next century to cast off the compressed formation and again become rounder. All this is simply the result of calligraphic imitation. Service-books have always been the MSS. in particular on which finely-formed writing has been lavished; and it was but natural that, when a style of writing fell into general disuse, its continuance, where it did continue, should become more and more traditional, and a work of copying rather than of writing. In the 10th century there are a few examples bearing dates. Facsimiles from two of them, the Curzon Lectionary of 980 and the Harleian Lectionary of 995, have been printed (*Pal. Soc.*, pls. 154, 26, 27). The Bodleian commentary on the Psalter (D. 4, 1) is likewise of great palæographic value, being written partly in uncials and partly in minuscules of the middle of the 10th century (Gardth., *Gr. Pal.*, p. 159, tab. 2, col. 4). This late form of uncial writing appears to have lasted to about the middle of the 12th century. From it was formed the Slavonic writing in use at the present day.

Under the head of late uncial writing must be classed a few bilingual Græco-Latin MSS. which have survived, written in a bastard kind of uncial in the west of Europe. This writing follows, wherever the shapes of the letters permit, the formation of corresponding Latin characters,—the purely Greek forms being imitated in a clumsy fashion. Such MSS. are the Codex Angiensis of Trinity College, Cambridge, of the end of the 9th century (*Pal.*

<sup>1</sup> *Scriptura Græca Specimina*, Berlin, 1883.

See, pl. 127), and the Psalter of St Nicholas of Cusa (pl. 128) and the Codex Sangallensis and Boernerianus of the 10th century (pl. 179). The same imitative characters are used in quotations of Greek words in Latin MSS. of the same periods.

**Cursive.**—The materials for the study of early Greek cursive writing are found in papyri discovered in Egypt and now deposited in the British Museum, the Louvre, the Library of Leyden, and the Vatican. The earliest of these to which an exact date can be assigned are contained in the collection of documents of a certain Ptolemy, son of Glaukias, a Macedonian Greek, who became a recluse of the Serapeum at Memphis in 173–172 B.C., and collected or wrote these documents relating to himself and others connected with the service of the temple in the middle of the 2d century B.C. A series of these and other documents can be selected so as to give a fairly continuous course of cursive handwriting from that period for several centuries. The papyri are supplemented by the ostraka or potsherds on which were written the receipts for payment of taxes, &c., in Egypt under the Roman empire, and which have been found in large quantities. Lastly there are still extant a few specimens of Greek cursive writing on waxen tablets; and in documents of the 6th and 7th centuries from Naples and Ravenna there are found subscriptions in Latin written in Greek characters (Marini, *I papyri diplom.*, 90, 92, 121; *Cod. Dipl. Cavensis*, vol. i, No. 250).

Facsimiles of the cursively written papyri are found scattered in different works, some dealing specially with the subject. By far the most plentiful and best executed are those which reproduce the specimens preserved at Paris in the atlas accompanying *Notices et Extraits des Manuscrits*, vol. xviii.

In the earliest examples of cursive writing we find the uncial character in use, and, as has been already remarked, many of the specimens fluctuate between the more formal or set book-hand and the cursive. As time goes on the two styles diverge more widely. The uncial book-hand had, as we have seen, a disposition to become more formal; cursive writing naturally has the opposite tendency, to become more flowing and disintegrated, the more extensively it is used. But the fact that there existed in Egypt in the 2d century B.C. a cursive hand not differing very materially from a more formal contemporary hand seems to indicate that the two styles had diverged at no very long time before. It cannot, however, be supposed that a cursive form of Greek writing did not exist still earlier. The highly developed calligraphy of the earliest examples proves that Greek writing, as we there see it, was then no newly-discovered art. Judging by the analogy of later reforms, it is perhaps not going too far to conjecture that in the papyri under consideration we see the results of a calligraphic reform, in which a new model was perfected from earlier styles.

The cursive hand in its best style (e.g., *N. et Extr.*, pls. xxviii., xxix.) is very graceful and exact. This elegance is indeed characteristic of most of the writings of the 2d century B.C., and if a criterion can be established for assisting in the difficult problem of dating the early papyri, this simplicity and evenness of writing appears to be the best.

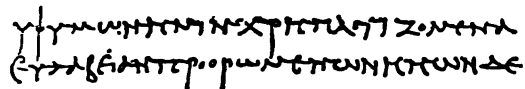

Greek Cursive, 163–162 B.C.

(ἡ ἐπιτομή τῆς χριστιανικῆς  
ἐκκλησιαστικῆς προφορᾶς τῆς 2d)

In the course of successive centuries the cursive hand

becomes slacker and more sloping. There is more combination of letters, and a continual disintegration, so to say, of the forms of the letters themselves. Naturally the letters which undergo most change are those which lend themselves most readily to combination with others. *Alpha*, for example, a letter in constant use, and appearing in frequently recurring words (as *καί*), quickly altered its shape. In the earliest papyri it is seen more cursively written than most of its fellows. *Epsilon*, again, is a letter which soon took a second form. It was found easier to make the cross-bar in conjunction with the upper half of the curve of the letter than by a separate stroke after the formation of the full curve ε̄. The upper half of the letter naturally linked itself with the next following letter; and the epsilon thus broken is found as early as a hundred years B.C., and runs through succeeding centuries. The *tau* was treated in the same way. In the specimen given above it may be seen how the scribe first made half the horizontal stroke and attached it to the main limb by one action of the pen τ, and then added the other half separately. By this device he avoided moving his hand far back. Next, to write the letter in one stroke, something like a γ, was a natural development. The transformation of *pi* follows on the same lines; and the *n*-shaped *nu* comes from the capital letter quickly written, just as the same shape was derived in the Roman alphabet. Such a form as the sickle-shaped *rho* ρ is one that would be expected; but the system of breaking-up is in no form better illustrated than in the case of *delta*. This letter, it might be thought, would, from its original shape, resist combination more than any other, yet even in the 2d century B.C. this combination is accomplished, and *delta* occasionally appears open on the right side and linked with the following letter Δ.

**Minuscule.**—The gradual disintegration of the pure forms of the early uncials by this progressive development of more cursive characters led eventually to the formation of minuscule letters. By the beginning of the 6th century most of the letters which are afterwards recognized as minuscules in form had become individually developed. For example, the three letters B, H, and K, which in their capital or uncial shapes are quite distinct, had, at this period, acquired alternative shapes which are not very dissimilar from one another, and which by a careless reader may be confused. The letter B in cursive writing lost its loops and was joined by a tag to the following letter—a process by which it became very like the Latin u. So the H readily passed through the form Π to h; and K became u. The Δ developed at the apex an elongation of the right side of the triangle, which, for junction with the next letter, was bent over, and hence resulted the small δ. The transformation of M through Μ to μ, and of N through Ν to ν, is obvious. This development, however, of minuscules from the old uncials was a work of time. The incipient changes in individual letters can be detected in papyri of the 2d and 1st centuries B.C.; but a fully developed minuscule hand, used as an independent form of writing, had no existence for some centuries to come. Arrived, however, at the end of the 6th century, we find a document of 600 A.D. given in facsimile in the *Notices et Extraits* (pl. xxiii., No. 20), the writing of which is so full of the smaller letters that the hand is practically a minuscule one. This document and six others which are extant formed part of the business papers of one Aurelius Pachymius, a dealer in purple dye, and, ranging in date from 592 to 616 A.D., are valuable material for elucidating the history of the Greek minuscule character. After an interval of eighty years another important document presents itself, in which the two styles of writing, the old uncial and the new minuscule, are seen on the same page. This is the frag-

mentary papyrus at Vienna, originally brought from Ravenna, which contains the subscriptions of bishops and others to the acts of the synod of Constantinople of 680 A.D. A facsimile was first printed by Lambecius (*Comm. de Bibl. Cæsar.*, ed. Kollar, lib. viii. p. 863), and is reproduced by Wattenbach (*Script. Gr. Specim.*, tabb. 12, 13), whose latest opinion, however, with regard to the document is, that the writing is too uniform to be the actual subscriptions, but that it is the work of a scribe imitating to some extent (and certainly so far that he has repeated the uncials and minuscules as he found them) the peculiarities of the original. This appears to be really the case, but the document being a nearly contemporary copy continues to have considerable palæographical value. An analysis of the alphabets of this papyrus and of the one of 600 A.D. cited above is given by Gardthausen (*Gr. Pal.*, taf. 4). The facsimile of the will of Abram, bishop of Harmonthis (*Pal. Soc.*, pl. 107), may also be referred to as showing the mixture of large and small letters in the 8th century; and in the single surviving specimen of Greek writing of the Imperial Chancery, containing portions of a letter addressed apparently to Pepin le Bref on the occasion of one of his wars against the Lombards in 753 or 756, appears a hand which approaches nearest to the set minuscule book-hand of the next century (Wattenb., *Script. Gr. Specim.*, tabb. 14, 15).

Arrived at this matured stage of development, the minuscule character was in a condition to pass into the regular calligraphic form of writing. In the documents quoted above, it appears generally in a cursive form, and in this form it was undoubtedly also used for literary works. An example of such book-writing in the 8th century has been given in facsimile by Gardthausen (*Beitr. zur griech. Pal.*, 1877, taf. 1). But in the 9th century the minuscule hand assumed a set form from which the writing of the succeeding centuries developed as from a new basis.

The establishment of this set hand is to be ascribed to the fact of the minuscule being now generally adopted as the recognized literary hand, in place of the larger and more inconvenient uncial, and its consequent introduction into vellum books. As we have already seen, uncial writing was influenced in the same way when applied to vellum. The firmer surface of the skin offered to the calligrapher a better working ground for the execution of his handiwork; and thus may be explained the almost sudden appearance of the beautiful and regular writing which presents itself in the minuscule MSS. of the 9th century.

Greek MSS. written in minuscules have been classed as follows:—(1) *codices vetustissimi*, of the 9th century and to the middle of the 10th century; (2) *vetusti*, from the middle of the 10th to the middle of the 13th century; (3) *recentiores*, from the middle of the 13th century to the fall of Constantinople, 1453; (4) *novelli*, all after that date.

Of dated minuscule MSS. there is a not inconsiderable number scattered among the different libraries of Europe. Gardthausen (*Gr. Pal.*, 344 sq.) gives a list of some thousand, ending at 1500 A.D. But, as might be expected, the majority belong to the later classes. Of the 9th century there are not ten which actually bear dates, and of these all but one belong to the latter half of the century. In the 10th century, however, the number rises to nearly fifty, in the 11th to more than a hundred.

In the period of *codices vetustissimi* the minuscule hand is distinguished by its simplicity and purity. The period has been well described as the classic age of minuscules. The letters are symmetrically formed; the writing is compact and upright, or has even a slight tendency to slope to the left. In a word, the beauty of this class of minuscule

writing is unsurpassed. But in addition to these general characteristics there are special distinctions which belong to it. The minuscule character is maintained intact, without intrusion of larger or uncial-formed letters. With its cessation as the ordinary literary hand the uncial character had not died out. We have seen that it was still used for liturgical books. It likewise continued to survive in a modified or half-uncial form for scholia, rubrics, titles, and special purposes—as, for example, in the Bodleian Euclid (*Pal. Soc.*, pl. 66)—in minuscule written MSS. of the 9th and 10th centuries. These uses of the older character sufficed to keep it in remembrance, and it is therefore not a matter for surprise that some of its forms should reappear and commingle with the simple minuscule. This afterwards actually took place. But in the period now under consideration, when the minuscule had been cast into a new mould, and was, so to say, in the full vigour of youth, extraneous forms were rigorously excluded.

Ἐπιτομὴ τῶν ἀριθμῶν διὰ τὴν ἑπιτομὴν  
 ὈΜΝ ἑπιτομῶν· διὰ τὴν ἑπιτομὴν διὰ τὴν ἑπιτομὴν

Greek Minuscule (Euclid), 888 A.D.

(ἐπιτομὴ ἀριθμῶν διὰ τὴν ἑπιτομὴν  
 ὈΜΝ ἑπιτομῶν· διὰ τὴν ἑπιτομὴν διὰ τὴν ἑπιτομὴν)

The breathings also of this class are rectangular, in unison with the careful and deliberate character of the writing; and there is but slight, if any, separation of the words. In addition, as far as has hitherto been observed, the letters run above, or stand upon, the ruled lines, and do not depend from them as at a later period. The exact time at which this latter mechanical change took place cannot be named; like other changes it would naturally establish itself by usage. But at least in the middle of the 10th century it seems to have been in use. In the Bodleian MS. of Basil's homilies of 953 A.D. (*Pal. Soc.*, pl. 82) the new method is followed; and if we are to accept the date of the 9th century ascribed to a MS. in the Ambrosian Library at Milan (Wattenb., *Script. Gr. Specim.*, tab. 17), in which the ruled lines run above the writing, the practice was yet earlier. Certain scribal peculiarities, however, about the MS. make us hesitate to place it so early. In the Laurentian Herodotus (W. and V., *Exempla*,<sup>1</sup> tab. 31), which belongs to the 10th century, sometimes the one, sometimes the other system is followed in different parts of the volume; and the same peculiarity happens in the MS. of Gregory of Nazianzus of 972 A.D. in the British Museum (*Pal. Soc.*, pl. 25; *Exempla*, tab. 7). The second half of the 10th century therefore appears to be a period of transition in this respect.

The earliest dated example of *codices vetustissimi* is the copy of the Gospels belonging to Bishop Uspensky, written in the year 835. A facsimile is given by Gardthausen (*Beiträge*) and repeated in the *Exempla* (tab. 1). Better specimens have been photographed from the Oxford Euclid of 888 A.D. (*Pal. Soc.*, pla. 65, 66; *Exempla*, tab. 2) and from the Oxford Plato of 895 A.D. (*Pal. Soc.*, pl. 81; *Exempla*, tab. 3). Sabas (*Specim. Palæograph.*) has also given two facsimiles from MSS. of 880 and 899. To this list may be added a facsimile of the Chronicles of Nicephorus in the British Museum, which falls within the 9th century (*Cat. Anc. MSS.*, i. pl. 15), and also one of the Aristotle of Milan, which may be of the 9th or early 10th century (*Pal. Soc.*, pl. 129; Wattenb., *Script. Gr. Specim.*, tab. 16). Of the year 905 is the *Catena on Job* at Venice (*Exempla*, tab. 4); and other facsimiles of MSS. of this class are taken

<sup>1</sup> Wattenbach and Von Velsen, *Exempla Codicum Græcorum Æt. minusc. scriptorum*, Heidelberg, 1878.



from a MS. of the Gospels in the British Museum (*Cat. Anc. MSS.*, i. pl. 16), the Ambrosian Plutarch (*Wattenb. Script. Gr. Specim.*, tab. 20), and the Ambrosian MS. of the Prophets (tab. 17), the last having, among other peculiarities, an unusual method of distinguishing the sigma at the end of a word by an added dot. These few facsimiles are all that are at present available for the purpose of studying minuscule book-writing of the first class. They are, however, all reproduced by photography, and serve sufficiently to show the character of writing which we are to look for in other, undated, examples of the same time.

After the middle of the 10th century we enter on the period of the *codices vetusti*, in which it will be seen that the writing becomes gradually less compact. The letters, so to say, open their ranks; and, from this circumstance alone, MSS. of the second half of the century may generally be distinguished from those fifty years earlier. But alterations also take place in the shapes of the letters. Side by side with the purely minuscule forms those of the uncial begin to reappear, the cause of which innovation has already been explained. These uncial forms first show themselves at the end of the line, the point at which most changes first gained a footing, but by degrees they work back into the text, and at length become recognized members of the minuscule characters. In the 11th and 12th centuries they are well established, and become more and more prominent by the large or stilted forms which they assume. The change, however, in the general character of the writing of this class of *codices vetusti* is very gradual, uniformity and evenness being well maintained, especially in church books. Among the latter, a bilingual Psalter of the year 1153, in the British Museum (*Pal. Soc.*, pl. 132), may be noted as an example of the older style of writing being adhered to at a comparatively late time. On the other hand, a lighter and more cursive kind of minuscule is found contemporaneously in MSS. of a secular nature. In this hand many of the classical MSS. of the 10th or 11th centuries are written, as the MS. of *Æschylus* and *Sophocles*, the *Odyssey* and the *Apollonius Rhodius* of the Laurentian Library at Florence, the *Anthologia Palatina* of Heidelberg and Paris, the *Hippocrates* of Venice (*Exempla*, tabb. 32-36, 38, 40), and the *Aristophanes* of Ravenna (*Wattenb. Script. Gr. Specim.*, tab. 26). In a facsimile from a Plutarch at Venice (*Exempla*, tab. 44), the scribe is seen to change from the formal to the more cursive hand. This style of writing is distinguishable by its light and graceful character from the current writing into which the minuscule degenerated at a later time. The gradual rounding of the rectangular breathings takes place in this period. In the 11th century the smooth breathing, which would most readily lend itself to this modification, first appears in the new form. In the course of the 12th century both breathings have lost the old square shape; and about the same time contractions become more numerous, having been at first confined to the end of the line. Facsimiles from several MSS. of the *codices vetusti* and the following class have been published by the Palæographical Society and by Wattenbach and Von Velsen in their *Exempla*.

When the period of *codices recentiores* commences, the

ἡ ἀλάβη ἐστὶ πρὸς ἐπίστασιν τὸν ἀλφῆν  
 ὡς ἔρα φωνήσας σφίλας ἐλλαβὴν ἀπὸ τῶν δδυσσάσας  
 ἡφιστόμου πρὸς γούνα κατὰ τὴν βουλιχίαν

Greek Minuscule (*Odyssey*), 13th century.

(ἡ ἀλάβη ἐστὶ πρὸς ἐπίστασιν τὸν ἀλφῆν  
 ὡς ἔρα φωνήσας σφίλας ἐλλαβὴν ἀπὸ τῶν δδυσσάσας  
 ἡφιστόμου πρὸς γούνα κατὰ τὴν βουλιχίαν)

Greek minuscule hand undergoes extensive changes. The

contrast between MSS. of the 13th century and those of a hundred years earlier is very marked. In the later examples the hand is generally more straggling, there is a greater number of exaggerated forms of letter, and marks of contraction and accents are dashed on more freely. There is altogether a sense of greater activity and haste.

The increasing demand for books created a larger supply. Scholars now also copied MSS. for their own use, and hence greater freedom and more variety appear in the examples of this class, together with an increasing use of ligatures and contractions. The introduction of the coarse cotton paper into Constantinople in the middle of the 13th century likewise assisted to break up the formal minuscule hand. To this rough material a rougher style of writing was suited. Through the 14th and 15th centuries the decline of the set minuscule rapidly advances. In the MSS. on cotton paper the writing becomes even more involved and intricate, marks of contraction and accents are combined with the letters in a single action of the pen, and the general result is the production of a thoroughly cursive hand. On vellum, however, the change was not so rapid. Church books were still ordinarily written on that material, which, as it became scarcer in the market (owing to the injury done to the trade by the competition of cotton paper), was supplied from ancient codices which lay ready to hand on the shelves of libraries. The result was an increasing number of palimpsests. In these vellum liturgical MSS. the more formal style of the minuscule was still maintained, and even on paper church services are found to be in the same style. In the 14th century there even appears a partial Renaissance in the writing of church MSS., modelled to some extent on the lines of the writing of the 12th century. The resemblance, however, is only superficial; for no writer can entirely disguise the character of the writing of his own time. And lastly there was yet another check upon the absolute disintegration of the minuscule in the 15th century exercised by the professional scribes who worked in Italy. Here the rag-paper, which had never made its way in the East, was the only paper in use. Its smoother surface approximated more nearly to that of vellum; and the minuscule hand as written by the Greek scribes in Italy, whether on paper or vellum, reverted again to the older style. The influence of the Renaissance is evident in many of the productions of the Italian Greeks which were written as specimens of calligraphy and served as models for the first Greek printing types.

The Greek minuscule hand had, then, by the end of the 15th century, become a cursive hand, from which the modern current hand is directly derived. We last saw the ancient cursive in use in the documents prior to the formation of the set minuscule, and no doubt it continued in use concurrently with the book-hand. But, as the latter passed through the transformations which have been traced, and gradually assumed a more current style, it may not unreasonably be supposed that it absorbed the cursive hand of the period, and with it whatever elements of the old cursive hand may have survived.

LATIN WRITING.

In writing a history of Latin palæography, it will be first necessary, as with the Greek, to follow its development in two main divisions—the set book-hand and the cursive. Under the former head will be first ranged the capital, uncial, and half-uncial hands found in early MSS.; on the other side will be traced the course of Roman cursive writing in the waxen tablets and papyri. Next will be shown how this cursive hand was gradually reduced into forms of writing peculiar to different countries on the continent of Europe (reserving for separate examination

the development of the Irish and English schools), and finally how, in the revival of learning under Charlemagne, the reformed Caroline minuscule became the standard on which the writing of all the Western nations was finally modelled.

*Capital.*—The oldest form of book-writing which we find employed in Latin MSS. is in capitals; and of these there are two kinds—the square and the rustic. Square capitals may be defined as those which have their horizontal lines at right angles with the vertical strokes; rustic letters are not less accurately formed, nor, as their title would seem to imply, are they rough in character, but, being without the exact finish of the square letters, and being more readily written, they have the appearance of greater simplicity. In capital writing the letters are not all of equal height; F and L, and in the rustic sometimes others, as B and R, overtop the rest. In the rustic the forms are generally lighter and more slender, with short horizontal strokes more or less oblique and wavy. Both styles of capital writing were obviously borrowed from the lapidary alphabets employed under the empire. But it has been observed that scribes with a natural conservatism would perpetuate a style some time longer in books than it might be used in inscriptions. We should therefore be prepared to allow for this in ascribing a date to a capital-written MS., which might resemble an inscription older by a century or more. Rustic capitals, on account of their more convenient shape, came into more general use; and the greater number of the early MSS. in capitals which have survived are consequently found to be in this character.

In the *Exempla Codicum Latinorum* of Zangemeister and Wattenbach are collected specimens of capital writing, which are supplemented by other facsimiles issued by the Palæographical Society. The earliest application of the rustic hand appears in the papyrus rolls recovered from the ruins of Herculaneum (*Exempla*, tabb. 1-3), which must necessarily be earlier than 79 A.D. In some of these specimens we see the letters written with a strong dashing stroke; in others they are mixed with cursive and uncial forms. In the vellum MSS. the writing in the earliest instances is of a perfectly exact character. MSS. of this class were no doubt always regarded as choice works. The large scale of the writing and the quantity of material required to produce a volume must have raised the cost to a height which would be within reach of only the wealthy. Such are the two famous copies of Virgil in the Vatican—the Codex Romanus, adorned with paintings, and the Codex Palatinus (*Exempla*, tabb. 11, 12; *Pal. Soc.*, pls. 113-115), which may be even as early as the 3d or 4th century, for in the regularity of their letters they resemble very nearly the inscriptions of the 1st and 2d century. There are no marks of punctuation by the first hand; nor are there enlarged initial letters.

TESTATVQVE POSITAVM SEAD P ROELIACOGI  
BISIAMI TALOS HOSTI STRAECALTEA TOIDEA

Roman Rustic Capitals (Virgil), 3d or 4th century

(Testatunqve decet iterum se ad proelia cogi  
Bis iam Italos hostis haec altera foedera)

In a third and younger MS. of Virgil, the Schedæ Vaticanæ (*Exempla*, tab. 13; *Pal. Soc.*, pls. 116, 117), the imitation of the lettering of inscriptions is far less apparent, and the writing may be said to have here settled down into a good working book hand; but, like the MSS. just noticed, this volume also was doubtless prepared for a special purpose, being adorned with well-finished paintings of classical style. In assigning dates to the earliest MSS. of capital-writing, one feels the greatest hesitation, none

of them bearing any internal evidence to assist the process. It is not indeed until the close of the 5th century that we reach firm ground,—the Medicean Virgil of Florence having in it sufficient proof of having been written before the year 494. The writing is in delicately-formed letters, rather more spaced out than in the earlier examples (*Exempla*, tab. 10; *Pal. Soc.*, pl. 86). Another ancient MS. in rustic capitals is the Codex Bembinus of Terence (*Exempla*, tabb. 8, 9; *Pal. Soc.*, pl. 135), a volume which is also of particular interest on account of its marginal annotations, written in an early form of small hand. Among palimpsests the most notable is that of the Cicero *In Verrem* of the Vatican (*Exempla*, tab. 4).

Of MSS. in square capitals the examples are not so early as those in the rustic character. Portions of a MS. of Virgil in the square letter are preserved in the Vatican, and other leaves of the same are at Berlin (*Exempla*, tab. 14). Each page, however, begins with a large coloured initial, a style of ornamentation which is never found in the very earliest MSS. The date assigned to this MS. is therefore the end of the 4th century. In very similar writing, but not quite so exact, are some fragments of another MS. of Virgil in the library of St. Gall, probably of a rather later time (*Exempla*, tab. 14a; *Pal. Soc.*, pl. 208).

In the 6th century capital-writing enters on its period of decadence, and the examples of it become imitative. Of this period is the Paris Prudentius (*Exempla*, tab. 15; *Pal. Soc.*, pls. 29, 30) in rustic letters modelled on the old pattern of early inscriptions, but with a very different result from that obtained by the early scribe. A comparison of this volume with such MSS. as the Codex Romanus and the Codex Palatinus shows the later date of the Prudentius in its widespread writing and in certain inconsistencies in forms. Of the 7th century is the Turin Sedulius (*Exempla*, tab. 16), a MS. in which uncial writing also appears—the rough and misshapen letters being evidences of the cessation of capital writing as a hand in common use. The latest imitative example of an entire MS. in rustic capitals is in the Utrecht Psalter, written in triple columns and copied, to all appearance, from an ancient example, and illustrated with pen drawings. This MS. may be assigned to the beginning of the 9th century. If there were no other internal evidence of late date in the MS., the mixture of uncial letters with the capitals would decide it. In the Psalter of St. Augustine's, Canterbury, in the Cottonian Library (*Pal. Soc.*, pl. 19; *Cat. Anc. MSS.*, ii. pls. 12, 13), some leaves at the beginning are written in this imitative style early in the 8th century; and again it is found in the Benedictional of Bishop Æthelwold (*Pal. Soc.*, pl. 143) of the 10th century. In the sumptuous MSS. of the Carolingian school it was continually used; and it survived for such purposes as titles and colophons, for some centuries, usually in a degenerate form of the rustic letters.

*Uncial.*—Uncial writing differs from the capital in adopting certain rounded forms, as α δ ε η ρ, and in having some of its letters rising above or falling below the line. The origin of the round letters may be traced in some of the Roman cursive characters as seen in the wall inscriptions of Pompeii and the waxen tablets. A calligraphic development of these alighter forms resulted in the firmly-drawn letters which are seen in the early vellum MSS. The most ancient of these may without much hesitation be assigned to the 4th century, and in them the writing is so well-established that one might well believe that it had been already practised for some generations. On the other hand, a calligraphic style may be stimulated into quick development by various causes,—caprice, fashion, or even the substitution of a different writing material, as vellum for papyrus. Uncial writing lasted as an ordinary book-

hand into the 8th century, when it was supplanted by the reformed small writing of the Carolingian school; but, like the capitals, it survived for some time longer as an ornamental hand for special purposes.

The *Exempla* of Zangemeister and Wattenbach, so often quoted above, contains a series of facsimiles which illustrate the progress of uncial writing throughout the period of its career. The letter *o* has been adopted by the editors as a test letter, in the earlier forms of which the last limb is not curved or turned in. The letter *g* also in its earlier and purer form has the cross stroke placed high. But, as in every style of writing, when once developed, the earliest examples are the best, being written with a free hand and natural stroke.

The Gospels of Vercelli (*Exempla*, tab. 20), said to have been written by the hand of Eusebius himself, and which may indeed be of his time, is one of the most ancient uncial MSS. Its narrow columns and pure forms of letters save the stamp of antiquity. To the 4th century also is assigned the palimpsest Cicero *De Republica* in the Vatican (*Exempla*, tab. 17; *Pal. Soc.*, pl. 160), a MS. written in the large characters of the best type; and a very ancient fragment of a commentary on an ante-Hieronymian text, in three columns, has also survived at Fulda (*Exempla*, tab. 21). Among the uncial MSS. of the 5th century of which good photographic facsimiles are available are the two famous codices of Livy, at Vienna and Paris (*Exempla*, tabs. 18, 19; *Pal. Soc.*, pls. 31, 32, 183), and the Gaius of Verona (*Exempla*, tab. 24). The latter MS. is also of special interest, as it contains abbreviations and has certain secondary forms amongst its letters. To distinguish between uncial MSS. of the 5th and 6th centuries is not easy, for the character of the writing changes but little, and there is no sign of weakness or wavering. It may, however, be noticed that in MSS. which are assigned to the latter century there is rather less compactness, and occasionally, as the century advances, there is a slight tendency to artificiality.

ΙΑΜΤΙΒΙΛΛΑΥΑΙΓΝΟ  
 ΡΑΝΤΙΑΣΑΕΚΛΑΡΙΣΒΟ  
 ΝΑΟΠΙΝΑΥΡΟΣΤΕΝΔΑ\*

Latin Uncial, 5th or 6th century.

(Iam tibi ille quas igno  
 rantia secularis bo  
 na opinatur ostendam)

When the 7th century is reached there is every evidence that uncial writing has entered on a new stage. The letters are more roughly and carelessly formed, and the compactness of the earlier style is altogether wanting. From this time down to the age of Charlemagne there is a continual deterioration, the writing of the 8th century being altogether misshapen. A more exact but imitative hand was, however, at the same time employed, when occasion required, for the production of calligraphic MSS., such as liturgical books. Under the encouragement given by Charlemagne to such works, splendid uncial volumes were written in ornamental style, often in gold, several of which have survived to this day (*Cat. Anc. MSS.*, ii. pp. 39-41).

*Half-Uncial.*—A very interesting style of writing, and for the study of the development of the set minuscule hand of later periods a most important one, is that to which the name of half-uncial has been given. It lies between cursive and uncial, and partakes of the character of both. As early apparently as the 4th century, a set style of small writing, partly following in formation the characters found in the Roman cursive writing of the Ravenna and other

documents on papyrus, and in some of its letters betraying an uncial origin, is found in glosses or marginal notes of early MSS. The limited space into which the annotations had to be compressed compelled the writer to abandon the free style of the ordinary cursive hand, and at the same time a mere reduction of capital or uncial letters would have been too tedious a process to adopt. A middle course was followed, and a neat minute hand, half-set half-current, was used,—just as in the present day it is no uncommon practice to write a so-called printing hand for similar purposes. The earliest example of this hand appears to be in the marginal directions for the painter in the Quedlinburg fragment of an illustrated early Italic version of the Bible (see Schum in *Theolog. Studien u. Kritiken*, 1876). In these notes appear *b, d, m, n* as fully developed minuscules; *r* is represented by *ϱ*, half way between the uncial and the minuscule, and *s* is *ʃ*. Again in the notes by the Arian bishop Maximin (*Exempla*, tab. 22), of the 5th century, the same style of writing appears,—with some variations, however, in individual letters, as in *g* and *r*, which come near to minuscule shapes. In the Codex Bezae of Terence (*Exempla*, tab. 8) there are many glosses giving ample opportunity for studying the hand, which is here in a small and well-formed character. From this specimen, and also from the notes in the Itala of Fulda (*Exempla*, tab. 21), a complete alphabet of set minuscule letters may be selected, as written probably early in the 6th century. Rather later and more uncial in form are the glosses in the Medicean Virgil (*Exempla*, tab. 10).

This set form of small writing, then, was, as it appears from the examples quoted above and from many others (see the enumeration in Wattenbach, *Einführung zur Lat. Palæog.*, p. 12), in pretty general use for the purposes of annotation; and it was but natural that it should also come to be adopted in MSS. for the text itself. The introduction into the text of uncial-written MSS., at an early date, of forms of letters borrowed from cursive writing is illustrated by the Verona Gaius (*Exempla*, tab. 24) of the 5th century, in which, besides the ordinary uncial shapes, *d* is also found as a minuscule, *r* as the transitional *ϱ*, and *s* as the tall letter *ʃ*. Again, in the Florentine Pandects of the 6th century, one of the scribes writes a hand which contains a large admixture of minuscule forms (*Exempla*, tab. 54). And some fragments of a Græco-Latin glossary on papyrus, of which facsimiles have been published (*Comment. Soc. Göttingen.*, iv., 1820, p. 166; *Rhein. Museum.*, v., 1837, p. 301), likewise contain, as secondary forms of uncial *m, r*, and *s*: *ϱ, ϱ, ʃ*. From these few instances it is seen that in uncial MSS. of a secular nature, as in works relating to law and grammar, the scribe did not feel himself restricted to a uniform use of the larger letters, as he would be in producing a church book or calligraphic MS. The adaptation then of a set small hand, very similar to, and in some particulars identical with, the annotating hand above referred to, is not surprising. The greater convenience of the small hand in comparison with the larger uncial is obvious, and the element of calligraphy which was infused into it gave it a vitality and status as a recognized book-hand. Thus we have a series of MSS., dating from the end of the 5th century, which are classed as examples of half-uncial writing, and which appear to have been written in Italy and France. The MS. of the *Fasti Consulares*, at Verona, brought down to 494 A.D. (*Exempla*, tab. 30), is in this hand, but the earliest MS. of this class to which a more approximate date can be given is the Hilary of St Peter's at Rome, which was written in or before the year 509 or 510 (*Exempla*, tab. 52; *Pal. Soc.*, pl. 136); the next is the Sulpicius Severus of Verona, of 517 A.D. (*Exempla*, tab. 32); and of the year 569 is a beautifully-written MS. at Monte Cassino containing a

Biblical commentary (*Exempla*, tab. 3). Other examples, of which good facsimiles may be consulted are the Corbie MS. of Canons, at Paris (*Exempla*, tabb. 41, 42), and the St Severianus at Milan (*Pal. Soc.*, pls. 161, 162), of the 6th century; and the Cologne MS. of Canons (*Exempla*, tab. 44), and the Josephus (*Pal. Soc.*, pl. 138) and St Ambrose (*Pal. Soc.*, pl. 137) of Milan, of the 6th or 7th century.

EPISCOPIMANUMINNOCENTE  
 ZUAMNONADFULNOQUIUMCOG  
 NATIONEMUNTERIORITENTI

Latin Half-Uncial, 509-510 A.D.

(episcopi manum innocentem) —  
 [in] linguam non ad falsiloquium coeg[ist]i —  
 nationem anterioris sententi[ae] —

The influence which this style of hand had upon the minuscule book-writing of the 7th and 8th centuries may be traced in greater or less degree in the Continental MSS. of that period. It appears at a comparatively late time with much of its old form in the Berlin MS. of Gregory's *Moralia* (Arndt, *Schrifttaf.*, 5), attributed to the 8th century. After the Caroline reform an ornamental kind of half-uncial, evidently copied from this hand, was used for particular purposes in minuscule MSS. (*Pal. Soc.*, pl. 239).

*Cursive.*—For examples of Roman cursive writing we are able to go as far back as the 1st century of the Christian era. During the excavations at Pompeii in July 1875, there was discovered in the house of L. Cæcilius Jucundus a box containing as many as one hundred and twenty-seven *libelli* or waxen tablets consisting of *per- scriptiones* and other deeds connected with sales by auction and receipts for payment of taxes (*Atti della R. Accademia dei Lincei*, ser. ii., vol. iii. pt. 3, 1875-76, pp. 150-230). Other waxen tablets, twenty-five in number, some bearing dates ranging from 131 to 167 A.D., were found in the ancient mining works in the neighbourhood of Alburnus Major (the modern Verespatak) in Dacia, at different times between 1786 and 1855. In 1840 Massmann published such as had at that time been discovered (*Libellus aurarius*); and the whole collection is given in the *Corpus Inscr. Lat.* of the Berlin Academy, vol. iii. pt. 2 (1873).

Although the waxen tablets prepared for the reception of legal instruments followed the system of the bronze diptychs on which were inscribed the privileges granted to veteran soldiers under the empire, in so far that they contained the deed witnessed and sealed, and also its duplicate copy open to inspection, yet they differed in being generally triptychs. Wood was a cheaper material than bronze, and the third tablet gave protection to the seals. These triptychs then were *libelli* of three tablets of wood, cleft from one piece and fastened together, like the leaves of a book, by strings passed through two holes pierced near the edge. In the case of the Pompeian *libelli* one side of each tablet was sunk within a frame, and the hollowed space was coated with wax, in such a way that, of the six sides or pages, Nos. 2, 3, 5, were waxen, while 1, 4, 6 presented a wooden surface. The first and sixth sides were not used, but served as the outside of the *libellus*; on 2 and 3 was inscribed the deed, and on 4 the names of the witnesses were written in ink and their seals were added in a groove cut down the centre, the deed being closed against inspection by means of a string of twisted threads which passed through two holes, one at the head and the other at the foot of the groove, round the two tablets and under the wax of the seals which thus secured it. An abstract or copy of the deed was written on the fifth page. The arrangement of the Dacian *libelli*

differed in this respect that page 4 was also waxen, and that the copy of the deed was commenced on that page in the space on the left of the groove, that on the right being reserved for the names of the witnesses. In one instance (*Corp. Inscr. Lat.*, iii. 2, p. 938) the seals and fastening threads still remain.

In these tablets some of the writing contains more capital letters, and is not so cursive as the rest; but here it is the cursive hand which has to be considered. This writing in both the Pompeian and Dacian tablets is very similar, differing only slightly in some of the letters; and both resemble the more cursive graffiti found on the walls of Pompeii.

Roman Cursive (Graffiti), 1st century.

(censio est nam noster magna habet pecuni[am]).

Roman Cursive (Dacian Tablet), 167 A.D.

(descriptum et recognitum factum ex libello— erat Alburno] maiori ad statione Reser[re] in quo scri— id quod [infra] s[criptum] est)

It is of particular importance to notice that, when examining the alphabet of this early Roman cursive hand, we find (as we found in the early Greek cursive) the first beginnings of minuscule writing. The slurring of the strokes, whereby the bows of the capital letters were lost and their more exact forms modified, led the way to the gradual development of the small letters, which, as will be afterwards seen, must have formed a distinct alphabet at an early time. With regard to the particular forms of letters employed in the waxen tablets, compare the tables in *Corp. Inscr. Lat.*, vols. iii., iv. The letter A is formed by a main stroke supporting an oblique cross-stroke above it; similarly P and R, having lost their bows, and F throwing away its bar, are formed by two strokes placed in relatively the same positions but varying in their curves. The main stroke of B dwindles to a slight curve, and the two bows are transformed into a long bent stroke so that the letter takes the shape of a stilted a or of a *z*. The D is chiefly like the uncial *o*; the E is generally represented by the old form || found in inscriptions and in the Faliscan alphabet. In the modified form of G the first outline of the flat-headed *g* of later times appears; H, by losing half its second upright limb in the haste of writing, comes near to being the small *h*. In the Pompeian tablets M has the four-stroke form |||, as in the graffiti; in the Dacian tablets it is a rustic capital, sometimes almost an uncial *m*. The hastily written O is formed by two strokes, almost like a. As to the general character of the writing, it is close and compressed, and has an inclination to the left. There is also much combination or linking together of letters (*Corp. Inscr. Lat.*, iii, tab. A). These peculiarities may, in some measure, be ascribed to the material and to the confined space at the command of the writer. The same character of cursive writing has also been found on a few tiles and potsherds inscribed with

alphabets or short sentences—the exercises of children at school (*Corp. Inscr. Lat.*, iii. p. 962).

But unfortunately material for the study of this hand fails us for some time after the period of the Dacian tablets, and whole centuries have to be passed before we find examples. At length some very interesting fragments of papyri, assigned to the 5th century, disclose the official cursive hand of the Roman chancery of that time, in which are seen the same characters, with certain differences and modifications, as are employed in the waxen tablets. They contain portions of two rescripts addressed to Egyptian officials, and are said to have been found at Philæ and Elephantina. Both documents are in the same hand; and the fragments are divided between the libraries of Paris and Leyden. For a long time the writing remained undeciphered, and Champollion-Figeac, while publishing a facsimile (*Chartes et MSS. sur papyrus*, 1840, pl. 14), had to confess that he was unable to read it. Massmann, however, with the experience gained in his work upon the waxen tablets, succeeded without much difficulty in reading the fragment at Leyden (*Libellus aurarius*, p. 147), and was followed by M. de Wailly, who published the whole of the fragments (*Mém. de l'Institut*, xv., 1842, p. 399). Later, Mommsen and Jaffé have dealt with the text of the documents (*Jahrbuch des. gem. deut. Rechts*, vi., 1863, p. 398), and compared in a table the forms of the letters with those of the Dacian tablets.

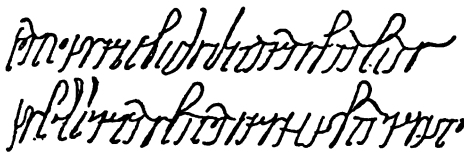

Roman Cursive (Imperial Chancery), 5th century.  
(portionem ipse debitam resarcire  
nec ullam precatorem ex instrumento)

The characters are large, the line of writing being about three-fourths of an inch deep, and the heads and tails of the long letters are flourished; but the even slope of the strokes imparts to the writing a certain uniform and graceful appearance. As to the actual shapes of the letters, as will be seen from the reduced facsimile here given, there may be recognized in many of them only a more current form of those which have been described above. The A and R may be distinguished by noticing the different angle at which the top strokes are applied; the B, to suit the requirements of the more current style, is no longer the closed *d*-shaped letter of the tablets, but is open at the bow and more nearly resembles a reversed *l*; the tall letters *f*, *k*, *l*, and long *s* have developed loops; O and *e*-shaped U are very small, and written high in the line. The letters which seem to differ essentially from those of the tablets are E, M, N. The first of these is probably explained correctly by Jaffé as a development of the earlier *ll* quickly written and looped. The M and N have been compared with the minuscule forms of the Greek *mu* and *nu*, as though the latter had been adopted; but they may with better reason be explained as cursive forms of the Latin capitals M and N.

That this hand should have retained so much of the older formation of the Roman cursive is no doubt to be attributed to the fact of its being an official style of writing which would conform to tradition. To find a more independent development we turn to the documents on papyrus from Ravenna, Naples, and other places in Italy which date from the 5th century and are written in a looser and more straggling hand. Examples of this hand will be found in largest numbers in Marini's work specially

treating of these documents (*I Papii Diplomatica*), and also in the publications of Mabillon (*De Re Diplomatica*), Champollion-Figeac (*Chartes et MSS. sur papyrus*), Massmann (*Urkunden in Neapel und Arezzo*), Gloria (*Paleografa*), as well as in *Facs. of Ancient Charters in the British Museum*, part iv., 1878, Nos. 45, 46, and in the *Facsimiles of the Palæographical Society*. The development that is found in these papyri of minuscule forms almost complete shows how great a change must have been at work during the three centuries which intervene between the date of the Dacian tablets and that of these documents; and the variety of shape which certain of them assume in combination with other letters proves that the scribes were well practised in the hand.



Roman Cursive (Ravenna), 572 A.D.  
(hulus splendidissimæ urbis)

The letter *a* has now lost all trace of the capital; it is the open *w*-shaped minuscule, developed from the looped uncial (*au*); the *b*, throwing off the loop or curve on the left which gave it the appearance of *d*, has developed one on the right, and appears in the form familiar in modern writing; minuscule *m*, *n*, and *u* are fully formed (the last never joining a following letter, and thus always distinguishable from *a*); *p*, *g*, and *r* approach to the long minuscules, and *s*, having acquired an incipient tag, has taken the form *r* which it keeps long after.

This form of writing was widely used, and was not confined to legal documents. It is found in grammatical works, as in the second hand of the palimpsest MS. of Licinianus (*Cat. Anc. MSS.*, pt. ii., pla. 1, 2) of the 6th century, and in such volumes as the Josephus of the Ambrosian Library of the 7th century (*Pal. Soc.*, pl. 59), and in the St Avitus of the 6th century and other MSS. written in France and referred to below under the head of Merovingian writing. It is indeed only natural to suppose that this, the most convenient, because cursive, hand, should have been employed for ordinary books which were in daily use. That so few of such books should have survived is no doubt owing to the destruction of the greater number by the wear and tear to which they were subjected.

NATIONAL WRITING.

Roman writing—capital, uncial, half-uncial, and cursive—became known to the Western nations, and in different ways played the principal part in the formation of the national styles of writing. In Ireland and England it was adopted under certain restrictions. On the Continent it had a wider range; and from it were constructed the three kinds of writing which in many characteristics closely resembled one another, and which, practised in Italy, Spain, and Frankland, are known by the names of Lombardic, Visigothic, and Merovingian. The basis of all three was the Roman cursive, as is very evident in the national charters which have survived; and by a certain admixture of uncial and half-uncial forms with the cursive were produced the set book-hands of those countries.

*Lombardic*.—In Italy the cursive hand of the Ravenna documents, which have been already referred to, continued in use and became more and more intricate and difficult to read. Facsimiles have been reproduced from Milanese documents of the 8th and 9th century (Sickel, *Monumenta*

*Graphica*, fasc. 1), the earlier examples, down to the middle of the 9th century, being in the large straggling character of their prototypes (see also *Cod. Dipl. Cavensis*, vol. i.; and Silvestre, i., pl. 137). The illegible scrawl into which this hand finally degenerated in notarial instruments of southern Italy was at length suppressed by order of Frederick II. (1210-50 A.D.). But at La Cava and Monte Cassino was especially cultivated the Lombardic hand, properly so called. There is much resemblance between this hand in its earlier stages and that which appears in certain MSS. written in France at the same period. Both starting from the same basis, it is not surprising that a likeness should be maintained for some time. Hence there is often no small difficulty in deciding whether a particular MS. is to be classed as Lombardic or Merovingian. If all MSS. written in the Merovingian kingdom are to be styled Merovingian, there are different styles which must be included under that title. A form of Frankish writing which is marked by a certain solidity and evenness, and thus more nearly resembles the Lombardic writing of Italy, is often classed with the latter. The Lombardic book-hand as written in Italy is seen in facsimile in *Exempla Codd. Lat.* (tabb. 29, 30), Silvestre (pl. 136), *Pal. Soc.* (pl. 92). As developed in the southern monasteries referred to above, it took, in the 9th century, a very exact and uniform shape, as seen in the Bible of La Cava (Silv., pl. 141). From this date the attention which it received as a calligraphic form of writing, accompanied with accessory ornamentation of initial letters, brought it to a high state of perfection in the 11th century, when by the peculiar treatment of the letters, they assume that strong contrast of light and heavy strokes which when exaggerated, as it finally became, received the name of broken Lombardic.

se nox est de qua scriptum est. Et  
nox ut dies illuminabitur.

Broken Lombardic Writing, 12th century.

(H)æc nox est de qua scriptum est Et  
nox ut dies illuminabitur)

This style of hand lasted to the 13th century. The fullest collection of examples is to be found in facsimile in the *Bibliotheca Casinensis* (1873, &c.). For other specimens see Silvestre, pls. 142-146, 150; Arndt, *Schrifttaf.*, 7, 32; *Pal. Soc.*, pl. 146.

*Papal Documents.*—A form of writing practised in Italy, but standing apart, is that found in papal documents. It has been erroneously named *littera Beneventana*. Specimens exist dating from the latter part of the 8th century. In the earliest examples it appears on a large scale, and has rounded forms and sweeping strokes of a very bold character. Derived from the official Roman hand, it has certain letters peculiar to itself, such as the letter *a* made almost like a Greek *ε*, *f* in the form of a loop, and *e* as a circle with a knot at the top.

This hand may be followed in examples from 788 A.D. through the 9th century (*Fac. de Chartes et Diplomes*, 1866; Gloria, *Palæog.*, tab. 22; Ch. Figeac, *Chartes et doc. sur Papyrus*, i.-xii.; Letronne, *Diplom. Meron. Etat.*, pl. 48; Silvestre, pls. 138, 139). In a bull of Silvester II., dated in 999 (*Bibl. de l'Ec. des Chartes*, vol. xxxvii.), we find the hand becoming less round; and at the end of the next century, under Urban II., in 1097 (Mabillon, *De Re Dipl.*, suppl., p. 115) and 1098 (Siökel, *Mon. Graph.*, v. 4), it is in a curious angular style, which, however, then disappears. During the 11th and 12th centuries the imperial chancery hand was also used for papal documents,

and was in turn displaced by the exact and calligraphic papal Italian hand of the later Middle Ages. The later invention of the 16th century, the so-called *littera Sancti Petri*, which seems to have been written to baffle the uninitiated, need only be referred to.

t  
dizononoparmapas filib  
huchideronow 2uathulurpruscft or

Bull of Pope John VIII. (much reduced), 876 A.D.

(Del genericis maris filib—  
hæc igitur omnia quæ hucus præcepti)

*Visigothic.*—The Visigothic writing of Spain ran a course of development not unlike that of the other national hands; and a series of photographic facsimiles lately published (*Exempla Scripturæ Visigothicæ*, 1883) enables us to mark the different periods of change. In the cursive hand attributed to the 7th century (*Ex.*, 2, 3), the Roman cursive has undergone little change in form; but another century developed a most distinctive character (*Ex.*, 4, 5). In the 8th century appears the set book-hand in an even and not difficult character, marked by breadth of style and a good firm stroke. This style is maintained through the 9th century with little change, except that there is a growing tendency to calligraphy. In the 10th century the writing deteriorates; the letters are not so uniform, and, when calligraphically written, are generally thinner in stroke. The same changes which are discernible in all the hand-writings of western Europe in the 11th century are also to be traced in the Visigothic hand,—particularly as regards the rather rigid character which it assumes. It continued in use down to the beginning of the 12th century. Perhaps the most characteristic letter of the book-hand is the *g*-shaped *g*. The following specimens illustrate the Visigothic as written in a large heavy hand of the 9th century (*Cat. Anc. MSS.*, ii., pl. 37), and in a calligraphic example of 1109 (*Pal. Soc.*, pl. 48).

arbidulcedineptoxi  
morum. tadicniat  
æoporum perfectorum.

Visigothic Minuscules, 9th century.

(tibi dulcedine proxi  
morum et dignita  
te operum perfectorum)

patrum et profetarum. et sanctorum et apostolorum  
que gamitibus et tormenta desiderii sui  
habuit usquequo fructum ex plebe sua

Visigothic Minuscules, 1109 A.D.

patrum et profetarum et sanctorum et apostolorum  
que gamitibus et tormenta desiderii sui  
habuit usquequo fructum ex plebe sua)



*Merovingian*.—The writing of the Frankish empire, to which the title of Merovingian has been applied, had a wider range than the other national hands. It had a long career both for diplomatic and literary purposes. In this writing, as it appears in documents, we see that the Roman cursive is subjected to a lateral pressure, so that the letters received a curiously cramped appearance, while the heads and tails are exaggerated to inordinate length.

diversity of writing show a development independent of the cursive hand of the Merovingian charters. It is among these MSS. that those examples already referred to occur which more nearly resemble the Lombardic type.

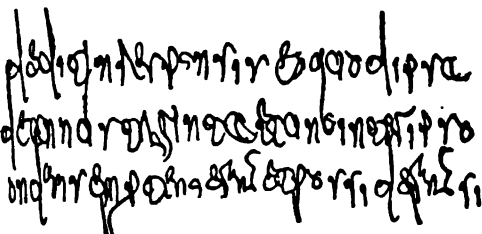

Merovingian Cursive, 679-680 A.D.

(dedit in responsis eo quod ipse—  
de annis tringinta et uno inter ipse—  
—candam semper tenuerant et possiderant at—)

Facsimiles of this hand, as used in the royal and imperial chanceries, are to be found scattered in various works; but a complete course of Merovingian diplomatic writing may be best studied in Letronne's *Diplomata*, and in the *Kaiserurkunden* of Profs. Sybel and Sickel now in course of publication. In the earliest documents, commencing in the 7th century and continuing to the middle of the 8th century, the character is large and at first not so intricate as it becomes later in this period. The writing then grows into a more regular form, and in the 9th century a small hand is established, which, however, still retains the exaggerated heads and tails of letters. The direct course of this chancery hand may then be followed in the imperial documents, which from the second half of the 9th century are written in a hand more set and evidently influenced by the Caroline minuscule. This form of writing, still accompanied by the lengthened strokes already referred to, continued in force, subject, however, to the varying changes which affected it in common with other hands, into the 12th century. Its influence was felt as well in France as in Germany and Italy; and certain of its characteristics also appear in the court-hand which the Normans brought with them into England.

The book-hand immediately derived from the early Merovingian diplomatic hand is seen in MSS. of the 7th and 8th centuries in a very neatly written but not very set hand (*Cat. Anc. MSS.*, ii, pla. 29, 30; Arndt, *Schriftst.*, 28).

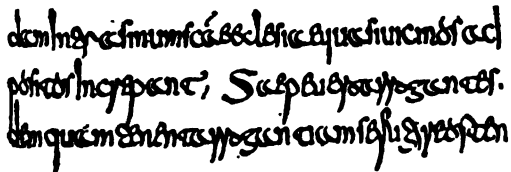

Merovingian Writing, 7th century.

(—dem intra sinum sancte ecclesie quasi uicino ad—  
positos incipient. Saepe uero arrogantes—  
—dem quam tenent arrogantiam se fugire ostent—)

But other varieties of the literary hand as written in France are seen to be more closely allied to the Roman cursive. The earliest example is found in the papyrus fragments of writings of St Avitus and St Augustine, of the 6th century (*Études paléogr. sur des Papyrus du VI<sup>e</sup> siècle*, Geneva, 1866); and other later MSS. by their

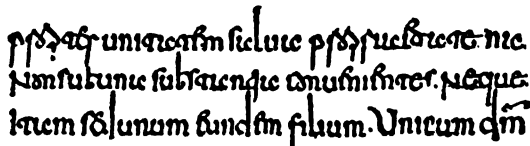

Franco-Lombardic Writing, 8th century.

(propter unitatem salua proprietate na—  
non sub una substantia conuenientes, neque—  
—itam sed unum eundem filium. Unicum dñm)

The uncial and half-uncial hands had also their influence in the evolution of these Merovingian book-hands; and the mixture of so many different forms accounts for the variety to be found in the examples of the 7th and 8th centuries. In the *Notice sur un MS. Mérovingien d'Égyptus* (1875) and the *Notice sur un MS. Mérovingien de la Bibl. d'Épinal* (1878), Delisle has given many valuable facsimiles in illustration of the different hands in these two MSS. of the early part of the 8th century. See also *Exempla Codd. Lat.* (tab. 57), and autotypes in *Cat. Anc. MSS.* ii. There was, however, through all this period a general progress towards a settled minuscule writing which only required a master-hand to fix it in a calligraphic form.

*Irish Writing*.—The early history of the palæography of the British Isles stands apart from that of the Continental schools. It is evident that the civilization and learning which accompanied the establishment of an ancient church in Ireland could not exist without a written literature. The Roman missionaries would certainly in the first place have imported copies of the Gospels and other books, and it cannot be doubted that through intercourse with England the Irish would obtain Continental MSS. in sufficient numbers to serve as models for their scribes. From geographical and political conditions, however, no continuous intimacy with foreign countries was possible; and we are consequently prepared to find a form of writing borrowed in the first instance from a foreign school, but developed under an independent national system.

In Ireland we have an instance how conservative writing may become, and how it will hand on old forms of letters from one generation to another when there is no exterior influence to act upon it. After once obtaining its models, the Irish school of writing was left to work out its own ideas, and continued to follow one direct line for centuries. The English conquest had no effect upon the national handwriting. Both peoples pursued their own course. In MSS. in the Irish language the Irish character of writing was naturally employed; and the liturgical books produced in Irish monasteries by Irish monks were written in the same way. The grants and other deeds of the English settlers were, on the other hand, drawn up by English scribes in their national writing. The Irish handwriting, then, went on in its even uninterrupted course; and its consequent unchanging form makes it so difficult a matter to assign dates to Irish MSS. A stereotyped form of letters is transmitted for so long that there is more risk of giving an early date to a late Irish MS., when written with care, than to one written, under similar conditions, in the English or Continental schools. And nowhere is it more necessary to look for the changes, slight though they be, which may indicate an advance.

The early Irish handwriting is of two classes—the round and the pointed. The round hand is found in the earliest examples; the pointed hand, which also was

developed at an early period, became the general hand of the country, and survives in the native writing of the present day. Of the earliest surviving MSS. written in Ireland none are found to be in pure uncial letters. That uncial MSS. were introduced into the country by the early missionaries can hardly be doubted, if we consider that that character was so commonly employed as a book-hand, and especially for sacred texts. Nor is it impossible that Irish scribes may have practised this hand. The copy of the Gospels in uncials, found in the tomb of St Kilian, and preserved at Würzburg, has been quoted as an instance of Irish uncial. The writing, however, is the ordinary uncial, and bears no marks of Irish nationality (*Exempla*, tab. 58). The most ancient examples are in half-uncial letters, so similar in character to the half-uncial MSS. of Italy and France, noticed above, that there can be no hesitation in deriving the Irish from the Roman writing. We have only to compare the Irish MSS. of the round type with the Continental MSS. to be convinced of the identity of their styles of writing. There are unfortunately no means of ascertaining the exact period when this style of hand was first adopted in Ireland. Among the very earliest surviving examples none bears a fixed date; and it is impossible to accept the traditional ascription of certain of them to particular saints of Ireland, as St Patrick and St Columba. Such traditions are notoriously unstable ground upon which to take up a position. But an examination of certain examples will enable the paleographer to arrive at certain conclusions. In Trinity College, Dublin, is preserved a fragmentary copy of the Gospels (*Nat. MSS. Ireland*, i., pl. ii.) vaguely assigned to a period from the 5th to the 7th century, and written in a round half-uncial hand closely resembling the Continental hand, but bearing the general impress of its Irish origin. This MS. may perhaps be of the early part of the 7th century.

adilledeinturperpondar  
lymimolaturerre lawora  
est apuennicubiculomatum

Irish Half-uncial Writing, 7th century.

(ad ille deintus respondens [dicit, No] li mihi molestus esse, iam ostendum clausum] est et pueri in cubiculo mecum [sunt])

Again, the Psalter (*Nat. MSS. Ireland*, i., pla. iii., iv.) traditionally ascribed to St Columba (ob. 597), and perhaps of the 7th century, is a calligraphic specimen of the same kind of writing. The earliest examples of the Continental half-uncial date back, as has been seen above, to the end of the 5th or beginning of the 6th century. Now the likeness between the earliest foreign and Irish MSS. forbids us to assume anything like collateral descent from a common and remote stock. Two different national hands, although derived from the same source, would not independently develop in the same way, and it may accordingly be granted that the point of contact, or the period at which the Irish scribes copied and adopted the Roman half-uncial, was not very long, comparatively, before the date of the now earliest surviving examples. This would take us back at least to the 6th century, in which period there is sufficient evidence of literary activity in Ireland. The beautiful Irish calligraphy, ornamented with designs of marvellous intricacy and brilliant colouring, which is seen in full vigour at the end of the 7th century, indicates no small amount of labour bestowed upon the cultivation of writing as an ornamental art. It is indeed surprising that such excellence was so quickly developed. The Book of Kells has been justly acknowledged as the culminating example of Irish calligraphy (*Nat. MSS. Irel.*,

i., pla. vii.-xvii.; *Pal. Soc.*, pla. 55, 56). The text is written in the large solid half-uncial hand which is again seen in the Gospels of St Chad at Lichfield (*Pal. Soc.*, pla. 20, 21, 35), and, in a smaller form, in the English-written Lindisfarne Gospels (see below). Having arrived at the calligraphic excellence just referred to, the round hand appears to have been soon afterwards superseded, for general use, by the pointed; for the character of the large half-uncial writing of the Gospels of MacDagol, of about the year 800 (*Nat. MSS. Irel.*, i., pla. xxii.-xxiv.; *Pal. Soc.*, pla. 90, 91), shows a very great deterioration from the vigorous writing of the Book of Kells, indicative of want of practice.

Traces of the existence of the pointed hand are early. It is found in a fully developed stage in the Book of Kells itself (*Pal. Soc.*, pl. 88). This form of writing, which may be termed the cursive hand of Ireland, differs in its origin from the national cursive hands of the Continent. In the latter the old Roman cursive has been shown to be the foundation. The Irish pointed hand, on the contrary, had nothing to do with the Roman cursive, but was simply a modification of the round hand, using the same forms of letters, but subjecting them to a lateral compression and drawing their limbs into points or hair-lines. As this process is found developed in the Book of Kells, its beginning may be fairly assigned to as early a time as the first half of the 7th century; but for positive date there is the same uncertainty as in regard to the first beginning of the round hand. The Book of Dimma (*Nat. MSS. Irel.*, i., pla. xviii., xix.) has been attributed to a scribe of about 650 A.D.; but it appears rather to be of the 8th century, if we may judge by the analogy of English MSS. written in a similar hand. It is not in fact until we reach the period of the Book of Armagh (*Nat. MSS. Irel.*, pla. xxv.-xxix.), a MS. containing books of the New Testament and other matter, and written by Ferdonnach, a scribe who died in the year 844, that we are on safe ground. Here is clearly a pointed hand of the early part of the 9th century, very similar to the English pointed hand of Mercian charters of the same time. The MS. of the Gospels of MacDurnan, in the Lambeth Library (*Nat. MSS. Irel.*, i., pla. xxx., xxxi.) is an example of writing of the end of the 9th or beginning of the 10th century, showing a tendency to become more narrow and cramped. But coming down to the MS. of the 11th or 12th centuries we find a change. The pointed hand by this time has become moulded into the angular and stereotyped form peculiar to Irish MSS. of the later Middle Ages. From the 12th to the 15th centuries there is a very gradual change. Indeed, a carefully written MS. of late date may very well pass for an example older by a century or more. Later forms must be detected among the fairly written characters. A book of hymns of the 11th or 12th century (*Nat. MSS. Irel.*, i., pla. xxxii.-xxxvi.) may be referred to as a good typical specimen of the Irish hand of that period; and the Gospels of Maelbrihte, of 1138 A.D. (*Nat. MSS. Irel.*, i., pla. xl.-xliii.; *Pal. Soc.*, pl. 212), as a calligraphic one.

In Irish MSS. of the later period, the ink is black, and the vellum, as a general rule, is coarse and discoloured, a defect which may be attributed to inexperience in the art of preparing the skins and to the effects of climate.

When a school of writing attained to the perfection which marked that of Ireland at an early date, so far in advance of other countries, it naturally followed that its influence should be felt beyond its own borders. How the influence of the Irish school asserted itself in England will be presently discussed. But on the Continent also Irish monks carried their civilizing power into different countries, and continued their native style of writing in the monasteries which they founded. At such centres as Luxeuil in

France, Würzburg in Germany, St Gall in Switzerland, and Bobbio in Italy, they were as busy in the production of MSS. as they had been at home. At first such MSS. were no doubt as distinctly Irish in their character as if written in Ireland itself; but, after a time, as the bonds of connexion with that country were weakened, the form of writing would become rather traditional, and lose the elasticity of a native hand. As the national styles also which were practised around them became more perfected, the writing of the Irish houses would in turn be reacted on; and it is thus that the later MSS. produced in those houses can be distinguished. Archaic forms are traditionally retained, but the spirit of the hand dies and the writing becomes merely imitative.

*English Writing.*—In England there were two sources whence a national hand could be derived. From St Columba's foundation in Iona the Irish monks established monasteries in the northern parts of Britain; and in the year 635 the Irish missionary Aidan founded the see of Lindisfarne or Holy Isle, where there was established a school of writing destined to become famous. In the south of England the Roman missionaries had also brought into the country their own style of writing direct from Rome, and taught it in the newly founded monasteries. But their writing never became a national hand. Such a MS. as the Canterbury Psalter in the Cottonian Library (*Pal. Soc.*, pl. 18) shows what could be done by English scribes in imitation of Roman uncials; and the existence of so few early charters in the same letters (*Facs. of Anc. Charters*, pt. i., Nos 1, 2, 7), among the large number which have survived, goes to prove how limited was the influence of that form of writing. On the other hand, the Irish style made progress throughout England, and was adopted as the national hand, developing in course of time certain local peculiarities, and lasting as a distinct form of writing down to the time of the Norman Conquest. But, while English scribes at first copied their Irish models with faithful exactness, they soon learned to give to their writing the stamp of a national character, and imparted to it the elegance and strength which individualized the English hand for many centuries to come.

As in Ireland so here we have to follow the course of the round hand as distinct from the pointed character. The earliest and most beautiful MS. of the former class is the Lindisfarne Gospels or "Durham Book" in the Cottonian Library (*Pal. Soc.*, pls. 3-6, 22; *Cat. Anc. MSS.*, pt. ii., pls. 8-11), said to have been written by Eadfrith, bishop of Lindisfarne, about the year 700. The text is in very exactly formed half-uncials, differing but slightly from the same characters in Irish MSS., and is glossed in the Northumbrian dialect by Aldred, a writer of the 10th century.

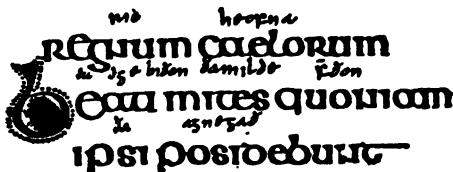

Lindisfarne Gospels, circ. 700 A.D.

(regnum caelorum. Beati mites quoniam ipsi possidebunt. sic beofna eadge bison ða milda forðon ða aegwæd.)

MSS. in the same solid half-uncial hand are still to be seen in the Chapter Library of Durham, this style of writing having been practised more especially in the north of England. But in addition to this calligraphic book-writing, there was also a lighter form of the round letters

which was used for less sumptuous MSS. or for more ordinary occasions. Specimens of this hand are found in the Durham Cassiodorus (*Pal. Soc.*, pl. 164), in the Canterbury Gospels (*Pal. Soc.*, pl. 7; *Cat. Anc. MSS.*, pt. ii., pls. 17, 18), the Epinal Glossary (*E. Eng. Text. Soc.*), and in a few charters (*Facs. Anc. Charters*, pt. i., 15; ii., 2, 3; *Pal. Soc.*, 10), one of which, of 778 A.D., written in Wessex, is interesting as showing the extension of the round hand to the southern parts of England. The examples here enumerated are of the 8th and 9th centuries,—the earlier ones being written in a free natural hand, and those of later date bearing evidence of decadence. Indeed the round hand was being rapidly displaced by the more convenient pointed hand, which was in full use in England in the middle of the 8th century. How late, however, the more calligraphic round hand could be continued under favouring circumstances is seen in the Liber Vitæ or list of benefactors of Durham (*Cat. Anc. MSS.*, pt. ii., pl. 25; *Pal. Soc.*, pl. 238), the writing of which would, from its beautiful execution, be taken for that of the 8th century, did not internal evidence prove it to be of about the year 840.

The pointed hand ran its course through the 8th, 9th, and 10th centuries, until English writing came under the influence of the foreign minuscule. The leading characteristics of this hand in the 8th century are regularity and breadth in the formation of the letters and a calligraphic contrast of heavy and light strokes—the hand being then at its best. In the 9th century there is greater lateral compression, although regularity and correct formation are maintained. But in the 10th century there are signs of decadence. New forms are introduced, and there is a disposition to be imitative. A test letter of this latter century is found in the letter *a* with obliquely cut top, *a*.

The course of the progressive changes in the pointed hand may be followed in the *Facsimiles of Ancient Charters in the British Museum* and in the *Facsimiles of Anglo-Saxon MSS.* of the Rolls Series. The charters reproduced in these works have survived in sufficient numbers to enable us not only to form a fairly accurate knowledge of the criteria of their age, but also to recognize local peculiarities of writing. The Mercian scribes appear to have been very excellent penmen, writing a very graceful hand with much delicate play in the strokes. On the other hand the writing of Wessex was heavier and more straggling, and is in such strong contrast to the Mercian hand that its examples may be easily detected with a little practice. Turning to books in which the pointed hand was employed, a very beautiful specimen, of the 8th century, is a copy of Bede's *Ecclesiastical History* in the University Library at Cambridge (*Pal. Soc.*, pl. 139, 140), which has in a marked degree that breadth of style which has been referred to. Not much later is another copy of the same work in the Cottonian Library (*Pal. Soc.*, pl. 141; *Cat. Anc. MSS.*, pt. ii., pl. 19), from which the following facsimile is taken.

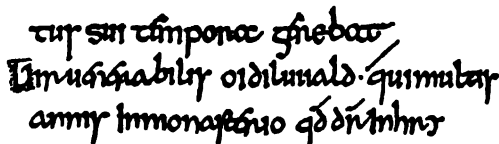

English Pointed Minuscules, 8th century.

(tunc sui tempora gereret. Vir venerabilis didimus, qui multis annis in monasterio quod dicitur Inby—)

For an example of the beginning of the 9th century, a MS. of miscellanies, of 811-814 A.D., also in the Cottonian Library, may be referred to (*Pal. Soc.*, pl. 165; *Cat. Anc.*

*MSS.*, pt. ii., pl. 24); and a very interesting *MS.* written in the *Wessex* style is the *Digby MS.* 63 of the middle of the century (*Pal. Soc.*, pl. 168). As seen in the charters, the pointed writing of the 10th century assumes generally a larger size, and is rather more artificial and calligraphic. A very beautiful example of the book-hand of this period is found in the volume known as the *Durham Ritual* (*Pal. Soc.*, pl. 240), which, owing to the care bestowed on the writing and the archaism of the style, might at first sight pass for a *MS.* of higher antiquity, were not the characteristics of its period evident in the angularity of certain letters.

In the latter part of the 10th century the foreign set minuscule hand began to make its way into England, consequent on increased intercourse with the Continent and political changes which followed. In the charters we find the foreign and native hands on the same page:—the body of the document, in Latin, in Caroline minuscules; the boundaries of the land conveyed, in the English hand. The same practice was followed in books. The charter (in book form) of King Eadgar to New Minster, Winchester, 966 A.D. (*Pal. Soc.*, pls. 46, 47), the Benedictinal of Bishop Æthelwold of Winchester (pls. 142, 144) before 984 A.D., and the *MS.* of the Office of the Cross, 1012–20 A.D. (pl. 60), also written in Winchester, are all examples of the use of the foreign minuscule for Latin. The change also which the national hand underwent at this period may certainly be attributed to this foreign influence. The pointed hand, strictly so-called, is replaced by a rounder or rather square character, with lengthened strokes above and below the line.

manan heperþm̄ maga. ꝥeapto ꝥreontaze  
 ꝥylled onpolic ꝥede beþlagen æþþe. ꝥm̄ꝥam  
 ꝥopla. onpæl ꝥoꝥe ꝥunoum ꝥorꝥunon.

English Minuscules, 11th century.

(manan he was his maga. seard ꝥreonda ge  
 ꝥylled on folcstede beþlagen æt ægga. and his suna  
 forset. on wælstowe wunoum forꝥunden.)

This style of writing becomes the ordinary English hand down to the time of the Norman Conquest. That event extinguished the national hand for official purposes—it disappears from charters; and the already established use of the Caroline minuscule in Latin *MSS.* completed its exclusion as the handwriting of the learned. It cannot, however, be doubted that it still lingered in those parts of the country where foreign influence did not at once penetrate, and that Englishmen still continued to write their own language in their own style of writing. But that the earlier distinctive national hand was soon overpowered by foreign teaching is evident in English *MSS.* of the 12th century, the writing of which is of the foreign type, although the English letter thorn, þ, survived and continued in use down to the 15th century, when it was transformed to *y*.

*The Caroline Reform.*—The revival of learning under Charlemagne naturally led to a reform in handwriting. An ordinance of the year 789 required the revision of church books; and a more correct orthography and style of writing was the consequence. The abbey of St Martin of Tours was the principal centre from whence the reformation of the book-hand spread. Here, from the year 796 to 804, Alcuin of York presided as abbot; and it was under his direction that the Caroline minuscule writing took the simple and graceful form which was gradually adopted to the exclusion of all other hands. In carrying out this reformation we may well assume that Alcuin brought to

bear the results of the training which he had received in his youth in the English school of writing, which had attained to such proficiency, and that he was also beneficially influenced by the fine examples of the Lombard school which he had seen in Italy. In the new Caroline minuscule all the uncouthness of the later Merovingian hand disappears, and the simpler forms of many of the letters found in the old Roman minuscule hand are adopted. The character of Caroline writing through the 9th and early part of the 10th century is one of general uniformity, with a contrast of light and heavy strokes, the limbs of tall letters being clubbed or thickened at the head by pressure on the pen. As to characteristic letters—the *a*, following the old type, is, in the 9th century, still frequently open, in the form of *æ*; the bows of *g* are open, the letter somewhat resembling the numeral 3; and there is no turning of the ends of letters, as *m* and *n*.

accipere marium coniugem tuam quod  
 enim ex coenobio tuo de spū scto est. Pariet  
 autem filium et uocabis nomen eius Iesum

Caroline Minuscules, 9th century.

(accipere marium coniugem tuam quod  
 enim ex coenobio tuo de spū scto est. Pariet  
 autem filium et uocabis nomen eius Iesum)

In the 10th century the clubbing of the tall letters becomes less pronounced, and the writing generally assumes, so to say, a thinner appearance. But a great change is noticeable in the writing of the 11th century. By this time the Caroline minuscule may be said to have put off its archaic form and to develop into the more modern character of small letter. It takes a more finished and accurate and more upright form, the individual letters being drawn with much exactness, and generally on a rather larger scale than before. This style continues to improve, and is reduced to a still more exact form of calligraphy in the 12th century, which for absolute beauty of writing is unsurpassed. In England especially, the writing of this century is particularly fine.

culos cū arumulis suis addeunt super  
 altare uitulū cū pelle & carnibus &  
 fimo cremat ex castra sic ꝥreparat dñs.

English Minuscules, 12th century.

(—culos cum arumulis suis addeunt super  
 altare uitulū cum pelle et carnibus et  
 fimo cremat ex castra sicut ꝥreparat dominus)

As, however, the demand for written works increased, the fine round hand of the 12th century could not be maintained. Economy of material became necessary, and a smaller hand with more frequent contractions was the result. The larger and more distinct writing of the 11th and 12th centuries is now replaced by a more cramped though still distinct hand, in which the letters are more linked together by connecting strokes, and are more laterally compressed. This style of writing is characteristic of the 13th century. But, while the book-hand of this period is a great advance upon that of a hundred years earlier, there is no tendency to a cursive style. Every letter is clearly formed, and generally on the old shapes. The particular letters which show weakness are those made of a succession of vertical strokes, as *m*, *n*, *x*. The new method of connecting these strokes, by turning the ends and running on, made the distinction of such letters

difficult, as, for example, in the word *minimi*. The ambiguity thus arising was partly obviated by the use of a small oblique stroke over the letter *i*, which, to mark the double letter, had been introduced as early as the 11th century. The dot on the letter came into fashion in the 14th century.

*Unguentum quod placet cui seruire potissimum  
debetis. Utrum diis quibus seruirent patres uestri in  
mesopotamia. An dii amorcorum in quorum terra  
habitatis. Ego autem et domus mea seruiemus domino. Respon-  
ditque populus et ait, Abest a nobis ut relinquamus dominum.)*

Minuscule Writing, 13th century.

(*Eligite hodie quod placet cui seruire potissimum  
debetis. Utrum diis quibus seruirent patres uestri in  
mesopotamia. An dii amorcorum in quorum terra  
habitatis. Ego autem et domus mea seruiemus domino. Respon-  
ditque populus et ait, Abest a nobis ut relinquamus dominum.)*

In MSS. of the 14th century minuscule writing becomes slacker, and the consistency of formation of letters falters. There is a tendency to write more cursively and without fixing the pen, as may be seen in the form of the letter *a*, of which the characteristic shape at this time is *a*, with both bows closed, in contrast with the earlier *a*. In this century, however, the hand still remains fairly stiff and upright. In the 15th century it becomes very angular and more and more cursive, but is at first kept within bounds. In the course of the century, however, it grows more slack and deformed, and the letters become continually more cursive and misshapen. An exception, however, to this disintegration of minuscule writing in the later centuries is to be observed in church books. In these the old set hand of the 12th and 13th centuries was imitated and continued to be the liturgical style of writing.

It is impossible to describe within limited space, and without the aid of illustrations, all the varieties of handwriting which were developed in the different countries of western Europe, where the Caroline minuscule was finally adopted to the exclusion of the earlier national hands. In each country, however, it acquired, in a greater or less degree, an individual national stamp which can generally be recognized and which serves to distinguish MSS. written in different localities. A broad line of distinction may be drawn between the writing of northern and southern Europe from the 12th to the 15th century. In the earlier part of this period the MSS. of England, northern France, and the Netherlands are closely connected. Indeed, in the 12th and 13th centuries it is not always easy to decide as to which of the three countries a particular MS. may belong. As a rule, perhaps, English MSS. are written with more sense of gracefulness; those of the Netherlands in darker ink. From the latter part of the 13th century, however, national character begins to assert itself more distinctly. In southern Europe the influence of the Italian school of writing is manifest in the MSS. of the south of France in the 13th and 14th centuries, and also, though later, in those of Spain. That elegant roundness of letter which the Italian scribes seem to have inherited from the bold characters of the early papal chancery, and more recently from Lombardic models, was generally adopted in the book-hand of those districts. It is especially noticeable in calligraphic specimens, as in church books,—the writing of Spanish MSS. in this style being distinguishable by the blackness of the ink. The mediæval minuscule writing of Germany stands apart. It never attained to the beauty of the hands of either the north or the south which have been just noticed; and from its ruggedness and slow development German MSS. have the appearance of being older than they really are. The writing has also very commonly a certain slope in the letters which com-

para unfavourably with the upright and elegant hands of other countries. In western Europe generally the minuscule hand thus nationalized ran its course down to the time of the invention of printing, when the so-called black letter, or set hand of the 15th century in Germany and other countries, furnished models for the types. But in Italy, with the revival of learning, a more refined taste set in in the production of MSS., and scribes went back to an earlier time in search of a better standard of writing. Hence, in the first quarter of the 15th century, MSS. written on the lines of the Italian hand of the early 12th century begin to appear, and become continually more numerous. This revived hand was brought to perfection soon after the middle of the century, just at the right moment to be adopted by the early Italian printers, and to be perpetuated by them in their types.

It must also not be forgotten that by the side of the book-hand of the later Middle Ages there was the cursive hand of every day use. This is represented in abundance in the large mass of charters and legal or domestic documents which remains. Some notice has already been taken of the development of the national cursive hands in the earliest times. From the 12th century downwards these hands settled into well-defined and distinct styles peculiar to different countries, and passed through systematic changes which can be recognized as characteristic of particular periods. But, while the cursive hand thus followed out its own course, it was still subject to the same laws of change which governed the book-hand; and the letters of the two styles did not differ at any period in their organic formation. Confining our attention to the charter hand, or court hand, practised in England, a few specimens may be taken to show the principal changes which it developed. In the 12th century the official hand which had been introduced after the Norman Conquest is characterized by exaggeration in the strokes above and below the line, a legacy of the old Roman cursive, as already noted. There is also a tendency to form the tops of tall vertical strokes, as in *b*, *h*, *l*, with a notch or cleft. The letters are well made and vigorous, though often rugged.

Charter of Stephen, 1136-39 A.D.

(*et ministris et omnibus fidelibus suis Francis et—  
Regine uxoris mee et Eustachii filii—  
mei dedi et concessi ecclesie Beate Marie)*

As the century advances, the long limbs are brought into better proportion; and early in the 13th century a very delicate fine-stroked hand comes into use, the cleaving of the tops being now a regular system, and the branches formed by the cleft falling in a curve on either side. This style remains the writing of the reigns of John and Henry III.

Charter of Henry III., 1259 A.D.

(*universis presentes litteras inspecturis salutem. Noveritis quod—  
—ford et Essexie et Constabularium Anglie et Willelmum de Fortibus  
—ad irradandum in animam nostram in presencia nostra de pace)*

Towards the latter part of the 13th century the letters grow rounder; there is generally more contrast of light and heavy strokes; and the cleft tops begin, as it were, to shed the branch on the left.

More cum pertinētis in mora que vocatur Inkalesmore continentem  
 et in longitudine per medium more illius ab uno capite  
 Abbas et Contentus aliquando tenuerunt et quam prefatus Co

Charter of Edward I., 1308 A.D.

(More cum pertinētis in mora que vocatur Inkalesmore continentem—  
 et in longitudine per medium more illius ab uno capite—  
 Abbas et Contentus aliquando tenuerunt et quam prefatus Co—)

In the 14th century the changes thus introduced make further progress, and the round letters and single-branched vertical strokes become normal through the first half of the century. Then, however, the regular formation begins to give way and angularity sets in. Thus in the reign of Richard II. we have a hand presenting a mixture of round and angular elements—the letters retain their breadth but lose their curves. Hence, by further decadence, results the angular hand of the 15th century, at first compact, but afterwards straggling and ill-formed.

And fully to be endid, payinge yerely the seid—  
 successours in hand half yere afore that is—  
 next enyngis xxiiij. s. iijij. d. by evens porcioussa.

English Charter, 1457 A.D.

(and fully to be endid, payinge yerely the seid—  
 successours in hand half yere afore that is—  
 next enyngis xxiiij. s. iijij. d. by evens porcioussa.)

*Palimpsests.*—A class of MSS. must be briefly noticed which, on account of the valuable texts which many of them have yielded, have a particular interest. These are the palimpsests. The custom of removing writing from the surface of the material on which it was inscribed, and thus preparing that surface for the reception of another text, has been practised from early times. The term palimpsest is used by Catullus, apparently with reference to papyrus; by Cicero, in a passage wherein he is evidently speaking of waxen tablets; and by Plutarch, when he narrates that Plato compared Dionysius to a βιβλίον παλιψηθον, in that his tyrant nature, being *βυβλίον*, showed itself like the imperfectly erased writing of a palimpsest MS. In this passage, reference is clearly made to the washing off of writing from papyrus. The word *παλιψηθον* can only in its first use have been applied to MSS. which were actually scraped or rubbed, and which were, therefore, composed of a material of sufficient strength to bear the process. In the first instance, then, it might be applied to waxen tablets; secondly, to vellum books. There are still to be seen, among the surviving waxen tablets, some which contain traces of an earlier writing under a fresh layer of wax. Papyrus could not be scraped or rubbed; the writing was washed from it with the sponge. This, however, could not be so thoroughly done as to leave a perfectly clean surface, and the material was accordingly only used a second time for documents of an ephemeral or common nature. To apply, therefore, the title of palimpsest to a MS. of this substance was not strictly correct; the fact that it was so applied proves that the term was in common use.

In the early period of palimpsests, vellum MSS. were also washed. The ink of the earlier centuries was easily removed with the sponge, and at the moment when this was done it may be supposed that the pages presented a clean surface. In course of time, however, by atmospheric action or other chemical causes, the original writing would to some extent reappear; and it is thus that so many of the capital and uncial palimpsests have been successfully deciphered. In the later Middle Ages the knife was used; the surface of the vellum was scraped away and the writing with it. The reading of the later examples is therefore very difficult or altogether impossible. Besides actual rasure, various recipes for effacing the writing have been found,—such as, to soften the surface with milk and meal, and then to rub with pumice. In the case of such a process being used, total obliteration must almost inevitably have been the result. To intensify the traces of the original writing, when such exist, various chemical reagents have been tried with

more or less success. The old method of smearing the vellum with tincture of gall restored the writing, but did irreparable damage by blackening the surface, and, as the stain grew darker in course of time, by rendering the text altogether illegible. Of modern reagents the most harmless appears to be hydrosulphurate of ammonia; but this also must be used with caution, and should be washed off when it has done its work.

The primary cause of the destruction of MSS. by wilful obliteration was, it need hardly be said, the dearth of material. At certain periods, from political or social changes, the market was interfered with, and production or importation failed. In the case of Greek MSS., so great was the consumption of old books, for the sake of the material, that a synodal decree of the year 691 forbade the destruction of MSS. of the Scriptures or the church fathers—imperfect or injured volumes excepted. The decline of the vellum trade also on the introduction of paper, as already noticed above, caused a scarcity which was only to be made good by recourse to material already once used. Vast destruction of the broad quartos of the early centuries of our era took place in the period which followed the fall of the Roman empire. The most valuable Latin palimpsests are accordingly found in the volumes which were remade from the 7th to the 9th centuries, a period during which the large volumes referred to must have been still fairly numerous. Late Latin palimpsests rarely yield anything of value: often the first writing precedes the later one by only a century or two; and sometimes both hands are of the same age. In the earlier examples, many of the original texts were sacrificed to make room for patristic literature or grammatical works. In many instances MSS. of the classical writers have been thus destroyed; and the sacred text itself has not always been spared. On the other hand, there are instances of classical texts being written over Biblical MSS.; but these are of late date. It has been remarked that no entire work has been found in any instance in the original text of a palimpsest, but that portions of many works have been taken to make up a single volume. These facts, however, go rather to prove, not so much that only imperfect works were put under contribution, as that scribes were indiscriminate in selection of material.

An enumeration of the different palimpsests of value is not here possible (see Wattenbach, *Schriftwesen*, pp. 252-257); but a few may be mentioned of which facsimiles are accessible. The MS. known as the Codex Ephraemi, containing portions of the Old and New Testaments in Greek, attributed to the 5th century, is covered with works of Ephraem Syrus in a hand of the 12th century (ed. Tischendorf, 1843, 1845). Among the Syriac MSS. obtained from the Nitrian desert in Egypt, and now deposited in the British Museum, some important Greek texts have been recovered. A volume containing a work of Severus of Antioch of the beginning of the 9th century is written on palimpsest leaves taken from MSS. of the *Iliad* of Homer and the Gospel of St Luke, both of the 6th century (*Cat. Anc. MSS.*, i, pl. 9, 10), and the *Elements* of Euclid of the 7th or 8th century. To the same collection belongs the double palimpsest, in which a text of St John Chrysostom, in Syriac, of the 9th or 10th century, covers a Latin grammatical treatise in a cursive hand of the 6th century, which in its turn has displaced the Latin annals of the historian Granus Licinianus, of the 5th century (*Cat. Anc. MSS.*, ii, pl. 1, 2). Among Latin palimpsests also may be noticed those which have been reproduced in the *Exempla* of Zangemeister and Wattenbach. These are—the Ambrosian Plantas, in rustic capitals, of the 4th or 5th century, re-written with portions of the Bible in the 9th century (pl. 6); the Cicero *De Republica* of the Vatican, in uncials, of the 4th century, covered by St Augustine on the Psalms, of the 7th century (pl. 17; *Pal. Soc.*, pl. 160); the Codex Theodosianus of Turin, of the 5th or 6th century (pl. 25); the *Fasti Consulares* of Verona, of 486 A.D. (pl. 29); and the Arian fragment of the Vatican, of the 5th century (pl. 31). Most of these originally belonged to the monastery of Bobbio, a fact which gives some indication of the great literary wealth of that house. The new photographic processes are particularly well adapted for the reproduction of palimpsests, for the reason that, however faint the subject, it is nearly always intensified in the negative. By using skill and judgment, with a favouring light, photography may be often made a useful agent in the decipherment of obscure palimpsest texts.

*Mechanical Arrangement of Writing in MSS.*—In the papyrus rolls the text was written in columns, generally narrow, whose length was limited by the width of the material, allowing a margin at top and bottom. In books, if the text did not extend across the page, it was usually written in two columns. A few instances, however, are known of MSS. which have more than two columns of writing in a page. Among them, the Codex Sinaiticus of the Bible has four columns, and the Codex Vaticanus three columns. In the Fulda fragment of an ancient Latin Bible (*Exempla*, 21) the arrangement is one of three columns; and a late instance of the same number occurs in a Latin Bible of the end of the 9th century in the British Museum (*Cat. Anc. MSS.*, i, pl. 45). Besides the practice of continuous writing without distinction of words, which



will be referred to more fully below, the letters towards the end of a line were, in the earliest MSS., reduced in size and cramped together, and very frequently in Latin MSS. two or more letters were linked or combined in a monogrammatic form, as *UV* (*ur, ut*). By these devices space was saved and words were less divided between two lines. Combinations survived partially in minuscule MSS. The opening lines of the main divisions of the text, as for example the different books of the Bible, were frequently written in red, for distinction. At first there was no enlargement whatever of letters in any part of the text, but still at an early period the first letter of each page was made larger than the rest. Rubrics and titles and colophons were at first written in the same character as the text; afterwards, when the admixture of different kinds of writing was allowed, capitals and uncial letters were used at discretion. In papyrus it appears to have been the practice to write the name of the work at the end only. Running titles or head-lines are found in some of the earliest Latin MSS. in the same characters as the text, but of a small size. Quotations were usually indicated by ticks or arrow-heads in the margin, serving the purpose of the modern inverted commas. Sometimes the quoted words were arranged as a sub-paragraph or indented passage. In commentaries of later date, the quotations from the work commented upon were often written in a different style from the text of the commentary itself.

In MSS., both Greek and Latin, of the earlier centuries the writing runs on continuously without breaking up into distinct words. To this system there are, however, a few partial exceptions, in some of the very earliest examples. For instance, the *Eidōgeōs* work written on papyrus in the 2d century B.C. has a certain amount of separation of words, and in the fragments of the poem on the battle of Actium which were recovered at Herculaneum the words are marked off with points, monosyllabic or short prepositions and conjunctions, however, being joined to the words which immediately follow them—a system which we find in practice at a later time. In the early vellum MSS. there is no such separation; and unless there is a pause in the sense, at which a small space may be left, the line of letters has no break whatever. In Greek MSS., indeed, a system of distinct separation of words was never thoroughly worked out, even as late as the 15th century. The continuous writing of the uncial MSS. was carried on in the minuscules; and, although, in the latter, a certain degree of separation is noticeable as early as the 10th century, yet a large proportion of words remain linked together or wrongly divided.

In the case of Latin uncial MSS., when the latter part of the 7th century is reached, there is more evidence of separation, although no regular system is followed. Concurrently the same process is observed in minuscule MSS., in which a partial separation goes on in an uncertain and hesitating manner down to the time of the Caroline reform. In early Irish and English MSS., however, it may be observed that separation is more consistently followed. In MSS. of the 9th and 10th centuries the long words are separated, but short prepositions and conjunctions are joined to the next following word. It was not until the 11th century that these smaller words were finally detached and stood apart.

**Punctuation.**—From the use of continuous writing naturally arose in the first place the necessity for the breaking up of the text into paragraphs and sentences, and afterwards the introduction of marks of punctuation. In the Greek works on papyrus before the Christian era certain marks of division are found. In the Harris Homer (*Cat. Anc. MSS.*, i., pl. 1) a wedge-shaped sign > is inserted between the beginnings of the lines to mark a new passage. In the prose works of Hyperides a pause in the sense (unless it occurs at the end of a line) is indicated by a short blank space being left in the line and by a horizontal stroke being drawn under the first letter of the line in which the pause occurs. In a few instances, in the space left to mark the pause a full point or slight oblique stroke is added high in the line. As large letters were unknown, this system of dividing the paragraphs was calculated to sacrifice the least amount of space, as the rest of the line, after the pause, was utilized for the beginning of the next paragraph. In the early vellum MSS. the same plan is followed, with the more general use of the full point, which is placed on a level with either the top or the middle of the letters; and the marginal dividing signs are of different patterns. When large letters were introduced to mark the paragraphs, had they been invariably placed at the beginning of their respective paragraphs, the latter must of necessity have each begun a new line, unless the lines had been wide enough apart to leave room for the insertion of the large letters. This latter arrangement would, however, have entailed considerable loss of space; and the device was accordingly invented, in cases where the paragraph began in the middle of a line, to place the large letter at the first letter of the next line, even though it might there occur in the middle of a word, and, as it was placed in the margin, it did not affect the normal space between the lines. It need hardly be said that, if the paragraph commenced at the beginning of a line, the large letter took its natural place as the initial. The use of these large or initial letters led to the abolition of the paragraph

marks. As early as the 5th century there is evidence in the case of the Codex Alexandrinus that the marks were losing their meaning in the eyes of the scribes; for in that MS. they are frequently placed in anomalous positions, particularly over the initial letters of the different books, having been evidently considered as mere ornaments. The position of the initial as the leading letter of the second line of a paragraph beginning in the middle of a line was maintained in the Greek minuscule MSS. into the 15th century. The practice of continuous writing also led to the arrangement of the text of the Bible and some other works in short sentences, according to the sense, which were called *στίχοι*, as will be noticed presently; but other minor methods were followed to prevent the ambiguity which would occasionally arise. In even the earliest Greek uncial MSS. an apostrophe was often inserted above the line between two words, as a dividing mark, as, for instance, in the Codex Alexandrinus, *ΟΤΝ'ΟΥΚ*; and it was specially used after words ending in *ε, χ, ξ, ρ*, and after proper names which have not a Greek termination. It was even placed, apparently from false analogy, between two consonants in the middle of a word, as *ΗΝΕΦ'ΚΕΝ*. Some of these uses of the apostrophe survived in minuscule MSS. A mark also, resembling an accent or short horizontal stroke, was employed to indicate words consisting of a single letter, as *Η*, which as a word has so many different meanings.

In the earliest surviving Latin volumes there was no punctuation by the first hand, but in the later uncial MSS. the full point, in various positions, was introduced—being placed on a level with either the bottom, middle, or top of the letters, the two latter positions being the most common. In minuscule MSS. the full point, on the line or high, was first used; then the comma and semicolon, and the inverted semicolon (!), whose power was rather stronger than that of the comma. In Irish and early English MSS. the common mark of punctuation was the full point. As a final stop one or more points with a comma *.,.* were frequently used.

**Stichometry.**—While dealing with the subject of punctuation, the system of stichometry, or division of the texts into *στίχοι, versus*, or lines of a certain length may be referred to.<sup>1</sup> It was the custom of the Greeks and Romans to estimate the length of their literary works by lines. In poetical works the number of verses was computed; in prose works a standard line had to be taken, for no two scribes would naturally write lines of the same length. This standard was a medium Homeric line, and it appears to have consisted, on an average, of 34 to 38 letters, or 15 to 16 syllables. The lines of any work, so measured, were called *στίχοι* or *ῥα*. The practice of thus computing the length of a work can be traced back to the 4th century B.C. in the boast of Theopompus that he had written more *ῥα* than any other writer. The number of such *στίχοι* or *ῥα* contained in a papyrus roll was recorded at the end with the title of the work; and at the end of a large work extending to several rolls the grand total was given. The use of such a stichometrical arrangement was in the first place for literary reference. The numeration of the *στίχοι* was no doubt at an early period regularly noted in the margin, just as lines of poetical works or verses in the Bible are numbered in our printed books. In a Greek Biblical MS. at Milan they are numbered at the end of every hundred, and the verses in the Books of Homer are counted in the same way. But the system was also of practical use in calculating the pay of the scribes and in arranging the market value of a MS. When once a standard copy of a work had been written in the normal lines, the scribes of all subsequent copies had only to record the number of *στίχοι* without keeping to the prototype. When we find therefore at the end of the different books of a Bible that they severally contain so many *στίχοι* or *versus*, it is this stichometrical arrangement which is referred to. Callimachus, when he drew up his catalogue of the Alexandrian libraries in the 3d century B.C., registered the total of the *στίχοι* in each work. Although he is generally lauded for thus carefully recording the numbers and setting an example to all who should follow him, it has been suggested that this very act was the cause of their general disappearance from MSS. For, when his *ῥα* were published, scribes evidently thought it was needless to repeat what could be found there; and thus it is that so few MSS. have descended to us which are marked in this way.

There was also in use in Biblical MSS. another arrangement. This was the division of the text into short sentences or lines, according to the sense, chiefly with a view to a better understanding of the meaning and a better delivery in public reading. The Psalms, Proverbs, and other poetical books were anciently thus written, and hence received the title of *βιβλῶς στιχθεῖαι*, or *στίχηται*; and it was on the same plan that St Jerome wrote, first the books of the prophets, and subsequently all the Bible of his version, *per cola et commata* "quod in Demosthene et Tullio solet fieri." In the Greek Testament also Euthalius, in the 5th century, introduced the method of writing *στίχηται*, as he termed it, into the Pauline and Catholic Epistles, and the Acts. The surviving MSS. which contain the text written in short sentences show by

<sup>1</sup> See the article by C. Graux in *Revue de Philologie*, 1878, vol. II. p. 97.

the diversity of the latter that the rhythmical sentences or lines of sense were differently calculated by different writers; but the original arrangement of St Jerome is thought to be represented in the Codex Amiatinus at Florence, and that of Euthalinus in the Codex Claromontanus at Paris. With regard to St Jerome's reference to the division *per cola et commata* of the rhetorical works of Demosthenes and Cicero, it should be noticed that there are still in existence MSS. of works of the latter in which the text is thus written, one of them being a volume of the *Tusculans* and the *De Senectute* in the Bibliothèque Nationale at Paris. The same arrangement of the text of the orations of Demosthenes is also mentioned by the rhetoricians of the 5th and subsequent centuries. It is a curious circumstance also that the text of the only two surviving documents of the Roman chancery addressed to Egyptian officials in the 5th century (see above) is written in lines of various lengths, apparently for rhetorical convenience.

**Corrections.**—For obliteration or removing pen strokes from the surface of the material the sponge was used in ancient times. While the writing was still fresh, the scribe could easily wash off the ink by this means; and for a fragile material, such as papyrus, he could well use no other. On vellum he might use sponge or knife. But after a MS. had left his hands it would undergo revision at the hands of a corrector, who had to deal with the text in a different manner. He could no longer conveniently apply the sponge. On hard material he might still use the knife to erase letters or words or sentences. But he could also use his pen for such purposes. Thus we find that a very early system of indicating erasure was the placing of dots or minute strokes above the letters to be thus "expunged." The same marks were also (and generally, at later periods) placed under the letters; in rare instances they stood inside them. It need scarcely be said that letters were also struck out with strokes of the pen or altered into others, and that letters and words were interlined. A long sentence, however, which could not be admitted between the lines, was entered in the margin, and its place in the text indicated by corresponding reference marks, such as *hd. ha. = hie deest, hoc supra, &c.*

**Tachygraphy.**—The systems of tachygraphy which were followed by both Greeks and Romans had an effect upon the forms of contraction found in mediæval MSS. The subject of Greek tachygraphy has lately received a good deal of attention on account of recent discoveries. How far back the practice of shorthand writing existed among the Greeks there is nothing to show; for, although certain words of Diogenes Laertius have been taken to imply that Xenophon wrote shorthand notes (*βραχυγραφία*) of the lectures of Socrates, yet a similar expression in another passage, which will not bear this meaning, renders it hardly possible that tachygraphy is referred to. The first undoubted mention of a Greek shorthand writer occurs in 195 A. D., in a letter of Flavius Philostratus. But unfortunately there appear to be no very ancient specimens of Greek tachygraphy in existence; for it is denied that certain notes and inscriptions in the papyri dating from the 2d century A. C., which have been put forward as such, are in shorthand at all. The extant examples date only from the 10th century. First stands the Paris MS. of Hermogenes, with some tachygraphic writing of that period, of which Montfaucou (*Pal. Gr.*, p. 351) gives some account, and accompanies his description with a table of forms which, as he tells us, he deciphered with incredible labour. Next, the Add. MS. 18291 in the British Museum contains some marginal notes in shorthand, of 972 A. D. (Wattenb., *Script. Græc. Specim.*, tab. 19). But the largest amount of material is found in the Vatican MS. 1809, a volume in which as many as forty-seven pages are covered with tachygraphic writing of the 11th century. Mai first published a specimen of it in his *Scriptorum Veterum Nova Collectio*, vol. vi. (1832); and in his *Novæ Patrum Bibliothecæ tom. secundus* (1844) he gave a second, which, in the form of a marginal note, contained a fragment of the book of Enoch. But he did not quote the number of the MS., and it has only lately been found again. The tachygraphic portion of it is now being made the subject of special study by Dr Gittlbauer for the Vienna Academy. It contains fragments of the works of St Maximus the Confessor, the confession of St Cypryan of Antioch, and works of the pseudo-Dionysius Areopagita. The writing used in these examples is syllabic, and appears to be a younger form of tachygraphy as distinguished from an older system, the existence of which may be inferred from the occurrence of certain signs or symbols of contraction used in the minuscule MSS. For, while many of the signs thus used correspond with the tachygraphic signs of the above examples, there are others which differ and which have been derived from an earlier source. For a system of tachygraphic contractions had been developing at an earlier period; and its elements have been traced in both curvæ and uncial MSS. as far back as the 5th or 6th century. If then we may suppose that the new system of tachygraphy was an invention of the 9th or 10th century, this will account for the occurrence in MSS. of that period of two forms of abbreviation for certain syllables—the one adopted from the old or ordinary system, and the other being the neo-stenographic symbol. As to the first origin of Greek tachygraphy, it has been supposed that it grew from a system

of secret writing which was developed from forms of abbreviation, and which the early Christians adopted for their own use.

Evidence of the use of tachygraphy among the Romans is to be found in the writings of authors under the empire. It appears to have been taught in schools, and, among others, the emperor Titus is said to have been skilful in this style of writing. Ennius has been named as the inventor of a large collection of shorthand symbols; but more generally Cicero's freedman M. Tullius Tiro is regarded as the author of these signs, which commonly bear the title of "Notæ Tironianæ." The shorthand writers or notaries were well trained in the use of these notes, and in the early Christian times were largely employed in taking down the words of the bishops of the church which were preached in sermons or spoken in councils, and in recording the acts and lives of martyrs. In the Frankish empire the notes were used in signatures or subscriptions of charters, and later, in the 9th and early 10th centuries, they were adopted by the revisers and annotators of the texts of MSS. Of this period also are several MSS. containing the *Præter* in these characters, which it has been suggested were written for practice at a time when a fresh impulse had been given to the use of shorthand in the service of literature. The existence also of volumes containing collections of the Tironian notes, and written at this time, points to a temporary revival. The notes appear to have gone out of general use, however, almost immediately after this, although in isolated cases, such as in subscriptions to charters, they linger as late as the beginning of the 11th century. A few of the forms of the Tironian notes were adopted in mediæval MSS. as symbols of contraction for certain common words, as will be noticed presently.

**Contractions.**—The use of contractions or abbreviations in MSS. would arise from two causes—first, the natural desire to write as quickly and shortly as possible words of frequent occurrence which could not be misread in a contracted form, and, secondly, the necessity of saving space. The contractions satisfying the first requirement were necessarily limited in number and simple in character, and are such as are found with more or less frequency in the oldest MSS. But the regular system of contracted forms, with the view of getting as much writing as possible into a limited space, was only elaborated in course of time, and was in use in the later centuries of the Middle Ages. Different kinds of literature also were, according to their nature, more or less contracted. From early times abbreviations were used more freely in secular books, and particularly in works in which technical language was employed, such as those on law or grammar or mathematics, than in Biblical MSS. or liturgies. In the Greek fragment of a mathematical treatise of the 7th century, at Milan, there are numerous contractions; and the same is found to be the case in a Latin MS. of the 5th century, the Verona Gaius. With regard to the different systems or styles of contraction, the oldest and simplest is that in which a single letter, or at most two or three letters, represent a whole word. Among Latin classical writers we know that these contractions were common enough, and ancient inscriptions afford plentiful examples. In the waxen tablets also they are found; and they survive in the later papyri of Ravenna, &c., and in law deeds. Next is the system of dropping the final syllable or syllables of a word, or of omitting a letter or syllable or more in the middle,—such omissions being easily supplied from the general sense of the context—*e. g.*  $\sigma\chi\mu$  =  $\sigma\chi\mu\alpha\tau\omicron\varsigma$ ,  $\eta\alpha\beta\upsilon\epsilon$  =  $\eta\alpha\beta\upsilon\epsilon\upsilon\tau\omicron\varsigma$ ,  $\pi\tau\epsilon\mu$  =  $\pi\alpha\tau\epsilon\mu$ . And lastly, there are the arbitrary signs and contractions formed in a special manner or marked by certain figures whereby they may be regularly interpreted.

Traces of a system of contraction are found in some of the early Greek papyri. For example, in the papyrus of the oration of Hyperides for Lycophron, of at least the 1st century A. C., the  $\alpha\epsilon$  of the syllable  $\alpha\epsilon$ , when occurring at the end of a line, is omitted, and its omission marked by a light horizontal stroke above the line of writing; and, as marks of reference to an accidentally omitted line, abbreviated forms of  $\epsilon\upsilon\alpha$  and  $\epsilon\delta\tau\epsilon$  are used. In the Banks Homer also the sign  $\overline{\omega}$  for  $\omega\alpha\iota\eta\eta\iota\varsigma$  is placed in the margin to mark the narrative portion of the text. In the ancient Greek Biblical MSS. the contractions are usually confined to the sacred names and titles, and a few words of common occurrence, as  $\Theta\text{C}$  =  $\theta\epsilon\delta\varsigma$ ,  $\text{IC}$  =  $\text{I}\eta\sigma\upsilon\varsigma$ ,  $\text{XC}$  =  $\chi\text{ρισ}\tau\omicron\varsigma$ ,  $\text{IINA}$  =  $\text{I}\eta\upsilon\delta\epsilon\mu$ ,  $\text{CHP}$  =  $\text{c}\alpha\tau\eta\rho$ ,  $\text{EC}$  =  $\text{e}\delta\text{p}\iota\omicron\varsigma$ ,  $\text{CTPOC}$  =  $\text{c}\tau\alpha\upsilon\tau\omicron\varsigma$ ,  $\text{PHP}$  =  $\text{p}\alpha\tau\eta\rho$ ,  $\text{MHP}$  =  $\text{m}\eta\tau\eta\rho$ ,  $\text{TC}$  =  $\text{t}\epsilon\iota\varsigma$ ,  $\text{ANOC}$  =  $\text{a}\nu\theta\omega\pi\omicron\varsigma$ ,  $\text{OTNOC}$  =  $\text{o}\upsilon\tau\alpha\upsilon\tau\omicron\varsigma$ ,  $\text{K}$  =  $\text{k}\alpha\iota$ ,  $\text{T}$  =  $\text{t}\alpha\iota$ ,  $\text{M}$  =  $\text{m}\omicron\upsilon$ ,  $\text{P}$ , &c. Final  $\text{N}$ , especially at the end of a line, was dropped, and its place occupied by the horizontal stroke, as  $\text{TO}$ . This limited system of contraction was observed generally in the uncial Biblical and liturgical MSS. In the mathematical fragment at Milan abbreviations by dropping final syllables, and contracted particles and prepositions, are numerous; and in the palimpsest Homer of the 6th century in the British Museum final syllables are occasionally omitted. Such omissions were, however, indicated by strokes or curves, or by some leading letter of the omitted portion being placed above the line of writing. Certain signs also were borrowed from tachygraphy, at first sparingly, but afterwards, in the later and

more elaborate system of contraction, in sufficient numbers to represent certain common words and terminations.

In the early Greek minuscule MSS. contractions are not very frequent in the texts; but in the marginal glosses, where it was an object to save space, they are found in great numbers as early as the 10th century. The MS. of Nonna, of 972 A.D., in the British Museum (Wattenb. and Von Vels., *Exempla*, 7) is an instance of a text contracted to a degree that almost amounts to tachygraphy. In secular MSS. contractions developed most quickly. In the 12th, 13th, and 14th centuries texts were fully contracted; and as the writing became more cursive contraction-marks were more carefully applied, until, in the 15th century, they degenerated into mere flourishes.

In Latin Biblical uncial MSS. the same restrictions on abbreviations were exercised as in the Greek. The sacred names and titles *DS*—*deus*, *DMS*, *DNS*—*dominus*, *SCS*—*sacrus*, *SPS*—*spiritus*, and others appear in the oldest codices. The contracted terminations *Q*—*que*, *B*—*bus*, and the omission of final *m*, or (more rarely) final *n*, are common to all Latin MSS. of the earliest period. There is a peculiarity about the contracted form of our Saviour's name that it is always written by the Latin scribes in letters imitating the Greek *IHC*, *XPC*, *etc.* In secular works, as already noticed, contractions were used in many forms at an early period. In minuscule MSS. of the 8th, 9th, and 10th centuries the system of dropping middle or final syllables was commonly applied. In this stage the simpler marks of contraction, such as a horizontal stroke or an apostrophe to mark the omitted termination, were generally used. Certain ordinary words also, as prepositions and conjunctions, and a few prefixes and terminations, had particular forms of contraction from an early date. Such are *ē*—*est*, *ī*—*in*, *ī*—*non*, *p*—*per*, *p*—*pro*, *ū*—*terminatio* *us*. The letter *q* with distinctive strokes applied in different positions represented the often recurring relative and other short words, as *quod*, *quia*. Conventional signs also derived from the Thronian signs were employed, particular in Irish and English MSS., as *ī*—*idem*, *÷*—*est*, *p*—*quasi*, *H*—*enim*, *7*—*et*. From the practice of writing above the line a leading letter of an omitted syllable, as *ī*—*infra*, *t*—*ter*, other conventional signs were also developed. Such growths are well illustrated in the change undergone by the semicolon, which was attached to the end of a word to indicate the omission of the termination, as *b*—*bus*, *q*—*que*, *et*—*debet*, and which in course of time became converted into *;*, a form which survives in our ordinary abbreviation *viz* (*i. e.*, *videlicet*). The different forms of contraction which have been noticed were common to all the nations of western Europe. The Spanish scribes, however, attached different values to certain of them. For example, in Visigothic MSS. *qu*, which elsewhere represented *quoniam*, may be read as *quum*; and *p*, which elsewhere—*per*, is here—*per*.

By the 11th century the system of Latin contractions had been reduced to exact rules; and from this time onwards it was universally practised. It reached its culminating point in the 13th century, the period of increasing demand for MSS., when it became more than ever necessary to economize space. After this date the contraction of the signs of contraction was less strictly observed, and the system deteriorated together with the decline of handwriting. In conclusion, it may be noticed that in MSS. written in the vernacular tongues contractions are more rarely used than in Latin texts. A system suited to the inflexions and terminations of this language could not be readily adapted to other languages so different in grammatical structure.

**Breathings and Accents.**—These were not systematically applied to the texts of Greek MSS. before the 7th century. Such as are found in isolated passages in the ancient papyri do not appear to have been written by the first hand, and most of them are probably of much later date. They have been freely added to the ancient texts of Homer, as in the Harris and Banke's papyri, but palpably long after the dates of the writing. Nor were they used in the early uncial MSS. The ancient codices of the Bible are devoid of them; and, although in the Ambrosian Homer of the 5th century it is thought that some of the breathings may be by the original hand, the other marks of breathing and the accents are of later date. So likewise the few breathings and accents which are seen

in the palimpsest Homer of the 6th century in the British Museum have been, to all appearance, added afterwards. In Latin texts, and particularly in early Irish and English MSS., an accent is occasionally found over a monosyllabic word or one consisting of a single letter. But such accentuation, serving to distinguish such small words in reading, rather corresponds to the similar marking of short words in Greek MSS., as noticed above.

**Numerals.**—An examination of the different forms of numerals to be found in Greek and Latin MSS. is beyond the province of this article. It may, however, be pointed out that, while in Greek MSS. one system was followed, in Latin MSS. both the Roman and Arabic numerals were in use. The Roman numerals appear in all kinds of documents at all times. When occurring in the text of a MS. they were usually placed between full points, *e.g.*, *cxliiii.*, to prevent confusion with the letters of the words. Arabic numerals were established in common use by the end of the 14th century, but their occurrence in MSS. has been traced back to the middle of the 12th century, from which date down to the time of their general adoption they were principally confined to mathematical works.

**Bibliography.**—GREEK PALEOGRAPHY.—The first book which dealt with the subject in a systematic manner was the *Palaeographia Græca* of the learned Besseline, Dom Bernard de Montfaucon, published in 1708. So thoroughly well was the work done that down to our own time no other scholar attempted to improve upon it, and Montfaucon remained the undisputed authority in this branch of learning. At length, in 1879, Gardthausen published his *Græcische Palæographie*, in which is embodied fuller information than was available in Montfaucon's day. In this work the development of Greek writing in its various styles is carefully and lucidly worked out and illustrated with tables, and a useful list of dated Greek MSS. is added. See also a review of Gardthausen's work by Charles Grand in the *Journal des Savants* (1881). A most useful and handy introduction to Wattenbach's *Anleitung zur Græcischen Palæographie* (3d ed., 1877), in which will be found references to all the most important MSS. With regard to facsimiles, those which are found in Montfaucon and other books of the same time are practically useless for critical purposes. The invention of photography has entirely driven into the background all hand-made facsimiles, and in the future none will be admissible which are not produced by the action of light. Autotypes or photo-lithographs from MSS. are given in the *Facsimiles of the Palaeographical Society* (1873-83); in the *Exempla Græcæ Antiquæ* (1874), *minuscule scriptorum* of Wattenbach and Von Vels. in the *Catalogue of Ancient MSS. in the British Museum*, part I. (1881); in Wattenbach's *Scriptura Græca Specimina* (1883); and, in fewer numbers, in *Specimina Palaeographica codd. Græc. et Slav. bibl. Mosquensis* (1862-64) by Bishop Sabas. Facsimiles made by hand, but excellently finished, are in Silvestre's *Palaeographie Universelle* (1850) and in *Notices et Extraits des Manuscrits*, tom. xviii., pt. 2 (1865), where the papyri of Paris are faithfully represented.

LATIN PALEOGRAPHY.—The bibliography of Latin palaeography in its different branches is very extensive, but there are comparatively few books which deal with it as a whole. The most complete work is due to the Benedictines, who in 1750-65 produced the *Nouveau Traité de Diplomatique*, which examines the remains of Latin writing in a most exhaustive manner. The fault of the work lies indeed in its diffuseness and in the superabundance of subdivisions which tend to confuse the reader. The extensive use, however, which the authors made of the French libraries renders their work most valuable for reference. As their title shows, they did not confine themselves to the study of MS. volumes, but dealt also with that other branch of palaeography, the study of documents, in which they had been preceded by Mabillon in his *De Re Diplomatice* (1709). Wattenbach's *Anleitung zur Lateinischen Palæographie*, 3d ed., 1878, is a thoroughly practical introduction, classifying the different kinds of writing, and giving full biographical references, and tracing the forms of letters and the history of contractions, &c. Works which give facsimiles in general are—Silvestre, *Palaeographie Universelle*; the *Facsimiles of the Palaeographical Society*; Arndt, *Schrifttafeln*, 1874, 1878; the *Catalogue of Ancient MSS. in the British Museum*, part II., 1884; and among those which deal with particular branches of Latin palaeography the following may be enumerated:—*Exempla Codicum Latine et Græcæ Antiquæ scripturæ* (1876, 1879) by Zangemeister and Wattenbach; on Roman cursive, and on Lombardic, Merovingian, and Visigothic writing, the *Corpus Inscriptionum Latinarum*, vols. III., IV.; Massmann, *Libellus aurarius*, 1840; Martin, *Papiri Diplomatice*, 1805; the *Chartæ Latines sur Papyrus* (1635-40) of Champollion-Figeac; Gloria, *Palaeographia*, 1870; Sieckel, *Monumenta Græcæque*, 1858-69; Letronne, *Diplomata et Chartæ Merovingicæ et Altit*, 1848; "Facsimile des Chartes et Diplomes," in the *Archives de l'Empire*, 1866; Sybel and Sieckel, *Kaiserurkunden*, 1880-84; *Bibliotheca Cassinensis*, 1878, &c.; Merino, *Exempla Palaeographica*, 1780; and the *Exempla Scripturæ Visigothicæ* (1883) of Ewald and Loewe. On Irish and English writing—Ashe, *Origin and Progress of Writing*, 1873; *Facsimiles of Ancient Charters in the British Museum*, 1874-78; *Facsimiles of Anglo-Saxon MSS.*, 1878, 1881. Rolls Series; *Facsimiles of National MSS. of England, Scotland, and Ireland*, in separate series. The various works on illumination, such as those of Count Bastard, Westwood, Tymms and Wyatt, and others may also be consulted. For the study of the Thronian Notes, see Carpenter, *Alphabetum Thronianum*, 1747; Kopp, *Palaeographia Critica*, 1817; Fales Tariff, "Mémoire sur les Notes Throniennes," in the *Mémoires de l'Académie des Inscriptions*, ser. 2, tom. III., 1852; and the "Notes Breviales," &c., published in the *Palaeographicon periodicum*. A useful handbook of contractions is Chassani's *Dictionnaire des Abréviations*, 1862. For particulars as to materials employed and the mechanical arrangements followed in the production of MSS., see Bir's *Antike Buchwesen* (1887) and Wattenbach's *Schriftwesen im Mittelalter* (1875).

**PALÆOLOGUS**, a Byzantine family name which first appears in history about the middle of the 11th century, when George Palæologus is mentioned among the prominent supporters of Nicephorus Botaniates, and afterwards as having helped to raise Alexius I. Comnenus to the throne in 1081; he is also noted for his brave defence of Durazzo against the Normans in that year. Michael Palæologus, probably his son, was sent by

Manuel II. Comnenus into Italy as ambassador to the court of Frederick I. in 1154; in the following year he took part in the campaign against William of Sicily, and died at Bari in 1155. A son or brother of Michael, named George, received from the emperor Manuel the title of *Sebastos*, and was entrusted with several important missions; it is uncertain whether he ought to be identified with the George Palæologus who took part

in the conspiracy which dethroned Isaac Angelus in favour of Alexius Angelus in 1195. Andronicus Paleologus Comnenus was Great Domestic under Theodoros Lascaris and John Vatatzes; his eldest son by Irene Paleologina, MICHAEL (*g.v.*), became the eighth emperor of that name in 1260, and was in turn followed by his son Andronicus II (1282-1328). Michael, the son of Andronicus, and associated with him in the empire, died in 1320, but left a son, Andronicus III, who reigned from 1328 to 1341; John VI (1355-1391), Manuel II (1391-1428), and John VII (1425-1448) then followed in lineal succession; Constantine XIII, the last emperor of Constantinople (1448-1453), was the younger brother of John VII. Other brothers were Demetrius, prince of Morea until 1460, and Thomas, prince of Achaia, who died at Rome in 1465. A daughter of Thomas, Zoe by name, married Ivan III of Russia. A younger branch of the Paleologi held the principality of Monferrat from 1305 to 1533, when it became extinct.

**PALÆONTOLOGY.** See **GEOLOGY**, vol. x. pp. 319 *sq.* Further details will be found in **DISTRIBUTION** and in the articles on the various zoological groups and forms (see, *e.g.*, **BIRDS**, **ICHTHYOLOGY**, **ICHTHYOSAURUS**, **MAMMALIA**, **MAMMOTH**).

**PALÆOTHERIUM.** See **MAMMALIA**, vol. xv. p. 429.

**PALEOPHATUS**, the author of a treatise *περὶ ἀπίστων*, "On Incredible (Narratives)," which has been preserved. It consists of a series of explanations of Greek legends, without any attempt at arrangement or plan. It is obviously a mere epitome of some more complete work. The great number of MSS., containing numerous variations in text, and the frequent quotations made from the treatise by late writers, show that it was a favourite work in their time. It is probable that the original treatise, from which it was abbreviated, was the *λύσεις τῶν μυθικῶν εἰρημένων* of a late writer mentioned by Suidas as a grammarian of Egypt or of Athens.

**PALAMFOX Y MELZI**, JOSÉ DE (1780-1847), duke of Saragossa, was the youngest son of an old Aragonese family. Brought up at the Spanish court, he entered the guards at an early age, and in 1808 he accompanied Ferdinand to Bayonne, but made his escape after the king's abdication. While he was living in retirement at his family seat near Saragossa, the inhabitants proclaimed him governor of that city and captain-general of the kingdom of Aragon (May 25, 1808), an honour which he owed to his rank, and, it is said, to his appearance, rather than to talent or experience in military affairs. Despite the want of money and of regular troops, he lost no time in declaring war against the French, who had already overrun the neighbouring provinces of Catalonia and Navarre, and soon afterwards the attack he had provoked began; Saragossa was bombarded on July 22, and on August 4 the French were masters of nearly the half of the town. Summoned to surrender, Palafox sent the famous reply of "War to the Knife," and on the following day his brother succeeded in forcing a passage into the city with 3000 troops. It was resolved, amid the enthusiasm of the inhabitants (whose real leaders belonged to the lower orders), to contest possession of the remaining quarters of Saragossa inch by inch, and if necessary to retire to the suburb across the Ebro, destroying the bridge. The struggle, which was prolonged for nine days longer, resulted in the withdrawal of the French (August 14) after a siege which had lasted sixty-one days in all. Operations, however, were resumed by Marshals Mortier and Mancey in November, and after more than 50,000 (it is said) of the inhabitants had perished, partly through the ravages of an epidemic by which Palafox himself was attacked, a capitulation was signed on February 21.

After his recovery Palafox was sent into France and closely confined at Vincennes, but was liberated on the restoration of Ferdinand. In June 1814 he was confirmed in the office of captain-general of Aragon, but soon afterwards withdrew from it, and, having indeed no real aptitude for them, ceased to take part in public affairs. He received the title of duke of Saragossa in 1824, and died at Madrid on February 15, 1847.

**PALAMAS.** See **HESTYCHASTA**, vol. xi. p. 782.

**PALANPUR**, a native state in Guzerat, Bombay, India, lying between 23° 57' and 24° 41' N. lat., and between 71° 51' and 72° 45' E. long., with an area of 3510 square miles, and a population of 234,402. The country is mountainous, with much forest towards the north, but undulating and open in the south and east. The principal rivers are the Saraswati and Banás. The chief, an Afghan of the Loháni tribe, enjoys an estimated gross revenue of £40,000, and pays a tribute to the gáekwár of Baroda. Palanpur town, the capital of the state, contained a population in 1881 of 17,547.

**PALATINATE**, *THE* (German, *Pfalz*), included for some time (from the middle of the 17th to the latter part of the 18th century) two distinct German districts, the Upper or Bavarian Palatinate, and the Lower Palatinate or the Palatinate on the Rhine. The Upper Palatinate, a duchy, belonged to the Nordgau and Bavarian circle, and was bounded by Baieruth, Bohemia, Neuburg, Bavaria, and the territory of Nuremberg. In 1807 (with Cham and Sulzbach) it had 283,800 inhabitants. The Lower Palatinate belonged to the electoral Rhenish circle, and was bounded by Mainz, Katzenellenbogen, Würtemberg, Baden, Alsace, Lorraine, and Treves. It took in the Electoral Palatinate (with a population, in 1786, of 305,000), the principality of Simmern, the duchy of Zweibrücken, half of the county of Sponheim, and the principalities of Veldenz and Lautern.

The palaces of the Rhine originally had their seat in Aix-la-Chapelle. In the 11th century the country called the Palatinate belonged to them as an hereditary fief, in virtue of which they ranked among the foremost princes of the empire. In 1156, after the death of Palgrave Hermann III without heirs, the Palatinate was granted by the emperor Frederick I. to his step-brother Duke Conrad of Swabia. Conrad was succeeded by his son-in-law, Duke Henry of Brunswick, the eldest son of Henry the Lion. In the contest for the crown between Otho IV. and Frederick II., Henry took part with Otho IV., his brother; and in 1215 Frederick II. punished him by putting him to the ban of the empire, and by granting the Palatinate to Louis, duke of Bavaria. Louis was never able to assert his claims with complete success; but his son Otho II. married Agnes, the daughter and heiress of Henry, and thus the Palatinate passed into the hands of the Bavarian family. In 1256 the whole territory of the family was divided between Louis II. and Henry, Otho's sons,—Louis II. obtaining the Palatinate and Upper Bavaria, and Henry Lower Bavaria. The possessions of Louis II. were inherited in 1294 by his two sons, Rudolph I. and Louis, the Palatinate and the electoral dignity going to the former, while the latter (who ultimately became emperor) received Upper Bavaria, to which Lower Bavaria was afterwards added. The claims of Louis to the imperial crown were contested by Frederick the Fair, duke of Austria; and, as Rudolph I. supported Frederick, his brother deprived him of his lands, which were then held in succession by Rudolph's three sons, Adolph, who died in 1327, Rudolph II., who died in 1353, and Rupert I., who died in 1390. Rudolph II. concluded a treaty with the emperor Louis, whereby the electoral vote was to be delivered alternately by Bavaria and by the Palatinate;

but the emperor Charles IV., in return for a part of the Upper Palatinate, conferred on Rupert I. and his heirs the exclusive right to the electoral dignity. Rupert I., in 1386, founded the university of Heidelberg. He was succeeded by his nephew, Adolph's son, Rupert II., whose son and successor, Rupert III., was elected emperor in 1400. After the death of Rupert III. in 1410, his hereditary territories were divided among his four sons, Louis III., John, Stephen (who became palgrave of Simmern and Zweibrücken), and Otho. The families of John and Otho soon died out, and the last representative of the line of Louis III.—Otho Henry—died in 1559. The lands of Otho Henry and the electoral dignity then passed to Frederick III., of the Simmern line; and Frederick III. marked an important epoch in the history of the electorate by definitely associating himself and his house with the Reformed or Calvinistic Church. His immediate successors were Louis VI., Frederick IV., and Frederick V. The latter, in 1619, rashly accepted the crown of Bohemia; and the result was that, after his expulsion from his new kingdom, the Palatinate was given by the emperor Ferdinand II. to Maximilian, duke of Bavaria. In virtue of the treaty of Westphalia, Charles Louis, Frederick V.'s son, who died in 1680, received back the Lower Palatinate, and in his favour an eighth electorate was created, with which was associated the office of lord high treasurer (*Erzschatzmeisteramt*). The house of Bavaria retained the Upper Palatinate, with the office of arch-sewer (*Erztruchsessamt*), and with the rank which had formerly been held in the electoral college by the counts palatine; but it was arranged that, if the male line of Bavaria died out, the lands and rights which had belonged to the rulers of the whole Palatinate should be restored to their descendants. Charles, Charles Louis's son, who died in 1685, was the last representative of the Simmern line. The electoral dignity and the lands connected with it then passed to Charles's kinsman, Philip William, of the Neuburg line, which sprang from Louis the Black, the second son of Stephen, son of Rupert III. Of Louis the Black's two grandsons, Louis and Rupert, the latter was the ancestor of the Veldenz line, which died out in 1694, while from the former sprang all other palatine lines—the Neuburg line, the Neuzweibrücken line, the Birkenfeld line, the Sulzbach line. Philip William, of the Neuburg line, died in 1690, and was succeeded by his son John William, who in 1694 inherited Veldenz, and during the war of the Spanish succession received the Upper Palatinate and all the ancient rights of his house. At the conclusion of the war, however, both rights and lands were restored to the elector of Bavaria. In 1716 John William was succeeded by his brother Charles Philip; and with Charles Philip, who died in 1642, the Neuburg line came to an end, and the Lower Palatinate was inherited by Charles Theodore, of the Sulzbach line. In 1777 the male line of Bavaria became extinct by the death of the elector Maximilian Joseph; and then, in accordance with the treaty of Westphalia, the Upper Palatinate and the Lower Palatinate were reunited, and the palgrave resumed the office of arch-sewer and the ancient place of his family in the electoral college, while the office of lord high treasurer was transferred to the elector of Brunswick. The successor of Charles Theodore, who died childless in 1799, was Maximilian Joseph, duke of Zweibrücken. By the treaty of Lunéville in 1801 his territories were divided, the part which lay on the left bank of the Rhine being taken by France, while portions on the right bank were given to the grand-duchy of Baden, to Hesse-Darmstadt, to the prince of Leiningen-Dachsburg, and to Nassau. By the treaties of Paris concluded in 1814 and in 1815, the palatine lands

on the left bank of the Rhine were restored to Germany, the larger part of them being granted to Bavaria, and the rest to Hesse-Darmstadt and Prussia. The Prussian part of the Palatinate is in the Rhine province; the Hesse-Darmstadt part is included in the province of Starkenburg and Rhine Hesse; the Bavarian part is known as Rhenish Bavaria; and the Baden part is in the Lower Rhine district, which in 1865 was divided into the districts of Mannheim, Heidelberg, and Mosbach.

See Häuser, *Geschichte der rheinischen Pfalz*, 1845; Nobenius, *Geschichte der Pfalz*, 1874.

PALAWAN. See PHILIPPINE ISLANDS.

PALAZZOLO (often *P. Acrae*) to distinguish it from several other places of the same name), a city of Italy, in the province of Syracuse, Sicily, 28 miles west of Syracuse, with a population of 11,069 according to the census of 1881. It is mainly of interest on account of the remains it still preserves of the ancient city of Acra, which was founded by Syracuse in 663 B.C. These consist of a temple, an aqueduct, a theatre with a fine view towards Etna, a smaller theatre or odeum, a group of thirteen cisterns, and, in the vicinity, various rows of rock-cut tombs, from which a rich harvest of vases, &c., was obtained by Baron Judica, the great explorer of the site. See Judica, *Antichità di Acra*.

PALEARIO, AONIO (c. 1500–1570), Italian humanist and Reformer, was born about 1500 at Veroli in the Roman Campagna. Other forms of his name are Antonio Della Paglia, A. Degli Pagliaricci. In 1520 he went to Rome, where, during the years immediately following, he made lasting friendships among the scholars and men of letters whom Leo X. had gathered to his brilliant court. Driven from Rome by the troubles of 1527, he found a home first at Perugia and afterwards, from 1530 onwards, at Siena, where he married happily in 1534. In 1536 his didactic poem in Latin hexameters, *De Immortalitate Animarum*, was published at Lyons. It is divided into three books, the first containing his proofs of the divine existence, and the remaining two the theological and philosophical arguments for immortality based on that postulate. The whole concludes with a rhetorical description of the occurrences of the second advent. Meanwhile his religious views had been undergoing considerable modification, and in 1542 an Italian tract written by him and entitled *Della Pienessa, Sufficienza, et Satisfazione della Passione di Christo, or Libellus de Morte Christi*, was made by the Inquisition the basis of a charge of heresy, from which, however, he successfully defended himself. To the period of his stay in Siena belongs also his *Actio in Pontifices Romanos et eorum Aseclas*, a vigorous indictment, in twenty "testimonia," against what he now believed to be the fundamental error of the Roman Church in subordinating Scripture to tradition, as well as against various particular doctrines, such as that of purgatory; it was not, however, printed until after his death (Leipsic, 1606). In 1546 he accepted a professorial chair at Lucca, which he exchanged in 1555 for that of Greek and Latin literature at Milan. Here about 1566 his enemies renewed their activity, and in 1567 he was formally accused of having taught the doctrine of justification by faith alone, denied that of purgatory, spoken slightly of monastic institutions, and so on. Removed to Rome to answer these charges, he was detained in prison until sentence of death was carried out in July 1570.

An edition of his works (*Ant. Palearii Verulani Opera*), including four books of *Epistolae* and twelve *Orationes* besides the *De Immortalitate*, was published at Lyons in 1552; this was followed by two others, at Basel, during his lifetime, and several after his death, the fullest being that of Amsterdam, 1696. A work entitled *Beneficio di Cristo* ("The Benefit of Christ's Death"), frequently translated, has often been attributed to Paleario, but on insufficient grounds.

**PALEMBANG.** See **SUMATRA.**

**PALENCIA**, an inland province of Spain, one of the eight into which Old Castile is divided, is bounded on the N. by Santander, on the E. by Burgos, on the S. by Valladolid, on the W. by Valladolid and Leon, and has an area of 3127 square miles. In shape it is an irregular parallelogram, measuring 83 miles from north to south with a maximum breadth of 48 miles, sloping from the Cantabrian chain to the Douro. The general direction of all its larger streams is from north to south; of these the principal are the Pisuegra and the Carrion, which unite at Dueñas and flow into the Douro in Valladolid. The tributaries of the former within the province are the Burejo, the Cieza, and the united streams of the Buedo and Abanades; the latter is joined on the right by the Cúeza. The northern part of the province, including the whole partido of Cervera, is mountainous, with some wood and with good pasture in the valleys; the remainder, the "Tierra de Campos," belongs to the great Castilian table-land, and is in general level and almost wholly devoid of trees. In the south occurs a considerable marsh or lake known as La Laguna de la Nava, as yet only partially drained. The mountainous district abounds in minerals, but only the coal is worked, the principal mines being those of San Feliceo de Castilleria, Orbo, and Villaverde de la Peña. The province is crossed in the south-east by the trunk railway connecting Madrid with Irun, while the line to Santander traverses it throughout from north to south; there is also railway connexion with Leon. The highways following the same routes are maintained in good order; the state of the other roads is often bad. The Canal de Castilla, begun by Ensenada in 1753, and completed in 1832, connects Alar del Rey with Valladolid. The province is essentially agricultural, wheat and other cereals, legumes, hemp, and flax being everywhere extensively grown, except in the mountainous districts. Other industries are of secondary importance, the principal being flour-milling and the manufacture of linen and woollen stuffs. The province is divided into seven partidos—Astudillo, Baltanas, Carrion, Frechilla, Palencia, Saldafia, and Carvera; the total population in 1877 was 180,786. The only ayuntamiento with a population exceeding 10,000 was that of Palencia.

**PALENCIA**, capital of the above province, occupies a level site on the left bank of the river Carrion, here crossed by a good stone bridge and by another called Los Puenteccillos. Palencia is the junction of the lines from Asturias and Galicia, and is 7 miles from Venta de Baños on the Madrid and Irun Railway. The distances north-north-east from Valladolid and south-east from Leon are 23 and 82 miles respectively. The height above sea-level is 2362 feet. The town is protected on the west by the river; on the other sides the old machicolated walls, 36 feet high by 9 in thickness, are in fairly good preservation, and beautified by alamedas or promenades which were laid out in 1778. The city is divided into two parts, the ciudad and the puebla, by a winding arcaded street, the Calle Mayor, which traverses it from north to south. The cathedral, which overlooks the Carrion, was begun in 1321 and finished in 1504; it is a large building in the later and somewhat poor Gothic style of Spain. The site was previously occupied by a church erected by Sancho el Mayor over the cave of St Antholin, which is still shown. The church of San Miguel is a good and fairly well-preserved example of 13th-century work; that of San Francisco, of the same date, is inferior, and has suffered more from modernization. The hospital of San Lazaro is said to date in part from the time of the Cid, who was married to Ximena here. The leading industries of Palencia are the woollen and linen manufactories, in which

a third of the inhabitants are engaged; flour-milling comes next in importance. The population of the ayuntamiento was 14,506 in 1877.

Palencia, the Pallantia of Strabo and Ptolemy, was the chief town of the Vaccol. Its history during the Gothic and Moorish periods is obscure; but it was a Castilian town of some importance in the 12th and 13th centuries. The university founded here in 1208 by Alfonso IX. was removed in 1239 to Salamanca.

**PALENQUE**, ruins of, in Chiapas, Mexico. See **ARCHITECTURE**, vol. ii. pp. 450-51; and H. H. Bancroft, *Native Races of the Pacific Coast of North America*, vol. iv.

**PALERMO** (Greek, Πάνοπος; Latin, *Panormus*, *Panormus*), the capital of the Sicilian kingdom as long as it kept its separate being, now capital of a province of the same name in the kingdom of Italy, and the see of an archbishop. The population numbered 205,712 in 1881. The city stands in the north-west part of the island, on a small bay looking eastwards, the coast forming the chord of a semicircle of mountains which hem in the *campagna* of Palermo, called the Golden Shell (Conca d'Oro). The most striking point is the mountain of Heirkte, now called Pellegrino (from the grotto of Santa Rosalia, a favourite place of pilgrimage), which rises immediately above both the sea and the city. Palermo has been commonly thought to be an original Phœnician settlement of unknown date,



Plan of Palermo.

1. Church of S. Giuseppe.
2. Palazzo del Municipio.

3. Church of S. Salvatore.
4. Church of S. Giovanni degli Ebrei.

but lately Prof. Holm, the historian of ancient Sicily, has suggested that the settlement was originally Greek.<sup>1</sup> There is no record of any Greek colonies in that part of Sicily, and Panormus certainly was Phœnician as far back as history can carry us. According to Thucydides (vi. 2), as the Greeks colonized the eastern part of the island, the Phœnicians withdrew to the north-west, and concentrated themselves at Panormus, Motye, and Soloeis (*Soluntum*, *Solunto*). Like the other Phœnician

<sup>1</sup>The coins bearing the name of ΠΑΛΙΟ are no longer assigned to Palermo; but it is probable that certain coins with the name ΠΑΛΙΟ are of Panormus.



colonies in the west, Panhormus came under the power of Carthage, and became the head of the Carthaginian dominion in Sicily. As such it became the centre of that strife between Europe and Africa, between Aryan and Semitic man, in its later stages between Christendom and Islam, which forms the great interest of Sicilian history. As the Semitic head of Sicily, it stands opposed to Syracuse the Greek head. Under the Carthaginian it was the head of the Semitic part of Sicily; when, under the Saracen, all Sicily came under Semitic rule, it was the chief seat of that rule. It has been thrice won for Europe by Greek, Roman, and Norman conquerors—in 276 B.C. by the Epirot king Pyrrhus, in 254 B.C. by the Roman consuls Aulus Atilius and Gnaeus Cornelius Scipio, and in 1071 A.D. by Robert Guiscard and his brother Roger, the first count of Sicily. After the conquest by Pyrrhus, the city was soon recovered by Carthage, but this first Greek occupation was the beginning of a connexion with western Greece and its islands which was revived under various forms in later times. After the Roman conquest an attempt to recover the city for Carthage was made in 550 A.C., which led only to the great victory of Metellus just under the southern wall of the city. Later in the First Punic War, Hamilcar Barca was encamped for three years on Heirkte or Pellegrino, but the Roman possession of the city was not disturbed. Panhormus remained a Roman possession, and one of the privileged cities of Sicily, till it was taken by the Vandal Genseric in 440 A.D. It afterwards became a part of the East-Gothic dominion, and was recovered for the empire by Belisarius in 535. It again remained a Roman possession for exactly three hundred years, till it was taken by the Saracens in 835. As Syracuse remained to the empire for a much longer time, Panhormus now became the Mussulman capital. In 1063 the Pisan fleet broke through the chain of the harbour and carried off much spoil, which was spent on the building of the great church of Pisa. After the Norman conquest the city remained for a short time in the hands of the dukes of Apulia. But in 1093 half the city was ceded to Count Roger, and in 1122 the rest was ceded to the second Roger. When he took the kingly title in 1130, it became and retained the capital and crowning-place of the kingdom, "Prima sedes, corona regis, et regni caput." During the Norman reigns Palermo was the main centre of Sicilian history, especially during the disturbances in the reign of William the Bad (1154-66). The emperor Henry VI. entered Palermo in 1194, and it was the chief scene of his cruelties. In 1198 his son Frederick, afterwards emperor, was crowned there. His reign was the most brilliant time in the history of the city. After his death Palermo was for a moment a commonwealth. It passed under the dominion of Charles of Anjou in 1266, but he was never crowned there. In the next year, when the greater part of Sicily revolted on behalf of Conradin, Palermo was one of the few towns which was held for Charles; but the famous letters of 1282 put an end to the Angevin dominion. From that time Palermo shared in the many changes of the Sicilian kingdom. In 1535 Charles V. landed there on his return from Tunis. The last kings crowned at Palermo were Victor Amadeus of Savoy in 1713, and Charles III. of Bourbon in 1735. The loss of Naples by the Bourbons in 1798, and again in 1806, made Palermo once more the seat of a separate Sicilian kingdom. The city rose against Bourbon rule in 1820 and in 1848. In 1860 came the final deliverance at the hands of Garibaldi, but with it came also the yet fuller loss of the position of Palermo as the capital of a kingdom of Sicily.

The original city was built on a tongue of land between two inlets of the sea. There is some question as to their extent inland, and as to the extent of salt and fresh

water. But there is no doubt that the present main street, the Cassaro, Via Marmorea, or Via Toledo (in official language Via Vittorio Emanuele), represents the line of the ancient town with water on each side of it. Another peninsula with one side to the open sea, meeting as it were the main city at right angles, formed in Polybius's time the *Neapolis* or new town, in Saracen times Khaleea, a name which still survives in that of Calsa. It was on this side that both the Romans and the Norman conquerors entered the city. But the old relations of land and water have long been changed. The two ancient harbours have been dried up; the two peninsulas have met; the long street has been extended to the present coast-line; a small inlet called the Calsa alone represents the old haven. The city kept its ancient shape till after the time of the Norman kings. It is still easy to mark the site of the two inlets, which now form valleys on each side of the long street. The old state of things fully explains the name *Πάροπος*.

There are not many early remains in Palermo. The Phœnician and Greek antiquities in the museum do not belong to the city itself. The earliest existing buildings date from the time of the Norman kings, whose palaces and churches were built in the Saracenic and Byzantine styles prevalent in the island (see NORMANS). Of Saracen works actually belonging to the time of Saracen occupation there are no whole buildings remaining, but many inscriptions and a good many columns, often inscribed with passages from the Koran, which have been used up again in later buildings, specially in the porch of the metropolitan church. This last was built by Archbishop Walter, a native of England, and consecrated in 1185, on the site of an ancient basilica, which on the Saracen conquest became a mosque, and on the Norman conquest became a church again, first of the Greek and then of the Latin rite. What remains of Walter's building is a rich example of the Christian-Saracen style. This church contains the tombs of the emperor Frederick the Second and his parents, as also the royal throne, higher than that of the archbishop; for the king of Sicily, as hereditary legate of the see of Rome, was the higher ecclesiastical officer of the two. But the metropolitan church has been so greatly altered in modern times that by far the best example of the style in Palermo, or indeed anywhere, is the chapel of the king's palace at the west end of the city. This is earlier than Walter's church, being the work of King Roger in 1143. Besides the wonderful display of mosaics, it is, simply as an architectural whole, beyond all praise. Of the palace itself the greater part has been rebuilt and added in Spanish times, but there are some other parts of Roger's work left, specially the hall called Sala Normanna.

Alongside of the churches of this Christian-Saracen type, there is another class which follow the Byzantine type. Of these the most perfect is the very small church of San Cataldo, embodied in public buildings. But the best, though much altered, is the church commonly called Martorana, the work of George of Antioch, King Roger's admiral. This is rich with mosaics, among them the portraits of the king and the founder. Both these and the royal chapel have cupolas, and there is a still greater display in that way in the church of San Giovanni degli Eremiti, which it is hard to believe never was a mosque. It is the only church in Palermo with a bell-tower, itself crowned with a cupola.

Most of these buildings are witnesses in different ways to the peculiar position of Palermo in the 12th century as the "city of the threefold tongue," Greek, Arabic, and Latin. Elements from all three sources may be seen, and inscriptions abound in all three languages. King Roger's sun-

dial in the palace is commemorated in all three, and it is to be noticed that the three inscriptions do not translate one another. In private inscriptions a fourth tongue, the Hebrew, is also often found. For in Palermo, under the Norman kings, Christians of both rites, Musulmans, and Jews were all allowed to flourish after their several fashions. This distinguishes Palermo from some other Sicilian cities which belonged wholly or mainly to one people—Greek, Latin, or Saracen. In many of the early churches of Palermo it is easy to see that they were first designed for the Greek rite, which was gradually supplanted by the Latin. The abiding connexion of Palermo with the races of south-eastern Europe comes out in several other shapes. In Saracen times there was a Slavonic quarter on the southern side of the city, and there is still a colony of United Greeks, or more strictly Albanians, who sought shelter from the Turks, and who keep their national religious usages.

The series of Christian-Saracen buildings is continued in the country houses of the kings which surround the city, La Favara and Mimerno, the works of Roger, and the better known Ziza and Cuba, the works severally of William the Bad and William the Good. The Saracenic architecture and Arabic inscriptions of these buildings have often caused them to be taken for works of the ancient emirs; but the inscriptions of themselves prove their date. Different as is their style, their mere shape is not very unlike that of a contemporary keep in England or Normandy.

All these buildings are the genuine work of Sicilian art, the art which had grown up in the island through the presence of the two most civilized races of the age, the Greek and the Saracen. Later in the 12th century the Cistercians brought in a type of church which, without any great change of mere style, has a very different effect, a high choir taking in some sort the place of the cupola. The greatest example of this is the neighbouring metropolitan church of Monreale; more closely connected with Palermo is the church of San Spirito, outside the city on the south side, the scene of the *Vespera*. Palermo is full of churches and monasteries of later date, as in Saracen times it was crowded with mosques. But only a few are of any architectural importance, and they often simply range with the houses.

Domestic and civil buildings, from the 12th century to the 15th, abound in Palermo, and they present several types of genuine national art, quite unlike anything in Italy. The later houses employ a very flat arch, the use of which goes on in some of the houses and smaller churches of the Renaissance, some of which are very pleasing. But the general aspect of the streets is later still, dating from mere Spanish times. Still many of the houses are stately in their way, with remarkable heavy balconies. The most striking point in the city is the central space at the crossing of the main streets, called the Quattro Cantoni. Here the eye catches the mountains at three ends and the sea at the fourth. But none of the chief buildings come into this view, and the intersecting streets suggest a likeness, which is wholly deceptive, to the four limbs of a Roman *cheater*. Two indeed of the four are formed by the ancient Via Marmorea, but the Via Macqueda, which supplies the other two, was cut through a mass of small streets in Spanish times.

The city walls remain during the greater part of their extent, but they are of no great interest. The gates also are modern. The best is Porta Nuova, near the king's palace, built in 1584 to commemorate the return of Charles V. fifty years earlier. The design is far better than could have been looked for at that time. Outside the walls, in the immediate neighbourhood of the city, there are, besides

the royal country houses and the church of San Spirito, several buildings of the Norman reigns. Among these are the oldest church in or near Palermo, the Lepers' church, founded by the first conqueror or deliverer, Count Roger, and the bridge over the forsaken stream of the Oreto, built in King Roger's day by the admiral George. There are also some later mediæval houses and towers of some importance. These all lie on to the south of the city, towards the hill called Monte Griffone (Griffon = Greek), and the Giant's Cave, which has furnished rich stores for the paleontologist. On the other side, towards Pellegrino, the change in the ancient haven has caused a new one to grow up, but there is little of artistic or historic interest on this side.

Besides works dealing with Sicily generally, the established local work on Palermo is *Descrizione di Palermo Antico*, by Salvatore Morso, Palermo, 1827. Modern research and criticism has been applied in *Die Mittellaterliche Kunst in Palermo*, by Anton Springer, Bonn, 1869; *Historische Topographie von Panormus*, by Julius Schubring, Lübeck, 1870; *Studi di Storia Palermitana*, by Adolf Holm, Palermo, 1880. See also "The Normans in Palermo," in the third series of *Historical Essays*, by E. A. Freeman, London, 1879. The description of Palermo in the second volume of Gaeffel's guide-book, *Unter-Italien und Sicilien*, Leipzig, leaves nothing to wish for. (E. A. F.)

PALES, an old Italian deity, worshipped in the festival of the *Palilia* at Rome on the 21st April. Like most of the ancient Italian deities, Pales is little more than a name to us; the authorities are at variance whether the name belonged to a goddess or to a god. In this festival Pales was invoked to grant protection and increase to flocks and herds; the worshippers entreated forgiveness for any unintentional profanation of holy places of which they might have been guilty, and sprang through fires of straw as a purificatory rite. The German *Maisfeuer*, which remained in use till a very recent date, was a precisely similar custom; the intention was to propitiate the wrath of the deity for any neglect of her service before the summer began, and so ensure her favour to the flocks. The foundation of Rome, *dies natalis Romæ*, was commemorated on this same day,—a custom still kept up. The name *Palilia* is often written, by dissimilation, *Parilia*.

PALESTINE. As Palestine, geographically considered, forms the southernmost third of SYRIA, its general geographical relations, as well as its geological structure, its botany, &c., will be treated under that heading. In the matter of climate, on the other hand, it holds a more or less independent position; and this is more strikingly the case with its ethnographic characteristics, at least so far as the pre-Christian period is concerned. Purely historical questions have already been discussed in the article ISRAEL.

By Palestine is to be understood in general the country seized and mainly occupied by the Hebrew people. That portion of territory is consequently excluded which they held only for a time, or according to an ideal demarcation (*cf.* Numbers xxxiv., from the older source) by which the land of the Israelites was made to extend from the "river of Egypt" to Hamath; but, on the other hand, that other ancient tradition is accepted which fixes the extreme borders at Dan (at the foot of Hermon) in the north and at Beersheba in the south, thus excluding the Lebanon district and a portion of the southern desert. In like manner, though with certain limitations to be afterward mentioned, the country east of Jordan stretched from the foot of Hermon to the neighbourhood of the Arnon. Towards the west the natural boundary—a purely ideal one so far as occupation by the Israelites was concerned—was the Mediterranean, but towards the east it is difficult to fix on any physical feature more definite than the beginning of the true steppe region. That the territory of Israel extended as far as Salcah (east of Boara at the foot of the Hauran Mountains) is the statement of an ideal rather



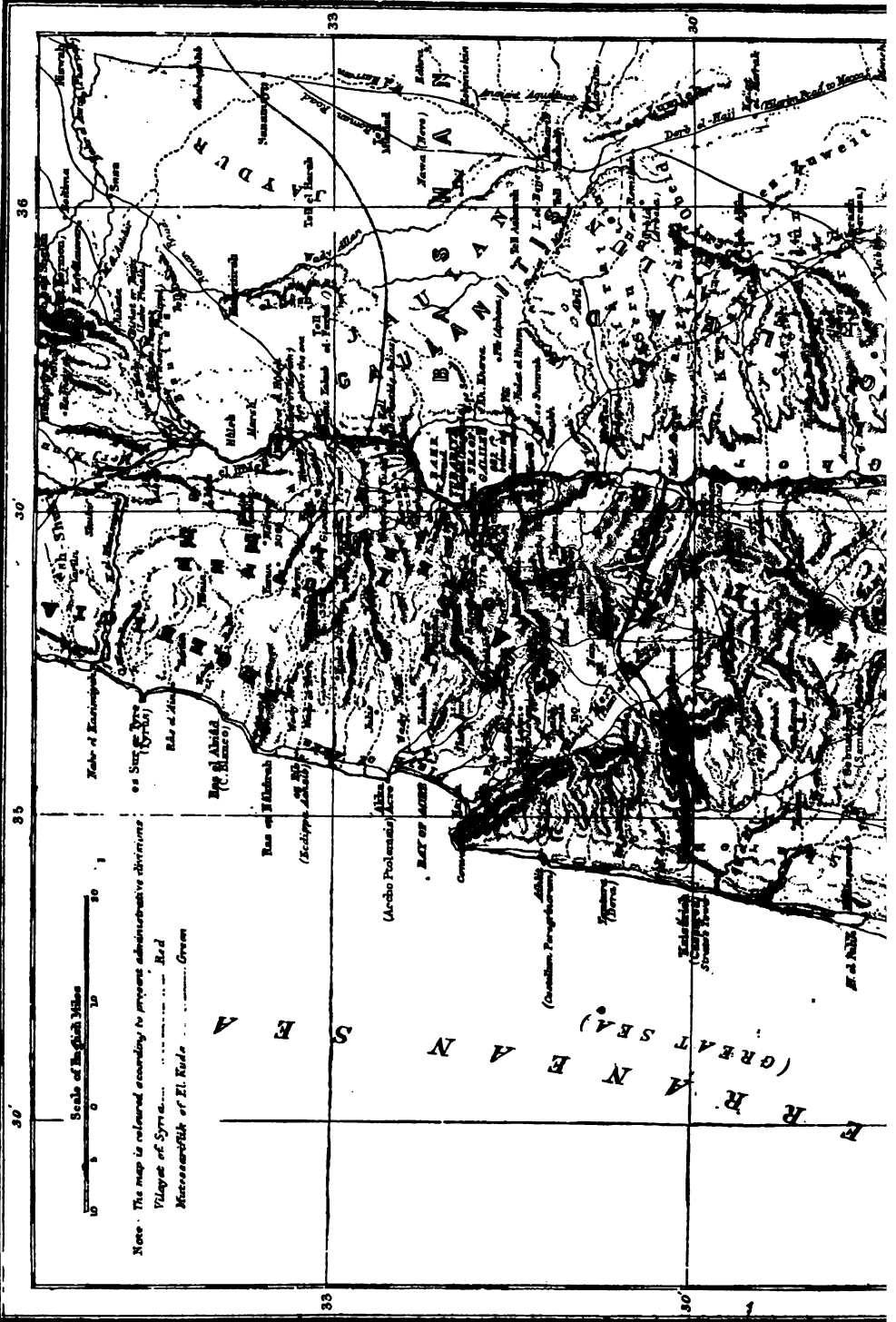

Scale of English Miles  
 0 5 10 20

Note: The map is colored according to present administrative divisions:  
 Vilayet of Syria ..... Red  
 Mutasarriflik of El Kude ..... Green

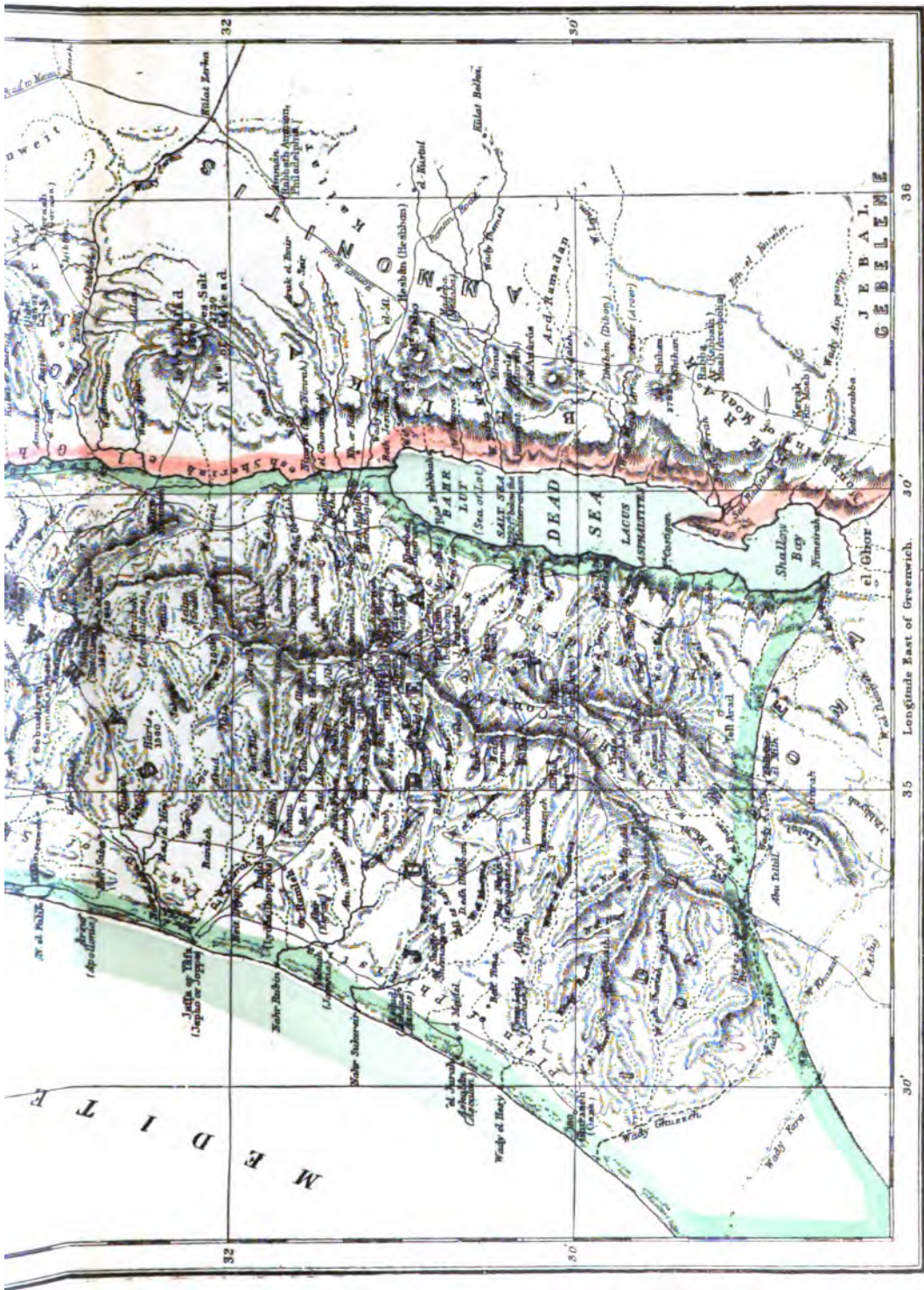

ENCYCLOPEDIA BRITANNICA NINTH EDITION

W.A.A.J. Johnston Edinburgh & London.





than an historical frontier (Josh. xiii. 11). Palestine thus lies between 31° and 33° 20' N. lat.; its south-west point is situated about 34° 20' E. long., some distance south of Gaza (Ghazza), its north-west point about 35° 15' E. long., at the mouth of the Litány (Kásimíye). As the country west of the Jordan stretches east as far as 35° 35' it has a breadth in the north of about 23 miles and in the south of about 80 miles. Its length may be put down as 150 miles; and, according to the English engineers, whose survey included Beersheba, it has an area of 6040 square miles. For the country east of the Jordan no such precise figures are available. The direct distance from Hermon to Arnon is about 120 miles, and the area at the most may be estimated at 3800 square miles. The whole territory of Palestine is thus of very small extent, equal, in fact, to not more than a sixth of England. The classical writers ridicule its insignificant size.

*General Geography.*—Palestine, as thus defined, consists of very dissimilar districts, and borders on regions of the most diverse character. To the south lies a mountainous desert, to the east the elevated plateau of the Syrian steppe, to the north Lebanon and Anti-Libanus, and to the west the Mediterranean. In the general configuration of the country the most striking feature is that it does not rise uninterruptedly from the sea-coast to the eastern plateau, but is divided into two unequal portions by the deep Jordan valley, which ends in an inland lake (see JORDAN). Nor does the Jordan, like the Nile in Egypt, simply flow through the heart of the country and form its main artery; it is the line of separation between regions that may almost be considered as quite distinct, and that too (as will afterwards appear) in their ethnographic and political aspects. This is especially the case in the southern sections of the country; for even at the Lake of Tiberias the Jordan valley begins to cut so deep that crossing it from either direction involves a considerable ascent.

The country west of Jordan is thus a hilly and mountainous region which, forming as it were a southward continuation of Lebanon, slopes unsymmetrically east and west, and stretches south, partly as a plateau, beyond the limits of Palestine. The mountain range consists of a great number of individual ridges and summits, from which valleys, often rapidly growing deeper, run east and west. Towards the Mediterranean the slope is very gradual, especially in the more southern parts, where the plain along the coast is also at its broadest. About three-fourths of the cis-Jordan country lies to the west of the watershed. Towards the Dead Sea, on the other hand, the mountains end in steep cliffs; and, as the Jordan valley deepens, the country draining towards it sinks more abruptly, and becomes more and more inhospitable. The plateaus back from the coast-cliffs of the Dead Sea have been desert from ancient times, and towards the east they form gullies of appalling depth. On the other side of the Jordan the mountains have quite a different character, rising from the river gorge almost everywhere as a steep wall (steepest towards the south) which forms the edge of the great upland stretching east to the Euphrates.

*Geology.*—The mountains both east and west of the Jordan consist in the main of Cretaceous limestone; nummulitic limestone appears but rarely, as on Carmel, Ebal, and Gerizim. Towards the Dead Sea the rock is traversed by hornblende and flint. Formations of recent origin, such as dunes of sea-sand and the alluvium of rivers and lakes, cover the western margin of Palestine (i.e., the whole of Philistia and the plain of Sharor) and the entire valley of the Jordan. Plutonic or volcanic rocks occur occasionally in the country east of Jordan; less frequently in the country to the west, as, for example, in the mountains round the plain of Jezreel.

*Physical Divisions.*—The mountain system west of Jordan must be broken up into a number of separate groups, which, it may be remarked, are of political as well as physical significance. A first group, consisting of the country north of the plain of Jezreel, may be subdivided into a large northern portion with summits reaching a height of 4000 feet, and a smaller southern portion not exceeding 2000 feet. The former, the Upper Galilee of antiquity, is a mountainous region with a somewhat intricate system of valleys, stretching from the Kásimíye in the north to a line drawn from Acre (Akka) towards the Lake of Tiberias. Of the valleys (more than thirty in number) which trend westwards to the Mediterranean, the Wádi Hubeishiye, Wádi 'Eziye, and Wádi el-Kurn deserve to be mentioned. Not far west of the watershed is a plateau-like upland draining northwards to the Kásimíye. The slope to the Jordan is steep. Jebel Jermak, a forest-clad eminence 3934 feet above the sea, is the highest *massif*. The whole territory is fruitful, and forms decidedly one of the most beautiful as well as best-wooded districts of Palestine. The plain along the Mediterranean is on the average hardly a mile broad; between cliff and sea there is at times barely room for a narrow road, and at some places indeed a passage has had to be cut out in the rock. South of Rás en-Nakúra, on the other hand, this plain widens considerably; as far as Acre the portion named after this town is about 4 miles broad.

The mountain structure of the second subsection, or Lower Galilee, is of a different character,—low chains running east and west in well-marked lines, and enclosing a number of elevated plains. Of these plains the most important is that of Buttauf (plain of Zebulun or Asochis), an extremely fertile (in its eastern parts marshy) depression 9 miles long and 2 broad, lying 400 to 500 feet above the sea, between hills 1700 feet high. To the south-west, about 700 feet above the sea, is the smaller but equally fertile plain of Tor'an, 5 miles long and 1 mile broad. Among the mountains the most conspicuous landmarks are Nebi Sa'ín (1602) near Nazareth, Jebel es-Sih (1838), and especially, to the east of this last, Jebel et-Túr or Tabor (1843), an isolated wooded cone which rises on all sides with considerable regularity, and commands the plain of Esdraelon. Eastwards the country sinks by a succession of steps: of these the lava-strewn plateau of Sahel el-Ahma, which lies above the cliffs that look down on the Lake of Tiberias, but is 300 feet below the level of the Mediterranean, deserves mention. The principal valleys of the whole region are (1), towards the west, the great basin of Nahr Na'mán (Belus of the ancients), whose main branch is Wádi Khalzín, known in its upper course as Wádi Sha'ib or Wádi Khashab, and, farther south, the basin of the Wádi Melek (Wádi Rummáni), which flows into the Nahr el-Mukatta' (Kishon); and (2) towards the east the rapid-flowing Wádi Rubudíye, Wádi el-Hamám, and Wádi Fejjás.

A certain connexion exists between the plains already mentioned (those of Buttauf, Acre, &c.) and the great plain which, with an average height of 250 feet above the sea, stretches south from the mountains of Galilee and separates them from the spurs of the mountains of Samaria (the central portion of the cis-Jordan country). This great plain, which in ancient times was known as the plain of Megiddo, and also as the valley of Jezreel or plain of Esdraelon, and which now bears the name of Merj Ibn 'Ámir (pasture land of the son of 'Ámir), is one of the main features of the whole cis-Jordan region (Josephus called it the Great Plain *par excellence*), and presents the only easy passage from the coast districts to the Jordan valley and the country beyond. The larger portion lies west of the watershed, which at El-'Afulé is 260 feet above

the Mediterranean. In the narrower application of the name, the whole plain forms a large triangle with its southern corner near Jennin and its western near the mouth of the gorge of the Nahr el-Mukhatta' (for here the hills of Nazareth shoot out towards Carmel); and connected with it are various small plains partly running up into the hills. The plain to the south of Acre, in which marshes are formed by the Kishon and Na'mán, and various other recesses towards north and east really belong to it. To the north-east stretches a valley bounded in one direction by Jebel Duhy (the Lesser Hermon, a range 15 miles long and 1690 feet high) and in the other direction by the hills of Nazareth and Mount Tabor (where lie Kksal and Deburiye); then to the east of the watershed lies the Bire valley, and the well-watered Wádi Jálud from Zer'in (Jezreel) falls away towards the Jordan between the slopes of Jebel Duhy and the more southern range of Jebel Fukú'a (Mountains of Gilboa). And finally towards Jennin in the south lies the secondary plain of 'Arráne. Quite recently it has been proposed to construct in the Merj Ibn 'Amir the beginning of a railway system for Palestine, and to turn to account the wonderful fertility of its rich basaltic loam which now lies almost completely waste, though in ancient times the whole country was densely peopled and well-cultivated.

To the south of the plain of Jezreel, which belongs to the northern system of Palestine, it is much more difficult to discover natural divisions. In the neighbourhood of the watershed, which here runs almost regularly in great zigzags, lie a number of plains of very limited extent:—the plain of 'Arráne (700 to 800 feet above the sea) connected south-east with the Merj el-Ghuruk, which having no outlet becomes a lake in the rainy season; the plain of Fendekúmiye (1200 feet); and the plain of Rújib, east of Shechem, connected with the plain of Mukhna (1600 to 1800 feet) to the south-west. The highest mountains too are generally near the watershed. In the east lies the south-westward continuation of Gilboa. In the west Mount Carmel (highest point 1810 feet, monastery 470) meets the projection of the hills of Nazareth, and sends its wooded ridge far to the north-west so as to form the southern boundary of the Bay of Acre, and render the harbour of Haifa, the little town at its foot, the best on all the coast of Palestine. The belt of land along the shore, barely 200 yards wide, is the northern end of the lowland plain, which, gradually widening, stretches south towards Egypt. At Athlít (9 miles south) it is already 2 miles broad, and it continues much the same for 21 miles to the Nahr ez-Zerka (named by the ancients after the crocodile which is still to be found in its marshes), where a small ridge El Khashm projects from the highlands. South of Nahr ez-Zerka begins the marvellously fertile plain of Sharon, which with a breadth of 8 miles near Cæsarea and 11 to 12 miles near Yáfá (Jaffa), stretches 44 miles farther to the Nahr Rúbin, and slopes upwards towards the mountains to a height of about 200 feet above the sea. Its surface is broken by lesser eminences, and traversed by a few coast streams, notably the Nahr el-Falik.

Between the maritime plain and the mountains proper lies a multiform system of terraces, with a great number of small ridges and valleys. In this the only divisions are those formed by the basins of the larger wadis, which, though draining extensive districts, are here too for the most part dry. They all have a general east and west direction. First comes the basin of the Nahr Mefjir, bounded south by the Bayazid range, and debouching a little to the south of Cæsarea; and about 5 miles farther south is the mouth of the Iakanderúna, which is distinguished in its upper portion as the Wádi Sha'ír, running

east as far up as Nábulus (Shechem), hardly a mile west of the watershed. It is in this neighbourhood that we find the highest portions of the mountains of Samaria—Jebel Esalámiye or Ébal, 8077 feet high, to the north of Shechem, and Jebel et-Túr or GERIZIM (*q.v.*), 2849 feet high. Both are bare and rugged, and consist, like all the loftier eminences in the district, of hard limestone capped with chalk. It was generally possible, however, to carry cultivation up to the top of all these mountains, and in ancient times the highlands of Samaria are said to have been clothed with abundant forest. From the watershed eastward the important Wádi Fá'a (also known as Wádi Keráwa in its lower course) descends to the Jordan. Returning to the western slope, we find to the south of Nahr el-Falik the basin of the 'Aujá, which after it leaves the hills is fed by perennial (partly palustrine) sources, and falls into the sea 5 miles north of Jaffa. As at this place the watershed bends eastward, this extensive basin stretches proportionally far in that direction; and, the right side of the Jordan valley being also very broad, the mountains of the eastern slope soon begin to sink rapidly. On the watershed, not far from Jifna, lies Tell Asúr (3378 feet), and with this summit of hard grey limestone begin the hills of ancient Judah. South of the 'Aujá comes the Nahr Rúbin (near Jabne), perennial up to the Wádi Surár (Sorek of Scripture f), and reaching, as Wádi Bét Hanána, as far as the country north of Jerusalem; the Wádi el-Werd is one of its tributaries. Farther south begins the maritime plain of Philistia, which stretches 40 miles along the coast, and, though now but partially under cultivation, consists of a light brown loamy soil of extraordinary fertility. It is crossed by numerous ridges of hills; and to the south of Ashdod (Ezdúdd) the highlands advance westwards, and form a hilly district composed of horizontal strata of limestone, sometimes considered part of the lowlands (Shephela), and separated from the more elevated region in the interior by a ridge more or less parallel with the line of the watershed. The basins to the south of the Rúbin are those of Wádi Sukereir, which runs up towards Tell-es-Sáfi in one direction and to Bét Jibrín in another, of Wádi el-Hesy, and finally of Wádi Ghazza, which forms the proper boundary of Palestine towards the south, runs past Beersheba as Wádi es-Seba, and receives the Wádi el-Khalíl (Hebron) from the north-east.

As regards the central parts of the country, the mountainous district north of Jerusalem is now known as Jebel el-Kuda, of which the loftiest point is the summit of the Nebi Samwíl (2935), rising above the plateau of El-Jib. Near Jerusalem the watershed lies at a height of about 2600 feet. Wild deep-sunk valleys descend eastwards to the Jordan; the Wádi Kelt, Wádi en-Nár (Kedron valley), Wádi ed-Dereje, and southernmost Wádi Seyál deserve to be mentioned. The country sloping to the Dead Sea falls in a triple succession of terraces,—a waterless treeless waste (in ancient times known as the desert of Judah), which has never been brought under cultivation, but in the first Christian centuries was the chosen abode of monasticism. To the north of Hebron, in the neighbourhood of Hulhúl, lie the highest elevations of this part of the central highlands (up to 3500 feet), which may be distinguished as the mountains of Hebron. Towards Yutta (Juttah) in the south is a sudden step; there begins a plateau at a height of about 2600 feet, but 500 feet below the Hebron watershed. It consists of open wolds and arable land, the soil being a white soft chalk; but there are no wells. Southward another step leads to the white marl desert of Beersheba, abounding in caves. In ancient times this southern district was called the Negeb; it extends far to the south, but is properly a part of Palestine. The country was in former times a steppe region without

definite boundaries, and consequently the abode of nomadic heremen.

The Jordan valley having already been described in a separate article (vol. xiii. p. 746), we may pass at once to a brief sketch of the physical character of the country east of Jordan (compare also the article GILEAD, vol. x. p. 594). This is a more difficult task for several reasons: first, no connected series of investigations and measurements has been made in this region; and, secondly, as the ideal demarcation of the book of Joshua is a hardly sufficient basis on which to build, and the information about the actual state of matters supplied by other ancient sources is insufficient, it is impossible to determine the limits of the country as far as it was occupied by the Israelites.

In the opinion of the present writer, the plain of BASHAN (*q.v.*) can hardly be assigned to Palestine. To the south of the Yarmuk (Hieromax of the Greeks and Romans, Hebrew name unknown), which falls into the Jordan below the Lake of Tiberias, begins the Cretaceous formation; only in the east of the country the basalt of the Hauran territory stretches farther south. Ascending from the Yarmuk, we first of all reach a mountainous district of moderate elevation (about 2000 feet) rising towards the south; this is Jebel 'Ajlún, which abounds in caves, and, according to recent explorers, is extremely well watered and of great fertility—the whole surface being covered with pasture such as not even Galilee can show. Eastwards are massive ridges as much as 4000 feet in height—Jebel Kafkafa and especially Marád—separating this territory from the waterless desert lying at no great depth below. The plateau stretches away to the south of the deep gorge of the perennial Zerka (Jabbok), and reaches a considerable height in Jebel Jifád (Gilead in the stricter sense). The landmark of the region is Jebel 'Osha, to the north of Es-Salt, so-called from the traditional tomb of Hosesa. From the deep-sunk Jordan valley the mountains rise grandly in terraces, partly abrupt and rocky; and, while fig trees and vines flourish down in the lower levels, valonia oaks, *Laurus Pinus*, cedars, and arbutus grow on the declivities. Owing to its perennial springs, the interior terrace of the country, Mishór, is a splendid pasture land, famous as such in ancient times; and abundance of wood and water renders this whole middle region of the trans-Jordan country one of the most luxuriant and beautiful in Palestine. Only a few individual summits, such as Jebel Nebá (Mount Nebo), are noticeable in the ridges that descend to the Jordan valley. The country from the Zerka southward to the Mójisb (Arnon) is now known as El Belka; and beyond that begins the land of Moab proper, which also consists of a steep mountain-wall through which deep gorges cut their way to the plain, and behind this of a plateau poorly watered but dotted over with ancient ruins. In this district, too, there are a few individual summits. And here also a mountain-wall separates the plain from the eastern desert; and the mountain district continues farther south along the Araba (*cf.* IDUMEA, vol. xii. p. 699).

*Water.*—Palestine is not exceptionally deficient in water. Perennial streams, indeed, are scarce, and were so in antiquity; but except in certain districts, as the desert of Judah, the country is not badly supplied with springs. In keeping with the structure of the rocks, these usually break out at the junction of the hard and soft strata. Thus abundant springs of good water occur on the very summit of the cis-Jordan country, as, for example, near Hebron, at Nábulus, and in Galilee; and, though few are found in the immediate neighbourhood of Jerusalem, more than forty may be counted within a radius of 15 to 20 miles round the city. There is no water in the low hilly

country behind the coast region; and, though in its northern portion some fairly large streams take their rise, the same is true of the coast-region itself. Rising as they do at the foot of a great mountain range, the most abundant springs in Palestine are those of the Jordan, especially those near Bánias and Tell-el-Kádi. The mountains of Gilead are rich in excellent water. A considerable number of hot springs occur throughout the country, especially in and near the Jordan valley; they were used in ancient times for curative purposes, and might still be so used. The water of the bath of El-Hammám, about 2 miles south of Tiberias, has a temperature of 137° Fahr., and the spring near the Zerka Má'in, formerly known as Callirrhoe, as much as 142° Fahr. Hot sulphur springs also occur on the west coast of the Dead Sea. Many of the springs in Palestine are slightly brackish. From the earliest times cisterns have naturally played a great part in the country; they are found everywhere in great numbers. Generally they consist of reservoirs of masonry widening out downwards, with a narrow opening above often covered with heavy stones. Open reservoirs were also constructed to collect rain and spring water. Such reservoirs (pools; Arab, *birka*; Hebrew, *berékha*) are especially numerous near Jerusalem and Hebron; the largest still extant are the three so-called Pools of Solomon, in Wádi Urtás (Artas), arranged in steps at a little distance from each other. Besides the conduits connected with this gigantic work, fine remains of aqueducts of Roman date are found near Jericho, in the ruins of many towns in the trans-Jordan country, at Sefúriye (Sepphoris) in Galilee, in ancient Caesarea, &c. Many of these aqueducts, as well as many now ruined cisterns, could be restored without much trouble, and would give a great stimulus to the fertility and cultivation of the country.

*Climate and Vegetation.*—Palestine may be considered part of the subtropical zone. At the summer solstice the sun stands 10 degrees south of the zenith; the shortest day is thus one of ten hours, the longest of only fourteen. In a few points, as already remarked, there is a difference between Palestine and the rest of Syria. The extensive maritime plain and the valley of the Jordan give rise to important climatic contrasts. From its vicinity to the sea the former region is naturally warmer than the highlands. The mean annual temperature is 70° Fahr., the extremes being 50° and 85°. The harvest ripens two weeks earlier than among the mountains. Citrons and oranges flourish; the palm also grows, but without fruiting; melons are largely cultivated; and pomegranate bushes are to be seen. Less rain falls than in the mountains. Another climatic zone consists of the highlands (from 500 to 3000 feet above the sea), which were the real home of the Israelites. The average temperature of Jerusalem, which may be taken as pretty much that of the upland as a whole, is 62°, but the extremes are considerable, as the thermometer may sink several degrees below the freezing point, though frost and snow never last long. The rainfall of 20 inches is distributed over about fifty days. In this climate the vine, the fig, and the olive succeed admirably. Even in the southernmost districts (of the Negeb), as well as throughout the whole country, there are traces of ancient wine-growing. A large share of the oil is consumed at home, partly in the manufacture of soap. The mountain ridges in this zone are for the most part bare, but the slopes and the valleys are green, and beauty and fertility increase as we advance northwards. In regard to the climate of the third zone, see JORDAN (vol. xiii. *et sup.*). The barley harvest here ends with the middle of April. The thermometer rarely sinks below 77°, and goes as high as 130°. The fourth zone, the elevated plateau of the trans-Jordan region, has an extreme climate.

The thermometer may frequently fall during the night below the freezing point, and rise next day to 80°. The mountains are often covered with snow in winter. Whilst the rainfall in the Jordan valley is very slight, the precipitation in the eastern mountains is again considerable; as in western Palestine the dewfall is heavy. From this short survey it appears that Palestine is a country of strong contrasts. Of course it was the same in antiquity; climate, rainfall, fertility, and productiveness cannot have seriously altered. Even if we suppose that there was a somewhat richer clothing of wood and trees in the central districts of the country, yet on the whole the general appearance must have been much the same as at present. To the stranger from the steppes arriving at a favourable season of the year Palestine may still give the impression of a land flowing with milk and honey. The number of cisterns and reservoirs is proof enough that it was not better supplied with water in ancient times; but, on the other hand, the numerous ruins of places which were still flourishing during the Roman period show that at one time (more especially in the southern districts, which now possess but few inhabited localities) cultivation must have been carried on more extensively and thoroughly. In general the country enjoyed the greatest security, and consequently the greatest prosperity, under Western rule, which even protected the country east of Jordan (at present partly beyond the control of the Government) from the inroads of the Bedouins. The Romans also did excellent service by the construction of roads, portions of which (as well as Roman milestones and bridges) still exist in good preservation in many places. Thus it cannot be denied that the resources of the country were formerly better developed than at present. Like all the lands of the nearer East, Palestine suffers from the decay of the branches of industry which still flourished there in the Middle Ages. The harbours are not of sufficient size for large vessels; that of Haifa alone is capable of any development. The road from Yafa to Jerusalem is the only one in the country fit for carriages. The proposal to construct a railway along this route (for which a firman was granted in 1875) is renewed from time to time; but it will be hard to carry it out, as, in spite of the pilgrims (who, besides, are restricted to one period of the year), the passenger traffic is not large enough to be remunerative, and commercial traffic there is almost none. At the same time the formation of means of communication would increase the productiveness of the country. The culture of olives and export of oil are especially capable of expansion. As regards the industrial arts, souvenirs for the pilgrims, rosaries, carved work in olive wood and mother-of-pearl, &c., are produced at Jerusalem and Bethlehem, and to some extent are exported. Wheat from the Hauran is also shipped at Acre and elsewhere, but neither exports nor imports are commercially important. The salt farming, which could easily be carried on at the Dead Sea and the deposit of salt to the south of it, is hampered by the difficulty of bringing the produce up the steep paths to the top of the mountains. In the valley of the Jordan all the products of the tropics could with little trouble be cultivated. Bee-keeping still receives attention, but might also be extended.

*Political Geography.*—Evidence of an early occupation of Palestine is afforded by the stone monuments (cromlechs and circles of stones), which are found more especially in the country east of Jordan, but also in the country to the west. To what period they belong in this part of the world is as doubtful as it is elsewhere; but it may be remarked that stories of a gigantic primeval population once prevailed in Palestine. To what race these people may have belonged is, however, unknown. For thousands

of years Palestine was an object of conflict between the vast monarchies of western Asia. As Egypt, whenever she sought to extend her power, was from the very position of the country naturally led to make herself mistress of the east coast of the Mediterranean, so, on the other hand, there were no physical boundaries to prevent the westward advance into Palestine of the Asiatic empires. For both Egypt and the East indeed the country formed a natural thoroughfare, in time of war for the forces of the contending powers, in time of peace for the trading caravans which carried on the interchange of African and Asiatic merchandise.

One of the oldest of the still extant historical documents in regard to the geography of Palestine is the inscription on the pylones of the temple of Karnak, on which Thothmes III. (in the beginning of the 16th century B.C.) has handed down an account of his military expedition to western Asia. Many of the topographical names of Palestine there mentioned are certainly hard to identify; a number, however, such as Iphu for Yafa, Luden for Lydda, Magedi for Megiddo, &c., are beyond dispute. The lists show that these names are of extreme antiquity, dating from before the Hebrew immigration. There is also a hieratic papyrus of the 14th century B.C., which contains a description of a carriage journey through Syria made by an Egyptian officer, possibly for the collection of tribute. Bethshean and the Jordan, among other localities, appear to be mentioned in this narrative, but the identification of most of the names is very dubious. Another foreign source of information as to the geography of Palestine can only be alluded to—the records contained in the cuneiform inscriptions, which mention a number of the most important towns:—Akku (Akko, Acre), Du'ru (Dor), Magidu (Megiddo), Yappu (Jaffa), Asndudu (Ashdod), Iskaluna (Askalon), Hazzatu (Ghazza, Gaza), Altaku (Eltheke), Ursalimmu (Jerusalem), and Samarina (Samarina), and—of course only from the 8th century, when they came into hostile contact with Assyria—the countries of Judah, Moab, Ammon, and Edom.

The information supplied by the Old Testament enables us to form only an extremely imperfect conception of the earliest ethnographic condition of the country. The population to the east of the Jordan was already, it is clear, sharply marked off from that to the west. In the latter region dwelt an agricultural people which had already reached no inconsiderable degree of civilization. Closely related to the Phœnicians, they were distinguished as Canaanites from the name of their country, which originally applied to the maritime belt and afterwards to the whole cis-Jordan territory (vol. iv. p. 62). Though for particular reasons they are placed among the Hamitic races in Gen. x., many modern investigators are of opinion that, according to our principles of ethnographic classification, they were Semitic; their language, at any rate, was very similar to Hebrew. The separation of Canaanites from Semites may have been due, in part at least, to the fact that a deep contrast made itself felt between them and the Hebrews, though they were only, perhaps, an older result of Arabic emigration. The enumeration of the names of the various branches of the Canaanites leaves it an extremely difficult task to form a clear idea of their tribal distribution; names of separate sections, too, like that of the Amorites, are sometimes applied to the Canaanites as a whole. The Amorites were at any rate the most powerful tribe; they dwelt in the southern portion of Canaan, as well as more especially in the northern parts of the country east of Jordan. About the others nothing more can be said save that the Perizzites, Hivites, and Girgashites dwelt in the heart of Canaan and the Jebusites near Jerusalem. The Philistines occupied

the south-west of the country; as Arabian population was settled in the south and south-west. Amalekites and Midianites, and the Kenites, a branch of the latter, early entered into close relationship with the Israelites, and along with them took possession of the extreme south, where, however, they remained nomadic. Of peoples closely akin to the Israelites may be mentioned the Moabites, the Ammonites, and the Edomites. Before the arrival of the Israelites the Moabites had developed a certain degree of power. The district, bordering on Edom, which they occupied in the south of the country east of Jordan, was bounded on the south by Wādi el-Ahsa (called in *Is. xv.* 7 the brook of the willows), an affluent of the southern part of the Dead Sea, and on the north stretched far beyond the Arnon (originally, indeed, to the north end of the sea, as in later times the country near Jericho was known as the steppes of Moab). Its eastern frontier must always have been matter of dispute, the relations of the nomadic tribes of the Syrian desert being the same as they are now, and contests with the Ammonites taking place from time to time. The Ammonites, a closely related people, lay to the north-east of Moab, east of the later possessions of Israel; but, as they were in the main nomadic, their frontiers were of a shifting character (see *vol. i. p. 742*). The Edomites (also nomadic) were situated in the south of the country east of Jordan; how far, at an earlier period, they extended their encampments to the west of Jordan and into the Negeb district cannot be with certainty decided.

It depends on the conception we form as to the general tribal relations of Israel how we represent to ourselves the method in which the settlement of the country by the tribes was accomplished as they passed from the nomadic to the fixed mode of life (*cf. ISRAEL, JOSEPH, JUDAH*). To explain this tribal relationship is not the task of a geographical sketch; it is enough for the present purpose to call attention to the fact that the account of the rise of the Israelitic tribes as it has come down to us is in great measure mythical or the product of later reflexion; even the number twelve is made out only with difficulty. Further, the settlements of the several tribes must be by no means conceived as administrative districts after the fashion of the modern canton; and, thirdly, the view that the several tribes had, after a general invasion of the country, their tribal territories allotted by Joshua (as we now read in the book of Joshua) is taken from the most modern, post-exilic, source of the Hexateuch, and stands in glaring opposition to the accounts in other books, according to which the conquest was in the main a peaceful one, and the assimilation with the native Canaanites gradually effected. The tribes which settled to the north of the great plain, especially those on the sea-coast, appear to have been much less successful in keeping free from Canaanitish influence; gradually, however, as the state and religion of Israel grew stronger, Israelitish influence made its way more and more even there. The heart of the country was the central portion later known as Samaria. The opposition between this district and the southern part of the country took shape at an early date. In the extreme south the Simeonites retained their nomadic way of life, and were by degrees mixed up with other wandering tribes. Down into the time of the early kings the dominion of the powerful Philistines stretched far into the centre of the country, and gave the first impulse to a firmer concentration of the energies of Israel. But the Israelites did not succeed in forcing their way in the southern regions down to the sea; in culture and well-established political institutions they were far surpassed by the Philistines. As regards the geography of the Philistine territory, the position of four of their chief

towns, Gaza, Askelon, Ashdod, and Ekron, is known; but it has not been ascertained where the fifth, Gath, was situated, though it must have lain not far from the present Bét Jibrin.—No definite boundaries can be assigned to the Israelitic country to north, south, or west.

Up to the conquest of Jebus the most important city of the southern region was undoubtedly Hebron (see *vol. xi. p. 608*). Clans belonging to Judah had there combined with others of alien origin; and the portions of this tribe which dwelt in the farthest south had become mingled with elements from the tribe of Simeon, while on the other hand the Simeonites acquired certain places in the territory of Judah. In regard to the south country in general, we obtain in the Old Testament the most detailed description of the frontiers, but the reason that we are able to follow it with so much accuracy is that the statements refer exclusively to post-exilic times, though it must be assumed that a certain recollection was still preserved of the original boundary between Judah and Benjamin. The line of the marches of the northern tribes, as indeed this whole system of demarcation, frequently follows the configuration of the ground, but occasionally becomes vague and doubtful. Especially striking is the omission of the districts of Samaria; it seems that at the time of the codification of the system this district was little known to the Judeans. A great deal of trouble has been expended—more especially since the rise of a more scientific exploration of the country—in verifying the old place-names which are known from the Bible, the writings of Eusebius, and the Talmud. The task is rendered much easier by the fact that in Palestine, as in every country where the ethnographic conditions have not been too violently revolutionized, a large number of ancient names of places have been preserved in use for thousands of years, often with only insignificant changes of form—a state of matters to which the continuous existence in the country of Semitic-speaking people has powerfully contributed. The identification of the ancient with the modern names demands none the less thorough historical and philological investigation. Through the labours of Robinson and Guérin we now possess a list of the names in use at least in the country west of Jordan. The list of six thousand names collected during the English survey by Lieuts. Conder and Kitchener is particularly rich,—though it must be borne in mind that the orthography in many cases has not been determined with sufficient accuracy, and that a revision of the collection on the spot by a trained Arabic scholar would be desirable. By the help of this abundant material many of the ancient place-names can undoubtedly be assigned to their localities, and in part at least the direction of the tribal boundaries as they were conceived by the author of the lists preserved in the book of Joshua can be followed. In regard to a large number of places, Joshua leaves us to mere conjecture; and the investigations and combinations hitherto effected are (in the opinion of the present writer) far from sufficient for the construction of such a map of ancient Palestine as the Palestine Exploration Fund has published. The difficulties of the case are further increased by the fact that the ancient localities were at an early date fixed by tradition. An undoubted example of this is furnished by the grave of Rachel between Jerusalem and Bethlehem, the localizing of which goes back to an ancient gloss on *Gen. xxxv. 19*. Even in the case of apparently well-established identifications such as Beitin—Bethel, the question may be raised whether in reality artificial tradition may not have been at work, and ancient Bethel have to be sought elsewhere. Too much care, therefore, cannot be brought to bear on the reconstruction of the ancient geography of Palestine.

It lies beyond the purpose of the present article to enter into the details of the ancient tribal demarcation of Palestine, especially as the tradition, as has been explained, is relatively late and artificial. As an illustration of our view of the subject we may select the boundaries of Judah itself (Josh. xv.). Here the first thing that strikes the reader is that the western frontier as there described for the earliest times is purely ideal, inasmuch as it includes the land of the Philistines. Inconsistencies of view are apparent in the ascription of certain places in Judah to Simeon and of others to Dan. A further difficulty arises from the discrepancies between the Masoretic text and that of the Septuagint in regard to the number of towns belonging to Judah. As regards the southern boundaries described in Josh. xv. 2 *sq.*, the course of the line, in our opinion, cannot be determined with certainty even if it were generally admitted that Kadesh-Barnea is to be fixed at 'Ain Kadis. The determination of the northern boundary is more explicit: it ran from the mouth of the Jordan to Beth-hogla (which is found in Ain el-Hajla). The position of Beth-arabah (Beth ha-Araba) is doubtful; and at least it has not been absolutely settled whether Eben Bohan ben Reuben really corresponds to Hajar el-Asbah. The identification of Debir with Thughrat-ed-Debr may be correct. Gilgal, which follows, is unknown. The ascent from Adummim may correspond with Talat-ed-Dem, which preserves at least an echo of the older name. It is a mere conjecture which places the water of En (Ain) Shemesh in 'Ain Handh. The Fuller's Spring, En Rogel, has in recent times been sought in St Mary's Well; but, with others, we consider Bir Eiyub a more probable identification. The position of the valley of Hinnom and the plain of Baphaim has been determined; Nephtoth corresponds perhaps to the modern Lifta. The places situated on Mount Ephron—Baalah and Kirjath-Joarim—cannot be made out any more than the mountains Seir and Jarim. It may be admitted that Chesalon is Kesla and Bethshemesh is 'Ain Shems, since the direction towards Timnah (Tibna) is imperative. The position of Ekron is ascertained; but it is hazardous to find Shicron in Khirbet Sukereir; and where Mount Baalah was situated we do not know. Finally, Jabnial corresponds to Yebna. From this example it is clear how difficult it is with the existing material to determine the ancient tribal limits, and how necessary it is in such an undertaking to distinguish provisional conjectures from well-established identification. To carry out this task lies beyond the scope of this article; to prove individual points whole treatises require to be written. Compare the articles on the several tribes and the maps.

It has already been remarked that the extension given to the tribal territories in the book of Joshua is frequently the mere reflexion of pious wishes. This holds true in general of the territories of Zebulun, Naphtali, and especially Asher; it is to be particularly remembered that down to a very late date (the time of the Maccabees) the Israelites were almost entirely shut out from the sea-coast. To the north of the land of the Philistines the maritime plain was in the hands of the Phœnicians; the plain to the south of Dor (the modern Tantura) was called Naphoth Dor (hill range of Dor). Even in the New Testament mention is made of a district of Tyro and Sidon to which we must not assign too narrow an extension inland. How matters stood in the country east of Jordan it is hard to decide. The stretch from the north of the Dead Sea to the Yarmuk (practically to the south end of the Lake of Tiberias) was the only portion securely held by the tribes of Israel; here, on the Jabbok, in the centre of the trans-Jordan region, the Gadites had settled; here there was an ancient Israelitic district in the neighbourhood of Mahanaim, Jabesh (on the present Wâdi Yâbis), Succoth, Penuel—places whose position for the most part cannot be determined. From some passages it is evident that the warlike tribe of Gad found it difficult to protect itself against its enemies. Numbers xxxii., a chapter belonging to the older class of sources, throws much light on the conditions under which the country east of Jordan was occupied, and it represents Reuben and Gad as having seized the Moabite territory to the north of the Arnon. We have in this a picture of a temporary extension of the territory of Israel, probably from the time of Omri (compare MOAB).

According to the inscription of King Mesa, the Gadites were still in Ataroth; Dibon, on the contrary, was Moabitic; other towns, such as Kirjathaim, Nebo, Jahaz, had been conquered by Mesa from the Israelites. It is remarkable that the Reubenites are not once mentioned in the inscription. At the date, too, when Isaiah xv.—xvi. were written (before the time of Isaiah himself), the Moabite dominion was widely extended. From all this it may be concluded that the Reubenites had to carry on a protracted struggle with Moab for the possession of the country,—the walled towns being now subject to the one belligerent and now to the other, and the Arnon consequently forming only an ideal boundary. No accurate knowledge of the condition of the settlements of Manasseh in the country east of Jordan has come down to us. The clan Machir had its seat in Gilead; and there, too, were the tent-villages of Jair, a clan which also possessed the district of Argob in Bashan, situated somewhere to the east of the Lake of Tiberias. The Nobah clan was settled in Kenath (the modern Kanawât) on

the western slope of the Hauran Mountains. From these facts it is evident that in the trans-Jordan region north of the Yarmuk and east of the Lake of Tiberias, there were at least a few Israelitic colonies; but they occupied merely scattered points, and thus in this district also the allotment of the country in the book of Joshua must be regarded as a mere pious wish. Other peoples settled in the Hauran, and the ever-advancing Aramaeans soon diminished and absorbed these Israelitic possessions.

The tribes of Israel made a great step in the conquest of the country when, under the early kings, they became subject to a single central government. They were now strong enough to seize many of the walled towns which the Canaanites had hitherto occupied; and their dominion, indeed, extended far beyond the limits of Palestine. Our information in regard to the divisions of the country during the regal period is very defective. The list of Solomon's twelve officers (1 Kings iv.) at least is derived from ancient sources; but it must be observed that, while the boundaries of some of the districts appear to coincide with the tribal boundaries, the political division was not based on the tribal. Nor at a later date was the line of separation between the kingdoms determined simply by the tribal division; the most that is meant is that Judah and Benjamin stood on the one side; of Simeon there is no longer any word. In the account given in 1 Kings xi. mention is only made of one tribe that remained true to David, by which must naturally be understood that of Judah. The limits, in fact, so far as they related to the tribal territory of Benjamin, seem to have varied from time to time; the northern portion as far as Bamaah (1 Kings xv.), or as far as the ravine of Michmasah (Mukhmâs), usually belonged to the northern kingdom, and the same was the case with Jericho. It was to this kingdom of Israel also, with its general superiority in strength and influence, that all the Israelitic districts beyond Jordan were attached. That it consisted, however, of ten tribes (1 Kings xii.) is a highly artificial computation. The small extent of the southern kingdom is evident from a list (if indeed it be trustworthy) given in 2 Chron. xi. of the towns fortified by Rehoboam. As regards the capitals of the northern kingdom, the royal court was originally at Shechem (Nâbulus), from the time of Jeroboam I. at Tirzah (not yet identified), and from the time of Omri at Samaria (Sebastyë); the house of Ahab had its seat for a season at Jezreel (Zer'in) (see vol. xiii. p. 689).

It is rather an historical than a geographical task to describe in detail the boundaries or divisions of Palestine in later times. From the lists for the post-exilic period, found in the books of Ezra and Nehemiah, and containing a series of new topographical names, it is evident that a considerable portion of the old tribal territory of Benjamin as well as of Judah was again peopled by Jews,—on the one hand the places from Jericho to Lydda, on the other a strip to the north of Bethel down to Beersheba in the south. Gradually, however, Edomites (perhaps pressed upon by Nabataeans) forced their way into the southern portion of the country, with the capital Hebron, so that it obtained the name of Idumea.

Before proceeding to the Græco-Roman period it will be well to consider the names by which the country in general was called at different times. Gilead was the centre of the power of the Israelites on the east side of Jordan, and the whole country which they possessed there bore this name. Gilead consequently is opposed to Canaan, the "Promised Land." For the later Hebrews distinguished this western territory as more especially the country which had been promised them, and regarded it as the possession of their national God, and therefore as a holy land. After the separation the more important northern and eastern portion naturally became the land of Israel *par excellence*, while the southern portion ultimately received the name of the individual tribe of Judah (as indeed the northern kingdom was frequently called after the most powerful tribe of Ephraim). The name of the southern kingdom appears in Cuneiform inscriptions as *mât (ir) Ya-u-du (di)*; and it is said that *mât Sir'al* occurs once for the land of Israel, though more frequently it is called *mât Humri* (Land of Omri). Though it has not been absolutely proved that even the Assyrians occasionally included Judah under the designation Palastav or Philista (Philistia), still there is nothing improbable about the supposition. But it cannot be taken for granted that the cis-Jordan country bore the name of land of the Philistines at a time when it was the scene of a great development of the Philistian power; the name was rather, as so often happens, extended by their neighbours from Philistia proper to the country beyond, and from the Egyptians it passed to the Greeks. In the Old Testament Peleshet is still always restricted to the Philistine coast-plain; the same is the case in Josephus; and in Herodotus, though the usage is not very explicit, Palestine appears usually to have no wider application. Gradually, however, the designation Palæstina Syria, or simply Palæstina, got into vogue, and was made to include even the country east of Jordan, and consequently the whole territory between Lebanon and Sinai.

We now return to the divisions of Palestine. Already in the book of Kings (that is, by the time of the exile) the name Shomeron (Samaria) is applied to the territory of the northern kingdom, for mention is made of the "towns of Samaria." In the



apocryphal books of the Old Testament, Judæa and Samaria (*Σαμαρεία, Σαμαρία, Σαμαρία*) are opposed to each other; but the limits of the two divisions at the time of Christ, and for centuries previously, can hardly be laid down. Thus in Josephus the Mediterranean coast as far as Acra is assigned to Judæa; towards the south this country was bounded by Idumæa; in the north it extended to about 3 miles to the south of Nâbulus (Shechem). Whether Samaria extended from the Jordan to the sea is uncertain; in the north it reached the southern edge of the plain of Esdraelon, the frontier town being 'En Gannim (Jennin). Galilee (in regard to which see vol. x. p. 27) was originally the district in the neighbourhood of Kedæa, afterwards distinguished as Upper Galilee. The Jewish population was there largely mixed with Phœnicians, Syrians, Greeks, and even Arabs. The whole maritime region to the north of Dor was still called Phœnicia in the time of the Romans, and thus does not strictly belong to Palestine in our sense of the word. Along the coast, as well as more especially in the north of the country, numerous Greek colonies were established; how strong the foreign influence must have been in Samaria and Galilee is evident from the preservation of so many Græco-Roman names like Neapolis (Nâbulus), Sebaste (Sebastiye), Tiberias (Tabariye). Elsewhere too, in the south for example, the old nomenclature was altered: Zelia was substituted for Jerusalem, Azotus formed from Ashdod, and so on; but the old names were always retained in the mouth of the people. The north of the country and the trans-Jordan region were much more thoroughly brought under the influence of the Greeks and Romans than the south. The Greek towns in some cases date from the time of Alexander the Great, and others were founded by the Ptolemies; but most of them owe their origin to the Seleucids. One district of the trans-Jordan region retained at that period its old name in the Greek form of Perea. Josephus says that this district extended from the Jordan to Philadelphia (Rabbath Ammon, 'Ammán and Gerasa (Jerash), went southward as far as Machærus (Makar on the Zerka Ma'in), and north as far as Pella (Fâhil opposite Beisan). Adjoining Perea, and mainly to the east of Jordan, lay the Decapolis, which was not, however, a continuous territory, but a political group of cities occupied by Greek republics distinguished from the tetrarchies with their Jewish-Syrian-Arabic population in the midst of which they were scattered. The largest of these cities was Scythopolis (Beisan); others were Hippos, Gadara (Mkés), Philadelphia, Dion, Gerasa, &c.; but ancient authorities do not agree about the names. Little requires to be said about the division of the country in later Roman times. In the 6th century a threefold partition began to prevail:—Palestina Prima (roughly equal to Judæa and Samaria), Palestina Secunda (the countries about the upper Jordan and the Lake of Gennesaret), and Palestina Tertia or Salutaris (Idumæa and Moab). In the time of the crusades the same names were applied to three divisions (at once political and ecclesiastical) of the country west of Jordan,—Palestina Prima or Maritima being the coast region as far as Carmel (with Caesarea as its archbishop's see), Palestina Secunda comprising the mountains of Judah and Ephraim (with the patriarchal see of Jerusalem), and Palestina Tertia corresponding roughly to Galilee (with its bishop's see at Nazareth). The country east of Jordan was called Arabia, and was in like manner divided into three parts lying north and south of each other.

The Arabians retained the name Filistin, and they divided the country into two principal portions,—the Jordan district (chiefly the northern parts) and Filistin proper, which extended from the Lake of Gennesaret to Aila and from Lejjûn to Rafah. Under the Turks Palestine was till quite recently subject to the governor of Syria; the greater part of it now forms an independent vilayet. The chief districts are (each with its town) Gaza, Hebron, Yâfa, Ludd (with Ramla), Nâbulus, Sha'rawiye, Jennin (with Beisan), Haifa, Acra, Tabariye, Nâsira, Safed; and in the country east of Jordan 'Ajlûn, Belkâ es-Salt, Kerak, and Maân.

Palestine is by no means so strikingly a country apart as is usually supposed. It lay, as already mentioned, near the great military highway from western Asia to Egypt and Africa. The traffic by sea was also formerly of importance; and even in the Middle Ages something was done for the protection of the harbours. At no time, however, was the country in the proper sense of the word a rich one; it hardly ever produced more than was necessary for home consumption. The great trading caravans which passed through were glad for the most part to avoid the highlands, and that region at least was thus more or less isolated. The following is a brief survey of the principal routes, partly as they formerly existed, and partly as they are still used. From Egypt a road runs by El-'Ariah (Rhinocoloura) or "the river of Egypt" by Rafah (Raphia) to GAZA (q.v.). From Gaza another runs by Umm Lâkis (Lachish) and Bêt Jibrin (Eleutheropolis) across the mountains to Jerusalem. Northwards from Gaza the main route continues along the plain at some distance from the sea (which in this part has piled up great sand dunes) to El-Mejdel (Migdal Gad) near Askelon, and so on to Ashdod (Ezdud, Azotus). From Ashdod a road runs by 'Akir (Ekron) to Ramle, an important town in the mediæval Arabian period, and Ludd (Lôd, Lydda). From these towns, which are con-

nected with the port of Yâfa (Japho, Joppa), three routes run to Jerusalem, of which the one most used in antiquity was evidently the northern one passing by Jimzu (Gimzo) and the two Bêt Urs (Beth-horon), and not the one now followed by 'Anwâs (Nicopolis) and Wâdi 'Ali. From Yâfa a road continues along the coast by Arsûf (Apollonia) to the ruins of Kaisariye (Caesarea), then past Tantura (ruins of Dor) and 'Athlit (Castellum Peregrinorum of the crusaders) and round the foot of the promontory of Carmel, to Haifa and Acra (a town of great importance from early times). Another route starting from Ludd runs north close to the mountains by Antipatris (now Kafr Saba or Râs el-'Ain f) and Kakin, and ends at Khân Lejjûn. The Great Plain offered the easiest passage from the coast inland. El-Lejjûn (a corruption of the Latin *Legio*) was certainly an important point; it is still conjecturally identified, according to Robinson's suggestion, with the ancient Megiddo, which Conder would rather place at Mejedde'a. In the vicinity lie the ruins of Ta'anuk (Ta'ansch), and farther south-west the great centre of Jennin ('En Gannim, Ginnas). From Acra there also runs a road directly east over the mountains to Khân Jubb Yâsuf.

The coast road from Acra northwards passes through Zib (Akhzib, Kodippa) and the two promontories of Râs en-Nâkûra and Ras-el-Abyad (Scala Tyrionum), and so continues to the maritime plain of Tyre.—To return to the south, from Egypt (Suez, Arsinoe) the desert was crossed to Ruheibe (Rochoboth), Khulasa (Elusa), and Bir-es-seb'a (Beersheba), and from this place the route went northward to Ed-Dhoheriye and El-Khalîf (Hebron). In like manner a road from Aila up the Araba valley crossed the Es-Sufâf pass to Hebron.—One of the most frequented highways traverses the central mountain chain northwards, and, though somewhat difficult in various parts, connects a number of the most important places of central Palestine. Starting from Hebron, it runs past Rama and Hulhûl through the Wâdi el-Biyâr, and leaving Bethlehem on the right holds on to Jerusalem, where a branch strikes east by Khân Hadrûr (probably there was once another route) to Jericho. From Jerusalem northwards it naturally continues by Sha'fat past Er-Râm (Rama) to El-Bîre (Beeroth), and then onwards by 'Ain el-Haramiye, Sinjil, and Khân Lubbân through the Mukhna plain to Nâbulus (Shechem). From this point a route runs down to the Jordan and Es-Salt (Ramoth Gilead f); another passes by Tubâs (Thebes) north-eastward in the line of the Jordan valley to Beisan (Bethshean, Scythopolis). The road across the highlands passes a little to the east of Sebastiyè (Samaria, Sebaste), running along the west side of the Merj el-Ghuruk and past Tell Dothan (Dothan) to Jennin. Thence the road northward to Nazareth skirts the east side of the plain of Esdraelon, and from Nazareth a path strikes to Acra. The caravan route proper passes from 'Afile north-eastwards past Jebel et-Tûr (Tabor) to Khân et-Tujjâr (where several roads cross), and reaches the Lake of Tiberias near Mejdal (Magdala). It keeps by the shore only for a short distance. Having traversed the small plain of Gennesar, it begins again to climb the mountains where they approach the lake at Khân Minye (which, however, for many reasons cannot be Capernaum), and then it goes on to Khân Jubb Yâsuf, strikes down again into the valley of the Jordan, and crossing the river at Jîr Benât Ya'kûb holds on across Jebel Hish to Damascus. The mountain district of Samaria is crossed by a great number of small roads, but none of them are true caravan routes or worth particular mention. An old caravan route once ran northwards up the Jordan valley from Jericho to Beisan; and from Beisan an important, now less frequented, road crossing the river at the bridge El-Mejâm'a struck north-east to Fik Tsèil and Naws in the Haurân, and finally to Damascus.—In the country east of Jordan a great highway of traffic ran from Petra (or really from the Elanitic Gulf) by Kerak (Kir Moab) to Rabba (Rabbath Moab, Areopolis); in front of Aroer ('Arâr) it crosses the Mójib (Arnon) and runs northwards through the highlands to Hesban (Heshbon) and thence to 'Amman (Rabbath Ammon, Philadelphia). A route also led from Jericho to Es-Salt (which could also be reached from Hesban) and thence northwards to the Jabbok and Jerash (GERASA, see vol. x. p. 441); and then from Jerash one stretched north-west by Tibne to Mkés (Gadara) and the valley of the Jordan, and another north-east to the Zumle and the Hauran or more precisely to Bosra (Bostra), and so on to Damascus. It must also be mentioned that the great pilgrim's track direct from Damascus to Medina and Mecca skirts the eastern frontier of the country. A great many roads await more detailed investigation; what has been said may suffice to show what lines of communication existed and still exist between the more important places of Palestine.

Population.—There are no trustworthy estimates of the number of inhabitants in the country at any period of its history. Certain districts, such as Galilee, have, there is no doubt, from early times been much more populous than certain other districts; the desert between much more populous than certain other districts; the desert of Judah and some portions of the country east of Jordan must all along have been very sparsely peopled. The figures given in the book of Numbers indicate that the whole country contained about 2½ million souls,—it being assumed that the statistics do not refer to the time of the wandering in the wilderness, and that the details

may be suspected of being artificially adjusted. The number 2½ to 3 millions may indeed be taken as a maximum; the population can hardly ever have been more than four times its present strength, which is estimated at 650,000 souls. Thus, in the most flourishing period, about 250 to 300 inhabitants would go to the square mile, while at present there may be about 65, a number which is rather above than below the mark. Lists based on information collected by the Turkish Government give much lower figures, viz., for the sanjak of Jerusalem (with the districts Jerusalem, Yáfa, Hebron), 276 places with about 24,000 houses (families); for the sanjak Balqa (with the districts of Nábulus, Jennin, Ajlun, and Es-Salt), 317 places and 18,984 houses; for the sanjak Akka (Acre) (with the districts 'Akka, Haifa, and Safed), 160 places with 11,028 houses,—making a total of 753 places with 54,237 houses. Reckoning five persons per house, this gives a population of 271,185, exclusive of the small number of Bedouins. Detailed statistics there are none as regards the relative strength of the Bedouin element and the peasantry, the numerical representation of the different religions, or any matter of this sort.

The ethnographic-geographical sketch given above has shown how the population of Palestine even at an early date was a very mingled one; for even when they arrived in the country foreign elements were present among the Israelites, and later on they absorbed or were absorbed by the Canaanites. The Philistines, Moabites, and others in course of time were merged in the new nationality. From the period of the exile colonies from the east settled in the country, and so powerful did the Aramæan contingent gradually grow that Aramæan became the popular tongue. Next were added Greek and Roman colonies. The Arabic element exerted considerable influence even before the days of Islam; with the Mohammedan conquest it became the dominant power, though it was only by slow degrees that it obtained numerical superiority. The Arab tribes transplanted to Palestine their old distinctions, especially that between Northern and Southern Arabs (Kais and Yemen; cf. ARABIA). The Arab peasantry is still divided into clans; for example, the districts of the Beni Hasan and Beni Malik to the west of Jerusalem, those of the Beni Hârith, Beni Zaid, and Beni Murrâ to the north, and that of Beni Sâlim to the east. Till recently the relations of the separate clans of fellahin was one of mutual hostility, and, unhindered by the Turkish Government, they engaged in sanguinary conflicts. In manners and in language (though Arabic is universally in vogue) the Palestine peasants retain much that is ancient. It is extravagant, however, to maintain from the traditions they preserve that primeval Canaanite elements still exist among them. The prevalent type, in fact, is Syro-Arabic, or in many districts pure Arabic; and their superstitious customs are partly remains of Syrian beliefs, partly modern Arabic reproductions, under similar external conditions, of ancient superstitions. These remarks are applicable to the saint worship at present spread through the whole Oriental world. The fellahin are on the whole a diligent frugal race, not destitute of intelligence. If well treated by a just Government which would protect them from the extortions of the nomadic tribes, they would be the means, with the assistance of the capitalist, of greatly improving the cultivation of the country, especially in the various lowland districts. They choose their own village sheikhs, who derive most of their authority from the reputation of their virtues, their bravery, and their liberality. The Bedouins, i.e., wandering tribes of pure Arab origin, also play an important part in the country. Till quite recently they used to visit certain settled districts and exact black mail from the peasants; and they find their undisputed domain in those districts which are incapable of cultivation, and fit only for cattle rearing, and in other fertile portions which for various reasons are not occupied by the husbandman. To the first class belong the belt of desert to the west of the Dead Sea, the southernmost parts of the country west of Jordan and the south country beyond the river (Moab); to the second belong the greater portion of the maritime plain, the depression of the Jordan valley, and part of the country to the east. The divisions of the Arab tribes will be discussed in the article SYRIA. In Palestine east of Jordan the Beni Sakhr (Moab) are of most importance; Jebel 'Ajlûn is the seat of the 'Adwân. The Ghawârîne (the inhabitants of the Ghor or Jordan depression) form a peculiar race which, as they are partly agricultural, have been a long time settled in the district. In type, as well as by their degeneracy, they are distinguished from the other Bedouins. The true Bedouin style of life can be studied only beyond the Jordan or to the south of Palestine,—the tribes west of the river, such as the Tâ'âmîre and Jehalîn in the south being all more or less deteriorated. As the Turkish race does not fall to be treated in connexion with Palestine, it simply remains to mention the Frankish (European) elements. During the Middle Ages these were not unimportant, especially along the coast; numerous ruined churches are still to be seen as the last and only memorials of crusaders' colonies (see Vogüé, *Les églises de la Terre Sainte*, Paris, 1860, and the article SYRIA). Nor must the missionary efforts be forgotten which in our own times have been again specially directed to Palestine. As regards the Roman Catholic Church, the Francis-

ans have maintained their position in the Holy Land even in troublous times, and have not only established schools and printing presses but protected the Christian sanctuaries and taken care of pilgrims and travellers. On the whole it may be said that, in comparison with that of the Roman and Greek Churches, the influence of Protestants is outwardly small. A German sect called the Templars settled in Palestine some years ago, and has now colonies at Yáfa, Sarona, Jerusalem, and Haifa. The colonists, about 1000 in number, have to contend with many and grievous difficulties, and are deficient in capital. Wine-growing is the most lucrative branch of their activity. As long as the Turks hold rule over the country successful colonization is hardly possible.

*Literature.*—The literature in regard to Palestine is extremely abundant. As bibliographical guides of the first class may be mentioned—Tobler, *Bibliographie palæstinæ*, Leipzig, 1869 (a supplement to this appeared in Fetscher's *Neuer Anzeiger für Bibliologie und Bibliothekswissenschaft*, Dresden, 1878). The works published between 1867-77 (with additions to Tobler) will be found in Rihricht and Meisner's *Deutsche Pilgerreisen nach dem Heiligen Lande*, Berlin, 1880 (pp. 547-648). Soehs has given an annual survey of current literature from 1877 in the *Zeitschr. des Deutschen Palæstina-Vereins*. Compare also *Archives de l'Orient Latin*, I, Paris, 1881. The series of old pilgrimages published by the Société de l'Orient Latin deserves special mention:—*Itinera Latina belis sacris antiora*, Geneva, 1879; *Itinéraires à Jérusalem et descriptions de la Terre Sainte*, etc., in *français*, nos. XI-XLIII, etc., Geneva, 1882. Original studies on the geography and ethnology are *Observations sur un locorum Sancta Scriptura* (edited by Larow and Parthey, 1862, and De Lagarde, 1870); Neubeauer, *La géographie de Palmyra*, Paris, 1868; Hadr. Beland, *Palæstina monumentis veteribus illustrata*, 3 vols., 1774; Ritter, *Vergleichende Erdkunde*, vol. xv.-xvii., Berlin, 1840-55; K. Hammer, *Palæstina* (4th ed., 1870; now to be completely remodelled by Farrar). Strictly scientific accounts of travel begin only in the present century; the credit of having led the way belongs to E. Robinson (*Biblical Researches in Palestine*, 1841; *Second Biblical Researches*, 1852; *Physical Geography*, 1856). Of importance is the voluminous work of V. Guérin, *Description géographique, historique, et archéologique de la Palestine*, 1868, sq. Splendid service has been rendered by the American Exploration Fund, which has published *Quarterly Statements* since 1849—the labours of Wilson, Warren, and Conder being particularly noteworthy. In 1880 appeared Conder and Kitchen's *Map of Western Palestine* (36 sheets), the result of surveys extending over many years; an edition in six sheets was published in London in 1881. Trelawney Sandars's *Special Edition Illustrating the Distances over the Mountains*, 1882, is to be recommended (compare his valuable *Introduction to the Survey of Western Palestine—its Waterways, Plains, and Highlands*, 1881); but the same cannot be said about the *Special Edition* of the map illustrating the Old Testament and that illustrating the New Testament, London, 1883 (each six sheets), many of the identifications resting on mere provisional conjecture. As companions to the great maps we have *Memoirs of the Topography, Orography, Hydrography, and Astrology* (3 vols.), a *Flora-Les* (1 vol.), *Special Papers* (reprinted from the *Statements*, 1 vol.), *Jerusalem* (1 vol.), *Flora and Fauna* (3 vols.). The Exploration Fund is preparing to accomplish a similar work for the country east of Jordan, since the American Society, which was to have undertaken the survey of that region, has relinquished the undertaking (compare also Schah Merrill, *East of the Jordan*, New York, 1861). The German Palæstina-Verein has published its *Zeitschrift* since 1874, a yearly volume of topographical and historical investigations on definite points. Guide-books which may partly serve as works of reference are—*Baedeker's Palestine and Syria* (written by Soehs, 1876), Murray's *Handbook for Travellers in Syria and Palestine* (by Porter, 1876), and Joazeiro's *Guide* (new edition, 1882). The best illustrated work is *Picturaeque Palæstina, Syria, and Egypt* (edited by Colonel Wilson, &c., London, 1881), to which may be added D. Roberts, *The Holy Land, and Loretto, La Syrie d'aujourd'hui*, 1884. W. M. Thomson's *The Land and the Book*, London, 1881-83, is of particular value for manners and customs. For natural history, see Tristram, *The Land of Israel* (London, 1861) and *Natural History of the Bible* (London, 1878). Latest geological investigations will be found in De Lapparent, *Explication à la Mer Morte*, etc., Paris, 1876. For matter of geographical detail consult especially Tobler's works (*Bethlehem; Nazareth; Dritte Wanderung*, &c.). Wilson, *The Lands of the Bible*, Edinburgh, 1847; Conder, *Fest Work in Palestine*, 1878; and Flin, *Spawys in Palestine*, London, 1868, may conclude the list. Menka's *Historischer Atlas* (Gotha, 1868) is still the best. (A. 50.)

#### PALESTRINA. See FRÆNESTE.

PALESTRINA, GIOVANNI PIERLUIGI DA (c. 1524-1594), now universally distinguished by the honourable title *Princeps Musica*, occupies a more important position in the history of art than any other composer, ancient or modern; for it is to his transcendent genius that music is indebted for its emancipation from pedantic trammels, which, ignoring beauty as its most necessary element, were fast tending to reduce it to the level of an arithmetical problem.

The exact date of Palestrina's birth is unrecorded. It most probably took place in 1524, and certainly at Palestrina (the Fræneste of Roman geographers,—whence the style accorded to him in Latin<sup>1</sup>). Some early writers call him Gianetto da Paleatina, or simply Gianetto; and this early custom—which has led some modern critics to mistake his identity—combined with the general use of his Christian names only, has induced the belief that he was of peasant origin; but Signor Cicerchia is said to have discovered at Palestrina documents proving that his father bore the family name of Sante, and his mother that of Gismondi,—in which case he must have been of gentle birth. The statement, however, needs confirmation.

<sup>1</sup> Joannes Petrus Aloysius (or Petraloyus) Frænestinus.

In early youth Palestrina studied at Rome in company with Animuccia, and, perhaps also, Giovanni Maria Nanini, in a music-school founded by GOUDMEL (*q.v.*). After this, we hear no more of him until 1551, when, by favour of Pope Julius III., he was elected Magister Cappellæ and Magister Puarorum at the Cappella Giulia, S. Pietro in Vaticano, with a salary of six scudi per month, and a house. Three years later he published his *First Book of Masses*, dedicated to Pope Julius III., and beginning with the *Missa "Ecce Sacerdos magnus,"* concerning which we shall have to speak more particularly hereafter.<sup>1</sup> On January 13, 1555, Palestrina was enrolled, by command of Pope Julius III., among the singers of the Cappella Sistina. This honour involved the resignation of his office at the Cappella Giulia, which was accordingly bestowed upon his friend Animuccia. But the legality of the new appointment was disputed on the ground that Palestrina was married, and the father of four children, his wife, Lucrezia, being still alive; and, though, for the moment, the pope's will was law, the case assumed a different complexion after his death, which took place only five weeks afterwards. The next pope, Marcellus II., was succeeded, after a reign of twenty-three days, by Paul IV.; and within less than a year that stern reformer dismissed Palestrina, together with two other married singers, Ferrabosco and Bari, with a consolatory pension of six scudi per month to each. This cruel disappointment caused Palestrina a dangerous illness; but better fortune was in store. In October 1555 he was appointed Maestro di Cappella at the Lateran, without forfeiting his pension; and in February 1561 he exchanged this preferment for a similar one, with an allowance of sixteen scudi per month, at Santa Maria Maggiore.

Palestrina remained in office at this celebrated basilica for ten years; and it was during this period that the most critical event in his life took place—an event of such grave importance that its results have never ceased to furnish matter for discussion to the musical historian from the time of its occurrence to the present day.

In 1562 the council of Trent censured the prevalent style of ecclesiastical music with extreme severity. In 1564 Pope Pius IV. commissioned eight cardinals to investigate the causes of complaint; and these proved to be so well founded that it was seriously proposed to forbid the use of all music in the services of the church, except unisonous and unaccompanied plain-chant—a proceeding which, so far as the church was concerned, would have rendered the "art of music," properly so called, a dead letter, not only for the time being, but in perpetuity, for the decree, once promulgated, could only have been repealed by another general council.

It is evident that very gross abuses must have been needed to justify so stringent a measure as this in the eyes of men accustomed to regard art as the obedient handmaid of religion; yet, strange to say, the nature of these abuses has never yet been clearly established by any musical historian, either English or foreign. Baini devotes several chapters of his great work<sup>2</sup> to their discussion, but without arriving at any definite conclusion. Burney and Hawkins seem to have regarded the question as one involving no deeper significance than a more or less exalted standard of artistic purity. Ambros, generally so reasonable a critic, denies the existence of any just ground of complaint at all, even in the limited sense claimed by Burney and Hawkins, and condemns the severer censures of Baini and his followers as attempts to substantiate a groundless myth. Bernsdorf speaks little less strongly, simply because a certain tradition, which represented the circumstances as having taken place in 1555, during the short reign of Pope Marcellus II., has been proved to be certainly false. That more than one groundless myth has been substituted for the real

account of the occurrence is true enough—one, at least, involving an anachronism of no less than twelve centuries. But no sober historian has ever credited these absurd stories; and it is not to them that Baini gives currency or that Ambros objects. The misfortune is that each successive narrator has perpetuated the vague statements of his predecessors, instead of seeking for information at original sources; and this mistaken course has resulted in an infinity of oracular utterances, no two of which agree. To conflicting opinions like these, one only form of answer is possible—that furnished by contemporary documents. Fortunately, an immense amount of church music, written in the style universally cultivated at the period of which we are treating, has been preserved to us both in MS. and in print; and, though the forms of notation employed by its transcribers are no longer in common use, students of mediæval music are able to decipher them with absolute certainty. Objections like those raised by Ambros can therefore be met by reference to examples of the music actually sung at the time the council of Trent condemned the then prevailing style.

The first impression derived from the study of these venerable records tends to confirm a statement already made, to the effect that the art of music was rapidly degenerating into a mere system of figures. There is evidence enough to prove the existence, from the 14th century downwards, of a growing tendency to cultivate, at the expense of ideal beauty, certain forms of technical ingenuity worthy only of association with a clever conundrum. A canon which could be sung upside down, as well as backwards and forwards, was more highly esteemed than one that could be sung backwards and forwards only. The amount of skill and learning wasted on the construction of such canons was almost incredible; and equally so was the puerility of the conceits with which men known to have been profound scholars endeavoured to give an additional zest to their strange inventions. When the construction of a canon, often written in the form of a cross or a rainbow, was so complicated that it was almost impossible to find out how to sing it, they hinted at the secret by means of a motto as obscure as the music itself. In one instance, *Responde me, ascende in tibi faciem tuam*, indicates that two singers are to hold the music between them, each reading it upside down from the other's point of view. In another, *Justitias in Pava occultatas sunt* intimates that two singers are to begin simultaneously at opposite ends of the music, singing all the notes in correct time until they meet in the middle. In a third case, *Βερεγγος δε Ξεργίος* means that a certain voice is to be silent—in allusion to *Ælian's* assertion that the frogs on the island of Seriphus do not croak. We do not say that all the music of the period was of this character; but a multitude of such examples, written by the most celebrated musicians of the Middle Ages, have been preserved to us, and most of them are adapted to the words of the Mass. Surely the council had just right to complain of this.

Another still more serious abuse consisted in the introduction, among the words of the Mass, of foreign passages having no connexion whatever with the original text,—one voice being made to sing "Alleluia" or "Ave Maria," while others were singing the words of the "Credo" or the "Sanctus."

In order to justly appreciate the true bearing of this very prevalent abuse, it will be necessary for the English Church composer to divest himself of certain not very unnatural prejudices,—and, first of all, of the idea that the custom implied intentional irreverence on the part of those who introduced it, which, in spite of appearances, it certainly did not. In England the music sung forms an essential part of the service. This is not the case with the Mass. In reciting the prescribed form of words with the prescribed ceremonies, the officiating priest fulfils unaided all the necessary conditions of the service, while the congregation looks on and worships, and the choir endeavours to excite its devotion by singing appropriate music. As a matter of fact, the words to which this music is set are identical with a portion of those recited by the priest; but they represent no essential element of the service, nor are they for the most part sung at the same time that the priest recites them. Except in the delivery of a few responses, the action of the choir is entirely independent of that of the priest; and the action of the congregation is independent of both. Each member of it may use any book of devotions he pleases, and he will generally be careful to use prayers and meditations suitable to the festival in which he is taking part. For instance, at Christmas he will meditate on the nativity of our Lord, at Easter on His resurrection,—continuing his meditations on these subjects, without reference, during the greater part of the mass, to the words the priest is reciting. It is only by bearing these facts carefully in mind that we can rightly understand what is to follow.

The mediæval composer very rarely constructed his Mass upon an original subject. His favourite plan was to select as his principal theme a fragment of some well-known plain-chant—hymn or antiphon, and from the words proper to this melody—technically called the *cento fermo*—the Mass was named. We

<sup>1</sup> The first edition of this was printed in 1554; the second—with a title-page representing Palestrina offering his music to the Pope—in 1572.

<sup>2</sup> *Memorie storiche-critiche della vita e delle opere di Giovanni Pierluigi da Palestrina*, Rome, 1828.

still possess countless examples of the *Missa* "Æterna Christi munera," the *Missa* "Vidi turbam magnam," "Repleatur os meum," "Dum complentur," "Iste Confessor," and others of like character, all named after the *cantus fermi* on which they are based, though, except in a few comparatively rare cases to be presently mentioned, the words proper to the *cantus fermi* do not appear in the work, the selected melody being adapted to the actual words of the *Missa*. And thus far the custom was not only an unobjectionable but a thoroughly commendable one; for the melodies employed were familiar to every educated member of the congregation, and to these the sound of the well-known tune must necessarily have suggested the sacred words belonging to it, and that so powerfully that the performance on Christmas Day of a *Missa* founded on the melody of "Hodie Christus natus est," or on Whitsunday of one based on that of "Veni, Creator Spiritus," could scarcely have failed to induce in the minds of the assembled worshippers the exact train of meditation most desirable on these great festivals.

Had composers been contented with this, all would have been well. But unhappily they were tempted to add the extraneous words; and their intention, in doing so, has been grossly misrepresented. They have been accused of wilfully sacrificing sense to sound, with the unworthy object of displaying their technical skill to greater advantage. At the first blush there may seem some truth in this; but here again the strictures will not bear examination in presence of the actual records.

Nearly a century before the birth of Palestrina, Joannes de Tinctoris—the compiler of the earliest known *Dictionary of Musical Terms*—wrote a *Missa* in which one voice interpolated the words here printed in italics, while the others sang the authorized text, exactly as it appears in the *Missa*:—

*Chorubin as seraphim extergens spiritus impedit Deo in altissimis incessabiliter oret proclamans, Sanctus, Sanctus, Sanctus, Dominus Deus Sabaoth. "Pueri Eboracorum sternentes vestimenta ramos palmarum Jezu Nro David clamabant Oseana in excolesia." "Benedictus semper sit Nrius Altissimi, qui de cœlis huc venit in nomine Domini."*

Clearly this is nothing more than an amplification of the received version—a reverent commentary upon the words actually recited by the priest. In what way can the addition of these extraneous sentences conduce to the display of the composer's musical learning? He might just as easily have set the same notes to the unaltered text.

Again, Palestrina himself begins his *Liber primus Missarum*, already mentioned, with a *Missa* for which he has chosen, as a *canto fermo*, the entire melody of the gradual, "Ecce Sacerdos magnus," sung on the festivals of certain great doctors of the church, such as Ambrose and Athanasius,—one voice being constantly employed in the reiteration of this in long, slow notes, sung to its own proper words, while three others sing the authorized text in the usual way. What object could possibly have tempted the composer to arrange his music thus, other than that of using the familiar words and tune as a means of reminding his hearers of the great work wrought by the saints whose festival they are commemorating? Palestrina was the last man in the world to have paraded his learning; and, had he wished to call attention to it, he might have done so in a hundred easier ways. Indeed, if the *Missa* were to be sung to-morrow, nothing would be easier than to fit the words of the *Missa* to the notes of the *canto fermo* throughout. Still, notwithstanding the innocence of the composer's intention, there can be no doubt that the custom was a highly reprehensible one; and it led to something very much worse.

The troubadours and minnesingers of the Middle Ages produced a host of beautiful secular melodies, many of which still live among us in the guise of "national airs," though the names of their authors have been forgotten for ages. The beauty of many of these melodies tempted composers to select them as *cantus fermi* for their *Messes*; and not a few such works were actually named after them, as the *Missa* "L'Homme armé" (a very common example), the *Missa* "Mon œneur se recommande à vous," and many others. And in this the mediæval musician had no more thought of intentional irreverence than had the Flemish painter when he represented the Nativity as taking place in a little roadside hostelry like that to which he was accustomed to resort for his evening meal. But he committed a grave error of judgment. For, just as the sound of the sacred *canto fermo* brought to remembrance the words with which it was connected, so, we may be sure, did that of the secular one; and the greater its beauty the more surely would it do its evil work. It was by its beauty alone that it attracted the composer; yet his treatment of it proves beyond all doubt that he meant no evil. This, however, is the last stage of our history at which we can acquit him of it; and perhaps even here we may have strained the point a little too far.

As might naturally have been expected, the introduction of the secular *canto fermo* was followed by exactly the same results as that of the sacred one. It took a longer time to bring about the evil, but it came at last. The familiar words were sung to the familiar notes, not by the will of the composer, who would never have dared to insert them, even had he wished to do so, but by that of profane singers, who surreptitiously trolled them forth for the

gratification of a prurient taste, while the great body of the choir adhered to the sacred text. And, in the face of these undeniable facts, Hawkins calmly speaks of the reform as one of style only, while Ambros, intoxicated by the beauty of so much of the music preserved to us, and especially by the compositions of Claude Goudimel, for whom he entertained a well-founded admiration, tells us, in so many words, that no reform of church music was ever needed or demanded, and that no such reform as that popularly attributed to the influence of Palestrina ever took place.

Two of the commissioners, however,—Cardinals Borromeo and Vitellozzi,—while admitting the urgent need of reform, pleaded for a compromise, and happily the commission agreed to postpone its final decision until Palestrina—already recognized as the greatest composer then living—had been permitted to prove, if he could, the possibility of producing a *Missa* which should not only be free from the abuses complained of, but should also conduce to the excitation of true devotional feeling by bringing the plain sense of the words into the strongest possible relief, and that so manifestly that it might be presented to all future composers as the pattern of what true ecclesiastical music ought evermore to be.

A careful comparison of Palestrina's works with those of the best of his contemporaries conclusively proves that in him alone were united all the qualifications necessary for the success of this difficult attempt, which demanded the earnestness of a deeply religious mind, the science of a profoundly learned musician, and the refined taste of an artist whose sense of beauty was strong enough to overcome all desire for the display of technical power at the expense of that delicacy of expression without which the required solemnity of style would have been unattainable. Animuccia lived as holy a life as Palestrina. The elder Nanini, if not so learned a musician as he, was at any rate more learned than by far the greater number of his contemporaries. But the world had yet to learn how far refinement of taste could be carried in the composition of sacred music; and upon Palestrina devolved the duty of teaching it its lesson. Ockenheim had already astonished it by the ingenuity with which he evolved from the contrapuntal materials at his command a form so symmetrically proportioned that it seemed as if no future artificer could add to its perfection<sup>1</sup>; but the materials were dry bones, and the resulting form no more than a wonderfully articulated skeleton. To the erudition of Ockenheim Joaquin Deprés united the fire of true genius. To him we are indebted for many, if not most, of the finest works produced before the age of Palestrina.<sup>2</sup> Yet even he could do no more than clothe Ockenheim's bare skeleton with flesh. It remained for Palestrina to breathe into the perfect body the breath of that artistic life which alone could enable it to give thanks to the Creator of all things in tones which betokened the presence of the soul within it. He first taught the world that music was not a mere lifeless collection of notes,—that, as the gift of speech enabled man to express his thoughts to his fellow-man, so the gift of harmony enabled him to express his feelings, whether of devotion, or praise, or prayer, and this so intelligibly that he might "sing praises with understanding" in the truest sense of the words. And it was to the decree of the council of Trent that he was indebted for the opportunity of showing how great a work it was possible to accomplish in this direction, as well as for the means of accomplishing it with such good effect that to this day the results are apparent in every church in which true ecclesiastical music is sung.

Dreading to trust the issue of so severe a trial to a single work, Palestrina, with characteristic modesty, submitted

<sup>1</sup> For examples, consult the *Dodecachordon* of Glafianus, and Petrucci's *Odhecaton* and *Cantus C. No. cento cinquanta*.

<sup>2</sup> See two extremely rare volumes of his *Messes* in the library of the British Museum.

three Masses to Cardinal Carlo Borromeo for approval. These were privately rehearsed, in presence of the commissioners, at the palace of Cardinal Vitellozzi; and, while warmly admiring them all, the judges were unanimous in deciding that the third mass fulfilled, in the highest possible degree, all the conditions demanded. The private trial took place in June 1565; and, on the 19th of that month, the Mass was publicly sung at the Sistine Chapel, in presence of Pope Pius IV., who compared its music to that heard by St John in his vision of the New Jerusalem. Thenceforth it was formally accepted as the type of all true ecclesiastical music. Parvi transcribed it, for the library of the choir, in characters of extraordinary size and beauty; and, in acknowledgment of his services to art, Palestrina was appointed by the pope composer to the Sistine Chapel, an office created expressly in his honour, and confirmed to him by seven later pontiffs, though with the very insufficient honorarium of three scudi per month, in addition to the six which formed his pension.

In 1567 this Mass was printed in Palestrina's *Liber secundus Missarum*. The volume was dedicated to Philip II. of Spain, but the Mass was called the "Missæ Pape Marcelli." This title, clearly given in honour of the short-lived pope Marcellus II., has given rise to an absurd story, told by Pellegrini and others, to the effect that the Mass was composed by Pope Marcellus I., martyred early in the 4th century, and was only discovered by Palestrina. Of course, in the 4th century the composition of such music was impossible; but this is only a specimen of the innumerable fables which have brought the true history into disrepute. The Missæ Pape Marcelli is undoubtedly Palestrina's greatest work. Its ineffable beauty has often been described in glowing terms by those who have heard it in the Sistine Chapel, but it was never heard in England until 1882, when the Bech choir, consisting of two hundred unaccompanied voices, sang it at St James's Hall, under the direction of Mr Otto Goldschmidt; and the effect produced on that occasion more than justified all that had ever been said of the music, which is certainly the most beautiful, the most solemn, and the most truly devotional that has ever been dedicated to the service of the church.

We have dwelt at some length on these circumstances, because they left a more indelible impression upon the history of art than any other events in Palestrina's life, which was not what the world would call a prosperous one, though he himself was quite satisfied with his condition.

Upon the death of Animuccia in 1571 Palestrina was re-elected to his appointment at the Cappella Giulia. He also succeeded Animuccia as Maestro di Cappella at the Oratory of Philip Neri; but these appointments were far from lucrative, and he still remained a very poor man. In 1580 he was much distressed by the death of his wife; and the loss of three promising sons, Angelo, Ridolfo, and Sila, left him with one child only—Igino—a very unworthy descendant. In 1586 a new trouble befel him: Pope Sixtus V. wished to appoint him maestro to the pontifical choir, as successor to Antonio Boccapadula, then about to resign, and commissioned Boccapadula to prepare the choir for the change. Boccapadula, however, managed so clumsily that Palestrina was accused of having meanly plotted for his own advancement. The pope was very angry, and punished the calumniators very severely; but Palestrina lost the appointment. These troubles, however, did not hinder his work, which he continued, without intermission, until February 2, 1594, when he breathed his last in the arms of his friend, Filippo Neri.

The printed works of Palestrina include twelve volumes of Masses; seven volumes of Motets for from four to twelve voices; two volumes of Offertories, and one of Hymns, for the whole year: one

volume of Lamentations, three of Litanies, and one of Magnificats; two of Madrigals, the loveliest in existence; and two of Madrigal spirituali; besides an immense number of compositions still remaining in MS. The whole of these are now in course of publication by Breitkopf and Härtel, of Leipzig. (W. S. B.)

PALEY, WILLIAM (1743–1805), was born in 1743 at Peterborough, where his father was one of the minor canons of the cathedral. The Paley family belonged to the West Riding of Yorkshire, and in 1745 Paley's father was appointed head master of the grammar school of Giggleswick, his native parish. Here Paley received his early education under his father's care. In 1759 he proceeded to Cambridge, where his first undergraduate years were given up, according to his own account, more to society than to study. But, being roused by a reproof from one of his companions, he used the remainder of his time to such advantage that he came out senior wrangler at the end of his course. After taking his degree in 1763, Paley was for about three years assistant in a school at Greenwich; but on his election to a fellowship he returned to Cambridge, and became, in 1768, one of the junior tutors of his college. His colleague in this office was John Law, son of Dr Edmund Law, then master of Peterhouse, and afterwards bishop of Carlisle. To the connexion thus formed Paley was afterwards indebted for his first preferments in the church. As tutor at Christ's, Paley lectured on Locke, Clarke, and Butler, and also delivered a systematic course on moral philosophy, which formed the basis, more than ten years later, of his well-known treatise. The subscription controversy was then agitating the university, and Paley published an anonymous *Defence* of a pamphlet in which Bishop Law had advocated the retrenchment and simplification of the thirty-nine articles. But, though Paley was all for "worshipping God in that generality of expression in which He himself has left some points," he did not see his way to join the petitioners for a relaxation of the terms of subscription. His own view of the articles, as simply "articles of peace," probably led him to consider their action as a piece of overstrained conscientiousness. In 1776 Paley vacated his fellowship by marriage, and retired to the rectory of Musgrave in Westmoreland, which had been conferred on him the year before by the bishop of Carlisle. This very modest living was soon supplemented by the vicarage of Dalston, and presently exchanged for that of Appleby. In 1782 he became archdeacon of Carlisle on the appointment of the younger Law to an Irish bishopric. His first important work, *The Principles of Moral and Political Philosophy*, was published (as *Principles of Morality and Politics*) in 1785, and Paley received the unusually large sum of £1000 for the copyright. The book at once became the ethical text-book of the university of Cambridge, and passed through fifteen editions in the author's lifetime. It was followed in 1790 by his first essay in the field of Christian apologetics, *Horns Paulina, or the Truth of the Scripture History of St Paul evinced by a comparison of the Epistles which bear his name with the Acts of the Apostles and with one another*. Though the original idea of the book was derived from Doddridge, this is probably the most original of its author's works. It was followed in 1794 by a more general work in the same field, the celebrated *View of the Evidences of Christianity*. Paley's latitudinarian views, combined with a certain homely outspokenness in the *Moral and Political Philosophy* regarding the foundations of civil authority ("the divine right of kings is like the divine right of constables"), are said to have debarred him from the highest positions in the church. But his able defence of the faith brought him substantial acknowledgments from the episcopal bench. The bishop of London gave him a stall in St Paul's; the bishop of Lincoln made him subdean of that

diocese; and the bishop of Durham conferred upon him the rectory of Bishop-Wearmouth, worth £1200 a year. Paley transferred his household to Bishop-Wearmouth in 1795. His wife, the mother of eight children, had died four years before, and in the end of 1795 Paley married a second time. During the remainder of his life his time was divided between Bishop-Wearmouth and Lincoln. In 1800 he was attacked by the disease of the kidneys which ultimately carried him off. It was in the intervals of comparative health and ease that remained to him that his last, and in some respects his most remarkable, work was produced, *Natural Theology, or Evidences of the Existence and Attributes of the Deity collected from the Appearances of Nature* (1802). He endeavoured, as he says in dedicating the book to the bishop of Durham, to repair in the study his deficiencies in the church. He died on the 25th May 1805.

In the dedication just referred to, Paley claims a systematic unity for his works. It is true that "they have been written in an order the very reverse of that in which they ought to be read"; nevertheless the *Natural Theology* forms "the completion of a regular and comprehensive design." The truth of this will be apparent if it is considered that the *Moral and Political Philosophy* admittedly embodies two presuppositions—(1) that "God Almighty wills and wishes the happiness of His creatures," and (2) that adequate motives must be supplied to virtue by a system of future rewards and punishments. Now the second presupposition depends, according to Paley, on the credibility of the Christian religion (which he treats almost exclusively as the revelation of these "new sanctions" of morality). The *Evidences* and the *Hours Paulinas* were intended as a demonstration of this credibility. The argument of these books, however, depends in turn upon the assumption of a benevolent Creator desirous of communicating with His creatures for their good; and the *Natural Theology*, by applying the argument from design to prove the existence of such a Deity, becomes the foundation of the argumentative edifice. The sense of unity in the structure is increased to a reader of the present day by the uniformity of the point of view from which the world is regarded throughout. Paley has popularized for 19th-century use the Deistic conception of the universe and the divine economy which was common ground last century both to the assailants and the defenders of orthodox Christianity.

In his *Natural Theology* Paley has adapted with consummate skill the argument which Ray (1691) and Derham (1711) and Nieuwenydt<sup>1</sup> (1780) had already made familiar to Englishmen. "For my part," he says, "I take my stand in human anatomy"; and what he everywhere insists upon is "the necessity, in each particular case, of an intelligent designing mind for the contriving and determining of the forms which organized bodies bear." This is the whole argument, and the book consists of a mass of well-chosen instances marshalled in support of it. But by placing Paley's facts in a new light, the theory of evolution has deprived his argument of its force, so far as it applies the idea of special contrivance to individual organs or to species. Paley's idea of contrivance is only applicable if we suppose a highly developed organism to be dropped suddenly into foreign surroundings. But the relation of an organism to its environment is not of this external nature, and the adaptation of the one to the other must be regarded as the result of a long process of interaction in the past history of the species. In thus substituting the operation of general laws for Paley's continual invocation of a supernatural cause, evolution passes no judgment on the question of the ultimate dependence of these laws upon intelligence; but it evidently alters profoundly our general conception of the relation of that intelligence to the world.

The *Evidences of Christianity* is mainly a condensation of Bishop Douglas's *Criterion* and Lardner's *Credibility of the Gospel History*. But the task is so judiciously performed that it would probably be difficult to get a more effective statement of the external evidences of Christianity than Paley has here presented. The general position, however, that the action of the first preachers of Christianity was due "solely" to their belief in the occurrence of

certain miraculous events is on the same level as the view that "the proper business of a revelation" is to certify future rewards and punishments. It betrays a defective analysis of the religious consciousness. For the rest, his idea of revelation depends upon the same mechanical conception of the relation of God to the world which dominates his *Natural Theology*; and he seeks to prove the divine origin of Christianity by isolating it from the general history of mankind, whereas later writers find their chief argument in the continuity of the process of revelation.

For the place of Paley's theological utilitarianism in the history of ethical speculation in England, see ERRATA.

The face of the world has changed so greatly since Paley's day that we are apt to do less than justice to his undoubted merits. He is nowhere original, and nowhere profound, but he justly claims to be "something more than a mere compiler." His strong reasoning power, his faculty of clear arrangement and forcible statement, place him in the first rank of expositors and advocates. He masses his arguments, it has been said, with a general's eye. His style is perfectly perspicuous, and its "strong home-touch" compensates for what is lacking in elasticity and grace. Paley's avoidance of ultimate speculative questions commended him to his own generation, and enabled him to give full scope to the shrewd practical understanding in which his strength lay. He displays little or no spirituality of feeling; but this is a matter in which one age is apt to misjudge another, and Paley was at least practically benevolent and conscientiously attentive to his parish duties. The active part he took in advocating the abolition of the slave-trade is evidence of a wider power of sympathy. His unconquerable cheerfulness becomes itself almost religious in the last chapters of the *Natural Theology*, when we consider the circumstances in which they were composed. The chapter on the goodness of the Deity is more touched with feeling than any other part of his writings, and impresses the reader with respect for his essential goodness of heart. (A. SE.)

PALGHÁT, a town in Malabar district, Madras, India, situated in the gap or pass of the same name in the Western Gháts, in 10° 45' 49" N. lat. and 76° 41' 48" E. long., 74 miles south-east of Beypur, with a population in 1881 of 36,339. Being the key to Travancore and Malabar from the east, it was formerly of considerable strategic importance. The fort fell for the first time into British hands in 1768, and subsequently formed the basis of many of the operations against Tippeco, which terminated in the storming of Seringapatam. It still stands, but is no longer garrisoned. Palghát is a busy entrepôt for the exchange of produce between Malabar and the upland country, and is a station on the Madras railway. The easy ascent by the Palghát Pass, formerly covered with teak forests, supplies the great route from the south-west coast of India to the interior.

PALGRAVE, SIR FRANCIS (1788–1861), historian, was born in London in July 1788, the son of Meyer Cohen, a Jew, and a wealthy member of the stock exchange. He was privately educated, and such was his capacity for languages that at the age of eight he translated the Latin version of the *Frogs and Mice* into French, which his father published in 1797 with a short preface. On account of the failure of his father's fortunes in 1803 he was articled as clerk to a firm of solicitors, with whom he remained till 1822, acting for some years as their managing clerk, after which he took chambers in King's Bench Walk, Temple, and was employed under the record commission. On his marriage in 1823 he obtained the royal permission to change his name from Cohen to Falgrave, the maiden name of his wife's mother. He was called to the bar at the Middle Temple in 1827, and soon acquired a good practice in pedigree cases in the House of Lords. From an early period of his life he had devoted much attention to literary and antiquarian studies. In 1818 he edited a collection of Anglo-Norman chansons, and previous to his call to the bar contributed largely to the *Edinburgh* and *Quarterly Reviews*. In 1831 he published the *History of England*, in the Family Library series, and in 1832 he brought out *The Rise and Progress of the English Commonwealth*, and *Observations on the Principles of New Municipal Corporations*. The same year he received the honour of knight-

<sup>1</sup> Nieuwenydt (1654–1718) was a Dutch disciple of Descartes, whose work, *Regt gebruik der wereld beschouwing*, published in 1716, was translated into English in 1780 under the title of *The Religious Philosopher*. A charge of wholesale plagiarism from this book was brought against Paley in the *Athenæum* for 1848. Paley refers several times to Nieuwenydt, who uses the famous illustration of the watch. But the illustration is not peculiar to Nieuwenydt, and had been appropriated by many others before Paley. In the case of a writer whose chief merit is the way in which he has worked up existing material, a general charge of plagiarism is almost irrelevant.



hooa. In 1837 he published *Merchant and Friar*, an imaginary history of Marco Polo and Friar Bacon. On the reconstruction of the record commission service in 1838, he was appointed to the post of deputy-keeper. Under the sanction of Government he edited *Rotuli Curia Regis* (2 vols., 1835) and *Calendars and Inventories of the Exchequer* (3 vols., 1836). He was the author of *Detached Thoughts on the Polity and Ecclesiastical History of the Middle Ages*, printed for private circulation, and a learned and elaborate *History of Normandy and England* (4 vols., 1851-64). He died at Hampstead, 6th July 1861.

PĀLI (pronounced *Bali* by the Siamese) is the name of the literary language of the Buddhists in Ceylon, Burmah, Siam, and Cambodia. Laloubère (*Rel. de Siam*) is the first European writer who mentions the name, towards the end of the 17th century. Various opinions have been advanced as to the etymology—from *pañā*, to read (Mason, Minayeff), or *pāli*—*pra + dā* (J. D'Alwis, E. Kuhn)—and original meaning of the word. The latter, given as "row," "range," "line," is applied by Trenckner (*Pāli Misc.*, i. 69) to the "series" of teachers by whom the text of the sacred tradition was handed down, and, according to the Burmese conception of the word (see Forchhammer's *Report for 1879-80*, p. 6), to the sacred texts simply, irrespectively of the language or dialect in which they are written; whereas Pāli scholars generally use the word less in the sense of sacred canon than in that of the language in which the canon is written (Childers, D'Alwis, Fausböll, Oldenberg). The same applies to the synonymous term *Tanti*. When and where that language was formed is still a matter of controversy. We quote here only the opinions of the two principal writers on the subject, Professors E. Kuhn and H. Oldenberg. The former, following Westergaard, holds that Pāli was the Sanakritic vernacular spoken at Ujjain, the capital of Mālava, at the time when Mahendra, the son and successor of the great Asoka, took the sacred canon with him to Ceylon in the form in which it had two years previously received the sanction of the third general council (*Beitr. zur Pāli-Gramm.*, Berlin, 1875). On the other hand, Professor Oldenberg, rejecting that tradition, considers the naturalization of the Pāli language in Ceylon to have been the fruit of a period of long and continued intercourse between that island and the adjacent parts of India, more especially the Kalinga country. Though he does not state within what limits of time that gradual naturalization took place, he records his opinion that at least one portion of the Buddhist canon, the *Vinaya*, in its present form existed in the Pāli language about a hundred and fifty years before Mahendra, that is, about 400 B.C. This is in all probability the earliest period that may be assigned to Pāli as a literary language (*The Vinayapitakam*, edited by Oldenberg, vol. i., 1879, Introduction). Both scholars have discussed the question as to the Pāli being identical with the Māgadhī dialect, and have satisfactorily disposed of it. There can be no doubt that some considerable time must have elapsed before the Pāli recension of the canon was completed, and that, as regards the locality of the language, through the contiguity of cognate vernaculars a palpable number of words and word-forms found their way into Pāli, enriching alike its vocabulary and its grammatical resources; or how else could we account for the occurrence of such doublets and triplets as *adda, alla* (Sanskrit, *ārdra*), *āvata, āvuta* (S. *āvṛita*), *issa, issa, ikka, accha* (S. *ṛiksha*), *kiicca, kasira* (S. *kīcchra*), *gaddha, gidha, gijjha* (S. *gīdhra*), *khā, khelā, khiddā* (S. *Kṛidā*), *taṇhā, taṇā* (S. *ṛiṣṇā*), *tikkhina, tikkha, tipha* (S. *tīkshna*), *dosinā, junhā* (S. *ṛyotā*), *rukkha, vaccha* (S. *ṛiksha*), *sita, mihita* (S. *smīta*), *sināna, nahāna* (S. *snāna*), *sunisā,*

*suphā, husā* (S. *snushā*), and for the many alternative forms in the declensions, some of which will presently be specified? It is also certain that the very belief in the sacred character of the canon must have tended to preserve the text unchanged in form and substance from the time that it was received in Ceylon till the present day. There is, however, a voluminous literature which has grown around and out of the sacred texts, such as Buddhaghosa's great commentary on them (beginning of the 5th century), and several historical works and their commentaries. In this secondary stage many new words and hybrid grammatical forms, due to what Childers appropriately calls false analogy, have found admission into the language (see Fausböll's *Dhammapada*, Introduction); and the grammarians who at this period appear to have treated of language after the Sanskrit models enrol them in their scheme as correct and legitimate.

Though tradition (*Mahāvansa*, xii. 6; *Buddhavaṇsa*, xxii.) makes the introduction of Buddhism into Burmah contemporaneous with the conversion of Ceylon, there is every probability that the event took place at a much later period. It must, however, have taken firm root in Burmah at the time that in consequence of religious persecutions Buddhist priests from Ceylon went to Burmah to obtain a copy of the sacred canon and Buddhaghosa's commentary thereon (5th century of our era). Thence an uninterrupted religious intercourse has been kept up between the two countries up to the present, notwithstanding which certain discrepancies between the Pāli texts of Burmah and those of Ceylon point to the fact that the latter retain older forms and expressions, whereas the former replace these by more modern, more common, or more regular ones (Fausböll, *Ten Jātakas*, Introd.). This fact, however, can only be established on a scientific basis when good old copies of grammatical works, both in the Sinhalese and Burmese character, shall have been carefully examined and compared *ad hoc*. It is certainly true that in Ceylon, where the study of Sanskrit flourishes, and where the people have spoken for upwards of two thousand years an Indo-Aryan idiom, Pāli learning has obtained a far firmer and more favourable footing than in Burmah, where the nature of the vernacular places considerable difficulties in the path of the student of the sacred language.

As regards the status of Pāli in Siam, no trustworthy information is available. It would appear, however, that Pāli MSS. from that country—invariably written in the Cambodian character—are more remarkable for caligraphy than for correctness. Both in Burmah and Ceylon Pāli is written in the character of the vernacular. The well-known *Manual* used at the admission of a novice into the monastic order is almost the only book in which the so-called square character is customary (see Burnouf and Lassen, *Essai sur le Pāli*, Paris, 1826).

Since the days of Prinsep the name of Pāli has also been given to the various local dialects, and the name of Pāli character to the monumental alphabet, or rather alphabets, in which the so-called Asoka inscriptions are written. The language of these records, it is true, comes nearer to the Pāli than to any other early Sanskrit idiom; still it is sufficiently distinct from the language of Buddhist literature to be treated by itself (see E. Senart, *Les Inscriptions de Piyadasi*, vol. i., Paris, 1881; and G. Bühler, in *Z. D. M. G.*, vol. xxxvii.).

Pāli has aptly been said to stand phonetically in the same position to Sanskrit as Italian does to Latin. There is the same tendency to smooth down all sounds difficult of utterance, to assimilate or otherwise simplify compound consonants, and to substitute vocalic or nasal for consonantal word-terminations. More especially, Pāli lacks the *r* and *l* vowels and the diphthongs *et* and *au*. The Sanskrit vowel *r* generally passes in Pāli into *e*,

sometimes also into *i* or *u*; as *śri* (S. *ṛiṣi*), *daṭṭha* (S. *dṛiḍha*), *prāṭha* (S. *prīṭha*). *E* and *o*, representing S. *ai* and *au* respectively, can before double consonants be further shortened into *i* and *u*, just as other long vowels may be shortened under the same circumstances; thus *usukka* (S. *autrukya*), *raṭṭha* (S. *rāṣṭra*). Some anomalous vowel changes are exhibited in the following examples:—*kaṇḍakka* (S. *kaundinya*), *paṇa* (S. *punar*), *purisa* (S. *purusha*), *usu* (S. *ishu*), *vīṭṭā* (S. *vīṭā*), *heṭṭhā* (S. *adhastāt*). As regards consonants, Pāli has only the dental sibilant, and replaces by *anusvāra* most final consonants of Sanskrit words; as *manā* (S. *manāk*), *saṇi* (S. *saṇis*), *khattun* (S. *kṛitvas*). Two or more consonants meeting in the middle of a word are mostly assimilated, as *ummagga* (S. *unmārga*), *pabbhāra* (S. *prāgbhāra*). Other changes are *paṭṭha* (S. *praṅga*), *paṭṭanta* (S. *pariyanta*), *daḍḍhā* (S. *damasṭra*), and of initial consonants *laṭṭhā* (S. *yaṣṭhi*), *ḷudda* (S. *rudra*), *naṅgala* (S. *lāngala*), *kipillika* (S. *pipillika*), *khāṇu* (S. *sthānu*). Contraction is very frequent, as well as metathesis, as the following examples will show:—*kho* (S. *khālu*), *accaka* (S. *atyaṅka*), *deera* (S. *ācārya*), *cuddāsa* (S. *caturdaśan*), *issera* (S. *aiṅvārya*), *abbhāra* (S. *avyabhāra*). In the Scenic Prakṛits and in the Māgadhī of the Jains the consonantal decay has reached a much higher stage than it has in Pāli, showing that the latter holds its place between the former and the Sanskrit. This applies also to *Sandhī*, which in Pāli is indeed sporadically and irregularly attended to, but shows a tendency to being altogether neglected.

There is no dual in the declension any more than in the conjugation; the only remnants of it appear to be *to* (S. *tau*) and *ubho* (S. *ubhau*). The old dative case is rarely used, and the genitive takes its place. The declension of nouns has in some cases been encroached upon by the pronominal declension. According to the nature of Pāli phonology, there cannot be any real consonantal stems, and therefore no regular consonantal declension. Final consonants are either dropped or have an *a* added to them. In the former case the final consonants reappear before the vowel terminations, in the latter the declension follows the false analogy of the *a*-declension. Thus, *dāṭṭā* (S. *dhātā*) is declined as follows:—*Sing.*—nom. *dhātā*, *dhātanto*; voc. *dhātā*, *dhā*, *dhīmā*; acc. *dhātantaṃ*, *dhātā*; instr. *dhātātā*, *dhātānta*; dat. gen. *dhātā*, *dhātanta*; abh. *dhātātā*; loc. *dhātātā*, *dhātanta*; plur. *dhātāntaṃ*; *Plur.*—nom. voc. *dhātantaṃ*, *dhātāntā*; acc. *dhātāntaṃ*, *dhātāntā*; instr. *abh. dhātāntebhī*, *dhātāntehī*; dat. gen. *dhātāntaṃ*, *dhātāntāṃ*; loc. *dhātāntaṃ*. Examples of multiform cases are the loc. sing. of *nadi*, which exhibits the forms *nadiya*, *nadiyaṃ*, *najjāṃ*; the voc. plur. of the honorific pronoun *bhavaṇ* (S. *bhavat*), which has *bhāvanto*, *bhonto*, *bhante*; the gen. dat. sing. of *pita*, which has *pita*, *pitano*, *pitussa*, and in the plur. *pitānaṃ*, *pitunnaṃ*, *pitānaṃ*, *pitānaṃ*; the loc. sing. of *mano*, *manāṃ* (S. *manas*), which has *manasi*, *mane*, *manasim*, *manamhī*. The personal pronouns also show a variety of forms, some of which are still traceable in the modern Prakṛits. Thus *ahaṃ* has in the plural—nom. *vayaṃ*, *mayāṃ*, *amhe*; acc. *asme*, *amhe*, *amhākaṃ*; instr. *abhi*, *amhehi*, *amhehi*; dat. gen. *amhākaṃ*, *amhānaṃ*, *amhaṃ*; loc. *amheṣu*. Similarly, the gen. dat. sing. fem. of the demonstrative pronoun has the forms *imassa*, *imassāya*, *imāya*, *assa*, *assāya*.

The Pāli verb shows even more than does the noun a tendency to break with the analogy of the Sanskrit. Though native grammarians arrange the conjugations on a plan similar to that of the Sanskrit, the disorganizing process which pervades the whole of Pāli grammar is in no part so advanced as in this particular. Thus, the present tense of the verb *śā* (S. *sthā*) is *thāti* as well as *tiṭṭhati*; of *dā* it is *dadāti*, *dahati*, and *dhāti*; of *da* *dadāti*, *dati*, *dāti*, and (by false analogy from the optative *dajjam*) *dajjati*; of *ji* *jayati*, *jeti*, and *jināti*; of *bhī* *bhāyati*; of *rudh* *rundhati*, *rundhiti*, *rundhiti*, and *rundheti*; of *mar* (S. *mṛi*) *marati* and *miyati*; and of *kar* (S. *kṛi*) the plural has *karoma*, *karotha*, *karonti*, and also regularly *kubbanti*, from which form again by false analogy a 2d person singular *kubbati* has been derived. The termination *va* of the 3d person plural perfect *ātmanepada* has been transferred to the present tense, where it is used along with *-anta*. But there is a general predilection for the *parasmaipada* terminations, even in the passive. While the perfect sensibly recedes before the other tenses, and is of rare occurrence, the use of the aorist largely encroaches on that of the imperfect, the conjugation of which is in many verbs influenced by the former, as, e.g., in the verb *as*, in which the imperfect is:—1st sing. *āsim* or *asi*; 2d and 3d, *ās*; 1st plur. *āsimha*; 2d, *āsitha*; 3d, *āsimu*. In the imperative par. the 1st sing. and 2d plur. do not differ from the corresponding forms of the present. The affixes of the future (*-ssa*) and passive (*-ya*) may also be added to the special base; thus we have the forms *dakkhati* and *passissati*, "he will see," and *gamiyati* and *gaociyati*, "he is gone to." In the causative verb the form with *p* greatly preponderates, and may even be added to the special base, as, e.g., *sunāpeti* (S. *grāvayati*), "he informs"; *ganāpeti* (S. *grāhayati*). Lastly, the gerund in *-tā* is not only used in compound verbs in preference to the one in *-ya*, but may also

occasionally be superadded to the letter for the sake of greater precision. Thus, *sajjivā*—*sad*+*ya*+*i*+*tvā*; and *abhiruyhivā*—*abhiruh*+*ya*+*i*+*tvā*. Instead of *rod* the forms *roṣa* and *roṣa* often occur. There are two forms of the infinitive, there being besides the usual form in *-sā* one in *-vā*, which appears to have lingered in the vernacular long after it was disused in Sanskrit literature.

*Literature.*—The study of Pāli by Europeans is of comparatively recent date; in fact, our knowledge of the very existence of an extensive Pāli literature dates scarcely half a century back. It is true that in 1826 Professors Burnouf and Lassen were enabled, from an examination of certain Pāli MSS. which had fallen under their notice, to give a general account of the language; but it was reserved for the late Mr G. Turnour, colonial secretary of Ceylon, to collect the first trustworthy information concerning the sacred books of the island, and to edit and translate the first Pāli text of any extent. His choice of the *Mahāvāsa*, one of the oldest chronicles, was all the more fortunate, as, in the almost total absence of historical works in Sanskrit literature, these annals were calculated to yield a vast amount of information regarding the origin and earlier history of the Buddhist religion in India. The book had been ready for the press many years, but was not published till 1837, while a series of articles by the same author, embodying the results of his examination of the *Mahāvāsa* and its commentary and of the contemporaneous *Dīpavāsa* (*Jour. Bengal As. Soc.*, vols. v. and vi.), had been received by Oriental scholars with the utmost interest. The thirty-eight chapters published by him bring the history of Ceylon down to 477 A.D.; they comprise the original work of *Mahāśāstra*. Six more chapters, ready for the press in text and translation, were found among Turnour's papers at his early death in 1842, and are now in the India office library. The whole *Mahāvāsa*, in Pāli and Sinhalese, has since been printed at the Government press, Colombo, 1877–83, and an English translation is in progress. However, a critical edition of the earlier part, and more especially of the commentary upon it, is still a desideratum. There is an excellent edition and translation of the *Dīpavāsa* by Professor Oldenberg (London, 1879), according to whom the work was written between the beginning of the 4th and the first third of the 5th century. Among the historical works may also be classed the *Dāthāvāsa*, a poetical history of the tooth-relic of Buddha, composed by Dhammakitti early in the 13th century. The work was printed at Colombo in 1882, and an English translation by M. Kumāraswāmi appeared in London in 1874. Further, the *Attanagālavāsa*, the history of a temple, likewise of the 13th century, edited and translated by J. D'Alwis at Colombo in 1866. Other historical works are described in the catalogues of Pāli MSS. Lastly, there exist many mediæval Pāli inscriptions, some of considerable extent, as, e.g., those of Kalyāṇi in Burmah, which are now in course of publication, and are likely to yield valuable historical results. Many of them are accompanied by a translation in Burmese or Talaing,—a language now all but extinct. It is worth noting that neither in Ceylon nor in Cambodia have any old Pāli inscriptions been found; in the island the old inscriptions are in Sinhalese, in Cambodia they are in Sanskrit, frequently with a translation in Khmer.

Though there is an old ninefold division (*navanga*, see Dr R. Morris's "Report on Pāli Literature," in *Philological Society's Proceedings*, 1880) of the canonical scriptures, it is the general practice of Pāli scholars to abide by the division into three "baskets" (*tipitaka*, *pitakattaya*), first specified by G. Turnour, and then more correctly in Childers's Dictionary, p. 507, viz. the *Vinayapitaka*, the *Suttapitaka*, and the *Abhidhammapitaka*, or the baskets of discipline, of discourses, and of metaphysics. Only the

first of these, and at the same time the earliest, has been published in a critical edition in five volumes by Professor Oldenberg, London, 1879-83, while a translation by the same and Mr Rhys Davids is in progress in the *Sacred Books of the East*. One of its constituent parts, the *Pāṭimokkha*, mentioned already by Laloubère, was edited and translated into Russian by Minayeff (1869); an English translation by Gogerly had appeared thirty years previously in vol. iii. of the *Ceylon Friend*, and the *Journal of the Royal Asiatic Society* for 1875 brought out a new translation, accompanied by the Pāli text, by J. F. Dickson. Editions of the text have also appeared in Ceylon and Burmah. A ritualistic manual, the *Kammavācā*, the first chapter of which was edited by Spiegel with a Latin translation in 1841, was the first Pāli text published in Europe. The first of the numerous works composing the *Suttapiṭaka* that was made accessible to Pāli scholars in Europe was the *Dhammapada*, or Path to Virtue, a critical edition of which, with a Latin translation and copious extracts from Buddhaghosa's commentary, was brought out by Professor Fausböll, of Copenhagen, in 1855. So popular has this work proved as a type of Buddhistic sentiment that no less than two English translations (by Professor F. Max Müller in 1870 and 1881, and by Professor J. Gray, of Rangoon, in 1881), one in German (by Professor A. Weber, 1860), and one in French (by M. F. Hd, 1878) have appeared, besides various editions printed at Colombo and Rangoon, with translations into the respective vernaculars. Other collections of moral maxims also, such as *Lokantī* and *Dhammantī*, appear to be favourite books in Burmah. Of the other works of the *Suttapiṭaka*, the *Jātaka Book*, an account of the five hundred and fifty previous births of Buddha, has till quite recently absorbed the lion's share of attention on account of its being the oldest extant collection of fables and popular stories, many of which have at an early date found their way to the West, and are still current amongst us. Three volumes of the text of this extensive work, edited by Professor Fausböll, and one volume of the translation, by Professor Rhys Davids, have up to the present appeared, while many of the most interesting tales, in groups of from two to twelve, were separately published by the same editor between the years 1858 and 1872. Other works belonging to the same division which have been published are *Khuddakapīṭha* (by Professor Childers, 1869), *Buddhavaṇṇa* and *Cariyāpīṭaka* (by Dr Morris, 1862), *Anguttaranikāya* (by the same, 1884), and *Majjhimanikāya* (by Trenckner, 1884); and a number of others, such as *Itivuttaka*, *Theragāthā*, *Therīgāthā*, and *Apadāna*, are, thanks to the active zeal of the working members of the newly founded Pāli Text Society, either in progress or in preparation. An edition of *Suttapiṭaka*, by Professor Fausböll, whose translation of the work appeared in 1881, is also passing through the press. Seven suttas from the *Dighanikāya*, prepared for publication by the late P. Grimblot, appeared in Paris in 1876; and a number of others, from various collections, edited and translated by L. Feer, are to be found in the *Journal Asiatique*. An edition, by Professor Childers, of the *Mahāparinibbāna-sutta*, from the *Dighanikāya*, was published in 1876, and a translation of the same and other suttas, by Professor Rhys Davids, forms vol. xi. of the *Sacred Books of the East*. Lastly, Dr Morris has in the press an edition and translation of "the Six Jewels of the Law," one of which is the *Mahāsatipatti-sutta*, a favourite text-book in Burmah and Ceylon. The *Milinda-paṭha*, a work of the middle of the 2d century B.C., a scholarly edition of which we owe to Trenckner (1880), though obviously not a canonical book, may well be classed with this second division. The *Abhidhammapīṭaka* has so little in it to attract the European student of Pāli that an

edition of any of its components parts is not likely to be forthcoming for some time. A compendium of its tenets, the *Abhidhammatthasangaha*, has been frequently printed in the Burmese and in the Sinhalese character.

While in Siam and Ceylon the law-books are in the vernacular, they are in Burmah in the original Pāli, which is generally accompanied by a Burmese gloss. San Germano translated one of them (see his work on *Burmah*, p. 178 sq.) in the end of last century. Several of them have in recent years been brought out at Rangoon by Colonel H. Browne, and the oldest of them, by King Wagaru, is passing through the press. The editor, Professor Forchhammer, has also supplied valuable translations to the series of Mr Jardine's *Notes on Buddhist Law*, which are appearing at Rangoon. A critical edition of the *Law of Manuśya*, by Dr Führer, is in the press at Bombay.

The age of the oldest Pāli grammarian, Kaocāyana, is still under dispute; it is far more likely, however, that it has to be placed towards the end of the 11th century A. D. (see Colonel Fryer's paper in *Jour. Beng. As. Soc.* for 1882) than with J. D'Alwis in the 6th century A. C. While his system is the one which has long been current in Burmah, the grammar by Moggallāna (second half of the 19th century) represents the leading grammatical school of Ceylon. Round both a large number of grammatical works have grown up, more than sixty of which are specified and fully described by Subhuti in the introduction to his book on the Pāli declensions (*Nāmanāli*, Colombo, 1876). M. E. Senart has given an excellent edition and exposition of Kaocāyana's grammar Paris, 1871, some chapters of which had previously been made the subject of separate treatises by J. D'Alwis and Professor E. Kuhn. The first five chapters of the *Bāli-vācāra* were edited and translated by L. F. Lee (*Ceylon As. Soc. Jour.* for 1870-71), and the sixth chapter of the *Āpāsiddhā*, another old grammar, was recently published by Dr Grünwedel (Berlin, 1883). The oldest Pāli vocabulary, called *Abhidhānappāṭya*, and compiled by the above-mentioned Moggallāna on the model of the *Amara-kośa*, was first printed at Colombo in 1884 as an appendix to Clough's grammar. A better edition, by Subhuti, with English and Sinhalese interpretations, notes, and appendices, appeared in 1865, of which a much improved reissue has just appeared at Colombo, to be followed in a second volume by full alphabetical indices. The *Dhātumānāṭya*, a dictionary of Pāli radicals, by Sīlavansa, was edited with English and Sinhalese translation at Colombo in 1872. *Vuttodaya*, a work on metre by Sangharakkhita, who is identified with Moggallāna, was first edited and translated by Professor Minayeff of St Petersburg in 1869, and in 1877, as No. II. of his *Pāli Studies*, by Colonel G. E. Fryer, who had previously, in the first essay (1875), given the text with a full analysis of a work on rhetoric, called *Subodhāntakāra*, by the same author.

There are great facilities in Europe for the study of Pāli and its extensive literature. The British Museum, the University Library of Cambridge, and the Library of the India Office are rich in Pāli MSS., and a catalogue raisonné of the last-mentioned collection, by Professor Oldenberg, is accessible to students. The Royal Library of Copenhagen contains the MSS. which the late Professor E. Saak had brought from India, probably the finest collection in Europe, a catalogue of which was published in 1844. The National Library of Paris is the only one in Europe that possesses, in addition to a large number of MSS. in the Sinhalese and Burmese characters, a fine assemblage of MSS. in Cambodian letters. There are also Pāli MSS. in the hands of learned societies and in private hands, and it would be well if means could be devised for bringing these hidden treasures to light and utilizing them for literary purposes, for the study of the Pāli language and literature has been making rapid strides within the last ten years. Lectures on Pāli are delivered at Cambridge, in Paris, and in most of the German universities, and the number of publications of Pāli texts increases year by year. It is already admitted that Childers's *Dictionary*, the publication of which in 1875 formed an epoch in the study of Pāli, no longer suffices to supply the want, and that a more comprehensive work, or at least a supplementary dictionary, is urgently needed. Clough's *Pāli Grammar*, which appeared at Colombo in 1854, found its way to Europe so tardily that it was still unknown to the authors of the *Essai sur le Pāli* when they published their supplement to it in 1837, and it has always been a scarce book. In 1873 Professor Minayeff brought out at St Petersburg a Pāli grammar, written in Russian, which was translated into French by M. A. Guyard five years later. An English translation made from this French version by Professor J. Gray appeared at Madras in 1882. Another Professor E. Kuhn of Munich published his valuable *Beiträge zur Pāli-Grammatik* (Berlin, 1875), a mine of wealth for all students of the language. It is from this book and from Dr Ed. Müller's grammar, to be named presently, that most of the examples in the above grammatical sketch have been culled. In 1881 there appeared at Christiania *Die Flexion des Pāli in ihrem Verhältniss zum Sanskrit*, by Alf Torp, and last year in London Dr Frankfurter's *Handbook of Pāli, being an Elementary Grammar, a Grammatical, and a Glossary*, at the same time that at Rangoon Professor J. Gray's *Elements of Pāli Grammar* left the press. The grammar by Dr Ed. Müller, just published, deserves to be called a pattern of critical scholarship. Much valuable information on grammatical and etymological questions may also be gained from Professor Fr. Müller's *Beiträge zur Kenntnis der Pāli-Sprache*, Vienna, 1867-68; Dr Morris's "Report on Pāli Literature," in *Proc. Philol. Soc.*, 1880; and last, not least, V. Trenckner's *Pāli Miscellany*, part I., Copenhagen, 1879.

PALIMPSEST, a term applied to any material from which writing has thus been removed to make room for another text, and which has thus been prepared or scraped a second time (*παλιμψηστος*). Such an object therefore as an inscribed monumental stone or brass may be called palimpsest.

But the term is most commonly applied to ancient MSc. which have undergone this treatment. See PALBROGRAPHY.

PALINDROME (πάλιν, again, and ῥόμος, a course), a verse or sentence which runs the same when read either backwards or forwards. Such is the verse—

Roma tibi subito motibus ibit amor ;

or

Signa te, signa, temere me tangis et angis ;

or

πίστερ ἀνομιάρτα μή πόρος ἔβρω.

Some have refined upon the palindrome, and composed verses each word of which is the same read backwards as forwards,—for instance, that of Camden—

Odo tenet mulum, madidam mappam tenet Anna,  
Anna tenet mappam madidam, mulum tenet Odo.

The following is still more complicated, as reading in four ways—upwards and downwards as well as backwards and forwards :—

S A T O R  
A R E P O  
T E N E T  
O P E R A  
R O T A S

PALISSY, BERNARD (1510-1589), was born in 1510 at La Chapelle Biron, a village in the province of Périgord, France. His parents were poor, and at an early age he was thrown upon his own resources for even the most elementary education. With indomitable energy he read all the books within his reach, and, aided by naturally keen powers of observation, gained a knowledge, remarkable for that time, of chemistry, geology, botany, and other branches of natural history. Bernard Palissy's father was a painter of stained glass, and taught his son the practice of this important craft; he thus became a skilful draughtsman, learned the manipulation of colours, and gained that training of the eye which in after years helped to bring him success and reward as a potter. After a period of travelling apprenticeship, Palissy married and settled in Saintes. At first he practised his craft of glass-painter, varied by portrait-painting and land-surveying. The search for subjects for his window-paintings led Palissy to extend his already wide course of study to history and classical mythology. He had not long been married when the whole course of his life was changed by a new ambition. He happened to see a fine piece of enamelled pottery, probably majolica ware from Italy, and thereupon resolved to spend any time and labour to discover for himself the secret of the beautiful enamelled surface that he admired so much in that piece of pottery. His trade as a glass-painter had taught him something of the methods of painting and firing enamel colours, and at the neighbouring village of La Chapelle des Pots he learned the rudiments of the potter's art in its simplest form; but this was all the help he had. He knew nothing whatever of the manufacture of the finer sorts of faience, or of the composition of the white enamel which was to form the covering of his clay vessels and the ground for his coloured ornament.

Year after year, through a succession of utter failures, and almost without a gleam of hope, he laboured on, working often blindly and at random in search for the secret of the white enamel. Almost starving for want of food, his wife in rags bitterly and not unreasonably reproaching him for his cruelty, his furniture broken up to feed his kilns, and without a hand to help, Palissy struggled on for nearly sixteen years before success came. A truly tragic story is this, for after all it was no new discovery that Palissy ever reached or even aimed at.

The secret of the white enamel was known to every potter of northern Italy, and there, if he had but known, he might have learned that process on the rediscovery of which he wasted so many of the best years of his life. All those struggles and failures are most vividly told by Palissy himself in one of the most thrilling pieces of autobiography ever written. The nearest parallel to it is perhaps (widely different as the two men are) that of his contemporary the Florentine Cellini.

For a few years Palissy enjoyed untroubled reward for his years of toil and unflinching constancy of purpose. His works were bought and appreciated by the queen, Catherine de' Medici, and many of the great nobles of her court, who were eager for specimens of his skill. But before long Palissy, who had always been something of a theologian and a constant Bible student, became irresistibly enthralled by the new doctrines of the Reformation, and enrolled himself an enthusiastic member of the Huguenot party. He could do nothing by halves; he devoted himself heart and soul to the cause, and, in 1568, while engaged in making plaques, tiles, and rustic figures in faience to decorate the Constable de Montmorency's Château d'Ecouen, Palissy was arrested and imprisoned at Bordeaux, while his kilns and the materials of his trade were destroyed by command of the magistrates.

Through the intervention of the French court Palissy was, after a time, liberated, and about 1563, under the protection of the king, set up his pottery-works in Paris, on a plot of ground afterwards occupied by part of the gardens of the Tuileries. Here Palissy lived and worked in comparative peace and prosperity till 1588, when a fresh outburst of religious zeal against the Huguenots proved too strong even for the royal patronage, which for so long had sheltered him. He was thrown into the Bastille, and, though Henry III., who was then king, offered him rewards and freedom if he would recant, Palissy preferred death to falsehood. Henry III., though not unmindful of the forty-five years during which Palissy had faithfully served the court of France, was too timid or too weak to save his old servant, then nearly eighty years of age. Palissy was condemned to death, but died shortly after, in one of the dungeons of the Bastille, in the year 1589. This martyr's death was a not unfitting end for one whose whole life had been a sacrifice to noble aims, and who, years before, had suffered a protracted martyrdom in the to him sacred cause of art.

*Palissy's Pottery.*—Though very varied in design, Palissy's pottery is for the most part executed after one technical process. Hard well-burnt earthenware, sometimes fired at so high a temperature as to have almost a metallic ring, was covered with a white enamel, formed of the usual ingredients of glass, to which opacity and creamy whiteness were given by the addition of an oxide of tin. On this white ground various colours were applied in enamel-pigments, and the whole finally covered with a thin plumbivorous glass. The potter's wheel was but little, if at all, used by Palissy, who, in his pieces, aimed less at purity and beauty of outline than at elaborate surface-decoration in high relief, formed by pressing the clay into a mould.

Palissy's best-known productions are large plates, ewers, vases, and other forms, decorated in alto-relief, with very realistic figures of reptiles, fish, insects, shells, plants, and other objects, executed with wonderful truth and accuracy from moulds formed by taking casts of the objects themselves (see woodcut). Thus we see reproduced every scale on a snake's or fish's back, and the minutest peculiarities of the fossil shells and living plants which Palissy saw around him and delighted in copying with the scientific accuracy of a student of natural history and geology. Casts from these objects were fixed on to a metal dish or vase of the shape required, and a fresh cast from the whole formed a mould from which Palissy could reproduce many articles of the same kind. After being covered with the long-sought-for white enamel, the various parts of the piece were painted in realistic colours, or as near truth as could be reached by the pigments Palissy was able to discover and prepare. These colours were mostly various shades of blue from indigo to ultramarine, some rather crude greens, several tints of brown

<sup>1</sup> This last is from the *capitoli* of the emperor Leo VI., the Philosopher, and occurs in a palindrome piece of twenty-seven lines, which can be seen in the *Zoographia Variata* of Leo Allatius (1641). See also *N. and Q.*, 5th ser., vii. 373, viii. 77.

and greys, and, more rarely, yellow. Other pieces, such as dishes and plaques, were ornamented by figure subjects treated after the same fashion, generally Scriptural scenes or subjects from classical mythology. These were in many cases copied from works in sculpture by contemporary artists.

Another class of designs used by Palissy were plates, tazze and the like, with geometrical patterns moulded in relief and pierced through, forming a sort of open network. Perhaps the most successful as works of art were those plates and ewers which Palissy moulded in exact facsimile of the rich and delicate works in pewter for which Francois Briot and other Swiss metal-workers were so



Rustic Plate by Palissy.

celebrated. These are in very slight relief, and are executed with cameo-like finish, mostly of good design, after the style of the Italian silvermiths of the 16th century. Palissy's ceramic reproductions of these metal plates are not improved by the colours with which he picked out the designs.

Some enamelled and painted earthenware statuettes, full of life and expression, have been attributed to Palissy; but it is doubtful whether he ever worked in the round. On the whole his productions cannot be assigned a very high rank as works of art, though they are certainly remarkable as objects of curiosity and marvels of ingenious skill. They have always been highly valued, and in the 17th century attempts were made both at Delft and Lambeth to copy his "rustic" plates with the reliefs of animals and human figures. These imitations are very blunt in modelling, and coarsely painted. They are generally marked on the back in blue with initials and a date—showing them to be honest copies, not attempts at forgery, such as have been produced in the present century.

The best collections of Palissy ware are those in the museums of the Louvre, the Hôtel Cluny, and Sévros; and in England that at Narford Hall, with a few specimens in the South Kensington and British Museums.

As an author Palissy was perhaps even more successful than as a potter. A very high position among French writers is assigned to him by Lamartine (*B. Palissy*, 8vo, Paris, 1852). He wrote on a great variety of subjects, such as agriculture, natural philosophy, religion, and especially his *L'Art de terre*, in which he gives an account of his processes and how he discovered them. A complete edition of his works was published by P. Antoine Cap, *L'Œuvres Complètes de B. Palissy*, Paris, 1844.

See Morley, *Life of Palissy*, 1855; Marryat, *Pottery*, 1850, pp. 31 sq.; Dumoulin, *B. Palissy, le potier de terre*, 1851; Tainturier, *Terres Émaillées de Palissy*, 1853; Delcambre, *B. Palissy*, 1853; Enjoubert, *L'Art céramique de B. Palissy*, 1858; Andlar, *Étude sur le vit* . . . de B. Palissy, 1868; Delange, *Monographie de l'œuvre de B. Palissy*, 1862. For Palissy as a Huguenot see Bonniau, *Les Protestants d'Alsace*, No. iv., 1861. (J. H. M.)

**PĀLITĀNA**, a "second class" native state of India, in **KĀTHIĀWĀR** (q.v.), Bombay presidency, lying between 21° 23' 30" and 21° 42' 30" N. lat., and between 71° 31' and 72° 0' 30" E. long., with an area of 305 square miles, and a population (1881) of 49,271. The chief pays a tribute jointly to the gāekwār of Baroda and the nawāb of Junagarh. The capital of the state is Pālitāna (population, 7659). Above the town, to the west, rises the sacred hill of Satrunjaya, which is covered with temples dedicated to Adināth, one of the deified saints of the Jains, and is the resort of innumerable pilgrims from all parts of India.

**PALLADIO, ANDREA** (1518–1580), a native of Vicenza in the north of Italy, one of the chief architects of his century. Palladio's early student life was spent in Rome, where he learned the practical part of his profession, and

spent several years in making drawings of the buildings of ancient Rome. In 1547 he returned to his native city Vicenza, where he designed a very large number of fine buildings—among the chief being the Barbarano, Porti, and Chierigati palaces, as well as many others for various nobles of Vicenza and the neighbourhood. Perhaps his finest work in Vicenza itself was the Palazzo della Ragione, with two stories of open arcades of the Tuscan and Ionic orders. Most of these buildings, however, look better on paper than in reality, as they are mainly built of brick, covered with stucco, now in a very dilapidated condition. This does not affect the merit of their design, as Palladio intended them to have been executed in stone. His fame extended widely throughout Italy, and Pope Paul III. sent for him to Rome to report upon the state of St Peter's. In Venice, too, Palladio built many stately churches and palaces, such as S. Giorgio Maggiore, the Capuchin church, and some large palaces on the Grand Canal. His last great work was the Teatro Olimpico at Vicenza, designed after a classical model; he died before its completion, and it was finished, though not altogether after the original design, by his pupil and fellow-citizen Scamozzi.

In addition to his town buildings, Palladio designed many country villas in various parts of northern Italy. The villa of Capra is perhaps the finest of these, and has frequently been imitated. Palladio was a great student of classical literature, and was much influenced by Vitruvius's great work on architecture. He also published in 1575 an edition with notes of *Cæsar's Commentaries*.

His great literary work was *I quattro libri dell' Architettura*, first published at Venice in 1570, which has passed into countless editions, and been translated into every European language. The original edition is a small folio, richly illustrated with well-executed full-page woodcuts of plans, elevations, and details of buildings,—chiefly either ancient Roman temples or else palaces designed and built by himself. The influence of this book on the architecture of Europe has been enormous. Among many others, an edition with notes was published in England by Inigo Jones, most of whose works, and especially the palace of Whitehall, of which only the banqueting room remains, owed much to Palladio's inspiration. Though other Italian architects in the 16th century worked out and developed the same style, yet, in England at least, the term Palladian has been used to include all the results of this revival of classicalism. Vignola, Scamozzi, and Serlio were among the chief of Palladio's contemporaries. The style adopted and partially invented by Palladio expressed a kind of revolt against the extreme licence both of composition and ornament into which the architecture of his time had fallen. Though often noble, dignified, and full of the most harmonious proportions, Palladio's style is dull and lifeless, dominated by scholasticism, and regardless of considerations of utility and convenience.

He was fascinated by the stateliness and beauty of proportion which are the chief charms of the buildings of ancient Rome, and did not stop to reflect that reproductions of these, however great their archaeological accuracy, could not but be lifeless and unsuited to the wants of the 16th century. Palladio's carefully measured drawings of ancient buildings are now of great value, as in many cases the buildings have altogether or in part ceased to exist.

The following is a short abstract of the contents of Palladio's great work on architecture:—

Book I. Materials; construction; the five orders (Tuscan, Doric, Ionic, Corinthian, and Composite); the proportions of various parts of buildings; construction of stairs.

Book II. Plans and elevations of city and country houses designed by Palladio; restoration of Greek and Roman houses; sites; Palladio's designs for palaces for certain Venetian and other noblemen, in Venice, Vicenza, Verona, and elsewhere.

Book III. Roads; bridges; piazza; piazza of Greeks and Romans; ancient basilica; modern basilica at Vicenza; baths and xysti of the Greeks.

Book IV. Temples of ancient Rome; Bramante's "Tempietto" (S. Pietro in Montorio); Roman temples in Italy, outside Rome; Roman temples (such as those at Nîmes) outside Italy.

See Montanari, *Vita di Andrea Palladio*, 1749; Bigatto, *Observazioni sopra Andrea Palladio*, 1811; Magrini, *Memorie intorno la vita di Andrea Palladio*, 1845; Müllis, *Memorie degli Architetti*, 1781, ii. pp. 35-54; Symonds, *Renaissance in Italy—Pino Arts*, pp. 94-99.

**PALLADIUM**, an archaic wooden image (ἔλαρον) of Pallas, preserved in the citadel of Troy as a pledge of the safety of the city. It represented the goddess, standing in the stiff archaic style, holding the spear in her right hand. According to one story, Zeus had thrown it down from heaven when Ilus was founding the city of Ilium. Odysseus and Diomedes carried it off from the temple of Pallas, and thus made the capture of Troy possible. Many different cities boasted that this ancient image had passed into their possession—Athens, Argos, Rome, Lavinium, &c. It is probable that the Palladium is an image of the warlike goddess Pallas, who must in origin be distinguished from Athena. The theft of the Palladium is a frequent subject in Greek art, especially of the earlier time.

**PALLADIUS, RUTILIUS TAURUS ÆMILLIANUS**, a writer of the 4th century after Christ, author of a poem on agriculture (*De Re Rustica*) in fourteen books. It is not certain whether he can be identified with any known historical person of the time. His work consists of an introductory book of general directions on agriculture, twelve books describing the operations suitable for the twelve months of the year, and a final book on the cultivation of trees. The material is derived from Columella and other earlier writers. The work was popular in the Middle Ages; it is conveniently arranged, but far inferior in every other respect to that of Columella.

**PAL LAHARA**, a tributary state of ORISSA (q.v.).

**PALLAS**. See **ATHENA**, vol. ii. 830.

**PALLAS, PETER SIMON** (1741-1811), naturalist and traveller, was born in Berlin, September 22, 1741, the son of Simon Pallas, surgeon in the Prussian army, and professor of surgery in Berlin. Pallas was carefully educated by his father, being accustomed from boyhood to the use of several languages, among them English and French. He was intended for the medical profession, and his progress was such that in 1758 he lectured publicly on anatomy. Pallas studied at the universities of Berlin, Halle, Göttingen, and Leyden. He early displayed a strong leaning towards natural history investigations, which by the time he reached manhood almost monopolized his attention. In 1761 he came to England, where he spent a year, devoting himself to a thorough study of the collections he found there, and to a geological investigation of part of the English coast; and at the age of twenty-three he was elected a foreign member of the Royal Society. Pallas spent some time in Holland, where he found ample scope for investigation in his special subjects, the results of which appeared at the Hague in 1766 in his *Klenchus Zoophytorum* and *Miscellanea Zoologica*, and in 1767-1804 in his well-known *Spicilegia Zoologica* (Berlin). In 1768 he gladly accepted the invitation of the empress Catherine to fill the professorship of natural history in the Imperial Academy of Science, St Petersburg, and from that time until within a year of his death his home was in Russia. The great event of his life, and that by which he will be permanently remembered, was the expedition through Russia and Siberia in 1768-74, in which he acted as naturalist, in company with Falk, Lepechen, and Gildenstein, the immediate object being the observation of the transit of Venus in 1769. In this leisurely journey Pallas went by Kasan to the Caspian,

spent some time among the Calmucks, crossed the Urals to Tobolsk, visited the Altai Mountains, traced the Irtysh to Kolyvan, went on to Tomsk and the Yenissei, crossed Lake Baikal, and extended his journey to the frontiers of China. Few explorations have been so fruitful as this six years' journey. Pallas's collections included all departments of natural history, and his observations extended to every point of interest in the region traversed and its inhabitants. The leading results were given in his *Reisen durch verschiedene Provinzen des Russischen Reichs* (3 vols. 4to, St Petersburg, 1771-76), richly illustrated with coloured plates. A French translation in 1788-93, in 8 vols., with 9 vols. of plates, contained, in addition to the narrative, the natural history results of the expedition; and an English translation in three volumes appeared in 1812. As special results of this great journey may be mentioned *Sammlungen historischer Nachrichten über die Mongolischen Völkerschaften* (2 vols. 4to, St Petersburg, 1776-1802); *Novæ Species Quadrupedum*, 1778-79; Pallas's contributions to the dictionary of languages of the Russian empire, 1786-89; *Icones Insectorum, præsertim Rossis Siberique peculiarium*, 1781-1806; *Zoographia Rossio-Asiatica* (3 vols., 1831); besides many special papers in the *Transactions* of the academies of St Petersburg and Berlin. The empress bought Pallas's natural history collections for 20,000 roubles, 5000 more than he asked for them, and allowed him to keep them for life. He spent a considerable time in 1793-94 in visiting the southern provinces of Russia, and was so greatly taken with the Crimea that he determined to take up his residence there. The empress gave him a large estate at Simpheropol, and 10,000 roubles to assist in equipping a house. Though disappointed with the Crimea as a place of residence, Pallas continued to live there, devoted to constant research, especially in botany, till the death of his second wife in 1810, when he removed to Berlin, where he died September 8, 1811. The results of his journey in southern Russia were given in his *Bemerkungen auf einer Reise durch die südlichen Statthalterchaften des Russischen Reichs* (Leipzig, 1799-1801; English translation by Blagdon, vols. 5-8 of *Modern Discoveries*, 1802, and another in 2 vols., 1812). Pallas also edited and contributed to *Neue Nordische Beiträge zur physikalischen Erd- und Völkerbeschreibung, Naturgeschichte, und Oekonomie* (1781-96), published *Illustrationes Plantarum imperfectæ vel nondum cognitarum* (Leipzig, 1803), and contributed to Buffon's *Natural History* a paper on the formation of mountains, and to the *Transactions* of various learned societies a great number of special papers.

The solid value and great extent of Pallas's contributions to natural science have been long admitted; his name is inseparably associated with the geography (in its varied branches) of Siberia and a large part of European Russia. That he had a marked influence on the progress of zoology there is no doubt; some authorities even hold that he changed the face of the science; while his geological investigations and speculations, if they did not revolutionize the young science (as has been maintained), greatly helped its progress. Though not in any sense brilliant either as an investigator or as a writer, Pallas is certainly one of the most important figures in the science of the latter half of the 18th century.

See the Essay of Rudolphi in the *Transactions of the Berlin Academy for 1812*; Cuvier's *Eloge in his Recueil des Etapes Historiques*, vol. II.; and the Life in Jardine's *Naturalist's Library*, vol. IV., Edin., 1845.

**PALLAVICINO, FERRANTE** (1618-1644), a writer of pasquinades, who is now known chiefly for his early and tragical end, was a member of the old and widely ramified Italian family of the Pallavicini, and was born at Piacenza in 1618. He received a good education at Padua and elsewhere, and early in life entered the Augustinian order, residing chiefly in Venice. For a year he accompanied Ottavio Piccolomini, duke of Amalfi, in his German campaigns as field chaplain, and shortly after his return



he published a number of clever but exceedingly scurrilous satires on the Roman curia and on the powerful house of the Barberini, which were so keenly resented at Rome that a price was set on his head. A Frenchman of the name of Charles de Breche decoyed him from Venice, where he was comparatively safe, to the neighbourhood of Avignon, and there betrayed him into his enemies' hands. After fourteen months' imprisonment and some observance of the formalities of a trial he was beheaded at Avignon on March 6, 1644.

His *Opera Parnassica* was published at Venice in 1655, but being, as may be imagined, inferior in scurrility and grossness (Pallavicino's specialities), are much less prized by the curious than the *Opera Scelta* (Geneva, 1660), which were more than once reprinted in Holland, and were translated into German in 1668.

**PALLAVICINO, OF PALLAVIOMI, SFORZA (1607-1667)**, cardinal, representative of another branch of the same family, was born at Rome in 1607. Having taken holy orders in 1630, and joined the Society of Jesus in 1638, he successively taught philosophy and theology in the Collegio Romano; as professor of theology he was a member of the congregation appointed by Innocent X. to investigate the Jansenist heresy. In 1659 he was made a cardinal by Alexander VII. His death occurred in 1667.

Pallavicino is chiefly known by his history of the council of Trent, written in Italian, and published at Rome in two folio volumes in 1656-57 (2d edition, considerably modified, in 1666). His avowed object was to correct and supersede the very damaging work of Sarpi on the same subject, and he certainly, by virtue of his position, had access to many important sources from the use of which his predecessor had been precluded; the contending parties, however, are far from agreed as to the completeness of his success. The work was translated into Latin by a Jesuit named Giattinus (Antwerp, 1670). There is a good edition of the original by Zacharia (6 vols. 4to, 1792-99). It was translated into German by Klitsche in 1835-37.

**PALLIUM, PALLA.** These articles of Roman dress, corresponding to the Greek *himation*, are described in the article **COSTUMES** (vol. vi. pp. 453, 456-57), where also the pallium, as an ecclesiastical vestment peculiar to archbishops in the Roman Church, has been spoken of (pp. 461, 463). In the East the pallium is worn by all bishops, and one or two instances have occurred in the Western Church also in which it has been conferred by the pope on prelates of less than archiepiscopal rank. The canon law forbids archbishops to wear this vestment until it has been solemnly asked for (either personally or by deputy) and obtained from the holy see; even then it is only to be worn on certain specified occasions, such as at high pontifical masses or at an episcopal consecration. Every archbishop must apply for it within three months after his consecration, and it is buried with him at his death. The pallium is never granted until after payment of considerable dues. The pallia are prepared by nuns from white wool obtained from lambs which have been consecrated on St Agnes's eve in the church of that saint in Rome; the vestments are blessed on the festival of Saints Peter and Paul, and deposited for a night on the altar over St Peter's tomb; they are afterwards taken charge of by the subdeacon, and given out as required. The growth of the occasional practice of bestowing the pallium into an invariable custom, and of the custom into a law, will be traced in the article **POPEDOM**.

**PALM.** From their noble aspect, and perhaps from the surpassing utility of several of the members of the group, the Palms (*Palmaceæ*) have been termed the princes of the vegetable kingdom. Neither the anatomy of their stems nor the conformation of their flowers, however, entitles them to any such high position in the vegetable hierarchy. Their stems are not more complicated in structure than those of the common butcher's broom (*Ruscus*); their flowers are for the most part as simple as those of a rush (*Juncus*). For all that, palms have

always had great interest, not only for botanists, but also for the general public, in the latter case by reason of the historical and legendary interest connected with them no less than from their beauty and economic value. The order *Palmaceæ* is characterized among monocotyledonous plants by the presence of a stem very frequently unbranched, and bearing a tuft of leaves at the extremity only, or with the leaves scattered, these leaves, often gigantic in size, being usually firm in texture and branching in a pinnate or palmate fashion. The flowers are borne on simple or branching spikes, very generally protected by a spathe or spatheæ, and each consists typically of a perianth of six greenish, somewhat inconspicuous segments in two rows, with six stamens, a pistil of 1-3 carpels, each with a single ovule and a succulent or dry fruit never dehiscent (figs. 1, 2). The seed consists almost exclusively of perisperm or albumen in a cavity in which is lodged the relatively very minute embryo (fig. 3). These are the general charac-

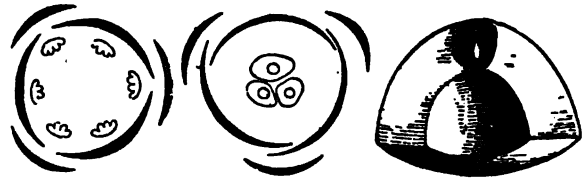

Fig. 1.

Fig. 2.

Fig. 3.

FIG. 1.—Diagram of the ♂ flower of *Chamærops*, Fan-Palm, showing six divisions of the perianth and six stamens.

FIG. 2.—Diagram of the ♀ flower of the *Chamærops*, showing six divisions of the perianth in two rows, and three cells of the ovary.

FIG. 3.—Portion of the perisperm of a palm, showing the embryo within a small cavity.

teristics by which this very well-defined order may be discriminated, but, in a group containing considerably more than a thousand species, dispersed widely and at different elevations throughout the tropics of both hemispheres, with stragglers in subtropical and even in warm temperate regions, it may well be imagined that deviations from the general plan of structure occur with some frequency. As the characteristic appearances of palms depend to a large extent upon these modifications, some of the more important among them may briefly be noticed.

Taking the stem first, we may mention that it is in very many palms relatively tall, erect, unbranched, regularly cylindrical, or dilated below so as to form an elongated cone, either smooth, or covered with the projecting remnants of the former leaves, or marked with circular scars indicating the position of those leaves which have now fallen away. In other cases the stem is very slender, short, erect, prostrate, or scandent by means of formidable hooked prickles which, by enabling the plant to support itself on the branches of neighbouring trees, also permit the stem to grow to a very great length and so to expose the foliage to the light and air above the tree-tops of the dense forests these palms grow in, as in the genus *Calamus*. In some few instances the trunk, or that portion of it which is above ground, is so short that the plant is in a loose way called "stemless" or "acaulescent," as in *Geonoma*, and as happens sometimes in the solitary species found in a wild state in Europe, *Chamærops humilis*. In many species the trunk is covered over with a dense network of stiff fibres, often compacted together at the free ends into spines. This fibrous material, which is so valuable for cordage, consists of the fibrous tissue of the leaf-stalk, which in these cases persists after the decay of the softer portions. It is very characteristic of some palms to produce from the base of the stem a series of adventitious roots which gradually thrust themselves into the soil and serve to steady the tree and prevent

its overthrow by the wind. The underground stem of some species, e.g., of *Calamus*, is a rhizome, or root-stock, lengthening in a more or less horizontal manner by the development of the terminal bud, and sending up lateral branches like suckers from the root-stock, which form dense thickets of cane-like stems. The branching of the stem above ground is unusual, except in the case of the Doum Palm of Egypt (*Hyphane*), and, when present, is probably the result of some injury to the terminal bud at the top of the stem, in consequence of which buds sprout out from below the apex.

The internal structure of the stem does not differ fundamentally from that of a typical monocotyledonous stem, the taller, harder trunks owing their hardness not only to the fibrous or woody skeleton but also to the fact that, as growth goes on, the originally soft cellular tissue through which the fibres run becomes hardened by the deposit of woody matter within the cells, so that ultimately the cellular portions become as hard as the woody fibrous matters proper.

The leaves of palms are either arranged at more or less distant intervals along the stem, as in the canes (*Calamus*, &c.), or are approximated in tufts at the end of the stem, thus forming those noble crowns of foliage which are so closely associated with the general idea of a palm. In the young condition, while still unfolded, these leaves, with the succulent end of the stem from which they arise, form "the cabbage," which in some species is highly esteemed as an article of food.

The adult leaf very generally presents a sheathing base tapering upwards into the stalk or petiole, and this again bearing the lamina or blade. The sheath and the petiole are very often provided with stout spines; and when, in course of time, the upper parts of the leaf decay and fall off the base of the leaf-stalk and sheath often remain, either entirely or in their fibrous portions only, which latter constitute the investment to the stem already mentioned. In size the leaves vary within very wide limits, some being only a few inches in extent, while those of the noble *Caryota* may be measured in tens of feet. In form the leaves of palms are very rarely simple; usually they are more or less divided, sometimes, as in *Caryota*, extremely so. In *Geonoma Verschaffeltia*, and some others, the leaf splits into two divisions at the apex and not elsewhere; but more usually the leaves branch regularly in a palmate fashion as in the fan-palms *Latania*, *Chamerops*, *Sabal*, &c., or in a pinnate fashion as in *Areca*, *Kentia*, *Calamus*, &c. The form of the segments is generally more or less linear, but a very distinct appearance is given by the broad wedge-shaped leaflets of such palms as *Caryota*, *Martinezia*, or *Mauritia*. These forms run one into another by transitional gradations; and even in the same palm the form of the leaf is often very different at different stages of its growth, so that it is a difficult matter to name correctly seedling or juvenile palms in the condition in which we generally meet with them in the nurseries, or even to foresee what the future development of the plant is likely to be. Like the other parts of the plant, the leaves are sometimes invested with hairs or spines; and, in some instances, as in the magnificent *Ceroxydon asiatica*, the under surface is of a glaucous white or bluish colour.

The inflorescence of palms consists generally of a fleshy spike like that of an *Arum*, either simple or much branched, studded with numerous, sometimes extremely numerous, flowers, and enveloped by one or more sheathing bracts called "spathe." These parts may be small, or they may attain relatively enormous dimensions, hanging down from amid the crown of foliage like huge tresses and adding greatly to the noble effect of the leaves.

As to the individual flowers, they are usually small, greenish, and insignificant; their general structure has been mentioned already. Modifications from the typical structure arise from differences of texture, and specially from suppression of parts, in consequence of which the flowers are very generally unisexual (figs. 1, 2), though the flowers of the two sexes are generally produced on the same tree (monoecious), not indeed always in the same season, for a tree in one year may produce all male flowers and in the next all female flowers. Sometimes the flowers are modified by an increase in the number of parts; thus the usually six stamens may be represented by 12 to 24 or even by hundreds. The carpels are usually three in number, and more or less combined; but they may be free, and their number may be reduced to two or even one. In any case each carpel contains but a single ovula.

Owing to the sexual arrangements before mentioned, the pollen has to be transported by the agency of the wind or of insects to the female flowers. This is facilitated sometimes by the elastic movements of the stamens and anthers, which liberate the pollen so freely at certain times that travellers speak of the date-palms of Egypt (*Phoenix dactylifera*) being at daybreak hidden in a mist of pollen grains. In other cases fertilization is effected by the agency of man, who removes the male flowers and scatters the pollen over the fruit-bearing trees. This practice has been followed from time immemorial; and it afforded one of the earliest and most irrefragable proofs by means of which the sexuality of plants was finally established. The fruit which results from this process of fertilization is various: sometimes, as in the common date, it is a berry with a fleshy rind enclosing a hard stony kernel, the true seed; sometimes it is a kind of drupe as in the cocoa-nut, *Cocos nucifera*, where the fibrous central portion investing the hard shell corresponds to the fleshy portion of a plum or cherry, while the shell or nut corresponds to the stone of stone-fruits, the seed being the kernel. Sometimes, as in the species of *Sagu*, *Raphia*, &c., the fruit is covered with hard, pointed, reflexed shining scales, which give it a very remarkable appearance.

The seed varies in size, but always consists of a mass of perisperm, in which is imbedded a relatively very minute embryo (fig. 3). The hard stone of the date is the perisperm, the white flesh of the cocoa-nut is the same substance in a softer condition; the so-called "vegetable ivory" is derived from the perisperm of *Phytolopha*.

Hooker, who in his recent revision of the genera follows the work of his predecessors Martius, Wendland, and Drude, enumerates about one hundred and thirty-two genera of the order ranged under five tribes, distinguished by the nature of the foliage, the sexual conditions of the flower, the seed umbilicate or not, the position of the raphe, &c. Other characters serving to distinguish the minor groups are afforded by the habit, the position of the spathe, the "æstivation" of the flower, the nature of the stigma, the ovary, fruit, &c.

It is impossible to overestimate the utility of palms. They furnish food, shelter, clothing, timber, fuel, building materials, sticks, fibre, paper, starch, sugar, oil, wax, wine, tannin, dyeing materials, resin, and a host of minor products, which render them most valuable to the natives and to tropical agriculturists. The Cocoa-nut Palm, *Cocos nucifera*, and the Date Palm, *Phoenix dactylifera*, have been treated under separate headings. Sugar and liquids capable of becoming fermented are produced by *Caryota urens*, *Cocos nucifera*, *Borassus flabelliformis*, *Rhapis vinifera*, *Arenga saccharifera*, *Phoenix silvestris*, *Mauritia vinifera*, &c. Starch is procured in abundance from the stem of the Sago Palm, *Sagu Rumphii*, and other species. The seeds of *Elais guineensis* of western tropical Africa yield, when

crushed and boiled, "palm oil." Cocoa-nut oil is extracted from the cocoa-nut. Wax is exuded from the stem of *Ceroxylon andicola* and *Copernicia carifera*. A variety of "dragon's blood," a resin, is procured from *Calamus Draco* and other species. Edible fruits are yielded by the date, the staple food of some districts of northern Africa. The cocoa-nut is a source of wealth to its possessors, and many of the species are valued for their "cabbage"; but, as this is the terminal bud whose removal causes the destruction of the tree, this is a wasteful article of diet unless care be taken by judicious planting to avert the annihilation of the supplies. The famous "coco de mer," or double cocoa-nut, whose floating nuts might have suggested the twin steamboats, and are the objects of so many legends and superstitions, is known to science as *Lodoicea Sechel-larum*. The tree is peculiar to the Seychelles, where it is used for many useful purposes. Its fruit is like a huge plum, containing a stone or nut like two cocoa-nuts (in their husks) united together. These illustrations must suffice to indicate the numerous economic uses of palma.

The only species that can be cultivated in the open air in England, and then only under exceptionally favourable circumstances, are the European Fan-Palm, *Chamaerops humilis*, the Chusan Palm, *C. Fortunei*, of which specimens may be seen out of doors at Kew, Heckfield, Osborne, &c., and the Chilian *Jubæa spectabilis*. The date-palm now so commonly planted along the Mediterranean coast is the common Date-Palm; but this does not ripen its fruit north of the African coast. There are several low growing palms, such as *Rhapis flabelliformis*, *Chamaerops humilis*, &c., which are suited for ordinary green-house culture, and many of which, from the thick texture of their leaves, are enabled to resist the dry and often gas-laden atmosphere of living rooms. Many species are now cultivated for the special purpose of the decoration of apartments, particularly the very beautiful *Cocos Weddelliana*. But, to gain anything like an idea of the magnitude and majestic character of palma, a visit to such establishments as the palm stoves at Kew, Edinburgh, or Chatsworth is necessary. In some instances, as in the famous Talipot Palm, *Borassus flabelliformis*, the tree does not flower till it has arrived at an advanced age and acquired a large stature, and, having produced its flowers, it dies like an annual weed.

(M. T. M.)

PALMA, the chief town of the Spanish province of Baleares, the residence of a captain general, a bishop's see, and a flourishing seaport, is situated 135 miles from Barcelona, on the south-west-coast of Majorca, at the head of the fine Bay of Palma, which stretches inland for about 10 miles between Capes Cala Figuera and Regana. It is the meeting place of all the highways in the island, and the terminus of the railway which (opened in 1875) runs to Inca and (1879) Manacor, and will be extended to Alcudia. The ramparts, which enclosed the city on all sides except towards the port (where they were thrown down in 1872), have a circuit of a little more than 4 miles. Though begun in 1562, after the plans of Georgio Fretin, they were not finished till 1836. Palma has undergone considerable change since 1860; streets have been widened and houses built in the ordinary modern style, and the fine old-world Moorish character of the place has suffered accordingly. The more conspicuous buildings are the cathedral, the exchange, the palace, now occupied by the captain-general and the law courts, the general hospital (1456), the town-house (end of the 16th century), the picture gallery, and the college. As the time of the partial suppression in 1835 there were twenty-five monastic buildings in Palma; none of those still extant are of much note. The church of San Francisco is interesting for the tomb of Raymond Lully, a native of Palma. The cathedral, a fine

Gothic building with massive buttresses, crowns the summit of the hill on which the city stands. It was erected and dedicated to the Virgin in terms of a vow made by King Jayme as he sailed to the conquest of Majorca, but, though commenced in 1230, it was not finished till 1601. The older and more interesting portions are the royal chapel (1232), with the tomb (1779) of Jayme II, and the south front with the doorway known as *del mirador* (1389). The principal dimensions of the edifice are—length from the door to the high altar, 347 feet; width, including the chapels, 190 feet; height of the central nave, 147 feet; height of the side nave, 78 feet; and height of the belfry tower, 166. Of the architecture of the exchange (*lonja*), a Gothic building begun in 1426, the people of Palma are particularly proud, as it excited the admiration of the emperor Charles V. The columns of the windows, in black and grey marble, are of almost unexampled slenderness. The harbour (formed by a mole constructed to a length of 387 yards in the 14th century and afterwards extended to more than 650 yards), has been greatly improved and enlarged since 1875 by dredging operations and a further addition to the mole of 136 yards. Previously it was not accessible to vessels drawing more than 18 feet, and men-of-war and large merchant steamers were obliged to anchor in the bay, which is sometimes rendered dangerous by violent storms. Porto Pi, about 2 miles from the city, was once a good harbour, but is now fit only for small craft. Shoemaking, tanning, and rope-spinning are prosecuted on a very extensive scale; and direct commerce is carried on with Valencia, Barcelona, Algeria, Marseilles, Cuba, Porto Rico, &c. Many of the Majorcan vessels used to be Palma-built, but the increase of steam navigation has changed the character of the trade. The population of the ayuntamiento, 53,019 in 1860, was 58,224 in 1877. There is a considerable number of Christian Jews (*Chuetas*) who were formerly confined to their own quarter.

Palma probably owes, if not its existence, at least its name (symbolized on the Roman coin by a palm branch), to Metellus Balearius, who in 123 B.C. settled three thousand Roman and Spanish colonists on the island. The bishopric dates only from the 14th century, its foundation having been strongly opposed by the bishop of Barcelona. About a mile south-west of Palma is the castle of Bellver, where Jovellanos and Arago were imprisoned.

PALMA, distinguished since 1861 as Palma Campania, a city of Italy, in the province of Caserta,  $4\frac{1}{2}$  miles south of Nola. The population was 5858 in 1881.

PALMA, distinguished since 1861 as Palma di Montechiaro, a city of Italy, in the province of Girgenti, Sicily, 13 miles S.E. of Girgenti. Though situated some distance inland, it has a port of considerable value to the coasting trade. The exports are wine, dried fruits, soda, and sulphur. Hodierna, the mathematician (1597–1660), was a priest at Palma patronized by the duke of Palma. The population, 13,458 in 1871, was 11,702 in 1881.

PALMA, one of the CANARY ISLANDS (*q.v.*).

PALMA, JACOPO, a painter of the Venetian school, was born at Sernalta near Bergamo, towards 1480, and is said to have died at the age of forty-eight, or towards 1528. He is currently named Palma Vecchio (Old Palma) to distinguish him from Palma Giovane, his grand-pew, a much inferior painter. About the facts of his life little is known. He is reputed to have been a companion and competitor of Lorenzo Lotto, and to some extent a pupil of Titian, after arriving in Venice early in the 16th century; he may also have been the master of Bonifazio. His earlier works are in the older manner, and betray the influence of the Bellini; but, modifying his style from the study of Giorgione and Titian, Palma took high rank among those painters of the distinctively Venetian type who remain a little below the leading masters. For rich-

ness and suffusion of colour he is hardly to be surpassed; but neither in invention, strength of character, nor vigorous draughtmanship does he attain any peculiar excellence. His finish is great, his draperies ample, his flesh golden-hued. He painted many fine portraits. A face frequently seen in his pictures is that of his daughter Violante, of whom Titian was more or less enamoured. Two works by Palma are more particularly celebrated. The first is a composition of six paintings in the Venetian church of S. Maria Formosa, with St Barbara in the centre, under the dead Christ, and to right and left Sts Dominic, Sebastian, John Baptist, and Anthony. The second work is in the Dresden Gallery, representing three sisters seated in the open air (presumably the painter's daughters); it is frequently named The Three Graces. Other leading examples are—the Last Supper, in S. Maria Mater Domini; a Madonna, in the church of S. Stefano in Vicenza; the Epiphany, in the Brera of Milan; the Holy Family, with a young shepherd adoring, in the Louvre; St Stephen and other Saints, Christ and the Widow of Nain, and the Assumption of the Virgin, in the Accademia of Venice; and Christ at Emmaus, in the Pitti Gallery. Palma's grand-nephew, Palma Giovane, was also named Jacopo (1544 to about 1626). His works, which are extremely numerous in Venice, and many of them on a vast scale, belong to the decline of Venetian art.

**PALMAS, LAR.** See CANARY ISLANDS, vol. iv. p. 799.

**PALMER, EDWARD HENRY** (1840–1882), Orientalist, was born at Cambridge, August 7, 1840. He lost his parents when he was a mere child, and was then brought up by an aunt. As a schoolboy he showed the characteristic bent of his mind by picking up the Romany tongue and a great familiarity with the inner life of the Gipsies. He was not, however, remarkably bookish, and from school was sent to London as a clerk in the City. Palmer disliked this life, and varied it by learning French and Italian, mainly by frequenting the society of foreigners wherever he could find it. He had a peculiar gift for making himself at home with all manner of strange people, which served him throughout life, and was as effective with Orientals as with Europeans. His linguistic faculty was in fact only one side of a great power of sympathetic imitation. He learned always from men rather than from books, and by throwing his whole flexible personality into unison with those from whom he was learning. In 1859 Palmer returned to Cambridge, apparently dying of consumption. He had an almost miraculous recovery, and in 1860, while he was thinking of a new start in life, fell in at Cambridge with a certain Sayyid Abdullah, a teacher of Eastern languages. Under his influence he resolved to give himself to Oriental studies, in which he made very rapid progress. He now attracted the notice of two fellows of St John's College, became an undergraduate there, and in 1867 was elected a fellow on the ground of his attainments, especially in Persian and Hindustani. He was soon engaged to join the survey of Sinai, and followed up this work in 1870 by exploring the Wilderness of the Wandering along with Drake. After a visit to Palestine and the Lebanon he returned to England in 1870, and next year published his *Desert of the Exodus*. In the close of the year 1871 he became Lord Almoner's Professor of Arabic at Cambridge, married, and settled down to teaching work. Unhappily his affairs were somewhat straitened, mainly through the long illness of his wife, whom he lost in 1878; he was obliged to use his pen for Oriental and other work in a way that did not do full justice to his talents, and at length he became absorbed in journalism. In 1881, two years after his second marriage, he finally left Cambridge and ceased to teach. In the following year he

was asked by the Government to go to the East and assist the Egyptian expedition by his knowledge and his great influence over the Arabs of the desert Al-Tih. It was a hazardous task, but Palmer rightly judged that he could not refuse his country a service which no one else was able to render. He went to Gaza, and without an escort made his way safely through the desert to Suez—an exploit of singular boldness, which gave the highest proof of his capacity for dealing with the Bedouins. From Suez he was again sent into the desert with Captain Gill, to procure camels and do other service of a very dangerous kind, and on this journey he and his companion were attacked and murdered (August 1882). Their remains were recovered after the war, and now lie in St Paul's Cathedral.

Palmer's highest qualities appeared in his travels, especially in the heroic adventures of his last journey. His brilliant scholarship is also seen to advantage in what he wrote in Persian and other Eastern languages, but not so much so in his English books, which were generally written under pressure. His scholarship was wholly Eastern in character, and lacked the critical qualities of the modern school of Oriental learning in Europe. All his works show a great linguistic range and very versatile talent; but he was cut off before he was able to leave any permanent literary monument worthy of his powers. His chief writings are *The Desert of the Exodus*, 1871; *Poems of Behá ed Din* (Ar. and Eng., 2 vols.), 1876–77; *Arabic Grammar*, 1877; *History of Jerusalem*, 1871 (by Besant and Palmer—the latter wrote the part taken from Arabic sources); *Persian Dictionary*, 1876, and *English and Persian Dictionary* (posthumous, 1883); translation of the *Qur'án* (unsatisfactory), 1880. He also did good service in editing the *Name Lists of the Palestine Exploration*.

**PALMER, SAMUEL** (1805–1881), landscape painter and etcher, was born in London on the 27th January 1805. He was delicate as a child, and received his education, in which a study of the classics—English as well as Greek and Latin—played a notable part, at home under the wise and genial care of his father. In 1819 we find him exhibiting both at the Royal Academy and the British Institution; and shortly afterwards he became intimate with John Linnell, who gave him excellent counsel and assistance, advising drawing from the figure and from the antique in the British Museum, and introducing him to Varley, Mulready, and, above all, to William Blake, whose strange and mystic genius had the most powerful effect in impressing on Palmer's art its solemn and poetic character. Before very long the studies of this period were interrupted by an illness which led to a residence of seven years at Shoreham in Kent. Here the artist sought a closer acquaintance with nature, and the characteristics of the scenery of the district are constantly recurrent in his works. Among the more important productions of this time are the Bright Cloud and the Skylark, paintings in oil, which was Palmer's usual medium in earlier life, but one with which he is now hardly at all associated in the popular mind. In 1839 he married a daughter of Linnell's. The wedding tour was to Italy, where he spent over two years in study. Returning to London, he was in 1843 elected an associate and in 1854 a full member of the Society of Painters in Water Colours, a method to which he afterwards adhered in his painted work. His productions are distinguished by an excellent command over the forms of landscape, and by mastery of rich, glowing, and potent colouring. He delighted in the more exceptional and striking moments of nature, and especially in her splendours of sunrise and sunset. His paintings are less literal transcripts than poetic and imaginative renderings. They are admirably composed and well-considered pastorals, which find a singularly accurate literary parallel in the landscape work of Milton in his minor poems; indeed among the best and most important paintings executed by Palmer during his later years was a noble series of illustrations to *L'Allegro* and *Il Penseroso*, now in the possession of Mr L. R. Valpy.

In 1853 the artist was elected a member of the English Etching Club; and his work with the needle is no less individual and poetic than his work with the brush. Mr Hamerton has pronounced him "one of the few really great English etchers," "one of the most accomplished etchers who ever lived." Considering his reputation and success in this department of art, his plates are few in number. They are executed with care and elaboration. Their virtues are not those of a rapid and vivid sketch, depending on force and selection of line, and adopting a frankly interpretative treatment; they aim rather at truth and completeness of tonality, and embody many of the characteristics of other modes of engraving—of mezzotint, of line, and of woodcut. Readily accessible and sufficiently representative plates may be studied in the *Early Ploughman*, in *Etching and Etchers* (1st ed.), and the *Herdsmen's Cottage*, in the third edition of the same work. In 1861 Palmer removed to Reigate, where he spent an honoured and productive old age, till his death on the 24th of May 1861. One of his latest efforts was the production of a series of etchings to illustrate his English metrical version of Virgil's *Eclogues*, which was published in 1853, illustrated with reproductions of the artist's water-colours and with etchings, of which most were left unfinished at his death, and completed by his son, A. H. Palmer. A collection of Palmer's works was brought together by the Fine Arts Society in the year of his death. The descriptive and critical catalogue of this exhibition, and the memoir by his son, may be consulted for particulars of the painter's life and art.

**PALMERSTON, HENRY JOHN TEMPLE, VISCOUNT,** (1784-1865), statesman, minister of foreign affairs, and twice prime minister of England, was born at Broadlands, near Romsey, Hants, on the 20th October 1784. The Irish branch of the Temple family, from which Lord Palmerston descended, was very distantly related to the great English house of the same name, which played so conspicuous a part in the politics of the 18th century; but these Irish Temples were not without distinction. In the reign of Elizabeth they had furnished a secretary to Sir Philip Sidney and to Essex. In the reign of William and Mary Sir William Temple figured as one of the ablest diplomatists of the age. From his younger brother, who was speaker of the Irish House of Commons, Lord Palmerston descended; the son of the speaker was created a peer of Ireland, March 12, 1722, and was succeeded by his grandson, the second viscount, who married a Miss Mee, a lady celebrated for her beauty, who became the mother of the subject of this notice. Lord and Lady Palmerston were persons of great taste and fashion, who travelled several times in Italy with their children. Their eldest son, Henry John, is mentioned by Lady Elliot in her correspondence as a boy of singular vivacity and energy. These qualities adhered to him through life, and he had scarcely left Harrow, at the age of eighteen, when the death of his father (April 17, 1802) raised him to the Irish peerage, and placed him at the head of his family. It was no doubt owing to his birth and connexions, but still more to his own talents and character, that Lord Palmerston was thrown at a very early age into the full stream of political and official life. Before he was four-and-twenty he had stood two contested elections for the university of Cambridge, at which he was defeated, and he entered parliament for a pocket-borough, Newtown, Isle of Wight, in June 1807. Through the interest of his guardians Lord Malmesbury and Lord Chichester, the duke of Portland made him one of the junior lords of the Admiralty on the formation of his administration in 1807. A few months later he delivered his maiden speech in the House of Commons in defence of the expedition against

Copenhagen, which he conceived to be justified by the known designs of Napoleon on the Danish court. This speech was so successful that it marked him out as one of the rising statesmen of the day, in so much that, when Perceval formed his Government in 1809, he proposed to this young man of five-and-twenty to take the chancellorship of the exchequer, following apparently the examples of Pitt and Lord Henry Petty, who had filled that office at about the same age. Lord Palmerston, however, though extremely surprised and flattered by the proposal, had the wisdom to refuse it, on the ground that he was totally ignorant of finance, and had only once addressed the House of Commons. Nor did he allow the offer of a seat in the cabinet to break his modest resolution. He contented himself with the far less important office of secretary at war, charged exclusively with the financial business of the army, without a seat in the cabinet, and in this position he remained, singularly enough, without any signs of an ambitious temperament or of great political abilities, for twenty years (1809-1828). His administrative talents were confined within the limits of the War Office, which he kept in perfect order, and his parliamentary speeches to the annual statements in which he moved the army estimates of those eventful years. During the whole of that period Lord Palmerston was chiefly known as a man of fashion, and a subordinate minister without influence on the general policy of the cabinets he served. Some of the most humorous poetical pieces in the *New Whig Guide* were from his pen, and he was entirely devoted, like his friends Peel and Croker, to the Tory party of that day.

The political opinions of Lord Palmerston at that time, and perhaps through life, were those of the school of Pitt—not the effete Toryism of the Pitt clubs, which he always treated with disdain, but the enlarged Conservative views of the great minister himself, as represented after Pitt's death by Canning. Lord Palmerston never was a Whig, still less a Radical; he was a statesman of the old English aristocratic type, liberal in his sentiments, favourable to the cause of justice and the march of progress, but entirely opposed to the claims of democratic government. Thus he supported from the first the cause of Catholic emancipation, and he sympathized warmly with the constitutional party throughout the world, but he was opposed to the extension of the franchise in England, and he regarded the impulse of popular power as a force to be directed and controlled rather than obeyed. So successfully did he practise the art of governing a free people that he lived to be regarded as a popular minister, though he had been for twenty years a member of a Tory Government, and never materially altered his own opinions.

In the later years of Lord Liverpool's administration, after the death of Lord Londonderry in 1823, strong dissensions existed in the cabinet. The Liberal section of the Government was gaining ground. Canning became foreign minister and leader of the House of Commons. Huskisson began to advocate and apply the doctrines of free trade. Catholic emancipation was made an open question. Although Lord Palmerston was not in the cabinet, he cordially supported the measures of Canning and his friends. Upon the death of Lord Liverpool, Canning was called to the head of affairs; the Tories, including Peel, withdrew their support, and an alliance was formed between the Liberal members of the late ministry and the Whigs. In this combination the chancellorship of the exchequer was first offered to Lord Palmerston, who accepted it, but this appointment was frustrated by the king's intrigue with Herries, and Palmerston was content to remain secretary at war with a seat in the cabinet, which he now entered for the first time. The Canning administration ended in four months by the death of its

illustrious chief, and was succeeded by the feeble ministry of Lord Goderich, which barely survived the year. But the "Canningites," as they were termed, remained, and the duke of Wellington hastened to include Palmerston, Huskisson, Charles Grant, Lamb, and Dudley in his Government. A dispute between the duke and Huskisson soon led to the resignation of that minister, and his friends felt bound to share his fate. In the spring of 1828 Palmerston found himself, for the first time in his life, in opposition. From that moment he appears to have directed his attention closely to foreign affairs; indeed he had already urged on the duke of Wellington a more active interference in the affairs of Greece; he had made several visits to Paris, where he foresaw with great accuracy the impending revolution; and on the 1st June 1829 he made a speech on foreign affairs of such excellence that never but once in his long career did he surpass it. For it may here be remarked that Lord Palmerston was no orator; his language was unstudied, and his delivery somewhat embarrassed; but he generally found words to say the right thing at the right time, and to address the House of Commons in the language best adapted to the capacity and the temper of his audience. An attempt was made by the duke of Wellington in September 1830 to induce Palmerston to re-enter the cabinet, which he refused to do without Lord Lansdowne and Lord Grey, and from that time forward he may be said to have associated his political fortunes with those of the Whig party. It was therefore natural that Lord Grey should place the department of foreign affairs in his hands upon the formation of the great ministry of 1830, and Palmerston entered with zeal on the duties of an office over which he continued to exert his powerful influence, both in and out of office, for twenty years.

The revolution of July 1830 had just given a strong shock to the existing settlement of Europe. The kingdom of the Netherlands was rent asunder by the Belgian revolution; Portugal was the scene of civil war; the Spanish succession was about to open and place an infant princess on the throne. Poland was in arms against Russia, and the Northern powers formed a closer alliance, threatening to the peace and the liberties of Europe. In presence of these varied dangers, Lord Palmerston was prepared to act with spirit and resolution. The king of the Netherlands had appealed to the powers who had placed him on the throne to maintain his rights; and a conference assembled accordingly in London to settle the question, which involved the independence of Belgium and the security of England. On the one hand, the Northern powers were anxious to defend the king of Holland; on the other hand a party in France aspired to annex the Belgian provinces. The policy of the British Government was a close alliance with France, but an alliance based on the principle that no interests were to be promoted at variance with the just rights of others, or which could give to any other nation well-founded cause of jealousy. If the Northern powers supported the king of Holland by force, they would encounter the resistance of France and England united in arms; if France sought to annex Belgium she would forfeit the alliance of England, and find herself opposed by the whole continent of Europe. In the end the policy of England prevailed; numerous difficulties, both great and small, were overcome by the conference; although on the verge of war, peace was maintained; and Prince Leopold of Saxe-Coburg was placed upon the throne of Belgium, which enjoyed for half a century the benefits of his enlightened rule, followed with equal success by that of his son and successor. Upon the whole this transaction may be regarded as the most important and most successful of Lord Palmerston's public life.

In 1833 and 1834 the youthful queens Donna Maria of Portugal and Isabella of Spain were the representatives and the hope of the constitutional party in those countries,—assailed and hard pressed by their absolutist kinsmen Don Miguel and Don Carlos, who were the representatives of the male line of succession. Lord Palmerston conceived and executed the plan of a quadruple alliance of the constitutional states of the West to serve as a counterpoise to the Northern alliance. A treaty for the pacification of the Peninsula was signed in London on the 22d April 1834; and, although the struggle was somewhat prolonged in Spain, it accomplished its object. France, however, had been a reluctant party to this treaty. She never executed her share in it with zeal or fidelity. Louis Philippe was accused of favouring the Carlists underhand, and he positively refused to be a party to direct interference in Spain. It is probable that the hesitation of the French court on this question was one of the causes of the extreme personal hostility Lord Palmerston never ceased to show towards the king of the French down to the end of his life, if indeed that sentiment had not taken its origin at a much earlier period. Nevertheless, at this same time (June 1834) Lord Palmerston wrote that "Paris is the pivot of my foreign policy." M. Thiers was at that time in office. Unfortunately these differences, growing out of the opposite policies of the two countries at the court of Madrid, increased in each succeeding year; and a constant but sterile rivalry was kept up, which ended in results more or less humiliating and injurious to both nations.

The affairs of the East interested Lord Palmerston in the highest degree. During the Greek War of Independence he had strenuously supported the claims of the Hellenes against the Turks and the execution of the treaty of London. But from 1830 the defence of the Ottoman empire became one of the cardinal objects of his policy. He believed in the regeneration of Turkey. "All that we hear," he wrote to Mr Bulwer, "about the decay of the Turkish empire, and its being a dead body or a sapless trunk, and so forth, is pure unadulterated nonsense." The two great aims he had in view were to prevent the establishment of Russia on the Bosphorus and the establishment of France on the Nile, and he regarded the maintenance of the authority of the Porte as the chief barrier against both these aggressions. Against Russia he had long maintained a suspicious and hostile attitude. He was a party to the publication of the "Portfolio" in 1834, and to the mission of the "Vixen" to force the blockade of Circassia about the same time. He regarded the treaty of Unkiar Skelessi which Russia extorted from the Porte in 1832, when she came to the relief of the sultan after the battle of Konieh, with great jealousy; and, when the power of Mohammed Ali in Egypt appeared to threaten the existence of the Ottoman dynasty, he succeeded in effecting a combination of all the powers, who signed the celebrated collective note of 27th July 1839, pledging them to maintain the independence and integrity of the Turkish empire as a security for the peace of Europe. On two former occasions, in 1833 and in 1835, the policy of Lord Palmerston, who proposed to afford material aid to the Porte against the pasha of Egypt, was overruled by the cabinet; and again, in 1839, when Baron Brunnow first proposed the active interference of Russia and England, the offer was rejected. But in 1840 Lord Palmerston returned to the charge and prevailed. The moment was critical, for Mohammed Ali had occupied Syria and won the battle of Nezib against the Turkish forces, and on the 1st July 1839 the sultan Mohammed expired. The Egyptian forces occupied Syria, and threatened Turkey; and Lord Ponsonby, then British ambassador at Constantinople, vehemently urged the necessity of crushing so



formidable a rebellion against the Ottoman power. But France, though her ambassador had signed the collective note in the previous year, declined to be a party to measures of coercion against the pasha of Egypt. Palmerston, irritated at her Egyptian policy, flung himself into the arms of the Northern powers, and the treaty of the 15th July 1840 was signed in London without the knowledge or concurrence of France. This measure was not taken without great hesitation, and strong opposition on the part of several members of the British cabinet. Lord Holland and Lord Clarendon and some other ministers thought that, whatever might be the merits of the quarrel between the sultan and the pasha, our interference was not worth the price we were paying for it—an alliance with Russia and the rupture of our alliance with France; and the Government was more than once on the point of dissolution. Lord Palmerston himself declared in a letter to Lord Melbourne that he should quit the ministry if his policy was not adopted; and he carried his point. His consummate knowledge of details, his administrative ability, his impetuous will, and his conviction that France could not declare war against the four great powers of Europe prevailed over the resistance of an indolent premier and hesitating colleagues. The operations were conducted with extraordinary promptitude, good fortune, and success. The bombardment of Beirut, the fall of Acre, and the total collapse of the boasted power of Mohammed Ali followed in rapid succession, and before the close of the year Lord Palmerston's policy, which had convulsed and terrified Europe, was triumphant, and the author of it was regarded as one of the most powerful statesmen of the age. At the same time, though acting with Russia in the Levant, the British Government engaged in the affairs of Afghanistan to defeat her intrigues in Central Asia, and a contest with China was terminated by the conquest of Chusan, afterwards exchanged for the island of Hong Kong. Seldom has Great Britain occupied a prouder position abroad, although by a singular contrast the cabinet was in the last stage of decrepitude at home. Within a few months Lord Melbourne's administration came to an end, and Lord Palmerston remained for five years out of office. The crisis was past, but the change which took place by the substitution of M. Guizot for M. Thiers in France, and of Lord Aberdeen for Lord Palmerston in England, was a fortunate event for the peace of the world. Lord Palmerston had adopted the opinion that peace with France was not to be relied on, and indeed that war between the two countries was sooner or later inevitable. France was in his eyes a power likely to become an enemy; and he encouraged the formation of an English party to thwart her influence all over the world. Had he remained in office, the exasperation caused by his Syrian policy and his harsh refusal to make the slightest conciliatory concession to France, in spite of the efforts of his colleagues, would probably have led to fresh quarrels, and the emperor Nicholas would have achieved his main object, which was the complete rupture of the Anglo-French alliance. Lord Aberdeen and M. Guizot inaugurated a different policy; by mutual confidence and friendly offices they entirely succeeded in restoring the most cordial understanding between the two Governments, and the irritation which Lord Palmerston had inflamed gradually subsided. During the administration of Sir Robert Peel, Lord Palmerston led a retired life, but he attacked with characteristic bitterness the Ashburton treaty with the United States, which closed successfully some other questions he had long kept open. In all these transactions, whilst full justice must be done to the force and patriotic vigour which Lord Palmerston brought to bear on the questions he took in hand, it was but too apparent that he imported into them

an amount of passion, of personal animosity, and imperious language which rendered him in the eyes of the queen and of his colleagues a dangerous minister. On this ground, when Lord John Russell attempted, in December 1845, to form a ministry, the combination failed because Lord Grey refused to join a Government in which Lord Palmerston should resume the direction of foreign affairs. A few months later, however, this difficulty was surmounted; the Whigs returned to power, and Palmerston to the foreign office, with a strong assurance that Lord John Russell should exercise a strict control over his proceedings. A few days sufficed to show how vain was this expectation. The French Government regarded the appointment of Palmerston as a certain sign of renewed hostilities, and they availed themselves of a despatch in which Palmerston had put forward the name of a Coburg prince as a candidate for the hand of the young queen of Spain, as a justification for a departure from the engagements entered into between M. Guizot and Lord Aberdeen. However little the conduct of the French Government in this transaction of the Spanish marriages can be vindicated, it is certain that it originated in the belief that in Palmerston France had a restless and subtle enemy. The efforts of the British minister to defeat the French marriages of the Spanish princesses, by an appeal to the treaty of Utrecht and the other powers of Europe, were wholly unsuccessful; France won the game, though with no small loss of honourable reputation. Not long afterwards Sir Henry Bulwer was expelled from the Peninsula for an attempt to lecture General Narvaes on his duties, and for his notorious intrigues with the opposition; and in Paris the British embassy became the centre of every species of attack on the king's Government, so that friendly diplomatic relations were temporarily interrupted with both countries. No doubt the rupture of the Anglo-French alliance and the tension existing between the two Governments contributed in some degree to the catastrophe of 1848, which drove Louis Philippe from the throne, and overthrew the constitutional monarchy in France; but Palmerston did not regret the occurrence or foresee all its consequences.

The revolution of 1848 spread like a conflagration through Europe, and shook every throne on the Continent except those of Russia and Spain and Belgium. Palmerston sympathized, or was supposed to sympathize, openly with the revolutionary party abroad. No state was regarded by him with more aversion than Austria. Prince Metternich he abhorred; and, with some inconsistency, after the fall of Metternich he still pursued a policy of unrelenting hostility to his successors. Yet his opposition to Austria was chiefly based upon her occupation of great part of Italy and her Italian policy, for Palmerston maintained that the existence of Austria as a great power north of the Alps was an essential element in the system of Europe. Antipathies and sympathies had a large share in the political views of Lord Palmerston, and his sympathies had ever been passionately awakened by the cause of Italian independence. He knew the country; he knew the language; and in London some of his closest friends were Italians, actively engaged in the national cause. Hence he threw all the moral support he could give into the Italian revolution. He supported the Sicilians against the king of Naples, and even allowed arms to be sent them from the arsenal at Woolwich; and, although he had endeavoured to restrain the king of Sardinia from his rash attack on the superior forces of Austria, he obtained for him a reduction of the penalty of defeat. Austria, weakened by the revolution, sent an envoy to London to request the mediation of England, based on a large cession of Italian territory; Lord Palmerston rejected the terms

he might have obtained for Piedmont. Ere long the reaction came; this straw-fire of revolution burnt itself out in a couple of years. In Hungary the civil war, which had thundered at the gates of Vienna, was brought to a close by Russian intervention. Prince Schwarzenberg assumed the government of the empire with dictatorial power; and, in spite of what Palmerston termed his "judicious bottle-holding," the movement he had encouraged and applauded, but to which he could give no material aid, was everywhere subdued. The British Government, or at least Palmerston as its representative, was regarded with suspicion and resentment by every power in Europe, except the French republic; and even that was shortly afterwards to be alienated by his attack on Greece.

This state of things was regarded with the utmost annoyance by the British court and by most of the British ministers. Palmerston had on many occasions taken important steps, without their knowledge, which they disapproved. Over the foreign office he asserted and exercised an arbitrary dominion, which—the feeble efforts of the premier could not control. The queen and the prince consort did not conceal their indignation at the position in which he had placed them with all the other courts of Europe. When Kossuth, the Hungarian leader, landed in England, after having been rescued by Palmerston from the demands made for his surrender, he proposed to receive this personage at Broadlands, a design which was only prevented by a peremptory vote of the cabinet; and in 1850 he took advantage of some very questionable claims on the Hellenic Government to organize an attack on the little kingdom of Greece. Greece being a state under the joint protection of three powers, Russia and France protested against this outrage, and the French ambassador temporarily left London, which promptly led to the termination of the affair. But it was taken up in parliament with great warmth. After one of the most memorable debates of this century, Palmerston's policy was condemned by a deliberate vote of the House of Lords. The House of Commons was moved by Roebuck to reverse the sentence, which it did by a majority of forty-six, after having heard from Palmerston the most eloquent and powerful speech ever delivered by him, in which he sought to vindicate, not only his claims on the Greek Government for Don Pacifico, but his entire administration of foreign affairs. It was in this speech, which lasted five hours, that Palmerston made the well-known declaration that a British subject—"Civis Romanus sum"—ought everywhere to be protected by the strong arm of the British Government against injustice and wrong. The entire Liberal party, from motives of party allegiance and patriotism, supported the minister who uttered these words. Even Sir Robert Peel, who opposed the resolution, said that the country was proud of him. Yet notwithstanding this parliamentary triumph, there were not a few of his own colleagues and supporters who condemned the spirit in which the foreign relations of the crown were carried on; and in that same year the queen addressed a minute to the prime minister in which Her Majesty recorded her dissatisfaction at the manner in which Lord Palmerston evaded the obligation to submit his measures for the royal sanction, as failing in sincerity to the crown. This minute was communicated to Palmerston, who did not resign upon it. These various circumstances, and many more, had given rise to distrust and uneasiness in the cabinet, and these feelings reached their climax when Palmerston, on the occurrence of the *coup d'état* by which Louis Napoleon made himself master of France, expressed to the French ambassador in London, without the concurrence of his colleagues, his personal approval of that act of lawless violence. Upon this, Lord John Russell advised his dismissal from office (December

1851). Palmerston speedily avenged himself by turning out the Government on a Militia Bill; but, although he survived for many years, and twice filled the highest office in the state, his career as foreign minister ended for ever, and he returned to the foreign office no more. Indeed he assured Lord Aberdeen, in 1853, that he did not wish to resume the seals of that department. Notwithstanding the seal and ability which he had invariably displayed as foreign minister, it had long been felt by his colleagues that his eager and frequent interference in the affairs of foreign countries, his imperious temper, the extreme acerbity of his language abroad, of which there are ample proofs in his published correspondence, and the evasions and artifices he employed to carry his points at home rendered him a dangerous representative of the foreign interests of the country. He accused every foreign statesman who differed from him of "bully and swagger"; foreign statesmen in more polite language imputed the same defects to him. The lesson of his dismissal from office was not altogether lost upon him; and, although his great reputation was chiefly earned as a foreign minister, it may be said that the last ten years of his life, in which he filled other offices, were not the least useful or dignified portion of his career.

Upon the formation of the cabinet of 1853, which was composed by the junction of the surviving followers of Sir Robert Peel with the Whigs, under the earl of Aberdeen, Lord Palmerston accepted with the best possible grace the office of secretary of state for the Home Office. He speedily overcame the slight hesitation or reluctance he had expressed when the offer was first made to him, on the ground that the views of Lord Aberdeen and Lord Clarendon on foreign affairs had differed widely from his own; nor was he ever chargeable with the slightest attempt to undermine that Government. At one moment he withdrew from it, because Lord John Russell persisted in presenting a project of reform, which appeared to him entirely out of season; and he advocated, with reason, measures of greater energy on the approach of war, which might possibly, if they had been adopted, have averted the contest with Russia. As the difficulties of the Crimean campaign increased, it was not Lord Palmerston but Lord John Russell who broke up the Government by refusing to meet Roebuck's motion of inquiry. Palmerston remained faithful and loyal to his colleagues in the hour of danger. Upon the resignation of Lord Aberdeen and the duke of Newcastle, the general sentiment of the House of Commons and the country called Palmerston to the head of affairs, and he entered, on the 5th of February 1855, upon the high office which he retained, with one short interval, to the day of his death. Palmerston was in the seventy-first year of his life when he became prime minister of England.

A series of fortunate events followed his accession to power. In March 1855 the death of the emperor Nicholas removed his chief antagonist. In September Sebastopol was taken. The administration of the British army was reformed by a consolidation of offices. In the following spring peace was signed in Paris. Never since Pitt had a minister enjoyed a greater share of popularity and power, and, unlike Pitt, Palmerston had the prestige of victory in war. He was assailed in parliament by the eloquence of Gladstone, the sarcasms of Disraeli, and the animosity of the Manchester Radicals, but the country was with him. The Liberals applauded his spirit and his sympathy with the cause of liberty abroad; the Conservatives knew that he would never lend himself to rash reforms and democratic agitation at home. Defeated by a hostile combination of parties in the House of Commons on the question of the Chinese War in 1857, he dissolved the parliament and

appealed to the nation. The result was the utter defeat of the extreme Radical party, and the return of a more compact Liberal majority. The great events of the succeeding years, the Indian revolt and the invasion of Italy by Napoleon III., belong rather to the general history of the times than to the life of Palmerston; but it was fortunate that a strong and able Government was at the head of affairs. Lord Derby's second administration of 1858 lasted but a single year, Palmerston having casually been defeated on a measure for removing conspiracies to murder abroad from the class of misdemeanour to that of felony, which was introduced in consequence of Orsini's attempt on the life of the emperor of the French. But in June 1859 Palmerston returned to power, and it was on this occasion that he proposed to Cobden, one of his most constant opponents, to take office; and, on the refusal of that gentleman, Milner Gibson was appointed to the Board of Trade, although he had been the prime mover of the defeat of the Government on the Conspiracy Bill. Palmerston had learnt by experience that it was wiser to conciliate an opponent than to attempt to crush him, and that the imperious tone he had sometimes adopted in the House of Commons, and his supposed obsequiousness to the emperor of the French, were the causes of the temporary reverse he had sustained. Although Palmerston approved the objects of the French invasion of Italy, in so far as they went to establish Italian independence, the annexation of Savoy and Nice to France was an incident which revived his old suspicions of the good faith of the French emperor. A proposal was made to him to cede to Switzerland a small portion of territory covering the canton of Geneva, but he rejected the offer, saying, "We shall shame them out of it"; in this he was mistaken, and his remonstrances found no support in Europe. About this time he expressed to the duke of Somerset his conviction that Napoleon III. "had at the bottom of his heart a deep and unextinguishable desire to humble and punish England," and that war with France was a contingency to be provided against. The unprotected condition of the principal British fortresses and arsenals had long attracted his attention, and he succeeded in inducing the House of Commons to vote nine millions for the fortification of those important points.

In 1856 the projects for cutting a navigable canal through the Isthmus of Suez was brought forward by M. de Lesseps, and resisted by Palmerston with all the weight he could bring to bear against it. He did not foresee the advantages to be derived by British commerce from this great work, and he was strongly opposed to the establishment of a powerful French company on the soil of Egypt. The concession of land to the company was reduced by his intervention, but in other respects the work proceeded and was accomplished. It may here be mentioned, as a remarkable instance of his foresight, that Palmerston told Lord Malmesbury, on his accession to the Foreign Office in 1853, that the chief reason of his opposition to the canal was this:—he believed that, if the canal was made and proved successful, Great Britain, as the first mercantile state, and that most closely connected with the East, would be the power most interested in it; that this country would therefore be drawn irresistibly into a more direct interference in Egypt, which it was desirable to avoid, because England has already enough upon her hands, and because our intervention might lead to a rupture with France. He therefore preferred that no such line of communication should be opened. Recent events have shown that there was much to be said for this remarkable forecast, and that the mercantile advantages of the canal are to some extent counterbalanced by the political difficulties to which it may give rise,

Upon the outbreak of the American civil war in 1861, Lord Palmerston acknowledged that it was the duty of the British Government to stand aloof from the fray, but his own opinion led him rather to desire than to avert the rupture of the Union, which might have been the result of a refusal on the part of England and France to recognize a blockade of the Southern ports, which was notoriously imperfect, and extremely prejudicial to the interests of Europe. The cabinet was not of this opinion, and, although the belligerent rights of the South were promptly recognised, the neutrality of the Government was strictly observed. When, however, the Southern envoys were taken by force from the "Trent," a British packet, Palmerston did not hesitate a moment to exact a full and complete reparation for this gross infraction of international law, which President Lincoln was wise enough to make. But the attitude and language of some members of the British Government at that crisis, and the active operations of Southern cruisers, some of which had been fitted out by private firms in British ports, aroused a feeling of resentment amongst the American people which it took many years to efface, and which was at last removed by an award extremely onerous to England. The last transaction in which Palmerston engaged arose out of the attack by the Germanic confederation, and its leading states Austria and Prussia, on the kingdom of Denmark and the duchies of Schleswig and Holstein. There was but one feeling in the British public and the nation as to the dishonest character of that unprovoked aggression, and it was foreseen that Austria would ere long have reason to repent her share in it. Palmerston endeavoured to induce France and Russia to concur with England in maintaining the treaty of London, which had guaranteed the integrity of the Danish dominions. But those powers, for reasons of their own, stood aloof, and the conference held in London in 1864 was without effect. A proposal to send the British fleet into the Baltic was overruled, and the result was that Denmark was left to her own resources against her formidable opponents. It may be interesting to quote, as a specimen of Lord Palmerston's clear and vigorous style and insight, one of the last letters he ever wrote, for, though it relates to the affair of Schleswig-Holstein, it embraces at a glance the politics of the world.

September 18, 1865.

"MY DEAR RUSSELL,—It was dishonest and unjust to deprive Denmark of Schleswig and Holstein. It is another question how those two duchies, when separated from Denmark, can be disposed of best for the interest of Europe. I should say that, with that view, it is better that they should go to increase the power of Prussia than that they should form another little state to be added to the cluster of small bodies politic which encumber Germany, and render it of less force than it ought to be in the general balance of power in the world. Prussia is too weak as she now is ever to be honest or independent in her action; and, with a view to the future, it is desirable that Germany, in the aggregate, should be strong in order to control those two ambitious and aggressive powers, France and Russia, that press upon her west and east. As to France, we know how restless and aggressive she is, and how ready to break loose for Belgium, for the Rhine, for anything she would be likely to get without too great an exertion. As to Russia, she will, in due time, become a power almost as great as the old Roman empire. She can become mistress of all Asia, except British India, whenever she chooses to take it; and, when enlightened arrangements shall have made her revenue proportioned to her territory, and railways shall have abridged distances, her command of men will become enormous, her pecuniary means gigantic, and her power of transporting armies over great distances most formidable. Germany ought to be strong in order to resist Russian aggression, and a strong Prussia is essential to German strength. Therefore, though I heartily condemn the whole of the proceedings of Austria and Prussia about the duchies, I own that I should rather see them incorporated with Prussia than converted into an additional asteroid in the system of Europe. Yours sincerely,

PALMERSTON."

In little more than a month from the date of this letter, on the 18th October 1865, he expired at Brompton

Hall, after a short illness, in the eighty-first year of his age. His remains were laid in Westminster Abbey.

Although there was much in the official life of Lord Palmerston which inspired distrust and alarm to men of a less ardent and contentious temperament, it is certain that his ambition was not selfish but patriotic, that he had a lofty conception of the strength and the duties of England, that he was the irreconcilable enemy of slavery, injustice, and oppression, and that he laboured with inexhaustible energy for the dignity and security of the empire. In private life his gaiety, his buoyancy, his high-breeding made even his political opponents forget their differences; and even the warmest altercations on public affairs were merged in his large hospitality and cordial social relations. In this respect he was aided with consummate ability by the tact and grace of Lady Palmerston, the widow of Earl Cowper, whom he married at the close of 1839. She devoted herself with enthusiasm to all her husband's interests and pursuits, and she made his house the most attractive centre of society in London, if not in Europe.

A *Life of Lord Palmerston*, by the late Lord Dalling, was published in three volumes in 1870, which owes its chief merit to the selections from the minister's autobiographical diaries and private correspondence. The work, however, ends at the year 1840, when more than half his ministerial career remained untold. This biography was resumed and continued by Mr Evelyn Ashley in 1876, after the death of Lord Dalling; but the whole period from 1846 to 1865 is compressed into two volumes, and no doubt materials are in existence, though still unpublished, which will eventually supply a fuller account of the important part played by this eminent statesman for sixty years in the affairs of the British empire and of Europe.

**PALM SUNDAY** (*Dominica in Palmis*), the Sunday immediately before Easter (see **HOLY WEEK**), in the Roman Catholic communion is characterized by a striking ceremonial which takes place in church at the beginning of the high mass of the day. Branches of palms and olives or other trees having previously been laid in sufficient quantity in front of the high altar, the anthem Hosanna is sung by the choir, the collect is said by the celebrant, and lessons from Exodus xv. and xvi. and Matt. xxi. are sung by the subdeacon and deacon respectively. The branches of palm and olive (held to symbolize "victory over the prince of death" and "the coming of a spiritual unction") are then blessed with prayer and aspersion, whereupon the principal person of the clergy present approaches the altar, and gives a palm to the celebrant, who afterwards gives one to him, then to the rest of the clergy in the order of their rank, and finally to the laity, who receive kneeling. During the distribution appropriate antiphons are sung, and when it is over a procession begins for which there is another series of antiphons. At the return of the procession two or four singers go into the church, and, shutting the door, with their faces towards the procession, sing two lines of the hymn "Gloria, laus, et honor," which are repeated by the celebrant and others outside; this continues till the end of the hymn. The subdeacon next knocks at the door with the end of the cross he carries; the door is opened, and the procession re-enters the church. Then follows mass, when all hold the palms in their hands during the singing of the Passion and the Gospel. There is evidence that the feast of palms (*Βαῖων ἑορτή*) was observed, in the East at least, as early as the 5th century, but the earliest mention of a procession similar to that which now takes place on Palm Sunday both in the Greek and in the Latin communion occurs in an *Ordo Officii* probably not earlier than the 10th century.

**PALMYRA** is the Greek and Latin name of a famous city of the East, now sunk to a mere hamlet, but still an object of interest for its wonderful ruins, which its

Semitic inhabitants and neighbours called Tadmor. The latter name, which is found in the Bible (2 Chron. viii. 5), and is written תדמור and תדמיר in Palmyrene inscriptions, has survived to the present day, and is now locally pronounced Tadmīr or Tīdmīr. The site of Palmyra<sup>1</sup> is an oasis in the desert that separates Syria from Irak, about 50 hours' ride or 150 miles north-east from Damascus, 32 hours from Emesa, and five days' camel journey from the Euphrates.<sup>2</sup> The hills which fringe the oasis mark the northern limit of the great Syrian desert. The direct route between the Phœnician ports and the cities of Irak and the Persian Gulf would be from Damascus eastward through the Hammād, but this region is so inhospitable that for at least two thousand years caravans have preferred to make a detour to the north and pass through the oasis of Tadmor. At this point also the great line between the Persian Gulf and the Mediterranean is intersected by other routes connecting Palmyra with northern Syria on the one hand and with Postra, Petra, and central Arabia on the other—routes now deserted or little traversed, but which in ancient times were of very considerable consequence, especially in connexion with the overland incense trade. The oasis was thus naturally marked out as a trading post of some importance, but the commanding position which Palmyra held in the 2d and 3d centuries of our era was due to special causes. The rise and fall of Palmyra form one of the most interesting chapters in ancient history, and must be studied not only from ancient writers but from the numerous inscriptions that have been collected from the ruins of the city and the tombs that surround it.

The oldest notice of Palmyra is in 2 Chron. viii. 5, when Tadmor in the wilderness is said to have been built by Solomon. But the source of this statement is 1 Kings ix. 18, and here the name is תמר, which cannot be read Tadmor, and from the context—in which Judæan towns are spoken of—is almost certainly the Tamar of Ezek. xlvii. 19, xlviii. 28. It is indeed extremely improbable that Solomon, whose policy was to enrich Judah by developing the Red Sea traffic, and so carrying the trade of the East to the Mediterranean ports through his own country, would have encouraged the rival route by Tadmor, which lies quite outside the Israelite settlements, and passes through districts over which Solomon was unable to maintain even the recognition of suzerainty which David had extorted by his Syrian wars. After the time of Solomon the Red Sea trade was interrupted, and an overland caravan trade from Phœnicia to Yemen and the Persian Gulf took its place. But neither on the cuneiform inscriptions nor in the Old Testament writings prior to Chronicles, not even in Ezekiel's account of the trading connexions of Tyre, is there any mention of Tadmor; up to the 6th century B.C. the caravans seem to have been organized by merchants of southern or central Arabia, and they probably reached Damascus by way of Dima (Jauf Bent Amir) and the W. Sirhān, without coming near the oasis of Palmyra (see especially Isa. xxi. 11 sq.; Ezek. xxvii.). On the other hand Tadmor cannot have been a new place when the Biblical Chronicler ascribed its foundation to Solomon, and thus we shall hardly be wrong in connecting its origin with the gradual forward movement of the nomadic Arabs which followed on the overthrow of the ancient nationalities of Syria by the Chaldæan empire. Arabian tribes then took possession of the partly cultivated lands east of Canaan, and, as has been explained in the article **NABATÆANS**, became masters of the Eastern

<sup>1</sup> According to the Duc de Luyne, the great temple is in 34° 32' 30" N. lat. and 35° 54' 35" E. long.

<sup>2</sup> Ptolemy (viii. 80) gives the distances as 176 Roman miles from Damascus and 337 from Seleucia.

trade, gradually acquired settled habits, and learned civilization and the use of writing from the Aramaeans, whose language was in current official and commercial use in the Persian empire west of the Euphrates. The Nabataeans of Petra naturally appear in Western literature before the remote Palmyraeans, who are not even mentioned by Strabo. But we learn from Appian (*Bell. Civ.*, v. 9) that in 42-41 B.C. the city was rich enough to excite the cupidity of Mark Antony, and that the population was still small and mobile enough to evade that cupidity by timely flight. The series of Semitic inscriptions of Palmyra begins a few years later. The oldest (De Vogüé, 30) bears the date 304 of the Seleucid era (9 B.C.), and was placed upon one of the characteristic tower-shaped tombs which overlooked the city from the surrounding hillsides. The dialect and the writing (a form of the "square" character) are western Aramaic; the era, as we have just seen, is Greek,<sup>1</sup> the calendar Macedonian; and these influences, to which that of Rome was soon added, were the determining factors in Palmyrene civilization. The proper names and the names of deities are also partly Syriac, but in part they are unmistakably Arabic. The Arabic element appears in the names of members of the chief families, and these retain some distinctive grammatical forms which suggest that, though Aramaic was the written language, Arabic may have not been quite obsolete in common life. That the town was originally an Arabic settlement is further rendered probable by the use of a purely Arabic term (מִרְוֵה "fahdh") for the septs into which the townsmen were divided. And thus we can best explain how, when the oasis was occupied by a settlement of Arabs, it gradually rose from a mere halting-place for caravans to a city of the first rank. The true Arab despises agriculture; but the pursuit of commerce, the organization and conduct of trading caravans, is an honourable business which gives full scope to all the personal qualities which the Bedouin values, and cannot be successfully conducted without widespread connexions of blood and hospitality between the merchant and the leading sheikhs on the caravan route. An Arabian merchant city is thus necessarily aristocratic, and its chiefs can hardly be other than pure Arabs of good blood. The position of Palmyra in this respect may be best illustrated by the analogy of Mecca. In both cities the aristocracy was commercial, and the ruling motive of all policy lay in the maintenance of the caravan trade, which involved a constant exercise of tact and personal influence, since a blood feud or petty tribal war might close the trade routes at any moment. To keep the interests of commerce free from these embarrassments, it was further indispensable to place them under the sanctions of religion, and, though we cannot prove that this policy was carried out at Palmyra with the same consistency and success as at Mecca, we can trace significant analogies which point in this direction. Mecca became the religious centre of Arabia in virtue of the cosmopolitan worship of the Ka'ba, in which all tribes could join without surrendering their own local gods. So at Palmyra, side by side with the worship of minor deities, we find a central cultus of Beal (Bel or Malachbel) identified with "the most holy sun." To him belonged the great temple in the south-east of the city with its east fortress-like courtyard 256 yards square, lined with colonnades in the style of Herod's temple; and the residence of the banquetts of his priests, an office coveted by the first citizens of Palmyra (W., 2606, a), may be compared with the Meccan *ri'āda*, or right of entertaining

the pilgrims.<sup>2</sup> And, just as in Mecca the central worship ultimately became the worship of the supreme and nameless god (Allāh), so in Palmyra a large proportion of the numerous votive altars are simply dedicated to "the good and merciful one, blessed be his name for ever." In Palmyra as at Mecca the name Rahmán (merciful) may be due to the influence of the Jewish colony, which settled in the town after the destruction of Jerusalem; but the tendency to a universal religion, of which the dropping of the local proper name of God is so decided a mark, and which nevertheless is accompanied by no such rejection of polytheism as made Jehovah and Elohim synonymous in the religion of the Hebrew prophets, appears too early to be due to Jewish teaching (Mordtmann, 1), and seems as at Mecca to be rather connected with the cosmopolitanism of a merchant city. A secondary parallelism with Mecca is found in the sacred fountain of Ephka. Its tepid and sulphureous waters perhaps acquired their reputation from their medicinal use to cure the rheumatism which has always prevailed in Palmyra.<sup>3</sup> This spring, like Zemzem at Mecca, had a guardian, appointed by the "moon-lord" Yarhiból (W., 2571, c; De V., 30), whose oracle is alluded to in another inscription, and who may therefore be compared with the Meccan Hobal.

The wars between Rome and Parthia favoured the growth of Palmyra, which astutely used its secluded position midway between the two powers, and by a trimming policy secured a great measure of practical independence and continuous commercial relations with both (Appian, *ut sup.*; Pliny, v. 89). These wars, too, must have given it a share in the trade with north Syria, which in more peaceful times would not have chosen the desert route. To some extent, however, the oasis soon came under Roman control, for decrees regulating the custom-dues were issued for it by Germanicus and Corbulo. The splendid period of Palmyra, to which the greater part of the inscribed monuments belong, began with the overthrow of the Nabataean kingdom of Petra (105 A.D.), which left it without a commercial rival. Hadrian took Palmyra into his special favour, and gave it on the occasion of his visit to the town (*circa* 130 A.D.) the name of Adrianopolis.<sup>4</sup> Under the same emperor (8th April 137) the customs and dues of Palmyra were regulated by a law which has recently been copied from the stone on which it was engraved, and gives the fullest picture of the life and commerce of the city. At this time the supreme legislative authority lay in the hands of a senate (*βουλή*), with a president, a scribe, two archons, and a fiscal council of ten. At a later date, probably under Septimius Severus or Caracalla, Palmyra received the *ius italicum* and became a Roman colony,<sup>5</sup> and according to usage the legislative power came into the hands of the senate and people under the administration of officers called *strategi*. The Romans had soon other

<sup>1</sup> The sacrifices were partly maintained by endowments given by rich citizens (De V., 3; W. 2588). The dates of the inscriptions show that much the commonest time for the erection of honorific statues—often in a connexion partly religious—was in spring (Adar, or more often Nisan), and this seems to point to a great spring festival, corresponding to the Arabic sanctity of Rajab. Palmyra had an important trade with the Bedouins in skins and gresses (fiscal inscr., xvi. sq., xxx.); the herds of the desert are in condition for slaughter in spring, and this also points to a spring feast and fair. A trace of the hospitality so necessary to keep the Bedouins in humour may perhaps be found in De V., 16; W., 2585.

<sup>2</sup> See Mordtmann, 18, and his notes; the oasis lies 1300 feet above the sea, is constantly swept by cutting winds, and is liable to sudden and extreme variations of temperature.

<sup>3</sup> See Uranus, *apud* Steph. Byz., now confirmed by the great fiscal inscription.

<sup>4</sup> See Ulpian, *Dig.*, l. 15, 1, and Waddington, p. 596. Palmyraeans who became Roman citizens took Roman names in addition to their native ones, and these in almost every case are either Septimius or Julius Aurelius.

<sup>5</sup> The oldest Greek inscription (bilingual) is of 10 A.D., for a statue erected jointly by the Palmyraeans and the Greeks of Balauda, *Jour. As.*, ser. 3, l. 243.

than commercial reasons to favour Palmyra, which became an important military post, and turned its commercial organisation to good account in aiding the movements of the legions marching against the Persians (De V., 15). It was the Persian wars that raised Palmyra to brief political importance, and made it for a few years the mistress of the Roman East; but before we pass to this last epoch of its greatness we must attempt to describe the aspect and life of the city during the century and a half of its chief commercial prosperity.

The chief luxuries of the ancient world—silks, jewels, pearls, perfumes, and the like—were drawn from India, China, and southern Arabia; and Pliny computes the yearly import of these wares into Rome at not less than three quarters of a million of English money. The trade followed two routes, one by the Red Sea, Egypt, and Alexandria, the other from the Persian Gulf through the Syro-Arabian desert. The latter, after the fall of Petra, was in the hands of the Palmyrene merchants. West of Palmyra there were Roman roads, and the bales could be conveyed in waggons, but east of the oasis there was no road, and the caravans of Palmyra traversed the desert either to Vologesias (near the ancient Babylon and the later Cufa), where water carriage was available, or to Forath on the Pasitigris and Charax at the head of the Persian Gulf. The trade was enormously profitable not only to the merchants but to the town, which levied a rigorous duty on all exports and imports, and even farmed out the water of the two wells; but the dangers of the desert and the risks of Parthian or Persian hostility were also formidable, and successfully to plan or conduct a great caravan was a distinguished service to the state, often recognised by public monuments erected by the "senate and people," or by the merchants of the caravan. These monuments, which form a conspicuous feature in Palmyrene architecture, took the form of statues placed on pedestals projecting from the upper part of the long rows of pillars which lined the chief streets; for every great merchant was eager to see his name handed down to posterity by an enduring memorial, and to add to the colonnades a series of pillars "with all their ornaments, with their brassen capitals (!) and painted ceilings," was the received way of honouring others or winning honour for oneself. Thus arose, besides minor streets, the great central avenue which, starting from a triumphal arch near the great Temple of the Sun, formed the main axis of the city from south-east to north-west for a length of 1240 yards, and at one time consisted of not less than 750 columns of rosy-white limestone each 55 feet high. We must suppose that this and the other pillared streets were shaded from the fierce heat of the sun like a modern bazaar; and in some parts the pillars seem to have served to support a raised footway, from which loungers could look down at their ease on the creaking waggons piled with bales of silk or purple wool or heavy with Grecian bronzes designed to adorn some Eastern palace, the long strings of asses laden with skins or *alabastra* of precious unguents, the swinging camels charged with olive oil from Palestine or with grease and hides from the Arabian deserts, and the motley crew of divers nationalities which crowded the street beneath—the slave merchant with his human wares from Egypt or Asia Minor, the Roman legiourary and the half-naked Saracen, the Jewish, Persian, and Armenian merchants, the street hawkers of old clothes, the petty hucksters at the corners offering roasted pine cones, salt fish, and other cheap dainties, the tawdry slave-girls, whose shameful trade went to swell the coffers of the state, the noisy salt auction, presided over by an officer of the customs. The production of "pure salt" from the deposits of the desert was apparently one of the chief local industries, and another

which could not be lacking on the confines of Arabia was the manufacture of leather. We read too, on the inscriptions, of a guild of workers in gold and silver; but Palmyra was not a great industrial town, and the exacting fiscal system, which reached the most essential industries, and drew profit from the barest necessities of life, must have weighed heavily on the artisan classes. Though all quarters of the town still show traces of splendid buildings, wealth was probably confined to a comparatively small number of great families, and we must picture Palmyra in its best days as displaying a truly Oriental compound of magnificence and squalor, where the mud or straw-built huts of the poor stood hard by the palaces of the merchant princes.

The life of the mass of the population was the unchanging life of the Eastern poor; the great families too remained essentially Oriental under the varnish of their Greek culture and Roman citizenship. The life of a prominent townsman included an active share in the organisation and even the personal conduct of caravans, the discharge of civic offices, perhaps the superintendence of the market and the victualling of a Roman expedition. The capable discharge of these functions, which sometimes involved considerable pecuniary sacrifices, ensured public esteem, laudatory inscriptions, and statues, and to these honours the head of a great house was careful to add the glory of a splendid family tomb, consecrated as the "long home" (אבן עזר)—the same phrase as in Eccles. xii. 5) of himself, his sons, and his sons' sons "for ever." These tombs, which lie outside the city, are perhaps the most interesting monuments of Palmyra. Some are lofty square towers, with as many as five sepulchral chambers occupying successive stories, and overlooking the town and its approaches—a feature characteristically Arabic—from the slopes of the surrounding hills. Others are house-like buildings of one story, a richly decorated portico opening into a hall whose walls are adorned with the names and sculptured portraits of the dead. The scale of these monuments corresponds to the wide conception of an Eastern family, from which dependants and slaves were not excluded; and on one inscription, in striking contrast with Western usage, a slave is named with the sons of the house (De V., 33, a). The tombs are the only buildings of Palmyra that have any architectural individuality; the style of all the ruins is late classic, highly ornate, but without refinement.

The frequent Eastern expeditions of Rome in the 3d century brought Palmyra into close connexion with several emperors, and opened a new career of ambition to her citizens in the Roman honours that rewarded services to the imperial armies. One house which was thus distinguished was to play no small part in the world's history. Its members, as we learn from the inscriptions, prefixed to their Semitic names the Roman *gentilicium* of Septimius, which shows that they received the citizenship under Septimius Severus, presumably on the occasion of his Parthian expedition. In the next generation Septimius Odsenathus<sup>1</sup> (Odhainat), son of Hairan, son of Wahballath, son of Nassor, had attained the rank of a Roman senator, conferred no doubt when Alexander Severus visited Palmyra (comp. De V., 15). The East was then stirred by the progress of the new Sasanian empire, and the Palmyrene aristocracy, in spite of its Roman honours, had probably never cordially fallen in with the changes which had made Palmyra a colony and a military station. Indeed the Romanising process had only changed the surface life of the place; it lay in the nature of things that the

<sup>1</sup> Odsenathos, not Odhainos; is the form of the name on the inscription.



greatest merchant prince, with the openest hand, and the widest circle of connexions along the trade routes, was the real head of the community, and could do what he pleased with *bole* and *demos* except when a Roman commander interfered. Odenathus appears to have been the head of a party which secretly meditated revolt, but the outbreak was prevented by a Roman officer Rufinus, who procured his assassination.<sup>1</sup> He left two sons; the elder named Hairan appears in an inscription of 251 A.D. as "headman" (ὁ κεφαλῆς) of the Palmyrenes, but it was the younger brother Odenathus who sought revenge for his father's death and inherited his ambition. In him the old Bedouin blood reasserted itself; an Esau among the Jacobs of Tadmor, he spent his youth in the mountains and deserts, where the hardships of the chase prepared him for the fatigues of war, and where no doubt he acquired the absolute influence over the nomad tribes which was one of the chief secrets of his future success. In 258, the year of Valerian's ill-fated march against Sapor, Odenathus is called *hypsathikos* or *consular*, the highest honorary title of the empire, in an inscription erected to him by the gold and silver smiths of Palmyra. The title no doubt had just been conferred by the emperor on his way eastward, and the munificent patron of the guild of workers in precious metals had, we may judge, liberally scattered their wares among the wives and daughters of the Bedouin sheikhs. He meant to have a strength and party of his own, whatever the issue of the war. If we may trust the circumstantial account of Petrus Patricius, the captivity of Valerian and the victorious advance of Sapor induced Odenathus to send gifts and letters to Sapor, and it was only when these were rejected that he threw himself heart and soul into the Roman cause. Sapor was offended that Odenathus did not appear before him in person; the Palmyrene chief in fact did not mean to be the mere subject either of Persian or Roman, though he was ready to follow whichever power would leave him practically sovereign at the price of occasional acts of homage. Rome in her day of disaster could not afford to be so proud as the Persian; the weak Gallienus was the very susserain whom Odenathus desired; and, joining his own considerable forces with the shattered fragments of the Roman armies, the Palmyrene commenced a successful war with Persia, in which he amply revenged himself on the arrogance of Sapor, and not only saved the Roman East but reduced Nisibis, twice laid siege to Ctesiphon itself, and furnished Gallienus with the captives and trophies for the empty pomp of a triumph. From the confused mass of undigested and contradictory anecdotes which form all the history we possess of this period it is impossible to extract a satisfactory picture of the career of Odenathus; but we can see that he steadily aimed at concentrating in his own person the whole sovereignty of Syria and the neighbouring lands, and as the organization of the empire had entirely broken down, and almost every Roman general who had a substantial force at his command sooner or later advanced a claim to the purple, the Palmyrene prince, always acting in the name of Gallienus, gradually disembarrassed himself of every rival representative of Western authority throughout the greater part of Roman Asia. In the year 264 he was officially named supreme commander in the East,<sup>2</sup> and, though to

the Romans he was a subject of the empire, among his own people he was an independent sovereign, supreme over all the lands from Armenia to Arabia, and able to count on the assistance of both these nations. Odenathus himself seems to have been engaged in almost constant warfare in the east and north against the Persians and perhaps the Scythians, but in his absence the reins of government were firmly held by his wife Zenobia, the most famous heroine of antiquity, to whom indeed Aurelian, in a letter preserved by Trebellianus Pollio, ascribes the chief merit of all her husband's success. Septimia Zenobia was by birth a Palmyrene; her native name was Bath Zabai (De V., 29);<sup>3</sup> and Pollio's description of her dark beauty, black flashing eyes, and pearly teeth, together with her unusual physical endurance and the frank commanding manners which secured her authority in the camp and the desert, point emphatically to an Arabic rather than a Syrian descent.<sup>4</sup> To the union of firmness and clemency, which is the most necessary quality of an Eastern sovereign, Zenobia added the rarer gifts of economy and organization, and an unusual range of intellectual culture. She spoke Coptic as well as Syriac knew something of Latin, and had learned Greek from the famous Longinus, who remained at her court to the last, and paid the penalty of his life for his share in her counsels. She was also a diligent student of Eastern and Western history, and the statement that she enjoined her sons to speak Latin so that they had difficulty in using Greek implies a consistent and early adoption of the policy which made the success of Odenathus, and, taken in connexion with Aurelian's testimony, in a letter preserved by Pollio, that she had the chief merit of her husband's exploits, seems to justify the conclusion that it was her educated political insight that created the fortunes of the short-lived dynasty. In the zenith of his fame Odenathus was cut off by assassination along with his eldest son Herod, and it is generally assumed that the murder took place under Gallienus. The authority for this view is Pollio, who says that on receiving the news Gallienus sent an army against the Persians, which was destroyed to a

Persian victories in 265 (reading *consulatus* for *consulatus* in Gall. c. 12 with Klein in *Rhein. Mus.* 1880, p. 49 sq.). With this agrees Jerome's date of 265 for the campaign against Sapor; and it is also possible to make out from the series of Palmyrene inscriptions referring to a certain Septimius Word that in 263-264 the military organization of Palmyra ceased to be Roman. On the other hand up to 262-263 Syria was held by Macrianus and his son Quietus. Odenathus took Emesa and destroyed Quietus probably in 263. Up to this time his sphere of action was limited by the desert, but the overthrow of Quietus left him the only real power between Rome and Persia. There is really no evidence that he was at war with Sapor before 265, and before 263 he was hardly in a position to send an embassy to him. It is most likely that his final decision in favour of Rome was not made till the fall of Emesa. Pollio is certainly wrong in saying that in 265 Odenathus was named Augustus. He seems to have been misled by a medal in which the Augustus represented dragging Persians captive was really Gallienus, whom we know to have triumphed for Odenathus's victories. But after his Persian successes Odenathus strengthened his position, as we learn from coins, by having his son associated in his imperium. The first year of Wahballath is 266-267, when his father, as will be presently shown, was still alive. The title of "king" was perhaps not conferred on Wahballath till the reign of Aurelian (Sallet, *Nouv. Sést.* 1870).

<sup>3</sup> The original reading of De Vogüé and Waddington, Bath Zabina, is now known to be incorrect. Zabai is a genuine Palmyrene name, borne also at this period by Septimius Zabbai, the general of the forces of the city.

<sup>4</sup> We need not attach any weight to the fact that Zenobia, when she was mistress of Egypt, boasted of descent from Cleopatra and the Ptolemies. Athanasius, in speaking of the support she gave to Paul of Samosata, calls her a Jewess; this is certainly false, for her coins bear pagan symbols. Athanasius probably drew a hasty conclusion, not so much from her sympathy with the Monarchian Paul as from her patronage of the Jews in Alexandria, for which the evidence of an inscription from a synagogue still exists (see Mommsen in *Zeitsch. f. Numismatik*, v. 229 sq., 1873).

<sup>1</sup> See the anonymous continuator of Dio (*Fr. Hist. Gr.*, iv. 195). The elder Odenathus is also alluded to in Pollio's life of Cyriades, from which one may infer that he plotted with a Persian party in Syria.

<sup>2</sup> This date is given by Pollio (*Gallienus*, c. 10) and is confirmed by other notices. The order of events is very obscure, and Pollio is self-contradictory in several places. But the two events which he dates by consulates, and which therefore are probably most trustworthy, are the imperium of Odenathus in 264 and the rejoicings in Rome over his

man by Zenobia—a statement quite incredible, since we know from coins of her son Wahballath or Athenodorus, struck at Alexandria, that the suzerainship of Rome was acknowledged in the Palmyrene kingdom till the second year of Aurelian. That Odsenathus fell under Gallienus seems, however, at first sight to be confirmed by the coins, which give 266-7 as the first year of Wahballath. On the other hand the inscriptions on two statues of Odsenathus and Zenobia which stand side by side at Palmyra bear the date August 271, and, though De Vogüé, mistaking an essential word, supposed the former to be posthumous, the inscription really implies that Odsenathus was then alive.<sup>1</sup> Now Pollio himself says that his wife and sons were associated in the kingship of Odsenathus, and therefore the years of Wahballath do not necessarily begin with his father's death. The fact seems to be that, while Odsenathus was busy at the other end of his kingdom, Zenobia administered the government at Palmyra and directed the conquest of Egypt, still nominally acting under the emperor at Rome, whose authority on the Nile was disputed by one or more pretenders.<sup>2</sup> It still seems strange that Wahballath should strike money in his father's lifetime—and he did so both at Antioch and Alexandria—when there are no genuine coins of Odsenathus; but it is equally strange and yet an undoubted fact that Zenobia, who not only enjoyed the real authority behind her beardless son, but placed her name before his on public inscriptions,<sup>3</sup> struck no coins till the second year of Aurelian, when the breach with Rome took place, and she suddenly appears as an empress (*Σεβαστη*, Augusta) of five years' standing. Up to that date the royal pair probably did not venture to coin in open defiance to Rome, and yet were unwilling to circulate an acknowledgment of vassalship in all the bazaars of the East.

When, however, Aurelian had restored the unity of the West, and stood at the head of a powerful army flushed by victory in Gaul, Palmyra had to choose between real subjection and war with Rome. Some time in the year ending August 28, 271, Wahballath assumed the title of Augustus, and drops Aurelian from his coins, and just at the same time Zabdai, generalissimo of the forces, and Zabbai, commander of the army of Tadmor, erected the statues already mentioned, where Odsenathus is styled "king of kings and restorer of the state." This was an open challenge, and the assassination of Odsenathus, which took place at Emesa, a town in which the Roman party was strong, must have followed immediately afterwards, and on political grounds.<sup>4</sup> Zenobia, supported by her two generals, kinsmen of her husband, was now face to face with a Roman invasion. She held Egypt, Syria, Mesopotamia, and Asia Minor as far as Ancyra; and Bithynia was ready to join her party had not the army of Aurelian appeared just in time from Byzantium. She could count too on the Armenians and the Arabs, but the loyalty of Syria was doubtful: the towns disliked a rule which was essentially "barbarian," and in Antioch at least the patroness of the Monarchian bishop Paul of Samosata could not be popular with the large Christian party by whom he was bitterly hated. There were many Romans

in Zenobia's force, and it was they who bore the brunt of the two great battles at Antioch and Emesa, which followed Aurelian's rapid advance through Asia Minor. But Zenobia made light of these defeats,—“I have suffered no great loss” was her message to Aurelian, “for almost all who have fallen are Romans” (*Fr. H. Gr.*, iv. 197). It was now plain that the war was one of races, and the fact that the fellâhîn of Palestine fought with enthusiasm on the side of Aurelian is the clearest proof that the empire of Palmyra was really an empire of Arabs over the peasants of the settled Semitic lands, whom the true Bedouin always despises, and who return his contempt with burning hatred. Thus the analogy already traced between the early history of Tadmor and Mecca is completed by an equally striking parallel between the empire of the Septimians at Palmyra and that of the Omayyads at Damascus. In each case it was a family of Arabian merchant princes, strong in its influence over the sons of the desert, which rose to sovereignty and governed the old lands of the Semites from a city which had the desert behind it. But the empire of Palmyra came four centuries too soon. Rome was not yet exhausted, and Zenobia had neither the religious discipline of Islâm to hold the Arabs together nor the spoil of the treasuries of Persia to keep their enthusiasm always fresh. Aurelian's military skill was strained to the uttermost by the prudence and energy of Zenobia, but he succeeded in forming and maintaining the siege of Palmyra in spite of its bulwark of desert, and his gold corrupted the Arab and Armenian auxiliaries. Zenobia attempted to flee and throw herself on the Persians, but she was pursued and taken, and then the Palmyrenes lost heart and capitulated. Aurelian seized the wealth of the city, but spared the inhabitants, and to Zenobia he granted her life while he put her advisers to death. She figured in his splendid triumph, and by the most probable account accepted her fall with dignity, and closed her days at Tibur, where she lived with her sons the life of a Roman matron. The fall of Zenobia may be placed in the spring of 272. Soon after, probably within a year, Palmyra was again in revolt, but on the approach of Aurelian it yielded without a battle; the town was destroyed and the population put to the sword.

An obscure and distorted tradition of Zenobia as an Arab queen survived in the Arabian tradition of Zabdai, daughter of Amr b. Zarib, whose name is associated with Tadmor and with a town on the right bank of the Euphrates, which is no doubt the Zenobia of which Procopius speaks as founded by the famous queen. See C. de Perceval, ii. 28 sq., 197 sq.; Tabari, i. 757 sq. But the ruins of Palmyra, which excited the lively admiration of the Bedouins, were not associated by them with the great queen; they are referred to by Nâbigha as proofs of the might of Solomon and his sovereignty over their builders the Jinn. This legend must have come from the Jews, who either clung to the ruins or returned when Palmyra partially revived as a military station founded by Diocletian. Under the Christian empire Palmyra was a bishopric; about 400 A.D. it was the station of the first Illyrian legion (*Nô. Dig.*). Justinian furnished it with an aqueduct, and built the wall of which the ruins are still visible: it was deemed important, as we gather from Procopius, to have a strong post on the disputed marches of the Arabs of Hira and Ghassân. At the Moslem conquest of Syria Palmyra capitulated to Khalid without embracing Islâm (Belâdhori, p. 111 sq.; Yâkût, i. 831). The town became a Moslem fortress and received a considerable Arab colony; for in the reign of Merwân II. it sent a thousand Kalbite horsemen to aid the revolt of Emesa, to the district of which it is reckoned by the Arabic geographers.<sup>5</sup> The rebellion was sternly suppressed and the walls of the city destroyed.<sup>6</sup> References to Palmyra in later

<sup>1</sup> That Odsenathus lived to begin the war with Aurelian seems to have been known to Vopiscus (*Probus*, c. 9).

<sup>2</sup> That the Probatas of Pollio, *Claudius*, c. 11 (the Probus of Zosimus), must have been a pretender was first seen by Mommsen, *apud Sallet, Fürsten von Palmyra*, p. 44.

<sup>3</sup> This is shown for Syria by an inscription near Byblus (*C. I. G.*, 4503 b; Waddington, p. 604), and for Egypt by the inscription from the Jewish synagogue already quoted, where indeed the names are not given but the order is *Βασίλευσας καὶ Βασίλισσα*—in the Latin *Regina et rex juuervul*.

<sup>4</sup> See, for the attitude of Emesa, Zosimus, i. 54, *Frag. Hist. Græc.*, iv. 195. The assassin was a relative of Odsenathus named Meonius, that is M'annai (Pollio *Frag. Tyr.*; Zonaras, xii. 24).

<sup>5</sup> Ibn Athîr (127 A.H.); compare *Frag. Hist. Ar.*, 139 (where it is said to have been held by the Benî 'Amr); Ibn Wâdil, ii. 230; Mokaddasi, p. 156.

<sup>6</sup> In this connexion Yâkût tells a curious story of the opening of one of the tombs by the caliph, which in spite of fabulous incidents, recalling the legend of Roderic the Goth, shows some traces of local knowledge. The sculptures of Palmyra greatly interested the Arabs, and are commemorated in several poems quoted by Yâkût and others.

times have been collected by Quatremère, *Sultans Mamlouks*, il. 1, p. 255. Once all but annihilated by earthquake (484 A.H.), and passing through many political vicissitudes, Tadmor was still a wealthy place, with considerable trade, as late as the 14th century; but in the general decline of the East, and the change of the great trade routes, it at length sunk to a poor group of hovels gathered in the courtyard of the great Temple of Sun. The ruins first became known to Europe in 1678 through W. Halifax, an Aleppo merchant. The architecture was carefully studied in 1751 by Wood and Dawkins, whose splendid folio (*The Ruins of Palmyra*, Lond., 1753) also gave copies of inscriptions. But, though the site was often visited and some stones with Semitic as well as Greek writing reached Europe, the great epigraphic wealth of Palmyra was first thoroughly opened to study by the collections of Waddington and De Vogüé, made in 1841-62. Subsequent discoveries have been of minor importance, with the notable exception of the great fiscal inscription spoken of above, discovered by Prince Abaméloh Lazarew.

*Source*.—To the writers already used by Tillmont and Gibson, of whom *Zetoun* appears to be the best informed, must be added the fragments of the anonymous continuator of Dio (Petrus Patricius) first published by Maf. For the coins, Sallet's *Firisten von Palmyra* (1866) must be read with his later essay, *Nam. Zettach*, il. 31 sq. (Vienna, 1870). For the Greek inscriptions, see the *Cr. Ins. Gr.*, but especially the work of Le Bas and Waddington, vol. III. To the great collection of Aramaic inscriptions in De Vogüé, *Syrie Centrale*, must be added the gleanings of other travellers (Mordemann, *Sitzber. of the Munich Ac.*, 1875; Sachau, in *S. D. M. G.*, xxxv. 123 sq.), with some stones brought to Europe at an earlier date, and the monuments of natives of Palmyra in Africa and Britain (see Levy, *Z. D. M. G.*, xli. xv. xvii.; W. Wright, "The Palmyrene Inscriptions," *Tr. Soc. Bib. Arch.*, vi.). The great fiscal inscription was published by De Vogüé, *Jour. As.*, ser. 4, vol. 1, l. 2; comp. Sachau in *S. D. M. G.*, xxxv. 123 sq., and R. Cagnat in *Rev. de Philol.*, viii. 125 sq. The dialect has been thoroughly discussed by Nöldke in *S. D. M. G.*, xlv. 88 sq. Its nearest affinities are with Biblical Aramaic. (W. R. R.)

**PALOMINO DE CASTRO Y VELASCO, ACOÑCLO ASTORIO** (1653-1726), Spanish painter and writer on art, was born of good family at Bujalance, near Cordoba, in 1653, and studied philosophy, theology, and law at that capital, receiving also lessons in painting from Valdes Leal, who visited Cordoba in 1672, and afterwards from Alfaro (1675). After taking minor orders he removed to Madrid in 1678, where he associated with Alfaro, Coello, and Careño, and executed some indifferent frescos. He soon afterwards married a lady of rank, and, having been appointed alcalde of the mesta, was himself ennobled; and in 1688 he was appointed painter to the king. He visited Valencia in 1697, and remained there three or four years, again devoting himself with but poor success to fresco painting. Between 1705 and 1715 he resided for considerable periods at Salamanca, Granada, and Cordoba; in the latter year the first volume of his work on art appeared in Madrid. After the death of his wife in 1725 Palomino took priest's orders. He died on August 13, 1726.

His work, in three vols. folio (1715-24), entitled *El Museo Fideicivo y Escala Opica*, consists of three parts, of which the first two, on the theory and practice of the art of painting, are without interest or value; the third, with the subtitle *El Parnaso Español Pintoresco Laureado*, is a mine of important biographical material relating to Spanish artists, which, notwithstanding its faulty style, has procured for the author the not altogether undeserved honour of being called the "Spanish Vasari." It was partially translated into English in 1739; an abridgment of the original (*Las Vidas de los Pintores y Escultores Españoles*) was published in London in 1742, and afterwards appeared in a French translation in 1749. A German version was published at Dresden in 1781, and a reprint of the entire work at Madrid in 1797.

**PALUDAN-MÜLLER, FREDERIK** (1809-1876), the leading poet of Denmark during the middle of the present century, was born at Kjerteminde on the 7th February 1809. His father was Jens Paludan-Müller, a distinguished bishop of Aarhuus. He was educated at the cathedral school of Odense from 1820 to 1828; in the latter year he passed to the university of Copenhagen. In 1832 he opened his career as a poet with *Four Romances*, and a romantic comedy entitled *Kjærlighed ved Hofet* ("Love at Court"). This enjoyed a great success, and was succeeded in 1833 by *Dandserinden* ("The Dancer"), and

in 1834 by the lyrical drama of *Amor og Frygt*. There was now no doubt about Paludan-Müller's genius. In 1835 he came under the influence of Byron, and published an Oriental tale, *Zuleimas Flugt* ("Zuleima's Flight"), which was less successful than the preceding books. But he regained all that he had lost by his two volumes of *Poems* in 1836 and 1838. Paludan-Müller now left his native country for the first time, and spent two years (1838-40) in Germany, Italy, and France. The next dates in his career are those of the publication of his principal masterpieces—his lyrical dramas, *Venus*, 1841; *Dryadens Bryllup* ("The Dryad's Wedding"), 1844; *Tithon* ("Tithonus"), 1844; and his famous didactic-humorous epic *Adam Homo*, in three volumes, 1841-48. His later works include *Abels Død* ("The Death of Abel"), 1854; *Kalanus*, an Indian tragedy; *Paradiset* ("Paradise"), a lyrical drama, 1861; *Benedikt fra Nurcia*, 1861; *Tidernes Skifte* ("The Times are Changing"), a comedy, 1874; and *Adonis*, an exquisite romance in verse, 1874. Besides these works, all of which are poetical, Paludan-Müller published a story, *Ungdomsbilleden* ("The Fountain of Youth"), in 1865, and an historical novel in three volumes, *Ivar Lykke's Historie* ("The Story of Ivar Lykke"), 1866-73. The poet lived a very retired life, first in Copenhagen, then for many years in a cottage on the outskirts of the royal park of Fredensborg. He died in his house in Ny Adalgade, Copenhagen, on the 27th December 1876.

Paludan-Müller's genius has been made the subject of one of the most brilliant of George Brandes's monographs. His work was varied, but of remarkably high and level merit. His lyrical dramas form a group of pure poems, of an elevated class, which would distinguish him above most of the European poets of his time, even if he had not shown himself, in *Adam Homo*, to be a great satirist as well. His artistic form was singularly fine. He might have been a more finished thinker if his imagination had not been disturbed by Byron. The reader who desires to study Paludan-Müller at his best must read the first book of *Adam Homo*, and the whole of *Kalanus* and of *Adonis*. His poetical works were collected in eight volumes in 1878-79.

**PALWAL**, in Gurgdon district, Punjab, India, with a population in 1881 of 10,635, is a town of great antiquity, supposed to figure in the earliest Aryan traditions under the name of Apelava, part of the Pándava kingdom of Indraprāstha. Its importance is purely historical, and the place is now a mere agricultural centre.

**PAMIERS**, capital of an arrondissement, an episcopal see, and the most populous town (10,478 inhabitants) of the department of Ariège, France, lies on the right bank of that river, 40 miles south of Toulouse, in the middle of a fertile and well-watered valley. Its wines were at one time in high repute. Its industrial establishments at present comprise flour-mills, spinning-mills, serge factories, and some large forges, and there is also a gold-washing company (the Ariège derives its name from its auriferous character). The cathedral of Pamiers, with an octagonal Gothic tower, is a bizarre mixture of the Græco-Roman and Gothic styles; the church of Notre Dame du Camp is noticeable for its crenellated and machicolated façade. From the site of the old castle, which still retains the name of Castellet, there is a fine view of the Pic de St Barthélemy and the valley of the Ariège.

Pamiers was originally a castle built in the beginning of the 12th century by Roger II., count of Foix, on lands belonging to the abbey of St Antonin de Frédelas. The abbots of St Antonin, and afterwards the bishops, shared the superiority of the town with the counts. This gave rise to numerous disputes between monks, counts, sovereigns, bishops, and the consuls of the town. Pamiers was sacked by Jean de Foix in 1486, again during the religious wars, and, finally, in 1628 by Condé.

**PAMIR**. See *ASIA*, vol. ii. p. 686, and *Oxus*, p. 103, *supra*.

**PAMPAS**. See *ARGENTINE REPUBLIC*, vol. ii. p. 487.

**PAMPHILUS**, an eminent promoter of learning in the early church, is said to have been born, of good family,

<sup>1</sup> For the site and the present aspect of the ruins, which are less perfect than at Wood's visit, see especially papers by W. Wright (of Damascus) in *Louvre Hour*, 1876; Socin-Baedeker's *Handbook*; and the recent *Reise* of Sachau (Berlin, 1883), which gives a general photograph, and one of the most perfect ruin, the small Sun-Temple.

at Berytus, in the latter half of the 3d century. After studying at Alexandria under Piarus, the disciple of Origen, he was ordained presbyter at Cæsarea in Palestine, where the remainder of his life was spent. There he established a theological school, and warmly encouraged students; he also founded, or at least largely extended, the great library to which Eusebius and Jerome were afterwards so much indebted. He was very zealous in the transcription and distribution of copies of Scripture and of the works of various Christian writers, especially of Origen; the copy of the complete works of the last-named in the library of Cæsarea was chiefly in the handwriting of Pamphilus himself. At the outbreak of the persecution under Maximin, Pamphilus was thrown into prison, and there, along with his attached friend and pupil, Eusebius (sometimes distinguished as Eusebius Pamphili), he composed an *Apology for Origen* in five books, to which a sixth was afterwards added by Eusebius. He was put to death in 309.

Only the first book of the *Apology of Pamphilus* is extant, and that but in an imperfect Latin translation by Rufinus. It has been reprinted in De la Rue's edition of *Origen*, and also by Louth and by Galland. Eusebius wrote a memoir of his master which also has unfortunately disappeared.

**PAMPHLETS.** The earliest appearance of the word is in the *Philobiblon* (1344) of Richard de Bury, who speaks of "panfietos exiguos" (chap. viii.). In English we have Chaucer's "this leud pamphlet" (*Treat. of Love*, bk. iii.), Occleve's "go litil pamphlet" (Mason's ed., 1796, p. 77), and Carleton's "pamphletis and bookys" (*Book of Envydes*, 1490, Prologue). In all these examples pamphlet is used to indicate the extent of the production, and in contradistinction to book. In the 16th century it became almost exclusively devoted in English literature to short poetical effusions, and not till the 18th century did pamphlet begin to assume its modern meaning of a prose political tract. "Pamphlet" and "pamphlétaire" are of comparatively recent introduction into French from the English, and generally indicate fugitive criticism of a more severe, not to say libellous, character than with us. The derivation of the word is a subject of contention among etymologists. The experts are also undecided as to what is actually understood by a pamphlet. Some bibliographers apply the term to everything, except periodicals, of quarto size and under, if not more than fifty pages, while others would limit its application to two or three sheets of printed matter which have first appeared in an unbound condition. These are merely physical peculiarities, and include academical dissertations, chap-books, and broadsides, which from their special subjects belong to a separate class from the pamphlet proper. As regards its literary characteristics, the chief notes of a pamphlet are brevity and spontaneity. It has a distinct aim, and relates to some matter of current interest, whether religious, political, or literary. Usually intended to support a particular line of argument, it may be descriptive, controversial, didactic, or satirical. It is not so much a class as a form of literature, and from its ephemeral character represents the changeful currents of public opinion more closely than the bulky volume published after the formation of that opinion. The history of pamphlets being the entire record of popular feeling, all that is necessary here is to briefly indicate the chief families of political and religious pamphlets which have exercised marked influence, and more particularly in those countries—England and France—where pamphlets have made so large a figure in influencing thought and events.

It is difficult to point out much in ancient literature which precisely answers to our modern view of the pamphlet. The *libelli famosi* of the Romans were simply abusive pasquinades. Some of the small treatises of Lucian, the lost *Anti-Cato* of Cæsar, Seneca's *Apocolocyntosis*

written against Claudius, Julian's *Kaisares* † *Ἰουσόριος* and *Ἀπποκρυφὸς* † *Μισωδύμων*, from their general application, just escape the charge of being mere satires, and may therefore claim to rank as early specimens of the pamphlet.

At the end of the 14th century the Lollard doctrines were widely circulated by means of the tracts and leaflets of Wickliffe and his followers. *The Ploughman's Prayer* and *Lanterns of Light*, which appeared about the time of Oldcastle's martyrdom, were extremely popular, and similar brief vernacular pieces became so common that it was thought necessary in 1408 to enact that persons in authority should search out and apprehend all persons owning English books. The printers of the 15th century produced many controversial tractates, and Caxton and Wynkin de Worde printed in the lesser form. It was in France that the printing press first began to supply reading for the common people. During the last twenty years of the 15th century there arose an extensive popular literature of farces, tales in verse and prose, satires, almanacs, &c., extending to a few leaves apiece, and circulated by the itinerant booksellers still known as *colporteurs*. These folk-books soon spread from France to Italy and Spain, and were introduced into England at the beginning of the 16th century, doubtless from the same quarter, as most of our early chap-books are translations or adaptations from the French. Another form of literature even more transient was the broadside, or single sheet printed on one side only, which appears to have flourished principally in England, but which had been in use from the first invention of printing for papal indulgences, royal proclamations, and similar documents. Throughout western Europe, about the middle of the 16th century, the broadside made a considerable figure in times of political agitation. In England it was chiefly used for ballads, which soon became so extremely popular that during the first ten years of the reign of Elizabeth the names of no less than forty ballad-printers appear in the Stationers' Registers. The humanist movement of the beginning of the 16th century produced the famous *Epistolæ Obsecratorum Virorum*, and the leading spirits of the Reformation period—Erasmus, Hutten, Luther, Melancthon, Francovia, Vergerio, Curio, and Calvin—found in tracts a ready method of widely circulating their opinions.

The course of ecclesiastical events was precipitated in England by the *Supplication for the Beggars* (1523) of Simon Fish, answered by Sir Thomas More's *Supplication of Soulvs*. In the time of Edward VI. brief tracts were largely used as a propagandist instrument in favour of the Reformed religion; political tracts were represented by the address of the rebels in Devonshire (1549). The licensing of the press by Mary greatly hindered the production of this kind of literature. From about 1570 there came an unceasing flow of Puritan pamphlets, of which more than forty were reprinted under the title of *A parte of a register* (London, Waldegrave, 4to). To this publication Dr John Bridges replied by a ponderous quarto, *A defence of the government established in the church of England* (1587), which gave rise to *Oh read over D. John Bridges . . . by the reverend and worthie Martin Marprelate gentleman* (1588), the first of the famous Martin Marprelate tracts, whose titles sufficiently indicate their opposition to priestly orders and episcopacy. Bishop Cooper's *Admonition to the People of England* (1589) came next, followed on the other side by *Hay any works for Cooper . . . by Martin the Metropolitan*, and by others from both parties to the number of about twenty-three. The controversy lasted about a year, and ended in the discomfiture of the Puritans and the seizure of their secret press. The writers on the Marprelate side are generally

supposed to have been Feary, Throgmorton, Udal, and Fenner, and their opponents Bishop Cooper, John Lilly, and Nash.

As early as the middle of the 16th century we find ballads of news; and in the reigns of Elizabeth and James I. small pamphlets, translated from the German and French, and known as "news-books," were circulated by the so-called "Mercury-women." These were the immediate predecessors of weekly newspapers, and continued to the end of the 17th century. A proclamation was issued by Charles II., May 12, 1680, "for suppressing the printing and publishing of unlicensed news-books and pamphlets of news."

In the 17th century pamphlets began to contribute more than ever to the formation of public opinion. Nearly one hundred were written by or about the restless John Lilburne, but still more numerous were those of the undaunted Prynne, who himself published above one hundred and sixty, besides many weighty folios and quartos. Charles I. found energetic supporters in Peter Heylin and Sir Roger L'Estrange, the latter noted for the coarseness of his pen. The most distinguished pamphleteer of the period was John Milton, who began his career in this direction by five anti-episcopal tracts (1641-42) during the Smectymnuss quarrel. In 1643 his wife's desertion caused him to publish anonymously *Doctrine and discipline of divorce*, followed by several others on the same subject. He printed the *Tract on Education* in 1644, and, unlicensed and unregistered, his famous *Areopagitica—a speech for the liberty of unlicensed printing*. He defended the trial and execution of the king in *Tenures of kings and magistrates* (1648). The *Ekton Basilike* dispute was conducted with more ponderous weapons than the kind we are now discussing. When Monk held supreme power Milton addressed to him *The present means of a free commonwealth and Headie and easie way* (1660), both pleading for a commonwealth in preference to a monarchy. John Goodwin, the author of *Obstructors of Justice* (1649), John Phillipps, the nephew of Milton, and Abiezer Coppe were violent and prolific partisan writers, the last-named specially known for his extreme Presbyterian principles. The tract *Killing no murder* (1657), aimed at Cromwell, and attributed to Colonel Titus or Colonel Sexby, excited more attention than any other political effusion of the time. The history of the civil war period is told day by day in the well-known collection made by Thomason the bookseller, now preserved in the British Museum. It numbers 30,000 separate books, pamphlets, and broadsides, ranging from 1640 to 1662, and is bound in 2000 volumes. Each article was dated by Thomason at the time of acquisition. William Miller was another bookseller famous for his collection of pamphlets, which were catalogued by Tooker in 1693. Wm. Laycock printed a *Proposal for raising a fund for buying them up for the nation*.

The Catholic controversy during the reign of James II. gave rise to a multitude of books and pamphlets, which have been described by Peck (*Catalogue*, 1735) and by Jones (*Catalogue*, Chetham Society, 1859-65, 2 vols.). Politics were naturally the chief feature of the floating literature connected with the Revolution of 1688. The political tracts of Lord Halifax are interesting both in matter and manner. He is supposed to have written *The character of a political trimmer* (1689), sometimes ascribed to Sir W. Coventry. About the middle of the reign Defoe was introduced to William III., and produced the first of his pamphlets on occasional conformity. He issued in 1697 his two defences of standing armies in support of the Government, and published sets of tracts on the partition treaty, the union with Scotland, and many other subjects.

His *Shortest way with the Dissenters* (1702) placed him in the pillory.

Under Queen Anne pamphlets arrived at a remarkable degree of importance. Never before or since has this method of publication been used by such masters of thought and language. Political writing of any degree of authority was almost entirely confined to pamphlets. If the Whigs were able to command the services of Addison and Steele, the Tories fought with the terrible pen of Swift. Second in power if not in literary ability were Bolingbroke, Somers, Atterbury, Prior, and Pulteney. The Government viewed with a jealous eye the free use of this powerful instrument, and St John seized upon fourteen booksellers and publishers in one day for "libels" upon the administration (see *Annals of Queen Anne*, October 23, 1711). In 1712 a duty was laid upon newspapers and pamphlets, displeasing all parties, and soon falling into disuse. Bishop Hoadly's sermon on the kingdom of Christ (1717), holding that the clergy could claim no temporal jurisdiction, occasioned the Bangorian controversy, which produced seventy or eighty pamphlets. Soon after this period party-writing declined from its comparatively high standard and fell into meaner and venal hands. Under George III. Bute took Dr Shebbeare from Newgate in order to employ his pen. The court part received the support of a few able pamphlets, among which may be mentioned *The consideration of the German War* against the policy of Pitt, and *The prerogative droit de Roy* (1764) vindicating the prerogative. We must not forget that although Samuel Johnson was a pensioned scribe he has for an excuse that his political tracts are his worst performances. Edmund Burke, on the other hand, has produced in this form some of his most valued writings. The troubles in America and the union between Ireland and Great Britain are subjects which are abundantly illustrated in pamphlet literature.

Early in the present century the rise of the quarterly reviews threw open a new channel of publicity to those who had previously used pamphlets to spread their opinions, and later on the rapid growth of monthly magazines and weekly reviews afforded controversialists a much more certain and extensive circulation than they could ensure by an isolated publication. Although pamphlets are no longer the sole or most important factor of public opinion, the minor literature of great events is never likely to be entirely confined to periodicals. The following topics, which might be largely increased in number, have each been discussed by a multitude of pamphlets, most of which, however, are likely to have been hopeless aspirants for a more certain means of preservation:—the Bullion Question (1810), the Poor Laws (1828-34), *Tracts for the Times* and the ensuing controversy (1833-45), Dr Hampden (1836), the Canadian Revolt (1837-38), the Corn Laws (1841-48), Gorham Controversy (1849-50), Crimean War and Indian Mutiny (1854-59), Schleswig-Holstein (1863-64), Ireland (1868-69), the Franco-German War, with *Dame Europa's School* and its imitators (1870-71), Vaticanism, occasioned by Mr Gladstone's *Vatican Decrees* (1874), the Eastern Question (1877-80), and the Irish Land Laws (1880-82).

France.—The activity of the French press in putting forth small tracts in favour of the Reformed religion caused the Sorbonne in 1523 to petition the king to abolish the diabolical art of printing. Even one or two sheets of printed matter were found too cumbersome, and single leaves or placards were issued in such numbers that they were the subject of a special edict, September 23, 1558. An ordinance of February 1566 was specially directed against libellous pamphlets, and those who wrote, printed, or even possessed them. The rivalry between Francis I. and Charles V. gave rise to many political pamphlets, and under Francis II. the Guises were attacked by similar means. Fr. Hotman directed his *Epîtres envoies au tygre de France* against the Cardinal de Lorraine. The Valois and

Henry III. in particular were severely handled in *Les Hermaphrodites* (c. 1605), which was followed by a long series of imitations. Between Francis I. and Charles IX. the general tone of the pamphlet-literature was grave, pedantic, and dogmatic, with few songs and an occasional political satire. From the latter period to the death of Henry IV. it became audacious, cruel, and dangerous, attended, however, with a considerable increase of political songs.

The *Satyre Ménippée* (1594), one of the most perfect models of the pamphlet in the language, did more harm to the League than all the victories of Henry IV. The pamphlets against the Jesuits were many and violent. Père Richéome defended the order in *Chasse du renard Pasquier* (1608), the latter person being their vigorous opponent Étienne Pasquier. On the death of the king the country was filled with appeals for revenge against the Jesuits for his murder; the best known of them was the *Anti-Colon* (1610), generally attributed to César de Plaix. During the regency of Mary de' Medici the pamphlet changed its severer form to a more facetious type. In spite of the danger of such proceeding under the uncompromising ministry of Richelieu, there was no lack of libels upon him, which were even in most instances printed in France. These largely increased during the Fronde, but it was Mazarin who was the subject of more of this literature than any other historical personage. It has been calculated that from the Parisian press alone there came sufficient *Mazarinades* to fill 150 quarto volumes each of 500 pages. Eight hundred were published during the siege of Paris (February 8 to March 11, 1649). A collection of satirical pieces, entitled *Tableau du gouvernement de Richelieu, Mazarin, Fouquet, et Colbert* (1693) extends to 432 pages. Pamphlets dealing with the amours of the king and his courtiers were in vogue in the time of Louis XIV., the most caustic of them being the *Carte Géographique de la Cour* (1668) of Bussy-Rabutin. The proses of Holland and the Low Countries teemed with tracts against Colbert, Le Tellier, Louvois, and Père Lachaise. The first of the ever-memorable *Provinciales* appeared on January 23, 1656, under the title of *Lettre de Louis de Montalte à un provincial de ses amis*, and the remaining eighteen came out at irregular intervals during the next fifteen months. They excited extraordinary attention throughout Europe. The Jesuit replies were feeble and ineffectual. John Law and the schemes of the bubble period caused much popular rallery. During the long reign of Louis XV. the distinguished names of Voltaire, Rousseau, Montesquieu, Diderot, D'Alembert, D'Holbach, Helvétius, and Beaumarchais must be added to the list of writers in this class.

The preliminary struggle between the parliament and the crown gave rise to hundreds of pamphlets, which grew still more numerous as the Revolution approached. Linguet and Mirabeau began their appeals to the people. Camille Desmoulins came into notice as a publicist during the elections for the states-general; but perhaps the piece which caused the most sensation was the *Qu'est ce que le Tiers État* (1789) of the Abbé Sieyès. The *Domine saltrum fua Regem* and *Pango lingua* (1789) were two royalist brochures of unavailing memory. The financial disorders of 1790 occasioned the *Effets des assignats sur le prix du pain* of Dupont de Nemours; Necker was attacked in the *Criminelle Neckorologie* of Marat; and the *Vrai noirceur de la noblesse* dragged the titled names of France through the mire. The massacre of the Champ de Mars, the death of Mirabeau, and the flight of the king in 1791, the noyades of Lyons and the crime of Charlotte Corday in 1793, and the terrible winter of 1794 have each their respective pamphlet literature, more or less violent in tone. Under the consulate and the empire the only writers of note who ventured to seek this method of appealing to the world were Madame de Staël, B. Constant, and Chateaubriand. The royalist reaction in 1816 was the cause of the *Pétition* of Paul Louis Courier, the first of those brilliant productions of a master of the art. He gained the distinction of judicial procedure with his *Simple Discours* in 1821, and published in 1824 his last political work *Le pamphlet des pamphlets*, the most eloquent justification of the pamphlet ever penned. The *Mémoire à consulter* of Montlosier attacked the growing power of the Congrégation. The year 1827 saw an augmentation of severity in the press laws and the establishment of the censure. The opposition also increased in power and activity, but found its greatest support in the songs of Beranger and the journalism of Mignet, Thiers, and Carrel. M. de Comenian was the chief pamphleteer of the reign of Louis-Philippe. His *Où et non* (1845), *Feu, Feu* (1846), and *Livre des orateurs, par Timon*, were extremely successful. The events of 1848 gave birth to a number of pamphlets, chiefly pale copies of the more virile writings of the first revolution. Among the few men of power Louis Veillot was the Père Duchesne of the clericals and Victor Hugo the Camille Desmoulins or Marat of the republicans. After 1852 there was no lack of venal apologies of the coup d'état. Within more recent times the second empire suffered from many bitter attacks, among which may be mentioned the *Lettre sur l'histoire de France* (1861) of the Duc d'Aumale, *Propos de Labiénus* (1865) of Bogoard, *Dialogues aux enfers* (1864) of Maurice Joly, and Ferry's *Comptes sanitiques d'Hausmann* (1868).

*Literature.*—In the article *LITERARIA* will be found references to collections of pamphlets in public libraries. An excellent catalogue by W. Olyra of those in the Harleian Library is added to the 10th volume of the edition of the *Miscellany* by T. Park; and in the *Bibliotheca volante* of G. Cinelli, 2d ed., 1744-47, 4 vols. 4to, may be seen a bibliography of pamphlet-literature, chiefly Italian and Latin, with notes. It is of course impossible to supply an account of all the volumes of collected pamphlets, but a few of the more representative in English may be mentioned. These are—*The Phoenix*, 1707, 5 vols. 8vo; *Wogan's Phanix Britannica*, 1732, 4to; Bishop Edmund Gibson's *Preservative against Popery*, 1738, 3 vols. folio, new ed. 1848-49, 18 vols. sm. 8vo, consisting chiefly of the anti-Catholic discourses of James II.'s time; *The Harleian Miscellany*, 1744-83, 8 vols. 4to, new ed. by T. Park, 1808-13, 10 vols. 4to, containing 600 to 700 pieces illustrative of English history, from the library of Edward Harley, earl of Oxford; *Collection of scarce and valuable tracts (known as Lord Somers' Tracts)*, 1749-52, 16 parts 4to, 2d ed. by Sir W. Scott, 1809-13, 13 vols. 4to, also full of matter for English history; and *The Pamphleteer*, 1813-23, 29 vols. 8vo, containing the best pamphlets of the day.

For the derivation of the word pamphlet consult Skeat's *Etymological Dict.*; Pogg's *Anonymiana*; *Notes and Queries*, 3d series, iv. 315, 379, 462, 482, v. 167, 290; 6th series ii. 156. The general history of the subject may be traced in M. Davies, *Iron-Nibellorum*, 1718; W. Oldys, "History of the Origin of Pamphlets," in Morgan's *Phanix Brit.*; and Nichols's *Lib. Anecdotes*; Dr Johnson's Introduction to the *Harleian Miscellany*; D'Irancelli, *Annalities of Literature*; *Review des Deux Mondes*, April 3, 1846; *Irish Q. Review*, vii. 267; *Edinb. Rev.*, Dec. 1855; Huth's *Ancient Ballads and Broadsides* (Philadelphia Soc.); H. Massell, *Martin Marprelate Controversy*; T. Jones, *Cat. of collection of tracts for and against Popery—the whole of Peck's lists and his references* (Chetham Soc., 1856-66); Blakey's *Hist. of Political Literature*; Andrews, *Hist. of British Journalism*; Larousse, *Grand Dict. Universel*; Nodder, *Sur la liberté de la presse*; Leber, *De l'état réel de la presse*; Moreau, *Bibliographie des Mazarinades*; *Bulletin du Bibliophile Belge*, 1868-63; Nisard, *Hist. des livres populaires*. (H. E. T.)

**PAMPHYLIA**, in ancient geography, was the name given to a region in the south of Asia Minor, between Lycia and Cilicia, extending from the Mediterranean to Mount Taurus. It was bounded on the N. by Pisidia, a rugged mountain tract, while Pamphylia occupied only the district between this and the sea. It was therefore a country of small extent, having a coast-line of only about 75 miles with a breadth of about 30. There can be little doubt that the Pamphylians and Pisidians were really the same people, though the former had received colonies from Greece and other lands, and from this cause, combined with the greater fertility of their territory, had attained a higher degree of civilization and more refinement than their neighbours of the interior. But the distinction between the two seems to have been established at an early period. Herodotus, who does not mention the Pisidians at all, enumerates the Pamphylians among the nations of Asia Minor, while Ephorus mentions them both, correctly including the one among the nations on the coast, the other among those of the interior. Strabo distinctly describes the position of Pamphylia as given above, and assigns as its limits the pass of Mount Climax on the west, and the fortress of Coracesium, which belonged to Cilicia, on the east. Under the Roman administration the term Pamphylia was extended so as to include Pisidia and the whole tract up to the frontiers of Phrygia and Lycaonia, and in this wider sense it is employed by Ptolemy.

Pamphylia is in one respect a country of peculiar character: although it consists almost entirely of a plain, extending from the slopes of Mount Taurus to the sea, this plain, though presenting an unbroken level to the eye, does not consist, as in most similar cases, of alluvial deposits, but is formed almost wholly of travertine. "The rivers pouring out of the caverns at the base of the Lycian and Pisidian ranges of the Taurus come forth from their subterranean courses charged with carbonate of lime, and are continually adding to the Pamphylian plain. They build up natural aqueducts of limestone, and after flowing for a time on these elevated beds burst their walls and take a new course. Consequently it is very difficult to reconcile the accounts of this district, as transmitted by ancient authors, with its present aspect, and the distribution of the streams which water it. By the sea-side the travertine forms cliffs from 20 to 80 feet high" (Forbes's *Lycia*, vol. ii. p. 188). Strabo describes a river which he terms Catarractes as a large stream falling with a great noise over a lofty cliff, but for the reason above given it cannot now be identified with certainty. He places it between Olbia and Attalia, where there is now no river of



any importance. East of the latter city is the Cestrus, and beyond that again the Eürymedon, both of which are considerable streams, navigable for some distance from the sea. Near the mouth of the latter is a lake called Capria, mentioned by Strabo, but it is a mere salt marsh.

The chief towns on the coast are—Olbia, the first town in Pamphylia, near the Lycian frontier; Attalia, founded by Attalus II, king of Pergamus, which still retains the name of Adalia, and is the principal port in this part of Asia Minor; and Side, about 15 miles east of the Eürymedon. On a hill above that river, some distance inland, stood Aspendus, and in a similar position above the river Cestrus was Perga, celebrated for its temple of Artemis. Between the two rivers, but somewhat farther inland, stood Sylleum, a strong fortress, which even ventured to defy the arms of Alexander. None of these towns are historically known to have been Greek colonies; but the foundation of Aspendus was traditionally ascribed to the Argives, and Side was said to be a colony from Cyne in Æolia. But it is certain that the inhabitants, even of these towns, retained little of a Hellenic character, and spoke a semi-barbarous dialect. The legend related by Herodotus and Strabo, which ascribed the origin of the Pamphylians to a colony led into their country by Amphiloehus and Calchas after the Trojan War, is merely one of those mythical fictions current among the Greeks with regard to so many non-Hellenic races. The coins of Aspendus, though of Greek character, present us with legends in a barbarous dialect.

The Pamphylians never appear in history as an independent people. They are first mentioned among the nations subdued by the kings of Lydia, and afterwards passed in succession under the dominion of the Persian and Macedonian monarchs. After the defeat of Antiochus III. in 190 B.C., they were included among the provinces annexed by the Romans to the dominions of Eumenes, king of Pergamus; but at a somewhat later period they joined with their neighbours the Pisidians and Cilicians in their piratical ravages, and their port of Side became the chief centre of the naval power of these freebooters, and the place where the captives were sold as slaves. Pamphylia was for a short time included in the dominions of Amyntas, king of Galatia, but after the death of that monarch lapsed into the ordinary condition of a Roman province, and its name is not again mentioned in history.

PAMPLONA (Pampeluna, Fr. Pampelune), a city of Spain, capital of the province of Navarra, and an episcopal see, is situated 1378 feet above sea-level, on the left bank of the Agra, a tributary of the Ebro, on a height commanding a wide view of the hill-encircled plain known as the "cuenca" or "bowl" of Pamplona. It is a station on the Ebro railway connecting Alcasua with Saragossa. The climate in general is cold and moist, but owing to the purity of the air and the excellence of its drainage the town is not unhealthy. From its position Pamplona has always been the principal fortress of Navarra. The fortifications form a rectangle of which the north-east and north-west sides face the river (here crossed by several bridges), while on the south-west side stands the citadel, which owes its present construction to Philip II., who modelled it on that of Antwerp. It is a pentagon, separated from the city by an esplanade, and is calculated to accommodate 7500 men. The streets of the town are regular and broad; there are three "plazas," the principal of which, containing the Casa de la Diputación and the theatre, is sometimes on festive occasions turned into a bull-ring. The cathedral is a late Gothic structure begun in 1397 by Charles III. (El Noble) of Navarra, who is buried within its walls; of the previous structure raised by Don Sancho about 1123 only a small

portion of the cloisters remains. The interior, which is fine, is remarkable for the peculiar structure of its apse; the wood carvings of the choir, in English oak, by Miguel Ancheta, a native artist, are excellent. The principal façade is Corinthian, from designs of Ventura Rodriguez (1783). The same architect designed the superb aqueduct by which the city is supplied with water from Monte Franco, some nine miles off. The beautiful cloisters on the south side of the cathedral, and the chapter-house beyond them, as well as the old churches of San Saturnino (Gothic) and San Nicolas (Romanesque), are also of interest to the student of architecture. Among other places of public resort in Pamplona may be mentioned the bull-ring, capable of accommodating 8000 spectators, and the tennis court (El Trinquete). The town has a well-equipped secondary school, two normal and numerous primary schools, as well as an academy of design; and there are three hospitals. Of the public gardens and walks the finest is La Taconera. The surrounding district is fertile, producing wine as well as grain and other seeds; the manufactures are comparatively unimportant, the chief being that of linen. The yearly fair in connexion with the feast of San Fermin (July 7), the patron saint of the city, attracts a large concourse from all parts of the country. Population of ayuntamiento in 1877, 25,630.

Originally a town of the Vascones, Pamplona was rebuilt in 68 A.C. by Pompey the Great, whence the name Pompelo or Pompelo (Strabo). It was captured by Euric the Goth in 466 and by the Franks under Childobert in 542; it was dismantled by Charlemagne in 778, but repulsed the emir of Saragossa in 907. In the 14th century it was greatly strengthened and beautified by Charles III., who built a citadel on the site now occupied by the Plaza de Toros and by the Basilica de S. Ignacio, the church marking the spot where Ignatius Loyola received his wound in defending the place against André de Foix in 1521. From 1808 it was occupied by the French until taken by Wellington in 1818. In the Carlist war of 1836-40 it was held by the Cristinos, and in 1875-76 it was more than once attacked, but never taken, by the Carlists.

PAN, a Greek god worshipped chiefly in Arcadia, among whose mountains he had numerous sanctuaries and holy caves. While he is a very common figure in poetry and art, it is exceedingly difficult to gain any clear idea of his actual worship in his Arcadian home. He appears to have been worshipped on the mountain tops as well as in caves; he was the herdsman's god, and the giver of fertility to flocks; he was a god of prophetic inspiration and of dreams, in which he sometimes revealed the cure of diseases; he was himself a huntsman and the god of hunters, and Arcadian sportsmen beat his image if they returned empty-handed from the chase; even fishermen invoked him for aid in their occupation; he guided travellers (as *ἑρέτης* and *τοῦρατος*) on the pathless mountains, and even smoothed the rough sea by the sound of his flute; he was the god of music, of dance, and of song, Echo and Syrinx were the objects of his love, and he sported and danced with the mountain Nymphs. The nineteenth Homeric Hymn gives a most poetic account of his birth from the union of Hermes and the daughter of Dryops, and of his life among the Arcadian mountains and springs. His power of inspiration and prophecy shows that there was an orgiastic, enthusiastic side of his worship, which made it easy for Pindar to connect him with the worship of Cybele, and for others to identify him with Marsyas. His voice inspires terror, and he produced sudden panics among men. The Athenian herald Phidippides heard his voice by the way promising victory at Marathon; the Athenians attributed their triumph to his aid, and to the panic he inspired among the Persians, and consecrated to him a cave in the north side of the Acropolis. He had a temple and oracle near Acacesium, in which a fire burned continually. The analogy of his nature with Dionysus led to his assimilation with the Satyr, and he is

often pictured among the Bacchic Thiasus. It was only a step further to speak of many Pans, male and female, and of infant Panisci. In the mystic eclecticism of Orphic religion, Pan was conceived as the universal god in a pantheistic fashion. His mother is variously called CEnoe, or Callisto, or Penelope; his father is Zeus, or Hermes, or Apollo, or Odyseus, or the suitors generally. He was represented as a half-human half-brute figure, with the legs and horns of a goat and a face whose features resembled those of an animal. According to the Homeric Hymn, his mother was terrified when he was born with his hideous figure and long goat's beard. The story, alluded to by Milton, Mrs Browning, and the modern poets, of the pilot Thamus, who, sailing near Paxos in the time of Tiberius, was commanded by a mighty voice to proclaim that "Pan is dead," is first found in Plutarch (*De Orae. Defectu*, 699).

PANÆTIUS, a Stoic philosopher, lived about 185-112 B.C. He belonged to a Rhodian family, but was probably educated partly in Pergamum and afterwards in Athens. About 156 B.C. he came from Athens to Rome, where he became a friend of Lælius and of Scipio the younger. He lived as a guest in the house of Scipio, and accompanied him in his final campaign against Carthage and in his expedition to Egypt and Asia, 143 B.C. He had an important influence in the introduction of Greek philosophy into Rome, and taught a number of distinguished Romans. He returned to Athens, probably after the murder of Scipio in 129 B.C., and succeeded Antipater as head of the Stoic school. The right of citizenship was offered him by the Athenians, but not accepted. In his teaching he laid most stress on ethics; and his most important works, of which only insignificant fragments are preserved, were on this subject. He wrote (apparently during his Roman visit) a treatise on virtue, *περὶ τοῦ καθήκοντος*, in three books, upon which Cicero has chiefly founded his work *De Officiis*. Works *περὶ σπουδαίης*, *περὶ εὐθυμίας*, &c., were also composed by Panætius.

PANAMÁ, a state and city of Colombia, in the extreme north of South America. The city, which is the capital of the state and the seat of a bishop, is situated on the coast of the Pacific at the head of the Gulf of Panamá, a few miles east of the mouth of the Rio Grande, occupying partly a tongue of coral and basaltic rock and partly a gentle rise towards Mount Ancon, an eminence 560 feet in height. The cathedral stands in 8° 57' 16" N. lat. and 79° 30' 50" W. long. In the 16th and 17th centuries Panamá was, next to Cartagena, the strongest fortress in South America; but its massive granite ramparts, constructed by Alfonso Mercado de Villacorta (1673), in some places 40 feet high and 60 feet broad, have been razed on the land side (where they separated the city proper from the suburbs of Santa Ana, Pueblo Nuevo, and Arrabal) and allowed to fall into a ruinous condition towards the sea. Of the old Spanish houses constructed in the Moorish fashion comparatively few remain; but three-story buildings, in which the two upper stories project, are sufficiently common to give a distinctive character to the city, which thus differs from the other towns of Central America. Ruins of churches and convents occupy a large area, those of the Jesuit college being the most imposing, and those of the Franciscan monastery (on the north-west sea wall) the most extensive. The cathedral, built in 1760, is a spacious edifice in the so-called Jesuit style, and its two lateral towers are the loftiest in Central America. It was restored in 1873-76, but the façade was destroyed and columns thrown down by the earthquake of September 7, 1882. The church of Santa Ana, in the suburb of that name, is of interest as the rallying point of the insurgents in the local revolutions; the high ground on which it

stands commands the city, and was long kept carefully free of all buildings. The president's residence, the governor's office, the state assembly house, the hospital in the old convent of the Conception, and the grand hotel (now the head offices of the canal company) in the principal square are the buildings now of most note. Besides the episcopal seminary there exist a sisters-of-charity school and a ladies' college, with teachers from the United States and Canada. In the rainy season streams of water flow down the streets, but in the dry season the city is dependent on water brought in carts from the Matamillo, a distance of several miles; the only perennial wells which it possessed having been dried up by the earthquake of 8th March 1883. By 1885, however, water-works introducing the



Railway and Canal from Panamá to Colon.

water of the Rio Grande at a cost of £50,000 are to be completed. Rents are high, and living is expensive. As Panamá, like Colon, is a free port, statistics of trade are not collected. The local exports are india-rubber (growing scarcer), gold-dust, hides, ivory nuts, manganese, shells, tobacco, cocobolo (a cabinet wood), tortoise-shell, vanilla, whale oil, sarsaparilla, and cocoa-nuts. The Panamá pearl fishery is still prosecuted with success. The passengers across the isthmus were 35,076 in 1868, 22,941 in 1876, 52,113 in 1881, and 75,703 in 1882. In 1870 the population of Panamá (of very varied origin) was 18,378; by 1880 it was 25,000, of whom about 5000 were strangers.

Panamá (an Indian word meaning abounding in fish) was founded in 1518 by Pedro Arias Davila, and is thus the oldest European city in America, the older settlement at Santa Maria el Antigua near the Atrato having been abandoned and leaving no trace. Originally it was situated six or seven miles farther north on the left side of the Rio Algarrobo; but the former city, which was the great emporium for the gold and silver from Peru, and "had eight monasteries, a cathedral, and two churches, a fine hospital, 200 richly furnished houses, nearly 5000 houses of a humbler sort, a Genoese chamber of commerce, and 200 warehouses, was after three weeks of rapine and murder burned, February 24, 1671, by Morgan's buccaners, who carried off 175 laden mules and more than 600 prisoners" (see *Travels of Pedro de Cieza de Leon*, Hakluyt Soc., 1864). A new city was founded on the present site by Villacorta in 1673.

*The Isthmus and State.*—By the Isthmus of Panamá is sometimes understood the whole neck of land between the continents of North and South America; more generally the name is restricted to the narrow crossing from Panamá to Colon, the two other narrowest crossings being distinguished as the Isthmus of San Blas (31 miles) and the Isthmus of Darien (46 miles). Nearly the whole isthmus, in the wider sense of the word, constitutes (since 1855) a state of the Confederation of Colombia, extending from the frontiers of Costa Rica to those of the state of Cauca. Besides Panamá the capital and Colon (Aspinwall), it contains Santiago, formerly chief town of a province and an apange of the family of Columbus, Penonomé (about 15,000 inhabitants), Los Santos, formerly chief town of a province, Nata, and David. It is divided into six departments—Coclé, Colon, Chiriqui, Los Santos, Panamá, Veragua. The total population in 1870 was 221,052.

*Railway and Canal.*—It is the Isthmus of Panamá in the narrower sense which is crossed both by the interoceanic railway and by the line of the interoceanic ship-canal at present in course of construction. It affords a much shorter route than that of Darien, and while the central Cordillera does not sink lower than 980 feet in the Isthmus of San Blas, at the Culebra Col it is rather less than 290 feet high. As the watershed runs much nearer the south than the north side of the isthmus, the streams flowing to the Pacific are of comparatively little importance, while the Chagres on the Atlantic slope, with its tributary the Rio Obispo, forms a navigable river whose volume attains formidable dimensions at certain seasons. The railway (a single line) starting from Colon (on the swamp-island of Manzanillo on Limon Bay) reaches the valley of the Chagres at Gatun, runs along its northern flanks to Barrocoas, crosses the river by a large bridge, continues along the southern flank and up the tributary Obispo: to the Culebra Col, from which it descends straight to Panamá. The ship-canal is to follow very much the same route; only it will keep closer to the bed of the Chagres, which it is to cross again and again, and on the Pacific slope it will descend the valley of the Rio Grande and be continued seaward to the island of Perico. The total length is 54 miles. Throughout the whole distance the bottom is to lie  $8\frac{1}{2}$  metres (nearly 28 feet) below the mean level of the oceans, and the width is to be 22 metres (72 feet) at bottom and 50 metres (160 feet) at top, except in the section through the Culebra ridge, where the depth is to be 9 metres, the bottom width 24, and the top width 28. The two great difficulties connected with the undertaking are those caused by the mountain and the river. As the idea of tunnelling the col has been abandoned, it will be necessary to cut down through the solid strata for a depth of 300 to 350 feet over a considerable distance; the rock happily is of a comparatively soft schistous character, disposed almost horizontally. The Chagres has an average discharge at Matachin of 100 cubic metres per second, which at low water may sink to 15 or 20 cubic metres, and during flood rise to 500 or 600. At Gamboa, which lies just above the influx of the Rio Obispo, it is proposed to construct an enormous reservoir by throwing a dam across the valley. From Cerro Obispo on the one side to Cerro Santa Cruz on the other this dam will be 960 metres long at the base and 1960 metres at the top, with a width at the bottom of 1000 metres and a height of 45 metres. It will thus be the largest dyke yet constructed in the world. Altogether it is calculated that the excavation of the canal involves the removal of 3531 millions of cubic feet of earth; by January 31, 1884, the actual quantity removed was 118,448,595 cubic feet, or only about one-thirtieth of the whole. All along the route, however, at Buhio Soldado, Tabernilla, San Pabre,

Mamei, &c., workshops and settlements have been formed, and by 1883 11,000 men were at work. At certain states of the tide the levels of the two oceans differ materially; while at Colon the difference between high and low water is not more than 23 inches, at Panamá it is generally 13 feet, and at times even upwards of  $19\frac{1}{2}$  feet. The current thus produced in the canal would be sufficient to stop navigation for a number of hours at each tide; and to obviate this difficulty it will be necessary either to construct locks at the Panamá extremity or to slope the canal from Colon to Panamá.

A proposal to pierce the Isthmus of Darien was made as early as 1620 by Angel Saavedra; Cortez caused the Isthmus of Tehuantepec to be surveyed for the construction of a canal; and in 1650 Antonio Galvão suggested four different routes for such a scheme, one of them being across the Isthmus of Panamá. In 1814 the Spanish cortes ordered the viceroy of New Spain to undertake the piercing of the Isthmus of Tehuantepec; but the War of Independence intervened, and, though a survey was made by General Obogoso in 1821, and José de Garny obtained a concession for a canal in 1843, nothing was accomplished. Bolívar, president of Colombia, caused Messrs Lloyd and Palmare to study the Isthmus of Panamá. Lloyd, whose paper was published in the *Philosophical Transactions*, London, 1830, proposed to make only a railway from Panamá or Chorrera to the Rio Trinidad (tributary of the Chagres), and to establish a port on the Bay of Limon. M. Napoleon Garella, sent out by the French Government in 1848, advocated the construction of a sluiced canal. An American company, stimulated by the sudden increase of traffic across the Isthmus caused by the discovery of gold in California, commenced in 1849 to construct a railway, and their engineers, Totten and Trautwine, already known in connexion with the canal from Cartagena to the Magdalena, managed, in spite of the extreme difficulty of procuring labour, to complete the works in January 1855. Meanwhile the question of an interoceanic canal was not lost sight of; and in 1875 it came up for discussion in the Congrès des Sciences Géographiques at Paris. A society under General Türr was formed for prosecuting the necessary explorations; and Lieutenant Wyse, assisted by Cellier, A. Reclus, Bixio, &c., was sent out to the isthmus in 1876. In 1878 the Colombian Government granted the society known as the Civil International Interoceanic Canal Society the exclusive privilege of constructing a canal between the two oceans through the Colombian territory; and at the same time the ports and canal were neutralized. In 1879 M. de Lesseps took the matter up, and the first meeting of his company was held in 1881. The capital necessary for the "Company of the Interoceanic Canal of Panamá," as it is called, was stated at 600,000,000 francs,—the estimated cost of excavation being 480,000,000, that of weirs and trenches to take fresh water to the sea 46,000,000, and that of a dock and tide-gates on the Pacific side 86,000,000. The Panamá canal was bought for \$20,000,000. The contractors, Couvreux & Hersent, began operations in October of the same year. Meanwhile the United States Government proposed to make a treaty with Colombia by which it would be free to establish forts, arsenals, and naval stations on the Isthmus of Panamá, though no forces were to be maintained during peace; but the British Government objected to any such arrangement.

Details in regard to engineering and finances will be found in the *Bulletin du Canal Océanique*, issued since 1879, and in *Engineering*, 1883 and 1884. See also Reclus's "Explorations" in *Four du Monde*, 1880, for an interesting series of views.

PANATHENÆA, the most splendid and brilliant of all the Athenian festivals, with perhaps the exception of the Great Dionysia. The mythic foundation is ascribed to Erechtheus; and Pausanias declares that the Olympia, the Lycea, and the Panathenæa were the three oldest feasts in Greece. It was originally a religious celebration in honour of the patron goddess of the city, celebrated by her own worshippers. It is said that when Theseus united the whole land under one government he made this festival of the city-goddess common to the entire country, and the older name Athenæa was then changed to Panathenæa. In addition to the religious rites there is said to have been a chariot race from the earliest time; Erechtheus himself won the prize in the race. The Panathenæa were modified and rendered far more magnificent by Pisistratus and his sons. It is probable that the distinction of Greater and Lesser Panathenæa dates from this period. Every fourth year the festival was celebrated with peculiar magnificence; gymnastic sports were added to the horse races; and there is little doubt that Pisistratus aimed at

making the penteteric Panathenæa the great Ionian festival in rivalry to the Dorian Olympia. The penteteric festival was celebrated in the third year of each Olympiad. The annual festival consisted solely of the sacrifices and rites proper to this season in the cultus of the goddess. One of these rites originally consisted in carrying a new peplos to the temple to serve as the clothing of the image, a ceremonial known in other cities and represented by the writer of the *Iliad* (vi.) as being in use at Troy; but it is probable that this rite was afterwards restricted to the great penteteric festival. Even the religious rites were celebrated with much greater splendour at the Greater Panathenæa. The whole empire shared in the great sacrifice; every colony and every subject state sent a deputation and sacrificial animals. On the great day of the feast there was a procession of the priests, the sacrificial assistants of every kind, the representatives of every part of the empire with their victims, the cavalry, in short of the population of Attica and great part of its dependencies. The peplos was borne in the procession and presented to the goddess, and the hecatomb was sacrificed. At least as early as the 3d century before Christ the custom was introduced of spreading the peplos like a sail on the mast of a ship, which was rolled on a machine in the procession. The subject of the frieze of the Parthenon is an idealized treatment of this great procession.

The festival which had been beautified by Pisistratus was made still more imposing under the rule of Pericles. He introduced a regular musical contest in place of the old recitations of the rhapsodes, which were an old standing accompaniment of the festival. The order of the *agones* from this time onwards was—first the musical, then the gymnastic, then the equestrian contest. Many kinds of contest, such as the chariot race of the *apobatas*, which were not in use at Olympia, were practised in Athens. The season of the festival was the last days of Hecatombeon, and the great day was the 28th, third from the end of the month (*τρίτη φθινόωτος*, called by Euripides *φθινὸς ἄμειρα*). The prize in the games was an amphora full of olive oil produced from the holy olives, the property and gift of the goddess herself. Only one Panathenæic amphora has been found in Attica itself; and, though many have been discovered outside of Attica, especially in Cyrene, it has been maintained that the latter are not really prizes in the games, but imitations made in the export trade as a sort of mark that the oil sold in them was of the very finest quality.

PANAY. See PHILIPPINE ISLANDS.

PANCH MAHĀLS, a district in the east of Guzerat, Bombay presidency, India, lying between 22° 30' and 23° 10' N. lat., and between 73° 35' and 74° 10' E. long., with an area of 1613 square miles. The south-western portion is for the most part a level plain of rich soil; while the northern, although it comprises some fertile valleys, is generally rugged, undulating, and barren, with but little cultivation. The mineral products comprise limestone, sandstone, trap, quartz, basalt, granite, and other varieties of building stone. Only recently has any attempt been made to conserve the extensive forest tracts, and consequently but little timber of any size is now to be found.

The census of 1881 returned the population at 255,479 (131,162 males and 124,317 females); the Hindus numbered 159,624; Mohammedans, 16,060; Parsis, 80; and Christians, 44. Of the total population 80 per cent. belong to aboriginal tribes, the majority being Bhils. Of 350,996 acres—the total area of Government cultivable land—202,498 acres were taken up for cultivation in 1831–82. Of 158,232 acres under actual cultivation (41,823 acres being twice cropped), grain crops occupied 127,082 acres; pulses, 42,444; and oil-seeds, 22,238.

PANCISOVA, a town of Hungary, near the Servian frontier, is situated on the river Temeš, just above its

junction with the Danube, which it reaches 9 miles above Belgrade. The town contains Roman Catholic, Protestant, and Greek churches, a convent, and manufactories of starch and beetroot sugar. Cotton and mulberries (for feeding silkworms) are cultivated, and a brisk trade in live stock and grain is carried on with Turkey. The hog fairs are largely attended. In 1860 Pancsova contained 17,127 inhabitants, partly Serbs and partly German. It was burned by the retreating Austrians in 1788, and was again occupied by Austrian troops in 1849, after they had defeated the Hungarians in the vicinity.

PANDARUS, son of Lycaon, led the people of Zeleia in the Troad as allies of the Trojans against the Greeks. In other passages his country is named Lycia. It is frequently said that the Lycians of the *Iliad* are a tribe of the Troad, different from the people of the country Lycia; but it is more probable that the conflicting accounts belong to different strata in the Homeric poetry. Pandarus was worshipped as a hero at Pinara in Lycia. Lycaon, the name of Pandarus's father, is merely an epithet of Apollo, the great god of Lycia. Pandarus is not an important figure in the *Iliad*. He breaks the truce between the Trojans and the Greeks by treacherously wounding Menelaus with an arrow, and finally he is slain by Diomedes. In mediæval romance he became a prominent figure in the tale of Troilus and Cressida. He encouraged the amour between the Trojan prince and his niece Cressida; and his name has passed into modern language as the common title of a lovers' go-between in the worst sense.

PANDECTS. See JUSTINIAN and ROMAN LAW.

PANDERPUR, or PANDHARPUR, a town in Sholapur district, Bombay, India, situated on the right bank of the Bhima river, in 17° 40' 40" N. lat. and 75° 22' 40" E. long., with a population in 1881 of 16,910. It is held in great reverence by the Brāhmins for its celebrated temple dedicated to Vithoba, an incarnation of Vishnu. Three large annual religious fairs are held.

PANDORA. See PROMETHEUS.

PANDUA, or PAREVAH. See GAUR, vol. x. p. 115.

PANGOLIN. In Africa, India, and Malaya are found certain curious Mammals known to the Malays as Pangolina, to the English as Scaly Anteaters, and to naturalists by the scientific name of *Manis*. These animals, which, by a superficial observer, might be taken for reptiles rather than mammals, belong to the order *Edentata*, otherwise almost wholly confined to the New World, and containing, besides the Pangolina, the Slotha, Anteaters, Armadillos, and Aard Varks.

In size pangolins range from 1 to 3 feet in length, exclusive of the tail, which varies from much shorter than to nearly twice the length of the rest of the animal; their legs are short, so that the body is only a few inches off the ground; their ears are very small; and their tongue is long and worm-like, and is used to catch ants with. Their most striking character, however, is their wonderful external coat of mail, composed of numerous broad overlapping horny scales, which cover the whole animal, with the exception of the under surface of the body, and, in most species, of the lower part of the tip of the tail. Besides the scales there are generally, especially in the Indian species, a certain number of isolated hairs, which grow up between the scales, and are also scattered over the soft and flexible skin of the belly. There are five toes on each foot, the claws on the pollex and hallux rudimentary, but the others, especially the third of the fore-foot, long, curved, and laterally compressed. In walking the fore claws are turned backwards and inwards, so that the weight of the animal rests on their back and outer surfaces, and their points are thus kept from becoming blunted,

Their skulls are long, smooth, and rounded, with imperfect zygomatic arches, no teeth of any sort, and, as in other ant-eating mammals, with the bony palate extending unusually far backwards towards the throat. The lower jaw consists of a pair of thin styliform bones ankylosed to each other at the chin, and rather loosely attached to the skull by a joint which, instead of being horizontal, is tilted up at an angle of 45°, the outwardly-twisted condyles articulating with the inner surfaces of the long glenoid processes, an arrangement quite unique among mammals, the sloths alone showing a slight tendency towards it. The other skeletal and anatomical characters have already been sufficiently described under MAMMALIA (vol. xv. p. 388).

The single genus *Manis*, which contains all the pangolins, may be conveniently divided into two groups, distinguished both by their geographical distribution and by certain convenient, though not highly important, external characters. (1) The Asiatic pangolins are characterized by having the central series of body-scales continued quite to the extreme end of the tail, by having many isolated hairs growing up between the scales of the back, and by their small external ears. They all have a



White-bellied Pangolin (*Manis tricuspis*).

small naked spot beneath the tip of the tail, which is said to be of service as an organ of touch. There are three species, viz., *Manis javanica*, ranging from Burmah, through Malacca and Java, to Borneo; *M. aurita*, found in China, Formosa, and Nepal; and the common Indian Pangolin, *M. pentadactyla*, distributed over the whole of India and Ceylon. (2) The African species have the central series of scales suddenly interrupted and breaking into two at a point about 2 or 3 inches from the tip of the tail; they have no hair between the scales, and no external ear-conch. The following are the four species belonging to this group:—the Long-tailed Pangolin (*M. macrura*), which has a tail nearly twice as long as its body, and containing as many as forty-six caudal vertebrae, nearly the largest number known among Mammals; the White-bellied Pangolin (*M. tricuspis*), closely allied to the last, but with longer and tricuspid scales, and white belly hairs (these two, like the Indian species, have a naked spot beneath the tail tip, a character probably correlated with the power of climbing, and they are, moreover, peculiar in having the outer sides of their fore legs clothed with hair, all the other species being scaly there as elsewhere); and the Short-tailed and the Giant Pangolins (*M. temminckii* and

*gigantea*), both of which have their tails covered entirely with scales, and evidently never take to arboreal habits. All the four species of the second group are found in the West African region, one only, *M. temminckii*, extending besides into south and eastern equatorial Africa. The following account of the habits of *Manis tricuspis* is taken from Mr Louis Fraser's *Zoologia Typica*:—

"During my short residence at Fernando Po I succeeded in procuring two living specimens of this animal. The individuals, judging from the bones, were evidently not adult; the largest measured 80 inches in length, of which the head and body were 12 inches and the tail 18 inches. I kept them alive for about a week at Fernando Po, and allowed them the range of a room, where they fed upon a small black ant, which is very abundant and troublesome in the houses and elsewhere. Even when first procured they displayed little or no fear, but continued to climb about the room without noticing my occasional entrance. They would climb up the somewhat roughly-hewn square posts which supported the building with great facility, and upon reaching the ceiling would return head foremost; sometimes they would roll themselves up into a ball and throw themselves down, and apparently without experiencing any inconvenience from the fall, which was in a measure broken upon reaching the ground by the semi-yielding scales, which were thrown into an erect position by the curve of the body of the animal. In climbing, the tail, with its strongly-pointed scales beneath, was used to assist the feet; and the grasp of the hind feet, assisted by the tail, was so powerful that the animal would throw the body back (when on the post) into a horizontal position, and sway itself to and fro, apparently taking pleasure in this kind of exercise. It always slept with the body rolled up; and when in this position in a corner of the building, owing to the position and strength of the scales, and the power of the limbs combined, I found it impossible to remove the animal against its will, the points of the scales being inserted into every little notch and hollow of the surrounding objects. The eyes are very dark hazel, and very prominent. The colonial name for this species of *Manis* is 'Attadillo,' and it is called by the Boobies, the natives of the island, 'Gahlah.' The flesh is said to be exceedingly good eating, and is in great request among the natives. (O. T.)

PANIPAT, a decayed historical town in Karnal district, Punjab, India, situated on the Grand Trunk Road, 53 miles north of Delhi, in 29° 23' N. lat. and 77° 1' 10" E. long. The town is of great antiquity, dating back to the great war of the *Mahabharata* between the Pandavas and Kaurava brethren, when it formed one of the tracts demanded by Yudisthira from Duryodhana as the price of peace. In modern times, the plains of Panipat are celebrated as having thrice formed the scene of decisive battles which sealed the fate of upper India,—in 1526, when Babar on his invasion of India with his small but veteran army completely defeated the imperial forces; in 1556, when his grandson, Akbar, on the same battlefield, conquered Hemu, the Hindu general of the Afghan Sher Shah, thus a second time establishing the Mughal power; and finally, on 7th January 1761, when Ahmad Shah Durani decisively shattered the unity of the Mahratta power. The modern town stands near the old bank of the Jumna, upon high ground composed of the debris of earlier buildings. The population in 1881 numbered 25,022, including 16,917 Mohammedans. Although there are many brick-built houses and some well-paved streets in the centre of the town, the outskirts are low and squalid, and the general aspect of the whole town miserable and poverty-stricken.

PANIZZI, SIR ANTHONY (1797-1879), principal librarian of the British Museum, was born at Brescello in the duchy of Modena, September 16, 1797. After taking his degree at the university of Parma, he became an advocate, and speedily obtained considerable practice. Always a fervent patriot, he was almost of necessity implicated in the movement set on foot in 1821 to overturn the miserable Government of his native duchy, and in October of that year barely escaped arrest by a precipitate flight. He first established himself at Lugano, where he published an anonymous and now excessively rare pamphlet

generally known as *I Processi di Rubiera*, an exposure of the monstrous injustice and illegalities of the Modenese Government's proceedings against respected persons. Expelled from Switzerland at the joint instance of Austria, France, and Sardinia, he repaired to England, where he arrived in May 1823, in a state bordering upon destitution. His countryman Foscolo provided him with introductions to Roscoe and Dr Shepherd, and by their aid he was enabled to earn a subsistence in Liverpool by giving Italian lessons, while diligently instructing himself in English. Roscoe further introduced him to Brougham, by whose influence he was called to London to assume the professorship of Italian in University College, upon the foundation of that institution in 1828. His chair was almost a sinecure; but his manners, his culture, and his abilities rapidly ingratiated him with the best London society; and in 1831 Brougham, having become lord chancellor, used his *ex officio* position as a principal trustee of the British Museum to obtain for Panizzi the post of an extra assistant librarian of the printed book department. At the same time he was actively prosecuting the most important of his purely-literary labours, his edition of Boiardo's *Orlando Innamorato*. Boiardo's fame had been eclipsed for three centuries by the adaptation of Berni; and it is highly to the honour of Panizzi's taste to have redeemed him from oblivion, and restored to Italy one of the very best of her narrative poets. His edition of the *Orlando Innamorato* and the *Orlando Furioso* was published between 1830 and 1834, prefaced by a valuable essay on the influence of Celtic legends on mediæval romance, and dedicated to his benefactor Roscoe. In 1835 he edited Boiardo's minor poems, and was about the same time engaged in preparing a catalogue of the library of the Royal Society, which led to a warm controversy. Panizzi was shortly to find library work of a much more important and agreeable description in the institution with which he was officially connected. The unsatisfactory condition and illiberal management of the British Museum had long excited discontent, and at length a trivial circumstance led to the appointment of a parliamentary committee, which sat throughout the sessions of 1835-36, and probed the condition of the institution very thoroughly. Panizzi's principal contributions to its inquiries as respected the library were an enormous mass of statistics respecting foreign libraries collected by him upon the Continent, and some admirable evidence on the catalogue of printed books then in contemplation. In 1837 he became keeper of printed books upon the retirement of Mr Baber, and immediately set himself to grapple with the special tasks imposed upon him by the peculiar circumstances in which he found the library. The entire collection, except the King's Library, had to be removed from Montague House to the new building; the reading-room service had to be reorganized; rules for the new printed catalogue had to be prepared, and the catalogue itself undertaken. All these tasks were successfully accomplished; but, although the rules of cataloguing devised by Panizzi and his assistants have become the basis of whatever has since been attempted in this department, the progress of the catalogue itself was slow. The first volume, comprising letter A, was published in 1841, and from that time, although the catalogue was continued and completed in MS., no attempt was made to print any more until, in 1881, the task was resumed under the direction of the present principal librarian. The chief cause of this comparative failure was injudicious interference with Panizzi, occasioned by the impatience of the trustees and the public. Panizzi's appointment, as that of a foreigner, had from the first been highly unpopular. He gradually broke down opposition, partly by his social influence, but far more by the sterling merits of his

administration, and his constant efforts to improve the library. The most remarkable of these was his great report, printed in 1845, upon the Museum's extraordinary deficiencies in general literature, which ultimately procured the increase of the annual grant for the purchase of books to £10,000. In 1847 his friendship with the Right Hon. Thomas Grenville led to the nation's being enriched by the bequest of that gentleman's unique library, valued even then at £50,000. In 1847-49 a royal commission sat to inquire into the general state of the Museum, and Panizzi was the centre of the proceedings. His administration, fiercely attacked from a multitude of quarters, was triumphantly vindicated in every point; and the inquiry had the excellent effect, not merely of establishing his reputation, but of abolishing the main source of maladministration, the anomalous position and illegitimate influence of the secretary. Panizzi immediately became by far the most influential official in the Museum, though he did not actually succeed to the principal librarianship until 1856.

It was thus as merely keeper of printed books that he conceived and carried out the achievement by which he is probably best remembered, the erection of the new library and reading-room. The want of space had become so crying an evil that purchases were actually discouraged from lack of room in which to deposit the books. Panizzi cast his eye on the empty quadrangle enclosed by the Museum buildings, and conceived the daring idea of occupying it with a central cupola too distant, and adjacent galleries too low, to obstruct the inner windows of the original edifice. The cupola was to cover three hundred readers, the galleries to provide storage for a million of books. The original design, sketched by Panizzi's own hand on April 18, 1852, was submitted to the trustees on May 5; in May 1854 the necessary expenditure was sanctioned by parliament, and the building was opened in May 1857. Its construction had involved a multitude of ingenious arrangements, all of which had been contrived or inspected by Panizzi with the genius for minute detail which he shared with so many men equally remarkable for the general breadth of their conceptions, and with the mechanical inventiveness of which he was continually giving proof. There is probably no building in the world better adapted to the purpose which it is intended to serve; and it is no discredit to the designer if, imposing as it is, neither the space nor the funds at his disposal allowed him to plan it on the colossal scale which its utility would have warranted.

Panizzi succeeded Sir Henry Ellis as principal librarian in March 1856. The most remarkable incidents of his administration were the great improvement effected in the condition of the Museum staff by the recognition of the institution as a branch of the civil service, and the decision, not carried out for long afterwards, to remove the natural history collections to Kensington. Of this questionable measure Panizzi was a warm advocate; he was heartily glad to be rid of the naturalists. He had small love for science and its professors, and, as his friend Macaulay said, "would at any time have given three elephants for one Aldus." Many important additions to the collections were made during his administration, especially the Temple bequest of antiquities, and the Halicarnassæan sculptures discovered at Budrum by Mr. C. T. Newton. Feeling the effects of age and excessive labour, he expressed a wish to retire in 1865, but remained some time longer in office at the instance of the trustees. He ultimately retired in July 1866, receiving as a special mark of distinction a pension equal to the full amount of his salary. He took a house in the immediate neighbourhood of his cherished institution, and continued to interest himself actively in its



affairs until his death, which took place on April 8, 1879. He had been created a K.C.B. in 1869.

Along with Panizzi's visible and palpable activity as the centre of energy at the British Museum, was another systematic activity no less engaging and important, but unacknowledged by himself and little suspected by the world. His devotion to the Museum was rivaled by his devotion to his country, and his personal influence with English Liberal statesmen enabled him to promote her cause by judicious representations at critical periods. Throughout the revolutionary movements of 1848-49, and again during the campaign of 1859 and the subsequent transactions due to the union of Naples to the kingdom of Upper Italy, Panizzi was in constant communication with the Italian patriots, and their confidential representative with the English ministers. He laboured, according to circumstances, now to excite now to mitigate the latter's jealousy of France; now to moderate their apprehensions of revolutionary excesses, now to secure encouragement or connivance for Garibaldi. The letters addressed to him by patriotic Italians, edited by his literary executor and biographer, Mr L. Fagan, alone compose a thick volume. His own have not as yet been collected; but the internal evidence of the correspondence published attests the priceless value of his services, and the boundless confidence reposed in his sagacity, disinterestedness, and discretion. He was chaffable to his exiled countrymen in England, and, chiefly at his own expense, equipped a steamer, which was lost at sea, to rescue the Neapolitan prisoners of state on the island of Santo Stefano. His services were recognised by the offer of a senatorship and of the direction of public instruction in Italy; but England, where he had been legally naturalised, had become his adopted country, though in his latter years he frequently visited the land of his birth.

Panizzi's merits and defects were those of a potent nature. He was a man born to rule, and in a free country would probably have devoted himself to public life and become one of the leading statesmen of his age. His administrative faculty was extraordinary: to the widest grasp he united the minutest attention to matters of detail. His will and perseverance were indomitable, but the vehemence of his temper was mitigated by an ample endowment of tact and circumspection. He was a powerful writer, a persuasive speaker, and an accomplished diplomatist. He was undoubtedly arbitrary and despotic; in some few points upon which he had hastily taken up wrong views, incurably prejudiced; in others, such as the claims of science, somewhat perversely narrow-minded. But on the whole he was a very great man, who, by introducing great ideas into the management of the Museum, not only redeemed that institution from being a mere show-place, but raised the standard of library administration all over England. His successors may equal or surpass his achievements, but only on condition of labouring in his spirit, a spirit which did not exist before him. His moral character was the counterpart of his intellectual: he was warm hearted and magnanimous, extreme in love and hate, a formidable enemy, but a devoted friend. The list of his intimate friends is a long and brilliant one, including Lord Palmerston, Mr Gladstone, Roscoe, Granville, Macaulay, Lord Langdale and his family, Rutherford (Lord Advocate); and above all, perhaps, Haywood, the translator of Kant. His most celebrated friendship, however, is that with Prosper Mérimé, who, having begun by seeking to enlist his influence with the English Government on behalf of Napoleon III., discovered a congeniality of tastes which produced a delightful correspondence. Mérimé's part has been published by Mr Fagan; Panizzi's perished in the conflagration kindled by the Paris commune. The loss is to be regretted rather on account of the autobiographical than the literary value of Panizzi's share of the correspondence, although he was an accomplished man of letters of the 18th century pattern. But no man of ability has more completely exemplified the apophthegm of another distinguished person, that success is won less by ability than by character.

See L. Fagan, *Life of Mr Anthony Panizzi*, 2 vols., London, 1880. (R. G.)

**PANNA**, or **PUNNAH**, a native state in Bundelkhand, India, situated for the most part on the table-lands above the Vindhyan Gháts, and containing much hill and jungle land, with an area of 2568 square miles, and a population in 1881 of 227,306. The state was formerly celebrated for its diamond mines in the neighbourhood of Panna town, but these appear to have become almost exhausted, and only a small and fluctuating revenue is now derived from them.

**PANNONIA**, in ancient geography, is the country bounded N. and E. by the Danube from a point 9 or 10 miles north of Vindobona (Vienna) to Singidunum (Belgrade) in Mœsia, and continuous westward with Noricum and Italy and southward with Dalmatia and

Mœsia Superior. It thus corresponds to the south-west of Hungary with portions of Lower Austria, Styria, Carniola, and Croatia and Slavonia. Partially conquered in 35 B.C. (when the town of Siscia was taken), Pannonia (but probably only what was afterwards known as Lower Pannonia) was made a Roman province by Tiberius in 8 A.D. The three legions stationed in the country at the death of Augustus (14 A.D.) rose in rebellion and were quelled by Drusus. Somewhere between 102 and 107 Trajan divided the province into Pannonia Superior and Pannonia Inferior. These, according to Ptolemy, were separated by a line from Arrabona (Raab) in the north to Servitium (Gradiaca) in the south, but at a later date the boundary lay farther east, to the diminution of Pannonia Inferior. The erection of two new provinces, Valeria and Savia, in the time of Diocletian gave rise to a fourfold division; and Constantine placed Pannonia Prima, Valeria, and Savia under the prætorian prefect of Italy, and Pannonia Secunda under the prætorian prefect of Illyricum. Pannonia Prima was the north part of the old Pannonia Superior and Savia the south part; Pannonia Secunda lay round about Sirmium, at the meeting of the valleys of the Save, the Drave, and the Danube; and Valeria (so called by Galerius after Valeria his wife and Diocletian's daughter) extended along the Danube from Altinum (Mohacs) to Brigetio (Ó-Szőny). Theodosius II. had to cede Pannonia to the Huns, and they were followed in turn by the Ostrogoths, the Longobards, and the Avars.

During the four hundred years of Roman occupation Pannonia reached a considerable pitch of civilization, and a number of the native tribes were largely Latinized. Upper Pannonia contained Vindobona (Vienna), a municipium; Carnuntum (Petronell), which became probably about 70 A.D. the winter quarters of the Pannonian legions, was made a municipium by Hadrian or Antoninus Pius, appears in the 3d century as a colonia, and has left important epigraphic remains; Arrabona (Raab or Győr), a considerable military station; Brigetio (Ó-Szőny), founded probably in the 2d century as the seat of Legio Prima Adjutrix, and afterwards designated municipium and colonia; Scarbantia or Scarbantia (Oedenburg or Soprony), a municipium of Julian origin according to Pliny, but of Ælian according to the inscriptions; Saveria or Sabaria (Stein am Anger or Sombathely), a purely civil municipium founded by Claudius, and a frequent residence of the later emperors; Poetovio (Ptobium of Ptolemy, Ptavio of *Itin. Anton.*; modern Pettau), first mentioned by Tacitus (69 A.D.) as the seat of Legio XIII. Gemina, and made a colonia by Trajan; Siscia (Sisak), formerly known as Segestaca or Segesta, a place of great importance down to the close of the empire, made a colonia probably by Vespasian, and restored by Severus (colonia Flavia Septimia); Nevidunum (Dernovo), designated municipium Flavium; municipium Latoblocorum (Treffen); Emona or Hemona, *Hemona* (Laibach); and Nauportus (Ober-Laibach). Lower Pannonia contained Sirmium (Mitrovic), first mentioned in 6 A.D., made a colonia by Vespasian or his successor, and a frequent residence of the later emperors; Bændana (near Petrovo), Cissum (Peterwardin), Malata or Ebonica (Bancoster), Cibale (Vinkovce), a municipium; Murus (Zessak), made a colonia by Hadrian 138 A.D.; Sopianæ (Fünfkirchen or Pecs), seat of the præses of Valeria, and an important place at the meeting of five roads; Aquinum (Alt-Ofen), made a colonia by Hadrian, and the seat of Legio II. Adjutrix; and Cirpi (near Bogdány). See *Corp. Inscr. Lat.*, vol. III. 1.

**PANORAMA** is the name given originally to a pictorial representation of the whole view which is visible from one point by an observer who in turning round looks successively to all points of the horizon. In an ordinary picture only a small part of the objects visible from one point is included, far less being generally given than the eye of the observer can take in whilst stationary. The drawing is in this case made by projecting the objects to be represented from the point occupied by the eye on a plane. If a greater part of a landscape has to be represented, it becomes more convenient for the artist to suppose himself surrounded by a cylindrical surface in whose centre he stands, and to project the

<sup>1</sup> In the 4th century it became a town of Noricum, not of Pannonia.

landscape from this position on the cylinder. In a panorama such a cylinder, originally of about 60 feet, but now extending to upwards of 130 feet diameter, is covered with an accurate representation in colours of a landscape, so that an observer standing in the centre of the cylinder sees the picture like an actual landscape in nature completely surround him in all directions. This gives an effect of great reality to the picture, which is skilfully aided in various ways. The observer stands on a platform representing, say, the flat roof of a house, and the space between this platform and the picture is covered with real objects which gradually blend into the picture itself. The picture is lighted from above, but a roof is spread over the central platform so that no light but that reflected from the picture reaches the eye. In order to make this light appear the more brilliant, the passages and staircases which lead the spectator to the platform are kept nearly dark. These panoramas were invented by Robert Barker, an Edinburgh artist, who exhibited the first in Edinburgh in 1788, representing a view of that city. A view of London and views of sea fights and battles of the Napoleonic wars followed. Panoramas gained less favour on the Continent, until after the Franco-German war a panorama of the siege of Paris was exhibited in Paris.

The name panorama, or panoramic view, is also given to drawings of views from mountain peaks or other points of view, such as are found in many hotels in the Alps, or, on a smaller scale, in guide-books to Switzerland and other mountainous districts. These too are drawn as if projected on a cylinder afterwards cut open and unrolled. The geometrical laws which guide the drawing of panoramas follow easily from the general rules for PROJECTION (*q.v.*).

**PANSY** (*Viola* sp.). This flower has been so long cultivated that its source is a matter of uncertainty. As we now see it, it is a purely artificial production, differing considerably from any wild plant known. By some it is supposed to be merely a cultivated form of *Viola tricolor*, a corn-field weed, while others assert it to be the result of hybridization between *V. tricolor* and other species such as *V. altaica*, *V. grandiflora*, &c. As florists and gardeners conducted, and still too often conduct, their operations without scientific method, it is unfortunately not possible to arrive at any definite conclusion on this point. Some experiments of M. Carrière, however, go to show that seeds of the wild *V. tricolor* will produce forms so like those of the cultivated pansy that it is reasonable to assume that that flower has originated from the wild plant by continuous selection. Mr Darwin confesses himself to have been foiled in the attempt to unravel the parentage of the pansy, "and gave up the attempt as too difficult for any one except a professed botanist." The changes that have been effected from the wild type are, however, more striking to the eye than really fundamental. Increase in size, an alteration in form by virtue of which the narrow oblong petals are converted into circular ones, and variations in the intensity and distribution of the colour—these are the changes that have been wrought by continued selection, while the more essential parts of the flower have been relatively unaffected. The stamens and pistil, in fact, present the characteristics of the genus *Viola*. In that genus the construction of the stamens and pistil is such as to favour cross-fertilization, and that circumstance alone would account for much of the variation that is observed. In practice it is customary to propagate by means of cuttings the varieties it is desired to perpetuate, while, if additional varieties are desired, reproduction by seed, and careful selection of seedlings, according to the desire or fancy of the cultivator, are had recourse to. Self-fertilizing

(cleistogamic) flowers, such as occur in various species of violet, and in which the petals are absent or inconspicuous, not being required for the purpose of attracting insects, have not as yet been observed in pansies.

**PANTAENUS**, head of the catechetical school at Alexandria at the close of the 2d Christian century, is known chiefly as having been the master of Clement, who succeeded him. Eusebius and Jerome speak of him as having been, originally at least, a Stoic, and as having been sent, on account of his zeal and learning, as a missionary to "India"—Yemen perhaps being meant. He was the author of commentaries on various books of Scripture, all of which have been lost with the exception of a few insignificant fragments. His teaching work in Alexandria seems to have begun before 180 A.D., and it was brought to an end by the persecution of Septimius Severus in 202.

**PANTELLARIA**, **PANTALARIA**, or officially **PANTELLERIA** (the ancient *Cosyra* or *Cosyra*), an island in the Mediterranean, which, though only 45 miles from the African coast to the south of Cape Bon, and 75 miles from the coast of Sicily, is included in the Italian province and circondario of Trapani. It is of volcanic origin, and its area is estimated at 58 square miles. Its principal summit reaches a height of 2440 feet. Hot sulphur springs occur in various places, and there is a small salt-lake of somewhat high temperature; but there is a lack of fresh water. The principal town, Oppidolo or Pantellaria, on the north-west, lies round a port protected by two redoubts and a citadel now used as a prison. Trade is carried on with Algeria, Tunis, and Malta. From 131 vessels (12,917 tons) in 1863 the movement of the port had by 1880 increased to 923 vessels (83,524 tons). In 1881 the population of the town was 3167, that of the island 7315.

The Phœnician name *Ἰνσῆ*, *Insam*, on coins has led Renan to identify the island with the *Inarime* of the Latin poets. The capture of *Cosyra* by M. Æmilius and Servius Fulvius in the First Punic War was thought worth mentioning in the triumphal fasti, though the Carthaginians recovered possession in the following year. In modern times the island has formed a principality in the hands of the *Requesens* family. The bastard Italian spoken by the inhabitants shows Arabic influence.

**PANTHEISM**. See **THEISM**.

**PANTHER**. See **LEOPARD**.

**PANTOGRAPH** is an instrument for making a reduced, an enlarged, or an exact copy of a plane figure. One of the simplest forms is represented in fig. 1. Four links of wood or metal are jointed together so as to form a parallelogram ABCS. On two sides BA and BC produced points P and P' are taken in a line with S, so that the triangles PSA and SPC are similar, as the sides of the

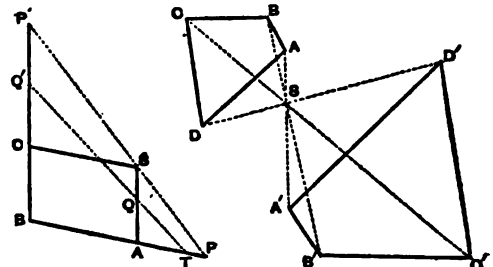

Fig. 1.

Fig. 2.

one are parallel to those of the other. Hence  $SA/AP = P'C/CS$ . Now the parallelogram ABCS is movable, its angles changing whilst its sides remain unaltered. The above ratio will therefore remain constant, and therefore again the points PSP' will always remain in a line. At the same time the ratio  $PS/SP'$  does not change, as it equals the ratio  $PA/AB$ . If then the point S be kept

fixed in a plane, and if P be made to describe any given figure, the point P' will describe another figure which is similar and similarly situated to the given one with S as centre of similitude, the ratio of similitude being PS:SP'. Thus if the point S be fixed at S fig. 2, and if P be made to describe the figure ABCD, then P' will describe the similar figure A'B'C'D'. For the geometry of figures which are similar and similarly situated, compare "Similar Figures" under PROJECTION.

For practical working there is at P a steel tracer having a fine but not sharp point, and at P' a tracing pencil for drawing the copy, or sometimes a sharp steel point for at once engraving the copy on a plate of metal. To obtain the smooth and steady motion of the instrument required for delicate work, a variety of different constructions are in use under various names, but all rest on the above principle that three points are kept in a line with their distances in a constant ratio. It will be noticed if any three points T, Q, Q' in a line be taken, as in fig. 1, these fulfil the conditions required, so that, for instance, T might be taken as the fixed point, and Q, Q' as the tracer and pencil.

PANTOMIME is a term which has been employed in different senses at different times in the history of the drama. Of the Roman *pantomimus*, a spectacular kind of play in which the functions of the actor were confined to gesticulation and dancing, while occasional music was sung by a chorus or behind the scenes, some account has been given elsewhere (vol. vii. p. 412). To speak of the Western drama only, there is no intrinsic difference between the Roman *pantomimus* and the modern "ballet of action," except that the latter is accompanied by instrumental music only, and that the personages appearing in it are not usually masked. The English "dumb-show," though fulfilling a special purpose of its own, was likewise in the true sense of the word pantomimic. On the other hand, the modern pantomime, as the word is still used, more especially in connexion with the English stage, signifies a dramatic entertainment in which the action is carried on with the help of spectacle, music, and dancing, and in which the performance is partly carried on by certain conventional characters, originally derived from Italian "masked comedy," itself an adaptation of the *fabula Atellanæ* of ancient Italy. Were it not for this addition, it would be difficult to define modern pantomime so as to distinguish it from the mask, and the least rational of English dramatic species would have to be regarded as essentially identical with another to which in its later development our dramatic literature owes some of its choicest fruit (see DRAMA, vol. vii.).

As a matter of course, no fixed date can be assigned to the birth of modern pantomime. The contributory elements which it contains had very soon in varying proportions and manifold combinations introduced themselves into the modern drama as it had been called into life by the Renaissance. In Italy the transition was almost imperceptible from the pastoral drama to the opera; on the Spanish stage ballets with allegorical figures and military spectacles were known already towards the close of the 16th century; in France ballets were introduced in the days of Mary de' Medici, and the popularity of the opera was fully established in the earlier part of the reign of Louis XIV. Meanwhile, in the previous century the improvised Italian comedy (*commedia dell' arte*) had crossed the Alps with its merry company of characters, partly borrowed from masked comedy, though also largely corresponding to the favourite types of regular comedy both ancient and modern, and including Pantalone, with Arlecchino, among other varieties of *zanni*.<sup>1</sup> Readers of Molière are aware of the influence of the Italian

<sup>1</sup> Whether the traditional costume of the ancient Roman *zanni*—the *concinnetus* or variegated harlequin's jacket, the shaven head, the sooty face, and the unshod feet—had before this been known among the provincials, may be left undecided.

players upon the progress of French comedy, and upon the works of its incomparable master. In other countries, where the favourite types of Italian popular comedy had been less generally seen or were unknown, popular comic figures such as the English fools and clowns, the German *Hannurst*, or the Dutch *Pickelhering*, were ready to renew themselves in any and every fashion which preserved to them the gross salt favoured by their patrons. Indeed in Germany, where the term pantomime was not used, a rude form of dramatic buffoonery, corresponding to the coarser sides of the modern English species so-called, long flourished, and threw back for centuries the progress of the regular drama. After being at last suppressed, it found a commendable substitute in the modern *Zauberposse*, the more genial Vienna counterpart of the Paris *féerie*.

In England, where the mask was only quite exceptionally revived after the Restoration, the love of spectacle and other frivolous allurements was at first mainly met by the various forms of dramatic entertainment which went by the name of "opera." In the preface to *Albion and Albanicus* (1685), Dryden gives a definition of opera which would fairly apply to modern extravaganza, or to modern pantomime with the harlequinade left out. Character-dancing was, however, at the same time largely introduced into regular comedy; and, as the theatres vied with one another in seeking *quocumque modo* to gain the favour of the public, the English stage was fully prepared for the innovation which awaited it. Curiously enough, the long-lived-but cumbrous growth called pantomime in England owes its immediate origin to the beginnings of a dramatic species which has artistically furnished congenial delight to nearly two centuries of Frenchmen. Of the early history of *vaudeville* it must here suffice to say that the unprivileged actors at the fairs, who had borrowed some of the favourite character-types of Italian popular comedy, after eluding prohibitions against the use by them of dialogue and song, were at last allowed to set up a comic opera of their own. About the second quarter of the 18th century, before these performers were incorporated with the Italians, the light kind of dramatic entertainment combining pantomime proper with dialogue and song enjoyed high favour with the French and their visitors during this period of peace. The *vaudeville* was cultivated by Le Sage and other writers of mark, though it did not conquer an enduring place in dramatic literature till rather later, when it had, moreover, been completely nationalized by the extension of the Italian type.

It was this popular species of entertainment which, under the name of pantomime, was transplanted to England before in France it had attained to any fixed form, or could claim for its productions any place in dramatic literature. Colley Cibber mentions as the first example, followed by "that Succession of monstrous Medlles," a piece on the story of Mars and Venus, which was still in dumb-show; for he describes it as "form'd into a connected Presentation of Dances in Character, wherein the Passions were so happily expressed, and the whole Story so intelligibly told, by a mute Narration of Gesture-only, that even thinking Spectators allow'd it both a pleasing and a rational Entertainment." There is nothing to show that Harlequin and his companions figured in this piece. Geneste, who has no record of it, dates the period when such entertainments first came into vogue in England about 1733. In that year the pantomime of *Harlequin Dr Faustus* had been produced at Drury Lane,—its author being John Thurmond, a dancing master, who afterwards (in 1727) published a grotesque entertainment called *The Miser, or Wagner and Abercock* (a copy of this is in the Dyce Library). Hereupon, in December 1733, John Rich (1681–1781), then lessee of the theatre in Lincoln's Inn

Fields, produced there as a rival pantomime *The Necromancer, or History of Dr Faustus*, no doubt, says Geneste, "gotten up with superior splendour." He had as early as 1717 been connected with the production of a piece called *Harlequin Executed*, and there seem traces of similar entertainments as far back as the year 1700. But it was the inspiring influence of French example, and the keen rivalry between the London houses, which in 1723 really established pantomime on the English stage. Rich was at the time fighting a difficult battle against Drury Lane, and his pantomimes at Lincoln's Inn Fields, and afterwards at Covent Garden, were extraordinarily successful. He was himself an inimitable harlequin, and from Garrick's lines in his honour it appears that his acting consisted of "frolic gestures" without words. The favourite Drury Lane harlequin was Pinkethman (Pope's "poor Pinky"); readers of *The Tatler* (No. 188) will remember the ironical nicety with which his merits are weighed against those of his competitor Bullock at the other house. Colley Cibber, when described by Pope as "mounting the wind on grinning dragons," briskly denied having in his own person or otherwise encouraged such fooleries; in his *Apology*, however, he enters into an elaborate defence of himself for having allowed himself to be forced into countenancing the "gin-shops of the stage," pleading that he was justified by necessity, as Henry IV. was in changing his religion. Another butt of Pope's, Lewis Theobald, was himself the author of more than one pantomime; their titles already run in the familiar fashion, e.g., *A Dramatick Entertainment, call'd Harlequin a Sorcerer, with the loves of Pluto and Proserpine* (1725; the "book of the words," as it may be called, is in the Dyce Library). In another early pantomime (also in the Dyce Library) called *Perseus and Andromeda, with the Raps of Colombina, or The Flying Lovers*, there are five "interludes, three serious and two comic." This is precisely in the manner of Fielding's dramatic squib against pantomimes, *Tumble-down Dick, or Phaeton in the Suds*, first acted in 1744, and ironically dedicated to "Mr John Lun," the name that Rich chose to assume as harlequin. It is a capital bit of burlesque, which seems to have been directly suggested by Pritchard's *Fall of Phaeton*, produced in 1736.

There seems no need to pursue further the history of English pantomime. "Things of this nature are above criticism," as Mr Machine the "composer" of *Phaeton* says in Fielding's piece. The attempt was made more than once to free the stage from the incubus of entertainments to which the public persisted in flocking; in vain Colley Cibber at first laid down the rule of never giving a pantomime together with a good play; in vain his son Theophilus after him advised the return of part of the entrance money to those who would leave the house before the pantomime began. "It may be questioned," says the chronicler, "if there was a demand for the return of £20 in ten years." Pantomime carried everything before it when there were several theatres in London, and a dearth of high dramatic talent prevailed in all; and, allowing for occasional counter-attractions of a not very dissimilar nature, pantomime continued to flourish after the Licensing Act of 1737 had restricted the number of London play-houses, and after Garrick's star had risen on the theatrical horizon. He was himself obliged to satisfy the public appetite, and to disoblige the admirers of his art, in deference to the drama's most imperious patrons—the public at large.

It should be noted that in France an attempt was made by NOVERRE (q.v.) to restore pantomime proper to the stage as an independent species, by treating mythological subjects seriously in artificial ballets. This attempt, which of

course could not prove permanently successful, met in England also with great applause. In an anonymous tract of the year 1789 in the Dyce Library, attributed by Dyce to Archdeacon Nares (the author of the *Glossary*), Noverre's pantomime or ballet *Cupid and Psyche* is commended as of very extraordinary merit in the choice and execution of the subject. It seems to have been without words. The writer of the tract states that "very lately the serious pantomime has made a new advance in this country, and has gained establishment in an English theatre;" but he leaves it an open question whether the grand ballet of *Medea and Jason* (apparently produced a few years earlier, for a burlesque on the subject came out in 1781) was the first complete performance of the kind produced in England. He also notes *The Death of Captain Cook*, adapted from the Parisian stage, as possessing considerable dramatic merit, and exhibiting "a pleasing picture of savage customs and manners." To conclude, the chief difference between the earlier and later forms of English pantomime seems to lie in the fact that in the earlier Harlequin pervaded the action, appearing in the comic scenes which alternated throughout the piece with the serious which formed the backbone of the story. Columbine (originally in Italian comedy Harlequin's daughter) was generally a village maiden courted by her adventurous lover, whom village constables pursued, thus performing the laborious part of the policeman of the modern harlequinade. The brilliant scenic effects were of course accumulated, instead of upon the transformation scene, upon the last scene of all, which in modern pantomime follows upon the shadowy chase of the characters called the *rally*. The commanding influence of the clown, to whom pantaloons is attached as friend, flatterer, and foil, seems to be of comparatively modern growth; the most famous of his craft was undoubtedly Joseph Grimaldi (1779–1837), of whom Charles Dickens in his youth edited a biography. His memory is above all connected with the famous pantomime of *Mother Goose*, produced at Covent Garden in 1806. It boots not to enumerate favourites of later days; the type of Christmas pantomime cherished by a generation now passing away has been preserved from oblivion in Thackeray's *Sketches and Travels in London*. The species still maintains its hold over sections of the grown-up public, and, though now only cultivated in a few of the leading London theatres, appears at Christmas 1883–84, according to professional statistics, to have multiplied itself in the capital alone by thirteen examples.

See Geneste, *Account of the English Stage*, especially vol. iii.; Dibdin, *Complete History of the Stage*, especially vols. ii., iv., and v.; *Apology for the Life of Colley Cibber*; Fitzgerald, *Life of Garrick*; Pröiss, *Dramaturgie*. (A. W. W.)

PANYASIS, of Halicarnassus, a poet of the early half of the 5th century B.C. He was a near relation of the historian Herodotus. According to some his father Polyarchus was brother of Herodotus's father Lyxes; according to others, Rhœo or Dryo, the mother of Herodotus, was a sister of Panyasis. He led a revival of the old Ionian epic poetry, and his younger contemporary Antimachus continued the movement. Only insignificant fragments of his works are preserved. He wrote a *Heracles*, in which the whole of the Heracles-myths were embraced in 14 books (9000 lines), and another poem in elegiacs, 7000 lines long called *Ioniaca*, in which he related the story of the Ionic settlements in Asia Minor and the exploits of Codrus and Nelus. Though not much thought of in his own time, he is praised by later critics. He was slain by Lygdamis, tyrant of Halicarnassus.

PAOLI, PASQUALE DE (1725–1807), generalissimo of Corsica, was the son of Giacinto Paoli, a Corsican patriot, and his mother was descended from the old family of the

Caporali. He was born in the village of La Stretta in the district of Rostino, 25th April 1725. After the hopes of the Corsicans were overthrown by the French in 1738, he accompanied his father to Naples, where he entered the military college. In an expedition against Calabrian bandits he greatly distinguished himself, and when in 1755 he returned to Corsica he had acquired so high a reputation that he was chosen generalissimo in a full assembly of the people. His refusal to accept Matra for a colleague, led the latter to take advantage of the dissatisfaction of some influential Corsicans to stir up an insurrection. With the aid of the Genoese, Matra for a time made a formidable stand, but after his death in battle Paoli turned his arms against the Genoese with such success that in 1761 they proposed terms of peace. As Paoli would consent to nothing less than the complete independence of Corsica, the Genoese, despairing of their ability to establish a hold on the island, sold it in 1768 to France. The French effected a landing in 1769 with 22,000 men under Count Vaux, and after a stubborn and prolonged resistance Paoli was totally defeated, and, barely succeeding in cutting his way through the enemy, escaped on board an English frigate and went to England. His rule in Corsica, notwithstanding the distraction of the continual struggle to maintain its independence, had been marked by the introduction of many important reforms, such as the remodelling of the laws, the establishment of permanent courts, the regulation of the coinage, and the furtherance of various measures for the encouragement of agriculture, manufactures, and commerce. At the instance of the duke of Grafton, prime minister of England, Paoli received from the English Government a pension of £1200 a year. He came to be on intimate terms with Dr Samuel Johnson, to whom he was introduced by Boswell. When, after the French Revolu-

tion, Corsica was numbered among the departments of France, Paoli agreed to return to Corsica as lieutenant-general and governor of the department; but, the excesses of the Convention having alienated his sympathies, he, with the help of Great Britain, organized a revolt, and in 1793 was elected generalissimo and president of the council of government at Corte. Despairing, however, of maintaining the independence of the island, he in 1795 agreed to its union with Great Britain, and on George III. being declared king returned to England. He died near London in February 1807. Clemente, elder brother of Pasquale Paoli, also distinguished himself in the struggles of Corsica against the Genoese. Subsequently he retired to a convent at Vallambrosa, but at the end of twenty years returned to Corsica, and died there in 1793.

See Boswell's *Life of Johnson* and his *Account of Corsica*, 1768; *Review of the Conduct of Pascal Paoli*, 1770; *Life of Paoli*, by Arrighi (Paris, 1848), Klose (Brunswick, 1858), Bartoli (Ajaccio, 1867), and Oris (Genoa, 1869).

PAOLO, FRA. See SARP.

PAOLO VERONESE. See VERONESE.

PÁPA, a large country-town of Hungary, in the district of Veszprim, lies on the Raab and Steinamanger Railway, 75 miles to the west of Pesth. It is the seat of a fine chateau and park of the Esterházy family, by whom the handsome Roman Catholic church, lined with red marble, was built in 1778. It also contains a Protestant church, a good Protestant school established about 1630, a Roman Catholic gymnasium, and three convents. A quaint one-storied edifice is shown as the house of Matthew Corvina. The chief industries are weaving, wine-growing, and the manufacture of paper and stoneware. The population in 1880 was 14,654.

PAPAOY. See POPE and POPKOD.

PAPAL STATES. See STATES OF THE CHURCH.

## P A P E R

THE origin and early history of paper as a writing material are involved in much obscurity. The art of making it from fibrous matter, and, among other substances, from the wool of the cotton plant, reduced to a pulp, appears to have been practised by the Chinese at a very distant period. Different writers have traced it back to the 2d century B.C. But however remote its age may have been in eastern Asia, cotton paper first became available for the rest of the world at the beginning of the 8th century, when the Arabs captured Samarkand (704 A.D.), and there learnt its use. The manufacture was taken up by them in that city, and rapidly spread through all parts of their empire. From the large quantities which were produced at Damascus, it obtained one of the titles, *charta Damascena*, by which it was known in the Middle Ages. The extent to which it was adopted for literary purposes is proved by the comparatively large number of early Arabic MSS. on paper which have come down to us, dating from the 9th century.<sup>1</sup>

<sup>1</sup> A few of the earliest dated examples may be instanced. The *Gharib* 'l-*Hadith*, a treatise on the rare and curious words in the sayings of Mohammed and his companions, written in the year 866, is probably one of the oldest paper MSS. in existence (*Pal. Soc.*, Orient. Ser., pl. 6). It is preserved in the University Library of Leyden. A treatise by an Arabian physician on the nourishment of the different members of the body, of the year 960, is the oldest dated Arabic MS. on paper in the British Museum (Or. MS. 2600; *Pal. Soc.*, pl. 96). The Bodleian Library possesses a MS. of the *Dawānu 'l-Adab*, a grammatical work of 974 A.D., of particular interest as having been written at Samarkand on paper presumably made at that seat of the first Arab manufacture (*Pal. Soc.*, pl. 60). Other early examples are a volume of poems written at Baghdad, 990 A.D., now at Leipzig, and the Gospel of St Luke, 993 A.D., in the Vatican Library (*Pal.*

With regard to the introduction of paper into Europe, it naturally first made its appearance in those countries more immediately in contact with the Oriental world. Besides receiving the names of *charta* and *papyrus*, transferred to it from the Egyptian writing material manufactured from the papyrus plant (see PAPYRUS), cotton paper was known in the Middle Ages as *charta bombycina*, *gossypina*, *cattunea*, *eylina*, *Damascena*, and *serica*. The last title seems to have been derived from its glossy and silken appearance. It was probably first brought into Greece through trade with Asia, and from thence transmitted to neighbouring countries. Theophilus presbyter, writing in the 12th century (*Schedula diversarum artium*, i. 23), refers to it under the name of Greek parchment—"tolle pergamenam Græcam, quæ fit ex lana ligni." In the 10th century *dambacium* was used at Rome. There is also a record of the use of paper by the empress Irene at the end of the 11th or beginning of the 12th century, in her rules for the nuns of Constantinople. It does not appear, however, to have been very extensively used in Greece before the middle of the 13th century, for, with one doubtful exception, there are no extant Greek MSS. on paper which bear date prior to that period.

The manufacture of paper in Europe was first established by the Moors in Spain, the headquarters of the industry being Xativa, Valencia, and Toledo. But on the fall of

*Soc.*, pl. 7, 21). In the great collection of Syriac MSS. which were obtained from the Nitrian desert in Egypt, and are now in the British Museum, there are many volumes written on cotton paper of the 10th century. The two oldest dated examples, however, are not earlier than 1075 and 1084 A.D.

the Moorish power the manufacture, passing into the hands of the less skilled Christians, declined in the quality of its production. In Italy also the art of paper-making was no doubt in the first place established through the Arab occupation of Sicily. But the paper which was made both there and in Spain, it must be remembered, was in the first instance cotton paper. In the laws of Alphonso of 1263 it is referred to as cloth parchment, a term which well describes the thick material made from cotton. As, however, the industry was pushed north, into districts where cotton was not to be found as a natural growth or was not imported, other substances had to be pressed into the service. Hence by degrees arose the practice of mixing rags, in the first instance no doubt of woollen fabrics, with the raw material. The gradual substitution of linen, in countries where it was more abundant or where it was the only suitable material at hand, was a natural step in the progress of the manufacture.

The first mention of rag paper occurs in the tract of Peter, abbot of Cluny (1122-50 A.D.), *adversus Judæos*, cap. 5, where, among the various kinds of books, he refers to such as are written on material made "ex rasuris veterum pannorum." At this early period woollen cloth is probably intended. Linen paper was first made in the 14th century; but in the first half of that century it is probable that woollen fabrics still entered largely into the component parts of the pulp—a fact which, however, can only be proved in individual instances by aid of the microscope. This being the case, it is of less practical advantage to try to ascertain an exact date for the first use of linen in paper-making than to define the line of demarcation between the two classes of paper, viz., that made in the Oriental fashion without water-marks, and that in which these marks are seen. The period when this latter kind of paper came into existence lies in the first years of the 14th century, when paper-making at length became a veritable European industry. Cotton paper of the Oriental pattern, it is true, is still found here and there in use some time after the manufacture of the water-marked material had begun, but the instances which have survived are few and are mostly confined to the south of Europe.

A few words may here be said respecting the extant examples of cotton paper MSS. written in European countries. Several which have been quoted by former writers as early instances have proved, on more recent examination, to be nothing but vellum. The ancient fragments of the Gospel of St Mark, preserved at Venice, which were stated by Maffei to be of cotton paper, by Montfaucon of papyrus, and by the Benedictines of bark, are in fact written on skin. The oldest document on cotton paper is a deed of King Roger of Sicily, of the year 1102; and there are others of Sicilian kings, of the 12th century. The oldest known imperial deed on the same material is a charter of Frederick II. to the nuns of Goess in Styria, of the year 1228, now at Vienna. In 1231, however, the same emperor forbade further use of paper for official documents, which were in future to be inscribed on vellum. In Venice the *Liber plegiorum*, the entries in which begin with the year 1223, is made of rough cotton paper; and similarly the registers of the Council of Ten, beginning in 1325, and the register of the emperor Henry VII. (1308-13) preserved at Turin, are also written on a like substance. In the British Museum there is an older example in a MS. (Arunde: 268) which contains some astronomical treatises written on an excellent paper in an Italian hand of the first half of the 13th century. The letters addressed from Castile to the English king, Edward I., in 1279 and following years (Pauli in *Bericht. Berl. Akad.*, 1854) are instances of Spanish-made paper; and other specimens in existence prove that in this latter country a rough kind of

*carta bombycina* was manufactured to a comparatively late date.

In Italy the first place which appears to have become a great centre of the paper-making industry was Fabriano in the marquisate of Ancona, which rose into importance on the decline of the manufacture in Spain. The jurist Bartolo, in his treatise *De insignis et armis*, refers to the excellent paper made there in the middle of the 14th century, an encomium which will be supported by those who have had occasion to examine the extant MSS. of Italian paper of that period, which even now excites admiration for its good quality. In 1340 a factory was established at Padua; another arose later at Treviso; and others followed in the territories of Florence, Bologna, Parma, Milan, Venice, and other districts. From the line of factories of northern Italy the wants of southern Germany were supplied as late as the 15th century. As an instance the case of Görlitz has been cited, which drew its paper from Milan and Venice for the half century between 1376 and 1426. But in Germany also factories were rapidly founded. The earliest are said to have been set up between Cologne and Mainz, and in Mainz itself about the year 1320. At Nuremberg Ulman Stromer established a mill in 1390, with the aid of Italian workmen. Other places of early manufacture were Ratisbon and Augsburg. Western Germany, as well as the Netherlands and England, is said to have obtained paper at first from France and Burgundy through the markets of Bruges, Antwerp, and Cologne. France owed the establishment of her first paper-mills to Spain, whence we are told the art of paper-making was introduced, as early as the year 1189, into the district of Hérault. The French paper of this early date was of course of cotton. At a later period, in 1406, among the accounts of the church of Troyes, such mills appear as *molins à toile*. The development of the trade in France must have been very rapid, for, as we have already noticed, that country was soon in a position to supply her neighbours as well as to provide for her own wants. And with the progress of manufacture in France that of the Netherlands also grew.

A study of the various water-marks has yielded some results in tracing the different channels in which the paper trade of different countries flowed; but a thorough and systematic collection and classification of them has yet to be accomplished. Experience also of the different kinds of paper, and a knowledge of the water-marks, aid the student in fixing nearly exact periods to undated documents. Rag paper of the 14th century may generally be recognized by its firm texture, its stoutness, and the large size of its wires. The water-marks are usually simple in design; and, being the result of the impress of thick wires, they are therefore strongly marked. In the course of the 15th century the texture gradually becomes finer and the water-marks more elaborate. While the old subjects of the latter are still continued in use, they are more neatly outlined, and, particularly in Italian paper, they are frequently enclosed in circles. The practice of inserting the full name of the maker in the water-mark came into fashion in the course of the 16th century. The variety of subjects of water-marks is most extensive. Animals, birds, fishes, heads, flowers, domestic and warlike implements, armorial bearings, &c., are found from the earliest times. Some of these, such as armorial bearings, and national, provincial, or personal cognisances, as the imperial crown, the crossed keys, or the cardinal's hat, can be attributed to particular countries or districts; and the wide dissemination of the paper bearing these marks in different countries serves to prove how large and international was the paper trade in the 14th and 15th centuries.



In the second half of the 14th century the use of paper for all literary purposes had become well established in all western Europe; and in the course of the 15th century it gradually superseded vellum. In MSS. of this latter period it is not unusual to find a mixture of vellum and paper, a vellum sheet forming the outside leaves of a quire while the rest are of paper.

With regard to the early use of paper in England, there is evidence that quite at the beginning of the 14th century it was a not uncommon material, particularly for registers and accounts. Under the year 1310, the records of Merton College, Oxford, show that paper was purchased "pro registro," which Prof. Rogers (*Hist. Agricul. and Prices*, I. p. 644) is of opinion was probably cotton paper of the same character as that of the Bordeaux customs register in the Public Record Office, which date from the first year of Edward II. The college register referred to, which was probably used for entering the books that the fellows borrowed from the library, has perished. There is, however, in the British Museum a paper MS. (Add. 31,223), written in England, of even earlier date than the one recorded in the Merton archives. This is a register of the hustings court of Lyme Regis, the entries in which commence in the year 1309. The material is cotton paper, with apparently an admixture of rag, the threads of which are visible, imbedded in the pulp—similar to the kind which was used in Spain. It may indeed have been imported direct from that country or from Bordeaux; and a seaport town on the south coast of England is exactly the place where such early relics might be looked for. Professor Rogers also mentions an early specimen of paper made from rag in the archives of Merton College, on which is written a bill of the year 1332; and some leaves of water-marked paper of 1333 exist in the Harleian collection. Of a date only a few years later is the first of the registers of the King's Hall at Cambridge, a series of which, on paper, are preserved in the library of Trinity College. Of the middle of the 14th century also are many of the municipal books and records still to be found among the archives of ancient cities and towns. The knowledge, however, which we have of the history of paper-making in England is extremely scanty. The first maker whose name is known is one Tate, who is said to have set up a mill in Hertford early in the 16th century; and a German named Spielman had works at Dartford in 1588. But it is incredible that no paper was made in the country before the time of the Tudors. No doubt at first it was imported. But the comparatively cheap rates at which it was sold in the 15th century in inland towns, as well as in those nearer the coast, seem to afford ground for assuming that there was at that time a native industry in this commodity, and that it was not altogether imported.

As far as the prices have been observed at which different kinds of paper were sold in England in the early period of its introduction, it has been found that in 1355-56 the price of a quire of small folio paper was 5d., both in Oxford and London. In the 15th century the average price seems to have ranged from 3d. to 4d. for the quire, and from 3s. 4d. to 4s. for the ream. At the beginning of the 16th century the price fell to 2d. or 3d. the quire, and to 3s. or 3s. 6d. the ream; but in the second half of the century, owing to the debasement of the coinage, it rose, in common with all other commodities, to nearly 4d. the quire, and to rather more than 5s. the ream. The relatively higher price of the ream in this last period, as compared with that of the quire, seems to imply a more extensive use of the material which enabled the trader to dispose of broken bulk more quickly than formerly, and so to sell by the quire at a comparatively cheap rate.

Brown paper appears in entries of 1570-71, and was

sold in bundles at 2s. to 2s. 4d. Blotting paper is apparently of even earlier date, being mentioned under the year 1465. It was a coarse, grey, unsized paper, fragments of which have been found among the leaves of 15th century accounts, where it had been left after being used for blotting.

See *Gerardi Moermsæ et doctorum virorum ad eum Epistolæ atque Observationes de Charta vulgaris seu Linæ origina*, Hagæ, 1767; G. F. Wehrs, *Von Papier*, Halle, 1789; M. Koojn, *Historical Account of the substances used to describe events and to convey ideas, from the earliest date to the invention of Paper* (London, 1801), in great part repeating Wehrs—the book is printed on paper manufactured from straw; Ersch and Gruber, *Allgem. Encyclopædie*, art. "Papier," Leipzig, 1838; Sotzmann, "Ueber die ältere Papierfabrikation," in *Scrapsium*, Leipzig, 1846; W. Wattenbach, *Das Schriftwesen im Mittelalter*, Leipzig, 1876, pp. 114-123; J. E. T. Rogers, *History of Agriculture and Prices in England*, Oxford, 1866-82, *passim*. (E. M. T.)

#### MANUFACTURE OF PAPER.

Paper is a thin tissue composed of vegetable fibres (rarely of woollen fibres), resulting from their deposition on wire-cloth while suspended in water. At first it was entirely made by hand, but the invention in 1798 of the paper machine by Louis Robert, a clerk in the employment of Messrs Didot, of the celebrated Essonnes paper-mills, near Paris, gave a new impetus to the industry. The invention was introduced into England through the agency of Messrs Fourdrinier, who employed Bryan Donkin, the engineer, to assist in working it out; but, although they expended a large fortune in developing the invention, their enterprise resulted only in bankruptcy. Their first paper machine was erected in 1804 at Frogmoor Mill, near Boxmoor, Herts. In the United States it was not till 1820 that such a machine was started for the first time by Messrs T. Gilpin & Co., on the Brandywine. Since that period, machine-made paper has gradually supplanted that made by hand for all except special purposes, and has been brought to a high state of perfection by subsequent improvements in the machinery.

Paper may be divided into three main classes:—writing paper, printing paper, and wrapping paper. The staple of which writing and printing paper is made is, in Britain, rags and esparto; in America a considerable quantity of wood pulp is used. The staple of wrapping papers is old ropes and in some cases jute. The best writing and printing papers are still made, whether by hand or by machine, from rags.

*Manufacture of Paper from Rags.*—The first process is the cutting and sorting of the rags, which is invariably done by women. The rag-cutter stands behind a knife about 14 inches long set in an oblique position in a table before her; the rags are cut into pieces about the size of the hand, and the linen pieces separated from the cotton, the various qualities being put into different receptacles. After being cut they are subjected to the action of the willow and duster, which knocks the loose dust off. The willow is composed of two conical cylinders, inside of which iron spikes project. In the interior of these cylinders an iron drum, also provided with spikes, revolves at about 300 revolutions per minute. The rags are fed into the first cylinder by a travelling felt, and dashed through from the one to the other by the action of the revolving drum, and from the second cylinder thrown forward into the ducter. This consists of a large rectangular wooden case, in the interior of which an iron cage, covered with coarse wirecloth, revolves slowly at right angles to the willow. This cage is set at a slight incline, so that the rags which are thrown into it by the willow at one end slowly pass to the other, while the dust, &c., which has been disengaged by the action of the willow, falls through the wirecloth, and the dusted rags pass out at the other end, now ready for the boiler. The boiler is of different

forms, revolving or stationary. The most usual is stationary. It consists of an upright cylinder of cast or malleable iron (fig. 1), about 8 feet in diameter by 6 foot deep, and fitted with a perforated false bottom, on which the rags rest. The boiler is further fitted with a filling door A at the top, and an emptying door B below. After being

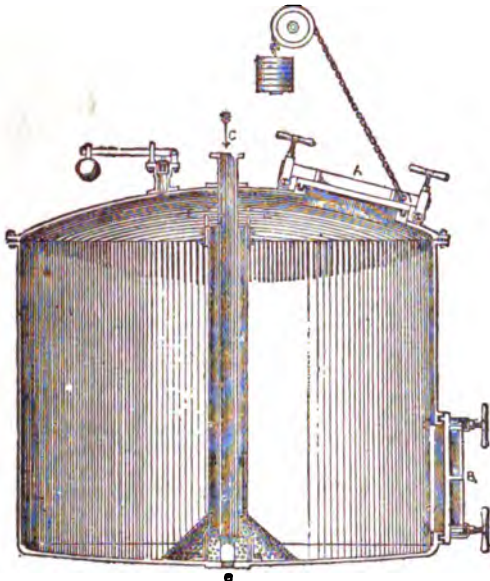

FIG. 1.—Section of Rag-Boiler.

charged with rags, it is filled to about half its height with water; a sufficient quantity of caustic soda, varying according to the nature of the rags, is introduced; the door is then shut, and steam is admitted by a small pipe C which is contained in, and communicates at the foot with, a larger pipe D and causes a constant circulation of hot liquid, which is dispersed all over the boiler by striking against a hood E at the top. This is technically known as the "vomit." The rags are boiled in this solution of caustic soda for ten to twelve hours, when the steam is turned off and the liquid is discharged by the pipe G. After a subsequent washing with cold water in the boiler the lower door is opened and the boiled rags withdrawn into small trucks, and picked by women to remove impurities, such as india-rubber, &c.

The rags are now submitted to the action of the breaking engine (figs. 2 and 3). This is an oblong trough with

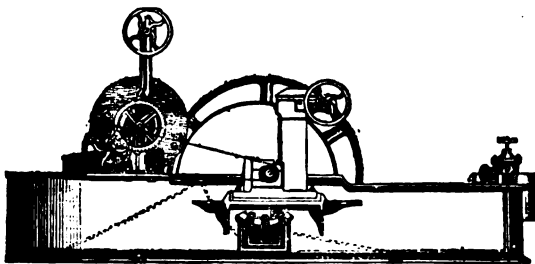

FIG. 2.—Breaking Engine—Vertical Section.

rounded ends, and may be about 6 feet wide and 12 feet long by about 2 feet in depth, but the size varies greatly. It is partially divided in the centre by the midfeather A, and provided with a heavy iron roll B, fitted with knives technically called bars, which revolves at a high speed on the plate C, also furnished with knives. The engine is half filled with water and packed with the boiled rags.

Water is introduced by the valve D, and is withdrawn by the washer E. The washer consists of a drum about 3 feet in diameter and 18 inches broad, covered with fine wire-cloth, and fitted inside with buckets shown by the dotted lines G. It is partially immersed in the pulp, and as it revolves discharges the water by the centre down the

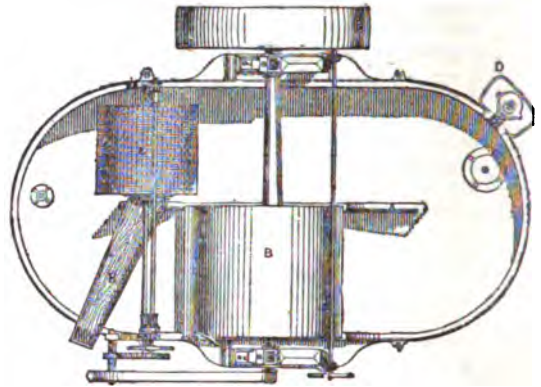

FIG. 3.—Breaking Engine—Horizontal Section.

shoot H. The rags are allowed to remain in this washer, according to their cleanness, from one to two hours, and then the solution of chloride of lime by which they are bleached is introduced. After running mixed with this in the engine from one to two hours, the pulp is run down into large stone chests, where it is allowed to lie for twenty-four hours till it becomes perfectly white; it is then drained and pressed to remove the remaining bleaching solution as far as possible.

The bleached pulp is now removed to the beating engine, which differs but little from the washing engine except that in the roll of the beater there are three bars to the bunch, while in the washer there are only two to the bunch. Here the pulp is furnished in the engine with water as before, and washed till it is free from chloride of lime, or this may be neutralized by the use of a sulphite or hyposulphite of soda. The pulp is then submitted to the action of the beater roll for from four to six hours, the circular knives being allowed to revolve very near the plate, so as to draw out the fibres into a very fine state, while preserving their strength as far as possible. While the operation of "beating" is being proceeded with, the loading material, consisting of china clay or pearl white, is added. This is by no means to be viewed entirely as an adulteration, as it too generally is. No doubt to a certain extent it weakens the paper, but it is not added in hand-made papers, in which great strength is required. In writing papers for ordinary purposes, however, and in printing papers, the addition of mineral matter in moderation is of positive advantage, as it closes up the pores of the fibres and enables the paper to take a much better finish than it would otherwise do.

The next process is the sizing, to which all papers for writing and most of those for printing purposes are subjected. Sizing consists in the deposition on the fibres of a substance which is comparatively waterproof, and for engine sizing a mixture of resin soap treated with alum is employed. The resin soap is formed by dissolving resin in carbonate or caustic soda, allowing the mixture to cool when the soap floats on the surface, and the mother-liquor containing the excess of alkali, is run off. It is of considerable importance to get rid of this mother-liquor before using the soap, as it is of no use, and takes alum to neutralize it. The soap is now dissolved in water, and, in many mills where starch is used for stiffening purposes,

mixed with the starch. This mixture is put into the beating engine in which the pulp is circulating, and when it is thoroughly incorporated with the pulp the solution of alum or sulphate of alumina is added. This forms a finely divided precipitate of resinates of alumina on the fibres. The pulp, after the sizing material is thoroughly incorporated with it, is now ready for colouring. Even to produce a pure white, colour must be added to the pulp. In general, for white papers, either cochineal and ultramarine blue are employed, or magenta and aniline blue. In all cases where permanence of colour is of importance, the former are to be preferred. For blue papers, ultramarine is generally used. Tinted papers are, as a rule, produced by the use of aniline colours. Coloured papers are produced by the use of various pigments.

The operation of beating the pulp is of the greatest importance, and too much care cannot be devoted to it. In America, where the mills are generally driven by water-power, the pulp is kept for a much longer time in the engine than in Great Britain, and this accounts to

a considerable extent for the superiority of the American papers.<sup>1</sup>

After the pulp is prepared in the beating engine it is run into the chests of the paper machine (figs. 4 and 5). These chests A are fitted with agitators, and from them the pulp is pumped into the supply-box B, which communicates with the sand-traps C by means of a regulating cock. Along with the pulp a certain amount of water is allowed to flow into the sand-trap, so as to thin it down sufficiently; in most cases the save-all water (see below) is employed for this purpose. The pulp flows backward and forward here in a shallow stream, so as to deposit any heavy impurities which it may contain. After issuing from the sand-traps it is delivered on to the strainers, which are made in many varieties, the most common being the revolving strainer D, shown on the plan. This is a rectangular trough into which the pulp flows. In the centre of this the strainer, rectangular in form, composed of four sets of brass plates bolted to a frame in which very fine slits are cut, revolves slowly. The size of this is about 7 feet by 2 feet. The pulp is made to flow from the

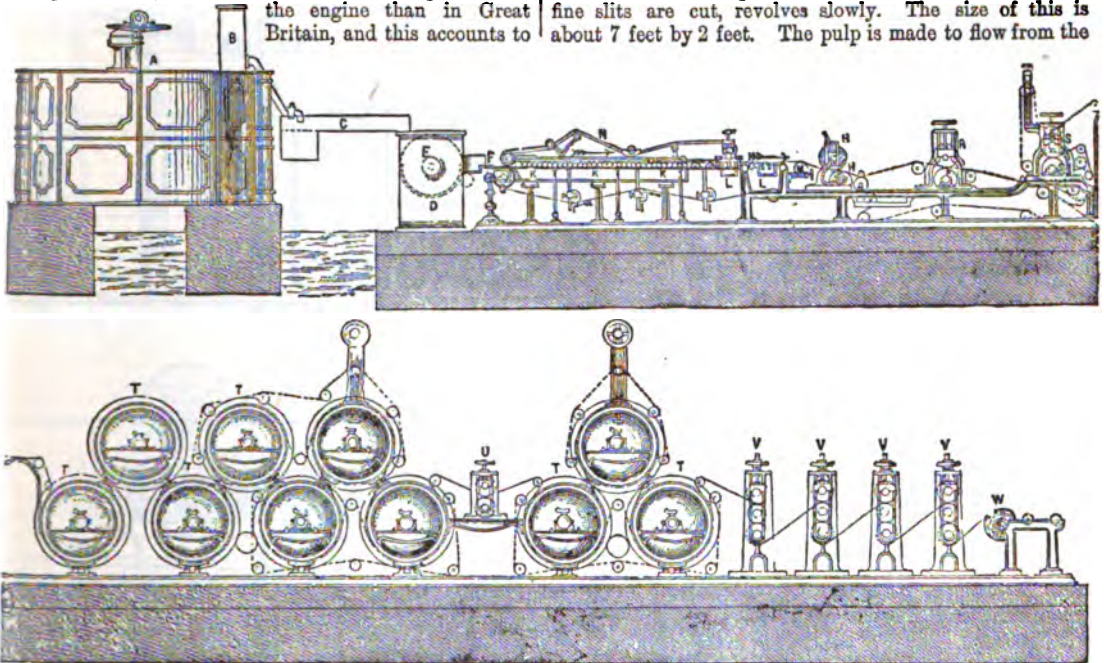

FIG. 4.—Paper Machine—Vertical Section.

outside through the slits to the inside of the strainer by means of suction produced by bellows or diaphragms in the interior of the plates, and is discharged by the pipe E into a box from which it flows on to the apron F, which is placed on the top of the breast roll. The apron is made of a piece of moleskin or india-rubber cloth the full width of the wire, and prevents the pulp from running away down the back of the wire. It covers the wire for 12 to 18 inches at the beginning. The wire consists of an endless sheet of fine wirecloth (about 66 wires per square inch) which stretches from the breast roll G to the couch roll H, returning underneath by the leading rolls I. Underneath the first portion of the wire are the tube rolls K, and farther along are the vacuum boxes L, L. These communicate by pipes with the vacuum pumps M. As the wire revolves in the direction shown in fig. 4 the pulp is allowed to flow from the strainer and spreads itself out in a thin film, covering the surface of the wirecloth. It is prevented from flowing over the sides of the wire by the deckle straps, endless india-rubber straps N. Part of

the water runs off through the meshes of the wire by gravitation, and the rest is removed through the suction boxes L by the vacuum pumps M. Stretching along under the wire from the breast roll to the first suction box is the save-all, a shallow trough into which the water which passes through the wire falls. The contents of this box flow into a cistern at the back of the machine into which the vacuum pumps also discharge their water; and from this cistern the water is pumped into a service box and used instead of fresh water for mixing with the pulp as it flows on to the sand-trap. There is a considerable saving in this, as the fine fibre, size, &c., contained by the water passing through the wire is all in this way

<sup>1</sup> Another form of beating engine which is finding great favour is the Umpherston engine, which differs little from the ordinary beater, except in having, instead of a midfeather, a passage under the roll by which the pulp circulates. It is claimed for it that one capable of preparing 10 cwts. of paper does not occupy more floor area than an ordinary beater for 8 cwts. The pulp is also said to travel more freely, and does not lodge about the corners as in the ordinary engine.



recovered. Between the first and second suction box the dandy roll, a skeleton roll covered with wirecloth, revolves on the top of the pulp. By means of raised wires on it in the form desired the paper is rendered thinner at these parts and a water-mark is produced. In order to secure regularity in the layer of pulp, as also to increase the strength of the paper, a lateral motion is communicated to the wire by the shake O. The half-dried pulp now passes between the couch rolls, where it receives the first pressure. The under couch roll generally consists of a brass shell fixed by iron rings to a spindle; the top roll may be either similar to the lower one or made of mahogany, and is always covered with a felt jacket. Pressure is applied to the ends of the top roll by means of levers and weights. From these the sheet of partially

dried pulp is carried by endless felts through the first and second press rolls R and S. The press rolls are either made of solid iron, or may with advantage have a brass shell shrunk on. Having been freed by these from a great part of its water, the web of paper is carried over the steam-heated cylinders T, T. The first two cylinders are generally bare, and the heat applied to these is gentle; in the case of the others, the paper is kept close to the cylinder by means of endless felts. The web then passes through the intermediate rolls U in a half-dried state, over three more cylinders and the calendars V. These are heavy iron rollers heated by steam internally and polished externally. Their object is to communicate a gloss to the web of paper. It is then wound up on the reel W, and these reels when filled with paper are removed as required

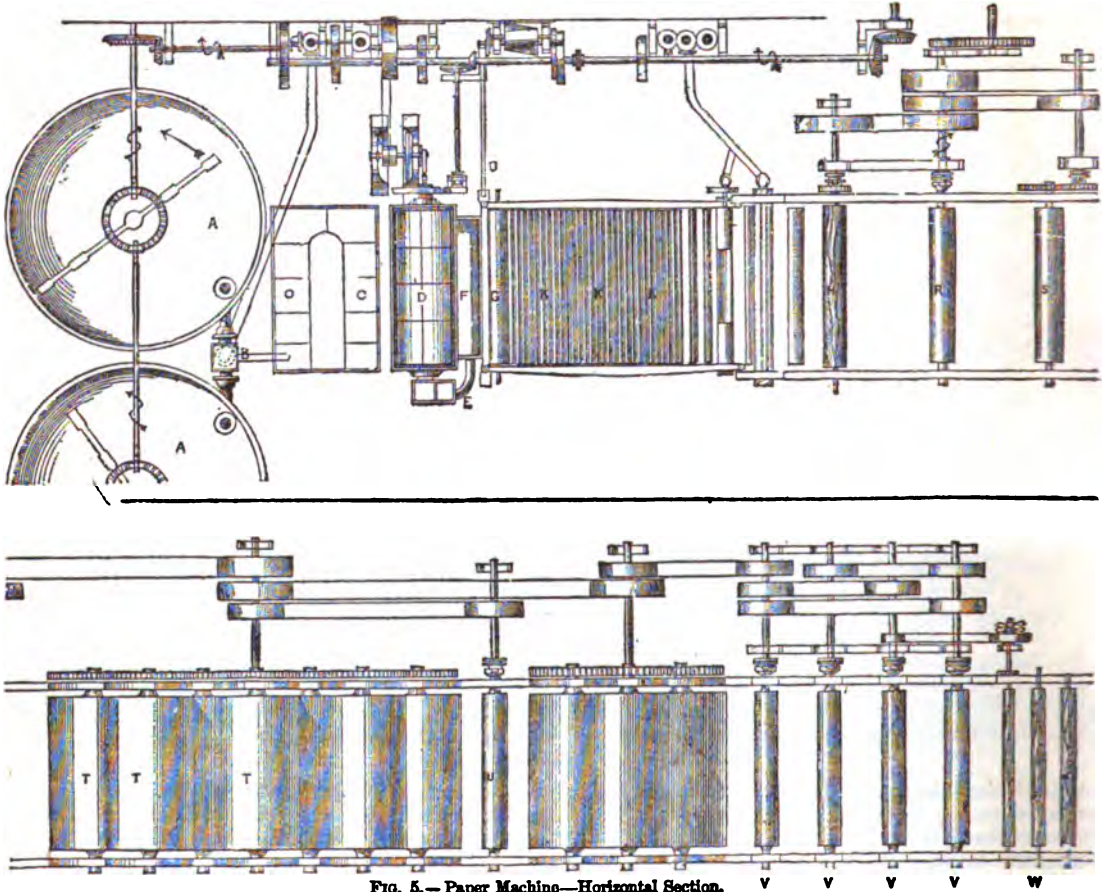

FIG. 5.—Paper Machine—Horizontal Section.

to the paper cutter. In cases where the paper is to be sized with gelatin after leaving the machine, it is wound up rough.

A modification of the Fourdrinier machine, suitable for the manufacture of thin papers and those which only require to be smooth on one side, is shown in fig. 6. It consists of an ordinary paper machine as far as the couch rolls A, A. From these the paper is carried backwards on the top of the endless felt B till it comes in contact with the large steam-heated cylinder C at *d*. Here it adheres to the cylinder, being pressed against it at the same time by the press roll E. The paper then continues round the surface of the cylinder, and is wound up dry on reels at G. The felt washer H is a box filled with water through which the felt passes as it travels. After this the paper is out or glazed in the usual way.

At this stage papers which require to be hard-sized, principally the better sorts of writing papers, are sized with gelatin or "tub-sized." This is done occasionally by passing the sheets separately through a trough containing a strong solution of gelatin, and afterwards hanging them up to dry in the same way as hand-made papers, but in general the paper is sized and dried in the web after leaving the paper machine. For this purpose a sizing and drying machine is used (fig. 7). The web of paper to be sized is shown at A. From this it is passed through a trough B containing a strong solution of gelatin into which a certain amount of alum is introduced; after passing through this by means of the size rolls C, C, it is passed through the press rolls D, which squeeze out the superfluous size from it, and is rewound on a reel at E to allow

the size time to set. The web is then transferred to the drying machine at G, and passed over a series of spar drums H, H at a slow speed. These drums are fitted round their circumference with wooden spars I on which the

paper rests, while a current of heated air from pipes underneath ascends through them and is driven against the inner surface of the paper by the fanners K, K, which revolve at a high speed. The great thing to be studied in this

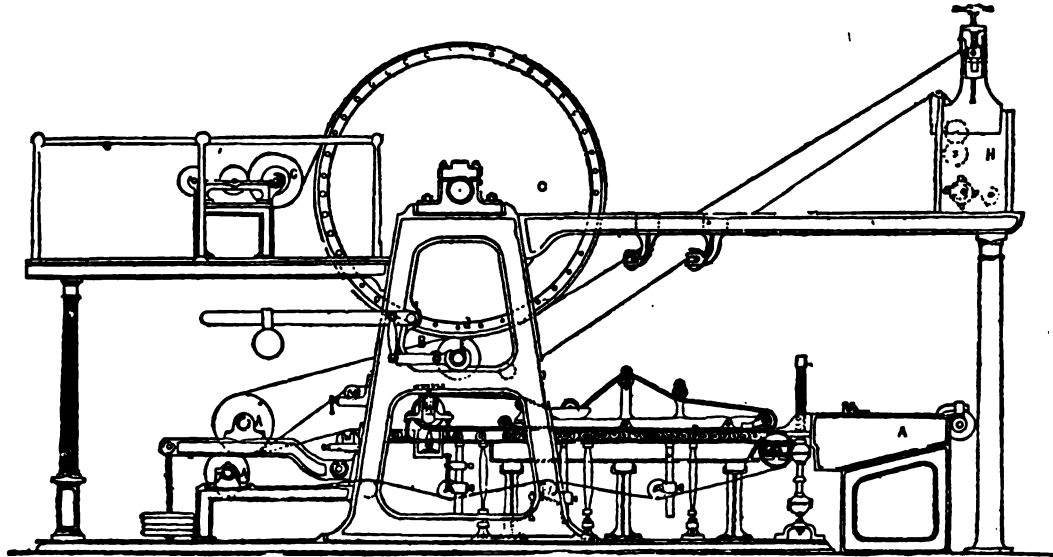

FIG. 6.—Single-Cylinder Machine.

operation is to keep as low a temperature as possible, not above 80° Fahr. There may be any number of these drums; the larger the number the lower the temperature at which the paper can be dried. In some mills as many

as two hundred of them go to a drier. After being wound up at the end of the drier the paper is ready for cutting in the ordinary way.

The ordinary paper cutter (fig. 8) cuts from six to eight

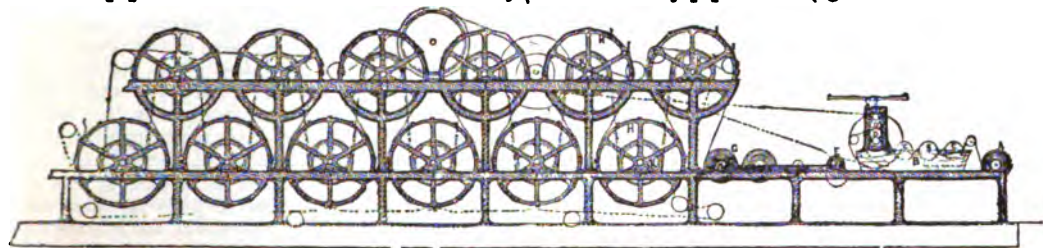

FIG. 7.—Sizing and Drying Machine.

webs at once. The webs to be cut may be seen on the drawing at *a, a*. The webs of paper from these are led between the leading rolls *b, b* through the feeding rolls *c, c*. These, by means of the change pulley *d*, are driven at such a speed that they feed the paper to the revolving knife at the exact speed necessary to give the length of sheet required. After passing the feeding rolls the paper passes on to the slitting knives *e*. These are circular revolving knives which slit the paper into the width required. From these the webs pass through the drawing rolls *f, f* to the revolving knife *g*, which, coming down with a shear against the dead knife *g'*, cuts them crosswise into the required length of sheet. The size of the sheet may be made longer or shorter, by altering the size of the expanding pulley *h* and the change pulley *d*. After being cut, the sheets of paper are caught by the endless felt *i* and carried forward to the table *k*, where they are arranged by boys,

Another form of paper cutter which is employed for water-marked papers (see paper machine) is the single-sheet cutter, fig 9. In this cutter only one web of paper is cut at a time, but it can be adjusted to a much

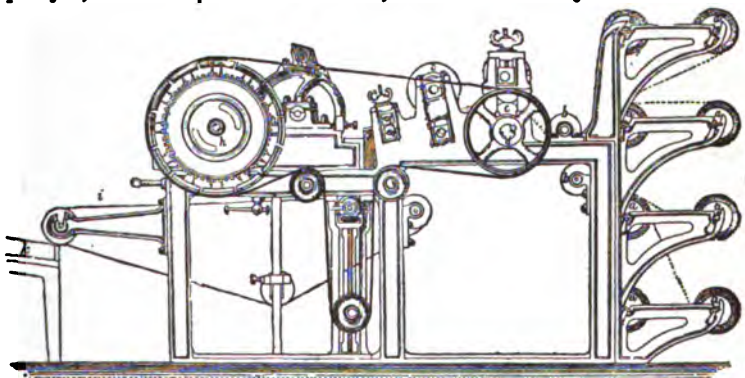

FIG. 8.—Reel Paper Cutter.

greater degree of nicety than the revolving cutter. After passing through the slitting knives *A*, which are in all

respects similar to those in the revolving cutter, the paper is carried over the measuring drum C, which, by a crank arrangement DE receives an oscillating motion and can be adjusted to draw the exact quantity of paper forward for the length of sheet required. The paper is kept fast on the drum by the gripper rolls F, F, arranged so as to rise and fall

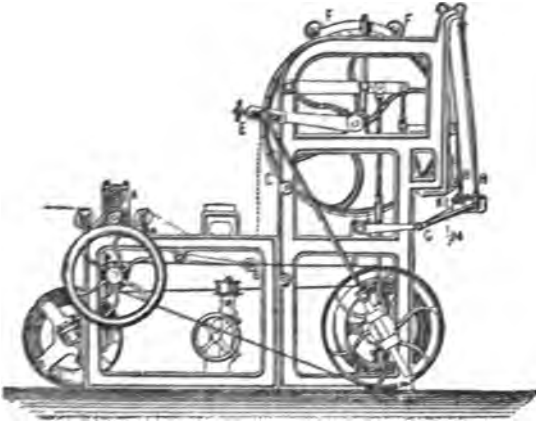

FIG. 9.—Single-Sheet Paper Cutter.

as the drum oscillates, while the dancing roll B keeps the web at a uniform tension. The paper is cut into sheets by the knife I, connected with cranks and links G, and supported by the link rods H, H working horizontally with a swinging motion against the dead knife K. At the same time the clamp L holds the web in position. The sheet to be cut may be seen hanging down at the dotted line M. The sheets are then caught by girls and dressed up in the usual way. This cutter requires a great deal of attention, and is only used when extreme accuracy is required.

**Calenders.**—If it is desired to give the paper a higher gloss than can be done on the calenders of the paper machine, or where, as in the case of papers sized with gelatin, these must be glazed after leaving the paper machine, it is done by the use either of the plate or roll

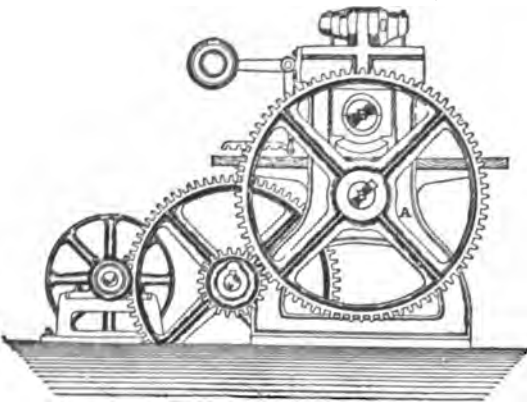

FIG. 10.—Plate Calender.

calender. (1) The plate calender (fig. 10) is composed of a framework A, in which are set two highly polished rolls of solid iron B, B, with a space of about  $\frac{1}{4}$  inch intervening. By means of levers and weights pressure can be applied to the top roll. The paper to be glazed is placed sheet by sheet between copper or zinc plates, till a bundle considerably thicker than the space between the rolls is made. This bundle is then passed backward and forward between the rollers, under considerable pressure, and the polished surface of the plates communicates a gloss to the paper.

(2) In America a calender of different construction is employed (fig. 11). In it a perpendicular series of highly polished iron and compressed cotton or paper rolls are placed alternately between frames, and revolve at a high speed. The sheets of paper are one by one introduced by an attendant who sits in a convenient position near the

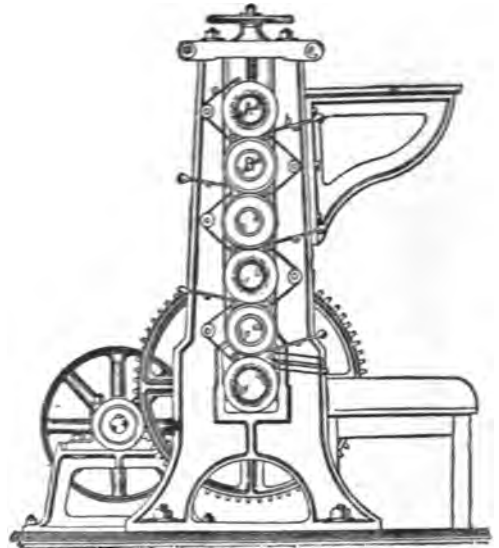

FIG. 11.—Sheet Glazing Calender.

top of the calender, under the tapes  $\alpha$ , which, running against the roll A, convey the sheet to the next roll B. After passing under the roll A, the paper has a tendency to adhere to the metal surface; this is overcome by a sharp-pointed knife  $b$  placed against it, so that the sheet is again caught by the next set of tapes, and so on till it completes its course, and comes out at the foot of the calender. If a still higher glaze is required, the sheets are passed through a second time. A much larger quantity of paper can be glazed in the same time by one of these calenders than by the so-called plate calender, and at a greatly smaller outlay for wages, but the surface acquired by the paper wants the peculiar gloss communicated to it by the latter, and for the higher grades of paper this still retains its position in Great Britain.

After being cut, and, if necessary, calendered, the paper is sorted, that is to say, it is examined sheet by sheet, and all torn or soiled sheets are taken out. It is then divided into quires and reams, each quire containing twenty-four sheets, and each ream twenty quires.

**Hand-Made Paper.**—So far the preparation of pulp, whether for paper making by hand or by machine, is identical, the chief difference being that only the most expensive drawing and writing papers are now manufactured by hand, and for this purpose only the finest qualities of rags are used. The process will be best understood by reference to the drawing (fig. 12). The pulp, after being prepared in the beating engine as above described, is run into large chests from which the vat is supplied. Before reaching this it is strained as on the paper machine. Hand-made paper is made by means of a mould (fig. 13). This consists of a framework of fine wirecloth with a "deckle" or movable frame of wood all round it, to keep the pulp from running off. Nearly all hand-made papers have also a water-mark (W. King in this instance), which is produced by wires representing these letters being raised above the rest of the mould. Hence the paper in these parts is thinner, and the letters can be read on holding the sheet up to the light.



The sheet of paper is formed in the following way. The vatman, fig. 12, takes up enough pulp on the mould to fill the deckle. He runs the stuff evenly over the mould from the fore-side to the back, throwing back any pulp

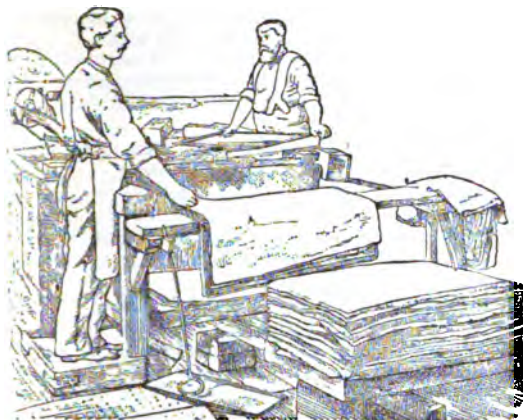

Fig. 12.

which may be superfluous, and then gives the mould the "shake," a gentle shake both along and across the mould, causing the water to run through the wirecloth while the pulp which forms the sheet of paper stays on the top. The vatman then brings the mould to the stay; it is placed by the coucher on an inclined elbow, where some more water drains away, and he afterwards turns it over on the felt, leaving the sheet of paper on the felt. When the

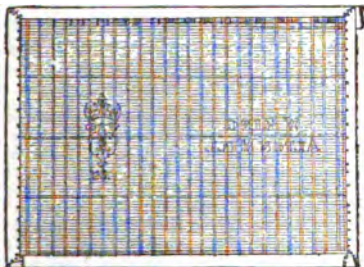

FIG. 13.—Mould.

proper number of sheets of paper, with a felt between each, has been placed in the pile called a "post," it is taken to the press, and a great quantity of the water is pressed out, leaving the sheets of paper sufficiently dry to be handled by the "layer," who places them in packs, one sheet above the other, and after being parted sheet from sheet they are re-pressed. After this the paper is hung in a drying loft on cow-hair ropes in spurs of three to five sheets thick until dry. It is then sized by passing the spurs through a strong solution of gelatin contained in a long trough. The paper passes along on an endless felt, and is freed from superfluous size by press rolls at the end of the trough. It is then parted again to prevent the sheets from sticking together, and is again dried at a temperature of 70° to 80° Fahr. After being picked and then glazed between plates, it is sorted and finished in the same way as other paper, but with much greater care.

It will readily be understood that the expense of manufacturing paper in this way is very much greater than by machinery; but the gain in strength, partly owing to the time allowed to the fibres to knit together, and partly to the free expansion permitted them in drying, still maintains a steady demand for this class of paper, and probably 60 to 70 tons per week are made in Great Britain at present.

In America, papers of great strength are manufactured by machinery, and not much hand-made paper is made.

*Manufacture from other Substances than Rags.*—Although the better varieties of both writing and printing paper are still manufactured from rags, the supply of these has been found altogether insufficient to supply the increasing demand for paper, and other fibres have to a great extent been substituted for the cheaper classes of paper. First among these is ESPARTO (*q.v.*).<sup>1</sup> The treatment of esparto does not greatly vary from that of rags. On arrival at the mill the grass is sorted; that is to say, it is spread out in bunches on a table with a wire gauze cover, and these are shaken to remove the dust, while the roots and weeds are removed by picking. This is technically known as dry picking. In some mills this process is done mechanically by aid of a duster, which removes dust and other heavy impurities from the esparto, but it must then be picked in the wet state after boiling. The boiling is done in the same way as rags, but with a larger proportion of caustic soda. Mr Thomas Routledge, the introducer of esparto, specifies 10 per cent. real caustic soda, but with improved forms of boilers such as Roeckner's or Sinclair's, operating at 40 to 50 lb pressure, a considerable saving on this amount of alkali may be effected. The subsequent treatment of esparto is similar to that for rags; it is again "wet-picked" after boiling, then washed and bleached, a much larger quantity of chloride of lime being required than in the case of rags. It can be treated either alone or mixed with rags, and forms a very mellow bulky paper admirably adapted for printing purposes.

A considerable quantity of straw is used both in Britain and in America for paper-making. In general it is mixed either with rags or with esparto, being of too brittle a nature when bleached to make into paper alone. It is generally dusted after arrival at the mill, in many cases cut into chaff before the boiling operation, so as to allow the soda freer access to the fibres, and boiled under high pressure with considerable quantities of caustic soda up to 15 per cent. of real caustic. It is then washed either separately or along with esparto, and bleached in the ordinary way. As at present treated, the yield averaging only 33 to 40 per cent., straw will not come into general use, except in cases where the raw material can be bought on unusually advantageous terms. There is no doubt that, in this case especially, a more rational method of extracting the cellulose than by boiling under high pressure with a large amount of caustic soda is most desirable, for, many of the fibres of the straw being extremely fine, these are to a considerable extent actually dissolved by the soda, and, whereas theoretically straw with 15 per cent. moisture ought to produce 45 per cent. cellulose, by the soda treatment not more than 33 per cent. are obtained, where a good white colour is desired.

The only other fibre which has seriously threatened to compete with rags or esparto is wood. From the fact that the supply of this raw material is apparently inexhaustible, a great deal of attention has been paid to methods for reducing it to a fibre capable of being made into paper. These divide themselves into two—(1) mechanical and (2) chemical treatment. (1) The wood generally selected for this purpose is white pine or poplar. It is cut into slabs of convenient size, which are then pressed against the face of a mill-stone revolving at a high speed, while a flow of water conveys the fibres of wood away as they are separated. They are then sieved according to fineness, collected, and pressed into pulp or half stuff, which is used for admixture in inferior papers, or even, in some cases, for making paper. By

<sup>1</sup> The imports, which in 1863 amounted to 78,000 tons, had risen to 100,000 tons in 1870, and in 1883 reached 208,000 tons.

this means of treatment, however, the wood is not split up into its ultimate fibres, but is left with all the incrusting matter attached, and the pulp and paper so obtained are only fitted for the commonest purposes. (2) Many efforts have been made with the view of preparing wood chemically, so that the resulting fibre might be introduced into fine papers, and latterly with considerable success. In the earlier processes, patented by Houghton and Sinclair, wood was boiled with about 20 per cent. real caustic soda under a pressure of from 10 to 14 atmospheres. By this means, with certain improvements in detail, dictated by experience, so-called chemical wood pulp is prepared in large quantities on the Continent, and is imported as pulp into England to a considerable extent. In America this process has been extensively adopted. While pulp of very fair quality is prepared in this way suitable for papers where a perfectly white colour is not required, there is no room for doubt that the action of the caustic soda solution at the extreme temperature which a pressure of upwards of 10 atmospheres involves, leads to a certain extent to a degradation and consequent weakening and browning of the fibres, and a great deal of work has been directed to the surmounting of this difficulty. The result has been a series of patents, all containing the same principle, namely, the treating the wood with a chemical agent which should prevent oxidation and subsequent degradation of the fibres from taking place. Such patents are those of Mitscherlich and Francke (bisulphite of lime), Ekman and Graham (bisulphite of magnesia). While these all contain a common principle, they differ in detail, as to pressure, blowing off of the sulphurous acid gas, &c., but they all present a very marked resemblance

to Tilghmann's expired patent, 1866, No. 2924. The pulp produced by all these processes is of excellent quality; and, according to the statements of the patentees, it can be prepared at a cost greatly lower than by the soda process. The strength of the fibre is maintained unimpaired even after bleaching, and white paper made solely from such pulp is in every respect superior to that manufactured solely from pulp prepared by boiling with caustic soda.

Dr. Mitscherlich's process has been extensively adopted in Germany, and there seems little doubt that these processes will in time supplant the use of soda in the case of wood. The great objection to them all is that, as they all depend on the use of bisulphite, which, being an acid salt, cannot be worked in an iron boiler, the boiler must be lined with lead; and great difficulty has been encountered in keeping the lead lining of the boiler in repair. This is a difficulty, however, which will probably be overcome with further experience. The objection to cellulose

prepared from wood by all the acid processes is that it is not pure, but a considerable quantity of incrusting matter is left in the fibre, and hence the paper manufactured from it solely is harsh in character and very transparent; to procure a pure cellulose, it must be exhausted in an alkaline solution subsequent to the treatment with acid.

The waste of *jute* is largely used in the manufacture of coloured papers, but it has not hitherto been found possible to thoroughly bleach this fibre without at the same time destroying its strength.

A long series of experiments, with a view to the introduction of *bamboo* fibre for paper making, has been undertaken by Mr Thomas Routledge, the well-known introducer of esparto, who recommends the employment of the young shoots. It may well be doubted whether the bamboo has any chance as a competitor against the new processes for preparing wood.

A host of other fibres have been tried from time to time, such as dis grass from the north coast of Africa, the leaves of the dwarf palm, sugar-cane refuse, the stalks of the hop plant, nettles, peat, *Phormium tenax* from New Zealand, with many others (see Dr Hugo Müller's *Pflanzensasser*), but none with such success as to call for notice here.

*Soda Recovery.*—In the preparation of esparto, wood, and other raw material for manufacture into

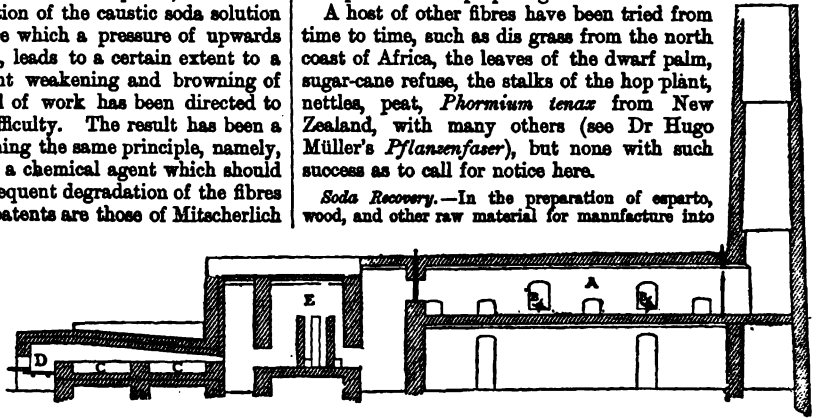

FIG. 14.—Porion Evaporator.

paper, large quantities of caustic soda are employed, and, as the resulting liquid after boiling the fibre in caustic soda solution is strongly alkaline and dark-coloured, it is very desirable to keep it out of the rivers. In order to effect this it is in many mills evaporated, and the soda it contains recovered, and, after causticizing, re-used. Many forms of evaporator have been proposed, and of late years great improvement has been made in their construction. Probably the best form is the Porion evaporator (fig. 14). This consists of an evaporating chamber A, on the floor of which a few inches of the liquid to be evaporated rest. By the action of fanners B, B revolving at a high speed and dipping into the liquid, it is thrown up in a fine spray through which the heated gases pass to the chimney. After being concentrated in the evaporating chamber the liquid flows into the incinerating furnaces C, C, where the remaining water is driven off by the heat of the fire D, and the mass afterwards ignited to drive off the carbonaceous matter. A considerable feature in this evaporator is Menzies and Davis's patent small chamber E, a chamber filled with masonry in which the strongly-smelling gases from the incinerating furnace are allowed to remain at a red heat for a short time. After being recovered, the soda, in the form of crude carbonate, is lixiviated and re-causticized by boiling with milk of lime.

*Sizes of Paper.*—The following are the ordinary sizes:—

Writing Papers.		Book and Drawing Papers.		Printing Papers.		Cartridge Papers.	
Ina.		Ina.		Ina.		Ina.	
Pott.....	12½ × 15	Foolscap.....	14 × 18½	Crown.....	16½ × 21	Foolscap.....	14 × 18½
Double pott.....	15 × 25	Demy.....	15½ × 20	Demy.....	17½ × 22½	Demy.....	17½ × 22½
Foolscap.....	18½ × 16½	Medium.....	17½ × 22½	Medium.....	18½ × 23	Royal.....	19 × 24
Double foolscap.....	16½ × 26½	Royal.....	19 × 24	Royal.....	20 × 25	Super royal.....	19½ × 27½
Foolscap and third.....	18½ × 22	Super royal.....	19½ × 27	Super royal.....	21 × 27	Imperial.....	21 × 26
Foolscap and half.....	18½ × 24½	Imperial.....	23 × 80½	Double pott.....	15 × 25	Elephant.....	23 × 28
Puchod post.....	14½ × 18½	Elephant.....	23 × 28	Double foolscap.....	17 × 27		
Post.....	16½ × 19	Double elephant.....	26½ × 40	Double crown.....	20 × 30		
Double post.....	19 × 80½	Atlas.....	26½ × 34	Double demy.....	22½ × 35½		
Large post.....	16½ × 90½	Columber.....	23½ × 24½				
Double large post.....	20½ × 35	Antiquarian.....	31 × 53				
Copy.....	16½ × 20						
Medium.....	18 × 22½						

British Paper Trade. — The comparative returns of the amounts and values of the imports and exports published by the Board of Trade (Great Britain) for the years 1882 and 1883 are as follows:—

Articles.	Imports.				Exports.			
	Weight.		Value.		Weight.		Value.	
	1882.	1883.	1882.	1883.	1882.	1883.	1882.	1883.
Writing and printing papers .....	Cwts. 190,089	Cwts. 209,455	£ 835,631	£ 844,186	Cwts. 413,645	Cwts. 445,859	£ 1,003,247	£ 1,028,617
Miscellaneous papers .....	911,458	952,723	872,590	902,514	171,302	152,930	301,778	258,017
Total of paper.....	1,101,547	1,162,178	1,208,211	1,246,700	584,947	598,789	1,305,025	1,284,630
Esports.....	Tons. 181,056	Tons. 206,558	1,282,014	1,883,021	Tons. ...	Tons. ...	...	...
Rags.....	20,977	29,647	301,083	401,615	49,352	51,019	526,554	501,035
Woolen rags.....	84,981,120	80,626,560	821,692	756,616	...	...	...	...
Printed books .....	...	...	...	...	Cwts. 121,607	Cwts. 123,038	1,169,592	1,175,642

American Paper Trade.—At the end of 1882 there were in the United States 1051 paper mills (1004 the previous year). Of this number 1018 are in active operation. These mills are owned and worked by 823 firms or establishments, an increase of 23 over the previous year. Twenty-three mills were abandoned during 1882, while 17 were destroyed by fire; 36 were in course of construction, and 68 new mills went into full work during 1882. This number is composed of a few mills reconstructed after fire, and 39 new establishments erected during 1882. The mills represent almost every variety of paper and pulp, and have an estimated daily capacity of 300 tons. Altogether there were in 1883 44 more mills in operation than in 1882. At the beginning of 1884 36 new mills

were being constructed and may be expected to be at work during the year. Every variety of paper is extensively manufactured in the United States with the exception of hand-made, but of late years attention has been devoted to this also, English plant and labour having been imported for the purpose, and hand-made papers are now regularly produced in small quantities.

Bibliography.—Herring, *Paper and Papermaking*; Piets, *Manuel de la Papeterie*, 1861; Drosch, *Die Papiermaschinen*, 1878; G. Planche, *L'Industrie de la Papeterie*, 1833; L. Müller, *Fabrication des Papiers*, 1855; Proteaux, *On the Manufacture of Paper and Boards*, 1864; Hugo Müller, *Pflanzensasser*, 1877; C. Hofmann, *Manufacture of Paper*, 1873; T. Routledge, *Bamboo considered as a Papermaking Material*, 1874; *Papermakers' Monthly Journal*, London; *Paper Trade Journal*, New York; *Papier-Ledung*, Berlin. (R. C. M.)

PAPER HANGINGS. See MURAL DECORATION, vol. xvii. p. 38.

PAPHLAGONIA, in ancient geography, was the name given to a province of Asia Minor, situated on the Euxine Sea, and adjoining Bithynia on the west and Pontus on the east, while towards the south it was separated from Galatia by a range of mountains which may be considered as a prolongation to the east of the Bithynian Olympus. According to Strabo, whose authority is generally followed upon this point, the river Parthenius formed the western limit of the region so-called, and it was bounded on the east by the much more important river Halys. Although the Paphlagonians play scarcely any part in history, they were one of the most ancient nations of Asia Minor, as their name appears in the Homeric catalogue of the allies of Priam during the Trojan War (*Il.*, ii. 851). They are afterwards mentioned by Herodotus among the races reduced to subjection by Croesus, and they sent an important contingent to the army of Xerxes in 480 B.C. They seem, however, to have enjoyed a state of at least semi-independence, as Xenophon speaks of them as being governed by a prince of their own, without any reference to the satraps of the neighbouring parts of Asia. The rugged and difficult nature of their country, which is described by Xenophon as containing fertile and beautiful plains, but traversed by lofty ranges of mountains, which could only be crossed by narrow and difficult passes, doubtless contributed to this result. At a later period Paphlagonia passed under the yoke of the Macedonian kings, and we find it after the death of Alexander the Great assigned, together with Cappadocia, to Eumenes. It continued, however, to be governed by native princes until it was absorbed by the encroaching power of the neighbouring kingdom of Pontus. The rulers of that dynasty became masters of the greater part of Paphlagonia as early as the reign of Mithradates III. (302-266 B.C.), but it was not till that of Pharnaces I. that the important city of Sinope fell into their hands (183 B.C.). From this time the whole province was incorporated with the kingdom of Pontus until the fall of the great Mithradates (65 B.C.). In the settlement of Asia

which followed that event, Pompey united the coast districts of Paphlagonia with the province of Bithynia, but left the interior of the country under one of the native princes, two or three of whom followed in succession until the dynasty became extinct and the whole country was incorporated in the Roman empire. All these petty native rulers appear to have borne the name or surname of Pylæmenes, as a token that they claimed descent from the chieftain of that name who figures in the *Iliad* as the leader of the Paphlagonians. Under the Roman empire Paphlagonia, with the greater part of Pontus, was united into one province with Bithynia, as we find to have been the case in the time of the younger Pliny; but the name was still retained by geographers, though its boundaries are not distinctly defined by Ptolemy. It reappears as a separate province in the 5th century (Hierocles, *Syneccl.*, c. 33).

The ethnic relations of the Paphlagonians are very uncertain. It seems perhaps most probable that they belonged to the same race with the Cappadocians, who held the adjoining province of Pontus, and who were undoubtedly a Semitic race. Their language, however, would appear from the testimony of Strabo to have been distinct from that of their neighbours. Equally obscure is the relation between the Paphlagonians and the Eneti, or Heneti, who are mentioned in connexion with them in the Homeric catalogue, and who were supposed in the mythical fictions of antiquity to be the ancestors of the Veneti, who dwelt at the head of the Adriatic. But no trace is found in historical times of any tribe of that name in Asia Minor.

The greater part of Paphlagonia is a rugged and mountainous country, but it contains fertile valleys, and produces great abundance of fruit. The mountains also are clothed with dense forests, which are conspicuous for the quantity of boxwood which they furnish. Hence its coasts were from an early period occupied by Greek colonies, among which the flourishing city of Sinope, a colony from Miletus, founded about 630 B.C., stood pre-eminent. Amastria, a few miles east of the Parthenius,

became an important town under the Macedonian monarchs; while Amisus, a colony of Sinope, which was situated a short distance east of the Halys, and therefore did not fall strictly within the limits of Paphlagonia as defined by Strabo, though often considered as belonging to that province, rose to be almost a rival of its parent city. The other towns along the coast of the Euxine were of little consequence, and none of those in the interior ever rose to any importance. The most considerable were Gangra, in ancient times the capital of the Paphlagonian kings, afterwards called Germanicopolis, and situated near the frontier of Galatia, and Pompeiopolis, in the valley of the Amnias (a tributary of the Halys), near which were extensive mines of the mineral called by Strabo sandarake (red arsenic), which was largely exported from Sinope. (E. H. B.)

PAPHOS, the name of two cities near the west coast of Cyprus. Old Paphos was on the river Bocarus, about 10 stadia from the coast, near the promontory Zephyrium; it had a harbour at the mouth of the river. The city was distinguished by a temple of Aphrodite, to which an oracle was attached; the priest exercised a sort of hieratic supremacy over the whole island. Paphos was the favourite city of Aphrodite, who is often styled the Paphian goddess. The grave of Aphrodite was shown in the city, and her image in the temple was a conical stone. There is no doubt that both the city and the cultus were of Phœnician origin. Apollodorus says that the Syrian king Cinyras was the founder. The place was subject to earthquakes; it was totally destroyed by a shock in the time of Augustus, and, being restored by that emperor, took the name Augusta or *Ἐβαστή*, which, however, did not displace the old name. New Paphos was situated in a fertile plain, about 10 miles inland from Old Paphos. There was a great festal procession from it every year to the temple of Aphrodite in the old city. It was a flourishing commercial place in the time of Strabo.

PAPIAS, bishop of the Phrygian Hierapolis in the first half of the 2d century, is mentioned by Irenæus as "an ancient man," "the hearer of John and the companion of Polycarp." According to the *Chronicon Pascale*, Papias suffered martyrdom at Pergamum in the year of that of Polycarp at Smyrna (163 A.D., or, according to other reckonings, 156). His name figures largely in Biblical criticism in connexion with his work entitled *λογίων κυριακῶν ἐξηγήσεις*, of which only a few small fragments have been preserved in the form of citations in the writings of Irenæus, Eusebius, and later authors. See GOSPELS, vol. x. p. 815 sq.

The fragments are collected in Routh's *Reliq. Sacr.* (vol. 1., 1846), and in Gebhard and Harnack's *Patr. Apost. Opera*.

PAPIER MÂCHÉ (mashed or pulped paper) is a term embracing numerous manufactures in which paper pulp is employed, pressed and moulded into various forms other than uniform sheets, such as ordinary paper and millboards. In the East the art has long been practised, especially in Kashmir, where, under the name of *kar-t-kalamdani*, or pen-tray work, the manufacture of small painted boxes, trays, and cases of papier mâché is a characteristic industry. About the middle of the 18th century papier mâché work came into prominence in Europe in the form of trays, boxes, and other small domestic articles, japanned and ornamented in imitation of Oriental manufactures of the same class; and contemporaneously papier mâché snuff boxes ornamented in vernis Martin came into favour. In 1772 Henry Clay of Birmingham secured a patent for a method of preparing this material, which he used for coach-building, for door and other panels, and for many furniture and structural purposes. In 1845 the application of the material to internal architectural decoration was patented by C. F. Bielefeld

of London, and for this purpose it has come into extensive use. Under the name of carton pierre, a substance which is essentially papier mâché is also largely employed as a substitute for plaster in the moulded ornaments of roofs and walls, and the ordinary roofing felts, too, are very closely allied in their composition to papier mâché. Under the name of ceramic papier mâché, architectural enrichments are also made of a composition patented by Mr Martin, the constituents of which are paper pulp, resin, glue, a drying oil, and acetate of lead. Among the other articles for which the substance is used may be enumerated masks, dolls' heads and other toys, anatomical and botanical models, artists' lay figures, milliners' and clothiers' blocks, mirror and picture frames, tubes, &c.

The materials for the commoner classes of work are old waste and scrap paper, repulped, and mixed with a strong size of glue and paste. To this very often are added large quantities of ground chalk, clay, and fine sand, so that the preparation is little more than a plaster held together by the fibrous pulp. For the finest class of work Clay's original method is retained. It consists of soaking several sheets of a specially made paper in a strong size of paste and glue, pasting these together, and pressing them in the mould of the article to be made. The moulded mass is dried in a stove, and, if necessary, further similar layers of paper are added, till the required thickness is attained. The dried object is hardened by dipping in oil, after which it is variously trimmed and prepared for japanning and ornamentation. For very delicate relief ornaments, a pulp of scrap paper is prepared, which after drying is ground to powder mixed with paste and a proportion of potash, all of which are thoroughly incorporated into a fine smooth stiff paste. The numerous processes by which surface decoration is applied to papier mâché differ in no way from the application of like ornamentation to other surfaces. Papier mâché for its weight is an exceedingly tough, strong, durable substance, possessed of some elasticity, little subject to warp or fracture, and unaffected by damp.

PAPIN, DENIS (1647-c.1712), French physicist, and one of the inventors of the steam-engine, was a native of Blois, where he was born in 1647. In 1661 or 1662 he entered upon the study of medicine at the university of Angers, where he graduated in 1669, with the intention apparently of settling as a practising physician in that city. Some time prior to 1674 he removed to Paris and assisted Huygens in his experiments with the air-pump, the results of which (*Expériences du Vide*) were published at Paris in that year, and also in the form of five papers by Huygens and Papin jointly, in the *Philosophical Transactions* for 1675. Shortly after the publication of the *Expériences*, Papin, who had crossed to London hoping to find some congenial employment, was hospitably received by Boyle, and gave him some assistance in his laboratory and with his writings; about this time, also he introduced into the air-pump the improvement of making it with double barrels, and replacing by the two valves the turn-cock hitherto used. He is said, moreover, to have been the first to use the plate and receiver, which are organs of capital importance in the modern form of the instrument. Subsequently he invented the condensing-pump, and in 1680 he was admitted, on Boyle's nomination, to the Royal Society. In the following year he communicated to the Society an account of his famous steam "digester, or engine for softening bones," afterwards described in a tract published at Paris, and entitled *La manière d'amollir les os et de faire cuire toutes sortes de viandes en fort peu de tems et à peu de frais, avec une description de la marmite, ses propriétés et ses usages*. In this instrument the principle of the safety-valve was applied for the first time. After some further experiments with the digester he accepted an invitation to Venice to take part in the work of the recently founded Academy of the Philosophical and Mathematical Sciences; here he remained until 1684, when he returned to London and received from the Royal Society an appointment as "temporary curator of experiments," with a small salary. In this capacity he carried

on numerous and varied investigations, in the course of which he discovered a siphon acting in the same manner as the "Siphon Wirtembergicus" (*Phil. Tr.*, 1685), and also constructed a model of an engine for raising water from a river by means of pumps worked by a water-wheel driven by the current. In November 1687 he was appointed to the chair of mathematics in the university of Marburg, and here he remained until 1696, when he removed to Cassel. From the time of his settlement in Germany he carried on an active correspondence with Huygens and Leibnitz, which is still preserved, and in one of his letters to Leibnitz, in 1698, he mentions that he is engaged on a machine for raising water to a great height by the force of fire; in a later communication he speaks also of a little carriage he had constructed to be propelled by this force. Again in 1702 he wrote about a steam "ballista," which he anticipated would "promptly compel France to make an enduring peace." In 1705 Leibnitz sent Papin a sketch of Savery's engine for raising water, and this stimulated him to further exertions, which resulted two years afterwards in the publication of the *Ars nova ad aquam ignis adminiculo efficacissime elevandam* (Cassel, 1707), in which his high-pressure boiler and its applications are described (see STEAM-ENGINE). In 1707 he resolved to quit Cassel for London, and on September 24th of that year he sailed with his family from Cassel in an ingeniously constructed boat, propelled by paddle-wheels, to be worked by the crew, with which he apparently expected to reach the mouth of the Weeser. The expedition, however, came to an ignominious end at Münden, where the vessel was confiscated at the instance of the boatmen, who objected to the invasion of their exclusive privileges in the Weser navigation. Papin, on his subsequent arrival in London, found himself without resources and almost without friends; various applications through Sloane to the Royal Society for grants of money were made in vain, and he died in total obscurity, probably about the beginning of 1712.

The published writings of Papin, besides those already referred to, consist for the most part of a large number of papers, principally on hydraulics and pneumatics, contributed to the *Journal des Savans*, the *Nouvelles de la République des Lettres*, the *Philosophical Transactions*, and the *Acta Eruditorum*; many of them were collected by himself into a *Fasciculus dissertationum* (Marburg, 1695), of which he published also a translation into French (*Recueil de diverses pièces touchant quelques nouvelles machines* (Cassel, 1695). His correspondence with Leibnitz and Huygens, along with a biography, has been published by Dr Ernst Gerland (*Leibnizens und Huygens' Briefwechsel mit Papin, nebst der Biographie Papins*, Berlin, 1881).

PAPINIAN, the most celebrated of Roman jurists, was *magister libellorum* and afterwards praetorian prefect under Septimius Severus. He was an intimate friend of the emperor, whom he accompanied to Britain, and before his death Severus specially commended his two sons to his charge. Papinian was faithful to his trust, and tried to keep peace between the brothers, but with no better result than to excite the hatred of Caracalla, to which he fell a victim in the general slaughter of Geta's friends which followed the fratricide of 212 A.D. The details are variously related, and have undergone legendary embellishment, but it is certain that the murder of Papinian, which took place under Caracalla's own eyes, was one of the most disgraceful crimes of that hideous tyrant. Little more is known about Papinian. He was perhaps a Syrian by birth, for he is said to have been a kinsman of Severus's second wife, Julia Domna; that he studied law along with Severus under Scævola is asserted in an interpolated passage in Spartian (*Caracal.*, c. 8). Papinian's place and work as a jurist will fall to be discussed under ROMAN LAW (q.v.).

PAPPENHEIM, GOTTFRIED HEINRICH, GRAF ZU

(1594-1632), imperialist general in the Thirty Years' War, was born on the 29th May 1594. He attended the high schools of Altdorf and Tübingen, but did not seem to profit much by the instruction he received at either institution. In his twentieth year he joined the Roman Catholic Church; and zeal for his new faith induced him to enter the military service of King Sigismund in Poland and afterwards that of Maximilian, duke of Bavaria, head of the Catholic League. In 1620, as a colonel in the army of the League, he distinguished himself in the battle near Prague which decided the fate of Frederick, king of Bohemia. In this battle, after fighting with extraordinary energy, he was severely wounded, and for many hours lay unnoticed under his horse. He received, in 1623, the command of a regiment of cuirassiers who became famous as the Pappenheimer, and with them he fought from 1623 to 1625 at the head of the Spaniards in Lombardy. In 1626, having been recalled to Germany by Duke Maximilian, he crushed an insurrection of peasants in Upper Austria, obtaining in the course of a month a series of victories in which 40,000 peasants are said to have been killed. He then went to the help of Tilly against Christian IV. of Denmark, and took a prominent part in the storming of Magdeburg, the inhabitants of which were treated by him and by his soldiers with savage cruelty. After the battle of Breitenfeld, which was fought at an unsuitable time, contrary to the wish of Tilly, in consequence of Pappenheim's impetuosity, he covered the retreat of the imperialists; and in Westphalia and the country of the lower Rhine he stimulated the enthusiasm of his party by several successful engagements. When Tilly died, Pappenheim aided Wallenstein in subduing Saxony. On his way to the lower Rhine, where he proposed to support the Spaniards, he was summoned by Wallenstein to Lützen, where battle was about to be given to Gustavus Adolphus; and at the moment of his arrival fortune seemed already to have declared for the Swedes. Pappenheim threw himself into the conflict, and his attack was so furious that the enemy began to give way; but two musket balls penetrated his breast, and he had to be carried from the field. He died on the 17th November 1632, the day after the battle. He left behind him the reputation of one of the bravest warriors and most ardent Catholics of his day. Notwithstanding the sternness of his discipline, he was idolized by his troops.

See Hess, *Gottfried Heinrich, Graf zu Pappenheim*, 1855.

PAPPUS, OF ALEXANDRIA, a geometer of a very high order, belongs to a time when already the Greek mathematicians of great original genius had been succeeded and replaced by a race of learned compilers and commentators, who confined their investigations within the limits previously attained, without adding anything to the development of mathematics. To the general mediocrity Pappus must be considered to be a remarkable exception; for, although much even of his work is of the nature of compilation (which is, however, itself of great historical value), there is yet much the discovery of which cannot well be attributed to any one else. According to Proclus, he was at the head of a school; but how far he was above his contemporaries, how little appreciated or understood by them, is shown by the absence of references to him in other Greek writers, and by the fact that his work had no effect in arresting the decay of mathematical science. In this respect the fate of Pappus strikingly resembles that of Diophantus, another living power amid general stagnation. In reading the *Collection* of Pappus, we meet with no indication of the date of the authors whose treatises he makes use of, or of the time at which he himself wrote. If we had no other information than can be derived from a perusal of his work, we should



only know that he was later than Claudius Ptolemy, whom he quotes often and with respect. Suidas states that he was of the same age as Theon of Alexandria, who wrote commentaries on Ptolemy's great work, the *Almagest*, and flourished in the reign of Theodosius I. (379–395 A.D.). Suidas asserts also that Pappus wrote a commentary upon the same work of Ptolemy. But it would seem incredible that two contemporaries should have at the same time and in the same style composed commentaries upon one and the same work, and yet neither should have been mentioned by the other, whether as friend or opponent. We have apparently no reason to question the statement of Suidas that Pappus wrote such a commentary. But the similarity of two such commentaries as those of Pappus and Theon may easily have led Suidas to confuse the two, and so suppose the two authors to have been contemporary. There is, then, reason to believe that Suidas may have been mistaken; we have, however, another authority, whose statement, on the supposition that it is false, is completely incomprehensible. This is the author of certain historical glosses, which are found in the margin of a MS. belonging to the beginning of the 10th century. Here it is stated, in connexion with the reign of Diocletian (284–305 A.D.), that Pappus wrote during that period. Except the two distinctly contradictory statements of Suidas and the scholiast, we have no evidence of the date of Pappus; and it seems accordingly best to accept the date indicated by the scholiast.

The work of Pappus which has come down to us bore the title *συναγωγή* or *Collection*, as we gather from references in the work itself, and from the scholia appended to the Vatican MS. 218 of the 12th century. This collection, which consisted of eight books, we possess only in an incomplete form, there being no part remaining of the first book, and the rest also having suffered considerably. It is curious that no ancient writer, with the exception of the author of the appendix to book iii., quotes the work under its proper title, though Eutocius's reference (Archimedes, p. 139 sq., ed. Toralli), *ὁ Πάππος ἐν μηχανικαῖς εἰσαγωγαῖς*, is no doubt to book viii. of the *Collection*.

Suidas enumerates other works of Pappus as follows:—*χωρογραφία οἰκουμένης, εἰς τὰ τέσσαρα βιβλία τῆς Πτολεμαίου μεγάλης συντάξεως ὑπόμνημα, ποταμοὶ τοῦ ἐν Λιβύῃ, ὄνειροκριτικά*. The question of Pappus's commentary on Ptolemy's work is discussed by Hultsch, *Pappi Collectio* (Berlin, 1878), vol. iii. p. xiii. sq. Pappus himself refers to another commentary of his own on the *ἀνάλημμα* of Diodorus, of whom nothing is known. There are, moreover, indications that he commented on Euclid's *Elements*, and on Ptolemy's *ἀρμονικά*. Further, there is a doubtful work entitled *Opusculum de multiplicationibus et divisione sexagesimalibus Diophanto vel Pappo tribuendum*, which has been edited by C. Henry (Halle, 1879); and, lastly, a tract, *Anonymi commentarius de figuris planis iso-perimetris*, has been inserted by Hultsch in vol. iii. of his edition of Pappus.

The characteristics of Pappus's *Collection* are that it contains an account, systematically arranged, of the most important results obtained by his predecessors, and, secondly, notes explanatory of, or extending, previous discoveries. These discoveries form, in fact, a text upon which Pappus enlarges discursively, many of his additions having no very decided points of connexion with the direct subject under discussion. Very valuable are the systematic introductions to the various books which set forth clearly in outline the contents and the general scope of the subjects to be treated. From these introductions we are able to judge of the style of Pappus's writing, which is excellent and even elegant the moment he is free from the shackles of

mathematical formulæ and expressions. At the same time, his characteristic exactness makes his collection a most admirable substitute for the texts of the many valuable treatises of earlier mathematicians of which time has deprived us.

We proceed to summarize briefly the contents of that portion of the *Collection* which has survived, mentioning separately certain propositions which seem, in the light of modern developments of mathematics, to be among the most important.

Of book i. the whole has been lost. We can only conjecture that it, as well as book ii., was concerned with arithmetic, book iii. being clearly introduced as beginning a new subject.

The whole of book ii. (the former part of which is lost, the existing fragment beginning in the middle of the 14th proposition) related to a system of multiplication due to Apollonius of Perga. On this subject see Nesselmann, *Algebra der Griechen*, Berlin, 1842, pp. 125–134; and Friedlein, *Die Zahlrechen und das elementare Rechnen der Griechen und Römer*, Erlangen, 1869.

Book iii. contains geometrical problems, plane and solid. It may be divided into five sections. (1) On the famous problem of finding two mean proportionals between two given lines, which arose from that of doubling the cube, reduced by Hippocrates to the former. Pappus gives the solutions of this problem by Eratosthenes, Nicomedes, and Heron, and finally his own solution of the more general problem of finding geometrically the side of a cube whose content is in any given ratio to that of a given one. (2) On the three different means between two straight lines, the arithmetic, the geometric, and the harmonic, and the problem of representing all three in one and the same geometrical figure. This serves as an introduction to a general theory of means, of which Pappus distinguishes ten kinds, and gives a table representing examples of each in whole numbers. (3) On a curious problem of the same type as Eucl. i. 21. (4) On the inscribing of each of the five regular polyhedra in a sphere. (5) An addition by a later writer on another solution of the first problem of the book.

Of book iv. the title and preface have been lost, so that the programme has to be gathered from the book itself. At the beginning are various theorems on the circle, leading up to the problem of the construction of a circle which shall circumscribe three given circles touching each other two and two. This and several other problems of contact form the first division of the book. Pappus turns then to a consideration of certain properties of Archimedes's spiral, the conchoid of Nicomedes (already mentioned in book i. as supplying a method of doubling the cube), and the curve discovered most probably by Hippasus of Elis about 420 B.C., and known by the name of *σφαιροψήφουσα*, or quadratrix, from the property that, if it could be practically constructed, it would enable us to square the circle. Having described the ordinary—the mechanical, as Pappus calls it—definition of this curve, he proceeds to show how it might be constructed by projecting orthogonally suitable plane sections of certain surfaces which he calls *plectoids* described by means of (a) the helix described on a cylinder, (b) the plane helix, or Archimedes's spiral. From these propositions it would seem that *plectoid* was the Greek general term for surfaces described by the motion of a straight line always passing through a fixed straight line and a curve, and remaining parallel to a fixed plane. Proposition 30 describes the construction of a curve of double curvature called by Pappus the helix on a sphere; it is described by a point moving uniformly along the arc of a great circle, which itself turns about its diameter uniformly, the point describing a quadrant and the great circle a complete revolution in the same time. The area of the surface included between this curve and its base is found—the first instance of quadrature of a curved surface. The rest of the book treats of the trisection of an angle, and the solution of certain problems by means of the quadratrix and spiral.

In book v., after an interesting preface concerning regular polygons, and containing some remarks upon the hexagonal form of the cells of honeycombs, Pappus addresses himself to the comparison of the areas of different plane figures which have all the same perimeter (following Zenodorus's treatise on this subject), and of the volumes of different solid figures which have all the same superficial area, and, lastly, a comparison of the five regular solids of Plato.

According to the preface, book vi. is intended to resolve difficulties occurring in the so-called *μυθῶδες ἀστρονομία*. It accordingly comments on the *Spherics* of Theodosius, a treatise of Autolycus, Theodosius's book on *Day and Night*, the treatise of Aristarchus *On the Size and Distance of the Sun and Moon*, and Euclid's *Optics and Phenomena*.

The preface of book vii. explains the terms analysis and synthesis, and the distinction between theorem and problem. Pappus then enumerates works of Euclid, Apollonius, Aristæus,



and Entosthenes, thirty-three books in all, the substance of which he intends to give, with the lemmas necessary for their elucidation. With the mention of the *Porisms* of Euclid we have an account of the relation of porism to theorem and problem. In the same preface we have enunciated (a) the famous problem known by Pappus's name—*Having given a number of straight lines, to find the geometric locus of a point such that the lengths of the perpendiculars upon, or (more generally) the lines drawn from it obliquely at given inclinations, to the given lines satisfy the condition that the product of certain of them may bear a constant ratio to the product of the remaining ones*; (b) the theorems which since the 17th century have been called by the name of Guldin, but appear to have been discovered by Pappus himself. Book vii. contains also (1) under the head of the *de determinata sectione* of Apollonius, lemmas which, closely examined, are seen to be cases of the involuption of six points; (2) important lemmas on the *Porisms* of Euclid (see *Porisms*); (3) a lemma upon the *Conicæ* of Apollonius, which is the first statement of the constant relation between the distances of any point on a conic from the focus and directrix.

Lastly, book viii. treats principally of mechanics, the properties of the centre of gravity, and some mechanical powers. Interspersed are some questions of pure geometry. Proposition 14 gives a simple construction for the axes of an ellipse, when a pair of conjugate diameters are given.

Of the whole work of Pappus the best edition is that of Hultsch, bearing the title *Pappi Alexandrini Collectionis quas supersunt in libris manuscriptorum editio Latina interpretatione et commentariis illustravit Fridricus Hultsch*, Berlin, 1877-8. Previously the entire collection had been published only in a Latin translation, *Pappi Alexandrini mathematica collectiones a Federico Commandino Urbinate in latinam conversæ et commentariis illustratae*, Pesaro, 1588 (reprinted at Venice, 1829, and Pesaro, 1873). A second edition of this work was published by Carolus Mencloni, entitled *Pappi Alexandrini mathematica collectiones a Federico Commandino Urbinate in latinam conversæ et commentariis illustratae, in hac nostra editione innumeris quibus sanctant mendis et præcipue in Græco contextu diligitur vindicatae*, Bologna, 1690. The merits of these two works are discussed by Hultsch, who remarks that the editor of the second edition, so far from making good the title and his boastful preface, has actually much marred the original book.

Of books which contain parts of Pappus's work, or treat incidentally of it, we may mention the following:—(1) *Pappi Alexandrini collectiones mathematicæ sive primæ Græcæ editio*, Harv. soc. Elmsamam, Libri quinti pars altera, Parisiæ, 1824. (2) *Pappi Alexandrini Senacii Libri Mathematicæ Collectionis Fragmentum a codice M.B. editio*, Latine sive Notique Illustravit Johannes Wallis, Oxoniæ, 1688. (3) *Apollonii Pergæi de sectione rationis libri duo ex Arabico M. Ste. latine versis, Accedunt etiam de sectione spatii libri duo restituti, Præmissæque Pappi Alexandrini præfatio ad VII. mæ collectionis mathematicæ, sive primæ Græcæ editio cum immutatis titulis Pappi ad hos Apollonii libros*, Opera et studio Edmundi Halletti, Oxoniæ, 1706. (4) *Apollonii Pergæi cænicorum libri IV. primæ cum Pappi Alexandrini lemmatibus ex cod. M.B. Græcæ editio*, Edmundi Halletti, Oxoniæ, 1710. (5) *Der Sammlang des Pappus von Alexandrien elebentes und seines Buch griechisch und deutsch herausgegeben von C. I. Gerhardt*, Halle, 1871. (T. L. H.)

**PAPUAN LANGUAGES.** The languages spoken in NEW GUINEA (*q.v.*) and other islands peopled by Papuas differ more widely from the Malayo-Polynesian languages than those of the Negritos in the Philippine Islands do from the dialects of the contiguous Malayan tribes. In fact, they form as separate a class by themselves as the Melanesian languages do as contradistinguished from the Polynesian group. From the meagre grammatical sketch of the Mafor (or Nuför) language—the only one to which the Dutch missionaries have paid some attention, but which may be taken as a type of the class—we gather that the verb has the subject pronoun prefixed in the singular, dual, and plural; past time is expressed by the word *hoër*, "already," prefixed, and futurity by *nerri*, "still," added to the verb; certain modifications of the sense are effected by *i* being prefixed, and others by *i* being affixed, to the radical vowels *a*, *o*, or *u*, and others again by the substantive affix *sa* (plur. *sta*). Much uncertainty, however, still prevails as to the precise import of those grammatical forms. See J. L. van Hasselt's *Woordenboek and Beknopte Spraakkunst der Noefoorsche taal*, both of which appeared at Utrecht in 1876; Fr. Müller's *Grundriß der Sprachwissenschaft*, i., ii. p. 30 *sq.*; and more especially G. von der Gabelentz and A. B. Meyer, *Beiträge zur Kenntnis der Melanesischen, Mikronesischen, und Papuanischen Sprachen*, Leipzig, 1882, and their essay, "Einiges über das Verhältnis des Mafoor zum Malayischen," in *Bydragen tot de taal-, land-, en volkenkunde van Nederland-Indië*, for 1883. The former of these publications contains also a survey of the literature on the subject. Vocabularies of the languages spoken by the various coast tribes with whom Europeans have come in contact have been collected by S. Müller, Von Rosenberg, Miklucho

Maclay, and others. An intercomparison of those vocabularies not only shows great phonetical divergencies, especially in the liquids *r* and *l*, but also in many cases the same absence of word affinity in consequence of which neighbouring Melanesian tribes are known to be unable to understand one another.

**PAPYRUS**, the paper reed, the *Cyperus Papyrus* of Linnaeus, was in ancient times widely cultivated in the Delta of Egypt, where it was used for various purposes, and especially as a writing material. As, however, the plant is now extinct in Lower Egypt, it is believed that it was not indigenous there, but was probably introduced from Nubia, where it is found at the present time, as well as in Abyssinia. Theophrastus (*Hist. Plant.*, iv. 10) adds that it likewise grew in Syria; and, according to Pliny, it was also a native plant of the Niger and Euphrates. From one of its ancient Egyptian names, *Papui*, was derived its Greek title *πάπυρος*, Lat. *papyrus*. By Herodotus it is always called *βύβλος*, a word which was apparently also of Egyptian origin. The first accurate description of the plant is given by Theophrastus, from whom we learn that it grew in shallows of 2 cubits (about 3 feet) or less, its main root being of the thickness of a man's wrist, and 10 cubits in length. From this root, which lay horizontally, smaller roots pushed down into the mud, and the stem of the plant sprang up to the height of 4 cubits, being triangular and tapering in form. The tufted head or umbel is likened by Pliny to a thyrsus.

The various uses to which the papyrus plant was applied are also enumerated by Theophrastus. Of the head nothing could be made but garlands for the shrines of the gods; but the wood of the root was employed in the manufacture of different utensils as well as for fuel. Of the stem of the plant were made boats, sails, mats, cloth, cords, and, above all, writing material (*ῥά βύβλα*). The pith was also a common article of food, and was eaten both cooked and in its natural state. Herodotus too notices its consumption as food (ii. 92), and incidentally mentions that it provided the material of which the priests' sandals were made (ii. 37). He likewise refers to the use of byblus as tow for caulking the seams of ships; and the statement of Theophrastus that King Antigonus made the rigging of his fleet of the same material is illustrated by the ship's cable, *ἔπλων βύβλων*, wherewith the doors were fastened when Ulysses slew the suitors in his hall (*Odyss.*, xxi. 390). That the plant was itself used also as the principal material in the construction of light skiffs suitable for the navigation of the pools and shallows of the Nile, and even of the river itself, is shown by sculptures of the period of the fourth dynasty, in which men are represented in the act of building a boat with stems cut from a neighbouring plantation of papyrus (Lepsius, *Denkm.*, ii. 12). It is to boats of this description that Isaiah probably refers in the "vessels of bulrushes upon the waters" (xviii. 2). If the Hebrew *göme* (*קנה*) also is to be identified with the Egyptian papyrus, something may be said in favour of the tradition that the bulrushes

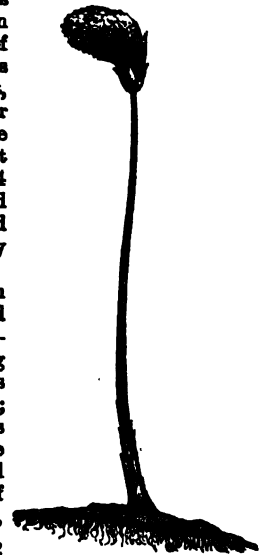

Papyrus.

of which the ark was composed in which the infant Moses was laid, in the flags by the river's brink, were in fact the latter plant. Ancient authors have likewise referred to the adaptation of the papyrus to other domestic purposes, both culinary and medicinal. But it seems hardly credible that the *Cyperus Papyrus* could alone have sufficed for the many uses to which it is said to have been applied. Wilkinson has pointed out (*Anc. Egyptians*, ii. 121) that, the cultivation of this variety being limited to certain districts, where, moreover, it was a monopoly of the Government, it cannot have been employed for so many purposes; and we may therefore conclude that several plants of the genus *Cyperus* were comprehended under the head of byblus or papyrus—an opinion which is supported by the words of Strabo, who mentions both inferior and superior qualities. The *Cyperus dives* is still grown in Egypt, and is used to this day for many of the purposes named by ancient writers.

The widespread use of papyrus as a writing material throughout the ancient world is attested by early writers, and by documents and sculptures. In addition to the names of the plant, which were also applied to the material, the latter was also known as  $\chi\acute{\alpha}\rho\iota\tau\eta$ , *charta*. Papyrus rolls are represented in ancient Egyptian wall-paintings; and extant examples of the rolls themselves are sufficiently numerous. The most ancient of these, known, from the name of its former owner, as the Prisse papyrus, and now preserved at Paris, contains a work composed in the reign of a king of the fifth dynasty, and is computed to be itself of the age of upwards of 2000 years B.C. The papyri discovered in Egypt have generally been found in tombs, and in the hands, or swathed with the bodies, of mummies. The ritual of the dead, which in its entirety or in an abridged form was buried with every person of consequence from the eighteenth dynasty to the Roman period, is most frequently the subject. And, besides the ritual and religious rolls, there are the hieratic, civil and literary, documents, and the demotic and enchorial papyri, relating generally to sales of property. Coptic papyri usually contain Biblical or religious tracts or monastic deeds.

The early use of papyrus among the Greeks is proved by the reference of Herodotus (v. 58) to its introduction among the Ionians. An inscription of 407 B.C. records the sale of two sheets ( $\chi\acute{\alpha}\rho\iota\tau\alpha\ \delta\upsilon\omicron$ ) at Athens, for two drachmas and four obols. Greek papyri have been found in Egypt of great importance both for their paleographical and literary worth. The first instalment which came to light, as late as the year 1778, consisted of some fifty rolls, which were discovered in the neighbourhood of Memphis; but all, with one single exception, were carelessly destroyed. More fortunate were the documents found near the Serapeum of Memphis, and connected with that temple; and further discoveries of valuable texts of Homer, Hyperides, and other classical writers have rewarded later searches (see PALÆOGRAPHY). The numerous rolls found in the ruins of Herculaneum generally contain the less interesting works of writers of the Epicurean school.

Papyrus also made its way into Italy, but at how early a period there is nothing to show. Under the empire its use must have been extensive, for not only was it required for the production of books, but it was also universally employed for domestic purposes, correspondence, and legal documents. So indispensable did it become that it is reported that in the reign of Tiberius the scarcity and dearness of the material, caused by a failure of the papyrus crop, nearly brought on a riot (Pliny, *N. H.*, xiii. 13).

The account which Pliny (*N. H.*, xiii. 11-13) has transmitted to us of the manufacture of the writing material from the papyrus plant should be taken strictly to refer to the process followed in his own time; but, with some

differences in detail, the same general method of treatment had doubtlessly been practised from time immemorial. His text, however, is so confused, both from obscurity of style and from corruptions in the MSS., that there is much difference of opinion as to the meaning of many words and phrases employed in his narrative, and their application in particular points of detail. In one important particular, however, affecting the primary construction of the material, there can no longer be any doubt. The old idea that it was made from layers or pellicules growing between the rind and a central stalk has been abandoned, as it has been proved that the plant, like other reeds, contains only a cellular pith within the rind. The stem was in fact cut into longitudinal strips for the purpose of being converted into the writing material, those from the centre of the plant being the broadest and most valuable. The strips (*phylæ*), which were cut with a sharp knife or some such instrument, were laid on a board side by side to the required width, thus forming a layer (*cheda*), across which another layer of shorter strips was laid at right angles. The two layers thus "woven"—Pliny uses the word *texere* in describing this part of the process—formed a sheet (*plagula*, or net), which was then soaked in water of the Nile. The mention of a particular water has caused trouble to the commentators. Some have supposed that certain chemical properties of which the Nile water was possessed acted as a glue or cement to cause the two layers to adhere; others, with more reason, that glutinous matter contained in the material itself was solved by the action of water, whether from the Nile or any other source; and others again read in Pliny's words an implication that a paste was actually used. Be this as it may, the sheet was finally pressed and dried in the sun. Any roughness was levelled by polishing with ivory or a smooth shell. But the material was also subject to other defects, such as moisture lurking between the layers, which might be detected by strokes of the mallet; spots or stains; and spongy strips (*tenise*), in which the ink would run and spoil the sheet. When such faults occurred, the papyrus must be re-made. To form a roll the sheets were joined together with paste (glue being too hard), but not more than twenty sheets in a roll (*scapus*). As, however, there are still extant rolls consisting of more than the prescribed number of sheets, either the reading of *vicens* is corrupt, or the number was not constant in all times. The best sheet formed the first or outside sheet of the roll, and the others were joined on in order of quality, so that the worst sheets were in the centre of the roll. This arrangement was adopted, not for the purpose of fraudulently selling bad material under cover of the better exterior, but in order that the outside of the roll should be composed of that which would best stand wear and tear. Besides, in case of the entire roll not being filled with the text, the unused and inferior sheets at the end could be better spared, and so might be cut off.

The different kinds of papyrus writing material and their dimensions are also enumerated by Pliny. The best quality, formed from the middle and broadest strips of the plant, was originally named *hieratica*, but afterwards, in flattery of the emperor Augustus, it was called, after him, *Augusta*; and the *charta Livia*, or second quality, was so named in honour of his wife. The *hieratica* thus descended to the third rank. The first two were 13 digiti, or about  $9\frac{1}{2}$  inches in width; the *hieratica*, 11 digiti or 8 inches. Next came the *charta amphitheatreica*, named after the principal place of its manufacture, the amphitheatre of Alexandria, of 9 digiti or  $6\frac{1}{2}$  inches wide. The *charta Fanniana* appears to have been a kind of papyrus worked up from the *amphitheatreica*, which by flattening and other methods was increased in width by an inch, in the factory of a certain Fannius at Rome. The *Saitica*, which took its name from the city of Saïs, and was probably of 8 digiti or  $5\frac{1}{2}$  inches, was of a common description. The *Fanotica*, named apparently from the place of its manufacture, a tongue of land (*rauis*) near Alexandria, was sold by weight, and was of

uncertain width, perhaps from 4½ to 5 inches. And lastly there was the common packing-paper, the *charta emporctica*, of 6 digits or 4½ inches. Isidore (*Etymol.*, vi. 10) mentions yet another kind, the *Corneliana*, first made under C. Cornelius Gallus, prefect of Egypt, which, however, may have been the same as the *amphitheatrica* or *Fassiana*. The name of the man who had incurred the anger of Augustus may have been suppressed by the same influence that expunged the episode of Gallus from the Fourth Georgic (Birt, *Antik. Buchwesen*, p. 260). In the reign of the emperor Claudius also another kind was introduced and entitled *Claudia*. It had been found by experience that the *charta Augustia* was, from its fineness and porous nature, ill suited for literary use; it was accordingly reserved for correspondence only, and for other purposes was replaced by the new paper. The *charta Claudia* was made from a composition of the first and second qualities, the *Augusta* and the *Livia*, a layer of the former being backed with one of the latter; and the sheet was increased to nearly a foot in width. The largest of all, however, was the *macrocollon*, probably of good quality and equal to the hieratic, and a cubit or nearly 18 inches wide. It was used by Cicero (*Epp. ad Attic.*, xiii. 25; xvi. 8). The width, however, proved inconvenient, and the broad sheet was liable to injury by tearing.

An interesting question arises as to the accuracy of the different measurements given by Pliny. His figures regarding the width of the different kinds of papyrus have generally been understood to concern the width (or height) of the rolls, as distinguished from their length. It has, however, been observed that in practice the width of extant rolls does not tally in any satisfactory degree with Pliny's measurements; and a more plausible explanation has been lately offered (Birt, *Antik. Buchwesen*, pp. 251 sq.) that the breadth (not height) of the individual sheets of which the rolls are composed is referred to.

The first sheet of a roll was named *πρωτόκολλον*; the last, *τεγχεροκόλλιον*. Under the Romans, the former bore the name of the comes largitionum, who had control of the manufacture, with the date and name of place. It was the practice to cut away the portion thus marked; but in case of legal documents this mutilation was forbidden by the laws of Justinian. On the Arab conquest of Egypt in the 7th century, the manufacture was continued, with the substitution of Arabic in marking the protocol. An instance of one of these Arab signatures is preserved in a bull of Pope John VIII. of the year 876.

Varro's statement, repeated by Pliny, that papyrus was first made in Alexander's time, should probably be taken to mean that its manufacture, which till then had been a Government monopoly, was relieved from all restrictions. It is not probable, however, that it was ever manufactured from the native plant anywhere but in Egypt. At Rome there was certainly some kind of industry in papyrus, the *charta Fanstiana*, already referred to, being an instance in illustration. But it seems probable that this industry was confined to the re-making of material imported into Italy, as in the case of the *charta Claudia*. This second manufacture, however, is thought to have been detrimental to the papyrus, as it would then have been in a dried condition requiring artificial aids, such as a more liberal use of gum or paste, in the process. The more brittle condition of the Latin papyrus found at Herculaneum has been instanced as the evil result of this re-making of the material.

According to Strabo the Romans obtained the papyrus plant from Lake Trasimene and other lakes of Etruria, but this statement is unsupported by any other authority and appears to have been made in error. At a later period, however, a papyrus was cultivated in Sicily, which has been identified by Parlatore with the Syrian variety (*Cyperus syriacus*), far exceeding in height the Egyptian plant, and having a more drooping head. It grew in the east and south of the island, where it was probably introduced during the Arab occupation. It was seen in the 10th century, by the Arab traveller Ibn-Hankal, in the neighbourhood of Palermo, where it thrived luxuriantly in the pools of the Papiroto, a stream to which it lent its name. From it paper was made for the sultan's use. But in the 13th century it began to fail, and in 1551 the drying up of the Papiroto caused the extinction of the plant in that district. It is still to be seen at Syracuse, but it was probably transplanted thither at a later time, and reared only as a curiosity, as there is no notice of it to be found previous to 1674. It is with this Syracusan plant that some attempts have been made in recent years to manufacture a writing material similar to ancient papyrus.

Even after the introduction of vellum, papyrus still continued in use among the Romans, and was not entirely superseded until a late date. It ceased, however, to be used for books sooner than for documents. In the 5th century St Augustine apologizes for sending a letter written on vellum instead of the more usual substance, papyrus (*Epp.* xv.); and Cassiodorus (*Varr.*, xi. 38), writing in the 6th century, indulges in a high-flown panegyric on the plant and its value, and refers to the abolition of the tax on paper by the emperor Theodoris. Of mediæval Greek papyrus a very few remains containing Biblical or patristic matter have survived, and one or two fragments of Græco-Latin glossaries have been published. Of

Greek documents, apart from monastic deeds discovered in Egypt, there are two which are well known, viz., the fragmentary epistle of Constantine V. to Pepin le Bref, of 768 or 766, now preserved at Paris, and the papyrus containing the subscriptions to the council of Constantinople of 680, at Vienna. Mediæval Latin MSS. on papyrus in book form are still extant in different libraries of Europe, viz.:—the Homilies of St Avitus, of the 6th century, at Paris; Sermons and Epistles of St Augustine, of the 6th or 7th century, at Paris and Geneva; works of Hilary, of the 6th century, at Vienna; fragments of the Digests, of the 6th century, at Pommersfeld; the Antiquities of Josephus, of the 7th century, at Milan; Isidore, *De Conspectu Mundi*, of the 7th century, at St Gall; and the Register of the Church of Ravenna, of the 10th century, at Munich. Of Latin documents on papyrus (*lomis* was the technical word of the Middle Ages to designate such a document), the first to be mentioned are the fragments of two imperial rescripts addressed to an official in Egypt in the 5th century. The employment of this material in Italy for legal purposes is sufficiently illustrated by the large number of documents which were preserved at Ravenna, and date from the 5th to the 10th century. In the papal chancery too it was used at an early date, evidence of its presence there being found in the biography of Gregory I. But of the extant papal deeds the earliest to which an authentic date can be attached is a bull of Stephen III. of the year 757, while the latest appears to be one of 1004. There is evidence to show that in the 10th century papyrus was used, to the exclusion of other materials, in papal deeds. In France it was a common writing substance in the 6th century (Gregory of Tours, *Hist. Franc.*, v. 5). Of the Merovingian period there are still extant several papyrus deeds, the earliest of the year 625, the latest of 692. Under Charlemagne and his successors it was not used. By the 12th century the manufacture of papyrus had entirely ceased, as appears from a note by Eustathius in his commentary on the *Odyssey*, xxi. 390.

See Melch. Gullandino's commentary on the chapters of Pliny relating to papyrus, *Papyrus, hoc est Commentarius*, &c., Venice, 1672; Montfaucon, "Dissertation sur la plante appelée Papyrus," in the *Mémoires de l'Académie des Inscriptions*, 1724, pp. 592-608; T. C. Tychsen, "De Chartis Papyraceis in Europa per medium ævum usæ," in the *Comment. Soc. Reg. Scient. Gottingensis*, 1850, pp. 141-208; Dureau de la Malle, "Mémoire sur le Papyrus," in the *Mém. de l'Institut*, 1861, pp. 140-183; Ph. Falstors, "Mémoire sur le Papyrus des anciens," &c., in the *Mém. de l'Acad. des Sci.*, 1854, pp. 469-502; Bittner, *Technologie und Terminologie der Gewerbe und Künste bei Griechen und Römern*, Leipzig, 1874, I. pp. 308-327; Cea. Paoli, *Del Papiro*, Florence, 1878. See also W. Wattenbach, *Das Schriftwesen im Mittelalter*, Leipzig, 1874, pp. 80-91; and T. Birt, *Das antike Buchwesen*, Berlin, 1883, pp. 223-278. (S. M. T.)

**PARÁ, OF SANTA MARIA DE BELÉM DO GRÃO PARÁ,** one of the most flourishing cities of Brazil, capital of the province of Pará or Grão Pará, lies on a point of land with sandy porous soil at the junction of the Guamá with the Rio Pará or eastern arm of the Amazona, about 75 miles from the sea. The main river is about 20 miles wide opposite the town, but is broken by numerous islands. Pará is regularly built, well-paved, and well-lighted. The houses, which seldom exceed two or three stories in height, are usually substantial structures of stone; and a general brightness of aspect is produced by red-tiled roofs and white, yellow, or even pink and blue coloured walls relieved by dense tropical foliage. The Estrada das Mongubeiras, running about a mile from the river to Largo da Polvora in the east end of the city, has long been famous for its magnificent cotton trees (*Bombax Monguba*, *B. Ceiba*); but the grand old trees are dying out, and the finest avenue in Pará is now the Estrada de São José, with its colonnade of tall "royal palms" (*Oreodora regia*). In the outskirts of the city the wealthy merchants have villas with very extensive grounds, and a little way beyond these begins the dense swamp-forest. Pará has a wonderfully pleasant and healthy climate, with a temperature extremely equable throughout the year. "The mornings are cool. From 10 till 2 the heat increases rapidly, commonly reaching 90° or 91°. A little later great black clouds appear in the east and spread quickly over the sky; the temperature falls suddenly, the wind blows in varying gusts, the rain pours down, and ere one is aware the sun leaps out. Sometimes the first shower is followed by a second or even a third. By sunset the ground is dry." This is the rule all the year round; only in the height of the dry season a week may pass without any showers. The Brazilians have a proverb, "Who came to Pará was glad to stay; who drank assai never away." The

assaí referred to is a beverage made by squeezing the black grape-like berries of the assaí palm (*Euterpe edulis*); it is largely drunk by all classes in Pará. The importance of the city is due to its being the great emporium of the rapidly-developing trade of the Amazona. The trade is carried on by several steamboat companies; the most important, the Amazonian Steamboat Company, receives a subsidy from the Brazilian Government. Two lines of steamers run between Liverpool and Pará; there are also a French line and a German line. A large trade is transacted with the United States, but mainly through English, French, German, and Portuguese houses. The principal exports are cocoa, Brazil nuts, hides, deer-skins, isinglass, balsam of copaiba, tonka beans, and Peruvian bark. In 1863 the total value of the imports was about £500,000 and of the exports about £325,000; by 1882 the duties paid to the custom-house amounted to £864,396.

Population has been growing faster than the supply of houses. In 1819 the inhabitants were estimated at 24,500, but by 1850 they had declined to 15,000; in 1866 they were 36,000 (about 5000 slaves); and they are now (1884) nearly 40,000. Besides a vast cathedral (1720) and the president's palace, usually considered one of the best buildings of its kind in Brazil, Pará contains an episcopal palace (formerly the Jesuit college), a handsome theatre, a large market building, a custom-house (formerly a convent, with two great towers), naval and military arsenals (the first of some size, with shipbuilding yards and a gridiron), a botanical garden, &c. About a mile from the city is the chapel of Our Lady of Nazareth, the most celebrated shrine in northern Brazil.

In 1615 Francisco Caldeira de Castello Branco, sent out by the Portuguese at Maranhão, built the fort of Santo Christo and founded the settlement of Nossa Senhora de Belem. By 1641 it was a place of 400 inhabitants, with four monasteries. A premature declaration of independence was made at Pará in 1823, and soon after Captain Grenfell, sent by Lord Cochrane, brought the city over to the Brazilian party; but for many years it was subject to political disturbance. In 1835 "every respectable white was obliged to leave the city" by the anarchical proceedings of the so-called "Liberals" Gomes, Vinagre, and Rodriguez.

See Bates, *Naturalist on the River Amazona*, 1863; H. H. Smith, *Brazil*, 1879.

**PARACELSUS** (c. 1490–1541). It seems now to be established that Paracelsus was born near Einsiedeln, in the canton Schwyz, in 1490 or 1491 according to some, or 1493 according to others. His father, the natural son of a grand-master of the Teutonic order, was Wilhelm Bombast von Hohenheim, who had a hard struggle to make a subsistence as a physician. His mother was superintendent of the hospital at Einsiedeln, a post she relinquished upon her marriage. Paracelsus's name was Theophrastus Bombast von Hohenheim; for the names Philippus and Aureolus good authority is wanting, and the epithet Paracelsus, like some similar compounds, was probably one of his own making, and was meant to denote his superiority to Celsus. In 1502–3 his father, taking his family with him, removed to Villach in Carinthia; and he resided there in the practice of the medical art till his death in 1534. In one of his works, dedicated to the magistracy of the town, Paracelsus refers to the esteem in which his father was held, and expresses his own gratitude for it.

Of the early years of Paracelsus's life there is hardly anything known. His father was his first teacher, and took pains to instruct him in all the learning of the time, especially in medicine. Doubtless Paracelsus learned rapidly what was put before him, but he seems at a comparatively early age to have questioned the value of what he was expected to acquire, and to have soon struck out ways for himself. As he grew older he was taken in hand by several distinguished churchmen, although it has been objected that dates will not warrant the idea of actual

personal instruction. This, however, is not correct, for all the men Paracelsus mentions were alive in his lifetime, though he was so young that he could hardly have profited by their lessons, unless on the supposition that he was a quick and precocious boy, which it is very likely he was. At the age of sixteen he entered the university of Basel, but probably soon abandoned the studies therein pursued. He next went to Trithemius, the bishop of Sponheim and Würzburg, under whom he prosecuted chemical researches. Trithemius is the reputed author of some obscure tracts on the great elixir, and as there was no other chemistry going Paracelsus would have to devote himself to the reiterated operations so characteristic of the notions of that time. But the confection of the stone of the philosophers was too remote a possibility to gratify the fiery spirit of a youth like Paracelsus, eager to make what he knew, or could learn, at once available for practical medicine. So he left school chemistry as he had forsaken university culture, and started for the mines in Tyrol owned by the wealthy family of the Fuggers. The sort of knowledge he got there pleased him much more. There at least he was in contact with reality. The struggle with nature before the precious metals could be made of use impressed upon him more and more the importance of actual personal observation. He saw all the mechanical difficulties that had to be overcome in mining; he learned the nature and succession of rocks, the physical properties of minerals, ores, and metals; he got a notion of mineral waters; he was an eyewitness of the accidents which befel the miners, and studied the diseases which attacked them; he had proof that positive knowledge of nature was not to be got in schools and universities, but only by going to Nature herself, and to those who were constantly engaged with her. Hence came Paracelsus's peculiar mode of study. He attached no value to mere scholarship; scholastic disputations he utterly ignored and despised,—and especially the discussions on medical topics, which turned more upon theories and definitions than upon actual practice. He therefore went wandering over a great part of Europe to learn all that he could. In so doing he was one of the first physicians of modern times to profit by a mode of study which is now reckoned indispensable. In the 16th century the difficulty of moving about was much greater than it is now; still Paracelsus faced it, and on principle. The book of nature, he affirmed, is that which the physician must read, and to do so he must walk over the leaves. The humours and passions and diseases of different nations are different, and the physician must go among the nations if he will be master of his art; the more he knows of other nations, the better he will understand his own. For the physician it is ten times more necessary and useful to know the powers of the heavens and the earth, the virtues of plants and minerals, than to spend his time on Greek and Latin grammar. And the commentary of his own and succeeding centuries upon these very extreme views is that Paracelsus was no scholar, but an ignorant vagabond. He himself, however, valued his method and his knowledge very differently, and argued that he knew what his predecessors were ignorant of, because he had been taught in no human school. "Whence have I all my secrets, out of what writers and authors? Ask rather how the beasts have learned their arts. If nature can instruct irrational animals, can it not much more men?" In this new school discovered by Paracelsus, and since attended with the happiest results by many others, he remained for about ten years. He had acquired great stores of facts, which it was impossible for him to have reduced to order, but which gave him an unquestionable superiority to his contemporaries. So in 1526 or 1527, on his return to Basel, he was appointed town physician,

and shortly afterwards he gave a course of lectures on medicine in the university. Unfortunately for him, the lectures broke away from tradition. They were in German, not in Latin; they were expositions of his own experience, of his own views, of his own methods of curing, adapted to the diseases that afflicted the Germans in the year 1527, and they were not commentaries on the text of Galen or Avicenna. Unfortunately they attacked, not only these great authorities, but the German graduates who followed them and disputed about them in 1527. They criticized in no measured terms the current medicine of the time, and exposed the practical ignorance, the compositio, and the greed of those who practised it.

The truth of Paracelsus's doctrines was apparently confirmed by his success in curing or mitigating diseases for which the regular physicians could do nothing. For about a couple of years his reputation and practice increased to a surprising extent. But at the end of that time people began to recover themselves. Paracelsus had burst upon the schools with such novel views and methods, with such irresistible criticism, that all opposition was at first crushed flat. Gradually the sea began to rise. His enemies watched for slips and failures; the physicians maintained that he had no degree, and insisted that he should give proof of his qualifications. His manner of life was brought up against him. It was insinuated that he was a profane person, that he was a conjurer, a necromancer, that, in fact, he was to be got rid of at any cost as a troubler of the peace and of the time-honoured traditions of the medical corporations. Moreover, he had a pharmaceutical system of his own which did not harmonize with the commercial arrangements of the apothecaries, and he not only did not use up their drugs like the Galenists, but, in the exercise of his functions as town physician, urged the authorities to keep a sharp eye on the purity of their wares, upon their knowledge of their art, and upon their transactions with their friends the physicians. The growing jealousy and enmity culminated in the Lichtenfels dispute; and, as the judges sided with the canon, to their everlasting discredit, Paracelsus had no alternative but to tell them his opinion of the whole case and of their notions of justice. So little doubt left he on the subject that his friends judged it prudent for him to leave Basel at once, as it had been resolved to punish him for the attack on the authorities of which he had been guilty. He departed from Basel in such haste that he carried nothing with him, and some chemical apparatus and other property were taken charge of by Oporinus, his pupil and amanuensis. He went first to Esslingen, where he remained for a brief period, but had soon to leave from absolute want. Then began his wandering life, the course of which can be traced by the dates of his various writings. He thus visited in succession Colmar, Nuremberg, Appenzell, Zurich, Pfäfers, Augsburg, Villach, Meran, Middelheim, and other places, seldom staying a twelvemonth in any of them. In this way he spent some dozen years, till 1541, when he was invited by Archbishop Ernst to settle at Salzburg, under his protection. After his endless tossing about, this seemed a promise and place of repose. It proved, however, to be the complete and final rest that he found, for after a few months he died on the 24th of September. The cause of his death, like most other details in his history, is uncertain. His enemies asserted that he died in a low tavern in consequence of a drunken debauch of some days' duration. Others maintain that he was thrown down a steep place by some emissaries either of the physicians or of the apothecaries, both of whom he had during his life most grievously harassed. In proof of this surgeons have pointed out in Paracelsus's skull a flaw or fracture, which could have been produced only during life. Authorities,

however, are not agreed on this point, and it may be simplest to suspend belief until more evidence is got. He was buried in the churchyard of St Sebastian, but in 1752 his bones were removed to the porch of the church, and a monument of reddish-white marble was erected to his memory.

In making the attempt to ascertain what was Paracelsus's character, and what were his philosophical and medical opinions, a very considerable difficulty presents itself at the outset. Of the voluminous writings which pass under his name, what are really his works, and what, if not actually composed by him, express his ideas? To this question no complete critical reply has as yet been given, though many opinions have been expressed. Dr Marx, for example, will admit only ten treatises as genuine. Dr Haeser allows seventeen for certain, a considerable number—some twenty-four—as doubtful, and the rest—he enumerates eleven—as spurious. Dr Mook does not accept these estimates, or the criteria by which the genuineness of a treatise is ascertained. But neither does he give altogether convincing criteria of his own, and, what is still less satisfactory, he does not apply them—such as they are—to decide the numerous doubtful cases. The only thing Mook has done is to draw up a list of the different editions of Paracelsus's so-called works. This list is not complete in the enumeration of editions, and it is quite imperfect in bibliographical description, but with these and other serious defects it is the fullest at present extant. The first book by Paracelsus was printed at Augsburg in 1529. It is entitled *Practica D. Theophrasti Paracelsi, gemacht auff Europen*, and forms a small quarto pamphlet of five leaves. Prior to this, in 1526-27, appeared a programme of the lectures he intended to deliver at Basel, but this can hardly be reckoned a specific work. During his lifetime fourteen works and editions were published, and thereafter, between 1542 and 1845, there were at least two hundred and thirty-four separate publications according to Mook's enumeration. The first collected edition was made by Johann Huser in German. It was printed at Basel in 1589-91, in eleven volumes quarto, and is the best of all the editions. Huser did not employ the early printed copies only, but collected all the manuscripts which he could procure, and used them also in forming his text. The only drawback is that rather than omit anything which Paracelsus may have composed, he has gone to the opposite extreme and included writings with which it is pretty certain Paracelsus had nothing to do. The second collected German edition is in four volumes folio, 1603-5. Parallel with it in 1603 the first collected Latin edition was made by Palthenius. It is in eleven volumes quarto, and was completed in 1605. Again, in 1616-18 appeared a reissue of the folio German edition of 1603, and finally in 1658 came the Geneva Latin version, in three volumes folio, edited by Bittikina.

The works were originally composed in Swiss-German, a vigorous speech which Paracelsus wielded with unmistakable power. The Latin versions were made or edited by Adam von Bodenstein, Gerard Dorn, Michael Toxites, and Oporinus, about the middle of the 16th century. A few translations into other languages exist, as of the *Chirurgia Magna* and some other works into French, and of one or two into Dutch, Italian, and even Arabic. The translations into English amount to about a dozen, dating mostly from the middle of the 17th century. The original editions of Paracelsus's works are getting less and less common; even the English versions are among the rarest of their class. Over and above the numerous editions, there is a bulky literature of an explanatory and controversial character, for which the world is indebted to Paracelsus's followers and enemies. A good deal of it is taken up with a defence of chemical, or, as they were called, "spagyric," medicines against the attacks of the supporters of the Galenic pharmacopœia.

The aim of all Paracelsus's writing is to promote the progress of medicine, and he endeavours to put before physicians a grand ideal of their profession. In his attempts he takes the widest view of medicine. He bases it on the general relationship which man bears to nature as a whole; he cannot divorce the life of man from that of the universe; he cannot think of disease otherwise than as a phase of life. He is compelled therefore to treat his medical practice upon general theories of the present state of things; his medical system—if there is such a thing—is an adaptation of his cosmogony. It is this latter which has been the stumbling-block to many past critics of Paracelsus, and unless its character is remembered it will be the same to others in the future. Dissatisfied with the Aristotelianism of his time, Paracelsus turned with greater expectation to the Neoplatonism which was reviving. His eagerness to understand the relationship of man to the universe led him to the Kabbala, where these mysteries seemed to be explained, and from these unsubstantial materials he constructed, so far as it can be understood, his visionary philosophy. Interwoven with it, however, were the results of his own personal experience and work in natural history and chemical pharmacy and practical medicine,

unfettered by any speculative generalizations, and so shrewd an observer as Paracelsus was must have often felt that his philosophy and his experience did not agree with one another. It was doubtless a very great ideal of medicine which Paracelsus raised; but when it came to realizing it in every-day life he could hardly do else than fail. During the three hundred years which have elapsed since his time knowledge both of the macrocosm and of the microcosm has increased far beyond what Paracelsus could have understood, even had it been all foretold him; and the healing art has advanced also, though perhaps scarcely at the same rate, but it would be as hard for us as for him to apply any cosmogony, however rational, to curing disease. We are not one whit nearer the solution of the problems which puzzled Paracelsus than he was; the mystery of the origin, continuance, and stoppage of life is, perhaps through the abundance of light shed on other phenomena, even darker than it may have seemed to Paracelsus. If this be so it is no matter for surprise, or blame, or ridicule that he missed constructing a theory of the universe which at the same time would be a never-failing guide to him in the practical work of alleviating the evils which a residence in this universe seems to entail.

Some of his doctrines have been already alluded to in the article *MEDICINE* (g.v.), and it would serve no purpose to give even a brief sketch of his views, seeing that their influence has passed entirely away, and that they are of interest only in their place in a general history of medicine and philosophy. Defective, however, as they may have been, and unfounded in fact, his kabbalistic doctrines led him to trace the dependence of the human body upon outer nature for its sustenance and cure. The doctrine of signatures, the supposed connexion of every part of the little world of man with a corresponding part of the great world of nature, was a fanciful and false exaggeration of this doctrine, but the idea carried in its train that of specifics. This led to the search for these, which were not to be found in the bewildering and untested mixtures of the Galenic prescriptions. Paracelsus had seen how bodies were purified and intensified by chemical operations, and he thought if plants and minerals could be made to yield their active principles it would surely be better to employ these than the crude and unprepared originals. He had besides arrived by some kind of intuition at the conclusion that the operations in the body were of a chemical character, and that when disordered they were to be put right by counter operations of the same kind. It may be claimed for Paracelsus that he embraced within the idea of chemical action something more than the alchemists did. Whether or not he believed in the philosopher's elixir is of very little consequence. If he did, he was like the rest of his age; but he troubled himself very little, if at all, about it. He did believe in the immediate use for therapeutics of the salts and other preparations which his practical skill enabled him to make. Technically he was not a chemist; he did not concern himself either with the composition of his compounds or with an explanation of what occurred in their making. If he could get potent drugs to cure disease he was content, and he worked very hard in an empirical way to make them. That he found out some new compounds is certain; but not one great and marked discovery can be ascribed to him. Probably therefore his positive services are to be summed up in this wide application of chemical ideas to pharmacy and therapeutics; his indirect and possibly greater services are to be found in the stimulus, the revolutionary stimulus, of his ideas about method and general theory. It is not difficult, however, to criticize Paracelsus and to represent him as so far below the level of his time as to be utterly contemptible. It is difficult, but perhaps not impossible, to raise Paracelsus to a place among the great spirits of mankind. It is most difficult of all to ascertain what his true character really was, to appreciate aright this man of fervid imagination, of powerful and persistent convictions, of unabated honesty and love of truth, of keen insight into the errors (as he thought them) of his time, of a merciless will to lay bare these errors and to reform the abuses to which they gave rise, who in an instant offends us by his boasting, his grossness, his want of self-respect. It is a problem how to reconcile his ignorance, his weakness, his superstition, his crude notions, his erroneous observations, his ridiculous inferences and theories, with his grasp of method, his lofty views of the true scope of medicine, his lucid statements, his incisive and epigrammatic criticisms of man and motives.

A character full of contradictory elements cannot but have had contradictory judgments passed on it; and after three hundred years the animus is as strong and the judgments are as diverse as ever.

(J. F.)

PARADISE is an old Persian word (*Pairīdāza* in the *Vendidad*) meaning an enclosure, a park. The Greeks use the word in the form *Παράδεισος* of the parks of the Persian kings, and it was borrowed also by the Hebrews in the form *פַּרְדֵּיז* (Cant. iv. 13; Eccles. ii. 5; Neh. ii. 8; A. V., "orchard," "forest"). The Septuagint chose the Greek form to translate the "garden" of Genesis ii.; other

Greek and Latin versions followed them, and thus "paradise" became the usual ecclesiastical name for the garden of Eden, which has been spoken of under *EDEN*. Now, as Paradise in this sense was the residence of man before he sinned, it was natural enough that theological speculation as to the dwelling-place of the righteous, after death, or in the future glory, should attach itself to the account given in Genesis of the original habitation of righteous Adam, and borrow not only the name but in some measure also the conception of paradise as there described. This took place in more than one way, as we see from the Jewish apocalyptic literature, and especially from the book of Enoch. Thus we find (1) the idea that the old Paradise still exists in a secret part of the earth, and that Enoch, Elijah, and other elect and righteous persons dwell there. This is the foundation of the doctrine of the earthly paradise, which passed into Christianity—being supposed to find confirmation in the New Testament, especially in Luke xxiii. 43. The *earthly* paradise, as developed by Christian fancy, is the old garden of Eden, which lay in the far East beyond the stream of Ocean, raised so high on a triple terrace of mountain that the deluge did not touch it. It is the residence of certain departed saints, and the pictures drawn of it are coloured with classical reminiscences of Elysium and the Islands of the Blest. How these outlines were filled up at different periods may be learned from Ephraem Syrus's poem on Paradise (4th century), from Cosmas Indicopleustes (6th century), from the *Divina Commedia* of Dante, and other mediæval sources. A more ideal conception is (2) that of the *heavenly* paradise. To the Hebrews ideal things represent themselves as the heavenly counterparts of earthly things; ideals which God's people are to realize in the future are already existent in heaven, or even things which have once been lost, but which are necessary to man's true happiness, are preserved in heaven. Thus the heavenly paradise was either a mere figure for the good things, corresponding to those which Adam lost, which are reserved in heaven for the righteous, or it was the heavenly archetype of which the earthly paradise was a copy, or on a crasser way of thinking it was held that the paradise which Adam lost had been actually transported to heaven. The commonest form of the idea was perhaps that expressed in 4 Ezra and the Talmud, by saying that paradise was created before the earth. This paradise is not conceived as the place of the souls of all the righteous after death, but it is inhabited by certain select persons—Enoch, Elijah, Moses, Ezra—who enjoy in it the fellowship of the coming Messiah. After the last judgment, when the enemies of Israel are cast into Gehenna, the righteous are raised to paradise, and there behold the glory of God. Associated with such views as these, we find farther the idea (3) that in the future glory paradise, or the heavenly Jerusalem, which stood in paradise before the fall and was removed to heaven with it (Apoc. Baruch), will be brought down from heaven to earth, that the tree of life will be planted on Zion (Bk. Enoch, 4 Ezra). All these apocalyptic crudities, which it is not necessary to follow into details, are really mechanical developments of a legitimate, one may even say an inevitable, inference from the position that the garden of Gen. ii. represents a state of ideal human felicity lost through sin. For, if this be so, the future bliss of the redeemed must be conceived as somehow analogous to the life of Eden, and a literal unimaginative conception of this analogy, making no allowance for the difference between the happiness of childhood, prior to experience of the everyday world, and the happiness of a life which has conquered the world, must end in regarding the future home of the blest as a mere reproduction of Eden. But the use of the word paradise for the home of



the blessed does not necessarily imply so mechanical a conception as we find in the Jewish apocalypses; to speak of the future bliss at all, without the use of metaphysics, is possible only in the form of poetical description, and for such description the story of the garden of Eden supplied the necessary concrete elements, which the apocalyptists took literally, while higher thinkers used them as symbols—and ordinary language, perhaps, as mere conventional equivalents—for ineffable things. Thus the images borrowed from Eden in such a prophecy as Isa. xi. are certainly not meant literally, any more than the figure of the tree of life in the book of Proverbs. So in the New Testament even Rev. ii. 7 is plainly figurative, and in Luke xxiii. 43 paradise is simply the place of bliss. In 2 Cor. xii. 4 paradise is a heavenly place where ineffable words were heard by Paul; but he himself does not know whether he visited it in the body or out of the body.

See Dillmann's *Buch Enoch*, and his articles "Eden" and "Paradies" in Bohlen's *Bibel-Lexikon*; Weber, *Altsynagogaische Theologie*; and the books on Biblical theology. The Mohammedan paradise (al-Janna) is borrowed from the Jews, as appears from the name *Jannatu 'Adna*, that is, Garden of Eden. It is described in the Koran and by later theologians as a place of all sensuous delights, where the righteous recline on couches in a fair garden drinking the delicious beverage supplied by the fountain Tasmim and waited on by damsels with great bright eyes ("Hür," Kor. lv. 72, hence our "hour," which is properly a Persian form). The expression "gardens of Firdaus" (the Persian form of the word Paradise) occurs in Kor. xviii. 107, and is interpreted as meaning the highest region of the Janna (Beidawi in l.).

PARADISE, BIRDS OF. See vol. iii. p. 778.

PARAFFIN. In the course of his classical investigation on the tar produced in the dry distillation of wood, Reichenbach in 1830 discovered in it, amongst many other things, a colourless wax-like solid which he called paraffin (*parum affinis*) because he found it to be endowed with an extraordinary indifference towards all reagents. A few years later he isolated from the same material a liquid oil chemically similar to paraffin, to which he gave the name of *eupion* (*εὐπίον*, very fat). For many years both these bodies were known only as chemical curiosities, and even scientific men looked upon them as things entirely *ens gætheris*; this was natural enough as far as paraffin is concerned, but it is rather singular that it took so long before it was realized that eupion or something very much like it forms the body of PETROLEUM (*q.v.*), which had been known, since the time of Herodotus at least, to well up abundantly from the bowels of the earth in certain places. Though extensively known, it was used only as an external medicinal agent, until the late Mr James Young conceived the idea of industrially working a comparatively scanty oil-spring in Derbyshire, and subsequently found that an oil similar to petroleum is obtained by the dry distillation of cannel coal and similar materials at low temperatures. This discovery developed into a grand industry, which may be said to have led to the utilization of those immense natural stores of petroleum in America. Scientific chemists naturally directed their attention to the products of these new industries, and it was soon ascertained that solid paraffin and eupion, as well as natural and artificial petroleum, are substantially more or less impure mixtures of saturated hydrocarbons; and so it comes that, on the proposal of H. Watts, the word paraffin in scientific chemistry has been adopted as a generic term for this class of compounds of carbon and hydrogen.

When the electric light is generated within an atmosphere of hydrogen, then, at the immense temperature of the electric arc, part of the carbon of the charcoal terminals unites with the hydrogen into acetylene gas,  $C_2H_2$ . Apart from this isolated fact, which was discovered by Berthelot in 1862, it might be said that the two elements are not capable of uniting directly, although an innumerable

variety of hydrocarbons exist in nature, and can be produced artificially from organic substances. Individual hydrocarbons may differ very much in their properties. At ordinary temperature and pressure a few are gases; the majority present themselves as liquids; not a few are solids. But the solids are fusible; and all liquid or liquefied hydrocarbons, at a high enough temperature, volatilize, as a rule without decomposition. To the latter circumstance to a great extent we owe our precise knowledge of their chemical constitution.

In all the numerous series of hydrocarbons the percentages of carbon vary from 75 (in marsh gas) to 94.7 (in chrysene). Within this narrow range of some 20 per cent. several dozens of elementary compositions have to be accommodated; and many of these, to be represented in formulae  $C_xH_y$ , with an adequate degree of precision, require formulae in which the coefficients  $x$  and  $y$  are so large that, by means of integers less than these, any fancy composition (within our limits) may be expressed with a degree of exactitude which is quite on a par with the analyses. But these hydrocarbons, in general, can be volatilized into gases, and in regard to these Avogadro's law tells us that quantities proportional to the molecular weights (i.e., the weights represented by the true chemical formulae) occupy the same volume. Hence, to find the true value,  $M = C_2H_4$ , of the formula as a whole, we need only determine the vapour density, and from it calculate the weight of the respective hydrocarbon which, as a gas at  $t'$  and  $P$  millimetres pressure, occupies the same volume as, for instance,  $H_2O$  parts of steam. This is  $M$ . The elementary analysis enables us to calculate the weight  $x \times O$  of carbon contained in  $M$  parts, and the analysis must be very poor to leave us in doubt as to whether it is for instance  $6 \times 12$  parts of carbon or  $7 \times 12$  parts that we have to deal with. The reader will now understand how it has been possible to ascertain the elementary composition of all pure hydrocarbons with a degree of precision which goes beyond that of the analysis, and to prove what analysis could never have done by itself, namely, that there are numerous groups of hydrocarbons which have absolutely identical elementary compositions,—cases of isomerism, as they are called. We speak of "isomerism in the narrower sense" when the atomic formulae are identical (there are, for instance, two hydrides of butyl,  $C_4H_{10}$ ), while we speak of "polymeric" bodies when the several formulae are integer multiples of the same primitive group (e.g., ethylene,  $2 \times CH_2$ , and butylene,  $4 \times CH_2$ , are polymers to one another).

The following table gives an idea of the several classes of hydrocarbons which for us come more particularly into consideration.

n	Paraffins.	Olefins.	Acetylenes.		Benzols.
1	$CH_4$	Vacat.	Vacat.		Vacat.
2	$C_2H_6$	$C_2H_4$	$C_2H_2$	Intermediate bodies, many non-axialent; all omitted.	Vacat.
3	$C_3H_8$	$C_3H_6$	$C_2H_4$		Vacat.
4	$C_4H_{10}$	$C_4H_8$	...		Vacat.
5	$C_5H_{12}$	$C_5H_{10}$	...		Vacat.
6	$C_6H_{14}$	$C_6H_{12}$	...		$C_6H_6$
7	$C_7H_{16}$	$C_7H_{14}$	...		$C_7H_8$
8	$C_8H_{18}$	$C_8H_{16}$	...		$C_8H_{10}$
...	...	...	...		$C_8H_{12}$
n	$C_nH_{2n+2}$	$C_nH_{2n}$	...		$C_nH_{2n-6}$

The first column, under "n," gives the number of carbon atoms per molecule in the compounds whose formulae stand in that horizontal line,—these latter being arranged in a descending series according to the number of hydrogen atoms united with  $n$  atoms of carbon. Instead of pointing out these regularities, in regard to the atomic proportions in which carbon and hydrogen can unite into compounds, which the table illustrates so forcibly, let us rather state that the "benzols," in opposition to all that stands to their left in the table, are things of their own kind. In them six atoms of the carbon are most firmly united (into a "ring," as a certain theory says), and the rest, or, so to say, hooked on to the ring in a less intimate fashion. Thus benzol is  $(C_6)H_6$ ; each one of the six H's being tied to one of the six C's; toluol is  $(C_6H_5) - CH_3$ ; it is a benzol from which one of the six hydrogen atoms has been removed, and in which the gap left has been filled by a "methyl,"  $CH_3$  :—

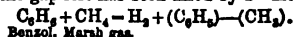

But similarly two dehydrogenated benzols,  $C_6H_4$ , can unite into one double ring of diphenyl:  $2C_6H_4 - 2H - (C_6H_4)(C_6H_4)$ ; and two benzol rings may unite more firmly in such a manner that two carbon atoms of the one ring do service for the two rings, and a double ring is formed firmly united by these two common carbons, the four hydrogens of the original two benzols being away. This gives naphthalene :—

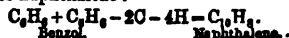

In a similar manner three benzols may unite into one anthracene:—

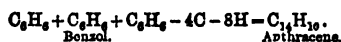

Generally speaking, a hydrocarbon is the more volatile the less the number of carbon atoms and the greater the number of hydrogen atoms in the molecule. Thus, in the series of "paraffins,"  $CH_4$  (marsh gas) and  $C_2H_6$  (ethane) are gases,  $C_3H_8$  (propane) and  $C_4H_{10}$  (butane) are very volatile liquids, and  $C_5H_{12}$ , &c., are liquids,—with higher and higher boiling points as we ascend the series. From a certain value of  $n$  upwards we find ourselves amongst the paraffins proper, which are solids, more or less easily fusible, but not, in general, volatile without decomposition. Benzol,  $C_6H_6$ , and its neighbouring homologues are volatile liquids. Naphthalene and anthracene are crystalline solids, fusible at  $79^{\circ}2$  and  $180^{\circ} C.$ , and boiling at  $217^{\circ}$  and above  $300^{\circ} C.$  respectively without decomposition.

All hydrocarbons agree in this, that they are practically insoluble in water, but more or less readily soluble (in general) in alcohol and in ether. They are all combustible; the more readily volatile ones are inflammable. Any complete combustion, of course, leads to the formation of only carbonic acid and water, with evolution of a large amount of heat; but the mechanism of the process is more or less complex. Naphthalene and anthracene remain undecomposed at a red heat; only at the very high temperature of their flames, and by the co-operation of the oxygen of the air, they are decomposed with large elimination of charcoal; a similar, though less, stability is exhibited by the benzols. The paraffins, on the other hand, are relatively unstable. Marsh gas, it is true, stands a red heat; but, to pass to the other end of the series, the paraffins proper, and also the higher liquid paraffins to some extent, even when being distilled, and especially when distilled "under pressure," *i.e.*, at higher temperatures than their natural boiling points, break up into olefines and lower paraffins (Thorpe and John Young). Similar changes take place when the vapours of paraffins are passed through red-hot tubes; only the products formed then suffer deeper-going decomposition with formation of hydrogen, marsh-gas, acetylene, ethylene, and charcoal, and, last not least, benzols and naphthalene. To this latter fact the paraffins owe their pre-eminence as illuminating agents.

When organoid minerals, such as cannel coal, shale, &c., are subjected to dry distillation, all the several classes of hydrocarbons are in general produced at the same time; but, from what we have said it will be understood that, even with the same material, the quantitative composition of the complex vapour which comes out of the retort depends on the way in which the distillation is being conducted. If we operate at the lowest practicable temperature, comparatively little gas is produced, and in the condensable part of the vapour the paraffins predominate largely; at a bright red heat, such as is used in making coal gas, and especially if the vapours have to pass along red-hot surfaces before they get into the condenser pipes, more gas is produced, and the place of the liquid paraffins is taken by benzols. These latter, however, are always accompanied by naphthalene, often also by anthracene, and invariably by certain ternary benzol-derivatives, namely, by "phenols," feebly acid bodies containing hydroxyl groups,  $OH$ , where the corresponding hydrocarbon bore plain hydrogens (ordinary phenol,  $C_6H_5(OH)$ , derived from benzol,  $C_6H_6$ , is a representative example), and, secondly, basic compounds of carbon, hydrogen, and nitrogen. Of the latter aniline and picoline—both  $C_6H_7N$ , but widely different in their properties—may be quoted as examples. The gas produced in this case through the presence in it of the vapour of higher hydrides, but especially of acetylene,  $C_2H_2$ , and

benzol is highly luminous. Supposing now, as a third instance, the distillation to be conducted at a white heat, and so that the primary vapour has to wind its way through a spiral pipe kept at a bright red heat, the proportion of gas increases largely, and there is an increased yield of retort charcoal; but the liquid hydrocarbons of all classes almost vanish; the gas consists mainly of hydrogen, marsh gas, carbonic oxide, and carbonic acid, and gives little light when kindled.

The aim of the paraffin oil manufacturer is to produce the best possible approximation to a mixture of paraffins, therefore he conducts his distillation at the lowest working temperature. Of course his paraffin mixture contains more or less of the other classes of bodies referred to, whose removal, however, offers no great difficulty. In the laboratory we should commence by shaking the crude oil with caustic alkali ley, which withdraws the phenols and other acid bodies, as part of a lower layer, the upper being purified oil. By shaking the latter with dilute sulphuric acid the bases are removed as a solution of their sulphates, and a still purer oil results. Application of concentrated sulphuric acid to the latter removes part at least of the benzols and olefines as sulpho-acids, and also of the phenols and all the bases, should the two preceding operations have been omitted. But the most thorough mode of getting quit of the benzols and their derivatives is—after having exhausted the milder agents—to shake the oil with first aqueous and then stronger and stronger nitric acid, which reagent converts the benzol-bodies into nitro-products, soluble in the acid, or removable, after separation of the acid layer, by aqueous alkali. By all these tortures the paraffins—being what the name implies—are not much affected, so that what ultimately survives all belongs to their family. The separation of the individual paraffins from one another is a very difficult problem which has not yet found a satisfactory solution. What we know of individual paraffins is derived chiefly from the investigation of decompositions of pure chemical substances leading to the formation of that one paraffin principally if not solely. To split up a mixture of paraffins approximately the only known method is fractional distillation (see DISTILLATION, vol. vii. p. 260), preferably by means of an apparatus so constructed that the vapour, before reaching the condenser, ascends through an intermediate inverted condenser or still-head, and there suffers partial condensation at some suitable temperature (enforced in the most perfect form of the apparatus by an oil-bath surrounding the still-head). In this latter case, singularly—not as a matter of course by any means—what goes over boils very nearly at the temperature of the still-head. This particular form of the method therefore lends itself chiefly for the final purification of an unitary substance of known boiling point already purified by preceding distillations. With mixtures of unknown composition the process is very tedious and may assume something like this form.

We distil the substance (slowly and with ample chance of partial condensation) and collect as separate fractions what came over at, for instance,  $100^{\circ}$  to  $105^{\circ}$ ,  $105^{\circ}$  to  $110^{\circ}$ ,  $110^{\circ}$  to  $115^{\circ}$ , &c., as I, II, III, IV, &c. Each of these when redistilled yields I and II and III and IV, &c., which parts are poured into the respective receptacles, and on this principle we continue working. If the substance happens to be of comparatively simple composition, it usually turns out, after a while, that (say) the two fractions II and VI increase while the rest get less and less; and by working on we may be able to isolate two bodies of the constant boiling points  $t_1$  and  $t_2$  respectively, with formation of "tails" of other boiling points. Unfortunately, even a constant boiling point is no proof of chemical purity; and, if a constant-boiling substance is

mixture, only chemical methods can help us out of the difficulty.

The following table (extracted from Roscoe and Schorlemmer's *Handbook of Chemistry*, German edition) gives the names, specific gravities, and boiling points of the more important paraffins. The first column, "n," gives the number of carbon-atoms in the molecule, and consequently the molecular weight M and the vapour density S. In the case of "pentan," for instance, we have  $n=5$ ; hence  $M=C_5H_{12}=72$ ; and, as  $H=2$ , the gas-density, referred to hydrogen= $S=36$ , while, as air is 14.45 times as heavy as hydrogen, for the gas-density referred to air the value

$$\frac{1}{2}M + 14.45 = 36 + 14.45 = 2491.$$

n	Name.	Boiling Point in Degrees.		Sp. Gr. of Liq. at ° C.	
		Fahr.	Cent.	d	t
1	Methan or marsh gas.....	Liquid at -11° C. and 180 atmospheres' pressure (Callotet).			
2	Ethan or dimethyl.....	Liquid at +4° C. under 46 atmospheres (Callotet).			
3	Propan.....	25° to 22°	36° to 30°	0.800	(7)
4	Butan, normal.....	+24°	+1°	(7)	
4	Isobutan or trimethylmethan, a gas.....	-1°	-17°	(7)	
5	Pentan, normal.....	69° to 105°	+37° to 36°	0.628	14*
5	Isopentan.....	26°	30°	0.638	14*
6	Tetramethylmethan.....	49°	9° S	(7)	
6	Hexan, normal.....	156°	66°	0.668	17°
6	Isohexan.....	144°	63°	0.701	0°
6	Methyl-dimethylmethan.....	140°	60°	(7)	
6	Tetramethylmethan.....	136°	58°	0.6769	10°
7	Trimethylmethan.....	108° to 118°	48° to 48°	(7)	
7	Heptan, normal.....	309°	30° S	0.7005	0°
7	Isheptan.....	198°	30° S	0.6969	0°
7	Triethylmethan.....	206°	36°	0.689	27°
7	Diethyl-dimethylmethan.....	187° to 180°	36° to 37°	0.7111	0°
8	Octan, normal.....	321°	125° S	0.7189	0°
8	Tetramethyl-butan.....	227°	106° S	0.7111	0°
8	Hexmethylmethan, fuses at 96° } to 97°	221° to 222°	105° to 106°	(7)	---
9	Nonan, normal.....	297° to 296°	147° to 148°	0.7279	15° S
9	Tetramethyl-pentan.....	270°	123°	0.7347	0°
9	Pentamethyl-butan.....	268°	120°	(7)	---
10	Decan (normal?).....	251° to 234°	166° to 169°	0.7394	15° S
10	Dimethyl-heptylmetan.....	220°	about 160°	(7)	---
10	Tetramethyl-hexan or "diamyl".....	220°	160°	0.7413	0°
11	Undecan.....	Not yet isolated.			
12	Dodecan, normal.....	296°	202°	(7)	---
13	Not isolated yet.				
14	Not isolated yet.				
15	Not isolated yet.				
16	Hexadeca-decan, normal, fuses at } +21° C.	532°	276°		

Probably all the paraffins enumerated in the table are present in paraffin oil and in petroleum; those marked \* have been actually found in the one or the other. The solid paraffins are not known as unitary chemical substances; no chemist as yet has succeeded in splitting up solid paraffin into its proximate components. The manufacturer, in regard to the liquid paraffins even, does not trouble himself with the isolation of chemical species; he contents himself with splitting up his oil into fractions corresponding to certain ranges of boiling point, and consequently adapted to certain practical applications. But even the boiling point is not much heeded industrially; the several kinds of oil are defined by their specific gravity at 60° F., which, as experience shows, increases as the boiling point rises. But it is as well here to point out that the same (initial) boiling point even, and in a much higher degree the same specific gravity, may be exhibited by oils of widely different proximate composition. Hence a relatively (and in a sense sufficiently) high specific gravity is no guarantee against dangerous inflammability; the degree of inflammability in an oil must be—and in practice always is being—determined by direct experiment. For this purpose it is not sufficient to heat a sample oil in an open vessel gradually to higher and higher temperatures, and to note the temperature at which the atmosphere over the oil proves inflammable when a lighted taper is brought in contact with it. By this method (which formerly was the universally recognized test) the most varying results may be obtained with the same oil. Far

more trustworthy is the close test first proposed by Keates about 1870, the principle of which is to heat the oil within a close vessel which is opened only from time to time to apply a light to its atmosphere. For the execution of this test many varieties of apparatus have been proposed. That adopted by Abel, and now (1884) legally recognized in Great Britain, is made of sheet copper, the exact thickness of which is prescribed for every part. The oil is placed in a close cup, suspended in an air-bath, which latter is heated by immersion in a warm-water bath, provided with an air-jacket. The top of the oil cup is pierced with three circular orifices, one in the centre for trying the best flame, and two smaller lateral holes for admitting air at the close of each trial. The holes are covered by a slide so contrived that when the central hole has become almost uncovered the lateral ones are also open. The slide carries a small colza-oil lamp suspended on trunnions, having a flame of a prescribed size. A pendulum two feet in length vibrates in front of the observer, who, in testing, withdraws the slide slowly during three vibrations, tilts the lamp to bring its flame in contact with the atmosphere of the vessel, and quickly shuts the slide during the fourth vibration. To execute a test the oil at about 60° F. is placed in the cup, which is immersed in the water-bath having water of 130° F. A thermometer plunged into the oil and another in the water-bath indicate their temperatures. When the oil has approached its presumable flashing point, trials are made at each rise of 1° F. in the temperature of the oil. The lowest temperature at which the atmosphere of the cup inflames is the flashing point of the oil tested. The legal minimum flashing point of burning oil by the close test is 75° F., corresponding to about 100° F. by the obsolete open test.

The variety of mixed paraffins which the oil-distiller produces may be arranged under the following heads:— (1) oils too volatile to be available for domestic illumination, serving chiefly as solvents; (2) burning oils, as required for house lamps; (3) oils of very high boiling point, available, and used chiefly, for lubricating purposes; (4) solid paraffin.

The products of the second class have long come to practically supersede the colza oil which used to be the illuminating oil *par excellence*. Over it they offer the advantages of greater cheapness and of giving, weight for weight, more light. But their drawbacks are that, however carefully refined they may be, they have, when allowed to leak out, or in lamps of inferior construction, a somewhat disagreeable pungent odour, and that there is always a lurking danger in the possible presence of highly volatile inflammable hydrocarbons. Colza oil will never burn without a wick; paraffin oil or petroleum may do so.

Products of the second and third classes, separately or combined, are of course available as fuels proper, i.e., for the production of heat. At the time when mineral oil was first produced in great quantity in America, the advantages it would offer as a fuel for marine boilers especially were very emphatically insisted on. Of course mineral oil can be more economically stored than coal, and its combustion-heat is susceptible of more exhaustive utilization. The latter fact forms the *raison d'être* of those beautiful petroleum kitchen-stoves and culinary lamps which are very much used on the Continent where gas is not at hand. But to talk of mineral oil as a cheap fuel for wholesale heating is nonsense. H. St. Claire Deville, about 1870, made an extensive investigation on the calorific value of American petroleum which, as we know, is pretty much the same thing as paraffin oil. He used a large apparatus, enabling him to burn several hundred litres of oil in one experiment; in fact he realized

more fully than other experimenters had ever done the conditions prevailing in the working of steam-boilers; the only difference was that he took care to collect all the heat produced in a large mass of water of known weight, and measured the heat by the increase of temperature produced in this heat receptacle. He found that even heavy Virginia lubricating oil gave not more than 10,180 units of heat (Centigrade) per unit-weight of fuel burned. But, on the other hand, in direct experiments made by Scheurer-Kestner, a coal containing 88.4 per cent. of carbon, 4.4 of hydrogen, and 7.2 per cent. of oxygen, nitrogen, and ash gave 9628 units of heat, while another coal of the same elementary composition gave 9117 units. Gas retort coke (though a far closer approximation to pure carbon) yields only 8050 units. Supposing coal yielded just that in opposition to the 10,000 units from petroleum, it is clear that the latter must not cost more than 1.25 times as much as coal weight for weight, or else it is the more expensive fuel. Take one ton of coal at 10s.; eight-tenths of a ton of petroleum is its calorific equivalent; but this weight of the oil (taking the specific gravity at 0.8) measures 224 gallons. Hence petroleum, to be as cheap as coal, must not cost more than about a halfpenny a gallon. Cheap as mineral oil is nowadays, it has not yet come down to this level.

To pass to the lubricating oil (third class), it, like the burning oil, competes with the fats and fatty oils which until lately were exclusively employed. In opposition to these it offers other and very substantial advantages besides its lower price. Good mineral lubricating oil may have such very high flashing point that it may be positively less inflammable than fatty oils or tallow; and, as a lubricant for high-pressure steam cylinders, it offers the great advantage that it is not, like fatty oils, decomposed by hot steam into glycerin and fatty acids, which latter cannot but attack the metal of the machinery to some extent. A still more important feature in mineral lubricating oil is that, even when diffused throughout a mass of cotton (or other textile) waste, it shows no tendency towards spontaneous combustion. In exhaustive experiments by Galletly and by Coleman, it was found that mineral lubricating oils diffused through textile waste do not take fire at temperatures at which even colza oil ignites, and also that fatty lubricants to which from 20 to 50 per cent. of mineral oil was added were thereby prevented from igniting.

Solid paraffin, industrially and commercially, is a substitute for the more expensive stearin as a material for candles. To this latter it is more than equivalent in light-giving power; but it offers the drawback of greater softness and lower fusing point. In practice paraffin is always alloyed with stearin to produce candles possessing the necessary degree of hardness and stability of form.

#### *The Paraffin Oil Industry of Scotland.*

In December 1847 Lyon Playfair drew the attention of the late Mr James Young, F.R.S., a Glasgow chemist, to a spring or exudation of petroleum at Alfreton in Derbyshire, and induced him to lease the spring, with the view of turning the material to commercial advantage. In 1848 Mr Young commenced the purification and preparation from this petroleum of two varieties of oil—*one, thick, for lubricating, the other, thin and limpid, for burning in lamps.* It was found that this crude petroleum contained paraffin in notable proportion; but the solid paraffin was not separated for trade purposes, and that body continued still a simple chemical curiosity. Within two years the quantity of petroleum yielded by the spring began to decrease, and in the beginning of 1851 it was practically exhausted, and the business there ceased. Meantime it had occurred to Mr Young that the petroleum he was working might have been produced by the action of heat on the underlying coal; and, under the impression that it might be possible by artificial means to produce a similar substance, he began an extensive series of experiments on the destructive distillation of coal. As the result of a long-con-

tinued investigation in this direction, with many varieties of coal, Mr Young in October 1850 secured a patent for the manufacture of paraffin and paraffin oil from bituminous coal, which patent became the basis of the new industry. "The coals," the patentee says, "which I deem to be best fitted for the purpose are such as are usually called parrot coal, cannel coal, and gas coal, and which are much used in the manufacture of gas for the purpose of illumination." Early in 1850 Mr Young's attention was called to the Boghead mineral, which he found to be of all the substances experimented upon the most promising for his purpose. That circumstance determined Mr Young and his original partners to set up their works at Bathgate in the region of the Boghead mineral, where consequently, in 1850, the necessary buildings and plant were erected, and manufacturing operations were begun in 1851. In 1853 a lawsuit of great importance, which turned on the scientific question "What is coal?" took place between the proprietor of a portion of the Boghead mineral and his mineral tenant, who was entitled to work coal only. The proprietor averred that the mineral in question was not coal; but, after a great amount of scientific evidence on both sides had been heard, the decision was that the substance came, so far as regarded the purposes of the lease, within the definition of coal. Had the issue of the case been in favour of the proprietor of the mineral, Mr Young's patent would have been practically valueless, for he claimed only the distillation of bituminous coal. The distillation of mineral schists or shale at a low red heat had, moreover, been previously patented by Du Buisson; and the only raw materials which have been used to any extent in the Scottish industry are the Boghead mineral and subsequently bituminous shale.

The essential feature of Young's invention was the distillation of bituminous substances at the lowest temperature at which they could be volatilized to a practically sufficient extent. In practice it was found that a temperature of 800° F. is the point about which the best results are obtained.

The material exclusively distilled in the early years of the industry in Scotland was the Boghead cannel or Torbanehill mineral. The supply of this mineral was limited, and, as its value for gas-making as well as for oil-distilling was very great, it rapidly advanced in price from 13s. 6d. per ton, at which it was contracted for when the Bathgate works began operations, till it rose to 90s. per ton before its final disappearance from the market about 1866. As early as 1859 the bituminous shales which are found in the Scottish Carboniferous formation began to attract attention as a possible source of raw material for the industry, and in that year a seam was experimentally opened up at Broxburn, Linlithgowshire. In 1861 a shale oil work was established at Gavieside, West Calder, and by the period of the expiry of Young's patent in 1864 several works distilling shale were in operation. But, while from the Boghead mineral from 120 to 180 gallons of crude oil were obtainable for every ton distilled, the ordinary bituminous shales yield at most only 35 gallons per ton; and even with the improved methods of working in use at the present day the average yield of crude oil from shales is not more than 82 gallons per ton.

The bituminous shales of Scotland are found in a wide belt of the Carboniferous formation, extending from Ayrshire in a north-easterly direction to the Fife coast. In Ayr and Renfrew they are found to some extent in the true Coal-measures; but, generally, and especially in the east, they are obtained in the Lower Carboniferous series. These oil shales consist of fissile argillaceous bands, highly impregnated with bituminous matter. As a rule the shale of the west country yields a high percentage of crude oil, but the Linlithgow, Midlothian, and Fife shales produce oils comparatively rich in lubricating oil and solid paraffin, the most valuable product of the industry. The ordinary Broxburn shale contains 17 per cent. of bituminous volatile matter, and leaves 76 per cent. of spent shale (char) on distillation. In contrast with this is the composition of the Boghead mineral, which contained not less than 65 per cent. of volatile bituminous matter and only 22 per cent. of ash.

In the early years of the industry at Bathgate, the two classes of oil—*heavy (lubricant) and light (illuminating)*—were the products to which attention was principally directed. Paraffin was separated from the heavy oils; but the demand for it was at first small, and many difficulties had to be overcome before candles consisting principally of that body could be favourably brought into the market. With the increased knowledge, improved methods, and eager competition of the present day, the range of products has largely extended, and almost everything obtainable from the shale, except the incombustible ash, is turned to profitable account. The commercial products embrace sulphate of ammonia, illuminating and heating gas, gasoline and naphtha, highly volatile oils, several grades of burning oil and of lubricating oil, heavy green oil used for making oil gas, and solid paraffin. The sequence of manufacturing operations has not changed in any essential particular since first established by Young; but at every stage and in all the appliances numerous and important modifications have been, and continue to be, actively introduced, all tending to greater economy of work, increase of production, and improvement of the quality and variety of commercial products.

*Manufacturing Operations.*

The manufacture divides itself into two distinct sections:—(1) the crude works, dealing with the preparation and distillation of the shale and with the production of crude oil and the collateral products

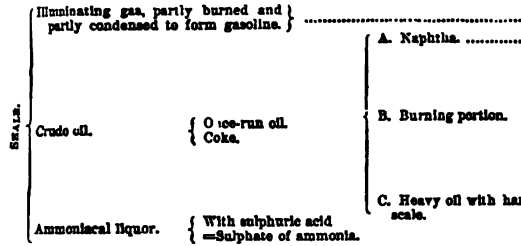

—illuminating gas, gasoline, and ammonia; and (2) the refinery in which the crude oil is purified and separated or split up into the considerable range of commercial products obtainable from it. The following table shows the stages through which the various products are derived from shale:—

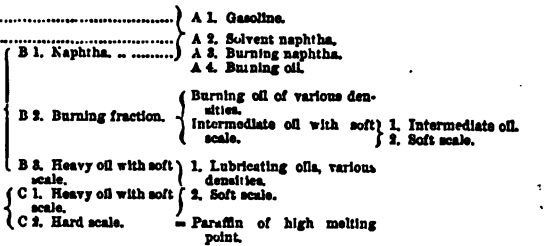

*Crude Works.*—Bituminous shale as brought from the pits is passed through powerful toothed cylinder machinery, reducing it to fragments not larger than a man's fist. In this state it is conveyed in hatches to the retorts, in which it undergoes destructive distillation—the distinctive operation under Mr Young's patent. The retorts used have undergone many and important modifications. Originally, as was natural, horizontal retorts arranged in benches, in all respects like gas retorts, were employed, but these in the Scottish trade very quickly gave way to the vertical retort. The form of vertical retort originally in general use consisted of a cast-iron cylinder, circular or oval in cross section, 8 or 10 feet in height and about 2 feet in diameter, or equivalent thereto. It tapered at the top, where it was provided with a hopper for charging the material to be distilled and a valve for closing the retort mouth. The bottom end dipped into a trough of water, forming an efficient lute, and effectually preventing the escape downwards of any of the gaseous products of distillation. These retorts were arranged in linear benches of six, three on each side of a furnace fed with coal, the heat from which passed to each side into the chamber or oven in which the retort stood. The distilled vapours passed away by a pipe at the upper end of the retort, their emission being aided by a jet of superheated steam injected at the bottom. The distillation in these retorts was continuous, a portion of spent shale being withdrawn through the water in the trough every hour or thereby, and a corresponding amount of fresh shale being added by the hopper.

As competition with American petroleum increased, the efforts of manufacturers were directed to cheapening the distilling process, by utilizing the spent shale from the retorts in its hot condition as fuel for distilling the succeeding charge. The difficulties in the way of accomplishing this were very great, chiefly on account of the large proportion of ash in the coked residue, amounting to from 85 to 90 per cent. of the whole. To use spent shale so poor in carbon it was essential that it should be dropped into the furnace direct from the retort without exposure to the air, and this was first successfully accomplished by the improved retorts and furnace patented by Mr Norman M. Henderson in 1878. According to the Henderson system, which has been adopted in the more important Scottish oil works—a series of four vertical retorts are arranged in quadrangular order over a common fire-chamber or furnace; the bottom ends of the retorts are provided with doors capable of being closed gas-tight; and immediately below each door there is a valve which, in one position, and while the charge is being distilled, entirely cuts off the retort bottom from the furnace or fire-chamber, leaving the retort bottom exposed to the external air, but when the retort charge has been exhausted of oil, and is about to be passed into the furnace as fuel, the valve can be turned over outwards, in which position it forms an inclined shoot contiguous to the bottom of the retort and the fire-chamber. The door-closing at the bottom of the retort having been first withdrawn, and the valve drawn back, the contents of the retort pass freely into the furnace, where their combustion is at first assisted by a jet of the incondensable inflammable gas given off by the retorts themselves.

Each Henderson retort can contain about 18 cwt. of shale. The four retorts forming a set are being cleared in rotation at intervals of five hours, so that each charge suffers distillation for twenty hours. The temperature is kept at about 800° F., this giving the best results. The vapour produced in the retort is led off by a pipe issuing from near the bottom, and, in order to avoid unnecessarily prolonged sojourn of the vapour in the hot vessel, a jet of superheated steam is constantly made to stream in above and guide the vapour downwards. The vapour, which amounts to about 3000 cubic feet per ton of shale distilled, is passed through a system of condensing pipes, communicating below through a properly divided horizontal chest, like that used in gas works for the condensation of the tar. From the last compartment of the condenser the still uncondensed gas is drawn away by a fan or other "exhaust" through a set of "scrubbers." In the first of these the

gas is washed with water and thus stripped of what it still contains of ammonia; in the succeeding ones it is washed with heavy oil which withdraws a considerable portion of the vapours of the more highly volatile hydrocarbons which are diffused throughout it. From this heavy-oil solution the absorbed hydrocarbons are extracted by distillation as "naphtha." The gas, after having thus been freed from its more readily condensable parts, is either led away into gas-holders to be utilized as illuminating gas or used directly as a fuel. (see above). The product which collects in the condenser chests consists of crude oil (about one-fourth of it) and a weak aqueous solution of ammonia and volatile ammonia salts, containing from 5 to 5 per cent. of real ammonia, NH<sub>3</sub>, which, however, in all cases represents only a small percentage of the potential ammonia which was contained in the original shale in the form of nitrogenous carbon compounds. In the golden days of paraffin oil making this ammonia liquor was simply allowed to go to waste; but when the American petroleum began to depress the prices of the oils the manufacturer saw the propriety of working up the liquors for sulphate of ammonia by the same methods as are employed in connexion with the coal-gas industry (see NITROGEN, vol. xvii, p. 519). And as, during the last decade or two, the demand for ammonia has been steadily increasing, the ammonia in the shale industry by and by rose from the rank of a minor collateral to that of one of the principal products, and a number of attempts have been made to recover that part of the nitrogen which, in the ordinary process, is lost as a component of the coke. Dr H. Grouven proved (1875-77) that all nitrogenous organic or organoid matter when exposed to a current of steam at about 1000° C. burns into carbon oxides, hydrogen, and ammonia, the last-named including all the nitrogen. Messrs G. T. Beilby and William Young have worked out and patented a process for discounting this fact in the shale industry for a more exhaustive extraction of the ammonia. In one of the later forms of the process the shale is being distilled in retorts standing over a fire-brick chamber surrounded by flues and kept at a far higher temperature than the retorts themselves. The coke from the retorts is discharged straight into this chamber, and therein exposed to a mixed current of steam and air, which burns away the carbonaceous part into carbonic acid, carbonic oxide, hydrogen, and ammonia. The large mass of hot gas thus produced passes next through the retorts above to aid in the distillation, and conjointly with the retort vapour is subjected to systematic successive condensation. The incondensable gas which is ultimately obtained includes all that the gas from the ordinary process contains, and also a large proportion of hydrogen and carbonic oxide from the hot-chamber process. It serves as a fuel for heating the chamber and the retorts; but, as it does not furnish quite enough of heat for all this, a combined retort and gas-producer is built into the bench with the shale retorts. This supplementary apparatus is charged with coal, which, in it, is first distilled, then converted partially into gas by steam and at last completely by a regulated current of air. The gas from the first and second stages is scrubbed to strip it of its ammonia and tar, and then, conjointly with the gas from the third, used as a fuel for the retorts. In this way the advantages of gas-firing are secured at little expense, as the condensed products are nearly equivalent in money value to the coal consumed. In the Young-Beilby process, which is extensively used in Scottish works, the yield of ammonia is on the average double, and in special cases five times, that obtained in the ordinary process of distillation.

*The Working of the Oil.*—The composition of the crude oil is very variable (see above). It generally forms a very dark green, almost black, liquid, somewhat tarry in appearance, and endowed with a highly unpleasant empyreumatic odour. The specific gravity ranges from 0.862 to 0.895. Each ton of shale distilled yields on an average 80 gallons of crude oil (about 260 lb), 700 lb of coke, gas, and loss, and 1270 lb of cinders. The crude oil on refining yields 88 to 44 per cent. of oils available as "spirit" or for burning, 15 to 20 per cent. of lubricating oil, and 9 to 12 per cent. of solid paraffin.

**Refinery.**—The first operation in oil refining consists in submitting the crude oil to distillation in large pot-shaped stills capable of holding 1200 or 1400 gallons. The distillation is continued till only a pure vesicular coke remains in the still, and the vapours (condensed by the ordinary worm-pipe arrangement) constitute "once-run oil," which from its bright green colour is also known as green oil. The once-run oil is the material from which, by a repeated series of washings with sulphuric acid and caustic soda and fractional distillations, the graduated series of purified products is finally obtained.

**Washing.**—Once-run oil contains a series of basic and acid components. To separate these the oil is first repeatedly treated with sulphuric acid of different degrees of strength, which is thoroughly intermixed and brought in contact with the oil by mechanical means in an agitating tank or washer. The acid first used is a weak tarry acid which has been already used in a subsequent stage of the manufacture. This produces a copious tarry deposit, which is removed; the process is repeated with a similar result; and thereafter the oil is further treated with two successive washings of strong vitriol. After settling and removal of the precipitated tar, a similar series of washings with caustic soda solutions of increasing strength, and corresponding precipitation and removal of tars which combine with the alkali, are carried out. During both the acid and the soda treatments the oil is maintained at a temperature of about 100° F. by the circulation of steam through the tanks in coiled pipes. The sulphuric acid tars are to some extent used as fuel in the fractionating stills.

**Fractional Distillation.**—The purified once-run oil is a very mixed substance, giving off vapours within a wide range of temperatures, which condense into products of varied specific gravity. By the series of fractional distillations to which it is submitted a series of products are ultimately obtained comparatively homogeneous in constitution, which distil within relatively narrow limits of temperature. The ordinary method of fractionating once-run oil consists in running it into large cylindrical boiler stills heated by furnaces in which the acid tar already spoken of is consumed. The stills have led into them steam-pipes, through which steam is injected into the oil in process of distillation as required. When the heat is first raised, superheated steam is injected to aid in carrying off the lighter vapours, which are condensed as naphtha or "spirit." As the distillation proceeds, and the gravity of the condensed product increases, it is run into separate receivers, and thus a series of fractionated intermediate products is produced, the first portion up to 0.750 specific gravity being naphtha, while from 0.750 to 0.850 is the burning oil portion, and the subsequent portion separated is heavy oil containing paraffin. The portion remaining in the still is removed to the residue stills, in which it is distilled till the still contains only coke. The oil driven off from the residue stills is called "heavy oil and paraffin," and passes to the paraffin house for treatment there.

**Improved Fractionating Stills.**—Many attempts have been made to adapt the fractionating still to a system of continuous working by keeping the contents at a constant level as the distillation proceeds. For a long period continuous distillation was only imperfectly applicable, and yielded unsatisfactory results. The lighter fractions alone were driven off, and as the distillation progressed the density of the contents of the still gradually increased, making the difference between the oil added to the still and that within it increasingly great. In the end the contents of the still had to be removed and completely distilled as one charge in a separate still. In 1888 Mr Norman M. Henderson, the patentee of the Henderson retort, patented a continuous process of distillation which completely obviates all difficulties, and largely reduces the time, labour, and cost of fractionation as compared with the ordinary intermittent method. According to Henderson's system, purified once-run oil is fractionated continuously in a connected series of three cylindrical stills. Each still is fitted with inlet and outlet pipes, the mouths of which opening upwards are placed at opposite extremities of the still. The outlet pipe of No. 1 passes as inlet into No. 2, and similarly outlet of No. 2 is connected as inlet with No. 3, while the outlet of No. 3 passes into one or more common residue stills. The inlet or feed pipe of No. 1 traverses the long horizontal condensing pipes of the whole three, and thus the once-run oil, while absorbing heat before entering No. 1 still, also aids the condensation of the vapours. In working there is a constant feeding of heated once-run oil into No. 1 still, a like steady flow from No. 1 to No. 2, from No. 2 to No. 3, and from No. 3 to a residue still. The oil of course increases in density as it passes onwards; but the specific gravity in each still is practically constant, and, as the heat applied is increased in proportion to the gravity, the oil vaporized in each separate still is of uniform quality and specific gravity. In No. 3 still, where, in consequence of the high gravity and temperature, there is a tendency to deposit carbonaceous matter, circulating plates or dishes hinged to each side of the still, and concentric to the bottom shell, are placed. The circulation of the oil from the bottom up the sides in the space between the shell and the circulating plates is directed and assisted by jets of steam from a pipe laid

along the bottom of the still. In this way the oil is kept in steady circulation up the sides and down the centre, and any deposit of coals which may take place forms on the inner surface of the circulating plates, from which there is provision for its easy removal when required.

The manufacturer has now his material split up into three products—naphtha, burning oil, and heavy oil with paraffin. By renewed treatments with acid and alkali and fractional distillations, these products are further purified and differentiated. We cannot go into technical details, and in regard to the principles upon which the processes are founded reference may be made to what has been said above in connexion with corresponding laboratory methods. As a final result the following products (or a similar series of other products) are produced and sent out into the market:—

1. Gasoline: a mixture of paraffins, so volatile that a current of air by being passed through it at ordinary temperature is converted into combustible (non-explosive) gas.

2. Naphtha: a mixture of hydrocarbons which in volatility and otherwise are equivalent to the crude benzol of the coal-gas industry.

3. Burning oil: a mixture of oils sufficiently volatile and light to be suitable for combustion in domestic lamps with wicks, and yet practically free of dangerously volatile inflammable components.

4. Heavy oil, corresponding to a range of very high boiling points: too heavy or viscid to be raised by the wick of a lamp, but well adapted for lubricating purposes. This part contains the solid paraffin which the manufacturer takes care to extract as completely as possible before the oil is sold as "lubricating oil." The several kinds of crude paraffin extracted are classed as "hard scale" or "soft scale," according to their fusing points and consequent degrees of hardness at ordinary temperatures.

**Separation of Hard Scale.**—The heavy oil forming the last of the three portions into which once-run oil is fractionated, at ordinary atmospheric temperatures, becomes thick and pasty by the abundant formation of crystals of solid paraffin. This mixture of oil and paraffin is separated by draining through canvas bags, or, as is now the almost universal practice, by passing the magma into a filter press. This apparatus contains a series of thirty or forty perforated plates about 2 feet square, the faces of which are covered with filtering canvas. They are screwed up together in an oblong horizontal frame, so that a space or chamber about an inch wide is left between each pair of plates. Into these chambers the pasty mixture is forced under high pressure, the material passing into and filling each chamber through an orifice in the centre of the plates till the whole of the chambers are filled. The pressure being kept up, the fluid oil exudes through the canvas and perforations in the plates, leaving solid paraffin, which continues to accumulate till the chambers are filled with it in a comparatively dry condition. The soft cake from the filter press is further squeezed in canvas in a hydraulic press giving off more fluid oil, and the cake from this pressure consists of commercial hard scale or crude paraffin.

**Soft Scale.**—The heavy oils separated in the second and third fractionation of burning oils, and the oil from which the above hard scale is separated, hold dissolved in them paraffin of low melting point, which can only be crystallized out by bringing the oil to a very low temperature. For this purpose the oils are reduced to from 18° to 20° F. by artificial refrigeration. The method now employed consists in sufficiently cooling a continuous current of brine or of chloride of calcium solution by passing it through an ether refrigerating machine. This cold current of brine circulates through the interior of a large cylinder or drum, which revolves slowly, dipping into a trough containing the oil to be cooled. The cold surface of the drum in contact with the oil takes on a deposit of solid paraffin crystallized out of the mixture. It is removed by scrapers and made to fall into a separate receptacle, whence it goes to the filter press and the hydraulic press in the same way as the hard scale.

**Lubricating Oil.**—The oil from which hard and soft paraffin are separated as above stated exhibits a blue fluorescence, and is hence called blue oil. It receives an acid and soda series of washings, after which it is submitted to fractionation. The first portion given off, up to about 0.850 specific gravity, is transferred to the burning-oil series, with which it is mixed for further treatment. The remainder is received as various grades of lubricating oil, with specific gravity ranging from 0.860 to 0.890. These heavy oils are again refrigerated, yielding a further crop of soft scale, after which they get a final acid and alkali treatment, and are finished for use by having steam blown through them for a prolonged period, the effect of which is to reduce greatly their objectionable smell. Finally they are kept in warm settling tanks at a temperature of not less than 90° F. for eight or ten days, when they are ready for the market.

Occasion has already been taken to name the advantages which this kind of mineral oil offers as a lubricating agent. Let us now add that it cannot quite take the place of fatty lubricants, lacking the degree and kind of viscosity which fits these for certain purposes. A mixture of fatty and mineral oil in proper proportions is often found to work better than either component would by itself. As mineral oil is far cheaper than all the fatty oils, it is largely used as adulterant of these. Such adulteration can



often be detected without the aid of chemical tests; all heavy mineral oils exhibit a characteristically strong blue fluorescence, which becomes rather more prominent by the presence of fatty oil. Manufacturers, however, have learned to remove the fluorescence by the addition of certain chemical substances, and large quantities of such "bloomless" oil are being sold and used as colza or other fatty oil.

**Paraffin Refining.**—The crude paraffin which remains to be dealt with consists of soft scale, melting point between 90° and 105° F., and hard scale melting between 115° and 120° F. The greater part of the soft scale is disposed of in the crude state for impregnating match splints in lucifer-match making. The remainder, hard and soft, is purified by an acid and soda treatment, and decolorized by repeated washings with solvent naphtha. To this end the scale is melted, mixed with 25 per cent. of naphtha, cooled down, and thus caused to crystallize, and subjected to hydraulic pressure. The solvent naphtha is thus squeezed out, and this series of operations is repeated two or three times. Each of the mother liquors produced is utilized as a purifying agent for the paraffin of a preceding stage of purity, so that it at last arrives at and serves for the original crude scale.

In its progress through these washings the naphtha takes up much heavy oil and solid paraffin, which are extracted by systematic fractionation and crystallization. The paraffin, after its last squeezing, is a dull chalky-looking white mass strongly impregnated with naphtha, to drive off which it is melted and has a current of steam blown through it, till no trace of naphtha odour comes away with the steam. The ultimate decolorization is effected by mixing the heated paraffin with animal charcoal, allowing the charcoal to settle, and drawing off the paraffin through filters. The molten paraffin flows into oblong tins which mould it into the beautiful translucent blocks used for candle making and the several other purposes to which paraffin is applied.

The soda-tar obtained in the various processes is to some extent collected and treated for the recovery of a soda sufficiently pure to be used in the first stages of purification of the crude oil. It is also employed to neutralize the acid tar, after which both are distilled, yielding as a bye-product an oil known as "green oil," largely used for the manufacture of oil-gas under Pintsch's patent.

**Commerce.**—The development of the paraffin industry under Young's patents, and the rapid increase of demand for the products, led directly to the rise of the great petroleum industry in America. The United States acting commissioner of patents, Mr John L. Hayes, in reporting on Mr Young's claim for an extension of his patent rights, states that "the manufactures of coal oil in this country had their origin in Mr Young's discovery. The use of petroleum followed so directly and obviously from the use of coal oils that it can hardly be denied that the one originated from the other." The petroleum industry once started, however, grew with so startling rapidity, and attained such gigantic proportions, that it threatened the entire extinction of the parent manufacture. In the early days of the trade a considerable development of manufacturing activity took place in Wales, where an inferior kind of cannel coal was distilled; and at many localities in Germany brown coal and sometimes peat were utilized as the raw materials of a considerable industry. The pressure of the competition with American oil was felt severely by all, and it was only with much difficulty that the great Scottish companies succeeded in holding their own, and in carrying on a constantly extending production. The Welsh industry was practically extinguished, and the production in Germany, notwithstanding the imposition of high protective duties, was greatly circumscribed. The chief seats of the manufacture in Germany are now in Saxony, near Weissenfels, where a peculiar variety of lignite called "pyropisite" forms the raw material for distillation.

In the Scottish industry there was in the middle of 1884 about £2,000,000 of capital invested, the working capacity of works in operation being equal to the distillation of 4170 tons of shale a day, while plant is being provided to increase that capacity to 5920 tons. The following table represents the present output of a year of 312 working days.

	Actual.	In View.	Total.
Scale distilled per day, tons.....	4,170	1,750	5,920
Scale distilled, tons.....per annum	1,301,040	548,000	1,849,040
Crude oil produced, gallons. "	29,081,900	16,880,000	45,961,900
Burning oil and spirit, in barrels of 40 gallons.....	400,070	167,895	567,965
Lubricating oil, tons (of about 226 gallons).....	24,490	10,277	34,767
Paraffin scale, tons.....	13,334	6,435	19,769
Sulphate of ammonia, tons....	10,454	4,388	14,842

(W. D.—J. P. A.)

**PARAGUAY,** a South American republic situated in the basin of the Parana-Paraguay system, between 22° and 27° 35' S. lat. and 54° 35' and 61° 40' W. long. It is continuous with Brazil, Bolivia, and the Argentine

Republic, and its boundaries were long under dispute. The Argentine Republic especially laid claim to a portion of the Gran Chaco to the north-east of the Pilcomayo; but in 1878 the president of the United States (to whose arbitration the matter had been submitted) decided in favour of Paraguay.<sup>1</sup> The town of Villa Occidental, on the Gran Chaco side of the Paraguay river, opposite Asuncion, has since been called Villa Hayes. The whole area of the country is estimated at 91,980 square miles, of which 35,280 are in the Gran Chaco portion.

Paraguay proper, or the country between the Paraguay and the Paraná, is traversed from north to south by a broad irregular belt of highlands which are known as the Cordillera Amanbaya, Cordillera Urucury, &c., but partake rather of the character of plateaus, and form in fact a continuation and outwork of the great interior plateau of Brazil (Keith Johnston, jun.<sup>2</sup>). The elevation nowhere much exceeds 2200 feet. On the western side these highlands terminate with a more or less sharply-defined edge, the country sloping gradually up to their bases in gentle undulations with open ill-defined valleys; on the eastern side they send out broad spurs enclosing deep-cut valleys, and the whole country retains more of an upland character. The tributaries that flow westward to the Paraguay are consequently to some extent navigable, while those that run eastward to the Paraná are interrupted by rapids and falls often of a formidable description.<sup>3</sup> Apart from the central highlands there are several plateaus and knots of hills in the west between 25° and 26° 20' S. lat. The plateau on the edge of which Asuncion is built has a relative height of about 200 feet, and skirts the Paraguay for about 25 miles with red sandstone cliffs; to the north of this is the Altos Cordillera, with a relative height of 600 feet. From the Asuncion plateau southwards, near the confluence of the Paraguay and Paraná, there is a vast stretch of marshy country draining partly into the Ypoa lagoon; and smaller tracts of the same character are found in other parts of the lowlands, especially in the valley of the Paraguay. The country sloping to the Paraná is nearly covered with dense and well-nigh impenetrable forest, and has been left in possession of the sparsely-scattered native tribes. On the other hand the country sloping to the Paraguay, and comprising the whole of the properly settled districts, is, in keeping with its proximity to the vast plains of the Argentine Republic, grassy and open, though the hills are usually covered with forest, and clumps of trees are frequent in the lowlands. Except in the marshy regions already mentioned and along the rivers the soil is dry, porous, and sandy, produced by the weathering of the red sandstone, which is the prevailing formation throughout the country.

The year in Paraguay is divided into two seasons,— "summer" lasting from October to March, and "winter" from April to September. December, January, and February are generally the hottest months, and May, June, July, and August the coldest. The most temperate month is April. The mean temperature for the year seems to be about 75° or 76°; for summer 81°, for winter 71°. The rainfall, amounting to 58 inches at Asuncion, is distributed

<sup>1</sup> By the treaty of 1872 the Brazilian frontier was drawn up the Paraná from the mouth of the Y-Guaru (26° 30' S. lat.) to the Salto Grande or Great Cataract of La Guayra (24° 7'), thence west along the watershed of the Sierra de Maracayú, north along the Sierra de Amanbaya to the sources of the Apa, and down that stream to its junction with the Paraguay. The Buenos Aires treaty of February 3, 1876, fixed the frontier between Argentina and Paraguay, and assigned to Paraguay the portion of the Gran Chaco between Rio Verde and Bahia Negra; the appropriation of the portion between Rio Verde and the Pilcomayo was left for after consideration.

<sup>2</sup> See his papers in the *Academy*, 1875; *Proc. R. Geogr. Soc.*, 1876; and *Geographical Magazine*, 1876.

<sup>3</sup> In regard to the rivers, compare the article PLATE RIVER.

over 84 days,—75 days being cloudy and 206 bright and clear. In the five years 1877–81 only 50 frosts were observed, and of these 17 fell in August. The wind blows from the south on 118 days, and from the north on 103; while from the east it blows only 44 days, and from the west only 3. Neither north nor south appears to obtain any definite mastery in any month or season. The south wind is dry, cool, fresh, and invigorating, and banishes mosquitoes for a time; the north wind is hot, moist, and relaxing. Violent wind-storms, generally from the south, average sixteen per annum. Goitre and leprosy are the only endemic diseases; but the natives, being underfed, are prone to diarrhoea and dyspepsia.<sup>1</sup>

The fauna of Paraguay proper is practically the same as that of Brazil. Caymans, water-hogs (*capincho*), several kinds of deer (*Cervus paludosus* the largest), ounces, oposums, armadillos, vampires, the American ostrich, the ibis, the jabiru, various species popularly called partridges, the *pato real* or royal duck, the *Palamedea cornuta*, parrots and parakeets, are among the more notable forms. Insect life is peculiarly abundant; the red stump-like ant-hills are a feature in every landscape, and bees used to be kept in all the mission villages.

As to the mineral resources of Paraguay but little is known—possibly because there is little to know. The gold mines said to have been concealed by the Jesuits may have had no existence; and, though iron was worked by Lopez II. at Ibicuy (70 miles south-east of Asuncion), and native copper, black oxide of manganese, marbles, lime, and salt have been found in greater or less abundance, the real wealth of the country consists rather in the variety and value of its vegetable productions. Its forests yield at least seventy kinds of timber fit for industrial purposes,—some, such as the lapacho and quebracho, of rare excellence and durability, as is shown by the wonderful state of preservation in which the wood-work of early Jesuit churches still remains. Fifteen plants are known to furnish dyes, and eight are sources of fibre—the caragatay especially being employed in the manufacture of the exquisite flanduty or spiderweb lace of the natives. Fruit trees of many kinds flourish luxuriantly; the cocoa palm often forms regular groves, and the orange tree (reaching a height of 50 feet) is so common and bears so profusely that oranges, like bananas, have a mere nominal value. In the MATÉ (*q.v.*), or Paraguayan tea, Paraguay has a commercial plant of great importance, which may be said to be peculiarly its own; and most of the primary crops of the tropics could be cultivated with ease if there were only men and means. Paraguay tobacco is prized in all the La Plata countries, and, as men, women, and children all smoke, there is a large home consumption; but only a small quantity finds its way to Europe, under other names; coffee (though the berry is of excellent quality, if slightly bitter) is even more neglected; sugar is grown only for manufacture into rum and syrups, and loaf-sugar has to be imported from Brazil; and, although the whole population is clothed exclusively in white cotton stuffs, and cotton grows almost spontaneously in the country, English goods burdened by a duty of 40 per cent. keep the market. Wheat, oats, and rice can all be raised in different districts, but the dietary staples of the Paraguayans are still, as when the Spaniards first came, maize and mandioca (the latter the chief ingredient in the excellent *chipa* or Paraguayan bread), varied it may be with the seeds of the *Victoria regia*, whose magnificent blossoms are the great feature of several of the lakes and rivers. Cattle-breeding was formerly a very important interest in several of the departments, but the stock was nearly all destroyed during the

war, and is only being slowly recruited from the Argentine Republic. The total number of horned cattle is estimated at 500,000. Land may be purchased from private owners for from £160 to £200 per square league of 4500 English acres, but the Government rate amounts to £900 or £1000.

The inhabitants of Paraguay are mainly Guaranis or half-breeds with a strong proportion of Guaraní blood.<sup>2</sup> A peaceful, simple people, fond of flowers and fêtes, they displayed during the desolating wars of 1865–70 (as so often before in the time of the Jesuits) indomitable courage in the face of overwhelming odds. Trustworthy figures in regard to the population can hardly be said to exist. A so-called census for 1879 gives a total of 346,048, which is probably not far from the truth. The female births being always in excess of the male, and most of the full-grown men having perished in the wars, the females form about two-thirds of the whole. Of the foreign residents in 1879, about 4000 were Italiani, 400 Germans, 400 Spaniards, and 40 English. Formerly, about 1857, divided into twenty-five departments, the country was in 1876 distributed into twenty-three electoral districts, each with a *gobernador*, a *juaz de paz*, and a municipality. ASUNCION (*q.v.*), the capital, is also the largest city (40,000 in 1857, 16,000 in 1879). Other places of present or historical importance are Villa Rica (12,570 in 1879), often called Villa Pobre, the chief seat of the tobacco trade, and the easternmost of the larger towns; Villa Pilar or El Pilar (3722), formerly Neembuc, opposite the mouth of the Bermejo, and the "strangers' farthest" under Dr Francia's despotism; San Estanislao (7453); San Pedro (9706), near the Tejuí, about 3 leagues from its junction with the Paraguay; Concepcion (10,697), the northernmost of the towns or villages, 200 miles above Asuncion, and the trading centre for the northern maté plantations; Humaitá (3868), 198 miles below the capital, the site of the great earthworks by which Lopez stopped the advance of the allies for more than a year; Paraguari (5315), the present terminus of the railway; Jaguaron (3418), 24 leagues from Paraguari, founded in 1586, and the seat of a manufacture of orange-flower essence; Ita (6832), known for its earthenware; Itanguá (6948), with brick and tile works; Luque (8878), the provisional capital in 1868; Villa Hayes (Villa Occidental, Nouvelle Bourdeaux), 10 miles above Asuncion, founded in 1854 by Lopez with French settlers.<sup>3</sup>

Paraguay is a constitutional republic. The president and vice-president hold office for four years, and are again eligible after eight years. The legislative bodies are a chamber of deputies (one deputy from each 6000 inhabitants) and a senate (one senator from each territorial division with 8000 inhabitants, and beyond that from every 12,000 inhabitants). There are five Government departments, and a supreme court of three salaried judges. The people are nominally Roman Catholics, but full religious liberty prevails. Crime is comparatively rare, and is rapidly diminishing. Marriage has fallen so completely out of fashion that only 3 per cent. of the births are legitimated. Education is technically compulsory; but the 178 schools were in 1879 attended only by 5862 boys and 920 girls. There is only one public library (3000 vols.) in the country. The army, which, when Lopez II. ascended the throne, numbered 12,000 men, but with a reserve of 46,000, is now reduced to 500 men; every able-bodied citizen is under obligation to serve in case of need. There is but one war-steamer, of 440 tons burden. The only railway is the line (45 miles) from Asuncion to Paraguari, which was begun by Lopez I. in 1859, and surveyed as far as Villa Rica. It was bought for £100,000 by a joint-stock company in 1877. The double run, occupying twelve hours, is performed four times a week. The general trade of the country has begun to revive: from £131,493 in 1876, the value of the imports rose to £258,000 in 1881, and the exports from £68,577 to £385,700. Among the exports (all duty free) there appeared in 1881—maté, £182,025; dry hides, £23,345; tobacco, £131,780; 20,009,597 cigars, £4302 (about seventeen a penny); 47,917,700 oranges, £9583; and hard woods, £3842. The customs furnish nearly four-fifths of the national revenue (not much more than £100,000 in 1881). Previous to the war there was no national debt. In 1871 and 1872 two foreign loans (nominally £1,000,000 and £2,000,000) were contracted through Messrs Robinson, Fleming, & Company, London, and hypothecated on the public lands of Paraguay, valued at £19,380,000. Apart from the war debt of more than £45,000,000, the official statement for 1882 recognizes a foreign debt of £3,463,000.

History.—In 1528 Sebastian Cabot, following in the footsteps of De Solis, reached Paraguay and built a fort called Santo Espiritu. Asuncion was founded on August 15, 1537, by Juan de Ayolá, and his successor Martínez de Iraia determined to make it the capital of the Spanish possessions east of the Andes. From this centre Spanish adventurers pushed east to La Guayra beyond the Paraná, and west into the Gran Chaco; and before long vast numbers of the less warlike natives were reduced to serfdom. The name Paraguay

<sup>1</sup> Further details will be found in Keith Johnston (*Geog. Mag.*) and Mr Vanittart's Report.

<sup>2</sup> A graphic description of the Guaraní physique is given by Captain Burton, *Battlefields of Paraguay*, p. 11.

<sup>3</sup> Mr Vanittart in *Reports by Sec. of Emb. and Legation*, 1853.

was applied not only to the country between Rio Paraguay and Rio Paraná, but to the whole Spanish territory, which now comprises parts of Brazil, the republic of Uruguay, and the Argentine provinces of Buenos Ayres, Entre Ríos, Corrientes, Misiones, and part of Santa Fé. It was not till 1820 that Paraguay proper and Rio de la Plata or Buenos Ayres were separated from each other as distinct governments, and they were both dependent on the vice-royalty of Peru till 1776, when Buenos Ayres was erected into a vice-royalty, and Paraguay placed under its jurisdiction. In the history of Paraguay down to the latter part of the 18th century, the interest develops along two main lines, which from time to time get entangled with each other—the struggle between Spaniard and Portuguese for the possession of the border region between the Brazils and the country of the plains, and the formation and defence of a great philanthropic despotism by the Jesuits. The first Christian missions in Paraguay were established by the Franciscans—Armenta, Lebron, Solano (who was afterwards canonized as the apostle of Paraguay), and Bolaños—between 1642 and 1680; but neither they nor the first Jesuit missionaries, Salonico, Field, and Ortega, were allowed to make their enterprise a permanent success. This fell to the lot of the second band of Jesuits, Cataldino, Mazeta, and Lorenzana, who began work in 1605. The methods by which they controlled and disciplined the Guaranis have been described in the article AMERICA.<sup>2</sup> The greater number of the Jesuit "reductions" lay outside of the present limits of the republic, in the country south of the Paraná, which now forms the two Argentine provinces of Corrientes and Misiones. La Guayra, one of the most celebrated, is in the Brazilian province of Paraná. Though they succeeded in establishing a kind of *imperium in imperio*, and were allowed to drill the natives to the use of arms, the Jesuits never held rule in the government of Paraguay; indeed they had nearly as often to defend themselves from the hostility of the governor and bishop at Asuncion as from the actual invasions of the Paulistas or Portuguese settlers of São Paulo. It was only by the powerful assistance of Zebala, governor of Buenos Ayres, that the Anti-Jesuit and quasi-national party which had been formed under Antequera was crushed in 1735. In 1750 Ferdinand VI. of Spain ceded to the Portuguese, in exchange for the fortified village of Colonia del Sacramento (Uruguay), both the district of La Guayra and a territory of some 20,000 square miles to the east of the Uruguay. Seven of their reductions being included in this area, the Jesuits determined to resist the transference, and it was only after several engagements that they were defeated by the combined forces of Spain and Portugal. The treaty which they thus opposed was revoked by Spain in 1761, but the missions never recovered their prosperity, and the Jesuits were finally expelled the country in 1767. In 1811 Paraguay declared itself independent of Spain; by 1814 it was a despotism in the hands of Dr FRANCIA (*q. v.*). On Francia's death in 1840, the chief power passed to his nephew Carlos Antonio LÓPEZ (*q. v.*), and he was in 1862 succeeded by his son Francisco Solano López, whose ambitious schemes of conquest resulted in the almost total extinction of Paraguayan nationality. The three allies, Uruguay, Brazil, and the Argentine Republic, which united against him, bound themselves by the treaty of 1865 to respect and guarantee for five years the independence, sovereignty, and territorial integrity of Paraguay, and at the close of the war in 1870 a new constitution was established, and a president, Jovellanos, appointed under their protection. Reduced to utter helplessness, the country owes its continued existence to the jealousy and balance of power existing between its neighbours. By a separate treaty with Brazil in 1872 it undertook to pay the cost of the war—£40,000,000 to Brazil, £7,000,000 to the Argentine Republic, and £200,000 to Uruguay, or more than £136 per head of the population. An attempt made in 1873 by Messrs Robinson and Fleming to establish an English colony of so-called Lincolnshire farmers ended in disaster. Somewhat better success has as yet attended the German colony of San Bernardino on Lake Ipacany (414 colonists in 1879). The Brazilian army of occupation was withdrawn only in 1876.

Of older works on Paraguay the most important are Azara's *Voyages dans l'Amérique Méridionale*, Paris, 1809; and Charlevoix, *Histoire*, already referred to. As commissioner for the settlement (in 1781) of the frontier between Spanish and Portuguese territory, Azara enjoyed exceptional opportunities of information. Lozano's *Hist. de la Conquista del Paraguay* (used in M.A. by Azara) was first printed at Buenos Ayres, 1678-74. Ulrich Schmidt (often, even in editions of his work, called Schmidt or Schmalz), a German adventurer, left a narrative of the first Spanish expeditions, which was published at Frankfurt in 1568. Like much else of the older literature it is included in Pedro de Angella, *Collection de docum. Hist. del Rio de la Plata*, 1836, &c., and in De Bry's similar collection, as well as in Barcia's *Historiadores*. A systematic narrative of events in the Spanish period is given in Gregorio Funes, *Ensayo de la hist. civil del Paraguay, Buenos Aires, y Tucuman*, 3 vols., Buenos Aires, 1816; Washburn's *History of Paraguay*, Boston, 1871, deals with later times. See also Dobrzhinoff, *Hist. de l'Amérique*; Fage, *Le Plata*, &c., New York, 1837; Mansfield, *Paraguay*, &c., London, 1846; Burton, *Letters from the Battlegrounds of Paraguay*, 1870; Mulhall, *Handbook of the River Plata Republics*, 1875; Mrs Mulhall, *Between the Amazon and Andes*, 1881; E. F. Knight, *Cruise of the Falcon*, 1883. (H. A. W.)

<sup>2</sup> See Duran, *Relation*, 1638; Ruiz de Montoya, *Conquista Espiritual del Paraguay*, 1689; Muratori's pangeyical *Il Cristianesimo felice*, 1743; Charlevoix, *Histoire de Paraguay*, 1756; Davis, *Letters from Paraguay*, 1806, &c.

PARAGUAY RIVER. See PLATE RIVER.

PARAHYBA, or PARABA, distinguished as Parahyba do Norte from Parahyba do Sul or S. João de Parahyba to the south of Rio de Janeiro, is a city of Brazil on the right bank of the river of the same name, 12 miles from the sea, at the terminus of a railway running 87 miles into the interior. It is divided into a lower commercial town and an upper town containing the governor's residence and other public buildings. From December to March the climate is not considered healthy. The harbour, obstructed by several reefs, has a depth of 15 feet, but vessels ground at low water; there is safe anchorage, however, at Cabedello at the mouth of the river. The population, which was 40,000 about 1845, has decreased to between 12,000 and 14,000, and direct trade with Europe has been given up since 1840. Sugar, cotton, and india-rubber are still exported.

PARALLAX may be defined, generally, as the change produced in the apparent place of an object when it is viewed from a point other than that of reference. In astronomy, the places of the moon and planets are referred to the centre of the earth, those of the fixed stars to the centre of the sun. It is shown in ASTRONOMY (vol. ii. p. 775) that, the maximum or horizontal parallax of a celestial object being known, its parallax from any point of observation can be calculated. The present article will be restricted to an account of the methods employed for determining the solar and lunar parallaxes and those of the fixed stars.

SOLAR PARALLAX.—The sun's mean equatorial horizontal parallax (termed briefly the "solar parallax") is the angle which the equatorial radius of the earth would subtend to an observer at the sun when the earth is at mean distance from the sun. For its determination it would appear only necessary to observe the sun's apparent position simultaneously<sup>2</sup> from two widely different points on the earth's surface; the difference of the apparent positions will be due to displacement by parallax, from which displacement the mean equatorial horizontal parallax can be readily deduced.

The requirements of modern astronomy demand that the solar parallax shall be determined with an accuracy of  $\frac{1}{1000}$  part of its amount—that is, within less than  $\frac{1}{100}$  part of a second of arc. But measures in the neighbourhood of the sun cannot be made with any approach to this accuracy, not only on account of the effect of the sun's heat on the various parts of the instruments employed, but also of the atmospheric currents created by heat, which tend to destroy steady atmospheric definition and to render the solar image incapable of exact observation. It is thus hopeless to look for any solution of the problem by the most direct method. Two courses remain—either to seek some method which affords a larger angle to measure, or one which permits a mode of observation affording a higher precision. There are many relations to the solar parallax which are well established.

(1) The parallax of the moon is known with very considerable precision by direct determination. The proportion of this parallax to that of the sun is an important term in the lunar theory, and the constant of this term (the *parallaxial inequality*<sup>3</sup>) is a known function of the solar parallax. Hence, if the constant of the parallaxial inequality is independently determined, the solar parallax becomes known. The elements of the orbits of Venus and

<sup>2</sup> In using the word *simultaneously* the reader must understand that, though it is impossible for two widely separated observers to make precisely simultaneous observations, yet there is no difficulty (since the apparent motion of the sun is accurately known) in reducing the observations so as to represent the result as if the two observations had been made at the same instant.

<sup>3</sup> See ASTRONOMY, vol. ii. p. 796.

Mars undergo secular variations which increase from year to year, from century to century, and at last acquire very large values. These secular variations (on the assumption that all the terms of the theories of the planets are mathematically accurate) have also a well-determined relation to the solar parallax, and therefore afford a means of determining that parallax with an accuracy which increases by the continuance of observation.

(2) It has been shown (ASTRONOMY, vol. ii. p. 779 *sq.*, and MECHANICS, vol. xv. p. 708) that the proportions of the interplanetary distances can be very accurately determined and tables be computed from observations of the apparent places of the planets, without any knowledge or assumption as to absolute distances (although an accurate knowledge of the solar parallax is required for giving final perfection to the lunar and planetary tables). In astronomical ephemerides therefore the distances of planets from the earth are accurately expressed in terms of the earth's mean distance from the sun, the latter being reckoned unity. Hence, to determine the solar parallax, it is only necessary to measure, at some favourable opportunity, the parallax of any planet, and to multiply the parallax so found by the number which expresses the relation of the distance of the planet from the earth to the earth's mean distance from the sun.

(3) When Jupiter is in opposition he is nearer the earth by the diameter of the earth's orbit than when in conjunction; hence, since light occupies a very sensible time to travel, eclipses of Jupiter's satellites will seem to occur too soon in the first case and too late in the latter, the difference between the extremes of acceleration and retardation being the time occupied by light in crossing the earth's orbit. This time is about  $16\frac{1}{2}$  minutes for the mean diameter of the earth's orbit; hence, if the velocity of light can be independently determined, the diameter of the earth's orbit becomes known. The determination, by employing the velocity of light, is also arrived at in another way. The constant of aberration (see ASTRONOMY, p. 757), or the maximum apparent change of a star's true place due to the motion of the observer, depends on the relative velocity of the motion of the observer in space compared with the velocity of light. The angular velocity of the observer is perfectly known; hence if his linear velocity is known his radius of motion is known. Thus, if the constant of aberration and the velocity of light are independently determined, the radius of motion (that is the sun's parallax) will be found.

There are thus three distinctive typical methods:—(1) the gravitational method, depending on terms in the lunar and planetary theories, the constants of which are determined by observation; (2) the geometrical, or direct observational, method; and (3) the physical method.

1. *The Gravitational Method.*—The moon's parallactic inequality appears, at first sight, to furnish a very accurate method, as its constant is about  $125''$ , or fourteen times as great as the solar parallax, and the existing observations are very numerous. Unfortunately its determination is inextricably mixed up with the determination of the moon's diameter—a diameter increased by irradiation, and therefore different for every telescope, and perhaps for every observer. But this is not all. The maximum and minimum effect of the parallactic inequality occur at first and last quarter, *i.e.*, when the moon is half full. One half of the observations for parallactic inequality therefore are made when the sun is above the horizon, and a great portion of the other half during twilight; whilst those on which the moon's diameter depend are made at midnight, when the irradiation is a totally different quantity from what it is in daylight or during twilight. Newcomb has attempted to determine the correction of the diameter by

the errors in right ascension, derived by comparing Hansen's tables of the moon with observations made by daylight and at night; but he confesses that the result is so mixed up with the correction of the coefficient of the variation (and, he might have added, with the observer's personality and the telescope employed) that it cannot be relied upon.

The following are the most important discussions:—

Hansen, <i>Mon. Notices R. A. S.</i> , vol. xxiv. p. 8.....	result $8^{\circ}22'$
Stokes, <i>Mon. Notices R. A. S.</i> , vol. xxvi. p. 271.....	" $8^{\circ}25'$
Newcomb, <i>Washington Observations</i> , 1865.....	" $8^{\circ}24'$
Neison, unpublished, probably to appear in <i>Mem. R. A. S.</i>	" $8^{\circ}27'$

One cannot look with confidence upon a method which thus permits discordance of more than one per cent. in the discussion of the *same observations* by different astronomers. The result arrived at must depend on the adopted corrections of the moon's diameter, and, since that diameter is not capable of determination under the same circumstances of illumination as those in which the observations for parallactic inequality are made, the judgment of the theorist must step in and assign some more or less hypothetical grounds for the adoption of a particular diameter; and upon this assumption will turn the whole of the quantity of which we are in search.

It is, however, not impossible that the method of observing a spot near the centre of the moon, instead of the moon's limb, may lead to a more reliable result. But it will have to be shown by independent methods that the position of the selected spot is not systematically affected by phase.

Attention was first called to the method which employs the secular variations of the elements of the orbits of Venus and Mars for determining the solar parallax by a most able and comprehensive paper communicated by Leverrier to the Paris Academy of Sciences, and published in their *Comptes Rendus* for 1872, July 22. The most important of these variations is that of the perihelion of Mars. The earth's attraction increases the heliocentric position of Mars at perihelion by about  $50''$  in a century, and this change at a favourable opposition subtends an angle of  $185''$  at the earth.

On 1672, October 1, the star  $\psi$  Aquarii was occulted by Mars. The appulse was observed by Richer at Cayenne, by Picard near Beaufort, and by Romer at Paris. The separate comparisons differ only  $0^{\circ}.5$ ,  $0^{\circ}.8$ , and  $0^{\circ}.3$  respectively; and the star  $\psi$  Aquarii was very frequently observed by Bradley. The increase in two centuries of the geocentric longitude, corresponding to the distance of the planet Mars from the earth on 1672, October 1, is  $294^{\circ}$ . Hence M. Leverrier concludes that (attributing an error not greater than  $1''$  to the determination of the observed variation) the time has arrived when the solar parallax can be determined with a probable error not exceeding  $\frac{1}{100}$  of its amount, or the concluded parallax will be exact to nearly  $\pm 0^{\circ}.01$ . The value of the parallax so deduced M. Leverrier finds to be

$8^{\circ}.866$ .

Similarly he finds from the latitude of Venus, determined by the transits of Venus in 1761 and 1769, combined with the latitude determined by meridian observations of the present day

$8^{\circ}.853$ .

From the discussion of the meridional observations of Venus in an interval of one hundred and six years, he finds

$8^{\circ}.859$ .

These values from the theories of Venus and Mars accord in a wonderful manner, and would appear at first sight to justify considerable confidence in the result. But it is impossible to forget the extraordinary intricacy of the

processes through which these results have been evolved, and the liability to some systematic source of error, such, for example, as some neglected term producing a long inequality which may become mixed up with the secular variation.

In 1874 the tabular errors of Venus, as determined by the planet's transit across the sun's disk, amounted to more than 5" of arc both in R.A. and declination, and the tabular errors of Mars amounted to more than 8" in R.A. and to about 3" in declination at the opposition, of 1877, equivalent to an error of 2".45 in heliocentric longitude (*Mem. R. A. S.*, vol. xlv. p. 172). Leverrier's planetary tables do not, therefore, possess the accuracy attributed to them by their distinguished author, and the conclusions at which he arrived probably require some further modification. Tisserand (*Comptes Rendus*, 1881, March 21) has continued the researches of Leverrier, and finds that they require modification, and are also subject to very considerable probable error. The later researches of Tisserand appear to point to a value of the solar parallax smaller than that found by Leverrier, but his work has not yet been brought to final conclusion.

2. *The Geometrical Method.*—The most favourable opportunities for the application of this method are afforded, in a geometrical sense, by the planets Venus and Mars, when the former is in conjunction and the latter in opposition. Of these Venus approaches the earth within one-fourth of the sun's mean distance, whilst Mars, in the most favourable circumstances, approaches only within one-third of the same distance.

When Venus is near conjunction she is only visible as a slender crescent in the neighbourhood of the sun, and at conjunction is only visible on the occasion of a transit across the sun's disk. It generally happens, therefore, that the only means of determining the apparent position of Venus near conjunction is to refer that position to the sun's limb or sun's centre. But the sun's place is also affected by parallax, so that when the position of Venus is referred to the sun the parallactic displacement is only the difference of the parallax of the sun and Venus. Mars, on the other hand, can be referred to stars of which the parallax is absolutely insensible; thus it happens that the advantage of Venus in point of parallactic displacement is diminished till the geometrical conditions are only 5 per cent. in favour of Venus. Transits of Venus across the sun's disk have been observed for parallax in 1761, 1769, 1874, and 1882.<sup>1</sup>

If an astronomer at each of two widely separated stations observes the absolute instant of apparent internal contact of Venus with the sun's limb, he is sure that the centres of the sun and Venus are separated by an angular distance equal to the "semidiameter of the sun minus the semidiameter of Venus." The difference of the absolute times at the two stations is due to parallactic displacement, and, the planet's tabular motion being accurately known, the amount of displacement becomes known. If instead of one contact only the two observers note the instants of internal contact both at ingress and egress, then they practically find the chords described by the planet as seen from both stations. The difference of length of these chords (in time) being known, as well as the approximate diameters of the sun and Venus, and their tabular motion, we have the data for computing the difference of least distance of centres of the sun and Venus at the two stations, and this distance being due to parallax, we have the means of computing the parallax of Venus and thence the solar parallax. This latter method (originally proposed by Halley in 1716) has the advantage of not requiring a

rigid determination of the *absolute instant* of each contact, but merely of the duration of the transit; in other words, it involves no very rigid determination of the longitude or clock error, but only an exact knowledge of the clock rate.

It was Halley's opinion that the instants of contact could be observed with an accuracy within two or three tenths of a second of time, but experience has gone to show that the actual errors are from ten to forty times this amount, and the causes of those errors can now be assigned with considerable certainty. These causes are—(1) irradiation and diffraction; (2) disturbance of the image by irregular refraction in the earth's atmosphere; (3) the effect of the atmosphere of Venus in complicating the phenomena at the point of contact.

(1) Irradiation increases the diameter of the sun and diminishes that of Venus. Its extent depends on the aperture of the telescope, the perfection of its optical quality, and the perfection of the focal adjustment. Its amount is also changed by the brilliancy of the sun, i.e., is affected by the transparency of the sky and the density of the sun-shade employed. Also, when the space between the limbs of the sun and Venus becomes smaller than the diffraction disk of the object-glass employed, a greyness or shadow is perceived at the point of past or approaching contact; therefore, within a minute angle equal to the separating power (the diameter of the diffraction disk) of the object-glass, the actual instant of contact can only be estimated by changes in the diffraction phenomena. (2) When the images are thrown into rapid vibration by irregular refraction in the earth's atmosphere, it becomes impossible to distinguish between the vibration of the image of the dark body of Venus across the sun's limb near the point of contact and the regular phenomena of irradiation, provided that the atmospheric vibrations are sufficiently rapid to produce a persistent image on the retina of the observer's eye. Thus at the transit of Venus in 1882 observers were instructed to note at ingress the time when there was "a well-marked and persistent discontinuity in the illumination of the apparent limb of the sun." Now it so happened that at the Royal Observatory, Cape of Good Hope, the definition was very bad—a south-easter was blowing, the effect of which was, as is almost invariably the case, to create a rapid minute vibration in the images of celestial objects (see Sir John Herschel's *Results of Observations at the Cape of Good Hope*, p. xiv.). Thus "a well-marked and persistent discontinuity in the illumination of the apparent limb of the sun" was seen by all of five observers at the Royal Observatory from 10 to 20 seconds of time longer than at the adjoining stations in the Cape Colony, where the images were seen comparatively steady and well-defined. The instant of occurrence of the above-described phase is therefore a function of the state of the atmospheric definition, and no accurate means exist of estimating such influence. (3) The observation is besides complicated by the illuminated atmosphere of Venus, which forms an arc of light round the planet near the point of contact. In many cases this light has been confounded with the light of the sun, and has thus caused very considerable errors of observation.

From these various causes the apparent phenomena are different at different stations; and probably also the same phenomena are described by different observers in very different language. The real difficulty of the discussion of the results arises when these different and differently described phenomena have to be combined. It is of no consequence whether a real or seeming contact has been observed; it is only necessary to be certain that those observations are combined which represent the same phenomenon. The same phenomenon would correspond with the same apparent angular distance of centres of the

<sup>1</sup> For conditions when a transit will occur, and past and future transits, see *ASTRONOMY*, vol. II. p. 796.

sun and Venus, if all the telescopes were alike, if all the telescopes were in perfect focal adjustment, and if the atmospheric conditions of definition at all the stations were perfect or identical. But if these conditions are not realized (and they cannot be realized in practice) the same apparent phenomena will not represent corresponding phases; and, further, the observers at different stations use such different language to express what they saw that it becomes impossible to select even apparent corresponding phases with any certainty.

The value of the solar parallax deduced from a series of observations of the contacts of Venus with the sun's limb will therefore entirely depend upon the interpretation put upon the language of the various observers. The result will besides be systematically affected if the state of atmospheric definition is systematically different in the opposite stations.

It is thus not surprising that very different results have been arrived at by different astronomers from different transits, and even from different discussions of the same observations of the same transit.

Laplace, <i>Mechanique Celeste</i> .....	transits of 1761 and 1769,	8'81
Encke, <i>Entfernung der Sonne</i> , p. 108	"	8'58
Stone, <i>Mon. Notices R. A. S.</i> , vol. xxviii. p. 255...	transit of 1769,	8'91
Powalky, <i>As. Nachrichten</i> , lxxvi. col. 161.....	"	1769, 8'79
Airy, <i>Monthly Notices</i> , vol. xxviii. p. 16.....	"	1874, 8'76
Stone, <i>Monthly Notices</i> , vol. xxxviii. p. 294....	"	1874, 8'88
Tupman, <i>Monthly Notices</i> , vol. xxxviii. p. 455.	"	1874, 8'85

Besides observing the contacts, another method was employed by the Germans, the Russians, the Dutch, by Lord Lindsay's expedition at the transit of Venus in 1874, and by the Germans in 1882, viz. the heliometric method. This consists in observing with the heliometer (see MICROMETER, vol. xvi. pp. 252-254) the distance of Venus from opposite limbs of the sun along known position-angles nearly in the line of greatest and least distance of Venus from the sun's limb. The method possesses many apparent advantages, because it affords the opportunity of multiplying the observations and of eliminating many sources of error.

At first sight it seems as if the method is free from the necessity for any accurate determination of the scale-value of the instrument, because, if measures are made from opposite limbs of the sun, the sun's diameter may be taken as the standard for all observers, and the place of the planet may be interpolated relatively to the opposite limbs. Unfortunately it happens that there is a very marked difference in observing the sun's diameter due both to instrument and observer. Thus two observers with different instruments, who have compared scale-value by a number of pairs of stars, or zones of stars, will measure sun-diameters with a marked constant difference. If the sun's diameter is assumed to be constant, it, in fact, determines the scale-value; hence the distance of centres measured by the two observers will differ by the proportionate part  $\frac{d}{s} \times \Delta d$ , where  $s$  is the distance of centres,  $d$  the true diameter, and  $\Delta d$  the difference of diameter as measured by the two observers. Thus it is only when  $s=0$  (that is, when the planet is near the centre of the sun) that this method can be used,—a condition that does not exist in practice.

In the case of the transit of Venus fully one-third of the whole of this personality would enter into the result by this method of reduction. For rigid reduction therefore it is absolutely necessary to have a rigid determination of scale-value in seconds of arc. Unfortunately this value, when determined for any uniform instrumental condition of temperature, is liable to change, because, in observations of the sun, difference of temperature between the tube, the object-glass, and the scale of the instrument is produced, and the focal adjustment is also disturbed. The scale-value depends on the relation of the focal length of the object-glass to the length of a part of the scale, and is besides affected by abnormal focal adjustment of the eyepiece.

Drs Auwers and Winnecke adopted a very complete scheme for determining the scale-value at any instant.

1. The scale-value was determined for a uniform condition of the temperature of the instrument by measuring zones of stars whose places were rigidly determined by meridian observations; and by the same means the temperature coefficient of the instrument was determined for different temperatures, the various parts of the instrument being assumed of a uniform temperature in observations of stars by night.

2. The effect of a displacement of focus was determined by measuring the sun's diameter and distances of pairs of stars with different positions of the focal adjustment.

3. The focal point was determined during sun-observations by adjusting the focus on a telescope fixed in a specially prepared chamber, where its temperature would change very slowly, and the temperature of the scale (and hence its length) were measured by a metallic thermometer; hence the change of the proportion of the scale-length to the focal length became known.

In Lord Lindsay's expedition similar precautions were employed, excepting that in the last case an attempt was made to determine the temperature of the tube by thermometers and that of the object-glass by a thermo-pile, and the position of the focal point was calculated from these data.

The uncertainties of all these operations are considerable, and, though from the extraordinary labour and care bestowed upon the determination of the necessary corrections by the German astronomers a fairly reliable result may be arrived at, it is certain that the method of determining the solar parallax from heliometric observation of transits of Venus can now be surpassed by methods more direct, more reliable, and at the same time less laborious and costly.

If photographs can be obtained during a transit in which the limbs of the sun and Venus are sufficiently well-defined, the distance of the centres of the sun and planet can be determined (as in the heliometer method) provided only that the pictures are affected by no systematic errors. That this latter condition may be fulfilled the following are the essential conditions.

1. The picture must be formed on the photographic plate without distortion, or, if it is affected by distortion, that distortion must be ascertained and allowed for.

2. No change must take place in the process of developing and fixing the picture, or, if such change is possible, means must be provided for its detection and elimination.

3. The angular value of one inch on the plate must be accurately known, so as to convert measured distances into arc—for the same reasons as in the heliometer method.

It is necessary to employ an image of considerable size, because otherwise the particles of collodion, if magnified so much as to permit measurement of the requisite accuracy, give an irregularity to the limbs that is fatal to accurate estimation. Thus it becomes necessary either to employ a lens of very considerable focal length (40 feet was generally adopted), or to introduce a secondary lens to magnify the image formed in the primary focus. The first of these methods was employed by the Americans, by the French, and in Lord Lindsay's expedition at the transit of 1874, the second by the British, German, Russian, and Dutch expeditions.

The use of an object-glass of long focus renders mounting of the lens in the usual manner, though not a practical impossibility, yet at least a matter of extreme inconvenience. Accordingly, where lenses of long focus were employed, the telescope was mounted in a horizontal position, and the sun's rays were reflected by a plane mirror in the direction of the tube's length. It is not easy to conceive that any sensible distortion in the image can be produced by a lens of such long focus even if only of mediocre quality of figure; indeed the method may be assumed free from any such error; but it is undoubtedly exposed to all the errors of distortion which may be produced by the plane. From the perfection now attained in the construction of optical planes, and the means which exist for testing them, the errors due to this cause may also probably be safely neglected, except in so far as the figure of the plane is distorted by the heat of the sun, and it is not impossible that some degree of systematic error may be thus created.

To determine the angular value of one inch (or other unit of length) on the photographic plate, it is only necessary to measure the distance of the plate from the posterior surface of the object-glass, and then to determine the distance of the optical centre of the lens from that surface; the sum of these two distances is the radius of which lines on the surface of the plate (reckoned from the centre of the plate) are tangents.

The French adopted the daguerrotype method of photography, in which it is impossible to imagine any errors due to contraction of the photographic film, as in the collodion process, because the picture is virtually a portion of the silver plate on which it is taken. But in adopting this process the advantage of measuring the photographs by transmitted light was lost; and it is a practical question, which experience has not yet decided, whether the loss or the gain is the greater.

The Americans, and Lord Lindsay in 1874, using the collodion process, took the precaution to provide means for the detection of possible contraction of the film during development of the picture or drying of the film. This was done by placing the sensitive plate near to or in contact with a reticule ruled on glass near the primary focus; this reticule was thus photographed simultaneously with each photograph of the sun; hence any change produced during the development would cause a similar change in the relative positions of the images of the ruled lines on the developed plate. As a matter of fact the American astronomers have found fairly reliable results from their photographic operations, but the accuracy arrived at is by no means very considerable, the probabi-



error of the complete measurements of an average plate amounting to  $\pm 0''.5$ .

But the difficulties of dealing with systematic errors are enormously increased when a secondary magnifier is employed, because it is theoretically impossible with the present optical glass (employing spherical curves) to construct a perfect secondary magnifier in which the scale value should be absolutely the same in every part of the field; still less is it possible, when the attempt is made, to combine the visual and photographic rays in the same focus; hence every photoheliograph of this construction must be separately studied for distortion of the image. The results of actual trial prove that the distortion is even greater than was expected, and is besides not the same in each radius, and the latter error may be produced by a very small error of centring in the lenses which compose the secondary magnifier. The investigation of such errors with the required accuracy would be a laborious and at best an unsatisfactory operation, and is rendered practically impossible by the fact that, whenever the instrument is turned upon the sun, the object-glass becomes heated, its focal length changed, and the optical relation of the secondary magnifier to the image in the principal focus of the object-glass changed also.

For these reasons the photographic observations in which secondary magnifiers were employed might be expected to prove a failure, and this expectation has been confirmed by the result of experience.

The observation of the transit of Venus on a large scale of national expenditure was certainly justified in 1761 and 1769. In those days there were no refined means of measuring angles with high accuracy, and the employment of the motion of Venus and a time-scale of measurement was the best available method of determining the solar parallax. But since 1820 the art of measurement has so advanced, and such refined instruments and methods have been thus introduced, that it may be a matter of some surprise and question to future generations of astronomers why so much labour and money were expended upon so imperfect a method in 1874 and 1882. The justification of these expeditions must be found, not in the reliability of the value of the solar parallax determined by them, but in the impulse given to the construction of instruments, the awakening of a widespread interest in astronomy, the stimulus to invention of new methods of research, and the accurate determination of the latitudes and longitudes of a large number of important and previously undetermined stations on the earth's surface.

If an opposition of Mars occurs when that planet is near perihelion and the earth near aphelion the planet is then about one-third of the sun's distance from the earth. When these conditions are nearly realized the opportunity is a favourable one for determining the solar parallax.

On 1672, October 1, the star  $\psi$  Aquarii was occulted by Mars. Estimations of the distance of the planet from the star were made at well-observed instants of time by Richer, Picard, and Romer, as already noticed, and from these observations the first approximate determination of the solar parallax was made by Cassini, viz.,  $9''.5$ .

The method of observing Mars that has been most largely employed consists in observing the apparent declination of the planet by means of the transit circle—at observatories both in the northern and in the southern hemisphere. To increase the accuracy of the result, the same stars near the planet are observed at the various observatories, so that the method is reduced to measuring the difference of declination between the planet and neighbouring stars. The effects of periodic error in the graduation of the circles, of flexure of the instruments, and of abnormal refraction are thus nearly eliminated, and there remain only the systematic errors which may be supposed to arise from the difference of the habit of the observers in bisecting a star and a planet. To some extent these errors could be eliminated by the use of a reversing prism applied in the place of a sun-shade between the eyepiece and the observer's eye. By the use of such a prism the motion of the spider-web and the limbs of the planet can be reversed with respect to the vertical, and such errors as

depend on a different habit of bisecting a similar apparent upper and lower limb would be thus eliminated. But on account of the chromatic dispersion of the atmosphere the lower limb of the planet is coloured red and the upper limb violet; and in the illuminated field of the telescope it is probable that the observer has a tendency to cut with his spider-web more deeply into the feeble violet limb than into the more glaring red limb. The effect of his so doing would be to increase the value of the resulting parallax, and it seems not improbable that from this cause a larger value of the parallax has been obtained by this than by other methods.

The following are the most important series of observations, and their discussion by this method:—

Winnecke ( <i>Ast. Nachrichten</i> , lix. vol. 261), opposition of Mars 1862; from observations at Pulkowa and Cape of Good Hope.....	8.96
Newcomb ( <i>Washington Observations</i> , 1865, Appendix II.); from all meridian observations of Mars in 1862.....	8.85
Eastman ( <i>Wash. Obs.</i> , 1877, Appendix III.); from meridian observations of Mars at six observatories in 1877.....	8.95
Stone, <i>Monthly Notices</i> , xlii. p. 300; including observations rejected by Eastman.....	8.95

In 1872 (*Ast. Nach.*, No. 1897) Dr Galle of Breslau proposed a method of determining the solar parallax which appears to be the foundation of the method of the future, viz., to measure, by means of the equatorial, the difference of declination between selected stars and a minor planet, or rather to interpolate the declination of a minor planet relative to two stars of comparison. A minor planet presents precisely the appearance of a star, and it is impossible to conceive any personality which can affect the observation of such a planet and a star. The interpolation of the planet's declination relative to two including star-declinations (i.e., measurement from stars nearly equally north and south of the planet) entirely eliminates errors due to error of the adopted arc-value of the micrometer screw. It is true that in the case of minor planets the parallax factor can hardly exceed  $1\frac{1}{2}$ , whilst in the case of Mars that factor may be 3; but their disks present objects which are capable of being observed with quite two and a half times the accuracy of Mars. Hence the conditions of accidental accuracy are equalized for a single opposition, whilst the advantages of systematic accuracy are entirely in favour of the minor planets. Moreover, the opportunities offered by favourable oppositions of minor planets are much more frequent than in the case of Mars. The opposition of the minor planet Flora in 1874 was observed, at the request of Dr Galle, by a considerable number of observers in both northern and southern hemispheres, but unfortunately only in very few cases with the precaution, care, and perfection of instrumental equipment necessary. In 1882 the minor planets Victoria and Sappho were similarly observed at the request of Gill. The work was taken up by a number of astronomers in both hemispheres, in a much more complete and systematic manner, with better instrumental means, and with the benefit of former experience. The results have not yet been reduced, but it is believed they will afford a valuable contribution to the problem in question. The results of Dr Galle's discussion of the observations of Flora in 1874<sup>1</sup> give for the solar parallax

$$8''.87 \pm 0''.042;$$

but the same results when the relative weights are assigned in a more legitimate manner lead to the value

$$8''.82 \pm 0''.06.$$

But in any plan requiring numerous and widely spread observers it is very difficult to secure that entire sympathy

<sup>1</sup> *Ueber eine Bestimmung der Sonnen Parallaxe aus correspondirenden Beobachtungen des Planeten Flora in October und November 1874*, Breslau, 1875.

with the end in view, that scrupulous care in minute detail, which is essential in the highest class of observation, and it becomes impossible to alter the previously prepared programme in such a case, should circumstances render it desirable to do so; nor does it always happen that distant observatories can be supplied with the necessary instrumental details in sufficient time. In the case of the Victoria and Sappho observations of 1882 the requisite sympathy and care were accorded in a very remarkable degree, but on account of the errors of the planetary tables (discoverable only when the observations were begun) the selected stars of comparison were not by any means the most favourable that could have been chosen, and were consequently not the stars that a single observer would have selected at the time. Hence arises the desirability of a method not requiring co-operation, in which success depends upon a single observer, who may obtain independently by his own observations a complete series of results.

In 1857 Airy, in an address to the Royal Astronomical Society on the methods available for determining the solar parallax during the next twenty-five years, called attention to the favourable opposition of Mars in 1877, and declared his opinion that the best method of finding the solar parallax was to determine at an equatorial station the difference of right ascension of that planet and neighbouring stars in the evening and early morning, by observing transits of stars and planet across the webs of a well-adjusted rigidly mounted equatorial. The motion of the earth's rotation would transport the observer 6000 or 7000 miles between the evening and morning observations, and the requisite displacement would thus be obtained. In other words, the observer would avail himself of the diurnal displacement to determine the parallax of the planet. Of course a very large number of observations would be required, because the observation of a transit over the webs of a telescope is not so exact as the micrometric comparison of two points. Only one observer availed himself of Airy's suggestion, but a very good series of observations by this method was obtained by Maxwell Hall at the island of Jamaica. The detailed observations are printed in *Mem. R. A. S.*, vol. xlv. p. 121; the resulting value of the solar parallax is

$$8''\cdot79 \pm 0''\cdot06.$$

In 1874 (in connexion with Lord Lindsay's expedition to Mauritius) Gill, combining the suggestion of Galle as to the employment of a minor planet and Airy's suggestion as to the employment of the diurnal displacement, observed the minor planet Juno, which was at that time favourably situated for the purpose. But instead of employing the method of transits of the planet and stars across spiderwebs he used a heliometer, and measured with that instrument the distance of the planet from the same star in the evening and morning. In order to eliminate the effects of changes in the scale-value, Gill selected stars on opposite sides of the planet, and so arranged his observations as to measure simultaneously the angle between the planet and both comparison stars. That is to say, if the two distances in question are called  $a$  and  $b$ , the measures were arranged in the order  $a, b, b, a$  or  $b, a, a, b$ . Thus any abnormal scale-value of the instrument applicable to the measurement  $a$  would be equally applicable to the measurement  $b$ . If the places of the comparison stars are thus determined by meridian observations, the scale-value may be derived from the observations themselves with all desirable accuracy, and the effect of change in the scale-value (which alone is all-important) be absolutely eliminated. The observations so made at Mauritius showed that the position of the planet Juno relative to two stars of comparison could be so interpolated with a probable error less than  $\frac{1}{10}$ th of a second of arc. A full account of these observa-

tions, together with a description of the heliometer, is given in the *Dunedin Publications*, vol. ii. Lord Lindsay's yacht, which conveyed the heliometer to Mauritius, unfortunately did not reach her destination till the most favourable time for making the observations was past; but sufficient observations were obtained to test the method thoroughly and to prove its capabilities.<sup>1</sup> The value of the solar parallax resulting from the observations of Juno at Mauritius was

$$8''\cdot77 \pm 0''\cdot04$$

In 1877, instead of observing the favourable opposition of Mars of that year by Airy's method, Gill proposed to the Royal Astronomical Society to employ a heliometer (kindly lent by Lord Lindsay) to observe the planet in a similar manner to that in which he had observed the minor planet Juno at Mauritius in 1874. The offer was accepted. Gill selected the island of Ascension, and there carried out the necessary observations. The stars of comparison, by the kind and hearty co-operation of astronomers, were observed at thirteen of the principal observatories with meridian instruments, a combination of their results affording standard places of high accuracy. In general the angular distance of the planet was measured both in the evening and morning from each of three surrounding stars. The observed readings of the heliometer were corrected for the effects of refraction and phase, for the errors of division of the scales and of the micrometer screw, and were then converted into arc on an assumed value of one revolution of the micrometer screw (or rather of half an interval of the scale divisions).

The tabular apparent distance of the centre of Mars from each star for the instant of each observation was then computed with an assumed approximate value of the solar parallax ( $8''\cdot80$ ). The calculation of the solar parallax and the elimination of errors of scale-value were then easily effected as follows:—

- Let  $\Delta\alpha$ ,  $\Delta\delta$  = the corrections in seconds of arc to be applied to the tabular right ascension and declination respectively to obtain the true right ascension and declination of Mars at the epoch  $\tau_0$ .
- $p$  = the position angle of the planet referred to the star of comparison.
- $\delta_0$  = the approximate mean declination of the star and planet.
- $\alpha'$  = the daily rate of increase of  $\Delta\alpha$  for the epoch  $\tau_0$ .
- $\delta'$  = the daily rate of increase of  $\Delta\delta$  for the epoch  $\tau_0$ .
- $\tau$  = the Greenwich mean time of observation.
- $n$  = the number of  $\frac{1}{1000}$  parts (or the percentage) that the assumed solar parallax must be increased.
- $s$  = the correction required to be applied to an observed arc of 10000" reduced on the assumed scale-value.
- $v$  =  $\frac{\text{the observed distance in seconds of arc}}{10000}$ .
- $O$  = the observed angular distance, computed with the assumed scale-value.
- $C$  = the calculated or tabular distance computed with the assumed value of the solar parallax.

Then each observation furnishes an equation of condition of the following form—

$$f'\Delta\alpha + f''\Delta\delta + f'''n - v = (O - C) - f'(\tau - \tau_0)\alpha - f''(\tau - \tau_0)\delta';$$

where

$$f' = \sin p \cos \delta_0;$$

$$f'' = \cos p$$

$$f''' = \left( \frac{\text{parallax in R. A.}}{100} \right) f' + \left( \frac{\text{parallax in declination}}{100} \right) f''; -$$

the parallaxes in  $f'''$  being in seconds of arc.

The equations resulting from each group of observations are then combined, care being taken to combine together in one group such observations only as have been made nearly simultaneously and where the value of  $n$  may therefore be assumed to be the same.

The combination of a group of evening with a group of morning observations (in which the term representing the error of scale-value must then be represented by  $s$  and  $s'$ ) thus affords six

<sup>1</sup> A more complete test has since been furnished by observations for stellar parallax, to which reference will afterwards be made.

equations involving five unknown quantities, from which the most probable value of  $\pi$  can be eliminated with its weight by the method of least squares, in terms of  $\kappa$  and  $\kappa'$ .

Care, however, must be taken to confine the combination to such groups as depend on measures from the same stars, if it is desired to eliminate the effects of errors in the adopted star places. Also, since it is assumed that  $\kappa$  and  $\kappa'$  vary proportionally with the time, it is necessary that only such observations should be combined as have been made at epochs sufficiently near together to render this a safe assumption.

Finally the absolute values of  $\kappa$  and  $\kappa'$  for the various combinations are deduced by developing the values of  $\Delta\alpha$  and  $\Delta\delta$  from each combination in terms of the time, and thus the definitive values of  $\pi$  are obtained.

The combination of these values of  $\pi$ , having regard to the weight of each, led to the result

$$\pi = -0.209.$$

Whence the value of the solar parallax was

$$8''.78 \pm 0''.012.$$

It should be remarked that in these observations a reversing prism was so employed as to eliminate any systematic error on the part of the observer which might be due to astigmatism of his eye, or a habit of placing the image of the star otherwise than truly central on the image of Mars. The probable error of one observation of distance having weight unity was found to be  $\pm 0''.24$ . Twelve such observations were generally made (and often more) on each night, and complete combinations of observations were secured on twenty-five nights.

This probable error does not exceed that of a single observation of contact on the occasion of a transit of Venus, and yet one hundred and ninety-six such observations were secured, as compared with two which is the utmost that can be secured as the result of any single observer's expedition to observe a transit of Venus.

It is impossible, however, to say with certainty that the above result is entirely free from systematic error. There is one possible source of such error to be suspected, viz., the possible effect of the chromatic dispersion of the atmosphere which colours the limbs of Mars in the manner already described. In the case of heliometer observations the effect is certainly minimized from the fact that the star disk which is compared with the limb of Mars is coloured precisely in the same way as the limb—but whether all error is so eliminated it is impossible to say. A detailed account of these observations and their reductions is given in *Mem. R. A. S.*, vol. xvi. pp. 1-172.

If a minor planet, however, is observed in the above described manner, no suspicion of the error in question can attach to the final result; and, so far as is known, that method affords the only geometrical means of arriving at an absolutely definitive value of the solar parallax.

The following table represents the oppositions of minor planets that will be available for determining the solar parallax till the end of the present century.

Date of Opposition.	Number and Name of Planet.	Approximate Horizontal Parallax at Opposition.	Magnitude at Opposition.
1886 November.	8 Flora.	9"	8½
1886 December.	79 Eurynome.	8	9½
1888 September.	75 Eurydice.	10	9½
1888 November.	7 Iris.	10	7
1889 July.	12 Victoria.	10	8
1889 August.	80 Sappho.	9	9
1890 January.	27 Euterpe.	8	8½
1890 June.	43 Ariadne.	10	8½
1890 December.	20 Massilia.	8	8½
1892 August.	192 Nausicaa.	8	8½
1893 September.	6 Hebe.	9	7½
1894 September.	84 Clio.	9	9½
1897 July.	194 Proce.	8	9
1898 June.	25 Phocæa.	8	9½
1899 November.	7 Iris.	9	7½
1899 December.	8 Flora.	8	8

The results of many hundreds of observations for stellar parallax by Gill and Elkin (*Mem. R. A. S.*, vol. xlviii. part 1) prove that the difference of two opposite angular distances each not greater than 2' can be measured by a small heliometer with a probable error not exceeding  $\pm 0''.15$  when the objects measured are points of light such as two stars (or a star and a minor planet). Hence it is easy to show, that a single observer at an equatorial station (furnished with a suitable heliometer) can determine the solar parallax by the careful observation of two or three of the more favourable of the above oppositions with a probable error not exceeding  $\pm 0''.01$ , and with absolute freedom from systematic error. Such a result is not possible by any other known method.

3. *The Physical Method.*—The determination of the velocity of light has recently been the subject of very refined and accurate measurement by the methods both of Fizeau and of Foucault (see LIGHT, vol. xiv. p. 585). The results of the most recent and best determinations of the velocity of light, expressed in kilometres per second, are the following (*Sidereal Messenger*, vol. ii. No. 6):—

Cornu, by Fizeau's method.....	300,400
Michelson, by modification of Foucault's method.....	299,940
Newcomb, by still more powerful apparatus and modification of Foucault's method.....	299,717

If we denote by  $k$  the interval required by light to cross the mean radius of the earth's orbit, any independent determination of  $k$  will obviously afford, when combined with the velocity of light, a determination of the sun's distance, i.e., of the solar parallax (see LIGHT, vol. xiv. p. 584). Such a determination of  $k$  is afforded by a discussion of the eclipses of Jupiter's satellites. Only two such discussions that have any claim to acceptance exist:—the first by Delambre in the early part of the present century, from a discussion of an immense mass of eclipses of the satellites of Jupiter comprising observations from 1662 to 1802, the second by Glasenapp, in a Russian thesis, in which there are discussed the observations of the first satellite of Jupiter from 1848 to 1873.

Instead of Delambre's value of  $k = 493''.2$

Glasenapp finds  $k = 500''.8 \pm 1''.03$ .

Todd, in calling attention to Glasenapp's results (*Am. Journal of Science*, vol. xix. p. 62), remarks on these two values as follows:—

"The former determination rests on a much greater number of observations than the latter; but it is difficult to form a just estimate of the work of an average last-century observation of an eclipse of a satellite of Jupiter. And, moreover, astronomers have no means of knowing the process which led the distinguished French astronomer to his result—which was adopted in his own tables of the satellites, and which was adopted by Damoiseau in his *Tables Écliptiques*, published in 1836. The latter determination rests upon a mass of observations of definite excellence, which have been discussed after the modern fashion."

Astronomers, however, whilst generally endorsing these remarks, will not be inclined to follow Todd in combining Delambre's value with Glasenapp's by giving double weight to the latter. Having regard to those portions of Todd's remarks which we have printed in italics, astronomers would generally be of opinion that only Glasenapp's value of  $k$  can be seriously considered at the present day. This value, combined with the above mean value of the velocity of light, leads to

$$8''.76 \pm 0''.02$$

as the value of the solar parallax.

The photometric observation of the eclipses of Jupiter's satellites as now being carried out at Cambridge, U. S., under Prof. Pickering, will probably ere long furnish the data for a much more accurate determination of  $k$ , and it is not impossible that very refined heliometric observations of the distance of the first satellite (when apparently

near the planet) from the other satellites may likewise yield a reliable value of  $k$

On the relations between the constant of aberration, the solar parallax, and the velocity of light, see LIGHT, vol. xiv. pp. 584, 585.

The mean of the nine best modern determinations of the constant of aberration (i.e., from 1830 to 1855) gives—  
20".496.<sup>1</sup>

The most recent and valuable paper on this constant is that of Nyrén (*Mém. de l'Acad. de St Pétersbourg*, 7th ser., vol. xxxi. No. 9), in which the constant is derived from independent researches extending over many years, with each of the three great fixed instruments of the Pulkowa observatory. The independent mean results are—

From observations with the prime vertical transit.....	20".490
"    "    vertical circle.....	20".495
"    "    transit instrument.....	20".491
Mean.....	20".492

This result, combined with the above quoted values of the velocity of light, gives the following values of the solar parallax:—

Combined with Cornu's velocity.....	8".778
"    Michelson's velocity.....	8".791
"    Newcomb's velocity.....	8".798
Mean.....	8".789

There still remain some little theoretical difficulties with regard to the theory of aberration. That theory is perfectly obvious on the emission theory of light, but is *a priori* by no means so obvious on the undulatory theory. Is it certain that the velocity of light in the celestial spaces is identical with (or bears an exactly known relation to) the velocity of light which, having travelled a certain space in air, undergoes reflexion and returns? This is a question for the physicist, and a question that probably demands a practical as well as a theoretical answer.<sup>2</sup>

Also Villarceau (*Comptes Rendus*, 1872, October 14) points out that in the ordinary theory of aberration no account is taken of the sun's motion of translation through space, and shows that, if the normal constant of aberration is  $A$ , the constant for any particular star is  $A + A \times \alpha$ , where  $\alpha$  depends on the angle which the star's direction makes with the direction of the sun's translation in space. In the observations of Nyrén, above referred to, there is a well-marked periodic variation in the values of the constant of aberration derived for twenty-seven stars, which seems to be a function of the right ascension of the stars. This variation may be due to some cause (such as lateral refraction in the north-and-south direction) depending on the seasons, or it may have a real physical significance on the theory of Villarceau. If further observation (especially in the southern hemisphere, where the seasons are reversed) should confirm the latter hypothesis, two important conclusions result:—

(a) We obtain some idea of the direction and amount of motion of the milky way, combined with that of the solar system in space; and

(b) We may conclude that our theory of light is correct, which supposes that a ray of light is transmitted through space with uniform velocity, independently of the velocity of the source of light, and that ether is fixed and infinite—that is, nowhere limited in extent.

On the other hand a negative result would go far to show that our conception of ether is not correct, at least would force us to adopt one of two conclusions,—either that the milky way is stationary in space (within limits of our power of measurement), or that the ether accom-

panies the milky way and is not fixed in space and not infinite.

It is, however, *a priori* improbable that from any of these causes the deduced value of the solar parallax will be affected by  $\frac{1}{1000}$  of its deduced amount.

The tendency of the best modern determinations is to fix the solar parallax at

8".78 or 8".79,

and hence the mean distance of the earth from the sun at 93 millions of miles, a result which is almost certainly exact within 200,000 miles.

**LUNAR PARALLAX.**—The constant of the lunar parallax may be determined by a method precisely similar to that followed in the meridian declination observations of Mars. Our knowledge of the parallax of the moon depends at present entirely on such observations made nearly simultaneously at the Royal Observatories of Greenwich and the Cape of Good Hope. The resulting values of the parallax, found directly from these observations, are then multiplied by a factor which expresses the relation between the constant of the lunar parallax (*ASTRONOMY*, vol. ii. p. 798) to the moon's tabular parallax at the time; thus each nearly simultaneous observation at the two observatories gives an independent determination of the constant of the lunar parallax.

A better method, however, will be found when the results of numerous occultations of stars have been employed to determine the constants of a new and more accurate lunar theory—a work about to be undertaken by Prof. Simon Newcomb.

The best determination of the constant of the lunar parallax is that of Mr Stone, viz., 3422".71 (*Mem. R.A.S.*, vol. xxxiv. pp. 11–16), derived from meridian observations at Greenwich and the Cape of Good Hope.

**STELLAR PARALLAX.**—The constant of parallax of a fixed star is the maximum angle which a line equal to the earth's mean distance from the sun would subtend if viewed at the star.

The distances of the fixed stars are so remote that till very recent times their parallaxes have been found to be insensible; that is to say, the earth's orbit viewed from the nearest fixed star presents a disk (or ellipse) too small for measurement.

The limits of this article do not permit a detailed history of the early attempts of astronomers to determine the parallaxes of the fixed stars. The reader is referred on this point to Peters's *Précis historique des travaux sur la parallaxe des étoiles fixes*, forming the first section of his celebrated work *Recherches sur la Parallaxe des étoiles fixes* (*Mém. de l'Acad. Imp. de St Pétersbourg*, sec. Math. et Physiques, vol. v.). The most notable incident in that history was the discovery of aberration by Bradley, in 1728, when engaged in an unsuccessful attempt to determine the parallax of the star  $\gamma$  Draconis

The first determination of the parallax of a fixed star is due to Henderson, His Majesty's astronomer at the Cape of Good Hope in 1832 and 1833.<sup>3</sup> It was followed by the nearly simultaneous discoveries of the parallax of 61 Cygni by Bessel<sup>4</sup> and that of  $\alpha$  Lyrae by Struve<sup>5</sup> from observations made in the years preceding 1840. Since that time similar researches have been prosecuted with gradually increasing success.

The methods of observation may be divided into two classes,—the absolute and the differential.

The *absolute method* depends on observation of the zenith distance of a star about the epochs of maximum

<sup>1</sup> *Mem. R. A. S.*, vol. xli. p. 166.

<sup>2</sup> See also letter by Lord Rayleigh in *Nature* 1881, August 25.

<sup>3</sup> *Mem. R. A. S.*, vol. xli. p. 329.

<sup>4</sup> *Astron. Nachrichten*, Nos. 365, 366, and 401.

<sup>5</sup> *Astron. Nachrichten*, No. 396.

parallactic displacement in declination—in practice, however, generally throughout the whole year. The differences of declination so observed, after allowing for the effects of refraction, precession, aberration, nutation, and proper motion, afford the means of deducing the parallax of the star. The most notable series of observations of this character are those of Maclear at the Cape of Good Hope, by which he confirmed the results of his predecessor Henderson and those of Peters at Pulkowa in the second section of his work above mentioned. The latter is the most classic work in existence on refined observations of absolute declination, and it is by no means certain that, in more modern meridian observations, the work and methods of that distinguished observer have been equalled—except perhaps at Pulkowa. The minute precautions necessary in such work will be found in Peters's paper above mentioned (see also TRANSIT CIRCLE). But not with all the skill of Peters, nor with every refinement of equipment and observation, can the difficulties caused by refraction and minute

change of instrumental flexure, &c., be completely overcome; the method of absolute altitudes does not, in fact, respond in accuracy to the demands of the problem.

The *differential method* depends on measuring the difference of declination, of distance, or of position angle between the star whose parallax is to be determined and one or more stars of comparison. It is assumed that the stars most likely to have sensible parallax are those which are remarkable for brilliancy or proper motion, and that the parallaxes of the stars of comparison (having little or no sensible proper motion and faint magnitude) are so small as to be insignificant. So far as our knowledge goes these assumptions are justified.

Researches on stellar parallax by these methods have been followed of late years with considerable success. The instruments employed have been the heliometer and the filar micrometer (see MICROMETER, vol. xvi. pp. 243-248), the latter instrument being used in conjunction with an ordinary equatorial (see TELESCOPE). The precautions

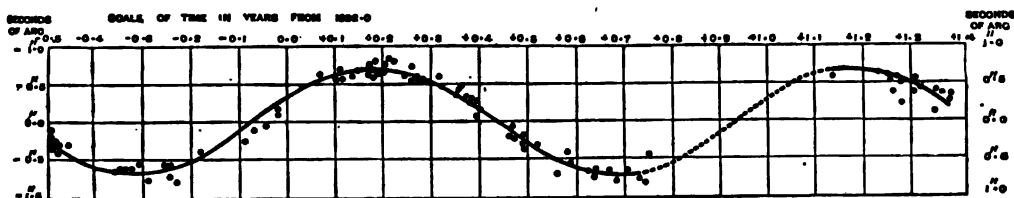

Fig. 1.

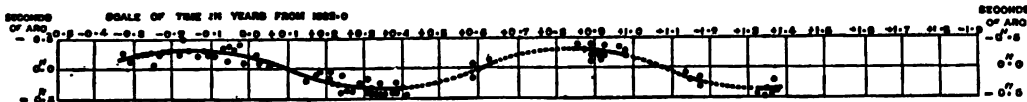

Fig. 2.

required to determine and eliminate systematic error, and to secure the necessary refinement of accuracy, demand more space for their description than the limits of this article admit. The reader is referred for these particulars to the undermentioned papers on the subject.

The heliometer method seems to present the greatest facilities for extensive researches on stellar parallax, not only because measures with this instrument seem, on the whole, to possess the highest accuracy, but because (on account of the large angles that can be measured) a much wider selection of suitable stars of comparison is available. Gylden of Stockholm has applied the method of observing the differences of right ascension between the star whose parallax is to be determined and each of two comparison stars, and the same method has also been applied by Auwers (*Math. Abhand. Berliner Acad.*, 1867); but the results obtained in this way do not compare at all favourably with the accuracy of properly conducted heliometer measurements.

The diagram (fig. 1) represents observations made by Gill to determine the parallax of a Centauri, with a heliometer at the Cape of Good Hope. The ordinates of the curve are the times reckoned from 1882-0, the abscissae the changes in the place of a Centauri due to the parallax computed from the observations. Each dot represents the observations of each single night, and the reader will be able to judge of the accuracy of the observations from the agreement of the dots with the curve. Fig. 2 in like manner represents a series of observations of Sirius.

These and many other results show that, with similar means, it is now possible to detect any differential parallax amounting to 0".05 with certainty, by a series consisting of a reasonable number of like observations—thus opening up a wide and important field for future research.

The following table contains a list of those stars of

which the parallax is known with considerable accuracy, Nos. 1 to 13 being in the northern and Nos. 14 to 22 in the southern hemisphere.<sup>1</sup>

	Magnitude.	Proper Motion.	Parallax.
1. 61 Cygni.....	6	5".14	0".50
2. Lalande 21185.....	7½	4".75	0".50
3. α Tauri.....	1	0".19	0".52
4. 84 Groombridge.....	8	2".81	0".29
5. Lalande 21258.....	8½	4".40	0".26
6. O. Arg. 17415.....	9	1".27	0".25
7. ε Draconis.....	5½	1".87	0".24
8. α Lyra.....	1	0".81	0".19
9. ρ Ophiuchi.....	4½	1".0	0".17
10. α Bootis.....	1	2".43	0".18†
11. Groombridge 1880.....	7	7".05‡	0".09
12. Bradley 3077.....	6	2".09	0".07
13. 85 Pegasi.....	6	1".38	0".05
14. α Centauri.....	1	3".67	0".75
15. Sirius.....	1	1".24	0".33
16. Lacaille 9352.....	7½	6".95	0".28
17. ε Indi.....	5½	4".68	0".22
18. α Eridani.....	4½	4".10	0".17
19. ε Eridani.....	4½	3".03	0".14
20. ζ Tucana.....	6	2".05	0".06
21. Canopus.....	1	0".00	Insen- sible.
22. β Centauri.....	1	...	Insen- sible.

<sup>1</sup> Authorities.—1. O. Struve, *Mém. Acad. St Pétersbourg*, ser. vii. vol. i. p. 45 (0".506); Auwers, *Ast. Nach.*, 1411-16 (0".58); Ball, *Dunedin Observations*, vol. iii. p. 27 (0".465); Hall, *Wash. Observations*, 1879, Appendix I. (0".478 ± 0.16). 2. Winnecke (heliometer), *Pub. Astron. Gesellschaft*, No. xi. (0".501 ± 0".011). 3. O. Struve, *Mém. Notices R. A. S.*, vol. xlv. p. 237. 4. Auwers (differences of R.A.), *Math. Abhand. Berliner Acad.*, 1867 (0".293 ± 0".036). 5. Auwers (heliometer), *Astron. Nachrichten*, No. 1411 (0".271 ± 0".11); Krueger (heliometer), *Mém. Notices R. A. S.*, vol. xxiii. p. 173 (0".260 ± 0".020). 6. Krueger (heliometer), *Ibid.*, (0".247 ± 0".021). 7. Brannow, *Dunedin Observations*, vol. ii. p. 31 (0".240 ± 0".011). 8. O. Struve, *Mém. Acad. St Péters-*

A glance at the table is sufficient to show that neither apparent magnitude nor apparent motion affords a criterion of the parallax of any fixed star. Similar researches must, in fact, be carried out on a much more extended scale before any definite conclusions can be drawn. At present we can only conclude that different stars really differ greatly in absolute brightness and absolute motion.

The following are the formulæ which will be found most useful in computing the corrections for parallax:—

*For the Sun, Moon, and Planets.*

- Put  $\pi$  — the equatorial horizontal parallax;  
 $\Delta$  — the distance of the object from the earth;<sup>1</sup>  
 $\zeta$  and  $\zeta'$  — the geocentric and apparent zenith distances respectively;  
 $A$  and  $A'$  — the geocentric and apparent azimuths respectively;  
 $\phi$  and  $\phi'$  — the geographical and geocentric latitudes respectively;  
 $\rho$  — the earth's radius corresponding to  $\phi$ ;  
 $\alpha$  and  $\alpha'$  — the geocentric and apparent right ascensions of the object respectively;  
 $\delta$  and  $\delta'$  — the geocentric and apparent declinations of the object;  
 $t$  — the hour angle of the object (reckoned + when west of meridian).

1. To find the parallax of the moon in zenith distance and azimuth, from the observed (or apparent) zenith distance and azimuth.

Put 
$$\sin(\zeta' - \zeta) = \rho \sin \pi \sin(\phi' - \phi) \cos \alpha'$$
 Then 
$$\sin(A' - A) = \frac{\rho \sin \pi \sin(\phi' - \phi) \sin A'}{\sin \zeta}$$

The corresponding quantities are found with all desirable precision for the sun and planets by the formulæ—

$$\zeta' - \zeta = \pi \sin(\zeta' - \gamma); \text{ or approximately } = \pi \sin \zeta';$$

$$A' - A = \pi \sin(\phi - \phi') \sin A \cos \zeta';$$

the latter quantity may generally be neglected.

2. To find the parallax of the moon in right ascension and declination from the true (or geocentric) right ascension and declination.

Put 
$$\sin \theta = \frac{\rho \sin \pi \cos \phi' \cos t}{\cos \delta}$$
 then 
$$\tan(\alpha - \alpha') = \tan \theta \tan(45^\circ + \frac{1}{2}\theta) \tan t.$$
 Put 
$$\tan \gamma = \frac{\tan \phi' \cos \frac{1}{2}(\alpha - \alpha')}{\cos[t + \frac{1}{2}(\alpha - \alpha')]};$$

$$\sin \delta' = \frac{\rho \sin \pi \sin \phi' \cos(\gamma - \delta)}{\sin \gamma};$$
 then 
$$\tan(\delta - \delta') = \tan \theta' \tan(45^\circ + \frac{1}{2}\theta') \tan(\gamma - \delta).$$

3. To find the parallax of the moon in right ascension and declination from the observed (or apparent) right ascension and declination.<sup>2</sup>

$$\sin(\alpha - \alpha') = \frac{\rho \sin \pi \cos \phi' \sin t'}{\cos \delta};$$

$$\tan \gamma = \frac{\tan \phi' \cos \frac{1}{2}(\alpha - \alpha')}{\cos[t' - \frac{1}{2}(\alpha - \alpha')]};$$

$$\sin(\delta - \delta') = \frac{\rho \sin \pi \sin \phi' \sin(\gamma - \delta')}{\sin \gamma}.$$

*bourg*, ser. vii. vol. 1. (0°-147±0°-009!); Brunnow, *Dunskob Observations*, vol. 1. (0°-212±0°-012), vol. II. (0°-188±0°-038); Hall, *Washington Observations*, 1879, Appendix I. (0°-180±0°-006). 9. Krueger (heliometer), *Ast. Nach.*, 1408 (0°-162±0°-007). 10. Johnson (heliometer), *Radcliffe Obs.*, vol. xvi. p. xxiii (0°-138±0°-052). 11. Wichmann (heliometer), *Ast. Nach.*, No. 841 (0°-087±0°-02); Brunnow, *Dunskob Obs.*, vol. II. (0°-089±0°-017). 12. Brunnow, *Ibid.* (0°-070±0°-014). 13. Brunnow, *Ibid.* (0°-054±0°-019). 14. Gill and Elkin, *Mém. R. A. S.*, vol. xviii. p. 40 (0°-747±0°-018), p. 51 (0°-76±0°-021), p. 71 (0°-78±0°-028), p. 82 (0°-68±0°-027), independent investigations. 15. Gill and Elkin, *Ibid.*, p. 97 (0°-87±0°-009), p. 115 (0°-39±0°-028), independent investigations. 16. Gill, *Ibid.*, p. 154 (0°-285±0°-003). 17. Gill and Elkin, *Ibid.*, p. 130 (0°-27±0°-002), p. 138 (0°-170±0°-008). 18. Gill, *Ibid.*, p. 160 (0°-166±0°-016). 19. Elkin, *Ibid.*, p. 180 (0°-14±0°-002). 20. Elkin, *Ibid.*, p. 174 (0°-06±0°-002). 21. Elkin, *Ibid.*, p. 184 (0°-08±0°-008). 22. Gill, *Ibid.*, p. 187 (0°-018±0°-019).

<sup>1</sup> In the case of the sun, planets, and comets this distance is generally expressed in terms of the earth's mean distance from the sun, that distance being reckoned unity.

<sup>2</sup> Here  $\zeta$  must first be found by subtracting the value of  $\zeta' - \zeta$  from the observed value of  $\zeta'$ .

<sup>3</sup> In preliminary computation of  $(\alpha - \alpha')$  employ  $\delta'$  for  $\delta$ . With this value compute  $\gamma$  and  $\delta - \delta'$ . Finally, with resulting value of  $\delta$ , correct preliminary computation of  $\alpha - \alpha'$ .

4. To find the parallax of the sun, planets, or comets in right ascension or declination.<sup>4</sup>

$$a - a' = \frac{\rho \pi \cos \phi' \sin t'}{\cos \delta'}$$

$$\tan \gamma = \frac{\tan \phi'}{\cos \delta'};$$

$$\delta - \delta' = \frac{\rho \pi \sin \phi' \sin(\gamma - \delta')}{\sin \gamma}.$$

When the distance of the object from the earth ( $\Delta$ ) is given (the earth's mean distance from the sun being reckoned unity), as is usually the case in ephemerides of minor planets and comets, we have

$$\pi = \frac{\text{mean solar parallax} \times \frac{\delta' \gamma \delta}{\Delta}}$$

The reader will find the proof of these formulæ in Chauvenet's *Spherical and Practical Astronomy*, vol. i. pp. 104-127.

*For the Parallax of the Fixed Stars.*

- Put  $p$  — the maximum angle subtended by the mean distance of the earth from the sun at the distance of the star,  
 $\epsilon$  — the star's annual parallax;  
 $\sigma$  — the obliquity of the ecliptic;  
 $\odot$  and  $\gamma$  — the sun's longitude and radius vector;  
 $\alpha$  and  $\alpha'$  — the star's true and apparent right ascensions and  $\delta$  and  $\delta'$  — declinations respectively.

1. To find the heliocentric parallax of a star in right ascension and declination, its annual parallax ( $p$ ) being known.

$$\alpha' - \alpha = -p \sec \delta (\cos \odot \sin \alpha - \sin \odot \cos \alpha);$$

$$\delta' - \delta = -p \sin \odot (\cos \epsilon \sin \delta \sin \alpha - \sin \epsilon \cos \delta) - p \cos \odot \cos \alpha.$$

2. To find the effect of parallax on the distance ( $\rho$ ) and position angle ( $P$ ) of two stars, one of which has sensible annual parallax.<sup>5</sup>

$$\Delta \rho = p \rho \cos(\odot - M);$$

$$\Delta P = p \rho \sin \cos(\odot - M);$$

where

$$\sin M = (-\cos \alpha \sin P + \sin \delta \sin \alpha \cos P) \cos \epsilon - \cos \delta \cos P \sin \epsilon;$$

$$\cos M = \sin \alpha \sin P + \sin \delta \cos \alpha \cos P;$$

$$\sin M' = \frac{1}{2} [ -(\cos \alpha \cos P + \sin \delta \sin \alpha \sin P) \cos \epsilon + \cos \delta \sin P \sin \epsilon ];$$

$$\cos M' = \frac{1}{2} [ \sin \alpha \cos P - \sin \delta \cos \alpha \sin P ].$$

(D. GI.)

**PARALLELS, THEORY OF.** The fundamental principles of mathematics have not in general received from mathematicians the attention which they deserve. Mathematical science might in fact be compared to a building far advanced in construction. As to the firmness of its foundations there can be no doubt, to judge by the weighty superstructure which they carry; but the aspect of the building is not a little marred by the quantity of irrelevant rubbish which lies around those foundations, concealing their real strength and security. The question of the parallel axiom in Euclid's geometry is to some extent an exception. There have been endless discussions concerning it. The difficulty is well known, and will be found succinctly stated in the article GEOMETRY (vol. x. p. 378). Those who have treated the subject have devoted themselves either to criticising the form of Euclid's axiom, suggesting modifications or substitutes (sometimes with undoubted advantage, *ag.*, Playfair), or to questioning its necessity, offering either to demonstrate the axiom or to dispense with it altogether. It would serve no useful purpose to attempt a complete account of the literature of the subject; we may refer the reader who is curious in such matters to the various editions of Perrenet Thomson's *Geometry without Axioms*. It will be sufficient to mention Legendre's views, which, although by no means reaching to the root of the matter, may be held as indicating the dawn of the true theory.<sup>6</sup> The delicacy of the question

<sup>4</sup>  $\alpha$  and  $\delta$  may be used instead of  $\alpha'$  and  $\delta'$  in these formulæ without sensible error.

<sup>5</sup> The position angle is to be reckoned from north through east, the star which has sensible parallax being taken for origin.

<sup>6</sup> Obviously, also,  $P$  may here express the relative parallax of the two stars.

<sup>7</sup> For some interesting controversy on this subject see Leslie's *Geometry*, 8d edition, p. 292; and Legendre, *Éléments de Géométrie*, 12th edition, p. 377.



may be illustrated by the story which is told of Lagrange. It is said that towards the end of his life he wrote and actually took to the Institute a paper dealing with the theory of parallels. He had begun to read it; but, before he had proceeded very far, something struck him. He stopped reading, muttered "Il faut que j'y songe encore," and put the paper in his pocket (De Morgan, *Budget of Paradoxes*, p. 173). There appears to be no doubt that the true theory first presented itself to the mind of Gauss. The history of the matter is interesting, and deserves to be more generally known than it appears to be. In his earlier days, before his career in life was determined, when he had to consider the possibility of his becoming a teacher of mathematics, he drew up a paper in which he gave a philosophical development of the elements of mathematics. It was probably in the course of this discussion (about 1792) that he first came across the difficulty of the parallel axiom. He arrived at the conclusion that geometry became a logically consistent structure only after the parallel axiom was given as part of its foundation; and he convinced himself that this axiom could not be proved, although from experience (for example, from the sum of the angles of the geodesic triangle Brocken, Hohenhagen, Inselberg) we know that it is at least very approximately true. If, on the other hand, this axiom be not granted, there follows another kind of geometry, which he developed to a considerable extent and called the anti-Euclidian geometry.<sup>1</sup> Writing to Bessel on the 27th January 1829, he says—

"In leisure hours now and then I have again been reflecting on a subject which with me is now nearly forty years old; I mean the first principles of geometry; I do not know if I have ever told you my views on that matter. Here too I have carried many things to farther consolidation, and my conviction that we cannot lay the foundation of geometry completely *a priori* has become if possible firmer than before. Meantime it will be long before I bring myself to work out my very extensive researches on this subject for publication, perhaps I shall never do so during my lifetime; for I fear the outcry of the Boeotians, were I to speak out my views on the question."

Bessel entered heartily into the ideas of Gauss, and urged him to publish them regardless of the Boeotians. Concerning the generality of mathematicians in his day, Gauss probably judged rightly, however, for his intimate correspondent Schumacher was, as we learn from their correspondence in 1831, unable to follow the new idea. One of the letters (Gauss to Schumacher, 12th July 1831) is of great interest, because it shows us that Gauss was then in full possession of the most important propositions of what is now called hyperbolic geometry. In particular he states that in hyperbolic space the circumference of a

circle of radius  $r$  is  $\pi k \left( \frac{r}{e^k} - \frac{r}{e^{-k}} \right)$ , where  $k$  is a constant, which we know from experience to be infinitely great compared with any length that we can measure (supposing, he means, the space of our experience to be hyperbolic), and which in Euclid's geometry is infinite.

Gauss never published these researches; and no traces of them seem to have been found among his papers after his death. Our first knowledge of the hyperbolic geometry dates from the publication of the works of N. Lobatschewsky and W. Bolyai. Lobatschewsky's views were first published in a lecture before the Faculty of Mathematics and Physics in Kasan, 12th February 1828. See Frischau, *Elemente der Absoluten Geometrie*, Leipzig, 1876, page 32. Speaking of a German edition of Lobatschewsky's work, which he had seen published at Berlin in 1840, Gauss says that he finds nothing in it which is materially new to him, but that Lobatschewsky's method of development is different from his own, and is a masterly performance carried out in the true geometric spirit. The theory received its complement in the famous *Habilitationschrift* of Riemann, in which the elliptic geometry for the first time appears. Beltrami, Helmholtz, Cayley, Klein, and others have greatly developed the subject; but it is

unnecessary to pursue its later history here, since all essential details will be found in the article MEASUREMENT, vol. xv, p. 659. All that we need do is to call the attention of those who busy themselves with mental philosophy to this generalization of geometry, as one of the results of modern mathematical research which they cannot afford to overlook. (G. CH.)

PARALYSIS,<sup>2</sup> or PALSÝ, the loss of the power of muscular action due to some interruption to the nervous mechanism by means of which such action is excited (see "Nervous System" in PHYSIOLOGY). In its strict sense the term might include the loss of the influence of the nervous system or any of the bodily functions, the loss of common sensation or of any of the special senses; but other terms have come to be associated with these latter conditions, and the word "paralysis" in medical nomenclature is usually restricted to the loss or impairment of voluntary muscular power. Paralysis is to be regarded rather as a symptom than a disease *per se*, and is generally connected with some well-marked lesion of some portion of the nervous system. According to the locality and extent of the nervous system affected, so will be the form and character of the paralysis. It is usual to regard paralysis as depending on disease either of the brain, of the spinal cord, or of the nerves distributed to parts and organs; and hence the terms cerebral, spinal, and peripheral paralysis respectively. The distribution of the paralytic condition may be very extensive, tending to involve in greater or less measure all the functions of the body, as in the general paralysis of the insane (see INSANITY); or again, one half of the body may be affected, or one or more extremities, or it may be only a certain group of muscles in a part supplied by a particular nerve. Reference can be made here only to the more common varieties of paralysis, and that merely in general terms.

1. *Paralysis due to Brain Disease*.—Of this by far the most common form is palsy affecting one side of the body, or *Hemiplegia*. It usually arises from disease of the hemisphere of the brain opposite to the side of the body affected, such disease being in the form of hæmorrhage into the brain substance, or the occlusion of blood-vessels, and consequent arrest of the blood supply to an area of the brain; or again it may be due to the effect of an injury, or to a tumour or morbid growth in the tissues of the brain. The character of the seizure and the amount of paralysis vary according to the situation of the disease or injury, its extent, and its sudden or gradual occurrence. The attack may come on as a fit of apoplexy, in which the patient becomes suddenly unconscious, and loses completely the power of motion of one side of the body; or a like result may arise more gradually and without loss of consciousness. In either case of "complete" hemiplegia the paralysis affects more or less the muscles of the tongue, face, trunk, and extremities. Speech is thick and indistinct, and the tongue, when protruded, points towards the paralysed side owing to the unopposed action of its muscles on the unaffected side. The muscles of the face implicated are chiefly those of mastication. The paralysed side hangs loose, and the corner of the mouth is depressed, but the muscles closing the eye are as a rule unimpaired, so that the eye can be shut, unlike what occurs in another form of facial paralysis (Bell's palsy). The muscles of respiration on the affected side, although weakened, are seldom wholly paralysed, but those of the arm and leg are completely powerless. Sensation may at the first be impaired, but as a rule returns soon, unless the portion of the brain affected be that which is connected with this function. Rigidity of the paralysed members is occasionally present as an early or a late symptom. In many cases of even complete hemiplegia improvement takes place after the lapse of

<sup>1</sup> Sartorius von Waltershausen, *Gauss sein Gedächtniss*, Leipzig, 1856, p. 81.

<sup>2</sup> From *παράλυσις*, to relax. Wickliffe has *palsery*, and another old form of the word is *parlesy*.

weeks or months, and is in general first indicated by a return of motor power in the leg, that of the arm following at a longer or shorter interval. Such recovery of movement is, however, in a large proportion of cases only partial, and the side remains weakened. In such instances the gait of the patient is characteristic. In walking he leans to the sound side and swings round the affected limb from the hip, the foot scraping the ground as it is raised and advanced. Besides this the evidence of the "shock" is felt more or less upon the system generally, the patient rarely (though occasionally) recovering his nervous stability. The paralysed parts retain as a rule their electric contractility, but they are apt to suffer in their nutrition both from disuse and also from certain degenerative changes which the interruption of nervous influence is apt to exercise upon them.

It is to be observed that in many instances the hemiplegia is only partial, and instead of the symptoms of complete paralysis above described there exist in varied combination only certain of them, their association depending on the extent and locality of the lesion in the brain. Thus there may be impairment of speech and some amount of facial paralysis, while the arm and leg may be unaffected, or the paralysis may be present in one or both extremities of one side while the other symptoms are absent. Further, the paralysis may be incomplete throughout, and the whole of the side be weak, but not entirely deprived of motor power. To partial paralysis of this latter description the term "paresis" is applied.

Besides hemiplegia, various other forms of paralysis may arise from cerebral disease. Thus occasionally the paralysis is crossed, one side of the face and the opposite side of the body being affected simultaneously. Or again, as is frequently observed in the case of tumours of the brain, the paralysis may be limited to the distribution of one of the cranial nerves, and may produce an association of phenomena (such as squinting, drooping of the eyelid, and impairment or loss of vision) which may enable the seat of the disease to be accurately localized.

2. *Paralysis due to Disease of the Spinal Cord.*—Of paralysis from this cause there are numerous varieties depending on the nature, the site, and the extent of the disease. Some of the more important only can be noticed.

*Paraplegia*, paralysis of both lower extremities, including usually the lower portion of the trunk, and occasionally also the upper portion—indeed the whole parts below the seat of the disease in the spinal cord—is a form of paralysis which is a not unfrequent result of injuries or disease of the vertebral column; also of inflammation affecting the spinal cord (MYELITIS, *q.v.*), as well as of hæmorrhage or morbid growths involving its substance. When due to disease, the lesion is generally situated in the lower portion of the cord. The phenomena necessarily vary in relation to the locality and the extent of the disease in the cord. Thus, if in the affected area the posterior part of the cord, including the posterior nerve roots, suffer, the function of sensation in the parts below is impaired because the cord is unable to transmit the sensory impressions from the surface of the body to the brain. If on the other hand the anterior portion of the cord and anterior nerves be affected, the motor impulses from the brain cannot be conveyed to the muscles below the seat of the injury or disease, and consequently their power of movement is abolished. In many forms of this complaint, particularly in the case of injuries, the whole thickness of the cord is involved, and both sensory and motor functions are arrested. Further, the functions of the bladder and bowels are apt to suffer, and either spasm or paralysis of these organs is the result. The nutrition of the paralysed parts tends to become affected, and

bed-sores and wasting of the muscles are common. Occasionally, more especially in cases of injury, recovery takes place, but in general this is incomplete, the power of walking being more or less impaired. On the other hand the patient may linger on for years bedridden, and at last succumb to exhaustion or to some intercurrent disease.

A form of spinal paralysis, often showing itself as paraplegia, occasionally occurs in children, and is termed—

*Infantile or Essential Paralysis.*—It is caused by an inflammatory affection limited to the anterior portion of the grey matter of the spinal cord throughout a greater or less extent, and affects therefore the function of motion, leaving that of sensation unimpaired. This disease is most common during the period of first dentition (although a similar affection is sometimes observed in adults). The commencement may be insidious, or there may be an acute febrile attack lasting for several days. In either case paralysis comes on, at first very extensive, involving both upper and lower extremities, but tending soon to become more limited and confined to one or other limb or even to a group of muscles. The affected muscles lose their electric contractility and are apt to waste. Hence limbs become shortened, shrivelled, and useless, and deformities such as club foot may thus be readily produced. In many instances fortunately recovery is complete, and the prospect of amendment is all the greater if the muscles show any reaction to electricity. There is throughout an absence of some of the more distressing of the phenomena of paraplegia, such as disturbances of the bladder and bowels or extensive bed-sores, and in general the health of the child does not materially suffer.

*Progressive Muscular Atrophy or Wasting Palsy* is a disease usually occurring in early or middle life. It is characterized by the wasting of certain muscles or groups of muscles accompanied with a corresponding weakness or paralysis of the affected parts, and is believed to depend on a slow inflammatory change in the anterior cornua of the grey matter of the spinal cord. It is insidious in its onset, and usually first shows itself in the prominent muscular masses in the palm of the hand, especially the ball of the thumb, which becomes wasted and deficient in power. The other palmar muscles suffer in like manner, and as the disease advances the muscles of the arm, shoulders, and trunk become implicated if they have not themselves been the first to be attacked. The malady tends to spread symmetrically, involving the corresponding parts of the opposite side of the body in succession. It is slow in its progress, but, notwithstanding it may occasionally undergo arrest, it tends to advance and involve more and more of the muscles of the body until the sufferer is reduced to a condition of extreme helplessness. Should some other ailment not be the cause of death, the fatal result may be due to the disease extending so as to involve the muscles of respiration.

Another form of paralysis in certain respects resembling the last, and supposed by some to be due to a similar cause, is *Pseudo-hypertrophic Paralysis*, a condition occurring most frequently in male children, in whom in such cases there exists at first a remarkable enlargement of certain muscles or groups of muscles, followed sooner or later by wasting and paralysis. The enlarged muscles are chiefly those of the calf and hips, and their abnormal size is caused by an over-development of their connective tissue, and is therefore not a true hypertrophy. The child acquires a peculiar attitude and gait. He stands with his legs widely separated, his body arched forward, and in walking assumes a rocking or waddling movement. Later on the enlarged muscles lose their bulk, and at the same time become weakened in power, so that walking becomes impossible, and the child is completely paralysed in the

limbs and all other affected parts. In most instances death takes place from some intercurrent disease before maturity.

*Paralysis Agitans* or *Trembling Palsy* is a peculiar form of paralysis characterized chiefly by trembling movements in certain parts, tending to become more widely diffused throughout the body. It is a disease of advanced life. The symptoms come on somewhat insidiously, and first show themselves chiefly by involuntary tremblings of the muscles of the fingers, hand, arm, or leg, which are aggravated on making efforts or under excitement. These trembling movements become more marked and more extensive with the advance of the disease, and along with the tremors there generally occurs increasing weakness of the affected muscles. This is very manifest in walking, the act being performed in a peculiar tottering manner with the body bent forward. The trembling movements cease during sleep. This disease is a chronic one, and is intractable to treatment, but life may be prolonged for many years.

*Glossolabio-laryngeal Paralysis* is a form of paralysis affecting, as its name indicates, the functions of the tongue, lips, and larynx (besides others), and depending upon disease of certain localities in the medulla oblongata from which the nerves presiding over these functions arise. The symptoms come on slowly, and are generally first manifested in some difficulty of speech owing to impaired movements of the tongue. Associated with this there is more or less difficulty in swallowing, owing to paralysis of the muscles of the pharynx and soft palate, by which also the voice is rendered nasal. With the advance of the disease the paralysis of the tongue becomes more marked. It cannot be protruded, and frequently undergoes atrophy. Certain of the facial muscles become implicated, especially those in the neighbourhood of the mouth. The features become expressionless, the lips cannot be moved in speaking, the mouth remains open, and the saliva flows abundantly. The muscles of the larynx may also be involved in the paralysis. In the later stages of the malady the power of speech is completely lost, the difficulty in swallowing increases to a degree that threatens suffocation, the patient's condition altogether is one of great misery, which is in no way mitigated by the fact of his mental power remaining unaffected. Complications connected with the respiratory or circulatory functions, or disease affecting other parts of the nervous system with which this complaint may be associated, often terminate the patient's sufferings, and in any case life is seldom prolonged beyond two or three years.

3. *Peripheral Paralysis*, or local paralysis of individual nerves, is of not unfrequent occurrence. The most common and important examples of this condition can only be briefly referred to.

*Facial Paralysis*, *Bell's Palsy*, are the terms applied to paralysis involving the muscles of expression supplied by the seventh nerve. It is unilateral, and generally occurs as the result of exposure of one side of the head to a draught of cold air which sets up inflammation of the nerve as it passes through the aqueductus Fallopii, but it may also be due to injury or disease either affecting the nerve near the surface or deeper in the bony canals through which it passes, or in the brain itself involving the nerve at its origin. Here the paralysis is manifested by a marked change in the expression of the face, the patient being unable to move the muscles of one side in such acts as laughing, whistling, &c., or to close the eye on that side. The mouth is drawn to the sound side, while, although the muscles of mastication are not involved, the food in eating tends to lodge between the jaw and cheek on the palsied side. Occasionally the sense of taste is

impaired. In the ordinary cases of this disease, such as those due to exposure, recovery usually takes place in from two to six weeks, the improvement being first shown in the power of closing the eye, which is soon followed by the disappearance of the other morbid phenomena. When the paralysis proceeds from disease of the temporal bone, or from tumours or growths in the brain, it is more apt to be permanent, and is in many cases of serious import. Throughout there is no diminution of sensibility in the paralysed muscles; but they early lose their reaction to faradization, retaining that to galvanism.

*Lead Palsy* is a not uncommon form of local paralysis. It is due to the poisonous action of lead upon the system, and, like the other phenomena of lead poisoning, affects chiefly workers in that metal (see LEAD). The pathology of this disease is still unsettled, but it is believed to depend upon the local effect of the lead upon the nerves of the part rather than to any disease, at least in the first instance, of the nerve centres. The paralysis in this case is as a rule confined to the muscles of the forearm which extend the hand, and as they lose entirely their power the hand cannot be raised when the arm is held out, which gives rise to the condition termed "wrist drop." The paralysis may come to affect other muscles of the arms as well as certain of those of the legs and trunk, and along with the paralysis there occurs wasting of the affected muscles and loss of their electrical reactions. Occasionally in severe cases other nervous phenomena, such as convulsions, delirium, &c., may become superadded. The symptoms usually disappear on the removal of the patient from the source of lead contamination, along with the application of the treatment appropriate to poisoning with this metal,—and all the more speedily if the case has not been of long duration and the affected muscles have not undergone atrophic change.

A form of peripheral paralysis not unlike the last occasionally results from chronic alcoholism. The paralysis occurring after diphtheria, another example of the peripheral variety, has been already referred to (see DIPHTHERIA).

*Treatment*.—It is impossible in a general notice like the present to refer at any length to the treatment of paralysis. The conditions of the disease in any particular case and its associations are so manifold that they can only be fully understood and appreciated by the medical expert under whose direction alone treatment can be advantageously carried out. It may be stated generally, however, that, since paralysed muscles tend to undergo certain degenerative changes (see PATHOLOGY), it becomes an object in treatment to endeavour to maintain as long as possible their molecular integrity. With this view, when pain and other acute symptoms which may be present have ceased, the use of nerve tonics such as iron, quinine, and strychnine, and the suitable dieting of the patient, are the best constitutional remedies; while of local applications frictions or massage, but more particularly the employment of electricity, will be found of service, the latter agent often yielding markedly beneficial results. (J. O. A.)

PARAMARIBO, the administrative and commercial capital of Dutch Guiana or Surinam, is situated in 5° 44' 30" N. lat. and 55° 12' 54" W. long., on the right bank of the Surinam, which, though at that point 20 miles from the sea, is a tidal river nearly a mile broad and 18 feet deep. Built on a plateau about 16 feet above low-water level, Paramaribo is well-drained, clean, and in general healthy; the straight canals running at right angles to the river, the broad, straight, tree-planted streets, the spacious squares, and the solid if plain-looking public buildings would not be unworthy of a town in the Netherlands. Among the more conspicuous edifices

weeks or months, and is in general first indicated by a return of motor power in the leg, that of the arm following at a longer or shorter interval. Such recovery of movement is, however, in a large proportion of cases only partial, and the side remains weakened. In such instances the gait of the patient is characteristic. In walking he leans to the sound side and swings round the affected limb from the hip, the foot scraping the ground as it is raised and advanced. Besides this the evidence of the "shock" is felt more or less upon the system generally, the patient rarely (though occasionally) recovering his nervous stability. The paralysed parts retain as a rule their electric contractility, but they are apt to suffer in their nutrition both from disuse and also from certain degenerative changes which the interruption of nervous influence is apt to exercise upon them.

It is to be observed that in many instances the hemiplegia is only partial, and instead of the symptoms of complete paralysis above described there exist in varied combination only certain of them, their association depending on the extent and locality of the lesion in the brain. Thus there may be impairment of speech and some amount of facial paralysis, while the arm and leg may be unaffected, or the paralysis may be present in one or both extremities of one side while the other symptoms are absent. Further, the paralysis may be incomplete throughout, and the whole of the side be weak, but not entirely deprived of motor power. To partial paralysis of this latter description the term "paresis" is applied.

Besides hemiplegia, various other forms of paralysis may arise from cerebral disease. Thus occasionally the paralysis is crossed, one side of the face and the opposite side of the body being affected simultaneously. Or again, as is frequently observed in the case of tumours of the brain, the paralysis may be limited to the distribution of one of the cranial nerves, and may produce an association of phenomena (such as squinting, drooping of the eyelid, and impairment or loss of vision) which may enable the seat of the disease to be accurately localized.

2. *Paralysis due to Disease of the Spinal Cord.*—Of paralysis from this cause there are numerous varieties depending on the nature, the site, and the extent of the disease. Some of the more important only can be noticed.

*Paraplegia*, paralysis of both lower extremities, including usually the lower portion of the trunk, and occasionally also the upper portion—indeed the whole parts below the seat of the disease in the spinal cord—is a form of paralysis which is a not unfrequent result of injuries or disease of the vertebral column; also of inflammation affecting the spinal cord (MYELITIS, *q.v.*), as well as of hæmorrhage or morbid growths involving its substance. When due to disease, the lesion is generally situated in the lower portion of the cord. The phenomena necessarily vary in relation to the locality and the extent of the disease in the cord. Thus, if in the affected area the posterior part of the cord, including the posterior nerve roots, suffer, the function of sensation in the parts below is impaired because the cord is unable to transmit the sensory impressions from the surface of the body to the brain. If on the other hand the anterior portion of the cord and anterior nerves be affected, the motor impulses from the brain cannot be conveyed to the muscles below the seat of the injury or disease, and consequently their power of movement is abolished. In many forms of this complaint, particularly in the case of injuries, the whole thickness of the cord is involved, and both sensory and motor functions are arrested. Further, the functions of the bladder and bowels are apt to suffer, and either spasms or paralysis of these organs is the result. The nutrition of the paralysed parts tends to become affected, and

bed-sores and wasting of the muscles are common. Occasionally, more especially in cases of injury, recovery takes place, but in general this is incomplete, the power of walking being more or less impaired. On the other hand the patient may linger on for years bedridden, and at last succumb to exhaustion or to some intercurrent disease.

A form of spinal paralysis, often showing itself as paraplegia, occasionally occurs in children, and is termed—*Infantile or Essential Paralysis.*—It is caused by an inflammatory affection limited to the anterior portion of the grey matter of the spinal cord throughout a greater or less extent, and affects therefore the function of motion, leaving that of sensation unimpaired. This disease is most common during the period of first dentition (although a similar affection is sometimes observed in adults). The commencement may be insidious, or there may be an acute febrile attack lasting for several days. In either case paralysis comes on, at first very extensive, involving both upper and lower extremities, but tending soon to become more limited and confined to one or other limb or even to a group of muscles. The affected muscles lose their electric contractility and are apt to waste. Hence limbs become shortened, shrivelled, and useless, and deformities such as club foot may thus be readily produced. In many instances fortunately recovery is complete, and the prospect of amendment is all the greater if the muscles show any reaction to electricity. There is throughout an absence of some of the more distressing of the phenomena of paraplegia, such as disturbances of the bladder and bowels or extensive bed-sores, and in general the health of the child does not materially suffer.

*Progressive Muscular Atrophy or Wasting Palsy* is a disease usually occurring in early or middle life. It is characterized by the wasting of certain muscles or groups of muscles accompanied with a corresponding weakness or paralysis of the affected parts, and is believed to depend on a slow inflammatory change in the anterior cornua of the grey matter of the spinal cord. It is insidious in its onset, and usually first shows itself in the prominent muscular masses in the palm of the hand, especially the ball of the thumb, which becomes wasted and deficient in power. The other palmar muscles suffer in like manner, and as the disease advances the muscles of the arm, shoulders, and trunk become implicated if they have not themselves been the first to be attacked. The malady tends to spread symmetrically, involving the corresponding parts of the opposite side of the body in succession. It is slow in its progress, but, notwithstanding it may occasionally undergo arrest, it tends to advance and involve more and more of the muscles of the body until the sufferer is reduced to a condition of extreme helplessness. Should some other ailment not be the cause of death, the fatal result may be due to the disease extending so as to involve the muscles of respiration.

Another form of paralysis in certain respects resembling the last, and supposed by some to be due to a similar cause, is *Pseudo-hypertrophic Paralysis*, a condition occurring most frequently in male children, in whom in such cases there exists at first a remarkable enlargement of certain muscles or groups of muscles, followed sooner or later by wasting and paralysis. The enlarged muscles are chiefly those of the calf and hips, and their abnormal size is caused by an over-development of their connective tissue, and is therefore not a true hypertrophy. The child acquires a peculiar attitude and gait. He stands with his legs widely separated, his body arched forward, and in walking assumes a rocking or waddling movement. Later on the enlarged muscles lose their bulk, and at the same time become weakened in power, so that walking becomes impossible, and the child is completely paralysed in the

limbs and all other affected parts. In most instances death takes place from some intercurrent disease before maturity.

*Paralysis Agitans or Trembling Palsy* is a peculiar form of paralysis characterized chiefly by trembling movements in certain parts, tending to become more widely diffused throughout the body. It is a disease of advanced life. The symptoms come on somewhat insidiously, and first show themselves chiefly by involuntary tremblings of the muscles of the fingers, hand, arm, or leg, which are aggravated on making efforts or under excitement. These trembling movements become more marked and more extensive with the advance of the disease, and along with the tremors there generally occurs increasing weakness of the affected muscles. This is very manifest in walking, the act being performed in a peculiar tottering manner with the body bent forward. The trembling movements cease during sleep. This disease is a chronic one, and is intractable to treatment, but life may be prolonged for many years.

*Glossio-laryngeal Paralysis* is a form of paralysis affecting, as its name indicates, the functions of the tongue, lips, and larynx (besides others), and depending upon disease of certain localities in the medulla oblongata from which the nerves presiding over these functions arise. The symptoms come on slowly, and are generally first manifested in some difficulty of speech owing to impaired movements of the tongue. Associated with this there is more or less difficulty in swallowing, owing to paralysis of the muscles of the pharynx and soft palate, by which also the voice is rendered nasal. With the advance of the disease the paralysis of the tongue becomes more marked. It cannot be protruded, and frequently undergoes atrophy. Certain of the facial muscles become implicated, especially those in the neighbourhood of the mouth. The features become expressionless, the lips cannot be moved in speaking, the mouth remains open, and the saliva flows abundantly. The muscles of the larynx may also be involved in the paralysis. In the later stages of the malady the power of speech is completely lost, the difficulty in swallowing increases to a degree that threatens suffocation, the patient's condition altogether is one of great misery, which is in no way mitigated by the fact of his mental power remaining unaffected. Complications connected with the respiratory or circulatory functions, or disease affecting other parts of the nervous system with which this complaint may be associated, often terminate the patient's sufferings, and in any case life is seldom prolonged beyond two or three years.

3. *Peripheral Paralysis*, or local paralysis of individual nerves, is of not infrequent occurrence. The most common and important examples of this condition can only be briefly referred to.

*Facial Paralysis, Bell's Palsy*, are the terms applied to paralysis involving the muscles of expression supplied by the seventh nerve. It is unilateral, and generally occurs as the result of exposure of one side of the head to a draught of cold air which sets up inflammation of the nerve as it passes through the aqueductus Fallopii, but it may also be due to injury or disease either affecting the nerve near the surface or deeper in the bony canals through which it passes, or in the brain itself involving the nerve at its origin. Here the paralysis is manifested by a marked change in the expression of the face, the patient being unable to move the muscles of one side in such acts as laughing, whistling, &c., or to close the eye on that side. The mouth is drawn to the sound side, while, although the muscles of mastication are not involved, the food in eating tends to lodge between the jaw and cheek on the palsied side. Occasionally the sense of taste is

impaired. In the ordinary cases of this disease, such as those due to exposure, recovery usually takes place in from two to six weeks, the improvement being first shown in the power of closing the eye, which is soon followed by the disappearance of the other morbid phenomena. When the paralysis proceeds from disease of the temporal bone, or from tumours or growths in the brain, it is more apt to be permanent, and is in many cases of serious import. Throughout there is no diminution of sensibility in the paralyzed muscles; but they early lose their reaction to faradization, retaining that to galvanism.

*Lead Palsy* is a not uncommon form of local paralysis. It is due to the poisonous action of lead upon the system, and, like the other phenomena of lead poisoning, affects chiefly workers in that metal (see LEAD). The pathology of this disease is still unsettled, but it is believed to depend upon the local effect of the lead upon the nerves of the part rather than to any disease, at least in the first instance, of the nerve centres. The paralysis in this case is as a rule confined to the muscles of the forearm which extend the hand, and as they lose entirely their power the hand cannot be raised when the arm is held out, which gives rise to the condition termed "wrist drop." The paralysis may come to affect other muscles of the arms as well as certain of those of the legs and trunk, and along with the paralysis there occurs wasting of the affected muscles and loss of their electrical reactions. Occasionally in severe cases other nervous phenomena, such as convulsions, delirium, &c., may become superadded. The symptoms usually disappear on the removal of the patient from the source of lead contamination, along with the application of the treatment appropriate to poisoning with this metal,—and all the more speedily if the case has not been of long duration and the affected muscles have not undergone atrophic change.

A form of peripheral paralysis not unlike the last occasionally results from chronic alcoholism. The paralysis occurring after diphtheria, another example of the peripheral variety, has been already referred to (see DIPHTHERIA).

*Treatment.*—It is impossible in a general notice like the present to refer at any length to the treatment of paralysis. The conditions of the disease in any particular case and its associations are so manifold that they can only be fully understood and appreciated by the medical expert under whose direction alone treatment can be advantageously carried out. It may be stated generally, however, that, since paralyzed muscles tend to undergo certain degenerative changes (see PATHOLOGY), it becomes an object in treatment to endeavour to maintain as long as possible their molecular integrity. With this view, when pain and other acute symptoms which may be present have ceased, the use of nerve tonics such as iron, quinine, and strychnine, and the suitable dieting of the patient, are the best constitutional remedies; while of local applications frictions or massage, but more particularly the employment of electricity, will be found of service, the latter agent often yielding markedly beneficial results. (J. O. A.)

PARAMARIBO, the administrative and commercial capital of Dutch Guiana or Surinam, is situated in 5° 44' 30" N. lat. and 55° 12' 54" W. long., on the right bank of the Surinam, which, though at that point 20 miles from the sea, is a tidal river nearly a mile broad and 18 feet deep. Built on a plateau about 16 feet above low-water level, Paramaribo is well-drained, clean, and in general healthy; the straight canals running at right angles to the river, the broad, straight, tree-planted streets, the spacious squares, and the solid if plain-looking public buildings would not be unworthy of a town in the Netherlands. Among the more conspicuous edifices

are—Fort Zeelandia (used as a civil and military prison) at the north corner, between the town proper and the Combé suburb; the Government-house, surrounded by a magnificent garden and park; the town-house, with a tower 100 feet high; the law courts; the public hospital, where there is a remarkable betel-nut avenue 50 feet in height; the Reformed Dutch, Lutheran, Moravian, and Roman Catholic churches; and the Portuguese and Dutch synagogues. The population, barely 16,000 in 1854, was 20,373 in 1869, and 21,265 in 1878.

The Indian village of Paramaribo became the site of a French

settlement probably in 1640, and in 1650 it was made the capital of the colony by Lord Willoughby of Parham. In 1683 it was still only a "cluster of twenty-seven dwellings, more than half of them grog-shops," but by 1790 it counted more than a thousand houses. The town was partly burned down in 1821, and again in 1837.

PARANA. See PLATE RIVER.

PARANAHYBA (PARNAHYBA, or PERNAHYBA), SÃO LUIS DE, a city of Brazil, the chief port of the province of Piahy, is situated on the right bank of the important Rio de Paranahyba, near the beginning of its delta. It has a population of about 15,000, and trades in cotton, leather, &c., but its port is little visited by foreign steamers.

## P A R A S I T I S M

### ANIMAL PARASITISM.

THE problems suggested by the occurrence of parasites not only in the intestines or the kidneys but even in flesh and blood, in eye or brain, have occupied alike physician and naturalist from the earliest times. From ancient Egyptian and Jewish sanitary and religious codes we may perhaps infer considerable knowledge of the distribution and danger of parasites,—unclean animals like the pig, rabbit, and dog being peculiarly infested with them. The schoolmen, too, perplexed themselves with quaint hypotheses as to the time and place and mode of the introduction of the parasites of man, while the long persistence of mediæval myths is evidenced by the "Furia infernalis" of the *Systema Naturæ*. The spontaneous generation of parasites seems never to have been doubted until the commencement of the 18th century, when Redi proved the origin of maggots from eggs of the blow-fly, and Swammerdam announced the similar origin of lice and other insect parasites. Both naturalists, however, opposed the extension of their results to the *Entozoa*, but the discovery of microscopic animalcules, and the reflexion that these must readily be introduced into the body, induced Boerhaave to suggest the origin of parasites from free-living worms and infusorians. The sexuality and characteristics of a few *Entozoa* gradually became better known, while Linnæus, though little dreaming of their complex form-history, expelled the spontaneous generation theory by the in-so-far fortunate mistake of identifying the free *Bothriocephalus* of the stickleback as the young stage of *B. latus* of man, and certain free Planarians and Nematoids as the young of liver flukes and thread worms. His school vastly increased the hitherto scanty catalogue of known forms, while their exacter knowledge rendered his hypothesis improbable. The origin of *Entozoa* from eggs which leave the body of their host, enter new hosts in food or drink, and when developing in other organs than the alimentary are carried thither by the circulation, was clearly put forward by Pallas, who also revived the early view of inheritance, which had been propounded before by the contemporaries of Leeuwenhoek (then, however, to avoid the apparently insoluble difficulty of tracing the origin of the parasite from its innumerable yet apparently wasted ova). With the enormous labours of Rud. Aphi and Bremser helminthology rose to the rank of an important special study, yet the degeneration of the Linnæan school had nowhere fuller course: observation of faunistic and systematic detail excluded all physiological or morphological research, and the knotty problem of origin was simply cut by a return to the hypothesis of spontaneous generation. This view seemed supported by the absence of reproductive organs in cystic parasites, and reigned almost undisputed until the accumulation of a new chain of evidence. Of this the main links were the discovery of the ciliated larva of a Trematode (*Monostomum*) by Mehlis in 1831, of the *Redia* or *Cercaria* stages of the same genus, and of the

six-hooked embryo of *Tenia* by Siebold in 1835, and the renewed study of *Bothriocephalus latus* by Eschricht, who maintained that the encysted forms were persistently larval, and that the life-history of the *Entozoa* should be viewed as broadly parallel to that of parasitic insects. Yet in spite of all this, and of the corroborative researches of Valentin, many helminthologists remained obstinate, until these incredible life-histories had been confirmed and treated as so many other cases of the "Alternation of Generations" in the epoch-making work of Steenstrup (1842). Dujardin next observed the wanderings of *Mermis*, and Siebold those of *Gordius*; the latter, however, advanced the doctrine that cysts were not larval stages, but mere pathological modifications of those worms which had chanced to "wander" into situations unfitted for their normal life. Meanwhile were commencing the important labours of Van Beneden, who traced the actual development of the cystic parasites of the bony fishes into the tape-worms of the rays and dogfishes which had devoured them, so proving that the transmission of the parasites depended upon the mode of feeding. These results were soon confirmed by Küchenmeister, who not only transmuted cyst into tape-worm by transmission in food, but redeveloped the cystic form by feeding with eggs from the adult tape-worm, thus (1852-53) commencing the modern era of experimental helminthology. Häubner and Leuckart eagerly followed for the same group; Filippi, Valette, Pagenstecher, and Cobbold made similar investigations on Trematodes; while Leuckart transferred *Pentastomum* from rabbit to dog, and traced the formidable *Trichina* from pig to man. From this time (1860) the advances of our knowledge have been no longer in principle, though numerous and important, but in detail. To Küchenmeister, Cobbold, Davaine, and others, but more especially to Leuckart, we owe valuable general works; to the last the present article is especially indebted.<sup>1</sup>

Any discussion of parasitism with its difficulties and wide theoretic bearings should naturally be preceded by an account of the known facts. This would involve the preparation of two systematic lists,—the first enumerating the parasitic members of each animal group, while the second, from the point of view not of parasites but of hosts, would indicate the forms which are infested, stating by what parasites. Of these lists the following scanty outlines must suffice.

#### A. List of Parasites.

*Protozoa* (see PROTOZOA).—Amœboid organisms are occasionally detected in dysentery and kindred diseases; the best known of these is *Amœba coli*. Parasitic *Infusoria* occur much more frequently: thus in the paunch of sheep and oxen six species (*Ophryoscolix*, *Entodinium*, *Isotricha*) are constant; similarly in the rectum of the frog are invariably present *Opalina*, *Nyctotherus*, and *Balantidium*; while *B. coli*, first described from man, inhabits

<sup>1</sup> See Leuckart, *Die menschlichen Parasiten*, 2 vols., Leipzig, 1863-76; a second edition (commencing in 1870) is now in progress as *Die Parasiten des Menschen*; Cobbold, *Parasites*, London, 1870; Küchenmeister and Zürn, *Die Parasiten d. Menschen*, 1861; Ehrsch, *Handb. d. hist.-geogr. Pathol.*, 2d ed., vol. II., Stuttgart, 1863.



the pig. *Trichodina* infests Planarians. Flagellate parasites are more numerous: *Cercomonas intestinalis* is frequently observed in choleric affections; *Trichomonas intestinalis* and *vaginalis* are also described in diseases. In perhaps all invertebrates and cold-blooded vertebrates ciliate and flagellate parasites seem to occur. *Acinetes* are sometimes parasitic on other *Infusoria*.

By far the most important group, however, are the exclusively parasitic Gregarinida. These are very widely distributed among the tissues of invertebrates, especially worms and insects, and their normal life-history, is readily observed in the species infesting the tissues of the common earthworm. Their spores or pseudo-nascitella are apparently closely related to the pterospores frequently detected in both vertebrate and invertebrate tissues, and even in the liver and hair of the human subject.<sup>1</sup>

*Dicyemida*.—This group contains only one entirely parasitic genus, various species of which live in the renal organs of *Cephalopoda*. The adult consists essentially of a simple sac of finely ciliated ectodermal cells enclosing a single elongated endodermal cell, which discharges nutritive and reproductive functions. Some have attempted to demonstrate a mesoderm. The embryos are of two kinds, nematogenic or vermiform, and rhombogenic or infusiform, differing in origin, structure, and life-history, but of still uncertain relations and import. The infusiform embryo which becomes free is of complicated structure, and probably completes its development in some new host. Some have connected the *Dicyemida* with such higher forms as the *Rotifera* or *Trematodes*, and have regarded the simplicity of the adult as the result of that degeneration which is suggested both by development and habit. Haackel, while acknowledging degeneration, regards *Dicyema* as a survivor of the originally simple *Gastræda* from which the *Metazoa* have sprung.<sup>2</sup>

*Orthocentrida*.—This group consists of a number of minute parasites, such as *Rhopalium*, infesting some Nemertines, Turbellarians, and Ophiuroids. Although moving in linear direction, as their name implies, they exhibit radiate structure. The ciliated and segmented ectoderm encloses an inner endoderm layer and a central cavity which usually contains embryos. They exhibit a well-marked sexual dimorphism, the males being smaller and with fewer segments. Their position is as problematic as that of the *Dicyemida*; they may be regarded as degraded forms allied to the *Turbellaria*, *Trematoda*, or *Rotatoria*, or as survivors of the *Gastræda*.<sup>3</sup>

*Calenierata*.—In this group (see **ORALS, HYDROZOA**), while the fixed forms are frequently indebted for support to other organisms or to each other, and although such associations occasionally seem tolerably constant, true parasitism is remarkably rare. Young *Narcomedusæ* (*Cusina*) are parasitic within the mouth of *Carmarina*, and the hydroid *Lafusa parasitica* grows like ivy on *Aglaphenia*.

Similar remarks apply to the *Mollusca*, where, with one or two exceptions (e.g., *Entoconcha mirabilis* discovered by Johannes Müller in *Synapta*, and another Philippine species described by Semper) parasitism is unknown.

*Echinodermata*.—There are no parasitic Echinoderms.

*Fernæ*.—To this sub-kingdom belong the majority of parasites, but the greater groups are treated in separate articles. See **NEMATOIDEA**, and for **Cestoids** and **Trematodes** see **TAPEWORM**.

*Acanthocephala*.—This group, usually regarded as degenerate from **NEMATOIDEA** (q.v.), is represented by various species of *Echinorhynchus*. These parasites possess a muscular elongated body with a retractile proboscis armed with hooks, which serves to fix the animal to its host. Sense organs, mouth, alimentary canal, and anus are wanting; but the muscles, nerves, and generative organs are well developed. There is a complicated subcutaneous canal system; the sexes are distinct, and the reproduction is viviparous. The embryo, well provided with ensheathing membranes and with hooks, is expelled with the excreta of its vertebrate host and swallowed by some Arthropod, such as *Asellus* or *Gammarus*. There a remarkable metamorphosis takes place: the adult is formed within the body of the larva, the skin being the only part of the larva which passes over to the adult. The young *Echinorhynchus* finally passes with its invertebrate host into the alimentary canal of some vertebrate, e.g., fish or bird or even pig, and there attains sexual maturity.<sup>4</sup>

*Rotatoria*.—Such forms as *Albertia*, found externally on certain worms (*Nais*, &c.), and *Balatro* inside the same, are distinctly parasitic, and are not improbably differentiations of the same form.

Among the Nemertean various parasites occur, such as *Pontobella*, *Branchellion*, *Piscicola*, found especially on fish. The *Chaetopoda* are never parasitic, and but rarely commensal. The

*Myxozomata* are probably, however, degenerate *Chaetopoda*, represented by the genus *Myxozoma* living ectoparasitically on Crinoids.

*Crustacea*.—This group includes an immense number of forms in varying degree parasitic. The *Copepoda* include all grades from free-living forms to such degenerated parasites as *Achtheres*, *Lernæa*, *Chondracanthus*, and *Argulus*. Many *Entomostraca* are parasitic, and among the *Isopoda* we find such forms as *Bopyrus* and *Cryptoniscus*. Among the *Cirripedia* again are various grades of parasitism from some of the *Lepadida* to the *no plus ultra* of degeneration—the *Rhizocephala*.<sup>4</sup>

*Insecta*.—Insects furnish a large proportion of ectoparasites, but comparatively few endoparasites, for very obvious reasons. The *Strepsiptera*, parasitic on bees, the ichneumon-flies, *Platygastræ*, and allied Hymenopterous forms, the *Pediculines* (*Hemiptera*) and the *Mallophaga* are the more important parasites. Many of the other groups also include parasitic members. See **INSECTA**.

*Arachnida*.—The majority of *Acarina* (see **MITE**) are parasitic, and there are many other *Arachnida* of similar habit. To the *Arachnida* the *Pycnogonida* and the *Pentastomida* are often referred. The former are parasitic in their youth at least on *Hydroids*. *Pentastomum* exhibits considerable divergence from the *Arachnoid* type, and has a life-history closely parallel to that of the *Cestoids*. The adult form is found in the frontal sinus of the dog or wolf; the embryos pass through the nose to the exterior, and if eaten by a hare or rabbit lose their investment, penetrate to the liver, encyst, and pass through a complicated series of changes, finally attaining maturity and sexuality when the flesh of the rodent is eaten by the original host.

*Vertebrata*.—The *Vertebrata* are rarely parasitic. The best case of incipient parasitism is that of *Myzina*, which burrows into the codfish. With this may be compared the well-known *Nemora*, which attaches itself externally to sharks, &c. Commensalism is, however, more common, many small *Teleostean* living with *Medusa*, sea anemones, and such like. *Fieraster* finds a lodgment inside the respiratory tree of *Holothurians*; and Semper describes a Philippine species which actually devours the viscera of its *Holothurian* host.

#### B. Distribution of Parasites and List of Hosts.

*Protozoa* are of course rarely infested; *Coelenterata* also rarely; species of *Distomum* have been taken on *Physophora*, *Vesella*, *Pelagia*, *Beros*, and *Cestum*; a scolex and a nematoid have been described from *Ctenophores*, while various *Arthropods* occur ectoparasitically. *Echinoderms* are also very free from parasites; on *Echinus*, however, despite its pedicellariae, occur occasionally the semi-planariform *Trematode* *Synasmetis*, and the mollusc *Syngaster*, *Anaploidiom*, and *Eulima* (the latter occurs also on starfishes). The *Comatulæ* of all seas bear *Myxozoma*. *Holothurians* from the Pacific occasionally contain crustaceans, such as the crab *Pinnotheres*, and several *Copepoda*. Their respiratory tree lodges *Fieraster*, while *Synapta* contains the mollusc *Entoconcha mirabilis*.

*Mollusca* are more largely infested. *Pinnotheres* and other *Crustacea* frequently inhabit the mantle cavity of marine *Lamellibranchia*, as the *Arachnid* *Atax* does the fresh-water mussel. The *Lamellibranchia* also have their peculiar *Trematodes* like *Aspidogaster* and *Buccephalus*, besides *Ceraria*, from which probably few *Gasteropods*, whether marine, fresh water, or terrestrial, are ever free. The *Cephalopods* not only contain certain *Dicyemida* in their renal organs, but through their piscivorous habits acquire *Tetrarhynchus* and *Ascarida*. Among the *Chaetopods* not only are *Protozoan* parasites frequent, but parasitic worms are occasionally described.

*Crustaceans* frequently contain *Gregarines*; and a few *Cestoids*, *Trematodes*, and *Nematoids* (and *Branchiobdella*) have been described, as well as the cystic *Echinorhynchus*, from *Gammarus pulex*. More formidable, however, are the *Copepods*, like the familiar *Nicotus* of the lobster's gills; and, worst of all, the *Rhizocephala*, like *Pellogaster* and *Sacculina* of the hermit and shore crab respectively.

*Centipedes* often contain *Nematoids*, and spiders *Mermis* and *Gordius*. *Insects* are preyed upon by ichneumons, are largely plagued by ticks externally, and internally by *Gregarines* and worms, most frequently *Gordius* and *Mermis*; but also by larval *Hymenoptera* of many families, by certain *Diptera*, and by the *Strepsiptera*. See **INSECTA**.

The *Tunicata* harbour many crustaceans, &c., chiefly in the test.

It is among vertebrates, however, that parasitism is most frequent and most fatal. Fishes swarm externally with *Trematodes*, leeches, and parasitic crustaceans, internally with cysts and intestinal worms all too numerous for enumeration. Nothing gives a more vivid idea of the extent to which parasitism has reached than an examination of a ray, or even better, the common sunfish (*Orthogoriscus*). Amphibians are inhabited by many parasites,—the common frog

<sup>1</sup> See Leuckart, *Broun's Protozoen*, and article **PROTOZOA**.

<sup>2</sup> K. van Beneden, *Bulletin de l'Acad. Royale de Belgique*, xii. and xiii., 1878; C. O. Whitman, *Michx. Zool. Mus. Neapel*, 1883, iv. 1-49; *Jour. Roy. Microscop. Soc.*, postum.

<sup>3</sup> Gard, *Jour. de l'Anat. et de la Physiol.*, xv. 1879; *Comptes Rendus*, lxxxix., 1879; *Quart. Jour. Microscop. Soc.*, vol. xx., 1880 (Gard); *Metschnikoff, Zool. An.*, 40-48, 1879; *Jour. Roy. Microscop. Soc.*, 1881; *Bocher. J. u. Zool.*, xxxv., 1881; *Jour. Roy. Microscop. Soc.*, 1880, p. 84.

<sup>4</sup> See **CHAETOPODA**, and the more recent researches of Claus and Kossmann, as also those of Lacaze-Duthiers on *Lernæa*, and the especially remarkable investigations of Delage on *Sacculina* (*Zoolog. Jahrbuch*, 1890-94).

having almost constantly *Acaris nigrovirens* in its lungs, and infusorial parasites in its rectum, and may also yield *Distomum*, *Echinorhynchus*, &c., twenty species in all. Lizards harbour tapeworms, Nematoids, including species of *Trichina*, more rarely Trematodes. Ophidians have all kinds of parasitic worms, Cheloniens chiefly Nematoids and Trematodes. The parasites of birds are of extraordinary number and variety; preying, fishing, and omnivorous birds serve, of course, very constantly as intermediate hosts; but graminivorous birds are hardly more exempt. The number of parasites is often so vast as to occasion the most serious disease; thus the "gapes" of poultry is due to the choking of the bronchial passages by multitudes of Nematoids (*Sclerostoma syngamus*), and the grouse disease to a similar cause (*Strongylus pygrracilis*).

Yet a great number of parasites may be borne without apparent injury: thus the post-mortem examination of a single stork has yielded twenty-four *Filaria* and sixteen *Strongylus* from the lungs and air passages, one hundred *Spiroptera* from the coats of the stomach, more than a hundred of various species of *Distomum*, and many hundreds of *Holostomum* from the gullet and intestine. Ticks and insect parasites are also common; of these the most remarkable are the feather-eating *Mallophaga*. The majority of the *Mammalia* have as internal parasites many different species of worms either in adult or cystic form, which are fully described in veterinary works. The special parasites of man are estimated by Cobbold at as many as 121 species (18 Trematodes, 16 Cestodes, 21 Nematoids, 10 Leeches, 17 Arachnida, 44 Insects); many of these, especially among insects, have occurred only very rarely, and should not be reckoned, e.g., *Musca vomitoria* and *Blaps mortisaga*, while a considerable number of the truly parasitic forms have only been once or twice described,—the above estimate thus becoming reduced well-nigh to half.<sup>1</sup>

**Taxonomy.**—Far then from there being, as was formerly thought, one great group of *Entozoa* by itself, we have seen that most invertebrate groups have their parasitic members and exhibit transitions or grades connecting these with free-living forms. The systematic position of many parasitic species is, however, not yet clear, many have been named by accident or according to habitat, and great concentration seems necessary. It is, for example, extremely probable that a careful systematic study of genera like *Gordius*, *Distomum*, and *Tetrarhynchus*, of which innumerable species have been described from as many different hosts, would result in proving the identity of many forms described as distinct, and that experiment would show that many of the forms still apparently specifically distinct are really only individuals of the same species more or less modified by the host upon whom the lottery of nature has chanced to quarter them.

With the increasing completeness of our knowledge of parasitic forms the transitions from free to parasitic species are becoming more prominent, and the relationships of the parasitic to the non-parasitic groups more definite. Among the *Nematodea*, for example, as Leuckart indicates, we are able to construct a series, starting from free-living forms, and through such cases as *Leptodera* (a *Rhabditis*-like form, sometimes free, sometimes parasitic), thence to parasitic Nematodes hardly to be distinguished from their free-living relations, but passing gradually through *Oxyuris*, *Trichocephalus*, *Spiroptera*, &c., to such highly parasitic forms as *Trichina*, where all relation to the outer world is lost. The *Acanthocephala* Leuckart has taught us to regard as Nematodes highly modified by parasitism, and he points out how *Gordius*, with its atrophied alimentary canal, terminal position of female reproductive organs, and other persistent and embryonic characters in which it differs from the typical Nematoid, really leads up to *Echinorhynchus*. As *Echinorhynchus* is related to the Nematodes, so are the Cestoids to the Trematodes. The close alliance suggested by numerous points of anatomical correspondence, and by the close parallelism in life-history, is corroborated by such intermediate forms as *Caryophyllæus* and *Amphitina*, from which we pass with ever-increasing parasitic adaptation

through the *Ligulids* to *Bothriocephalus* and *Tenia*. Leuckart further points out how closely the Trematodes are united by intermediate forms to the Planarians. The affinities of *Myxostoma* and *Pentastomum* are not yet precisely determined, though the former is most plausibly regarded as a degenerate *Chaetopod* and the latter as similarly degenerated from some low Arachnid or at least Arthropod type. In the *Copepoda*, *Cirripedia*, and other crustaceans all degrees in intimacy of association may be observed, making the relations of the parasitic to the free forms sufficiently obvious. Everywhere, in short, we find a morphological and physiological gradation from free to parasitic forms.

**Nature and Degree of Parasitism—Commensalism.**—From the foregoing necessarily much abbreviated lists we observe not only the enormously wide prevalence of parasitism—the number of parasitic individuals, if not indeed that of species, probably exceeding that of non-parasitic forms—but its very considerable variety in degree and detail. The majority indeed derive their main support from their host, but of these some are free, wandering about from animal to animal, some are attached permanently to the exterior of their victim, while others again are concealed within its body. In some cases the parasitism is only temporary, with others it is a life-long habit. The majority are free in their youth, while some pass their early life as parasites, becoming free in their mature state, and others again spend their whole life on their host.

In some cases there is the very slightest association; every student of marine forms is familiar with the complex

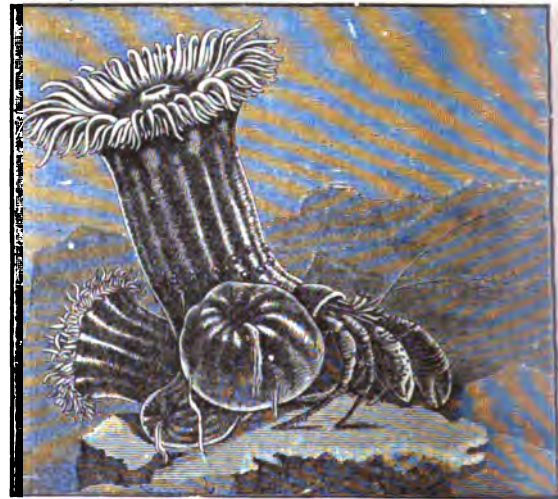

FIG. 1.—Colony of sea-anemones (*Balanus parasiticus*) on shell of hermit crab.

incrustations and intergrowths of sessile forms, and has seen how almost any surface or cranny may afford a lodgment. Parasitism for support is not infrequent; it may be temporary or permanent; in the former case it is useful in diffusion,—the glochidium-larva of the fresh-water mussel, for example, being transported on the fins of fishes. From cases like those of many Cirripedes, which occur indifferently on rocks or on animals, we pass readily to permanent associations like that of *Laxosoma* on the posterior end of *Phacelosoma*. Vague and loose associations, if useful to one or both participants, may become perpetuated by natural selection. Thus sea anemones may settle on any surface,—occasionally therefore on shells inhabited by hermit crabs; hence have arisen permanent

<sup>1</sup> For lists see, in addition to general authorities, Linstow *Compendium d. Helminthologie*, Hannover, 1878; V. Beneden, *Animal Parasites and Mesozoa*; Cobbold, *Human Parasites* (1887), and *Parasites of Domestic Animals* (1874); Engler's *Pathology*, English ed., London, 1853.

associations. Of these there are many familiar instances, such as the hermit crabs bearing *Sagarita parasitica* (fig. 1), or having their shell-mouth enveloped by *Adamsia*. One of the quaintest instances is a lately described species of crab which wields an anemone firmly grasped in either claw. In such cases the association is obviously useful: the crab is protected from the octopus and other enemies by the nematocysts of its comrade, which also aid in holding the prey, while the *Actinia* too gains its share of the food, and vicariously acquires means of locomotion. To such cases where two animals are associated together for mutual support and advantage the term "Commensalism" is applied. In the struggle for existence increased complexity of needs, and difficulty in satisfying them, evokes in the individual organism a certain specialization of function and consequent differentiation of structure. Similar causes result not so much in the differentiation of each individual of a species as in the specialization of certain individuals for certain specific functions, resulting again in that specialization of structure which is called polymorphism. Thus in a *Hydractinia* or Siphonophore colony many different individuals of the same species have been specialized in each to perform a certain function. The same purpose is served by those associations, not of individuals of the same species, but of two individuals of different species, united as we have just seen for mutual advantage, and each working out some definite part of the common life-problem. Just as polymorphism in the same species is physiologically equivalent to differentiation in the individual organism, so is commensalism between different species the physiological equivalent of polymorphism in a single species.

But cases of co-operation on equal terms are rare; size constitutes the most frequent disparity, and the smaller tends to become first wholly dependent upon the other for support, then for concealment, and finally perhaps for sustenance. The reverse may occasionally occur, the weaker being utilized for the purposes of the stronger; thus a species of *Dromia* adapts a colony of sponge or ascidian as a removable upper garment for concealment.<sup>1</sup>

**Parasitism within the same Species.**—In some cases even within the morphological unity of the species a physiological relation is established analogous to commensalism if not to parasitism. Thus in *Bomellia* the diminutive and degenerate male lives in the uterus of the female, in *Trichococcus crassicauda* of the rat three or four male are found within the spermatheca of the female, while in *Bilharzia* the incipient reciprocal of these cases is found, the male being host. Many of the most remarkable cases are also afforded by the *Cirripedia*, in which a female may bear males in various states of dependence and degeneration. In viviparous animals a certain absorption by the young from the tissues of the parent can hardly avoid taking place; this is therefore so far an analogy to endoparasitism. This advantage is clearly retained and developed if absorption take place by an organ specialized for the purpose. Thus in the well-known shark *Mustelus levis* the young are attached to the oviduct by a placenta developed on the yolk sac; and the like arrangement, though morphologically different, is physiologically the same among the *Mammalia*.

**Hyperparasitism.**—Not only are very few animals altogether free from parasites, but even parasites themselves find their nemesis in being themselves infested by lesser parasites, though not "ad infinitum." Thus Leuckart mentions that water-lice and thread-worms are found on parasitic crustaceans, and the endoparasitic larvae of some *Hymenoptera* are themselves preyed upon by other larvae

(*Pteromalinae*). Nematodes are found in *Nicotia*, and associated with *Sacculina* are frequently found two other crustacean parasites, one of which, after destroying the greater part of its host, continues to subsist upon the nourishment afforded by its root-like processes which survive the operation.

**Classification.**—Some classification of these various parasitic forms is necessary. Van Beneden introduced the useful term *commensals* or *mesmates*, under which he includes (1) *oikosites* or fixed and (2) *coinosites* or free partners. These he distinguishes not only from parasites but from *mutualists* where two species are associated, but neither share a common food nor does one prey on the other. Parasites he divides according to the duration of their state of attachment to a host, distinguishing (1) those which are free all their life (leeches, bugs, fleas, &c.); (2) those free as adults but parasitic when young (*Ichneumon*, *Mermis*, &c.); (3) those free only in youth, and attaining their adult form either directly in the first host entered, or only after a migration from one host to another (most parasitic worms); (4) those which pass all phases of their life on or in their host, e.g., *Strepsigaster*, *Tristomum*, &c. In this classification there is no attempt to define the degree of dependence or the closeness of the association, except in the general distinction between parasites and commensals; the group of mutualists is entirely superfluous and confused, no clear definition being given, and in the examples of the various groups the limits of his own definitions are not adhered to.

Leuckart distinguishes parasites as ecto- and endo-parasitic, and divides the former into temporary and permanent. Endoparasites he divides according to the nature and duration of their strictly parasitic life. (1) Some have free-living and self-supporting embryos which become sexually mature either in their freedom or only after assuming the parasitic habit. (2) Others have embryos which, without having a strictly free life, yet pass through a period of active or passive wandering, living for a while in an intermediate host. They may either (a) escape to pass their adult life in freedom (*Archigetes* and *Aspidogaster*), or (b) they may become sexual, or (c) they may bore their way to another part of the body (*Trichina*), or (d) most frequently they pass to their final host either directly when their intermediate host is devoured as food, or indirectly seeking for themselves another intermediate host, or producing asexual forms which do so (Trematodes and Cestoids). (3) Others again have no free-living or even migratory embryonic stage, but pass through their complete life-cycle in one host (*Trichocephalus*, *Oxyuris*, &c.). This somewhat detailed classification has at least the advantage of clearness, and of showing to some extent the various degrees of parasitism.

Kossmann has proposed a more physiological classification dealing with the organization and habit of the parasite. This he has applied to the *Crustacea*:—I. *Dioctotich*, or vegetative without independent digestive organs, e.g., *Rhizocephala*; II. *Digestorii*, with independent digestive system, and including (1) *Sedentarii*, *Copepoda atelemetata*, *Bopyridae*, *Euboliceidae*, *Cryptoniscidae*; (2) *Vagantes*, *Copepoda holometata*, *Branchiura*, *Cymothoidae*. The great variety of details, however, makes it almost impossible to establish any logically accurate division. Any strict classification of such a variety of organisms having only in common the physiological correspondence of their mode of life is almost impossible, and the most that can be done is to point out the existence of series of adaptations varying with the intimacy and constancy of the association and the degree of dependence.

**Origin of Parasitism and Transmission of Parasites.**—With the dismissal of the theory of *generatio aequivoca*, the question of the origin of parasites is limited to the discussion of the causes which might induce such a change of habit and environment. There are obviously many opportunities for one animal either in adult or larval state being swallowed by another in food or drink, in which case, if the environment were not too utterly different from that previously enjoyed, parasitism might arise in a purely unconscious way. It is again easily conceivable that animals which have sought a host for temporary protection from climate or enemies, or for safety and seclusion in the bearing and breeding of the young, might, finding the environment congenial and a supply of food at hand, remain there during a large portion of their life. It is worth noticing, as corroboratory of the idea that the host was in many cases resorted to primarily as a sort of maternity asylum, that we find many parasitic females with free males, e.g., *Nicotia*. Given an animal with a carnivorous habit, it is intelligible enough that during a period of

<sup>1</sup> For an account of many cases of commensalism, see V. Beneden, *Animal Parasites*, and Senger, *Animal Life*, both in International Science Series.

scarcity of food or of extreme pressure from enemies, various methods of solving the problem of life would be attempted, the successful results of which in a few cases persist especially in ectoparasitism, not the least obvious mode of retaliation on stronger foes. The degree of the parasitism is, as we have seen, not of primary moment, and its intimacy may be increased. There are naturally some physiological limits of respiration, &c., determining the possibilities of parasitism—air-breathing insects are found on land animals or at most on some amphibian forms, water-breathing Arthropods on water-breathers, water-breathing worms only in the interior of land animals; but even these limits may be overstepped by adaptation when, for example, the respiration becomes cutaneous in *Pentastomum*, *Sarcoptes*, &c.

The various modes of transmission of parasites, though of great practical importance, do not call for much discussion here. They may be summarized as follows after Leuckart:—(1) the majority of parasites reach their hosts through the medium of food or drink; (2) eggs are in some cases transferred from one animal to another by actual bodily contact, e.g., the eggs of *Pentastomum* by the licking of dogs; (3) sometimes the eggs are deposited in or on the host by the mother, for example, by insect parasites, such as *Ichneumons*, *Blattidas*, &c.; (4) in some rare cases parasites are transmitted by self-infection,—for example, young *Trichinas*, born free in the alimentary canal of their host, bore their way thence directly into the muscles, there to grow into the well-known encapsuled worms. Eggs or proglottides of tape-worm may, on gaining the exterior, be transmitted inadvertently to the mouth, and so recommence their life-cycle within the same host.

The mode of diffusion of the ova of parasites presents many analogies to that of seeds in the vegetable kingdom: thus wind and water are alike utilized, passing animals may serve as unconscious bearers, and the like. Though well protected by a usually thickened egg-shell and an often remarkable degree of vitality, so as to resist prolonged drought, burial, and other vicissitudes, the parasite has an exceedingly small chance of success in finding a host; to preserve the species from extinction an enormous number of eggs must be produced, far exceeding that of free-living organisms. Thus Leuckart points out that as a tapeworm has an average lifetime of two years, and produces in that time about 1500 proglottides, each containing say 57,000 ova, and since the species is not increasing in numbers, an ovum has thus only one chance in 85,000,000 of reaching maturity. The difficulties are of course increasingly greater as the life-history becomes more complicated, demanding an increasing number of hosts. Given a sufficient number of eggs, however, no difficulty is insuperable, and few parasitic forms accordingly seem in any risk of disappearance, except, it is to be hoped, in the case of civilized man and the domestic animals, where the large consumption of cooked food, aided by conscious hygienic precautions and medical aid, tends to exclude or remove them.

*Effects of Parasitic Life on Parasites.*—So far from treating the phenomena of parasitic life as highly aberrant, and the peculiarities of parasitic form as differentiations *sui generis*, it becomes evident that we have to do with only one of the many cases in which the influence of environment on organism is clearly marked. The ætiology of parasitism is only a fraction of a vaster general question; and we shall never fully understand the adaptation of the parasite to its host until the relation of environment to organism has been far more profoundly analysed and completely experimented on—inquiries which have only

ly begun to be seriously set on foot. The most cursory consideration of the action of environment shows how profoundly it determines form; of this no better examples can be found than those furnished by the habit of plants. It is easy to see how submerged leaves must become dissected, or desert plants tend to become succulent; how evergreens are only possible in certain conditions of climate, or thorns are only useful where herbivorous mammals abound. In the same way we can broadly see that the conditions of life profoundly influence animal form. Before considering how the abnormal parasitic environment affects the parasite, we should know how the normal environment affects the non-parasite, and how the two cases differ. The environment thus needs analysis into its factors, the organism similarly into its constituent systems of organs; and the influence of any factor of the environment upon each system and organ demands determination, species by species, before safe and exhaustive generalizations can be obtained. Pending these inquiries, which are destined to take so large a place in the biology of the future, and within the present narrow limits, only the merest outline can be attempted.

Morphological science has but slowly and with difficulty disentangled itself from the primitive classifications of plants and animals by habit and resemblances of external form; the physiologist, however, needs to reassert the claims of these and develop them in detail; as for the child so for him whales are in a sense fishes, and bats birds,—just as the swimming organs of the former, like those of the penguin or cuttlefish, are all fins, or the flying organs of the latter and those of insects are wings alike. Such considerations show too the first importance of the mechanical conditions, primarily those of locomotion or rest, and whether in water, or land, or in air, since these determine, not only external form, but muscular and skeletal disposition and structure. These determined, conditions of heat and light play an obvious part; copious supplies of heat energy to the organism have a distinct result in stimulating plant growth, and accelerating that of animals; light too, a primal necessity for green plants, has also the most marked effect on animals, which develop tracts of absorbent pigments in its presence, these becoming locally evolved for perception into eyes; while in relation to sound-vibrations and impressions of contact other sense organs develop. Quantity of food has its influence mainly on size, but nature of food and mode of feeding demand many appropriate specializations of details of form. Expressing the same adaptations from the other point of view, that of the organism, we see how not only the general form but the integument with its colour and texture, and also the respiratory and alimentary organs, are necessarily fitted to avail themselves of the given conditions; how the circulatory and how the reproductive systems must comply; how the sensory organs must take note more and more of the changes in the environment; and how the whole series of complex adaptations demands a similarly complex internal mechanism for their co-ordination through the nervous system.

From the slightest analysis then of the relation of organism to environment, the theory of evolution might almost have been predicted, since, if the details of environment and organism be indeed obviously and precisely adapted one to another, change in the former must either be followed by the extinction of the latter or its modification in the requisite details. To explain the *modus operandi* of change in the organism, we have mainly to bear in mind Dohrn's admirably expressed "principle of functional change,"—the simple conception that any living tissue, however specialized, still retains traces of all the functions of living protoplasm, and that any one of these traces may be indefinitely increased by favourable conditions, and the

specialized function similarly reduced to a trace. Along with this, or rather as a corollary of it, comes the conception of economy of unused structure; our notions of specialization become henceforth associated with a corresponding possibility of simplification, and our ideas of progress must be for ever accompanied by the corresponding possibility of degeneration.

The conditions of parasitic life are readily seen to differ primarily from those of independent organisms in negative characters, i.e., in the simplification of the factors of the environment; let us therefore briefly consider the results of such progressive simplification upon organisms in general. Let the mechanical conditions be simplified by the cessation of active movement; the specialized body-form necessary for locomotion then becomes unnecessary; locomotor muscles and their skeletal attachments are simplified or disappear; organs of sense are far less needed; and nervous adaptations and structures become correspondingly reduced. In all these respects then sessile parasites simply agree with other sessile animals. Again, let us simplify the environment by the deprivation of light; eyes and pigment are useless, and our organism, whether cave-dwelling insect or crustacean or internal parasite, becomes blanded and blind; and similarly with other senses. Or let us subtract as far as possible the element of danger from other animals by special protection or concealment in one of the "nooks of life"; here again for shelled mollusc, sand-buried *Ampelisca*, or hidden parasite the diminished need of nervous adaptations is a similar degenerative factor. Let food become abundant, the same nervous economy follows; let it be highly nutritive, and digestive structures and functions may be simplified; thus the examples of progressive degeneration of the alimentary system up to its complete replacement by superficial absorption, afforded by various parasitic series, are natural enough. The soft integument unprotected and blanded, the reduced muscular activities, the simple or absent alimentary tube, the reduced circulatory and respiratory organs consequent upon diminished waste and softened integument, are all intelligible enough, as also is the increase in reproductive activity demanded by increased risk of failure to find the appropriate conditions. The few adaptive conditions are readily understood: given the continuous application of a flat muscular surface to resist detachment from the host, and atmospheric pressure helps the development of the sucker; given either a clutching limb or a portion of the body-wall thrust for support into the host, and the mechanical conditions aid the differentiation of a hook; here, if anywhere, function in fact may be said to make the organ, and such curious resemblances of superficial form as those between say a gregarine, a tapeworm, and an *Echinorhynchus* are not hard to explain.

Further details of the process of retrograde metamorphosis and of the enormously important phenomena of degeneration cannot here be attempted; it must suffice if the general dependence of such changes upon simplification of environment—freedom from danger, abundant alimentation and complete repose, &c. (in short, the conditions commonly considered those of complete material well-being)—has been rendered clearer, and if the phenomena of parasitism, however apparently aberrant, become intelligible as new evidences of the unity of organic nature.<sup>1</sup>

*Effects of Parasite on Host.*—As the result of the association of two organisms with more or less constancy, various mutual modifications of form and function must obviously occur. The more important effects of parasite on host may be briefly outlined. Semper cites numerous cases where the commensal or parasite has a mechanically trans-

forming effect on the host. Thus a horny coral with which an annelid is constantly associated has become permanently modified to form an encasing tube. Worms inside corals have enlarged the base of the cavity by stimulating growth, and may also produce permanent pores. Pycnogonids on *Campanularia* produce galls, which acquire specific characters, and various species of crab parasitic on corals form galls, two of which coalescing, form a sort of "cave dwelling" with two fissures which are kept open by the respiratory currents of the crab, which thus both stimulates and checks the growth of the polyps. In higher animals, and with more intimate parasitism, the mechanical influences of the parasite on the host are more serious and more markedly pathological. Thus parasitic worms, by their size and number, frequently close up passages such as arteries, windpipe, &c., causing often fatal results. But many parasites are also actively destructive to certain tissues of their host—thus, as Semper points out, *Pellogaster* destroys the female reproductive organs of *Pagurus*, a Trematode those of *Limnæa stagnalis*, the larva of a fly (*Cuterebra emaculator*) the testes of various species of American squirrel. In none of these cases, however, is the general vitality of the host affected. The results of active motion within the host are productive of still more serious mischief; thus the internal migration and burrowing of such parasites as *Trichina* and *Bilharzia* is well known to produce violent inflammation. The perforation of vessels, the consequent extravasation of blood, and the destruction of tissue often end fatally for the host. Leuckart distinguishes pathological effects as due either to growth and increase of parasites, or to their wanderings within the host, or thirdly to the very considerable loss of nourishment which a number of parasites of appreciable size necessarily entails. Some blood-sucking parasites are specially dangerous, and many less ferocious forms doubtless poison their host to some extent by their waste products. Roux also notes how parasites—an *Echinococcus*, for example—by inducing a flow of nutritive material, may develop a network of capillaries and produce other histological changes.<sup>2</sup>

It is probable that many of the most remarkable integumentary specializations of the animal kingdom are defences against parasites (somewhat as the stings or thorns which protect foliage, or the hairs which keep ants from flowers); thus the nematocysts of coelenterates, the molluscan shell or the crustacean mail, the vigilant pedicellariæ of the echinoderm, or the scales of the fish are alike largely specialized as defences against the never-ceasing attacks of swarms of larval parasites, eagerly struggling to gain entrance or footing anywhere.

The history of the medical aspects of parasitism can only be very briefly alluded to. From the time of the ancient Arabian physicians some diseases, such as itch, have been referred to parasites. With the increasing knowledge as to the prevalence and importance of parasitism there arose a distinct parasitic theory of disease, and in the 17th and 18th centuries such questions were discussed as "an moris naturalis sit substantia verminosa." In spite of the gradual unravelling of the mysteries of origin and life-history, physicians long clung conservatively to the old hypothesis of spontaneous generation, even Bremser regarding the pathological states of the host not as caused by the parasites, but as causing and in fact creating them. It was not till within the last thirty years that, with the rise of experimental helminthology, medical science shook itself free from superstition and ignorance, and devoted close attention to ætiology and treatment, culminating in that systematic warfare against all forms of parasitism

<sup>1</sup> See Dohrn, *D. Princps. d. Fractionenwechsel*; Lankester *On Degeneration*, London, 1890; Semper, *Animal Life*.

<sup>2</sup> Leuckart, *op. cit.*; Semper, *Animal Life*; Roux, *D. Kampf d. Thelle im Organismus*; Ziegler's *Pathology*, &c.



which now occupies so important a place in medicine and the veterinary art (see p. 269 *infra* and VETERINARY SCIENCE).

#### VEGETABLE PARASITISM.

The name of parasites has been given to those plants which are nourished wholly or partially at the expense of other living organisms. The degree and nature of the benefit thus obtained varies greatly with different plants, and the effect produced upon the host ranges from an almost imperceptible one to complete destruction. At one extreme are certain forms which, while drawing the nourishment necessary for life from their hosts, yet do so in such fashion that both organisms continue to live in intimate association, and, it may be, rendering mutual help. From these by a series of gradations we come to parasites of such destructive influence as to cause widespread death to certain animal and vegetable forms of life. This physiological group is closely related to another, the saprophytes, which obtain their nourishment from the dead remains of organisms. True parasites belong exclusively to the dicotyledonous flowering plants and the fungi. A few algae are partial parasites.

The remarkable appearance presented by most parasitic flowering plants undoubtedly attracted notice in remote times. They are frequently mentioned by early writers, but there is no evidence sufficient to enable us to determine whether they were regarded as independent plants or merely as pathological excrescences—unless in the one case of the mistletoe, which was recognized as the former by Pliny, who gives an account of its reproduction by seed. The effects of the attack of parasitic fungi were also observed in very early times, as there is abundant evidence to show, but the plants themselves which caused the damage were necessarily not detected as such from their minute size and obscure nature. We must come to the middle of the 18th century for the first attempt to establish a botanical group of flowering parasites. Pfeiffer, in his treatise on the *Fungus melitensis* (*Cynomorium coccineum*), divides all flowering parasites into three groups, according as they infested the whole plant or attacked but one place or were confined to the root; but he includes many epiphytes, such as ivy, lichens, &c. After this remarkable classification a knowledge of native and exotic forms grew up, and nothing noteworthy occurred in the history of the subject until the end of last century and beginning of the present one, when there was a relapse to the old theory that parasites were no more than degenerate outgrowths from their hosts. For example, Meyen attempted to account on anatomical grounds for the existence of *Lathræa squamaria* on its host, and more absurdly still, Trattinick, in a letter to Schlechtendal, gave a short list of plants to which parasites bear a very superficial resemblance, and gravely affirmed his belief that the latter are but specific degenerations of these. Thus he contended that *Balanophora* is but an *Arum*, *Cytisus* a *Cotyledon*, *Rafflesia* a cabbage, &c. De Candolle made the first genuine attempt in 1832 to establish a classification of parasites on morphological and physiological grounds; Unger followed in 1840 with a purely morphological arrangement, and, though he advanced matters considerably, his treatise contains much speculation not borne out by facts. Martius's classification of about the same time is on much the same lines as De Candolle's. The knowledge of parasitic fungi has advanced gradually with the improvement of the microscope, and the accumulation of the life-histories of forms has grown up under the hands of numerous observers, among the earliest of whom Knight performed admirable service. With increasing knowledge of native and exotic forms, and the advance

made in the fields of vegetable anatomy and physiology, the whole group of vegetable parasites has become more strictly defined,—the last noteworthy service being the establishment by De Bary (*Morph. u. Physiol. der Pilze, Flechten u. Myzomyceten*) of the physiological group of "saprophytes" to receive those plants which differ from the parasites in obtaining their nourishment from the dead bodies of organisms and from soil rich in humus.<sup>1</sup>

**PHANEROGAMIA.**—The parasitic flowering plants are exclusively dicotyledons confined to natural orders falling under the two divisions of *Gamopetalæ* and *Monochlamydeæ*. Among the *Gamopetalæ* there are the (*Monotropæ*) *Lennoaceæ*, *Cuscutæ* (*Convolvulaceæ*), certain genera of *Scrophulariaceæ* (such as *Rhinanthus*, *Melampyrum*, *Euphrasia*, and *Pedicularis*), and the *Orobanchæ*. Among the *Monochlamydeæ* there are the *Cytinaceæ*, *Cassytha* (*Lawsoniaceæ*), *Loranthaceæ*, *Santalaceæ*, and *Balanophoraceæ*. The vegetative bodies of these exhibit various degrees of degradation, and this process may go so far that, excepting the parts concerned in reproduction, not only the external appearance but the whole structure of the tissues characteristic of a vascular plant may be lost to the parasite. The roots in particular undergo considerable change of form and structure in adaptation to their peculiar function, and the typical root of a vascular plant may lose all its characteristics, retaining only its physiological properties. A degraded root or part of a root so adapted is termed a *haustorium*, and the mistletoe, dodder, *Thesium*, *Balanophora*, and *Rafflesia* exhibit such in various degrees of removal from the true type.<sup>2</sup>

The arrangement of the orders as follows is that adopted in systematic botany. Their physiological relations will be afterwards indicated.

The *Monotropæ*, which are allied to the heaths, possess no chlorophyll and only small scale-like leaves. *Monotropa*, which may be taken as a type of the group, undoubtedly subsists as a saprophyte on organic matter derived from the soil. There has been some controversy as to the parasitism of these plants. Perhaps the strongest evidence in its favour was offered by Drude, who stated that he found a parasitic connexion between *Monotropa* and the roots of *Abies excelsa*. *Monotropa* was then generally regarded as both parasite and saprophyte. More recently, however, Kamienski has denied the accuracy of Drude's interpretation of the case, and, affirming that *Monotropa* possesses no haustoria, upholds the view that it is no true parasite. Upon the evidence it may be taken that no case has yet been satisfactorily made out for the parasitism of this group. The suborder consists of ten or twelve species included in nine genera occurring in north temperate regions. *Monotropa Hypopitys*, L., is distributed through Europe; var. *glabra*, Roth, mostly among deciduous trees; and var. *hirsuta*, Roth, commonly among conifers.<sup>3</sup>

The *Lennoaceæ* are a very small order confined to Mexico and California. They are succulent herbs with simple or slightly branched stems bearing small scale-like leaves, and resemble in general habit the *Monotropæ*, to which they are allied. They possess no chlorophyll, and are probably always parasitic.<sup>4</sup>

The *Cuscutaceæ* (Dodders) are a suborder of *Convolvulaceæ*, and are distinguished by their fibrous, climbing stems bearing very small scale-like leaves. They are entirely without chlorophyll, and are true parasites. The group consists of annual plants reproduced each year from their seed, which commonly ripens about the same time as that of the host plants. The seeds of host and parasite are frequently found mixed, and it consequently happens that they are sown together. When the seed of the dodder germinates it

<sup>1</sup> Pfeiffer, *Fungus melitensis*, Linnaeus's *Amœnitat. Acad.*, Dissert. Lxx., vol. iv., 1788; De Candolle, *Physiologie végétale*, iii., *Des parasites phanerogames*, 1832; Unger, "Beitr. zur Kenntniss der parasitischen Pflanzen," *Ann. d. Wiener Mus.*, ii., 1840; Martius, "Ueber die Vegetation der wuesten und echten Parasiten zunæchst in Brasilien," *Bot. Anz. d. Kgl. bot. Acad. d. Wissenschaft.*, xlv.

<sup>2</sup> The following recent works deal more or less completely with parasitic flowering plants as a group:—Solms Laubach, "Ueber den Bau und die Entwicklung der Ernæhrungsorgane parasitischer Phanerogamen," *Pringsheim's Jahrb. f. wissensch. Bot.*, vi.; Chatin, *Anatomie comparée des végétaux—Plantes parasites*, Paris, 1893; Brandt, *Monstrosité de parasite*, *gesellschaft phanerogame*, obs. Linnaus, 1849; Pittu, "Ueber die Anheftungswerte einiger phanerogamischer Parasiten an ihre Nährpflanzen," *Bot. Ztg.*, 1861.

<sup>3</sup> Solms Laubach, *loc. cit.*; Drude, *Die Biologie von Monotropa Hypopitys*, Göttingen, 1878; Kamienski, "Die Vegetationsorgane von *Monotropa Hypopitys*," *Bot. Ztg.*, 1881.

<sup>4</sup> Solms Laubach, "Die Familie der Lennoaceæ," *Abhandl. d. Naturf. Gesellsch. zu Halle*, xi.



pushes up its stem, which meeting with the stem of the host plant develops a papilla like body at the point of contact. From the papilla there proceeds the true haustorium, which penetrates the tissues of the host as far as the vascular system, where it expands slightly and terminates in a broad surface. The haustorium is furnished with a central vascular bundle originating in the vascular system of the dodder stem. When this haustorium has been developed the root of the dodder dies off and all connexion with the soil ceases, while the stem above the haustorium continues to wind round its host, producing fresh haustoria at short intervals, and gradually enveloping and destroying the plant. The influences exerted are of two kinds—(1) a truly parasitic influence, since the dodder, possessing neither connexion with the soil nor chlorophyll, obtains all its nourishment from its host by the action of its haustoria; and (2) a mechanical influence, in depriving its host of air, light, &c., and preventing the development of branches, leaves, &c. (see fig. 2). The commonest species are *Cuscuta Epithymum*, Murr., distributed throughout Europe, growing on *Thymus Serpyllus*, *Allium vulgare*, *Genista*, &c.; var. *trifolii* on clover, to which crop it is enormously destructive; *C. europaea*, L., occurring throughout Europe on hops, vines, &c., and *C. Epithymum*, Weihe, commonly found throughout Europe growing on flax.<sup>1</sup>

There are at least five genera of *Scrophulariaceae* which are partially parasitic, viz., *Rhinanthus*, *Melampyrum*, *Pedicularis*, *Euphrasia*, and *Striga*. They all contain chlorophyll, and possess true roots on which small haustoria are developed. *Euphrasia*, occurring in both north and south temperate regions, is partially parasitic on roots of grasses. *Pedicularis* is common in alpine and arctic regions of the northern hemisphere, *Melampyrum* and

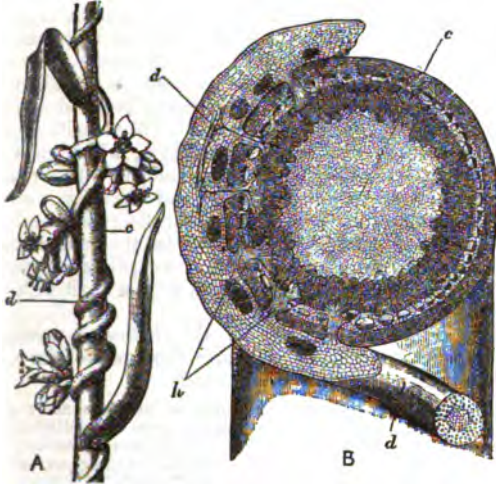

FIG. 2.—*Cuscuta glomerata*, Choisy. A, Parasite entwining host; B, section through union between parasite and host; c, stem of host; d, stem of *Cuscuta*; A, haustoria. After DeCandolle.

*Rhinanthus* in the north temperate zone, and *Striga* is a native of Asia, Africa, and Australia. The last possesses perhaps more distinctly parasitic habits than the others—though the cultivation experiments of Decaisne, Cornu, and others tend to show that parasitism is necessary in the cases of *Melampyrum*, *Rhinanthus*, and *Euphrasia*.<sup>2</sup>

The *Orobanchae* (Broomrapes) possess erect, simple or little-branched stems bearing numerous scale-like leaves, and are variously coloured, but destitute of chlorophyll. They are parasitic on the roots of many different herbs and shrubs by means of their haustoria, which penetrate to the vascular system of the host. They attach themselves thus immediately after germination. There are about one hundred and fifty so-called species of *Orobanchae*, of which the following are perhaps best known:—*Orobancha rubens*, Wallr., parasitic on and very destructive to Incense; *O. minor*, Sutt., on red clover; *O. major*, L., which attains a height of 2 feet on roots of furze and other leguminous plants; and *O. Rapum*, Thuill. *Phelipsea ramosa*, Mey., attacks particularly hemp and tobacco. *Lathraea*, which according to Solms Laubach belongs to *Scrophulariaceae*, is parasitic on the roots of trees such as hazel.<sup>3</sup>

The *Cytinaceae* are a very remarkable order of truly parasitic plants which are wholly destitute of chlorophyll, and of a very degraded structure. *Cytinus* possesses a scaly stem bearing sessile flowers, while *Rafflesia* and *Brugmansia* consists one may say of a single flower, measuring in the case of *Rafflesia* as much as 3 feet across. These flowers appear first in the form of knobs emerging from the host plant, and before expanding resemble an unopened cabbage. They remain expanded only for a few days, when putrefaction begins and a smell as of putrescent flesh is emitted, serving thus to attract insects which probably aid in effecting fertilization, since the stamens are in different flowers. There are about twenty-four species in the order, and these are mostly tropical. *Cytinus Hypocistis*, L., which is parasitic on the roots of *Oleus*, occurs in southern Europe. *Rafflesia* and *Brugmansia* are limited to the Malay Islands, and *Sappia* has a wider distribution throughout the same region. *Rafflesia* is parasitic on both roots and stems, the latter generally prostrate. *Pileostyles*, a native of America and Africa, and *Apodanthes*, confined to America, are parasitic on branches. *Hydnora*, found in tropical and south Africa, grows on succulent plants, chiefly *Euphorbiaceae*, and closely allied to it is *Prosopeanche*, an American genus.<sup>4</sup>

The genus *Cassytha* (*Laurinae*), of which there are about fifteen species occurring in the tropics, but mostly in Australia, strongly resembles *Cuscuta*. The plants are exceedingly alike in appearance and in parasitic habit, for which reason the name of "dodder laurels" has been given to the *Cassythae*. They are wholly without chlorophyll, and their thin, twining, cylindrical stems, bearing scaly leaves, envelop their hosts, to which they are attached by means of papilla-like haustoria. The seeds germinate in the soil, and the roots subsequently die off as in *Cuscuta*.<sup>5</sup>

The *Loranthaceae* are parasitic on the stems and branches of trees, but, since they bear mostly thick and leathery leaves containing chlorophyll, their parasitism cannot be considered so complete as in those cases where chlorophyll is absent. The order is for the most part a tropical one, but it is represented in Europe by *Loranthus europaeus*, L., and *Viscum album*, L., the common mistletoe. *Loranthus* is a large tropical genus containing upwards of three hundred species. *Arenthobium* occurs in southern Europe. The mode of parasitism of *Viscum album*, L., the mistletoe, may be taken as illustrative of the order. Its seeds adhere to the young shoots of trees by means of the viscid pulp of the fruit (used in the preparation of bird-lime). On germination it shoots out rootlets which traverse the cortex of the host mostly in the direction of the axis, sending down numerous haustoria into the wood, where the cells of the parasite become partly lignified, and thus attain an intimate connexion with the wood-cells of the host. A layer of meristem is formed in the haustorium where it passes through the cambium region of the host stem, thus enabling the parasite to keep pace with the growth in thickness, and gradually to become more deeply fixed. The function of the growing point, which soon passes over into permanent tissue, is thus transferred to this region of the haustorium. Ultimately this layer of meristem is also transformed into permanent tissue, and the activity of the parasite in this direction ceases. The haustoria are commonly situated close together in considerable numbers, and an excessive demand upon the host is thus brought about, causing local death and a hurtful influence throughout the plant, exhibited in its defective development. Where a tree has been attacked by mistletoe a corroded and distorted appearance is presented, owing to the drying up of the tissues and the reparative processes that ensue. When the mistletoe has thus exhausted one region of supply it frequently sends out adventitious shoots, which, attacking the host in fresh places, give rise to new growths of the parasite. The mistletoe grows on a large number of different trees, such as the apple, lime, elm, maple, willow, thorn, poplar, and even on conifers. Though exceedingly plentiful on the apple, it rarely attacks the pear tree, and the Lombardy poplar seems to be exempt, while other poplars suffer considerably. Very rarely does it attack the oak, and Dr Bull, who made exhaustive inquiry (*Journ. Bot.*, vol. ii.) into the matter, succeeded in "discovering only seven authentic cases in

*Dissert.*, 1865, and loc. cit., also in *Abhandl. d. Naturforsch. Ges. zu Halle*, xiii., Koch, "Untersuch. über d. Entwicklung d. Samens d. Orobanchen," in *Jahrb. f. wissensch. Bot.*, xi.; Caspary, "Ueber Samen, Keimung, etc., der Orobanchen," *Flora*, 1864; Lory, "Sur la respiration et la structure des Orobanchen," *Ann. d. Sci. Nat.*, ser. iii., 1847.

<sup>4</sup> R. Brown, "An Account of a New Genus of Plants, named *Rafflesia*, From the Flora Soc., published also in *Miscellaneous Works*; id., "On the Female Flower and Fruit of *Rafflesia Arnoldi*, and on *Hydnora africana*," *Ibid.*, xix.; Solms Laubach, loc. cit., and "Ueber das Haustorium der Loranthaceen und den Thallus der Rafflesiaceen und Balanophoren," *Abhandl. d. Naturforsch. Ges. zu Halle*, xiii.; id., "Ueber den Bau der Samen in der Fam. der Rafflesiaceen und Hydnoreen," *Bot. Ztg.*, 1874; Beccari, "Osservazioni a alcune Rafflesiacee," *Novo giorn. bot. Ital.*, 1876; Teysmann, "Nouvelles recherches sur la culture de *Rafflesia Arnoldi*," *Batavia*, 1866; De Barry, "Prosopeanche Burmeisteri, eine neue Hydnore aus Süd-America," *Abhandl. d. Naturforsch. Ges. zu Halle*, x.; Schimper, "Die Vegetation von *Prosopeanche Burmeisteri*," *Ibid.*, xv.; Bailion, "Sur le développement du *Cytinus*," *Bull. de la Soc. Anon. de Paris*, 1874; Archaingeli, "Étude sur le *Cytinus Hypocistis*," *Atti del Congresso internaz. botan.*, Florence, 1874.

<sup>5</sup> Foulton, "Ueber d. morphol. Werth d. Haustorium v. *Cassytha*," *Flora*, 1873.

<sup>1</sup> DeCandolle, *Études organiques sur les Cuscutées*, Toulouse, 1823; Solms Laubach, loc. cit.; Uloth, "Beiträge zur Phytol. der Cuscutaceen," *Flora*, 1860; Koch, *Die Klee und Pflasterörter, Untersuch. über deren Entwicklung*, etc., Heidelberg, 1850, where references to further literature are given.

<sup>2</sup> DeCandolle, *Ann. d. Bot.*, 1847; ser. iii., vol. viii., p. 2; Cornu, *Bull. d. la Soc. Bot. de France*, 1871, vol. xliii., p. 195; Hamelov, *Bot. Ztg.*, 1848, p. 14; Pitra, *Bot. Ztg.*, 1851, pp. 66 and 72; Solms Laubach, loc. cit.

<sup>3</sup> Solms Laubach, "De *Lathraea* generis positione systematica," in *Berlin*.

England. *Loranthus europaeus*, L., occurs on the oak in southern Europe.<sup>1</sup>

The *Santalaceae* are mostly if not all partially parasitic shrubs or herbs—their foliage containing chlorophyll. *Santalum* (*S. album* yields sandal wood), distributed throughout the East Indies, Malay Islands, and Australia, and *Thesium*, a native of Europe, are parasites on the roots of plants, especially monocotyledons. Their haustoria are more or less globular in shape, and emit from the surface in contact with the host a process which penetrates the tissues. *Osyris* also attacks the roots of trees. *Hemslowia* and *Myzodendron* are partially parasitic on the branches of trees. The latter, a native of south temperate climates, attaches itself to its host by means of the feathered processes on its seeds. These retain them in contact with the branches on which they fall until germination (thus performing the same function as the viscid pulp of the mistletoe), when the haustoria penetrate the bark and become, as it were, grafted into the living tissues.<sup>2</sup>

The *Balanophoraceae* are flowering plants of degraded structure, destitute of chlorophyll, and generally coloured red, yellow, or brown. In appearance they somewhat resemble *Cyrtinaceae*, though there is no real affinity in the case. The stems are succulent, somewhat knob-shaped or cylindrical, varying in height from a few inches to a foot, in which latter case they are sometimes branched, and bear imbricated scales in place of leaves. They are true parasites on the roots of woody Dicotyledons, rarely on Monocotyledons. The haustoria vegetate in the tissues, frequently setting up extensive hypertrophy. They occur chiefly in mountainous tropical regions—some in Australia and the Cape. The order contains thirty-five species in fourteen genera, of which *Balanophora*, *Cynomorium*, and *Langsdorfia* are the best known. *Cynomorium cocotum*—the *Fungus melitensis* of old writers—is found in Malta, the Levant, North Africa, and the Canary Islands.<sup>3</sup>

**ALGÆ.**—Several microscopic algæ may very well be partial parasites, though it is probable that in most cases they are little more than epiphytes in their relation to the plants in which they occur. They all possess chlorophyll and are able to assimilate; but from their situation in the tissues of other plants a degree of parasitism may be inferred. A species of *Nostoc* occurs in the intercellular spaces of the roots, leaves, and thalli of other plants; and *Chlorochytrium* is found in the tissues of *Lemna*, *Ceratophyllum*, and in another alga *Schisonema*. More distinctly parasitic is the case of *Phyllostiphon Arisari*, Kühn, which inhabits the parenchymatous tissue of *Arum Arisarum*.<sup>4</sup>

**LICHENES.**—*Mycoides parasitica*, Cunn., was described and figured by Cunningham as a parasitic green alga. It, or a closely allied form, has been recently examined by Ward, who says, "It seems clear that the injury is not due to a direct parasitic action of the thallus; even in the extreme case of *Citrus* I do not imagine the active development to depend so much on absorption of food from the living leaf as on the sheltered situation enjoyed by the ensconced thallus."<sup>5</sup>

**FUNGI.**—The absence of chlorophyll from all fungi, and the necessity thus thrown upon them of taking up the carbon compounds assimilated by other organisms, determines their mode of life, which is therefore either parasitic or saprophytic. The parasitic organ of the fungal thallus

is the *mycelium*, upon which haustoria are sometimes developed in the form of lateral protuberances of various shapes and sizes. In the same species of parasitic fungus sporidia frequently occur of different kinds, succeeding each other more or less regularly in cycles, and sometimes in their course preying upon hosts of remote affinities among themselves. This course of life is of practical importance when effort is made to limit the ravages of such a parasite (see MILDREW, vol. xvi. p. 293). Many indiscriminately attack plants nearly allied to each other; numerous species are peculiar to one host; while others are confined to a single region such as the ovary, the stem, or the leaf of one or more species of the higher plants. The spores, invariably of microscopical dimensions, represent the infectious agent, as the seeds of flowering parasites commonly do. They are conveyed by the atmosphere, by contact of one plant with another, by insects and other animals, &c., and germinate by the emission of a germ-tube, the production of zoospores sometimes intervening. Access to the host is obtained by the penetration of the epidermal tissue or by way of the open stomata. The main body of the fungus is either endophytic or epiphytic—the spore-producing portion in nearly all cases opening externally. The amount of damage effected by the attack varies from slight local injury to the destruction of the host; in some cases cell-contents only are destroyed, while in others whole tissues perish. The effect produced is often in the direction of abnormal stimulus, and the hypertrophy of whole regions or the production of galls ensues. The parasite commonly prepares the way for the saprophyte, which steps in to break up the dead and decaying remains. In certain rare instances the union of parasitic and saprophytic modes of life in the same species has been observed (see below). The fungi which are concerned in the constitution of lichens maintain with the algal components throughout life relations of consortium which will be dealt with below, under "Symbiosis."<sup>6</sup>

For the life-histories of the following groups the student is referred to the article FUNGUS (vol. ix. p. 827), and to the literature therein cited.

**Saprolegnias.**—The fungi of this suborder are many of them saprophytes, as their name implies, but some are of distinctly parasitic habits. Certain species of *Pythium* are parasitic on freshwater algae, on the prothallia of vascular cryptogams, and in the tissues of the higher plants. Several species of *Saprolegnia* are parasitic on similar hosts, but one in particular, *S. ferax*, Gruth, is well known for the part it plays in the disease of fishes in fresh water—commonly called the salmon disease. That this fungus possesses both parasitic and saprophytic modes of life is established, and the fact is one of remarkable importance, since it stands almost by itself in this respect among the higher fungi.<sup>7</sup>

The *Peronosporas* are all parasites on vascular plants of many different orders. The mycelium inhabits the tissues of the host, and, in many of the species, while passing through the intercellular passages, sends globular or irregularly branching filamentous haustoria (see fig. 3) into the adjoining cells. On the other hand the mycelial filaments of certain species, such as *Phytophthora infestans*, De Bary, the potato disease, possess no true haustoria, but they penetrate the cells, breaking down the cell-walls in their course. In the regions where the oospores of *Peronosporas* are formed hypertrophy of the tissues of the host sometimes occurs, and, the normal functions being checked, the parts in question die off. The *Peronosporas* are enormously destructive to the higher plants, and may be reckoned among the most dangerous enemies of agriculture and horticulture. Besides the potato disease, *Cystopus candidus*

<sup>1</sup> Solms Laubach, *loc. cit.*; Id., "Ueber das Haustorium der Loranthaceen," &c. in *Abhandl. d. Naturforsch. Ges. zu Halle*, xii., 1818; "Beitrag zur Entwicklungsgeschichte der Loranthaceen," in *Bot. Ztg.*, 1852; De Candolle, *Mémoire sur la famille des Loranthacées*, Paris, 1850; GümbeL, "Zur Entwicklungsgeschichte von *Viscum album*," *Flora*, 1854.

<sup>2</sup> Solms Laubach, *loc. cit.*; Mittou, "On the Economy of the Roots of *Thesium Inophyllum*," in *Hook. Lond. Journ. Bot.*, vol. vi.; Scott, "Untersuch. über d. Parasitismus von *Santalum album*," (for which see Solms Laubach, *loc. cit.*, 1874); Schulz, "Beobachtung über *Aspergillus generatus*, *Thesium intermedium*, und d. Verhältnis der Schmarotzer zur Nährpflanze," in *Flora*, 1854.

<sup>3</sup> Solms Laubach, *loc. cit.*; Id., "Ueber das Haustorium der Loranthaceen und den Thallus der Raffanaceen und Balanophoreen" in *Abhandl. d. Naturforsch. Ges. zu Halle*, xiii.; J. D. Hooker, "On the Structure and Affinities of *Balanophora*," &c. in *Trans. Linn. Soc.*, xii.; Goepfert, "Ueber den Bau der Balanophoren," in *Act. Acad. Cæs. Leop. Carol.*, vol. xviii., 1843, suppl.; Caruel, "Observation sul *Cynomorium*," in *Monop. giorn. Bot. Ital.*, viii.; Weddell, "Mémoire sur le *Cynomorium cocotum*," in *Arch. de Mus.*, 2.

<sup>4</sup> Cohn, "Ueber parasitische Algen," in *Beiträge zur Biologie der Pflanzen*, i.; Perceval Wright, "On a New Species of Parasitic Green Alga belonging to the genus *Chlorochytrium* of Cohn," in *Trans. Roy. Irish Acad.*, vol. xxv.; Kühn, "Mitteltheilung über eine neue parasitische Alge (*Phyllostiphon Arisarum*)," in *Sitzungsber. d. Naturf. Gesellsch. Halle*, 1878.

<sup>5</sup> Cunningham, "On *Mycoides parasitica*," in *Trans. Linn. Soc.*, ser. II., vol. I., Ward, "Structure, Development, and Life-History of a Tropical Epiphyllous Lichen," *Ibid.*, vol. II.

<sup>6</sup> The following works have special reference to fungal parasites:—Frank, *Die Krankheiten der Pflanzen*, 1880; Bornau, *Handbuch der Pflanzenkrankheiten*, 1874; O. Comes, *Le Crétogame parasitico delle piante agrarie*, Naples, 1863. Of historical interest are Unger, *Die Erantheen der Pflanzen* (1859), and *Beiträge zur vergleichenden Pathologie* (1840); Meyen, *Pflanzen-Pathologie*, 1861.

<sup>7</sup> Pringsheim, "Die Saprolegnien," in *his Jahrb. f. wissenschaft. Bot.*, I., 8, and ix.; De Bary, "Entgegnung auf Saprolegnien," *Ibid.*, II.; Lindstedt, *Synopsis der Saprolegnien*, Berlin, 1873; Cornu, "Monographie des Saprolegnien," in *Ann. Sci. Nat.*, ser. v., vol. xvi.; Hesse, *Pythium de Baryanum*, &c., Halle, 1874; Sadebeck, "Ueber *Pythium Equiseti*," in Cohn's *Beitr. zur Biol. d. Pflanzen*, I.; T. H. Huxley and G. Murray, "On Salmon Disease," in *Inspector of Fisheries Reports for 1861, 1862, 1863*; Marshall Ward, "Observations on the Genus *Pythium*," in *Quart. Journ. Microscop. Sci.*, vol. xxii., new ser.

and *Peronospora parasitica*, both occurring plentifully on *Cruciferae*, may be mentioned as typical of the group.<sup>1</sup>

The *Chytridiales* are a small suborder of parasitic fungi inhabiting rarely the epidermal tissue of higher plants, but commonly attacking fresh-water algae and sometimes *Infusoria*. Many of these exceedingly simple plants consist merely of a sporangial cell maintained in position and nourishment by a haustorium which penetrates the host cell. The affinities of the group are somewhat uncertain, but probably they are correctly placed among *Zygomycetes*.<sup>2</sup>

The *Uredines* are endophytic parasites on vascular plants producing the disease popularly called rust. These fungi occur on very various plants, and in their life-history go through a cycle of generations on at least in many cases two different hosts. Corn-mildew is the best known of them, and may be taken as typical of the rest (see MILDREW, vol. xvi. p. 293; and for figures, see FUNGUS, vol. ix.). This suborder, like the *Peronosporales*, is exceedingly destructive to cultivated and other plants. The *Rustelia* of the pear tree (which alternates with the *Podisoma* of junipers) and the *Puccinia* of *Malvaceae* may be mentioned as familiar examples of the group. The coffee-leaf disease, *Hemileia vastatrix*, is considered by Ward to be allied to this group.<sup>3</sup>

The *Ustilaginæ* are all parasites of a very destructive nature on the stems, leaves, ovaries, &c., of the higher plants. The mycelial filaments inhabit the tissues of the host, where hypertrophy is

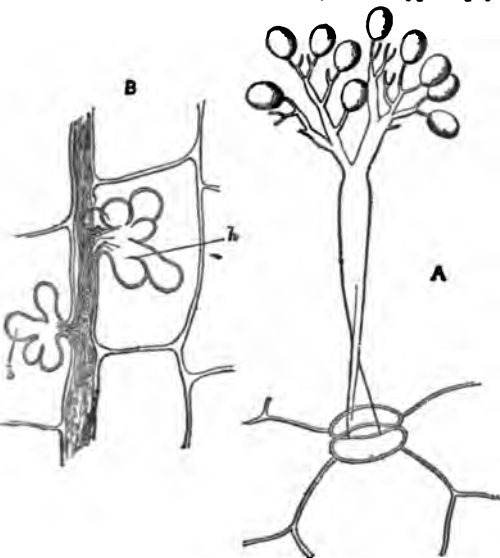

FIG. 3.—*Peronospora parasitica*, De By. A. Conidiophore with conidia. B. Mycelium with haustoria (A).

frequently set up, and the enlarged space thus obtained is used by the fungus to contain the masses of spores formed by the breaking up of the hyphae. Their whole life-history is carried out in the same host. Though attacking grain crops particularly, many species infest other plants. *Ustilago Carbo*, Tul., is perhaps the commonest, and is exceedingly destructive to a considerable number of grasses.<sup>4</sup>

The *Entomophthorales* are a very small group attacking insects. The mycelium ramifies densely in the body of the insect and breaks out through the skin where spores are produced singly on basidia. Within the body resting spores are formed by means of which the fungus hibernates. *Empusa Muscorum* is very common on the ordinary house fly.<sup>5</sup>

<sup>1</sup> De Bary, "Recherches sur le développement de quelques champignons parasites," *Ann. d. Sci. Nat.*, ser. iv., vol. xx.; id., "Zur Kenntnis der Peronosporales," in *Beitr. zur Morph. u. Physiol. d. Pflanz.* Hft. 2. See also POZARO. <sup>2</sup> Braun, "Ueber Chytridien," &c., in *Abh. d. Berl. Akad.*, 1855; Nowakowski, "Beitrag zur Kenntnis der Chytridiales," in Cohn's *Beitr. zur Bot. d. Pflanzenk.*; De Bary and Woronin, "Beitrag zur Kenntnis d. Chytridien," in *Ber. d. Naturforsch. Gesell. zu Freiburg*, 1863; Woronin, in *Bot. Ztg.*, 1860. <sup>3</sup> De Bary, *Untersuch. über die Uredinales* (Berlin, 1865), and "Neue Untersuch. über Uredinales," in *Monatsh. d. Berl. Akad.* (1865); Tulane, "Mém. sur les Uredines," &c., in *Ann. Sci. Nat.*, ser. III., vol. vi. (Uredin., p. 45), and *Ibid.*, ser. IV., vol. 8; Schröter, "Entwicklungsgeschichte einiger Rostpilze," in Cohn's *Beitr. zur Bot. d. Pflanzenk.*; Ward, "Researches on the Life-History of *Hemileia vastatrix*," in *Ann. Bot. Jour.*, vol. xix. <sup>4</sup> Tulane, *loc. cit.*; Flecher v. Waldheim, "Beiträge zur Biologie. . . der Ustilaginæ," in *Pringsh. Jahrb. v. wissenschaft. Bot.*, vii.; and *Aparys Systematische des Totfäulnis, Isaria pilosula verruculosa*, &c., Paris, 1877; De Bary, *Untersuch. über die Uredinales*, Berlin, 1865; Kühn, "Ueber die Art des Eindringens der Kestmiden," &c., in *Hilsmüller's d. Naturforsch. Gesellsch. Halle*, 1874, and *Bot. Ztg.*, 1874; Brefeld, *Bot. Unters. über Helmpilze*, v. 1883. <sup>5</sup> Cohn, "Empusa Muscorum und die Krankheit der Stubenfliege," in *Nova Acta*, xv.; Brefeld, "Untersuch. über die Entwicklung der *E. Muscorum* und *E. ruficornis*," in *Abh. d. Naturforsch. Gesellsch. Halle*, 1871; and "Ueber Entomophthorales," &c., in *Sitzungsber. d. Gesellsch. Naturforsch. Freunde, Berlin*, 1871,

The *Hymenomyces* is the only suborder of *Basidiomycetes* certainly known to include parasitic members, and these relatively few in number. *Agaricus mollis*, Vahl, by means of its subterranean mycelium (*Rhizomorpha subterranea* of older authors), is exceedingly destructive to the roots of many trees and woody plants. Other *Agariciales*, such as *Nyctalis parasitica*, attack members of the same group as themselves, but by far the greater number are saprophytes. *Trametes radiciperda*, R. Hart., and *T. pini*, Fr., *Polyporus fulvus*, Scop., *P. vaporarius*, Fr., *P. mollis*, Fr., and *P. borealis*, Fr., all attack *Coniferae* especially, while *P. sulphureus*, Fr., *P. igniarius*, Fr., and *P. dryadens*, Fr., are parasitic on oaks, poplars, beeches, willows, and other dicotyledonous trees. *Thelephora*, *Stereum*, and *Hydnium* also include species parasitic on trees.<sup>6</sup>

The *Discomycetes*, like the last group, are mostly saprophytes, but a few distinctly parasitic members are to be found in it. *Ascomyces*, *Gymnascus*, and *Exococcus* (*E. Pruni*, Fückel, and *E. deformans*, Fückel) are parasitic, the last named upon plum, peach, and cherry trees. Several species of *Peziza*, as *P. calycina*, Schum., on the larch, and a number of those belonging to the section of *Pseudopezizae* attack the higher plants. It is highly probable that many *Sclerotia*, numbers of them parasitic, the positions of which are not definitely known, will be found to belong to such discomycetous forms as *Peziza*. *Peziza sclerotoides*, Lib., is said to remain living as a saprophyte after the death of its host. *Rhizoma* is a very common disease of leaves, such as those of *Acer*, in which it produces large darkly discoloured patches.<sup>7</sup>

*Pyrenomyces*.—Of this group the *Erysiphæ* are perhaps the most destructive as parasites. They exhibit in their life-history a cycle of generations each of considerable parasitic activity. The main body of the fungus is commonly epiphytic, the mycelium sending down haustoria through the epidermis of the host (see fig. 4). Of the perithecial form of fructification good examples are *Sphaerotheca Castagnei*, Lev., the hop mildew (see MILDREW, vol. xvi. p. 294), *Phyllactinia*, *Uncinula*, *Calocladia*, and *Erysiphe* (*E. graminis*, Lev., *E. Linthii*, Lev., *E. Martii*, Lev., and *E. lampyrocampa*, Link.). The oidium forms are also conspicuous as parasites, a familiar example being found in *E. Tuckeri*, Berk., the vine-mildew (see MILDREW, as above). *Claviceps purpurea*, Tul., the ergot of grasses (see ERGOT, vol. viii. p. 251), is the best known and most important of all pyrenomycetous parasites. The group includes a multitude of minor parasites,—some of them, however, doubtfully so—belonging to such genera as *Stigmatalia*, *Sphaerella*, *Fusicladium*, *Ramularia*, *Fumago*, *Polystigma*, *Pleospora*, *Nectria*, &c. *Nectria ditissima*, Tul., is reputed to be the cause of canker in certain trees. *Cordyceps* is well known as a disease of insects.<sup>8</sup>

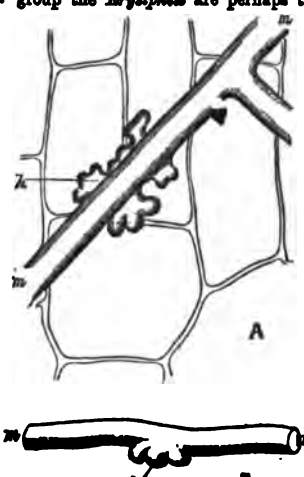

FIG. 4.—*Erysiphe Tuckeri*, Berk. A and B, mycelium (m), with haustoria (A). After De Bary.

NATURE OF VEGETABLE PARASITISM.—It has been seen that the dependence of parasites upon their hosts for the means of subsistence varies considerably in degree, but it is equally manifest that underlying this condition of existence there are certain facts which characterize every case. The most important of these is the absence or the inadequate supply of chlorophyll and the

<sup>6</sup> R. Hartig, *Wichtige Krankheiten der Waldbäume*, Berlin, 1874; Brefeld, *Botanische Unters. über d. Schimmelpilze*, III.; and compare also De Bary in *Morph. u. Physiol. d. Pflanz*, p. 22. <sup>7</sup> Willkomm, *Die mikroskopischen Früchte des Waldes*, II.; Rehm, *Die Entomophthorales eines die Kleinflecken verursachenden Pilzes*, Göttingen, 1873; Frautl, "Hysterium Pinastri, Schrad., als Ursache der Schüttekrankheit der Kiefer," in *Flora*, 1877; Hartig, *loc. cit.*; Tschombroff, "Peziza Kaufmanniana, eine neue aus Sclerotium stammende und auf Hanf schmarotzende Boehrerie-Sporidie," in *Bull. Soc. Nat. Moscou*, 1869; Brefeld, *Bot. Unters. über Schimmelpilze*, Leipzig, IV. Heft, 1882. <sup>8</sup> Tulane, *Salvia fungorum Carpologia*, Paris, 1861-65, and "Mémoire sur l'Ergot des Graminées," in *Ann. Sci. Nat.*, ser. III., vol. xx.; Kühn, "Untersuch. über d. Entwick., &c., des Mutterkornes," in *Mittl. Physiol. Lab. Untere. Halle*, I. Hft., 1863; V. Mohl, "Ueber die Fleckenkrankheit der Manbeerblätter und die *Septoria Mori*, Lev.," in *Bot. Ztg.*, 1864; and "Ueber die Traubenkrankheit," in *Bot. Ztg.*, 1864; De Bary, "Zur Kenntnis insectentödtender Pilze," in *Bot. Ztg.*, 1867.

consequent loss or deficiency of the power of assimilation. For a comparison of this abnormal condition with the normal state a subject is found ready to hand in the nourishment of one organ by another, as exemplified in the growth of young seedlings, which in the case of seeds containing endosperm (coconut, date-palm, and many other monocotyledons) absorb by means of a definite organ the nourishment necessary for their development. Young plants nourished from the reserve-materials stored in bulbs and the like, and the young shoots of a tree from winter buds, afford a comparison which is even closer in an anatomical respect, since in this case there is present, as in the intimate association of parasitic haustoria with the host, a continuity of tissues which is not so strongly marked in the union of the absorbing organ of a seedling with the endosperm. Looking at the subject wholly from the point of view of the process of nutrition, there seems to be little essential difference between parasite and saprophyte, since we have not only experimental instances of the nutrition of parasites on artificially prepared solutions, but the natural union of both habits in the same individual (salmon-disease, &c.; see also the experiments of Grawitz on the growth of saprophytic fungi in the blood of animals). These are exceptional instances, however, and it is manifest that other properties must be brought into play, since most parasites affect peculiar hosts, and many of them certain regions only of the plant. It is equally true that many saprophytes are able to grow only in peculiar substrata.

That parasitism is often but partial is apparent from such instances as the mistletoe, *Rhinanthus*, *Thesium*, &c., which probably obtain from their hosts in the main only water and mineral substances in solution, to be prepared for plant food in their green leaves. It is most likely, however, that a small quantity of certain organic compounds is a necessary accompaniment in all such instances. Here again there exist the means for comparison with green saprophytes. The taking up of ash constituents from the soil may occur in such parasites as *Orobancha*, which possesses rootlets, though undoubtedly the whole of the necessary carbon compounds are obtained from the host.

This mode of life not only acts upon the host, but reacts upon the parasite itself, as is manifested by the aberrant and degraded structure of the parts (directly and indirectly) concerned in nutrition, and even of the reproductive system. This is strongly marked in the case of the embryo. It is apparent that large transpiratory surfaces are unnecessary, and would even be of detriment to a parasite; and with this the formation of wood so intimately connected with the process of transpiration keeps pace in degradation. In the mistletoe, for example, the bulk of wood is in relation to the small transpiratory surface, and in the cases of parasites without chlorophyll it dwindles to insignificance. No other abnormal mode of life so influences the structure of a plant as a parasitic or a saprophytic one, though we see an approach to it in the adaptations existing in insectivorous plants.

The effect upon the host ranges from local injury to destruction on the one hand, and, on the other, in the case of stimulus, from the local production of galls to the complete hypertrophy and transformation of at least large regions of a plant. The exciting of definite reparative processes is an indirect effect. It must be noticed also that many parasites, especially fungi, cause in the host enormous destruction of food material far exceeding that necessary to their maintenance. In this way the parasite frequently commits suicide as it were, and the act is in striking contrast to the relations of symbiosis as exemplified in the lichen thallus.

The change of or alternation between two different hosts is adapted to suit the requirements of the parasite. This is notably so in the case of the corn-mildew, which passes an intermediate stage on the barberry until a period when the wheat plant has sufficiently developed to become a suitable host.

Most fungi are endophytic, and certain phanerogamic parasites, such as *Rafflesia*, develop within the cortex of the host, while on the other hand the fungal part of a lichen encloses the algal.

The existence and complete dependence upon its host of a parasite culminating in the production of seed after its kind is one of the most impressive relationships physiology presents.<sup>1</sup>

**SYMBIOSIS.**—This, the consortium of organisms in such fashion that mutual services are rendered sufficient to make the alliance profitable and successful to the whole community of organisms, is a mode of life closely related to parasitism, in which, however, as has been seen, the profit is one-sided and the alliance ends with the exhaustion of the host or the detachment of the parasite. The term was first employed by De Bary (*Die Erscheinung der Symbiose*, 1879), but the relations expressed by it were first brought into general notice by the epoch-marking discovery of the dual nature of the lichen thallus by Schwendener in 1868, and established after prolonged and searching controversy, more especially by the classical histological researches of Bornet, and the actual artificial lichen synthesis (by sowing fungus on alga) by Stahl. Some theory of reciprocal accommodation was necessary to account for the duration of such relations between a fungal organism and an alga; and, though it is not yet precisely known in what way these relations are maintained, speculation has been active enough. It may safely be inferred that the fungal portion of the thallus is nourished by the exosmose of starch and the like in much the same fashion as the colourless cells of a plant are fed by those bearing chlorophyll; and there can be little doubt that the algal cells benefit in return by the endosmose of the waste products of the fungal protoplasm. In the reproductive process an adaptation exists in certain lichens for the supply of gonidia to the new lichen. Hymenial-gonidia (the offspring of the thallus-gonidia) are present in the apothecia, from which they are cast out along with the spores, and falling with them are subsequently enclosed by the germ tubes (see *FUNGUS*, vol. ix. p. 835). It may be noted here that, though the fungal portions of the thallus retain the marks of near relationship to ascomycetous fungi, they are yet considerably modified by this mode of life, and unfitted most probably in nearly every case for the distinctly parasitic or saprophytic life norms of fungi. The algal portion, on the other hand, is capable of independent existence after liberation from the fungal thallus. The complete symbiotic community represent an autonomous whole, living frequently in situation where neither alga nor fungus is known to support existence separately.<sup>2</sup>

The presence of chlorophyll in animals (*Hydra* and *Vortex*) was discovered by Max Schultze in 1851, and confirmed more recently (*Hydra* and *Spongia*) by the spectroscopic evidence furnished by Lankester and Sorby. That a chlorophyll-bearing animal is able to

<sup>1</sup> P. Grawitz, "Ueber Schimmelvegetationen in tierischen Organismen," *Vierteljahrsschrift der Naturforschenden Gesellschaft in Zürich*, 1890; and "Experimentelle zur Infektionsfrage," *Berlin, Deutsche Versuchsanstalt für Landwirtschaft*, No. 14, 1891; Brückel, *Botanische Untersuchungen über Schimmelpilze* (1891), and *Ueber Symbiosen* (1895). A very graphic account of the physiology of parasitism is to be found in Sachs, *Vorlesungen über Pflanzenphysiologie*, 1892. See also Pfeffer, *Pflanzenphysiologie*, 1891.

<sup>2</sup> Schwendener, *Untersuchung über den Flechten-Thallus*, 1868; Stahl, *Beiträge zur Symbiosegeschichte der Flechten*, 1877; Bornet, "Recherches sur les gonidies des Lichens," *Ann. Bot. Bot.*, 9th ser., 1878; De Bary, *Morphologie u. Physiologie der Flechten, Flechten, und Mycetozoen* (1895), and *Die Symbiose der Mycetozoen* (1879), which includes an account of the association of *Acetabularia* with *Anabaena*, & of the relations of *Hydra* to green roots.

vegetate by means of its own intrinsic chlorophyll was finally established in 1878 by the experiments of Geddes on *Convolvata Schultzei*, Schm. He found that the analysis of the gas given off by these green animals, under the influence of direct sunlight, "yielded from 45 to 55 per cent. of oxygen." The discovery of these vegetating animals directed fresh attention to chlorophyll-bearing animals, with much result. The nature and functions of the yellow cells of radiolarians had long been an unsolved enigma. Haeckel had detected in them in 1870 the presence of starch, and regarded them as stores of reserve material. Cienkowski, in the following year, contended for their algal nature without finally deciding the question, and without perceiving the significance such organisms would have in the economy of the radiolarian. Much suggestive observation followed by the Hertwig, Brandt, Entz, Korotneff, Lankester, Moseley, and others on similar bodies in various organisms; but the subject remained in uncertainty till its reinvestigation by Brandt, and simultaneously and much more conclusively by Geddes, finally supplied the solution of the difficulties. After confirming Haeckel's discovery of the presence of starch, and the observations of Cienkowski, Brandt, and others on the survival of the yellow cells after the death of the radiolarian, and extending his observation to various other organisms, Geddes demonstrated the truly algal nature of these cells from their cellulose walls, the identity of their yellow colouring-matter with that of diatoms, and the evolution of oxygen (in some instances, such as *Anthea Cereae*, very copiously) under the influence of sunlight. It was pointed out that the animal protoplasm investing these starch-producing cells (and containing amylolytic ferment) must obtain by osmosis its share of the dissolved starch, and that benefit must accrue to the animal from the digestion of the dead bodies of the algae. The evolution of oxygen during sunshine into the surrounding animal protoplasm is a respiratory function fittingly compared to that performed by certain stationary deposits of hæmoglobin. On the other hand the carbonic acid and nitrogenous waste produced by the animal cell is the nutritive return made to the alga, which in removing them performs an intracellular renal function. The young gonophores of *Veella*, after budding off from the parent, start in life with a provision of algae, and in this respect bear interesting resemblance to the function performed by the hymenial-gonidia of lichens described above. The physiological relations are summed up as follows:—"Thus, then, for a vegetable cell no more ideal existence can be imagined than that within the body of an animal cell of sufficient active vitality to manure it with abundance of carbonic anhydride and nitrogenous waste, yet of sufficient transparency to allow the free entrance of the necessary light. And, conversely, for an animal cell there can be no more ideal existence than to contain a sufficient number of vegetable cells, constantly removing its waste products, supplying it with oxygen and starch, and being digestible after death." The completeness of the case thus established for a symbiotic mode of life marks one of the most interesting and impressive chapters in the history of the biological relations between animals and plants.

A re-discussion of the subject, largely historical and controversial, but with excellent bibliography, has been lately furnished by Brandt, and more recently a further contribution has been made by Oscar Hertwig, who repeats the views of preceding investigators and goes on to speculate as to the nature of symbiosis and its general relations with other modes of life.<sup>1</sup> (G. M.)

<sup>1</sup> *Strahlens, Beitr. zur Naturg. d. Furbelarten*, 1891; Lankester, "Abstract of a Report on the Spectroscopic Examination of certain Animal Substances," *Jour. of Acad. Sc.*, 1879; Id., "On *Euthepasma*," *Quart. Jour. Microscop.*, *Vol.*, 1879, and "On the Chlorophyll Corpuscles and Amyloid Deposits of *Spongilla* and

## PARASITISM IN MEDICINE.

Only a limited number of the parasitic diseases of man are included in the present article. Under TAPEWORM will be found all that medically relates to that important parasitic group, and under SCHIZOMYXOMES will be discussed the significance of the parasitic micro-organisms (*Bacterium*, *Bacillus*, *Spirillum*, *Vibrio*, &c.) in morbid processes, and particularly in the infective diseases. There fall to be considered here (1) the skin-diseases due to filamentous fungi, (2) a peculiar disease called "actinomycosis," primarily affecting cattle, (3) the itch, and (4) certain diseases caused by various species of nematodes, and one disease caused by a trematode.

## 1. Skin Diseases due to Parasitic Fungi.

*Favus* ("honeycomb") is a common disease of the scalp (more rarely of the hairless parts of the skin) in children, primarily of scrofulous or ill-cared-for children, but apt to spread to others, especially in schools. The uncomplicated appearance is that of a number of yellowish circular cup-shaped crusts, grouped in patches like a piece of honeycomb, each about the size of a split pea, with a hair projecting in the centre. This was the first disease in which a fungus was discovered—by Schönlein in 1839; the discovery was published in a brief note of twenty lines in *Müller's Archiv* for that year (p. 82), the fungus having been subsequently named by Remak *Achorion Schönleini* after its discoverer. The achorion consists of slender mycelial threads matted together, bearing oval nucleated gonidia either free or jointed. The spores would appear to enter through the unbroken cutaneous surface, and to germinate mostly in and around the hair-follicle and sometimes in the shaft of the hair. Favus is commonest among the poorer Jews of Russia, Poland, Hungary, Galicia, and the East, and among the same class of Mohammedans in Turkey, Asia Minor, Syria, Persia, Egypt, Algiers, &c. It is not rare in the southern departments of France, in some parts of Italy, and in Scotland.

The treatment of favus is difficult and disappointing. The first requisite is good feeding; meanwhile the crusts are to be removed by poulticing, the hair being cut short. The next thing is to destroy the fungus, to which end a lotion of sulphurous acid (one part to three or four of water) may be applied repeatedly by means of lint, and the scalp kept covered by an oil-silk cap. To prevent the return of the fungus, various agents may be rubbed in, such as cod-liver oil, oil of cade, or an ointment of iodine or of pitch, the oil-silk cap being worn continuously. It has often been found of advantage to pull out all the broken stumps of hairs with a tweezers (see Bennett's *Prin. and Pract. of Med.*, 5th ed., Edin., 1868, p. 847).

*Ringworm*, or *Tinea tonsurans*, a much more common disease of the scalp (especially within the tropics), consists of bald patches, usually round, and varying in diameter from half an inch up to several inches, the surface showing the broken stumps of hairs and a fine whitish powdering of desquamated epidermic scales. In scrofulous subjects matter is sometimes produced, which forms crusts or glues the hairs together or otherwise obscures the characteristic appearance. The disease is due to a fungus, *Trichophyton tonsurans*, which exists mostly in the form of innumerable spores (with hardly any mycelium), and is most abundant within the substance of the hairs, especially at their roots. If a piece of the hair near the root be soaked for a time in dilute liquor potassæ and pressed flat under a cover-glass, the microscope will show it to be occupied by long rows of minute oval spores, very uniform in size, and each bearing a nucleus. The treatment of ringworm is very much the same as the treatment of favus.

The same fungus sometimes attacks the hairs of the beard, producing a disease called "sycosis." Sometimes it invades the hairless regions of skin, forming "tinea circinata;" circular patches of skin disease, if they be sharply defined by a margin of papules or vesicles, may be suspected of depending on the tinea-fungus. Interesting varieties of tinea are found in some of the Pacific and East Indian islands.

A less serious condition of the skin due to a fungus is *Pityriasis*

*Hydra*, *Quart. Jour. Microscop. Sc.*, 1869; Sorby, "On the Chronological Relations of *Spongilla subnitida*," *Quart. Jour. Microscop. Sc.*, 1871; Geddes, "Observations on the Physiology and Histology of *Convolvata Schultzei*," *Proc. Roy. Soc. Lond.*, 1879, and "On the Nature and Functions of the Yellow Cells of Radiolarians and Coelenterates," *Proc. Roy. Soc. Edin.*, 1889; Haeckel, "Amylum in d. gelben Zellen d. Radiolar., *Jena Zeitsch.*, 1870; Cienkowski, "Ueber Schwammbildung bei Radiolar., *Archiv. Natur. Anst.*, 1871; R. Hertwig, "Zur Histologie der Radiolar., 1874;" "Der Organismus der Radiolar., *Jena Zeitsch.*, 1875; O. and R. Hertwig, "Die Actinen," *Jena Zeitsch.*, 1876; O. Hertwig, *Die Symbiose*, 1888; Brandt, "Untersuchungen an Radiolarien," *Monatsh. Acad. Berl.*, 1881; Id., "Ueber d. Zusammenleben von Thieren und Algen," *Verhandl. d. physiol. Ges. zu Berl.*, 1881; Id., "Ueber d. Morph. u. Physiol. Bedeutung d. Chlorophylls bei Thieren," *Arch. f. Anat. u. Physiol.*, 1882, and *Mémoires d. Zool. Soc. Napoléon*, 1889; Entz, "Ueber d. Natur d. Chlorophyll-Körperschen niedriger Thiere," *Biol. Centralblatt*, 1883; Korotneff, "On *Syringotheca*," *Arch. Anat. Med.*, 1881; Moseley, *Notes of a Naturalist on the "Challenger"*, p. 296.



*verrucolor*, consisting of patches of brownish discolorations of various sizes and shapes, mostly on the front of the body, and often attended with itching, especially after heating exercise. The pigmentation seems to radiate from the orifices of hair-follicles. The epidermis is in a scaly condition over the patch, and among the debris of the epidermic cell there may be seen minute oval spores, which are supposed to belong to a fungus, the *Microsporion Puyferri*. The disease is mostly one of adult age, found all over the world, and not associated in any special way with poor general health. The treatment consists of rubbing in an ointment of sulphuret of potassium, or one of the mercurial ointments, or using sulphur-soap habitually.

The remarkable brown, black, and blue spots of discoloration of the whole body met with endemically in Mexico, Panama, New Granada, and Venezuela, and known under the name of "pinto," or "mal de los pintos," have been claimed by Gastambide (*Præses Med. Belgæ*, 1881, Nos. 33-41) as due to the presence of a fungus, whose spores and even mycelial filaments may be detected among the deeper rows of cells of the rete mucosum. The disease, which is somewhat serious from its large superficial area, would appear to be one of the many forms of *morbus miliaris*; but it is contagious, and is sometimes seen in the wall-to-do. In some villages of the western districts of Tabasco (Mexico), it has been estimated that 9 per cent. of the inhabitants suffer from the pinto; McClellan says that in 1826 in the city of Mexico he saw a whole regiment of "pintados."

Before leaving the parasitic fungi of the skin, it should be mentioned that *Oidium albicans* is apt to plant itself on the mucous membrane of the mouth in young and ailing children, causing whitish patches known as thrush.

### 2. Actinomycosis.

In certain tumour-like formations of cattle, usually growing from the alveoli of the lower molar teeth, and protruding externally near the angle of the jaw, Bollinger in 1877 detected the presence of a number of sulphur-yellow bodies about the size of a hemp seed and of a fatty consistence. These were found to be aggregates of a peculiar radiate fungus (*Actinomyces*), which assumed the form of minute rosettes, the mycelial filaments expanding into flask-like swellings at their free or circumferential ends. The yellow seed-like conglomerates lay in spaces of the tumour, and they were also found within cavities on the tongue, fauces, larynx, mucous membrane of the stomach, in lymphatic glands, and (by a later observer) in the lungs. In 1879 Ponfick found the same sulphur-yellow bodies in the body of a man who had died of chronic disease of the chest, and who had a number of sinuses in the skin of the back. Some twenty cases of actinomycosis in man have now been described in Germany; in most of them there have been centres of chronic inflammation in front of the vertebrae in the cervical, dorsal, or lumbar regions, with numerous sinuses penetrating the muscles and opening on the skin. The yellow conglomerates of *Actinomyces* are found in or upon the granulations of these sinuses, or in the sero-purulent discharge from them, or in the muscles, or more rarely in centres of granulation-like new growth in some of the viscera. The relation of the fungus to the primary tumour-like new growth of the ox has not yet been made out, and there is hardly any clue to the connexion between the bovine disease and the somewhat modified form of it in man. In some respects there is an analogy between actinomycosis and the fungus-foot of India as described by Vandyke Carter.

### 3. Scabies.

Of the human diseases due to animal parasites there is only one of any importance affecting the skin, namely, scabies or the itch. The parasite is the *Sarcoptes scabiei* (see MITZ, vol. xvi. p. 529), which burrows under the epidermis at any part of the body, but hardly ever in the face or scalp of adults; it usually begins at the clefts of the fingers, where its presence may be inferred from several scattered pimples, which will probably have been torn at their summits by the scratching of the patient, or have been otherwise converted into vesicles or pustules. The remedy is soap and water, and sulphur ointment.

### 4. Diseases due to Nematode and Trematode Worms.

The common thread-worm (*Oxyuris*), a small white object about half an inch long, is very frequent in all countries, mostly in children; its habitat is the lower bowel, but it is often a troublesome irritant outside the bowel as well. The round-worm (*Ascaris lumbricoides*), about 6 inches long when full-sized, and not unlike the common earth-worm, is less common in England and other Western countries; but it is enormously common all over the East, and in the tropics generally. Hundreds of them may accumulate in the body, causing an obvious enlargement of the abdomen. The most valuable remedy against them is santonine powder. A third intestinal nematode is the whip-worm (*Trichocephalus dispar*), about 2 inches long, having a slender anterior extremity joined on to the body like the thong to the handle of a whip. It is said to be very common in some countries, such as France, but it has no great importance as regards disease.

The nematodes of greatest pathological interest are *Trichina spiralis*, causing the serious malady of trichinosis; *Anchyllostoma*

*duodenale*, often associated with the profound anemia of men working in mines, making tunnels, and the like; *Anguillula stercoraria*, associated with a specific kind of diarrhoea in Cochin China; *Filaria sanguinis hominis*, a blood-worm occurring mostly in China and other parts of the East, and often associated with the disease called lymph-scrotum, and with hæmato-chyluria; and *Filaria medinensis*, the Guinea-worm, very common on the Guinea coast and in many other tropical regions, a long and slender filament like a hair from a horse's tail, and mostly infesting the skin of the legs.

*Trichinosis*.—The presence of encysted trichinæ in the muscles was discovered in one or more of the London dissecting-rooms in 1828 and following years; but it was not until thirty years later that the clinical characters of the acute disease caused by the invasion of the parasite were discovered. This discovery was made in 1860 by Zenker, on examining the abdominal muscles of a patient who had died at Dresden, with symptoms taken to be those of typhoid fever, the case being afterwards accounted one of trichinosis on the *post mortem* evidence. Epidemics of this disease occur from time to time, especially in north Germany, from the eating of uncooked swine's flesh, in which trichinæ are not uncommon. The greatest care is now taken in Germany to examine the carcasses of swine for trichinæ, a piece of the diaphragm of every animal being searched with the microscope by an inspector specially appointed. The symptoms in man are occasioned by the presence of the free parasites in the intestine, by the development of young trichinæ from the eggs, and most of all by the migration of the parasites from the intestinal canal to the muscles, where they become quiescent within a calcareous shell. This cycle occupies from four to six weeks. When consumed in small quantity, the parasites may give rise to no marked symptoms, and they are sometimes found accidentally in muscular fibres in the bodies of those who had probably experienced no definite symptoms from their invasion. In the more acute and serious cases, sometimes ending fatally, the early symptoms are nausea, failure of appetite, diarrhoea, and fever; later, when the migration to the muscles begins, there is more fever, stiffness, pain, and swelling in the limbs, swelling of the eyelids, continued exhausting diarrhoea, perspirations, and sometimes delirium. During convalescence there is desquamation of the cuticle. If the diagnosis be made early in the case, brisk purgatives, particularly calomel, are the best treatment; if the parasites are already on their way to the muscles, the only thing left to do is to support the patient's strength.

*Anæmia and Cachexia caused by Anchylostoma duodenale*.—A disease which caused a great mortality among the negroes in the West Indies towards the end of last century, and of which descriptions were afterwards sent from Brazil and various other tropical and subtropical regions, was identified, chiefly through the labours of Bilhars and Griesinger in Egypt (1854), as being due to the presence in the intestine of nematode worms from one-third to half an inch long, and variously named *Anchylostoma*, *Sclerostoma*, *Strongylus*, &c. The same disease has subsequently been found in some places among miners, and particularly among the men employed in making the St Gotthard tunnel. Various names have been given to the malady, such as mal d'estomac, mal de cœur, dirt-eating, anemia intertropicalis, cachexia Africana, and cachexia æquea. The symptoms, as first observed among the negroes, were pain in the stomach, capricious appetite, pica (or dirt-eating), obstinate constipation followed by diarrhoea, palpitations, small and unsteady pulse, coldness of the skin, pallor of the skin and mucous membranes, diminution of the secretions, loss of strength, and, in cases running a fatal course, colliquative diarrhoea and dysentery, hæmorrhages, and dropsies. The parasites, which cling to the intestinal mucous membrane, draw their nourishment from the blood-vessels of their host, and as they are found in hundreds in the body after death, the disorders of digestion, the increasing anemia, and the consequent dropsies and other cachectic symptoms are easily explained. It seems probable that the parasite is introduced in its larval stage through the medium of the drinking-water. Male-fern, santonine, or other anthelmintic remedies are prescribed for it; but, inasmuch as it is most apt to lodge in the bodies of the ill-fed and otherwise ailing poor, there is little doubt that the most satisfactory remedy would be to increase the power of resistance by improving the general well-being.

*Chyluria and Lymph-Scrotum caused by Filaria sanguinis hominis*.—A milky appearance of the urine, due to the presence of a substance like chyle, which forms a clot, had been observed from time to time, especially in tropical and subtropical countries; and it has been proved by the late Dr Wucherer of Bahia, and by Dr Timothy Lewis, that this peculiar condition is uniformly associated with the presence in the blood of minute eel-like worms, visible only under the microscope, being the embryo forms of a *Filaria*. The parent worms are very difficult to find, and their characters and habits are imperfectly known; but they are supposed to be about 3 inches long, and to inhabit dilations of the lymph-carrying vessels. It is not yet clear how the chyle gets into the urine, but it seems probable that the blood in which filariae are present is altered in its constituents, although there is no obvious change in



its microscopic characters beyond the presence of the young nematodes. These are also present in the chylous urine. Sometimes the discharge of lymph takes place at one or more points of the surface of the body, and there is in other cases a condition of neuro- elephantiasis of the scrotum, or lymph-scrotum. More or less of blood may occur along with the chylous fluid in the urine. Both the chyria and the presence of filariae in the blood are curiously intermittent; it may happen that not a single filaria is to be seen during the daytime, while they swarm in the blood at night, and it has been ingeniously shown by Dr S. Mackenzie that they may be made to disappear if the patient sits up all night, reappearing while he sleeps through the day.

Dr Manson of Amoy has proved that mosquitoes imbibe the embryo filariae from the blood of man; and that many of these reach full development within the mosquito, acquiring their freedom when the latter resorts to water, where it dies after depositing its eggs. Mosquitoes would thus be the intermediate host of the filariae, and their introduction into the human body would be through the medium of water.

**Dracontiasis or Guinea-worm.**—*Filaria medinensis*, or *Dracunculus*, or Guinea-worm, is a very long filariform nematode like a horse hair, whose most frequent habitat is the skin of the legs and feet. It is common on the Guinea coast, and in many other tropical and subtropical regions, and has been familiarly known since ancient times. The condition of dracontiasis due to it is a very common one, and sometimes amounts to an epidemic. The black races are most liable, but Europeans of almost any social rank and of either

sex are not altogether exempt. The worm lives in water, and, like the *Filaria sanguinis hominis*, appears to have an intermediate host for its larval stage. It is doubtful whether the worm penetrates the skin of the legs directly; it is not impossible that the intermediate host (a cyclops) which contains the larvae may be swallowed with the water, and that the larvae of the *Dracunculus* may be set free in the course of digestion.

**Endemic Hamaturia and Calculus due to *Distoma hamatobium*.**—*D. hamatobium* is a trematode or fluke-worm, which is extensively parasitic in man in northern and southern Africa—in the former along the Nile, and in the latter mostly on a narrow belt of the Natal coast. The parasites live mostly in the blood-vessels of the intestine and of the urinary bladder, whence they reach the mucous membranes; and the most remarkable effects of their parasitism are bleeding from the surface of the bladder and the formation of uratic and phosphatic calculi around the clusters of eggs deposited by the *Distoma*. The mode of access to their human habitat is still uncertain.

**Literature.**—The more special memoirs are Ponsick, *Die Actinomykose des Menschen, eine neue Infektionskrankheit* (plates, Berlin, 1863); Leuckart, *Uebersicht über Trichinen spärlich* (plates, Leipzig, 2d ed., 1866); Virchow, *Abhandlung der Lehre von den Trichinen* (plate, Berlin, 2d ed., 1864); Loig, *De l'asémie des mineurs en Gohard, causée par l'Ankylostome duodenal*, in *Tran. Inst. Med. Congr.*, 1881, i. p. 437, and papers quoted in Hirsch; T. R. Lewis, *On a Hamatocoon inhabiting Human Blood, its relation to Chyluria*, &c., Calcutta, 1873; Manson, *The Filaria Sanguinis Hominis*, &c. (plates, London, 1884); S. Mackenzie, "Case of filarial hamato-chyluria," in *Trans. Path. Soc. Lond.*, 1883, p. 394; see also Hirsch, *Historisch-geographische Pathologie*, vol. II., Stuttgart, 1883 (English translation). (C. C.)

**PARCÆ.** See **FATES**, vol. ix. p. 49.

**PARCHMENT** consists of skins of various animals, unhaird, cleaned, and dried so as to form sheets of uniform thickness suitable for writing upon and for the numerous other purposes to which such preparations are devoted (see **PALÆOGRAPHY**, p. 144). The skins employed for parchment are principally those of sheep, lambs, and calves; but goat and ass skins are similarly dressed for special purposes. The preliminary unhairing and cleaning of the skins are effected as in the leather manufacture (see **LEATHER**, vol. xiv. p. 380). In their moist flexible condition the unhaird skins are tightly and uniformly stretched over a wooden frame termed a horse, and on the flesh side they are carefully gone over with a semicircular fleashing knife which removes all adherent flesh. The grain side is also gone over to clean the surface and squeeze out a proportion of the absorbed moisture. Ordinary binder's parchment and drum-head parchment need no further preparation, but are simply allowed to dry gradually on the frames on which the skins are stretched. But fine parchment for writing and vellum are powdered with chalk on the flesh side and carefully rubbed with fine pumice stone till a delicate uniform velvety surface is raised. All inequalities on the grain side are also removed by paring and rubbing with fine pumice. Stout vellum is made from calf skins, and ordinary qualities from split sheep skins; for drum heads, tambourines, and like applications goat and calf skins are used, and it is said that wolf skins yield the best drum heads.

**Vegetable Parchment**, or parchment paper, is a modified form of paper produced by chemical treatment, having considerable similarity to ordinary animal parchment. It is prepared by acting on ordinary unsized paper with dilute sulphuric acid, and immediately washing away all trace of acid. Paper so treated will be found to have undergone a remarkable change: the porous intertexture of cellulose composing unsized paper will have expanded and agglutinated, forming a homogeneous surface, translucent, horny, and parchment-like; it will have acquired about five times the strength of ordinary paper; it will become soft and flaccid when steeped in water, to which, however, it is impervious; and it is unaffected by boiling in water. The formation of vegetable parchment is due to a molecular change in cellulose when acted on by sulphuric acid, owing to which the substance is transformed into a

starch-like body—amyloid—with simultaneous swelling of the fibres, which thereby soften and agglutinate. The preparation of vegetable parchment was patented in 1857 by Mr W. E. Gaine, and machinery has been adapted for the manufacture. The paper to be acted on passes in a continuous web through a vat containing commercial sulphuric acid diluted with half its volume of water. In this it is immersed from five to twenty seconds at a temperature of about 60° Fahr. It then passes in succession through pure water, next an ammoniacal solution to remove all acid, and finally again through water, after which it is dried and finished by passing between felted rollers and over heated polished metal cylinders. A similar effect is produced on paper by treating it with a syrupy solution of zinc chloride at from 120° to 212° Fahr. Vegetable parchment has not realized all the expectations of it. It is most largely used as covers for preserve jars, bottles, &c., and to some extent for tracings of plans, charts, &c.

**PARDON** is the remission, by the power entrusted with the execution of the laws, of the penalty attached to a crime. The right of pardoning is coextensive with the right of punishing. In a perfect legal system, says Beccaria, pardons should be excluded, for the clemency of the prince seems a tacit disapprobation of the laws (*Dei Delitti e delle Pene*, ch. xx.).<sup>1</sup> In practice the prerogative is extremely valuable, when used with discretion, as a means of adjusting the different degrees of moral guilt in crimes or of rectifying a miscarriage of justice. By the law of England pardon is the sole prerogative of the king, and it is declared by 27 Hen. VIII. c. 24 that no other person has power to pardon or remit any treasons or felonies whatsoever. This position follows logically from the theory of English law that all offences are breaches of the king's peace. Indictments still conclude with a statement that the offence was committed "against the peace of our lady the queen, her crown and dignity." The crown by pardon only remits the penalty for an attack upon itself. The prerogative is in modern times exercised by delegation, the crown acting upon the representation of the secretary of state for the home department in Great Britain, of the lord lieutenant in Ireland. The prerogative of the crown is subject to some restrictions. (1) The committing of a

<sup>1</sup> See further, on the ethical aspect of pardon, Montesquieu, *Esprit des Loix*, bk. vi. ch. 21; Bentham, *Principles of Penal Law*, bk. vi. ch. 4.

## P A R I S

**P**ARIS, the capital of France, the seat of the legislature and of the administrative departments, is situated on both banks of the Seine, in  $48^{\circ} 50' 14''$  N. lat. and  $2^{\circ} 20' 14''$  E. long. (Observatory). It occupies the centre of the so-called Paris basin, which is traversed by the Seine from south-east to north-west, open towards the west, and surrounded by a line of Jurassic heights. The granitic substratum is covered by Jurassic, Cretaceous, and Tertiary formations; and at several points building materials—freestone, limestone, or gypsum—have been laid bare by erosion. It is partly, indeed, to the existence of such quarries in its neighbourhood, or on the very ground on which it stands, that the city owes its vast development.<sup>1</sup> The mean elevation of the Seine valley at Paris is from 100 to 130 feet. On the north bank rise the heights of Charonne, of the Buttes-Chaumont (404 feet), of La Villette, and of Montmartre (345 feet); on the left or south bank the Butte-aux-Cailles, and beyond the valley of the Bièvre the hill of Ste Geneviève and Montrouge. Between those lines of heights, the Seine flows from east to west, encircling the island of St Louis, the Île de la Cité, and lower down the Île aux Cygnes. The Bièvre or Gobelins stream flows for some distance in an open channel on the left side of the river, and then *c* appears in a sewer. On the right side the brook which used to run from Mémilmontant to Chaillot past the site now occupied by the opera, has at length been dammed by masonry, driven into the sewers, or lost underground.

*Climate.*—Paris enjoys a fairly uniform climate, subject, however, to frequent changes at all seasons of the year. The mean temperature, calculated by M. Flammarion from observations extending over seventy-two years (1804–76), is  $51^{\circ} 4$  Fahr. The highest reading observed (in July 1874, and again in July 1881) is  $101^{\circ}$  Fahr., the lowest (in December 1879) is  $-14^{\circ}$ . The monthly means for the sixty-four years 1806–1870 are—January  $36^{\circ} 3$ , February  $40^{\circ} 1$ , March  $43^{\circ} 5$ , April  $50^{\circ} 2$ , May  $57^{\circ} 6$ , June  $63^{\circ} 0$ , July  $66^{\circ} 0$ , August  $65^{\circ} 3$ , September  $60^{\circ} 3$ , October  $52^{\circ} 3$ , November  $43^{\circ} 7$ , December  $38^{\circ} 7$ . The river freezes when the temperature falls below  $18^{\circ}$ . It was frozen in nearly its whole extent from Bercy to Auteuil in the winters of 1819–20, 1829–30, 1879–80; and partially in the winters of 1840–41, 1853–54, 1857–58, and 1870–71. Rain falls, on an average, on 143 days, of which 38 are in winter, 35 in spring, 34 in summer, and 36 in autumn,—the average quantity in a year being 19.68 inches. The driest month is February, the rainiest July,—the rainfall for these months being respectively 0.87 inch and 2.15 inches. There are 12 days on which snow falls, 184 on which the sky is covered, 40 with fogs, and 9 with hail. The following figures show the directions of the winds:—N. 38 days, N.E. 41, E. 24, S.E. 26, S. 53, S.W. 70, W. 67, and N.W. 36, with 10 calm days. Thunderstorms average 13 per annum,—ranging from 6 (in 1823) to 25 (1811). There is comparatively little variation in the barometer. Its mean height is 29.763 inches at a height of 216 feet above sea-level. On the whole the climate is healthy and agreeable, its variations, though frequent, being comparatively slight.

*Boundaries.*—Since January 1, 1860, the boundaries of Paris have extended to the fortifications built in accordance

with the scheme of 1840. The total area thus included is 30 square miles, of which 6 square miles are occupied by the public streets, 458 acres by squares and gardens, 642½ acres by the river and canals, and 224 acres by cemeteries. The line of fortifications measures 22½ miles. On the right side of the river it presents 68 fronts, and on the left 26, each consisting of a curtain connecting two demi-bastions. It is pierced by 56 gates, 9 openings for railways, and 2 openings for the Ourcq and the St Denis canals. Outside of this enceinte are a number of detached forts arranged in two main lines. First come the forts erected previous to 1870 at St Denis, Aubervilliers, Romainville, Noisy, Rosny, Nogent, Vincennes, Ivry, Bicêtre, Montrouge, Vanves, Issy, and Mont Valérien; and next the new forts of Palaiseau, Villeras, Buc, and St Cyr, which protect Versailles, and Marly, St Jamme, and Aigremont, which surround St Germain. On the right side of the Seine are Forts Cormeilles, Domont, Montlignon, Montmorency, Écouen, Stains, Vanjourn, Villiers, and Villeneuve St Georgea. Between the two lines the Chatillon fort occupies the site of the German batteries which bombarded Paris in 1871.

*Boulevards, Streets, and Squares.*—The line of the Boulevards from the Madeleine to the Bastille, nearly 3 miles, is one of the busiest and most fashionable in the world; here are the Porte St Denis, the Porte St Martin, most of the large cafés, the Opera-House, and the various theatres distinguished as Le Vaudeville, Les Nouveautés, L'Opéra Comique, Les Variétés, Le Gymnase, La Porte St Martin, La Renaissance, L'Ambigu, Les Folies Dramatiques, Dejazet, Beaumarchais, and Le Cirque. Traffic passes east and west from the Bastille to the Place de la Concorde by Rue St Antoine and Rue de Rivoli. North and south the line of the Boulevard de Strasbourg and the Boulevard de Sébastopol stretches from the station of the Eastern Railway (Gare de l'Est) to the Seine, and is continued by the Boulevard du Palais in the Cité and the Boulevard St Michel, on the left side of the river, as far as the observatory. The total length is not less than 2½ miles. On the right side of the river may also be mentioned the Rue Royale; the Malsherbes and Haussmann boulevards, which cross the most elegant quarters of the town; the Avenue de l'Opéra, which unites the Place du Palais Royal with the Place de l'Opéra, and terminates at the main entrance of the Opera; the Rue de la Paix, Rue Auber, and Rue 4 Septembre, which also terminate in the Place de l'Opéra, and are remarkable for their magnificent shops; Rue Lafayette, one of the longest thoroughfares of Paris, traversing the town from the Opera to the end of La Villette; the Boulevard Magenta, from Montmartre to the Place de la République; Rue de Turbigo, from this place to the Halles Centrales. The older streets known as Richelieu, Vivienne, De la Chaussée d'Antin, St Honoré, Montmartre, St Denis, St Martin, are full of shops and offices. The Place de l'Arc de Triomphe de l'Étoile is the centre of twelve avenues stretching out from it like the spokes of a wheel, but not all as yet lined with buildings. On the left side of the river the main thoroughfare is the Boulevard St Germain, from Pont Sully to the Pont de la Concorde, which passes in front of the school of medicine, the Place St Germain des Prés, and the war office. The Rue de Rennes, which extends from St Germain des Prés to the Mont Parnasse Railway station, is to be prolonged as far as the Seine.

The finest of the public squares in Paris are Place de la

<sup>1</sup> The quarries of Montrouge, the Montmartre and the Buttes-Chaumont plaster-kilns, and the brick-works of Vaugrard or of Passy are gradually being built over. At Passy there is a cold chalybeate spring, and sulphurous waters are found at Belleville and at Les Batignolles.

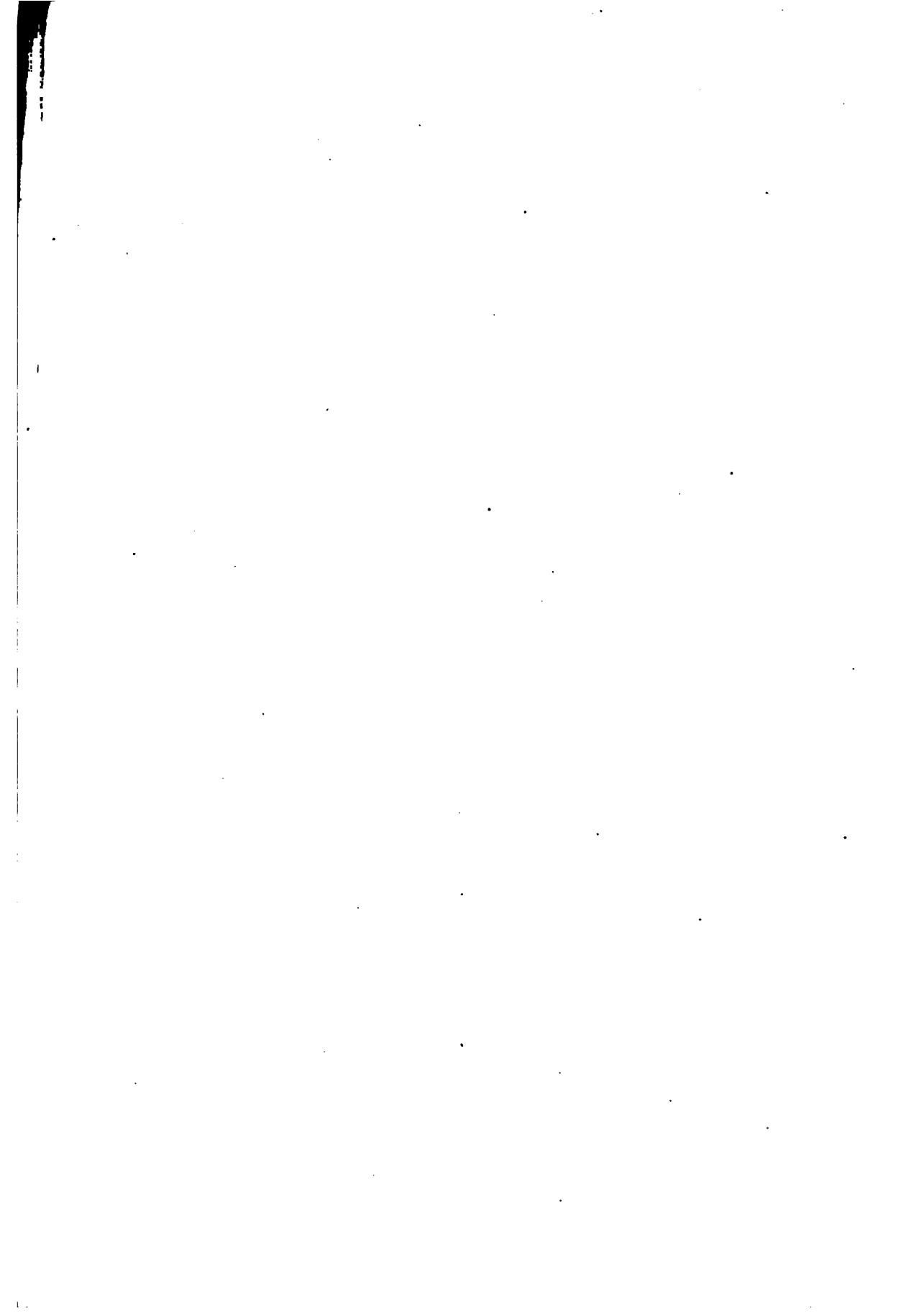









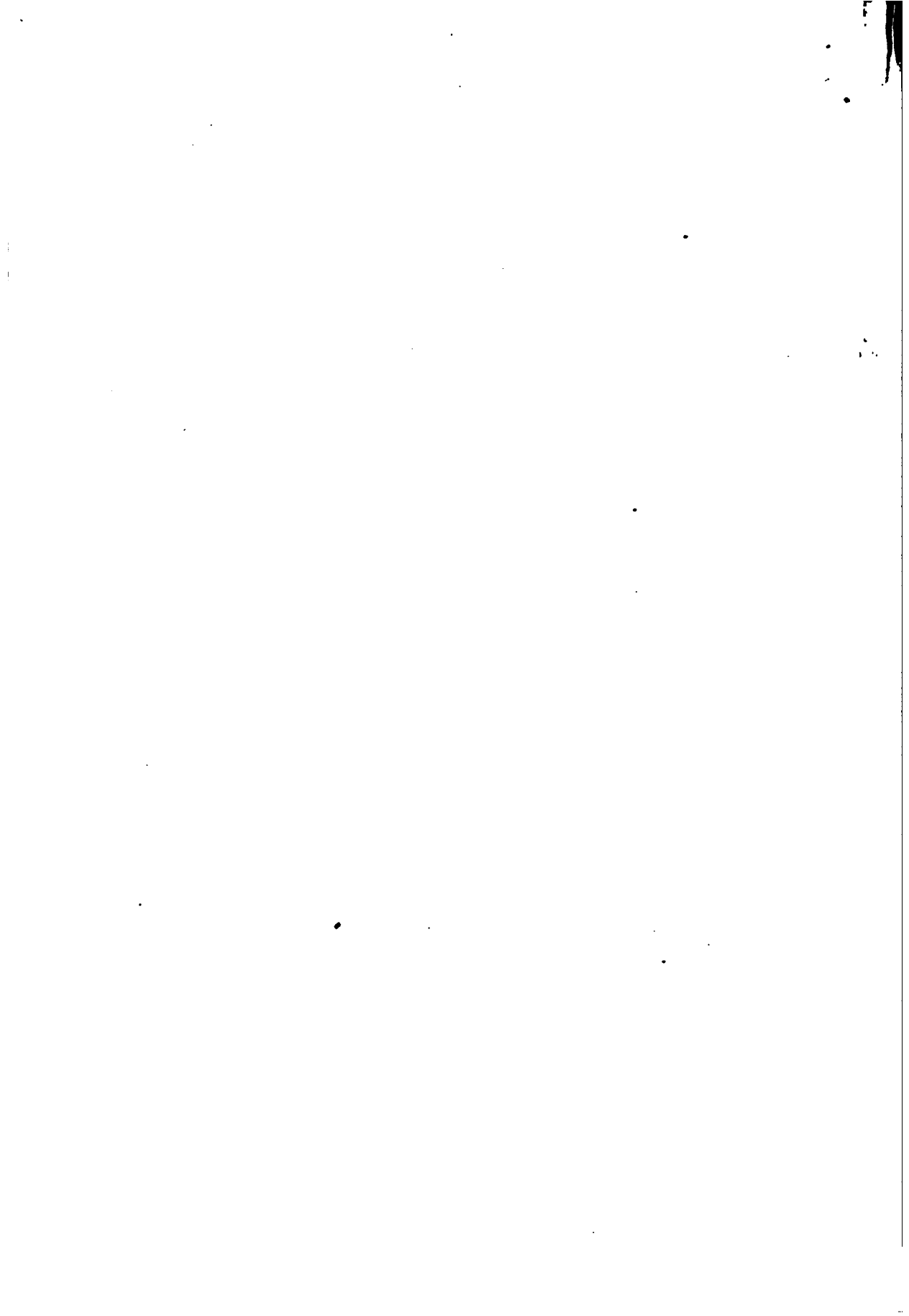



Concorde; Place de l'Étoile; Place Vendôme, with the column and statue of Napoleon I.; Place du Carrousel, with a small triumphal arch commemorative of the campaign of 1806, which formed the entrance to the palace of the Tuileries, now demolished; Place des Victoires, with the equestrian statue of Louis XIV.; Place des Vosges, formerly Place Royale, with that of Louis XIII.; Place de la Bastille, with the column commemorative of the Revolution of July 1830; Place de la République, with the Republic statue; Place de l'Hôtel de Ville; Place du Châtelet, with a column commemorative of the Italian campaign of 1796; those which take their names from the Bourse, the Palais Royal, and the Opera; Place de Rivoli, with the equestrian statue of Joan of Arc; Place Moncey, adorned with a monument in memory of the defence of Paris in 1814, as Place Denfert, at the opposite extremity of the town, is adorned with a colossal lion symbolizing the defence of 1871. South of the Seine are the Place St Michel, adorned with a monumental fountain, and one of the great centres of traffic in Paris; Place du Panthéon; Place St Sulpice; Place Vauban, behind the dome of the Invalides, and Place du Palais Bourbon, in front of the chamber of deputies. Besides those already mentioned there are monumental fountains in the Places de la Concorde, de la République, and du Châtelet, the Avenue de l'Opéra, and the Place Louvois opposite the national library; and attention must also be called to the Fountain of the Innocents near the markets, which was originally adorned with sculptures by Jean Goujon; the Molière Fountain, in the Rue Richelieu; the Gaillon Fountain; and on the left side of the river the Fountain of Rue de Grenelle.

*The Seine.*—The Seine flows for 7 miles (taking five hours) through Paris. As it enters and as it leaves the city it is crossed by a viaduct used by the circular railway and for ordinary traffic; that of Point du Jour has two stories of arches. Two bridges, the Pont des Arts and the Passerelle de Passy, are for foot passengers only; all the others are for carriages as well. The most famous is the Pont Neuf, the two portions of which rest on the extremity of the island called La Cité where the river is at its widest (961 feet). On the embankment below Pont Neuf stands the statue of Henry IV., the people's king. Between La Cité and the left bank the width of the lesser channel is reduced to 161 feet. The whole river has a width of 532 feet as it enters Paris and of 440 as it leaves it. As it descends it passes under the bridges of Tolbiac, Bercy, and Ansterlitz (built of stone), that of Sully (of iron), those of Marie and Louis Philippe between Île St Louis and the right bank; that of Les Tournelles between Île St Louis and the left bank; that of St Louis between Île St Louis and La Cité; and Pont d'Arcole, a very elegant structure connecting La Cité with Place de l'Hôtel de Ville. La Cité besides communicates with the right bank by the bridges of Notre Dame and Au Change; with the left bank by that of the Archevêché, the so-called Pont au Double, the Petit Pont, and Pont St Michel. Below Pont Neuf come the Pont des Arts, Pont du Carrousel (of iron), Pont Royal (a fine stone structure leading to the Tuileries), and those named after Solferino, La Concorde, the Invalides, Alma, Jena, (opposite the Champ de Mars), Passy, and Grenelle.

The houses of Paris nowhere abut directly on the river banks, which in their whole extent from the bridge of Ansterlitz to Passy are protected by broad embankments or "quays." At the foot of these lie several ports for the discharge of goods:—on the right side Bercy for wines, La Rapée for timber, the Port de l' Arsenal at the mouth of the St Martin Canal,<sup>1</sup> the Port de l'Hôtel de Ville for

fruits, and the Port St Nicholas or du Louvre (steamboats for London); on the left bank Port de la Gare for timber, St Bernard for wines, and those named after La Tournelle, the Saints Pères, the Invalides, and Grenelle.

*Promenades and Parks.*—In the heart of Paris are situated the gardens of the Tuileries (74 acres), laid out in parterres and bosquets, planted with chestnut trees, lindens, and plane trees, and adorned with playing fountains and basins, and numerous statues mostly from the antique. From the terrace along the river side a fine view is to be had over the Seine to the park and palace of the Trocadéro; and from the terraces along the Place de la Concorde the eye takes in the Place and the Avenue of the Champs Élysées. The gardens of the Luxembourg, in front of the palace occupied by the senate, are rather larger than those of the Tuileries; with less regularity of form they present greater variety of appearance. In the line of the main entrance extends the beautiful Observatory Walk, terminating in a monumental fountain, which is in great part the work of Carpeaux. The Luxembourg conservatories are rich in rare plants; and classes are held in the gardens for the study of gardening, fruit-tree pruning, and bee-keeping. The Jardin des Plantes will be mentioned below in the list of scientific establishments. Besides these three great gardens laid out in the French taste, with straight walks and regular beds; there are several in what the French designate the English style. The finest and most extensive of these, the Buttes-Chaumont Gardens, in the north-east of the city, occupy 62 acres of very irregular ground, which up to 1866 was occupied by plaster-quarries, lime-kilns, and brick-works. The "buttes" or knolls are now covered with turf, flowers, and shrubbery. Advantage has been taken of the varying relief of the site to form a fine lake and a cascade with picturesque rocks. The Montsouris Park, in the south of the city, 40 acres in extent, also consists of broken ground; in the middle stands the meteorological observatory, built after the model of the Tunisian palace of Bardo, and it also contains a monument in memory of the heroic and unfortunate Flatters expedition. Monceau Park, surrounded by the most aristocratic quarters of modern Paris, is a portion of the old park belonging to King Louis Philippe, and is now the property of the town. The gardens of the Palais Royal are surrounded by arcades and fine shops. There is hardly, it may be further remarked, a district in Paris which has not of recent years its well-planted square kept up at municipal expense on some plot of ground cleared during the improvements. Such are those named after Tour St Jacques (one of the most graceful monuments of old Paris), the Conservatoire des Arts et Métiers, the Temple, Montholon, Cluny, &c. There have recently been added the park of the Champs de Mars, and that of the Trocadéro with its fountains and aquarium.

But the real parks of Paris are the Bois de Boulogne and Bois de Vincennes, which belong to the city, though situated outside of the fortifications. The former is reached by the wide avenue of the Champs Élysées as far as the Arc de Triomphe, and thence by the avenue of the Bois de Boulogne or that of the Grande Armée. The first of these, with its side walks for foot passengers and equestrians, grass-plots, flower-beds, and elegant buildings with gardens and railings in front, affords a wide and magnificent prospect over the Bois and the hills of St Cloud and Mont Valérien. The Bois de Boulogne covers an area of 2158 acres, one-fourth of which is occupied by turf, one-eighth by roads, and the rest by clumps of trees, sheets of water, or running streams. Here are the two race-courses of Longchamps (flat races) and Auteuil (steeple-chases), and the gardens

risers by sluices to the La Villette basin, from which the St Denis Canal descends to the Seine at St Denis. In this way boats going up or down the river can avoid passing through Paris.

<sup>1</sup> This canal, leaving the Seine below Ansterlitz Bridge, passes by a tunnel under Place de la Bastille and Boulevard Richard Lenoir, and

of the Acclimatization Society, which, with their menageries, conservatories, and aquarium, are largely visited by pleasure-seekers. The Bois de Vincennes, a little larger than the Bois de Boulogne, is similarly adorned with streams, lakes, cascades; and from the Gravelle plateau there is a splendid view over the valleys of the Marne and the Seine. Unfortunately the wood is cut in two by an open space comprising a drill-ground for artillery and infantry, a race-course, and a farm (*La Faisanderie*) for agricultural experiments. Trees for the public parks and squares are grown in the great municipal nurseries at Auteuil and Bois de Boulogne; and the municipal botanical gardens of *La Muette*, with thirty-five conservatories covering  $1\frac{1}{2}$  acres, and an equal area under frames, contain magnificent collections of azaleas, palm-trees, and other exotics for ornamenting the public gardens or decorating official apartments on fête days.

*Public Buildings, Palaces, &c.*—The following are among the public buildings of Paris which have most architectural interest. The palace of the Louvre (see pp. 281, 288), which lies on the right side of the Seine in the heart of the city, consists of a quadrangle with an inner court 394 feet square, two galleries extending westwards from two sides of the quadrangle, and two galleries external and parallel to these, and continued till they meet the side wings of the Tuileries. The east front of the Louvre is 548 feet long and 90 feet high, and the first story is occupied by Perrault's famous colonnade. Towards the west are those portions of the Tuileries which escaped the fire of 1871, —the connecting galleries and (on the south) the Flora pavilion and (on the north) the Marsan pavilion, which was entirely rebuilt between 1872 and 1877. From Perrault's colonnade to the Flora pavilion the side facing the quay is 2250 feet long. In the matter of sculpture the south and west sides of the inner court are considered the best parts of the Louvre. On the west side lies the oldest part of the palace, and the principal points in the former arrangement of the building are indicated by the paving of the court. In the middle of each façade there is a pavilion rising above an archway. The western archway, which is surmounted by the clock, leads into Place Napoléon III., which has its centre occupied by a square, and its north and south sides bordered with porticos surmounted by statues of eminent Frenchmen. To the west is the Place du Carrousel. On the south side at the junction of the Louvre and the Tuileries is a gateway with three arches, of which the middle one is crowned with the bronze group by Mercier, "The Genius of the Arts," erected in 1875. The river-front of the Louvre is in an older and more elegant style than the side facing Rue de Rivoli. It is connected with the buildings of the quadrangle by Henry IV.'s pavilion, which contains in its first story the elegant Apollo gallery.

The Palais de Justice in La Cité presents on the W. side, towards Place Dauphine, a Greek façade by Duc (1865–1870), one of the finest productions of modern art. From the Boulevard du Palais on the east it is separated by a magnificent 18th-century railing in wrought iron and gilt. On this side lie the Salle des Pas Perdus and the Sainte-Chapelle. The fine square tower known as the Clock Tower stands at the corner formed by the Quai du Nord and the Boulevard du Palais; and on the north side lies the Conciergerie prison with the dungeon once occupied by Marie Antoinette. Opposite the Palais de Justice on the other side of the Boulevard is the Tribunal de Commerce with a remarkable staircase under the cupola.

On the left bank of the Seine are the Luxembourg palace, the seat of the senate and formerly the residence of Mary de' Medici; the Bourbon palace, the seat of the chamber of deputies, fronting the river and Pont de la Concorde with a fine columned portico and pediment: the

palace of the Legion of Honour, an exquisite building of Louis XIV.'s time; and the palace of the Institute, with a handsome dome. On the right side of the river lie the Élysée palace (in the Champs-Élysées), a vast building in a modern style, the residence of the president of the republic, and the palace of the Trocadéro, built for the Exhibition of 1878, the central rotunda of which contains the largest music-hall in Paris (for 15,000 auditors) and a colossal organ.

Among the Government and administrative buildings may be mentioned the Hôtel de Ville, burnt in 1871, but rebuilt finer than before on the old site; the ministry of foreign affairs, where the congress of Paris was held in 1856; the ministry of marine, which occupies on Place de la Concorde one of the two pavilions erected by Gabriel on each side of Rue Royale; the ministry of war in the Boulevard St Germain; the Bank, formerly the *De la Vrillière* "hôtel," built by Mansard; the Mint, with a fine façade stretching 394 feet along Quai Conti not far from Pont Neuf; the national printing establishment, formerly Cardinal Rohan's mansion; and the national record office, close at hand, formerly the *Soubise* mansion. These last two buildings are in the Quartier du Marais, where a great many ancient mansions are now used as warehouses and workshops. Besides the Hôtel Carnavalet and the Hôtel de Cluny may be mentioned the tower of Rue aux Ours, the last remnant of the Hôtel de Bourgogne; the Hôtel de Sens, formerly the residence of the archbishop of the province; the Hôtel Lambert at the head of Île St Louis, adorned with paintings by Leueur; the turret of the Hôtel Barbette (Rue vieille du Temple).

The largest and finest of the religious buildings of Paris is the cathedral of Notre Dame (426 feet long by 164 wide), restored between 1846 and 1879 by Viollet-le-Duc. As it now exists this church has five naves running the whole length of the building, and square chapels; the central *fleche*, recently restored, is 312 feet high, and two massive square towers worthily crown the principal façade, which is one of the most beautiful that has come down to us from the Middle Ages. The transept has also two façades, which, while less imposing, are more richly decorated with chiselled work, dating from about the middle of the 13th century. Of the elaborate decoration of the interior all that is old is a part of the screen of the choir, from the 14th century.

St Geneviève or the Panthéon, consecrated by the Convention to illustrious men, but since restored to Christian worship, has the form of a Greek cross with a dome in the centre and a columned portico in front, the pediment of which contains an immense bas-relief by David of Angers representing great men crowned by their country. Fénelon, Rousseau, Voltaire, Mirabeau, Laplace, Cuvier, &c., may be distinguished. The crypt contains the tombs of Soufflot (the architect of the church), Rousseau, Voltaire, &c. Near St Geneviève stand St Étienne du Mont with a magnificent roodloft, and the chapel of St Geneviève with the tomb of this patroness of Paris. The Madeleine, intended by Napoleon I. for a temple of victory, has consequently the form of a Greek temple. At St Germain des Prés, St Severin, and St Vincent de Paul are beautiful frescos by Hippolyte Flandrin, to whom a monument has been erected in St Germain. St Eustache contains Colbert's tomb; St Germain l'Auxerrois has a curious porch; and St Sulpice, which is nearly as large as Notre Dame, presents in its main front the most vigorous effort yet made to apply classical architecture in the building of Christian churches. Notre Dame des Victoires is a great resort of pilgrims. The church of the Vow of the Sacred Heart, at present in course of erection on Montmarte, will when finished be one of the most remarkable buildings in Paris from its commanding site, the extent of its crypt, and the vast propor-

tions of its dome and tower, respectively 197 and 262 feet in height.

**Theatres.**—Of the many buildings in Paris devoted to theatrical entertainments there is only one, at once the largest and the most beautiful, which is of real architectural importance—the Grand Opéra, or national academy of music and dancing. The opera house, which covers 2½ acres, is the finest theatre in the world. The process of erection, directed by Charles Garnier, lasted from 1861 to 1875, required 673,295 days' work, and cost £1,440,000. The front is decorated on the ground story by allegorical groups (music by Guillaume; lyrical poetry by Jouffroy; lyrical drama by Perraud; and dancing by Carpeaux) and allegorical statues. In the first story a row of coupled Corinthian columns (each consisting of a single block) forms an open gallery, above which are seven busts of famous musicians, Mozart, Beethoven, &c. Above the architrave of the front appears the dome which covers the auditorium, and behind that rises the vast pediment above the stage decorated at the corners with enormous groups. On the summit of the pediment an Apollo, raising aloft his lyre, is seen against the sky and forms the culminating point of the whole edifice. The sides are not so richly decorated as the front, but each has in the centre an elegant cylindrical pavilion with a carriage entrance. Behind are the buildings occupied by the managers and staff. The interior is decorated throughout in the most gorgeous manner with massive gilding, flamboyant scroll-work, statues, paintings, &c. The grand vestibule with statues of Lully, Rameau, Gluck, and Handel, the grand staircase (an indubitable masterpiece), the *avant-foyer* or corridor leading to the *foyer*, and the *foyer* or crush-room itself are especially worthy of mention. This last, which is 197 feet long, 43 broad, and 59 high, has its ceiling brilliantly painted by Baudry, whose work, however, can hardly be appreciated properly from the excess of light. The auditorium is seated for 2156; its ceiling is painted by Lenepveu. Behind the stage is the *foyer de la danse* or green-room for the ballet, adorned with large allegorical panels and portraits of the most eminent danseuses.

The comic opera has a theatre to itself, L'Opéra Comique; and operettas are played at La Renaissance, Les Bouffes, Les Folies Dramatiques, and Dejazet. The Théâtre Français and the Odéon represent the works of the classical dramatists, as well as modern pieces tragic or comic. Comedy and vaudevilles are played at the Gymnase and the Vaudeville; and the Palais Royal, the Variétés, and the Nouveautés devote themselves especially to farce. Pieces of the popular class, fairy scenes and spectacular displays, are the main attraction of the Châtelet, the Gaiété, the Porte St Martin, and the Ambigu. The Château d'Eau now gives popular operatic performances. Equestrian entertainments are supplied by the hippodrome and three circuses. The café concerts—which during the summer season abound in the Champs Élysées—remove in winter to the Boulevard de Strasbourg and the Montmartre and Poissonnière faubourgs, where there are also some permanent establishments of the kind. Several companies give concerts of classical music on stated days in the winter season; the finest are those of the Conservatoire and the Château d'Eau. Châtelet, and Cirque theatres.

**Arrondissements.**—The city is divided into twenty arrondissements. Only the first twelve belonged to Paris previous to 1860; the others correspond to the old suburban communes then annexed. The first four arrondissements occupy the space on the right of the river, extending from the Place de la Concorde to the Bastille, and from the Seine to the line of the Grands Boulevards; the 5th, 6th, and 7th arrondissements lie opposite them on the left side; the 8th, 9th, 10th, 11th, and 12th surround the first four arrondissements on the north; the 13th, 14th, and 15th are formed out of the old suburban communes of the left side; and the 16th, 17th, 18th,

19th, and 20th out of the old suburban communes of the right side.

**Population and Vital Statistics.**—The growth of the population during the last six hundred years is shown in the following table (L.) :—

Years.	Population.	Years.	Population.
1292	216,861	1841	935,261
1553	260,000	1846	1,058,897
1718	509,000	1851	1,053,262 <sup>1</sup>
1755	576,000	1856	1,174,846
1784	660,000	1861	1,696,741 <sup>2</sup>
1800	547,756 <sup>1</sup>	1866	1,825,274
1817	713,966	1872	1,851,792
1831	785,862	1876	1,988,806
1836	868,438	1881	2,269,023

\* The figures for December 1881, like the rest of those in the table, represent the number of people legally domiciled at Paris at the date given, but the number actually present in the city at last census was only 2,239,928 (1,113,326 males and 1,126,602 females).

The following table (II.) shows the distribution of the population in the several arrondissements :—

Number and Name of Arrondissement.	Area in Acres.	Inhabitants.	Houses.	Births (1881).	Deaths (1881).	No. of Inhabitants per Acre.
1. Louvre.....	470	78,890	2,184	1,606	1,428	160
2. Bourse.....	241	76,886	2,278	1,573	1,432	317
3. Temple.....	237	84,254	2,380	2,000	2,000	358
4. Hôtel de Ville.....	387	103,700	2,404	2,734	2,473	268
5. Pantheon.....	615	114,444	2,308	2,083	2,780	186
6. Luxembourg.....	521	97,735	2,746	2,183	1,969	108
7. Palais Bourbon.....	996	83,827	2,441	1,796	1,984	94
8. Élysée.....	941	89,004	3,393	1,478	1,373	95
9. Opéra.....	526	122,698	3,460	2,697	1,987	234
10. St Laurent.....	706	180,800	3,772	3,573	3,546	256
11. Popincourt.....	692	206,246	4,830	6,479	6,254	235
12. Reaumur.....	1,303	102,455	4,181	2,984	2,864	79
13. Gobelins.....	1,544	91,315	3,933	2,983	3,154	59
14. Observatoire.....	1,147	91,713	4,373	3,071	2,783	80
15. Vaugirard.....	1,782	100,679	5,229	3,915	2,961	57
16. Passy.....	1,753	60,703	4,406	1,265	1,266	35
17. Bagneux.....	1,100	143,187	3,266	3,587	3,214	130
18. Montmartre.....	1,283	176,586	6,166	6,426	4,964	139
19. Butte-Chaumont.....	1,296	117,865	4,083	3,523	3,490	84
20. Ménilmontant.....	1,267	126,917	5,522	4,007	3,376	99
	19,177	2,239,928	77,014	59,874	57,066	117

The number of births and of deaths in Paris during the five years 1876–80—273,785 births and 252,500 deaths—apparently shows nothing exceptional as compared with the rest of France. It is to be observed, however, that the population is composed to a larger extent than usual of adults, young children being sent to the country, and old men withdrawing. The number of marriages, 20,993 for 1881, with an average of 18,427 for the five previous years, is rather small for the proportion of marriageable persons. Of the 1,113,326 males in 1881, 621,569 were unmarried, 440,022 married, and 51,735 widowers; of the 1,126,602 females, 557,054 were unmarried, 446,297 married, and 123,251 widows. The subjoined table (III.) shows the proportion of individuals of the various ages specified, in each 10,000 of the inhabitants, according to the census of 1881. It will be seen that the proportion was greater in Paris from 20 to 55, and smaller below and above those ages.

Age.	Number of Persons		Age.	Number of Persons	
	In Paris.	In France.		In Paris.	In France.
0 to 5	711	978	50 to 55	554	546
5 ,, 10	642	867	55 ,, 60	391	483
10 ,, 15	671	869	60 ,, 65	297	415
15 ,, 20	849	868	65 ,, 70	186	317
20 ,, 25	1,118	874	70 ,, 75	119	222
25 ,, 30	1,010	709	75 ,, 80	67	140
30 ,, 35	966	707	80 ,, 85	22	62
35 ,, 40	901	682	85 ,, 90	9	18
40 ,, 45	800	641	90 ,, 95	2	7
45 ,, 50	675	604	95 ,, 100	0	2

The following table shows the occupations of the population in 1881 :—

<sup>1</sup> The decrease between 1784 and 1800 was due to the Reign of Terror, and that between 1846 and 1851 to the Revolution of 1848.

<sup>2</sup> The increase in 1861 is largely due to the incorporation of the suburban districts.

TABLE IV.—*Distribution of Population according to Occupation, 1881.*

	Employers.		Agents or Clerks.		Workpeople.		Members of Family living with the Preceding.		Domestic attached to the Person.		Total.
	Males.	Females.	Males.	Females.	Males.	Females.	Males.	Females.	Males.	Females.	
<i>Agriculture.</i>											
Landowners farming their lands.	598	96	60	16	639	222	659	1,151	248	454	4,143
Farmers, cultivators, "métayers"	220	28	24	10	264	85	180	302	69	50	1,232
Small proprietors working for others.	142	49	12	9	455	78	240	324	24	47	1,380
Foresters.	876	210	97	23	489	222	597	707	75	127	2,923
Total.....											9,678
<i>Industry.</i>											
Engaged in mines, quarries, and metal-working establishments	1,238	121	1,814	170	12,728	1,085	5,138	9,940	267	863	32,854
Engaged in other manufacturing establishments	2,729	357	5,808	1,086	46,478	31,743	17,984	27,835	1,474	3,769	139,863
In petty industries	40,143	20,521	29,700	19,919	258,506	239,334	108,668	185,844	8,123	18,813	929,596
Total.....											1,102,313
<i>Trade.</i>											
Bankers, agents, wholesale traders	14,128	1,539	43,092	7,288	6,970	8,917	17,781	40,033	3,794	14,844	85,765
Retail traders, shopkeepers	40,525	15,349	47,972	25,306	23,128	17,851	29,520	61,605	5,687	16,082	146,835
Keepers of hotels, taverns, coffee-houses, and lodging-houses.	21,178	7,146	11,118	4,568	6,467	3,006	16,033	27,975	6,518	11,255	61,314
Total.....											293,914
<i>Transport and Shipping.</i>											
Engaged on railways or as carriers	1,401	74	10,787	514	10,539	858	7,202	16,301	281	923	48,830
Connected with mercantile marine, pilotage, fisheries, &c.	261	6	118	8	115	13	147	326	32	49	1,075
Total.....											49,905
<i>Army, Navy, and Police.</i>											
Army	10,988	...	182	10	789	6	391	1,106	203	407	14,082
Navy	198	...	8	3	1	...	50	138	78	100	576
Gendarmerie and police	3,105	...	995	14	614	71	2,782	6,443	98	267	19,389
Total.....											34,047
<i>Liberal Professions.</i>											
Civil service	6,945	553	16,509	1,947	3,149	1,170	8,746	19,789	1,856	5,856	66,720
Clergy	1,308	...	166	72	32	2	159	636	193	651	3,219
Religious communities	1,107	3,432	273	309	36	120	6	172	147	336	5,938
Justice, administration of	3,638	...	2,114	23	11	5	2,198	4,682	1,171	3,057	16,899
Medicine	3,913	1,429	994	412	335	176	2,112	4,288	1,369	3,276	19,304
Education	4,398	4,082	1,573	1,407	109	101	2,184	4,466	1,060	2,441	21,821
Art	11,374	4,527	2,984	538	1,921	521	4,912	10,192	1,321	4,406	42,646
Science	3,591	281	208	28	37	7	1,224	3,109	624	2,075	11,184
Total.....											186,731
<i>Living on Realized Means.</i>											
Proprietors, "rentiers"	39,244	44,337	6,923	7,891	1,026	1,577	18,171	41,453	13,674	36,559	210,860
Pensioners, &c.	7,083	1,333	448	54	93	129	2,435	4,968	1,124	2,315	20,050
Total.....											230,910
<i>Without Occupation.</i> —Children supported outside of their own commune by their parents; inmates of hospitals, prisons, &c.											61,699
<i>Occupation unknown</i> .....											12,967
Grand Total.....											2,239,918

Barely a third (322 per 1000) of the population are Parisians by birth,—382 per 1000 having been born in the other communes of the department of Seine, 566 in the other departments of France or in French colonies, and 74·8 abroad. The foreign population shows a tendency to increase; in 1876 880 per 1000 were natives of the department, the proportion of foreigners being only 60. In 1881 the English numbered 10,789; Germans, 81,190; Belgians, 45,281; Dutch, 9250; Italians, 21,577; Swiss, 20,510; Americans, 5987; and other nationalities, 19,154.

The following were the principal causes of death in 1882:—phthisis, 10,342 deaths; diarrhoea, 5095; pneumonia, 4127; congestion of the brain, 2668; organic diseases of the heart, 2873; meningitis, 2605; chronic bronchitis, 2630; cancer, 2251; typhoid fever, 3352; acute bronchitis, 1730; croup and diphtheria, 1805; small-pox, 661; infantile weakness, 1458; senile debility, 1350.

*Municipal Administration.*—Each arrondissement is divided into four quarters, each of which nominates a member of the municipal council. The functionaries of the arrondissement are—a mayor (*maire*) and three deputies (*adjoints*) nominated by the prefect of Seine, who act as registrars, and preside over the poor-relief (*bureaux de bienfaisance*) of their arrondissement, and a justice of the peace

(*juge de paix*) nominated by the Government. There is no elective mayor of Paris: the president of the municipal council, who is nominated by his colleagues, merely acts as chairman of their meetings. When occasion requires, the function of mayor of Paris is discharged by the prefect of Seine. The municipal council discusses and votes the budget of the city. The importance of the business thus transacted will be seen below. The prefect of Seine and the prefect of police (both magistrates named by the Government, but each with a quite distinct sphere of action) represent the executive authority as opposed to the municipal council, which latter has no power by refusing a vote of credit to stop any public service the maintenance of which legally devolves on the city: in case of such refusal the minister of the interior may officially insert the credit in the budget. And in like manner he may appeal to the head of the state to cancel any decision in which the council has exceeded its legal functions. The prefecture of Seine comprises a departmental service, differing in no essential particular from that of other prefectures, and a municipal service for the city of much more importance. Elections, rates, municipal debt, city schools, public lands, municipal buildings, markets and market-places (in respect to the collection of dues), cemeteries, roads and streets, public edifices,

water-works and sewers, promenades and plantations, river navigation and river ports, public pawnbroking establishments, and the relief of the poor are all under the control of the prefecture of Seine.

The prefecture of police includes the whole department of Seine and the neighbouring communes of the department of Seine-et-Oise—Mondou, St Cloud, Sèvres, and Enghien. It consists of three sections—political police, police of public safety, and administrative police, the two former being rather national than municipal. The state consequently repays two-fifths of the annual budget of about £800,000 which this prefecture receives from the city.

The municipal police deals with public health; civil order, and repression of crimes and misdemeanours, whether against person, property, or morals. It exercises surveillance over lodging houses, the insane, and prostitutes, tests weights and measures, and has charge of the markets, the public vehicles, the fire department, sanitary arrangements, and exhumations and reinterments in the cemeteries.

The prefect of police has a staff of 8500 officials—*commissaires de police, officiers de paix, gardiens de la paix* (a kind of police-magistrate), and inspectors. He has also under his orders the *sauteurs pompiers* or fire-brigade (1742 men), and the republican guard, long called the municipal guard, which numbers 3295 men, besides a mounted force of 726. He has full control over the budget of his department, which is voted on *l'oc* by the municipal council.

*Revenue and Expenditure.*—The heaviest item of expenditure is the public debt: the sum at 31st December 1883, represented by the series of annuities terminable in 1950, amounts to a total of £171,730,965. The annuity for 1883 was £2,693,303. Over and above this the city is authorized to have a floating debt of £300,000. The following are in round numbers the main items of the ordinary budget for 1883,—the exact sum varying from year to year:—

Prefecture of police (partly repaid by the state).....	£250,000
Streets and roads ("voies publiques" and "voies").....	999,000
Primary and professional education.....	890,000
Poor relief.....	795,000
Water-works and drainages.....	520,000
Public walks, plantations, and lighting.....	392,000
Octroi or customs (the main source of municipal revenue).....	296,000
Central administration, "mairies," and municipal council.....	237,000
Architecture and fine arts.....	213,000

By the addition of the expenses of the Collège Rollin (an institution for secondary education belonging to the city), and some miscellaneous expenses of less amount, the ordinary budget for 1883 reached the sum of £10,106,533, and by the further addition of £44,000 belonging to the previous year, a grand total of £10,150,533.

The extraordinary budget shows expenses to the amount of £298,444 on general funds, and £90,000 on special funds. The former is specially devoted to architectural works (rebuilding the Hôtel de Ville) and keeping up streets and roadways, and the latter to the erection of buildings (Sorbonne, faculty of law, and canal St Denis).

The following are the principal items of ordinary revenue:—

Octroi (municipal customs).....	£5,996,802
Communal <i>concessions</i> added to the direct contributions.....	948,805
Municipal share in the profits of the gas company.....	604,000
Water-rates and incomes from the canals belonging to the city.....	442,387
Government subsidy to the municipal police.....	307,783
Fines, shooting licences.....	220,110
Revenue for public instruction (legacies, &c.).....	Unknown
Duty on gas supplied to private persons (0·02 fr. per cub. met., about 5½d. per 1000 cub. feet).....	225,250
Cab-stands, omnibuses, and tramways.....	194,937
Government subsidy for the maintenance of the public roads and streets.....	164,000
Dues from goods exposed for sale in the public markets.....	180,012
Slaughter-houses.....	138,136
Householders' street-cleaning tax ( <i>taxe de balayage</i> ).....	108,416
Warehouses.....	101,492
Sale of burial-lots in the cemeteries.....	94,284
Stands in the markets and market-places.....	83,461
Paving and cleaning of the streets.....	95,717
Ground-rents.....	62,594
Night-soil and sewage.....	56,597
Rent of stands on the public streets.....	51,732

Including less important items, the total ordinary revenue in 1883 was £10,489,378; and the arrears of former years' revenue paid up amounted to £1,218,883.

The extraordinary budget on general and special funds amounts to £6,450,037; but a large proportion of this consists of sums which are carried forward from one fiscal year to another, till the expenses which they are meant to cover are liquidated.

The chief items in the octroi are—

Beverages.....	£2,566,118
Etatables.....	1,232,363
Liquida, other than beverages.....	608,283
Fuel.....	463,278
Building materials.....	525,698
Wood for industrial purposes.....	246,693
Fodder.....	204,102

Total (1883), comprising other less important items,.....£5,986,841

*Streets.*—The public streets, covering an area of 3877 acres, make a total length of 580 miles, 143 miles being bordered with trees. The municipality is going on with the work of planting as rapidly as possible, though each new tree costs about 2s.

The staff entrusted with maintaining and cleaning the public streets comprises 320 engineers, overseers, and timekeepers, who have under their orders 3123 paviers and roadmen and 3186 permanent and supernumerary scavengers. The maintenance of the streets costs £406,800; that of the pavements and sidewalks, £62,224; cleaning, £259,480. The streets are for the most part paved (1525 acres on January 1, 1883), usually with Yvette sandstone from the neighbourhood of Paris. The most frequented crossings are laid with Belgian porphyry. The metalled roadways cover 445 acres, the asphalted 33 acres, the earthen 26. Wooden paving, previously employed only for 1 acre, was in 1833 laid down in the *Champs Elysees*, and in 1884 extended to the *Avenue de l'Opéra*, *Rue de Rivoli*, the line of the *Grands Boulevards*, and *Rue Royale*. Of the total area of 1181 acres occupied by pavements and sidewalks, two-ninths are covered with asphalt, one-third with sand, one-seventh with granite, and the rest with paving-stone.

There are 5070 plugs for the watering of the streets, and 400 water-carts. The annual consumption of water for this purpose amounts to 130,174,478 cubic feet (195 days). The sweeping of the streets in the morning devolves on the householders, and is commuted by payment of a tax (see above); during the day the whole cost falls on the municipality.

The point of greatest traffic in Paris is the *Place de la Bastille*; one current passing from *Rue St Antoine* to the *Faubourg St Antoine* and another from the *Grands Boulevards* to the railway stations for Vincennes, Lyons, and Orleans. On an average 42,000 carriages and 55,900 draught horses pass through this square in the twenty-four hours. Next in amount of traffic come *Rue de Rivoli*, 33,232 vehicles; *Avenue de l'Opéra*, 29,460; *Rue du Pont Neuf*, 20,668; *Boulevard des Italiens*, 20,124; *Place de l'Étoile*, 18,311; *Rue Royale*, 14,095. The most frequented of the bridges are *Pont de la Concorde*, 10,008; *Pont Neuf*, 8519; and *Pont d'Austerlitz*, 7340.

*Means of Conveyance.*—Cabs, omnibuses, tramways, steamboats, and a railway (the *Chemin de Fer de Ceinture*) are the local means of transit in Paris. The steamboats ply up the river to Charenton, down the river to Surames. Within the city, in 1882, they plied on 329 days, made an aggregate of 8163 days of service, traversed 479,997 miles, and conveyed 11 170,980 passengers. Outside the limits of the city, up the river, the days were also 329—aggregate days 2265, aggregate distance 123,007 miles, passengers 3,122,593; down the river the days were 329—aggregate days 2356, miles 180,138, and passengers 1,262,680. The omnibus company employs both ordinary omnibuses and tramway-cars. In 1882 it employed 610 omnibuses and 255 tram-cars, conveying 200,187,455 passengers. The two tramway companies distinguished as Northern and Southern have conveyed respectively 26,076,761 and 27,067,981 passengers. The *Chemin de Fer de Ceinture*, which runs round the city just within the fortifications, conveyed 21,617,909 passengers. As cab-hiring is an open industry (though the cabsmen are restricted in their charges by a tariff, and are subject to police control), the movement of the cabs cannot be given exactly. In 1882 the number of horses belonging to private persons and bound to be at the service of the army in case of mobilization was found to be 95,847; in 1878 the number of carriages was 13,372.

*Water and Drainage.*—Paris derives its water-supply (1) from the Seine and the Marne, (2) from the *Ouroq Canal*, (3) from artesian wells, and (4) from springs. (1) The two steam-pumps at *Chaillot* on the Seine raise each at their ordinary rate 635,683 cubic feet and at their maximum 1,518,588 in the twenty-four hours. The ten pumps at *Port à l'Anglais* and *Maisons-Alfort* above Paris, at *St Ouen* below Paris, and at the *Quai d'Austerlitz* and *Auteuil* (within the city), can supply about 800,372,000 cubic feet per annum. In 1880 about 2,119,000 cubic feet on an average were taken daily from the Seine. The water is stored in reservoirs at the highest points in *Passy*, *Montmartre*, *Charonne*, and *Gentilly*. The establishment at *St Maur*, situated on the canal which crosses the loop of the Marne, and partly moved by the head of water and partly by steam, supplies the *Bois de Vincennes* and the elevated districts of *Belleville* and *Ménilmontant*. It can furnish 2,896,000 cubic feet in the twenty-four hours. (2) The *Ouroq Canal*, which is

also used as a water-way, comes from the department of Aisne, and terminates at the La Villette basin, which also receives the St Denis and St Martin Canals. It brings a volume of 4,414,500 cubic feet per day, to which are added in summer from 2,000,000 to 3,500,000 cubic feet procured from the Marne near the confluence of the Ourcq, and discharged into the canal. The water is hardly suitable for domestic use owing to the quantity of foreign matter which it contains. (2) The water of the artesian wells is much purer. The Grenelle well is 1797 feet deep, and reaches the greensand; its daily yield is 12,360 cubic feet of water at a temperature of 80° Fahr., which rises to a height of 233 or 239 feet, and can thus be carried to the summit of Mont St Geneviève. The Passy well is 1923 feet deep, and yields an average of 233,000 cubic feet in the twenty-four hours. By the hydrometer Seine water registers 18°, that of the Ourcq 28°, that of the Passy well only 9°. A new well is being sunk (1884) at La Chapelle, and another at Butte-aux-Cailles. (4) Till quite recently all the spring water was brought to Paris by two aqueducts. The Arrouil aqueduct, 8 miles long, on the left of the Seine, furnishes 67,100 cubic feet per day; that of Belleville, on the right side, which up to the beginning of the 17th century fed all the fountains of Paris with the waters of Belleville and the Frés St Gervais, now yields only 6000 cubic feet in the twenty-four hours. This insufficiency of spring water has been supplied by the Dhuis and the Vanne, two streams of La Champagne. The former is diverted near Châteaen Thierry (Aisne) and conveyed by an aqueduct 81 miles long into the Ménilmontant reservoirs (354 feet above the sea, or more than 250 feet above the level of the Seine), which consist of two stories, one above the other, with a united capacity of 4,533,000 cubic feet, and usually containing a store equal to five average days' influx. In the valley of the Vanne (a tributary of the Yonne, which it reaches at Sens), Paris has obtained possession of a great number of springs, which, when the rivers are at their lowest, yield in the twenty-four hours 3,581,600 cubic feet of a perfectly pure water at a steady temperature of 52° Fahr. The aqueduct from the Vanne ends at Montrouge at a height of 262 feet, in reservoirs capable of holding 10,594,800 cubic feet, equal to three average days' influx. Every year new works are constructed to increase the quantity of water distributed. In June 1883 the machines raised for the first time 2,825,000 cubic feet on the plateau of Villajuff. The total quantity of water supplied to Paris will now be 30,180,000 cubic feet in the twenty-four hours. The quantity actually required is not less than 14,127,000 cubic feet, or not quite 44 gallons per head of the population, a proportion exceeded in several other great cities. This water is distributed by 66 monumental fountains, 763 *bornes-fontaines* (i.e., smaller fountains or wells, similar in appearance to a boundary stone or milestone), 5249 common street taps, 58 pumps, 181 plugs for the use of the watering carts, 4175 plugs for attachment of watering hose, 363 fire-plugs, 178 cocks at cab-stands, in the Wallace fountains, and the urinals. There is a certain number of fountains not open to the public where water is retailed to the water-carriers; and a large number of private houses have water laid on to their courts, or in many cases to the several stories. The public baths (161 in number) and the washing establishments (263, with 21,911 stands) receive daily 2,353,000 gallons of water. The water-pipes, varying in diameter from a little more than an inch to upwards of 4 feet, the commonest size being about 8 inches, have a total length of 94,904 miles.

Since about the middle of the present century all houses have been bound to discharge their rain and waste water directly into the sewers; but, though these are annually being extended, there are still streets into which they have not been introduced. On the 31st of December 1881 their total length was nearly 441 miles. The drainage of both sides of the river is collected in a great sewer ending in the Seine at Clichy opposite Asnières; the main sewer of the left side of the river is connected with that of the right side by a siphon which passes under the Seine by a tunnel near the Pont de l'Alma. A departmental sewer, receiving the waters of the devastated districts of Charonne, Ménilmontant, Belleville, and Montmartre, terminates at St Denis. These sewers are much more than great drains; they are used as passages for water-pipes, gas-pipes, telegraph wires, and pneumatic tubes. The two largest classes of them have a height respectively of 14½ feet and 17 feet 6 inches at the keystone, and a width respectively of 18 feet 5 inches and 17 feet at the spring of the arch. The smallest class is only 6 feet high and 3 feet wide. The most usual class, of which there are 171 miles, has a height of 7½ feet and a width of 4½ feet.

The sewage from these mains is partly employed in irrigation in the plain of Gennevilliers on the left bank of the Seine opposite St Denis and Clichy. At the close of 1881 1216 acres were under treatment, though the system was only commenced in 1872 on a tenth of that area; and the drains employed, varying from 1 to 4 feet in diameter, had an extent of 21 miles, and discharged the sewage by 571 outlets. The quantity of sewage discharged daily by the sewers varies from 10,171,000 cubic feet to 13,112,366 cubic feet (1881). The amount absorbed by irrigation varies according to the season. Thus in May 1881 it was 95,907,555 cubic feet, and in

September only 15,719,780 cubic feet. The daily average throughout the year shows 54,935,945 cubic feet, watering 218 acres.

The value of the land (originally sandy) at Gennevilliers has considerably increased since the introduction of this system. The rent of a hectare (2.47 acres), which was 152 francs between 1865 and 1870, reached 300 francs in 1875 and 450 in 1880. The cultivation of the plain gives employment to 1350 hands, and the population of the commune has steadily increased—1897 in 1872, 2389 in 1874, 3192 in 1881. The municipality proposes to extend this system of irrigation, which absorbs only a part of the sewage, to the foot of the St Germain forest, and thus to utilize the masses of foul water which still go to pollute the Seine.

Nightsoil is collected in three different ways—(1) in cesspools of mason-work, which ought to be watertight and to communicate with the open air by a ventilating pipe rising above the tops of the neighbouring houses; (2) in movable buckets, placed in suitably ventilated cellars; (3) in filtering tinettes, which discharge their liquids directly into the sewer. On the 31st December 1883 the number of cesspools was 66,610, of movable buckets 14,953, and of tinettes 17,038. The nightsoil contractors have to be authorised by the prefect of Seine. The cesspools must not be emptied except by night. The quantity removed in 1881 was 89,797,810 cubic feet—35,098,453 cubic feet from the cesspools, 3,682,187 from the movable buckets, and 1,017,170 from the tinettes.

Lighting.—The lighting of Paris is practically in the hands of the gas company, electric lighting being still in the experimental stage (28 burners in the public streets in 1883), and oil being used only in a small and ever-diminishing number of out-of-the-way streets (473 burners in 1881). The gas company manufactured in 1861 2,974,690,553 cubic feet of gas, in 1875 6,213,425,025 cubic feet, and in 1882 9,726,709,281 cubic feet, this last quantity being obtained from 917,867 tons of raw material (10,597 cubic feet per ton). The gas mains belonging to the company make a total length of 1222 miles; those in the public streets feed 43,514 burners, consuming 1,301,236,027 cubic feet for public lighting. The company further supplies 7,168,994,098 cubic feet to 154,998 private customers in the city, and 600,208,654 cubic feet to 53 communes in the outskirts. About 660,593,880 cubic feet, or 6.8 per cent., is lost in transmission. The daily consumption reaches a maximum (86,008,949 cubic feet) in December and a minimum (14,078,112 cubic feet) in July.

Public Instruction.—The so-called *salles d'asile* are infant schools for children from three to six years of age, i.e., from the time when their mothers place them in the *crèches* or day-nurseries (see below) and the time when they may be admitted to the primary schools. The municipality maintains 136 secular *salles d'asile* receiving 15,939 children, and one *salles congréganiste* (i.e., under the management of a religious society) with 279 children. The private establishments comprise 23 secular "salles" with 1243 children, and 38 congreganist "salles" with 4231.

In 1882 the municipality supported 173 primary secular schools (96,369 pupils) for boys, 161 secular schools (46,579 pupils) and 3 congreganist schools (765 pupils) for girls. The private primary schools are 188 secular schools and 70 congreganist for boys, 577 secular schools and 136 congreganist for girls,—number of pupils unknown. At certain hours the primary schools are transformed into classes for adults—116, with 14,238 pupils. The "higher schools" (*coles supérieures*) supply education for industrial or commercial careers. They have 677 pupils between six and thirteen years of age and 2966 above thirteen, who are distributed among the Collège Chaptal and the Turgot, Lavoisier, Colbert, J. B. Say, and Arago schools. The apprentice school (*cole d'apprentissage*) with 223 pupils, the normal schools (for males, 306 pupils; for females, 66 pupils), and the Pape-Carpentier school, which trains matrons for the *salles d'asile*, complete the list of the municipal establishments for primary education. Besides these are private normal schools for Protestant teachers (male and female), a private normal school for girls, normal classes for ladies under the auspices of the Society for Elementary Instruction, and professional schools for both girls and boys. Commercial instruction is given in two schools placed under the patronage of the chamber of commerce, and a special commercial high school established about 1880. In 1881 a fund was established for placing indigent but deserving pupils in free primary boarding-schools, at the expense of the city. Between Oct 1881 and Oct 1882 494 pupils were thus dealt with at a cost of £9367. Municipal libraries, subsidised by the city, have been established in all the arrondissements; in 1882 they lent 401,415 works, the number of books contained in the libraries being 89,355.

Secondary education is provided by the municipal Collège Rollin; in the national lycées (Louis le Grand, Henry IV., St Louis, and Vanves), which have both boarders and day pupils; the Charlemagne and Condorcet lycées, for day pupils only; and the Collège Stanislas, more especially for boarders. It is between these establishments, subjected to the same university programme, and the Versailles lycées that the great competition of the Sorbonne takes place at the close of each school year. The number of their pupils in 1883 (Stanislas



excepted) was 8048. Among the private establishments giving secondary education mention must be made of the Collège Ste Barbe, the Monge, Bossuet, Fénelon, and Massillon schools, the old Jesuit colleges at Vaugirard, Rue de Madrid, and Rue Lhomond, the two lesser seminaries of Notre Dame des Champs and St Nicolas, and numerous institutions preparatory for the examinations and special schools. In 1881 there were 11,808 pupils in the secular and 15,811 in the ecclesiastical establishments, of which 1584 in addition attended a lycée course. For some years there have been at the Sorbonne special classes for young ladies, but the secondary education of girls is only beginning to be organized. Higher education is given in the faculties of science, literature, and Catholic theology, which are together in the Sorbonne, and in the faculties of law and of medicine, each of which is by itself. There is also a faculty of Protestant theology transferred to Paris from Strasburg. These faculties confer the degrees of bachelor, licentiate, and doctor. The Catholic Institute, a private foundation, has faculties of law, literature, and science, but has no right of conferring degrees. The Sorbonne, the seat of the Academy of Paris and of its rector, who is the head of the whole educational system, contains a library of 100,000 volumes belonging to the university, and a well-appointed museum of physical science, and laboratories. The school of law has a library of 30,000 volumes and the school of medicine 60,000 volumes, forming the most complete medical collection in the world. Connected with the school of medicine are the Orfila museum of comparative anatomy, the Dupuytren pathological museum, the practical school of anatomy, and a botanic garden, and the midwifery schools of the Maternity and De la Pitié hospitals; the higher school of pharmacy and the dissecting amphitheatre for hospital students are also affiliated institutions.

Whilst the "faculties" are specially intended to prepare for and confer university degrees (though their lectures are open to the public), the Collège de France is meant to give instruction of the highest order to the general public (men or women); and the various sciences are there represented by thirty-seven chairs. The Ecole des Hautes Etudes supplements the theoretical instruction provided by the public lectures of the higher education by practical training. The upper normal school is for the training of "professors" for secondary classical education and for the faculties. The Ecole des Hautes Etudes Ecclésiastiques prepares ecclesiastical "professors" for the institutions and lesser seminaries which supply secondary education, and are placed in the hands of the clergy. The free school of the political sciences prepares more especially candidates for administrative employments (council of state, &c.). The Ecole des Chartes trains record-keepers in the reading and study of ancient documents. The school of living Oriental languages teaches the principal languages from Russian and Modern Greek to Malay, Chinese, and Japanese. The Polytechnic school (Ecole Polytechnique) trains military and naval engineers for the artillery corps, the corps of engineers, and the navy-yards, and civil engineers for the national corps of the roads and bridges, the mines, and the state manufactories (tobacco, powder, and saltpetre). As for infantry and cavalry officers, they usually come from the special military school of St Cyr, when they do not rise from the ranks. In Paris too are situated—the Ecole Supérieure de Guerre, the practical schools of roads and bridges and of mines, for the training of civil engineers, with libraries and collections of models and classes in some cases open to the public; the Ecole d'Application des Tabacs; the school of military medicine and pharmacy. The central school of the arts and manufactures, though some years ago it became a Government institution, still educates engineers for ordinary industrial careers. The school of the fine arts (Ecole des Beaux Arts), intended for painters, sculptors, and architects, contains valuable collections, which render the palace in which they are exhibited one of the most interesting museums in Paris. The instruction in this institution is at once theoretical and practical. It is open to all Frenchmen from fifteen to thirty years of age, and even in some cases to foreigners. Of the various competitions open to the pupils the most important is for the *pris de Rome*. The successful competitor is rewarded with four years' residence in Italy at Government expense, two years being spent at the Medici palace in Rome. Schools of design for boys and girls serve as preparatory for the school of the fine arts, or train designers for industrial occupations. There is a free school of architecture. Music and elocution are taught at the Conservatoire, which possesses a musical library and a very curious collection of musical instruments. The diocesan seminary of St Sulpice receives clerical pupils from all France to the number of 200; the foreign mission seminary trains missionaries for the far East, and the seminary of St Esprit missionaries for the French colonies. The Lazarists have also a *seminaire* of their own. The Irish, English, and Scotch colleges, as their names suggest, prepare priests for the Roman Catholic dioceses of the United Kingdom.

A district at one time almost exclusively occupied by students and known as the Quartier Latin or Pays Latin was situated on the left side of the river mainly in the arrondissement of Luxembourg; the old houses have, however, been almost entirely

demolished since about 1850. It corresponded on the whole to the pre-Revolutionary quarter of St Benoit or the University, otherwise called the Faubourg St Jacques. The most distinctive portion lay between Rue St Jacques and Boulevard St Michel. Rue de la Harpe opens into Boulevard St Michel; and Rue du Foin, frequently mentioned in mediæval and Renaissance writers, strikes N. E. from Rue St Jacques. The students now live for the most part in the vicinity of Sorbonne and the schools of medicine and law. They frequent the cafés and beer-hops of Boulevard St Michel and its neighbourhood.

The principal libraries in Paris have already been described under LIBRARIES (vol. xiv. pp. 524-6), and an account of the observatory will be found in vol. xvii. p. 712.

The Bureau des Longitudes, which was founded in 1795 for the advancement of astronomy and navigation, and publishes the *Comptes rendus des Séances*, is located at the Institute. The meteorological office and observatory is situated in the Montsouris Park, and in connexion with it is a school of nautical astronomy and practical geodesy. The observatory for physical astronomy is at Meudon.

The Conservatoire des Arts et des Métiers, in the old priory of St Martin des Champs, was founded (1794) as a public repository of machines, models, tools, plans, descriptions, and books in regard to all kinds of arts and trades. Various courses of lectures on the applications of science to commerce and industry have been added from time to time; they are all open to the public without fee, and are addressed rather to workmen and artisans than to the wealthy or learned. The Agronomic Institute has recently been removed to the Conservatoire.

The Jardin des Plantes (1626), about 75 acres in extent, forms one of the most interesting promenades in Paris; its museum of natural history (1793), with its zoological gardens, its hothouses and greenhouses, its nursery and naturalization gardens, its museums of zoology, anatomy, anthropology, botany, mineralogy, and geology, its laboratories, and its courses of lectures by the most distinguished professors in all branches of natural science, make it an institution of universally acknowledged eminence.

*Learned Societies.*—Among the learned societies of Paris the first in importance is the Institut de France, which has already been described (see INSTITUTE OF FRANCE, vol. xiii. p. 160). The committee of learned societies at the ministry of public instruction forms, as it were, the centre of the various societies not maintained by the Government; and the French Association for the Advancement of the Sciences, founded in 1872, is based on the model of the older British society, and like it meets every year in a different town. The other societies may be classified as follows:—1. *Historical or Geographical*—History of France, Antiquaries of France (till 1814 known as Celtic Academy), Historic Studies, Numismatics and Archaeology, Bibliophiles, School of Charters, Ethnography, Geography (1821, and thus the oldest of its class), Asiatic (1822), French Alpine Club (Club Alpin); 2. *Natural and Medical Sciences*—Anthropology, Zoological Acclimatization (which has the direction of the zoological gardens in the Bois de Boulogne), Entomological, Geological, Surgery, Anatomy, Biology, Medical of the Hospitals, Legal Medicine or Medical Jurisprudence, Practical Medicine, Pharmacy, Agriculture, Horticulture; 3. *Industrial and Moral Sciences*—Encouragement of National Industry, Statistics, Elementary Instruction, Franklin (for the foundation of popular libraries); 4. *Positive Sciences and Fine Arts*—Philomathic, Physical, Philotechnic, Athenæum of the Arts, Sciences, and Literature (1792), Concerts of the Conservatoire de Musique (1795).

*Newspapers.*—Paris is very largely supplied with newspapers of all descriptions. See NEWSPAPERS, vol. xvii. pp. 423-8.

*Museums.*—The richest museum in Paris occupies the Louvre, the finest of its palaces. On the ground floor are museums (1) of ancient sculpture, containing such treasures as the Venus of Milo, the Pallas of Velletri (the most beautiful of all statues of Minerva), the colossal group of the Tiber, discovered at Rome in the 14th century, &c.; (2) of mediæval and renaissance sculpture, comprising works by Michelangelo, Jean Goujon, Germain Pilon, John of Bologna, &c., and special rooms devoted to early Christian monuments and to Jewish antiquities (this last a feature peculiar to the Louvre); (3) of modern French sculpture, with works by Puget, Coustou, Coysevox, Chaudet, Houdon, Rude, David of Angers, &c.; (4) of Egyptian sculpture and inscriptions; (5) of Assyrian antiquities; (6) of Greek and Phœnician antiquities; (7) of engraving. On the first floor are (1) the Lacaze museum, a magnificent collection of pictures presented to the state by M. Lacaze in 1869; (2) the splendid musée de peinture; (3) the Campana museum; (4) a museum of Greek antiquities; (5) a museum of Egyptian antiquities; (6) an Oriental museum (Persian pottery, Chinese vases, lacquered work, &c.); (7) the Lenoir museum (snuff-boxes, jewels, miniatures, lacquered wares, bequeathed to the Louvre by M. and Madame Lenoir

<sup>1</sup> As the National Society of Agriculture, in contrast to nearly all the other societies, consists of only a limited number of persons named by the Government, to be a member of this corporation has a distinct value similar (though at a considerable remove) to that of being a member of the Institute.

in 1874); (8) the Duchatal room, bequeathed by the widow of the minister of that name (*La Source*, a masterpiece by Ingres); (9) the Timbal, His de la Salle, and Davilliers collections, consisting respectively of furniture drawing and curiosities, drawings, and pottery, furniture, and tapestry; (10) a mediæval and renaissance museum, comprising French, Italian, or Hispano-Moorish pottery and terra cotta ware, as well as objects in bronze, glass, and ivory—the Sauvagot collection being of note; (11) the museum of drawings and chalks, of which the more valuable are preserved in drawers; (12) a museum of ancient bronzes; (13) the Apollo gallery, adorned by the leading artists who have been employed on the palace, and containing the royal gems and jewels, articles of goldsmith's work, and enamels. The second floor accommodates the naval museum, the ethnographic museum (African, Chinese, Mexican), part of the French school of painting, and rooms for the study of Egyptian papyrus-rolls.

The museum of the Luxembourg, installed in a portion of the palace occupied by the senate, is devoted to works of living painters and sculptors acquired by the state. They remain there for ten years after the death of the respective artists, that the finest may be selected for the Louvre.

The Cluny museum occupies the old mansion of the abbots of that order, built in the 15th century by Jacques d'Amboise. It was founded by M. du Sommerard, whose collections were acquired by the state in 1843. Increased from year to year since that date, it now contains about 10,000 articles—pieces of sculpture in marble and stone, carvings in wood, ivories, enamels, terra cottas, bronzes, furniture, pictures, stained glass, pottery, tapestry, glass ware, locksmith work, and jewellery of mediæval and Renaissance times. In the neighbourhood are the remains of the ancient palace of the emperor Julian; in the midst of the ruins, and in the garden which surrounds them, has been collected a Gallo-Roman museum, to which have been added many fragments of mediæval sculpture or masonry, found in the city or its vicinity. The Carnavalet museum occupies the mansion in which Madame de Sévigné resided; it is a municipal museum, in which are brought together all objects of interest for the history of Paris. The artillery museum, in the Hôtel des Invalides, comprises ancient armour, military weapons, flags, and an ethnographic collection reproducing the principal types of Oceania, America, and the coasts of Africa and Asia. The permanent exhibition of the products of Algeria and the colonies is in the Palais de l'Industrie; and finally the Trocadéro palace contains a museum of comparative sculpture and ethnographic galleries for exhibiting curiosities brought home from distant countries by the principal French official travellers.

**Public Charity—Hospitals, &c.**—The administration of public charity is entrusted to a responsible director, under the authority of the Seine prefect, and assisted by a board of supervision consisting of twenty members. The funds at his disposal are derived (1) from the revenue of certain estates, houses, farms, woods, stocks, shares (£250,880 in 1883); (2) from taxes on seats in the theatres (one-tenth of the price), balls, concerts, the Mont de Piété, and allotments in the cemeteries (£252,117); (3) from subsidies paid by the town, the department, and the state (£976,868); (4) from other sources (£522,398, including £130,787 from voluntary donations). The charges on the administration consist of "outside

relief" to the poor (*secours à domicile*) the "service" of the hospitals, and the support of charity children. In each arrondissement there is a *bureau de bienfaisance*, consisting of the *maire*, his assistants, twelve administrators, and an indefinite number of ladies and gentlemen (known as *commissaires* and *dames de charité*) who give voluntary and gratuitous assistance. The secretary and treasurer is a paid official; and 180 doctors, 110 midwives, and 207 *religieuses*, distributed among fifty-eight houses of relief (*maisons de secours*), are employed in the service of the bureaux, which in 1880 received 104,236 applications for aid presented by 68 "victims." The expenses for that year amounted to £269,848 for food, £18,140 for clothing, £6114 for fuel, £29,861 for medicine and medical advice, £15,082 for other assistance in kind, and £83,848 for assistance in money. The pauper population, enumerated every three years, consisted in 1880 of 123,735 persons (53,591 males, 70,144 females) in 46,815 families, or at the rate of 1 person for every 16·07 inhabitants in the city,—an increase of 8158 families and 10,418 persons since 1877, and 10,102 families and 83,448 persons since 1861. Of the families assisted in 1880, 18,125 obtained temporary relief and 28,600 relief throughout the entire year. This destitute class is very unequally distributed among the several arrondissements. Whilst in the 9th arrondissement there is only 1 pauper in 50 inhabitants, and in the 1st, 8th, and 2d 1 pauper in 46, 46, and 44 inhabitants, in the 18th arrondissement there is 1 in 7, in the 20th 1 in 8, and in the 19th 1 in 9. The paupers are for the most part under sixty years of age, and occupy single rooms, at a rent of from £4 to £8 per annum, generally with a single fireplace and a single bed. There are usually no children under fourteen years of age.

The doctors in 1880 gave 453,086 consultations at the dispensaries, and performed vaccination in 81,549 cases. The midwives attended 5126 women boarding in their houses for their confinement, and gave assistance to 14,178 during pregnancy. Domiciliary visits were paid by the medical staff in 1880 to 30,322 patients and to 48,269 necessitous persons.

The doctors, surgeons, chemists, both resident and non-resident, connected with the hospitals, are all admitted by competitive examination. In 1880 the staff for the hospitals of Paris and the auxiliary hospitals of Forges, Garches, and Roche Guyon (Seine-et-Oise), and Berck (Pas de Calais) consisted of 32 doctors or surgeons at the central office of admission, 118 hospital doctors or surgeons, 8 doctors for the insane, 18 chemists, 201 internes,<sup>1</sup> 470 externes, 875 probationers, and 9 midwives or midwives' assistants. The hospitals are classified as general hospitals—Hôtel Dieu, Pitié, Charité, Saint Antoine, Necker, Cochin, Beaujon, Lariboisière, Tenon, Laennec, Tournelles; special hospitals—St Louis (akia diseases), Midi or South (venereal diseases, men), Lourcine (venereal diseases, women and children), Maternity, Clinical (operations); children's hospitals—Enfants Malades, Trousseau, Bercy-sur-Mer, La Roche-Guon; hospices—Bicêtre (old men), La Salpêtrière (old women), Irvy (incurables); maisons de retraite—Isly, La Rochefoucauld, Ste Périne; fondations—Boulard St Michel, Brézin at Garches (for ironworkers), Devilla, Chardon Lagache, Lenoir-Jousseau; and asylums for the insane—Bicêtre (men), Salpêtrière (women). The following table (V.) gives details regarding these institutions in 1882:—

	No. of Patients, 1st January 1882.	Entered during the Year.	Left during the Year.	Deaths.	Remaining on 31st December.	No. of Patient Days.	Mean Length of Term.	Mortality.*
General hospitals .....	6,097	79,106	67,875	11,339	6,489	2,982,302	29·28	6·94
Special hospitals.....	1,533	21,794	20,974	781	1,571	775,542	25·70	27·85
Children's hospitals.....	1,586	9,454	7,726	1,721	1,543	736,763	62·19	5·47
Maison de Santé.....	210	3,140	2,644	541	165	122,186	25·60	5·88
Temporary service of the hospices...	113	873	603	140	242	61,709	...	...
<b>Grand total for the hospitals....</b>	<b>9,488</b>	<b>114,366</b>	<b>99,323</b>	<b>14,522</b>	<b>10,010</b>	<b>4,623,502</b>	<b>31·24</b>	<b>7·36</b>
Hospices, retraites, and fondations..	8782	6,811	4,979	1,413	9,201	3,561,342	...	7·29
Hospitals for Insane—								
Bicêtre (men).....	652	426	308	105	665	298,016	...	10·18
Salpêtrière (woman).....	711	266	305	64	708	380,525	...	15·14

Several of the hospitals are of recent construction—Hôtel-Dieu, Tenon, Lariboisière. The Hôtel-Dieu was rebuilt in La Cité at an outlay of £1,800,000, or £4000 per bed; the arrangements for practical education are excellent, and secure the institution a world-wide reputation. La Salpêtrière (oldest of all the hospital buildings) is remarkable for its extent, occupying 74 acres, with 45 large blocks lighted by 4632 windows.

The benefits of the hospitals or hospices are generally given gratuitously, but a certain number of patients pay their expenses, and in 1880 the funds of the department were in this way augmented by £89,262. In connexion with these establishments are a bakery, a slaughter-house, a wine cellar, a central drug-store, a purveyor for purchasing provisions in the open market, a central depot for bedding, linen, clothing, furniture, and utensils; and a certain number

of articles are retailed to other departments or private institutions.

Foundlings and orphans are sent to the Hospice des Enfants Assistés, which also receives children whose parents are patients in the hospitals or undergoing imprisonment. In 1882 the hospice received 9620 children; the inmates from the preceding year numbered 274. Of these children 2549 were restored to their parents, 2814 were boarded out in the country, 561 died, and 2594 were

<sup>1</sup> The internes and externes are two grades of medical students—the interne the higher of the two and limited in number. Many doctors of medicine have not passed the *internat*.

\* The mortality is here stated for the mean number present on the 1st of January and admitted during the year.—see Death for 1882, &c., of this mean number. The larger the number in the table the less, of course, is the mortality.

formally enrolled among the *enfants assistés*, or charity children. There are in the hospice 103 resident wet-nurses; infants, however, are not kept in the institution, but are boarded out with nurses in the country, of whom 1707 were engaged under the supervision of 361 matrons. Up to twelve years of age these children are kept at the expense of the department of Seine, and they remain under the guardianship of the poor-board till twenty-one years of age. On December 31, 1882, there were 13,861 children of the first class and 12,135 of the second distributed among 32 agencies and 257 medical circuits situated in Nivernais, Burgundy, Bourbonnais, Normandy, Artois, Flanders, and Brittany.

The Quinze-Vingts still gives shelter to the 300 (fifteen score) blind for whom it was founded by St Louis, and gives outdoor assistance to 1550 besides. The blind asylum for the young (Institution des Jeunes Aveugles) has 250 pupils (one-third girls, two-thirds boys); the course of study lasts for eight years; most of the pupils are burars of the state or the departments; some pay a small fee; suitable trades are taught. The deaf-mute institution is for boys only, and they are generally paid for by the state, the departments, and the communes. During a course of seven years they are taught articulation and lip-reading. The Charenton asylum for the insane receives 300 male and 280 female patients, most of them paying for their board, and classed according to their means. Those of Vincennes (522 beds for male patients) and Le Yveinet (300 beds for female patients) take in convalescents from the hospitals sent by the charity boards or friendly societies which subscribe to the institution. The Hôtel des Invalides is for old and infirm soldiers. The pensioners, who have numbered at times as many as 5000, are now only a few hundred, and their immense edifice accommodates the École Supérieure de Guerre, the artillery museum, the galleries for plans in relief of fortified posts, and numerous storehouses of the war department. Under the dome of the Invalides is the tomb of Napoleon I., and in the church the funeral obsequies of distinguished soldiers are performed. There are four military hospitals in Paris—Val de Grâce (960 beds for all ranks), Gros Caillon (350 beds), Saint Martin (425 beds), and Vincennes (630).

Private beneficence maintains a great variety of institutions in Paris. There are 30 crèches or day-nurseries in the city and 14 in the suburbs (capable of accommodating respectively 1093 and 398 infants), where mothers who have to go out to work may leave their infants under two years; they are under the direction of the sisterhood of St Vincent de Paul. The Society of St Vincent de Paul, which must not be confounded with the sisterhood, is a society of laymen founded in 1833 and divided into as many conferences as there are parishes, for the purpose of visiting the poor and giving them advice and assistance. The Société Philanthropique distributes food rations in its "kitchens" by means of a system of cheap tickets. The Société de Charité Maternelle devotes its attention to women in childbed; the Petites Sœurs des Pauvres have five houses for poor old men, for whom they collect scraps from the restaurants. The Frères St Jean de Dieu take care of children suffering from incurable diseases. A large number of institutions known as *ouvroirs* or workrooms bring up orphan and destitute girls and fit them for various industrial occupations, especially the use of the needle. The night asylums offer shelter to the homeless. The Society for the Protection of the Alsace-Lorrainers, and the charity office of the British embassy, are naturally limited to special nationalities. Friendly societies, supported by ordinary subscriptions, donations from honorary members, and state subsidies, are numerous; they give assistance to their members when they are sick or out of work, and pay their funeral expenses.

An evangelistic mission, commenced in 1872 by the Rev. R. W. M'All in the district of Belleville has met with remarkable success. By 1884 it had between thirty and forty stations in Paris and the suburbs, and had extended its activity to various towns in the provinces, to Corsica, and to Algiers. Its income in 1883-4 was £10,607. Homes for English girls were established in 1872 by Miss Ada Leigh, and the association to which they have since been transferred has been presented with an orphanage by M. Galignani.

The Mont de Piété is a national pawnbroking establishment. Charging 9 per cent. for working expenses, it hands over all its proceeds to the public charity funds. The average number of articles pawned per day is 5205, of which 5 only are of suspicious origin (theft); the average sum lent on each was 23 francs in 1881. When the depositor does not redeem his pledge or purchase a renewal the article is sold. In 1882 there were 1,669,582 new transactions and 864,617 renewals, while 1,401,944 articles were redeemed, and 214,340 sold,—the loans amounting respectively to £1,619,621, £276,671, £1,390,888, and £144,815. If the sale involves a loss this falls on the agent who overestimated the value when the article was deposited; any profit, on the contrary, is divided between the administration and the person concerned.

The Caisse d'Épargne, or savings bank, the natural complement of the Mont de Piété, was founded in Paris in 1818. It began that year with 351 depositors, and deposits to the amount of £2153; in

1882 it had 440,728 depositors, and owed them £3,513,482. The new deposits for the year reached a sum of £1,874,697, and the repayments £1,236,060. The number of new pass-books issued was 63,146, of accounts closed 24,228. Three per cent. interest was paid to the depositors. The maximum deposit is £80.

*Law and Justice.*—Paris is the seat of four courts having jurisdiction over all France:—(1) the Tribunal des Confits, for settling disputes between the judicial and administrative authorities on questions as to their respective jurisdiction; (2) the Council of State, for litigations between private persons and public departments; (3) the Cour des Comptes; and (4) the Cour de Cassation. The first three sit in the Palais Royal, the fourth in the Palais de Justice, which is also the seat of (1) a cour d'appel for seven departments (five civil chambers, one chamber of appeal for the correctional police, one chamber for preliminary proceedings), (2) a cour d'assises (members nominated for a term of three months; two sessions per month), (3) a tribunal of first instance for the department of Seine (seven civil chambers for civil affairs, sequestration of real estate, and sale of personal property; four chambers of correctional police), (4) a police court where each *juge de paix* presides in his turn assisted by a *commissaire de police*. Litigations between the departmental or municipal administrations and private persons are decided by the *conseil de préfecture*.

The prefect of police, charged with the maintenance of public safety, has the prison department under his supervision. There are eight prisons in Paris—Mazas, La Santé, Ste Pelagie, St Lazare (for females), the depot (police station) of the prefecture of police, the Conciergerie or lock-up at the Palais de Justice, the Grande-Roquette (for condemned criminals), and the Petite Roquette reformatory. In 1882 there passed through these prisons 108,231 prisoners (83,022 men, 25,209 women), the daily average being 5529. Out of the total number, 30,990 were kept in solitary confinement, and 2905 (males) worked in company by day and were placed in separate cells at night. The prisons also received 1067 young children who accompanied their mothers, and 732 children lost in the streets. The mendicity-station at Villers-Cotterets (Aisne) has besides a daily roll of 919 prisoners (male and female). In the so-called House of Repression at St Denis are confined those mendicants who cannot be removed to Villers-Cotterets, or those discharged prisoners who have not acquired a sufficiency for their immediate necessities; 3240 persons passed through St Denis in 1882. The same year 46,457 persons were arrested in Paris,—44,955 being taken *flagrante delicto* or arrested as vagabonds; 41,207 were brought before the judges. Of the whole number eight-ninths were males. Against five-ninths no previous charge had been made: 899 were ticket-of-leave men, 3291 were foreigners (959 Belgians, 759 Italians, 376 Swiss, 379 Germans, and 126 English). The most frequent causes of arrest were—vagrabondism and begging, 16,958; theft in its various forms, 8604; rioting, 5619; assaults and acts of violence, 1838; offences against morals, 825; breach of certificate by ticket-of-leave men, 899; murders, assassinations, and assault by night, 330; drunkenness, 812.

The prefect of police has the control of the locating, discharging, or maintaining of the insane in the six public asylums of Ste Anne, La Salpêtrière, Bicêtre, Charenton, Vancluse, and La Ville Evrard,—the last two situated in the department of Seine-et-Oise. The financial and administrative management of these establishments is entrusted to the prefect of Seine. At the last of January 1882 there were in the different asylums 8260 lunatics, and during 1882 3670 were admitted, while 3988 left or died. Private asylums for the insane cannot be opened within his prefecture without the permission of the prefect of police. Children put out to nurse, and women wishing to be engaged as wet-nurses, are also under his supervision. In 1881 18,527 infants were registered by their parents as requiring to be put to nurse in the various departments; on December 31, 1881, 4398 infants under three years of age were out at nurse within the prefecture; 407 died during the year. An institution of a reformatory character commenced operations on January 1, 1881. In 1881 and 1882 it received 1644 children—1131 brought by their parents, 262 by the magistrates, and 251 by the prefect of police. On December 1882 there remained 1380 children boarded out in the country. The expense for the two years was £18,160.

Establishments which are dangerous or unhealthy are of three classes, according as they have to be kept absolutely at a distance from dwelling-houses or simply subjected to certain precautions. They can be opened only with the permission and under the surveillance of the prefect of police. The first class comprises slaughter-houses, nightsoil reservoirs, vitriol works, &c. In 1882 there were of all the three classes 3049 establishments within the city of Paris; in 1881 there were 2922 in the suburban communes. The shops for mineral oils (3615) and those for mineral waters (1138) are also subject to inspection, and the groceries, drug-stores, and chemists' shops in which medicines are sold (9224) are under the supervision of the upper school of pharmacy. Steam machinery, (3817 machines, of 29,529 horse-power) which must be registered, is inspected by the engineers.

Eighty local committees—forty composed of men and forty of women—are entrusted with the duty of visiting the 12,316 workshops in which 27,402 children are employed (16,945 boys or girls between twelve and sixteen years of age, and 10,336 girls between sixteen and twenty-one, &c., still minors). Street porters (*commis-lustrateurs*), rag-pickers, hawkers, and lodging-house keepers are under police surveillance. The bodies of the drowned or of those who have died in the streets are conveyed to the Morgue, where post-mortem examinations are performed at the command of the court, and lectures delivered on medical jurisprudence. The number of bodies is increasing (718 in 1878; 879 in 1882). Of this total 673 were adults (committed suicide, 219; killed by accident, 105; murdered, 45; died suddenly, 86). Drowning is the most frequent cause of death (321 cases). Of the 673 adults 588 were identified; the 85 unidentified were photographed before burial.

**Cemeteries.**—A corpse cannot be buried in Paris without a certificate from a medical man who has ascertained that death has really taken place; and at least twenty-four hours must be allowed to elapse. In most cases (30,825 out of 57,871 deaths) the families are too poor to pay any funeral expense, and the body is consequently buried free of charge. Other interments are divided into nine classes, the cost of which ranges from 15s. to £287, without counting secondary and religious expenses. There are twenty cemeteries in Paris or outside the gates. Père la Chaise, the most extensive, contains 106½ acres; it is there that the most illustrious personages are generally buried. In 1882 the number of interments was no less than 8043 (all permanent). Montmartre, or the Northern Cemetery (26 acres), received 970 (all permanent); Montparnasse, or the Southern Cemetery (46 acres), 1945 (10 being temporary). The two cemeteries of St Ouen (61 acres) received 13,463 gratuitous and 5761 temporary interments, but only 10 permanent; and the two cemeteries at Ivry (69 acres) 20,380 gratuitous interments and 7088 temporary. It is towards St Ouen and Ivry that most of the funerals now make their way and those graveyards, though but recently formed, will before long prove insufficient. The other Paris cemeteries are due to the incorporation of the suburban communes in 1860. The little graveyard at

Picpus is the property of a few families. Old cemeteries, long ago abandoned, in the heart of the city have gradually been built over. The bones found on breaking up the ground are collected in the osuary of the Catacombs at Montrouge. The Catacombs are ancient quarries extending under a great part of the city south of the Seine; they are subjected to continual inspections and aboring-up to prevent subsidences such as have taken place on several occasions.

**Fires.**—The fire brigade has a military organization, and consists of 1742 officers and men. On 31st December 1882 they had at their disposal 1678 fire-plugs. In the course of that year they extinguished 982 fires (127 in January, the maximum; 56 in September, the minimum) and 1656 burning vents; and there were 72 false alarms. They used 1778 fire-engines, 139 of them worked by steam. Eight individuals perished in the conflagrations; 56 were saved by the firemen. Only 19 of the fires were serious. In 708 cases the damage was less than £40. The total loss for the year was £309,300. The most frequent cause of fires was some defect in the buildings (157 cases); lights ranked next (142 cases), and the falling of petroleum or naphtha lamps accounted for 84.

**Military.**—Paris is the seat of a military government, whose commandant has under him all the troops stationed in the departments of Seine and Seine-et-Oise. The soldiers recruited in the two departments are distributed among the 2d, 3d, 4th, and 5th corps d'armée, whose headquarters are at Amiens, Rouen, La Mans, and Orleans. The principal barracks belonging to the state in Paris are those of the military school of Prince Eugene and Napoleon; the town possesses the barracks of the republican guard, the gendarmes, and the firemen in different quarters. The most important are those of La Cité, to which the prefecture of police was transferred after the destruction of its former buildings by fire in 1871. Besides the war office and the hospitals named above, the main establishments comprise the dépôt of the fortifications, the central artillery dépôt with the workshops of St Thomas d'Aquin, and the dépôt of the commissariat department.

**Food Supply.**—The following table (VI.) shows the annual average of food consumed per head of the inhabitants of Paris:—

	Population.	Wine and Spirits.	Fish.	Oysters.	Poultry and Game.	Butcher Meat.	Tripe, &c.	Butter.	Eggs.	Cheese.
		Gallons.	lb	do	do	do	do	do	do	do
1866	1,635,374	41	19'	...	24	165'78	6'148	18'36	153	4'54
1872	1,851,792	47'5	29'68	...	24	156'10	5'848	17'16	157	4'45
1876	1,988,806	48'2	28'12	2'95	24	168	6'391	15'96	150	4'32
1881	2,239,928	50	28'28	5'12	24	172'74	6'64	16'66	180	4'95

The average annual consumption of bread is 349·46 pounds per head. Wholesale merchandise in food stuffs, though legal in all the market-places of Paris, is, as a matter of fact, concentrated in the central markets (*halles centrales*), with the exception of the butcher-meat trade, which is carried on by public auction or private sale both in the central markets and the slaughter-houses. The central markets comprise ten elegant "pavilions" of iron and glass, each about ½ acre, and separated from each other by streets which are for the most part covered. Dealers from the neighbourhood of Paris took to these markets, in 1882, 80,472 vehicles loaded with fruit, 723,257 with vegetables, 39,740 with potatoes, and 37,584 with pease and beans. These are entered as market-garden produce. There was also sold wholesale in the pavilions 1506 tons of "choice" fruits and vegetables, 6896 of "fine" fruits and vegetables, 6903 of ordinary vegetables, 4837 of cresses, 321,047,149 eggs (at an average price of 51s. per thousand), 192,629 "hundreds" of oysters, 21,144 tons of fish, 5748 tons of shell-fish, 6167 tons of "new" cheese, 697 tons of dry cheese, 12,419 tons of butter, 21,931 tons of poultry and game (comprising 6,454,876 fowls, 3,102,269 rabbits, 2,819,088 pigeons, 1,936,560 larks, &c., at an average price of 10½d. per lb), 38,086 tons of beef, veal, mutton and pork,—these last figures including butcher meat sold by public auction in the market of the La Villette slaughter-house. Through the same market there passed to the shambles in 1882 354,277 oxen, cows, and bulls, 199,416 calves, 2,054,680 sheep, 315,306 pigs. This cattle-market, connected with the Chemin de Fer de Ceinture so that the trains bring the cattle-trucks right into the market, occupies with its slaughter-houses an area of 111 acres. The places of sale (*positions de vente*) are capable of containing 4600 horned cattle, 23,000 sheep, 7000 pigs, 4000 calves. Horned cattle are liable to an entry fee of 3 francs, calves and pigs 1 franc, sheep 0·30 franc. Animals not sold are kept in sheds, cattle paying ½ franc per night, and the others in proportion. The slaughter-houses can accommodate 1200 butchers, and contain a tallow-melting house (*fondote*). Most of the cattle come from Maine-et-Loire, Nièvre, Calvados; sheep from Seine-et-Oise, Seine-et-Marne, Côte d'Or, Nord, Alsace, Allier, Indre-Cher; calves from Seine-et-Marne, Eure-et-Loir, Loiret, Nord, Aube; pigs from Sarthe, Allier, Creuse, Indre-et-Loire, and Maine-et-Loire. Foreign countries also contribute to the supply, especially of sheep. Germany in 1882 sent 576,563, Austria-

Hungary 352,376, Russia 156,005, Algeria 23,172, and Italy 37,694. Beside the Halles Centrales is the Halle aux Blés or corn-market. A certain number of full sacks are stored under the cupola (which, architecturally considered, is a bold and striking design), but the whole of this class of goods arriving at Paris does not necessarily pass through the building. Brought by boat or rail, they are either stored at the stations or taken directly to the bakers, the general warehouses, or the military stores. In 1881 71,961 tons of grain and 208,374 tons of flour reached the city.

The consumption of wine has not increased in Paris during the last decade, allowance being made for the growth of the population. For 1872 the figures were 85,407,322 gallons of wine in cask and 404,272 gallons in bottle; for 1880, 92,840,374 in cask and 428,450 in bottle. But the average consumption of spirits (1,312,498 in 1872, 2,907,190 in 1880) has doubled in the interval. More than half of the wines and spirits consumed in Paris pass through the entrepôts of Bercy, Quai St Bernard, or Pont de Flandre. To these great markets must be added the market for skins and hides (which, according to the latest returns—taken, however, in 1872—did business to the amount of £880,000), the horse-market (£414,200), charcoal-markets on the boats along the Seine (£180,000), sewer-markets (£80,000), and the markets for fodder, dogs, birds, &c. The Marché du Temple, rebuilt about 1864, is devoted to the sale of old clothes and second-hand articles of all sorts. All the market-houses and market-places are placed under the double supervision of the prefect of Seine and the prefect of police. The former official has to do with the authorization, removal, suppression, and holding of the markets, the fixing and collecting of the dues, the choice of sites, the erection and maintenance of buildings, and the locating of vehicles. The latter maintains order, keeps the roads clear, and watches against fraud. A municipal laboratory has recently been established, where any purchaser can have the provisions he has bought analysed, and can obtain precise information as to their quality. Spoiled provisions are seized by the agents of the prefecture; in 1880 458 tons of butcher meat, 123 tons of horse flesh, 52 tons of tripe, fish, vegetables, fruit, mushrooms, &c., were seized in this way.

**Industries and Commerce.**—Returns issued by the chamber of commerce for 1873 estimated the industrial production of Paris as in the following table:—

TABLE VII.—*Industries of Paris.*

Class of Industry.	No. of Workmen.	Average Daily Wage.	Total Annual Wage.
Food.....	55,989	4 4	2,464,451
Building.....	25,594	4 2	2,261,252
Furniture.....	26,441	3 3	2,408,128
Outfiting.....	112,306	4 10	6,262,737
Spun and woven goods.....	26,723	4 4½	1,167,615
Ordinary metals.....	23,161	4 7½	2,123,973
Precision metals.....	18,319	5 4	1,228,412
Chemical stuffs and pottery.....	12,106	4 4½	1,161,487
Printing, engraving, and paper.....	23,917	4 7	1,707,222
Philosophical instruments, musical instruments, clockwork.....	16,798	5 1½	1,172,746
Skins and leather.....	1,510	4 4	266,287
Carriages, saddlery, military equipments.....	24,684	4 11½	1,427,406
Shoemakers, brumies, &c.....	4,287	4 2½	248,444
Articles de Paris.....	24,916	4 4½	1,064,877
Miscellaneous.....	22,472	4 6	2,114,639
	280,287	4 8	26,486,187

The larger manufacturing establishments of Paris comprise engineering and repairing works connected with the railways, similar private works, foundries, and sugar refineries. Government works are the tobacco factories of Gros Caillon (2000 workmen) and Reuilly (1000), the national printing establishment (1000), the mint (where money and medals are coined by a contractor under state control), and the famous tapestry factory and dye-works of the Gobelin. The list of minor establishments is a very varied one; most of them devoted to the production of the so-called *articles de*

Paris, and carrying the principle of the division of labour to an extreme. The establishments which rank next to those above mentioned in the number of workmen are the chemical factories, the gas-works, the printing offices, cabinetmakers' workshops, boot factories, tailoring establishments, hat factories, and works for the production of paperhangings.

Among the workers are included 189,401 women, girls, and boys, and 123,369 masters—this last a figure which shows how great is the number of the small establishments. The total value produced was estimated at £134,763,717 in 1860, and must have since increased enormously. (Compare Table IV. p. 272.) In 1881 the average day's wages paid in the *petite industrie* were estimated at 4s. 5d. for the men and 2s. 5d. for the women. Since 1878 an increase has taken place year by year, at least for the men. Clerks in warehouses earn about £48 per annum, shop women £22, shop girls £16, male domestics £24, and female domestics £20.

In 1882 2400 new houses were built and 1883 old houses enlarged; on the other hand, 997 old houses were entirely demolished and 777 partially. The last official industrial valuation of rental is for the year 1876. At that date there were 76,129 houses containing 1,088,124 separate establishments, 699,175 being used as dwelling-houses at a rental of £13,981,836, and 338,949 for industrial purposes at a rental of £10,049,542.

Between 1872 and 1881 the navigation of the Seine doubled in importance. It has been free from all dues since 1830. There are three divisions—the navigation of the upper Seine and the Marne (above Paris), that of the lower Seine and the Oise (below Paris), and that of the Canal de l'Ouroq with its terminus at the La Villette basin, whence the St Denis Canal branches off to the lower Seine and the St Martin Canal to the upper Seine.

TABLE VIII.—*Navigation of the Seine.*

	Arrivals.			Departures.			Total Movement.
	Upper Seine and Marne.	Lower Seine and Oise.	Canal de l'Ouroq.	Upper Seine and Marne.	Lower Seine and Oise.	Canal de l'Ouroq.	
Average for 1872-80.....	Tons. 803,749	Tons. 417,780	Tons. 6,629	Tons. 104,160	Tons. 249,988	Tons. 12,246	Tons. 1,596,502
" 1882.....	1,220,015	521,682	11,286	193,445	329,966	10,594	2,286,638

The goods arriving by the upper Seine are chiefly building sand, paving-stones, firewood, timber, grain, coal and coke, pyrites, charcoal, and wines; those by the lower Seine, coal and coke, sand, paving-stones, wine, building materials, grain, and timber; and those by the Canal de l'Ouroq, building materials. By the upper Seine Paris despatches mainly refuse and manure; by the lower Seine, manure, pyrites, grain, and refined sugars; by the Canal de l'Ouroq, agricultural produce and manure. To the traffic of the river ports situated within the city must be added that of the ports along the canals, and especially that of La Villette, the third port of all France, judged by its commercial activity. The following table (IX.) shows the tonnage of the merchandises that passed through each of the canals in 1882 (the same merchandises may sometimes figure on two canals, or may have also been entered for the ports within the city):—

Ouroq Canal.		St Denis Canal.		St Martin's Canal.		Total for the Three Canals.
Up.	Down.	Up.	Down.	Up.	Down.	
Tons. 112,730	Tons. 894,198	Tons. 1,017,729	Tons. 261,002	Tons. 612,800	Tons. 424,028	Tons. 2,427,669

The Ouroq Canal brings down wood, building stones, bricks, flour, and especially plaster, and takes in return coal, manure, and night-soil for the Bondy manure-works. The St Denis Canal brings up coal from Nord, Pas de Calais, Belgium, and England; freestone from the valley of the Oise, sands from the lower Seine, wood for industrial purposes, grain, sewage for the works at Aubervilliers, colonial wares for La Villette, &c., and the most important articles taken down are sewage for Aubervilliers, and the various wares embarked at La Villette for Rouen or La Havre. Along the St Martin Canal, on the upward passage, sand, gravel, paving-stones or blocks, firewood, lime or cement, freestone, bricks, tiles, slates are discharged, and sewage especially is taken in for Aubervilliers. On the downward passage are discharged plasters from the Ouroq Canal, coal, and stones and sand from the Oise and the Ouroq. There is besides a large transit traffic.

Five of the great railway companies have a terminus at Paris. The "Nord" and the "Paris, Lyons, and Mediterranean" lines have each only one station; the "Ouest" has two, St Lazare and Montparnasse; the "Est" two, one of which, Bastille, is only a passenger station for the use of the Vincennes line and its prolongation; the "Orleans" two, of which one, Barrière d'Enfer, is restricted to the short line from Paris to Sceaux and Lâmoura.

The following table (X.) shows the number of passengers and quantity of goods that left Paris in 1880:—

	Word.	Est.	Ouest.	Orleans.	Paris-Lyons-Mediterranean.
Passengers.....	2,994,000	5,364,800	10,221,500	1,900,100	1,621,800
Goods (tons).....	1,267,028	622,268	1,228,704	601,970	1,228,029

Some goods are registered and pay dues at the Paris custom-house; but many pay these dues at the frontier. The following returns (Table XI.) must therefore be considered only as showing the importance of the Paris custom-house, and not the extent of the trade of the city:—

	General Trade.		Special Trade.	
	Quantity in Tons.	Value.	Quantity in Tons.	Value.
Imports.....	(A) 484,228	£26,222,459	(B) 490,135	£26,602,716
Exports.....	85,442	18,503,776	72,955	17,331,030

The "special" trade is for home consumption. The duty paid on the imports was £3,774,407.

Till 31st December 1897 the Bank of France has the exclusive privilege of issuing bank-notes. Notes are at present issued for 1000, 500, 100, and 50 francs (£40, £20, £4, and £2); at different times there have been notes for 5000, 2000, 25, 20, and 5. The Bank of France, which has already been described in BANKING (see vol. iii. p. 237-99), has 90 branch offices in the provinces. In 1877 the bank received bills and stock to the value of £56,022,522; its advances on securities amounted to £15,028,072; and the change of bank-notes into gold caused a movement of £23,228,000.

The other chief financial establishments in Paris are the Caisse des Dépôts et des Consignations, which receives voluntary deposits or those which are obligatory in certain cases fixed by law; the Crédit Foncier de France, which gives advances to landowners on real property; the Comptoir National d'Escompte, which carries on the same branches of business as the bank, with the exception of the issue of notes.

Among the great private joint-stock banks must be mentioned the Société Générale, the Crédit Industriel et Commercial, the Crédit Lyonnais, the Banque de Paris et des Pays Bas, the Société de Dépôts et Comptes Courants, the Banque d'Escompte, &c. The Bourse or Exchange is open from noon to 3 o'clock for the negotia-

tion of public stock, and from 8 to 6 for commercial transactions. The former is effected by means of brokers (*agents de change*) named by ministerial decree, and possessing the exclusive right of dealing in public stocks and bills. Brokers for the purchase and sale of goods enjoy freedom of trade, but the tribunal of commerce issues a list of the brokers who have taken the oath. These brokers meet to decide the prices current of the various goods.

The *conseils de prud'hommes* settle differences between workmen and workmen, or between workmen and masters; the whole initiative, however, rests with the parties. There are four of these bodies in Paris (for the metal trades, the chemical trades, the textile trades, and miscellaneous industries), composed of an equal number of masters and men. They succeed in settling without litigation 95 per cent. of the disputes submitted to them.

The tribunal of commerce, composed of business men elected by the "notables" of their order, deals with cases arising out of commercial transactions; declarations of bankruptcy are made before it; and it acts as court of appeal to the *conseils de prud'hommes*. In 1882, out of 75,960 cases brought into this court, judgment was given in 66,156, of which 20,696 were cases of first and 45,460 cases of last instance; 4584 cases were compromised. In the same year 1696 bankruptcies were declared, 10 applications made for rehabilitation, and 7 such applications granted by the Paris court of appeal. Money due to bankrupt estates is paid into the *Caisse des Dépôts et des Consignations*. In 1882 the tribunal of commerce registered 1963 deeds of partnership, 1167 dissolutions of partnership, 1840 home trade marks, and 175 foreign trade marks.

The chamber of commerce (under the honorary presidency of the Seine prefect) consists of twenty-one elective members, of whom a third are renewable every two years. Its duty is to present its views on the means of increasing and developing Parisian commerce. The *Condition des Soies*, as its name indicates, has to determine exactly the quality of the silk purchased by the dealers. The *Chambre Syndicale des Tissus*, a non-official association, is the recognized mouthpiece of the textile industries and trade in their dealings with the public administration.

*Post-offices and Telegraphs.*—The post and telegraph department comprised at the close of 1881 56 mixed offices, 22 post offices, 24 telegraph offices, and 863 letter boxes. The postal communications are collected eight times per day, and conveyed to one or other of the 15 sorting-offices (*bureaux de triage*), which arrange them according to their destinations. All are then brought together in the General Post Office (*Rocette principale de la Seine*), which in 1881 sent out 277,588,000 letters or post cards and 366,816,144 lower-rate packets (*objets affranchis à prix réduits*), and received 188,815,000 letters and post cards, and 40,716,000 lower-rate packets. In 1882 there were issued 2,143,952 ordinary money orders, 45,823 telegraphic orders, and 240,734 international orders; 3,841,335 ordinary orders, 80,693 telegraphic orders, and 188,480 international orders were cashed. The greatest number of foreign orders is from Belgium (86,885) and from Germany (35,684). Great Britain sent only 19,314 in 1881.

Telegraphic communication is effected partly by pneumatic tubes and partly by electric apparatus. The year 1881 showed a great increase over 1880 in the matter of pneumatic messages.

TABLE XII.

	1881.	1882.
Telegram-cards within Paris .....	619,418	846,611
Closed telegrams do. do....	335,108	515,509
Ordinary pneumatic telegrams do....	221,084	246,664
Total.....	1,175,610	1,608,778
Telegrams from outside of Paris.....	4,452,705	4,118,069
Do. from Paris to places outside	4,399,558	3,981,614
Do. passing through Paris by pneumatic tubes.....	398,158	814,785
Total of telegraphic messages.....	10,421,024	10,015,246

The pneumatic system had at the close of 1881 64 miles of tube and 49 offices, and by 1884 it was extended as far as the fortifications, and into almost all quarters of the town. The Government electric telegraph system has 27,000 miles of double wire; the branch offices being connected with the central office by 94 wires and with the Bourse office by 53. The municipal system, used by the various departments of the local administration, the police, the fire-brigade, &c., and for the indication of observatory time, has a length of 534 miles. The telephonic system on the 1st January 1882 had a length of 1392 miles and 2144 subscribers, — increased to 2306 miles and 2637 subscribers on the 1st of January 1883. The central telegraphic office has 315 instruments at work in direct communication with 23 foreign towns and 124 offices in the provinces. In 1880 it sent 11,559,200 messages, and in 1881 12,955,291. (G. ME.)

## HISTORY.

At its first appearance in history there was nothing to foreshadow the important part which Paris was to play in Europe and in the world. An island in the Seine, now almost lost in the modern city, and then much smaller than at present, was for centuries the entire site. The sole importance of the town lay in its being the capital of a similarly insignificant Gallic people, which navigated the lower course of the Seine, and doubtless from time to time visited the coasts of Britain. So few were its inhabitants that they early put themselves under the protection of their powerful neighbours the Senones, and this vassalship was the source of the political dependence of Paris on Sens throughout the Roman period, and of a religious subordination which lasted till the 17th century. The capital did not at once take the name of the Parisii, whose centre it was, but long kept that of Lutetia, Lucotetia, or Lutetia, of which Lutetia is the generally recognized French form.

During the war of Gallic independence, after being subjugated by Cæsar, who even in 53 B.C. made their territory the meeting-place of deputies from all Gaul, the Parisii took part in the great rising of the year 53, at the same time separating their cause from that of the Senones, who were held in check by Cæsar's lieutenant, Labienus. They joined their forces to the army commanded by an Aulerian, the old Camulogenna, which in turn was to unite with the Bellovaci to crush Labienus advancing from Sens to attack the Parisians. Having marched along the right bank of the river till opposite Lutetia, Labienus learned that the Bellovaci were in arms, and, fearing to find himself between two armies at a distance from his headquarters, he sought to get rid of Camulogenna, who, posted on the left bank, endeavoured to bar his way. The bridges had been cut and the town burned by order of the Gallic chief. By means of a stratagem Labienus drew his opponent up the river to the district now occupied by the *Jardin des Plantes*, and quietly by night crossed the Seine lower down in the neighbourhood of Grenelle, near a place which Cæsar calls *Meticosædum*, identified, but not conclusively, with Meudon. The Gauls, retracing their steps a little, met the Romans and allowed themselves to be routed and dispersed; their leader fell in the fore-front of the battle. Still unsubdued, the Parisii were called upon by the general council assembled in Alesia to furnish eight thousand men to help in raising the siege of that city. It is doubtful whether they were able to contribute the whole of this contingent, when their powerful neighbours the Bellovaci managed to send only two thousand of the ten thousand demanded of them. This was their last effort, and after the check at Alesia they took no part in the desperate resistance offered by the Bellovaci.

Lutetia was somewhat neglected under the Roman emperors of the first centuries. Its inhabitants continued quietly carrying on their river traffic, and devoted part of their wealth to the maintenance of a great temple to Jupiter built on the site of the present cathedral of Notre Dame. It is not known at what date Christianity was introduced into the future capital of France; but it is probable, judging by the use of the title "city," that Lutetia was the see of one of the earliest of the bishoprics of Gallia Celtica. The name of the founder of the church is known, but a keen controversy, not yet settled, has recently been raised with regard to the date when the first Roman missionary, St Dionysius or Donis, reached the banks of the Seine, along with his two deacons Rusticus and Eleutherius. A pious belief, which, in spite of its antiquity, has its origin in nothing better than parochial vanity, identifies the first-named with Dionysius the



Asopagite, who was converted by St Paul at Athens, and thus takes us back to the middle of the 1st century of the Christian era. Better founded is the opinion which dates the evangelization of the city two centuries later; the regular list of bishops, of whom, after Denis, the most famous was St Marcell, begins about 250.

Lutetia was in some sort the cradle of Christian liberty, having been the capital, from 292 to 306, of the mild Constantius Chlorus, who put an end to persecution in Brittany, Gaul, and Spain, over which he ruled. This emperor fixed his residence on the banks of the Seine, doubtless for the purpose of watching the Germans without losing sight of Brittany, where the Roman authority was always unstable; perhaps he also felt something of the same fancy for Lutetia which Julian afterwards expressed in his works and his letters. Be that as it may, the fact that these two princes chose to live there naturally drew attention to the city, where several buildings now rose on the left side of the river which could not have been reared within the narrow boundaries of the island. There was the imperial palace, the remains of which, a magnificent vaulted chamber, beside the Hôtel de Cluny, are now known, probably correctly, as Julian's Baths. At some distance up the river, in the quarter of St Victor, excavations in 1870 and in 1883 laid bare the foundations of the amphitheatre, which was capable of holding about 10,000 spectators, and thus suggests the existence of a population of 20,000 to 25,000 souls. Dwelling-houses, villas, and probably also an extensive cemetery, occupied the slope of the hill of St Geneviève.

It was at Lutetia that, in 360, Julian, already Cæsar, was in spite of himself proclaimed Augustus by the legions he had more than once led to victory in Germany. The troops invaded his palace, which, to judge by various circumstances of the mutiny, must have been of great extent. As for the city itself, it was as yet but a little town (*πολις*) according to the imperial author in his *Μισορογον*. The successive sojourns of Valentinian I. and Gratian scarcely increased its importance. The latest emperors preferred Treves, Arles, and Vienne in Gaul, and, besides, allowed Paris to be absorbed by the powerful Armerican league (c. 410). When the patricians Aetius, Egidius, and Syagrius held almost independent sway over the small portion of Gaul which still held together, they dwelt at Soissons, and it was there that Clovis fixed himself during the ten or eleven years between the defeat of Syagrius (486) and the surrender of Paris (497), which opened its gates, at the advice of St Geneviève, only after the conversion of the Frankish king. In 508, at the return of his victorious expedition against the south, Clovis made Paris the official capital of his realm—*Cathedram regni constituit*, says Gregory of Tours. He chose as his residence the palace of the Thermae, and lost no time in erecting on the summit of the hill, as his future place of interment, the basilica of St Peter and St Paul, which became not long afterwards the church and abbey of St Geneviève. After the death of Clovis, in spite of the supremacy granted to the kingdom of Austrasia or Metz, Paris remained the true political centre of the various Frankish states, insomuch that the four sons of Clothaire, fearing the prestige which would attach to whoever of them might possess it, made it a sort of neutral town, though after all it was seized by Sigebert, king of Austrasia, Chilperic, king of Neustria (who managed to keep possession for some time, and repaired the amphitheatre), and Gontran, king of Burgundy. The last sovereign had to defend himself in 585 against the pretender Gondowald, whose ambition aspired to uniting the whole of Gaul under his dominion, and marching on Paris to make it the seat of the half barbarian half

Roman administration of the kingdom of which he had dreamed.

Numerous calamities befell Paris from 586, when a terrible conflagration took place, to the close of the Merovingian dynasty. During a severe famine Bishop Landry sold the church plate to alleviate the distress of the people, and it was probably he who, in company with St Éloi (Eligius), founded the Hôtel-Dieu. The kings in the long run almost abandoned the town, especially when the Austrasian influence under the mayors of the palace tended to shift the centre of the Frankish power towards the Rhine.

Though the Merovingian period was for art a time of the deepest decadence, Paris was nevertheless adorned and enriched by pious foundations. Mention has already been made of the abbey of St Peter, which became after the death of Clovis the abbey of St Geneviève. On the same side of the river, but in the valley, Childebert, with the assistance of Bishop St Germain, founded St Vincent, known a little later as St Germain-des-Prés, which was the necropolis of the Frank kings before St Denis. On the right bank the same king built St Vincent le Rond (afterwards St Germain l'Auxerrois), and in La Cité, beside the cathedral of St Étienne, the basilica of Notre Dame, which excited the admiration of his contemporaries and in the 12th century obtained the title of cathedral. Various monasteries were erected on both sides of the river, and served to group in thickly-peopled suburbs the population, which had grown too large for the island.

The first Carolingian, Pippin the Short, occasionally lived at Paris, sometimes in the palace of Julian, sometimes in the old palace of the Roman governors of the town, at the lower end of the island; the latter ultimately became the usual residence. Under Charlemagne Paris ceased to be capital; and when feudal France was constituted under Charles the Bald it was liberally bestowed, like any ordinary place, on mere counts or dukes. But the dangers of the Norman invasion attracted general attention to the town, and showed that its political importance could no longer be neglected. When the suburbs were pillaged and burned by the pirates, and the city regularly besieged in 885, Paris was heroically defended by its "lords," and the emperor Charles the Fat felt bound to hasten from Germany to its relief. The pusillanimity which he showed in purchasing the retreat of the Normans was the main cause of his deposition in 887, while the courage displayed by Count Eudes procured him the crown of France. Robert, Eudes's brother, succeeded him; and, although Robert's son Hugh the Great was only duke of France and count of Paris, his power counterbalanced that of the last of the Carolingians, shut up in Leon as their capital.

With Hugh Capet in 987 the capital of the duchy of France definitively became the capital of the kingdom, and in spite of the frequent absence of the kings, several of whom preferred to reside at Orleans, the town continued to increase in size and population, and saw the development of those institutions which were destined to secure its greatness. Henry I. founded the abbey of St Martin-des-Champs, Louis the Stout that of St Victor, the mother-house of an order, and a nursery of literature and theology. Under Louis VII. the royal domain was the scene of one of the greatest artistic revolutions recorded in history: the Roman style of architecture was exchanged for the Pointed or Gothic, of which Suger, in his reconstruction of the basilica of St Denis, exhibited the earliest type. The capital could not remain aloof from this movement: several sumptuous buildings were erected; the Roman choir of St Germain-des-Prés was thrown down to give place to another more spacious and elegant; and when, in 1163, Pope Alexander had solemnly consecrated it, he was invited by Bishop Maurice de

Sully to lay the first stone of Notre Dame de Paris, a cathedral on a grander scale than any previously undertaken. Paris still possesses the Roman nave of St Germain-des-Prés, preserved when the building was rebuilt in the 12th century; the Pointed choir, consecrated in 1163; and the entire cathedral of Notre Dame, which, completed sixty years later, underwent various modifications down to the beginning of the 14th century. The sacristy is modern; the site previous to 1831 was occupied by the episcopal palace, also built by Maurice de Sully, who by a new street had opened up this part of the island.

Philip Augustus may be considered the second founder of Paris. He seldom quitted it save for his military expeditions, and he there built for himself, near St Germain l'Auxerrois, the Louvre, the royal dwelling *par excellence*, whose keep was the official centre of feudalism. He created or organized a regular system of administration with its headquarters at Paris; and under his patronage the public lectures delivered at Pré-aux-Clercs were regulated and grouped under the title of a university in 1200.

This university, the most famous and flourishing in Christendom, considerably augmented the local population, and formed as it were a new town on the left side of the river, where the important abbeys of St Geneviève, St Germain-des-Prés, and St Victor, and a vast Carthusian monastery already stood. Colleges were erected to receive the students of the different countries, and became the great meeting-place of the studious youth of all Europe. Returning to their native lands, where rank and honours awaited them, the pupils of the Paris university spread abroad the name and prestige of France; and sometimes they took home with them, or afterwards sent for, French artists, to whose wanderings must be ascribed the astonishing propagation in other countries of Pointed architecture.

The right side of the river, where commerce and industry had taken up their abode, and where the Louvre, the abbey of St Martin, and a large number of secondary religious establishments were already erected, became a centre of activity at least as important as that on the left. The old suburbs, too, were now incorporated with the town and enclosed in the new line of fortifications constructed by Philip Augustus, which, however, did not take in the great abbeys on the left side of the river, and thus obliged them to build defensive works of their own.

Philip Augustus issued from the Louvre a celebrated order that the streets of the town should be paved. Not far from his palace, on the site of the present Halles Centrales, he laid out an extensive cemetery and a market-place, which both took their name from the Church of the Innocents, a building of the same reign, destroyed at the Revolution. Fountains were placed in all the quarters. As for the lighting of the town, till the close of the 16th century the only lamps were those in front of the madonnas at the street corners. But the first "illumination" of Paris occurred under Philip Augustus: on his return from a victorious expedition to Flanders in 1214 he was welcomed by the Parisians as a conqueror; and the public rejoicings lasted for seven days, "interrupted by no night," says the chronicler, alluding to the torches and lamps with which the citizens lighted up the fronts of their houses. Ferrand, count of Flanders, the traitor vassal, was dragged behind the king to the dungeons of the Louvre, whose doors closed on him for ever.

In 1226 there was held at Paris a council which, by excommunicating Raymond VII., count of Toulouse, helped to prepare the way for the most important treaty which had as yet been signed in the capital. By this treaty (12th April 1229) Blanche of Castile obtained from Raymond VII. a great part of his possessions, while the

remainder was secured to the house of Capet through the marriage of Alphonse of Poitiers, brother of St Louis, with Jeanne, the last natural heiress of Languedoc.

In affection for his capital St Louis equalled or even surpassed his grandfather Philip, and Paris reciprocated his goodwill. The head of the administration was at that time the provost of Paris, a judiciary magistrate and police functionary whose extensive powers had given rise to the most flagrant abuses. Louis IX. reformed this office and filled it with the judge of greatest integrity to be found in his kingdom. This was the famous Étienne Boileau, who showed such vigilance and uprightness that the capital was completely purged of evil-doers; the sense of security thus produced attracted a certain number of new inhabitants, and, to the advantage of the public revenue, increased the value of the trade. It was Étienne Boileau who, by the king's express command, drew up those statutes of the commercial and industrial guilds of Paris which, modified by the necessities of new times and the caprices of princes, remained in force till the Revolution.

St Louis caused a partial restoration of St Germain l'Auxerrois, his parish church (completed in the 15th century, and deplorably altered under Louis XV.); and, besides preferring the palace of La Cité to the Louvre, he entirely rebuilt it, and rendered it one of the most comfortable residences of his time. Of this edifice there still remain, among the buildings of the present Palais de Justice, the great guard-room, the kitchens with their four enormous chimneys, three round towers on the quay, and, one of the marvels of the Middle Ages, the Sainte Chapelle, erected in 1248 to receive the crown of thorns sent from Constantinople. This church, often imitated during the 13th and 14th centuries, is like an immense shrine in open work; its large windows contain admirable stained glass of its own date, and the basements are adorned inside with pictures recently restored. It has a lower story ingeniously arranged, which served as a chapel for the palace servants. The Sainte Chapelle was designed by Pierre de Montreuil, one of the most celebrated architects of his time, to whom is attributed another marvel still extant, the refectory of the abbey of St Martin, now occupied by the library of the Conservatoire des Arts et des Métiers. This incomparable artist was buried in the abbey of St Germain-des-Prés, where, too, he had raised magnificent buildings now no longer existing. Under St Louis, Robert de Sorbon, a common priest, founded in 1253 an unpretending theological college which afterwards became the celebrated faculty of the Sorbonne, whose decisions were well-nigh as authoritative as those of Rome.

The capital of France had but a feeble share in the communal movement which in the north characterizes the 11th, 12th, and 13th centuries. Placed directly under the central power, it was never strong enough to force concessions; and in truth it did not claim them, satisfied with the advantages of all kinds secured for it by its political position and its university. And, besides, the privileges which it did enjoy, while they could be revoked at the king's pleasure, were of considerable extent. Its inhabitants were not subjected to forced labour or arbitrary imposts, and the liberty of the citizens and their commerce and industry were protected by wise regulations. The university and all those closely connected with it possessed the fullest rights and liberties. There was a municipal or bourgeois militia, which rendered the greatest service to Philip Augustus and St Louis, but afterwards became an instrument of revolt. The communal administration devolved on *schepins* or *jurés*, who, in conjunction with the notables, chose a nominal mayor called provost of the merchants (*prévôt des marchands*). The powers of this official had been grievously curtailed in favour of the

provost of Paris, and his lieutenants named by the sovereign. His main duties were to regulate the price of provisions and to control the incidence of taxation on merchandise. He was the chief inspector of bridges and public wells, superintendent of the river police, and commander of the guard of the city walls, which it was also his duty to keep in repair. And, finally, he had jurisdiction in commercial affairs until the creation of the consular tribunals by L'Hôpital (Lalanne, *Dict. historique de la France*). The violent attempts made by Étienne Marcel in the 14th century, and those of the communes of 1793 and 1871, showed what reason royalty had to fear too great an expansion of the municipal power at Paris.

The town council met in the 13th and 14th centuries in an unpretending house on Ste Geneviève, near the city walls on the left side of the river. The municipal assemblies were afterwards held near the Place de Grève, on the right side of the river, in the "Maison aux Piliers," which Francis I. allowed to be replaced by an imposing hôtel de ville.

The last of the direct descendants of Capet, and the first

two Valois did little for their capital. Philip the Fair, however, increased its political importance by making it the seat of the highest court in the kingdom, the *parlement*, which he organized between 1302 and 1304, and to which he surrendered a part of his Cité palace. Under the three sons of Philip the Fair, the Tour de Nesle, which stood opposite, on the site now occupied by the buildings of the Institute, was the scene of frightful orgies, equally celebrated in history and romance. One of the queens who, if the chronicles are to be trusted, took part in these expiated her crimes in Château-Gaillard, where she was strangled in 1315 by order of her husband, Louis X. During the first part of the war of the Hundred Years, Paris escaped being taken by the English, but felt the effects of the national misfortune. Whilst destitution excited in the country the revolt of the Jacquerie, in the city the miseries of the time were attributed to the vices of the feudal system, and the citizens seemed ready for insurrection. The provost of the merchants, Étienne Marcel, equally endowed with courage and intellect, sought to turn this double movement to account in the interest of the



Paris in 1380.

municipal liberties of Paris and of constitutional guarantees. The cause which he supported was lost through the violence of his own acts. Not content with having massacred two ministers under the very eyes of the dauphin Charles, who was regent whilst his father John lay captive in London, he joined the Jacquerie, and was not afraid to call into Paris the king of Navarre, Charles the Bad, a notorious firebrand who at that time was making common cause with the English. Public sentiment, at first favourable to Marcel's schemes, shrank from open treason. A watch was set on him, and, at the moment when, having the keys of the town in his possession in virtue of his office, he was preparing to open one of the gates, he was assassinated by order of Jean Maillard, one of the heads of the *milice*, on the night of July 31, 1358. Marcel had enlarged Philip

Augustus's line of fortifications on the right side of the river, and had commenced a new one

When he became king in 1364, Charles V. forgot the outrages he had suffered at the hands of the Parisians during his regency. He robbed the Louvre to some extent of its military equipment, in order to make it a convenient and sumptuous residence; his open-work staircases and his galleries are mentioned in terms of the highest praise by writers of the time. This did not, however, remain always his favourite palace; having built or rebuilt in the St Antoine quarter the mansion of St Paul or St Pol, he was particularly fond of living in it during the latter part of his life, and it was there that he died in 1380. It was Charles V. who, in conjunction with the provost of the merchants, Hugues Aubriot, erected the famous Bastille

to protect the St Antoine gate. A library which he founded—a rich one for the times—became the nucleus of the national library. With the exception of some of the upper portions of the Sainte Chapelle, which were altered or reconstructed by this prince or his son Charles VI., there are no remains of the buildings of Charles V.

The reign of Charles VI. was as disastrous for the city as that of his father had been prosperous. From the very accession of the new king, the citizens, who had for some time been relieved by a great reduction of the taxes, and had received a promise of further alleviation, found themselves subjected to the most odious fiscal exactions on the part of the king's uncle, who was not satisfied with the well-stored treasury of Charles V., which he had unscrupulously pillaged. Aubriot, having ventured to remonstrate, was thrown into prison as a heretic, and in 1382 a riot took place for the purpose of delivering the provost and seizing the fiscal agents. Preoccupied with his expedition against the Flemings, Charles VI. delayed putting down the revolt, and for the moment remitted the new taxes. On his victorious return on 10th January 1383, the Parisians in alarm drew up their forces in front of the town gates under the pretext of showing their sovereign what aid he might derive from them, but really in order to intimidate him. They were ordered to retire within the walls and to lay down their arms, and they obeyed. The king and his uncles, having destroyed the gates, made their way into Paris as into a besieged city; and with the decapitation of Desmarets, one of the most faithful servants of the crown, who perished at the age of seventy, began a series of bloody executions. Ostensibly through the intercession of the regents an end was put to that species of severities, a heavy fine being substituted, much larger in amount than the annual value of the abolished taxes. The municipal administration was suspended for several years, and its functions bestowed on the provost of Paris, a magistrate nominated by the crown.

The calamities which followed were due to the weakness and incapacity of the Government, given over because of the madness of Charles VI. to the intrigues of a wicked queen and of princes who brought the most bloodthirsty passions to the service of their boundless ambition. First came the rivalry between the dukes of Orleans and Burgundy, brought to an end in 1407 by the assassination of the former in Rue des France-Bourgeois. Next followed the relentless struggle for supremacy between two hostile parties, the Armagnacs on one side, commanded by Count Bernard of Armagnac (who for a brief period had the title of constable), and supported by the nobles and bourgeois, and on the other side the Burgundians, depending on the common people, and recognizing the duke of Burgundy (John the Bold) as their head. The mob was headed by a skinner at the Hôtel-Dieu called Jean Caboche, and hence the name Cabocheians given to the Burgundian party. They became masters of Paris in 1412 and 1413; but so violent were their excesses that the most timid rose in revolt, and the decimated bourgeoisie managed by a bold stroke to recover possession of the town. The Armagnacs again entered Paris, but their intrigues with England and their tyranny rendered them odious in their turn; the Burgundians were recalled in 1418, and returned with Jean Caboche and a formidable band of pillagers and assassins. Ferrinet Leclerc, son of a bourgeois guard, secretly opened the gates to them one night in May. The king resided in the Hôtel St Paul, an unconscious spectator of those savage scenes which the princes Louis and John, successively dauphins, were helpless to prevent.

The third dauphin, Charles, afterwards Charles VII., managed to put an end to the civil war, but it was by a crime as base as it was impolitic—the assassination of

John the Bold on the bridge of Montreuil (1419). Next year a treaty, from the ignominy of which Paris happily escaped, gave a daughter of Charles VI. to Henry V. of England, and along with her, in spite of the Salic law, the crown of France. The king of England made his entry into Paris in December 1420, and was there received with a solemnity which ill concealed the misery and real consternation of the poor people crushed by fifteen years of murders, pillage, and famine. Charles VI. remained almost abandoned at the Hôtel St Paul, where he died in 1422, whilst his son-in-law went to hold a brilliant court at the Louvre and Vincennes. Henry V. of England also died in 1422. His son Henry VI., then one year old, came to Paris nine years later to be crowned at Notre Dame, and the city continued under the government of the duke of Bedford till his death in 1435.

The English rule was a mild one, but it was not signalized by the execution of any of those works of utility or ornament so characteristic of the kings of France. The choir of St Severin, however, shows a style of architecture peculiarly English, and Sauval relates that the duke of Bedford erected in the Louvre a fine gallery decorated with paintings. Without assuming the mission of delivering Paris, Joan of Arc, remaining with Charles VII. after his coronation at Rheims, led him towards the capital; but the badly conducted and abortive enterprise almost proved fatal to the Maid of Orleans, who was severely wounded at the assault of the gate of St Honoré on the 8th September 1429. The siege having been raised, Charles awaited the invitation of the Parisians themselves upon the defection of the Burgundians and the surrender of St Denis. The St Jacques gate was opened by the citizens of the guard to the constable Arthur of Richemont on April 13, 1436; but the solemn entry of the king did not take place till November 12 of the following year; subsequently occupied by his various expeditions or attracted by his residences in Berry or Touraine, he spent but little time in Paris, where he retired either to the Hôtel St Paul or to a neighbouring palace, Les Tournelles, which had been acquired by his father.

Louis XI. made equal use of St Paul and Les Tournelles, but towards the close of his life he immured himself at Plessis-les-Tours. It was in his reign, in 1469, that the first French printing press was set up in the Sorbonne. Charles VIII. scarcely left Plessis-les-Tours and Amboise except to go to Italy; Louis XII. alternated between the castle at Blois and the palace of Les Tournelles, where he died January 1, 1515.

Francis I. lived at Chambord, at Fontainebleau, at St Germain, and at Villers-Cotterets; but he proposed to form at Paris a residence in keeping with the taste of the Renaissance. Paris had remained for more than thirty years almost a stranger to the artistic movement begun between 1498 and 1500, after the Italian expedition. Previous to 1533, the date of the commencement of the Hôtel de Ville and the church of St Eustache, Paris did not possess, apart from the "Court of Accounts," any important building in the new style. Between 1527 and 1540 Francis I. demolished the old Louvre, and in 1541 Pierre Lescot began a new palace four times as large, which was not finished till the reign of Louis XIV. The buildings were not sufficiently advanced under Henry II. to allow of his leaving Les Tournelles, where in 1559 he died from a wound received at a tournament. His widow, Catherine de' Medici, immediately caused this palace to be demolished, and sent her three sons—Francis II., Charles IX., and Henry III.—to the unfinished Louvre. Outside the line of the fortifications she laid the foundations of the Château des Tuileries as a residence for herself.

Of the three brothers, it was Charles IX. who resided



most at the Louvre; it was there that in 1572 he signed the order for the massacre of St Bartholomew. Henry III. remained for the most part at Blois, and hardly came to Paris except to be witness of the power of his enemies the Guises.

Taking advantage of the absence of the kings, the League had made Paris a centre of opposition. The municipal militia were restored and reorganized; each of the sixteen quarters or arrondissements had to elect a deputy for the central council, which became the council or rather faction of The Sixteen, and for four years, from 1587 to 1591, held the city under a yoke of iron. Henry III., having come to the Louvre in 1588, unwillingly received there the duke of Guise, and while endeavouring to take measures for his own protection provoked a riot known as the Day of the Barricades. It was with difficulty that he escaped from his palace, which at that time had no communication with the country, and which Henry IV. afterwards proposed to unite with the Tuileries in order to provide a sure means of escape in case of need.

When, after the murder of the duke of Guise at Blois at the close of 1588, Henry III. desired to return to Paris, he was not yet master of the city, and was obliged to besiege it in concert with his presumptive heir the king of Navarre. The operations were suddenly interrupted on August 1, 1589, by the assassination of the king, and Henry IV. carried his arms elsewhere. He returned with his victorious forces in 1590. This second siege lasted more than four years, and was marked by terrible suffering, produced by famine and the tyranny of The Sixteen, who were supported by the intrigues of the king of Spain and the violent harangues of the preachers. Even the conversion of the king did not allay the spirit of fanaticism, for the king's sincerity was suspected, and the words (which history, however, fails to substantiate), "Paris is surely worth a mass," were attributed to him. But after the coronation of the king at Chartres the commonalty of Paris, weary of intriguing with strangers and Leaguers, gave such decided expression to its feelings that those of its leaders who had kept aloof or broken off from the faction of The Sixteen attached themselves to the parlement, which had already evaded the ambitious designs of the king of Spain; and after various negotiations the provost of the merchants, L'Huillier, offered the keys of the city to Henry IV. on March 22, 1594. The king met no resistance except on the part of a company of German landknechts, which was cut in pieces, and the students of the university, who, steeped in the doctrines of the League, tried to hold their quarter against the royal troops, but were dispersed. The Spanish soldiers who had remained in the town decamped next day.

Henry IV., who carried on the building of the Louvre, was the last monarch who occupied it as a regular residence. Attempts on his life were made from time to time, and at last on May 14, 1610, he fell under Ravallac's knife near the market-house in Rue de la Ferronnerie.

Whether royalty gave it the benefit of its presence or not, Paris continued all the same to increase in political importance and in population. Here is the picture of the city presented about 1560 by Michel de Castelnau, one of the most celebrated chroniclers of the 16th century:—

"Paris is the capital of all the kingdom, and one of the most famous in the world, as well for the splendour of its parlement (which is an illustrious company of thirty judges attended by three hundred advocates and more, who have reputation in all Christendom of being the best seen in human laws and acquainted with justice) as for its faculty of theology and for the other tongues and sciences, which shine more in this town than in any other in the world, besides the mechanic arts and the marvellous traffic which render it very populous, rich, and opulent; in such sort that the other towns of France and all the magistrates and subjects have their eyes directed thither as to the model of their decisions and their political administrations."

Castelnau spoke rather as a statesman and a magistrate, and he did not look close enough to see that the university was beginning to decline. The progress of the sciences somewhat lessened the importance of its classes, too specially devoted to theology and literature; the eyes of men were turned towards Italy, which was then considered the great centre of intellectual advance; the colleges of the Jesuits were formidable rivals; the triumphs of Protestantism deprived it of most of the students who used to flock to it from England, Germany, and Scandinavia; and finally the unfortunate part it played in political affairs weakened its influence so much that, after the reign of Henry IV., it no longer sent its deputies to the states-general.

If the city on the left side of the river neither extended its circuit nor increased its population, it began in the 16th century to be filled with large mansions (hôtels), and its communications with the right bank were rendered easier and more direct when Henry IV. constructed across the lower end of the island of La Cité the Pont Neuf, which, though retaining its original name, is now the oldest bridge in Paris. On the right side of the river commerce and the progress of centralization continued to attract new inhabitants, and old villages become suburbs were enclosed within the line of a bastioned first enceinte, the ramparts of Étienne Marcel being, however, still left untouched. Although Louis XIII., except during his minority, rarely stayed much in Paris, he was seldom long absent from it. His mother, Mary de' Medici, built the palace of the Luxembourg, which, after being extended under Louis Philippe, became the seat of the senata.

Louis XIII. finished, with the exception of the eastern front, the buildings enclosing the square court of the Louvre, and carried on the wing which was to join the palace to the Tuileries. Queen Anne of Austria founded the Val de Grâce, the dome of which, afterwards painted on the interior by Mignard, remains one of the finest in Paris. Richelieu built for himself the Palais Royal since restored, and rebuilt the Sorbonne, where now stands his magnificent tomb by Girardon. The island of St Louis above La Cité, till then occupied by gardens and meadows, became a populous parish, whose streets were laid out in straight lines, and whose finest houses still date from the 17th century. Building also went on in the Quartier du Marais (quarter of the marsh); and the whole of Place Royale (now Place des Voeges), with its curious arcaded galleries, belongs to this period. The church of St Paul and St Louis was built by the Jesuits beside the ruins of the old Hôtel St Paul; the church of St Gervais received a façade which has become in our time too famous. St Étienne du Mont and St Eustache were completed (in the latter case with the exception of the front). The beautiful Salle des Pas-Perdus (Hall of Lost Footsteps) was added to the Palais de Justice. Besides these buildings and extensions Paris was indebted to Louis XIII. and his minister Richelieu for three important institutions—the royal printing press in 1620, the Jardin des Plantes in 1626, and the French Academy in 1635. The bishopric of Paris was separated from that of Sens and erected into an archbishopric in 1623.

As memorials of Mazarin Paris still possesses the Collège des Quatre-Nations, erected with one of his legacies immediately after his death, and since appropriated to the Institute, and the palace which, enlarged in our own time, now accommodates the national library.

The stormy minority of Louis XIV. was spent at St Germain and Paris, where the court was held at the Palais Royal. The intrigues of the prince of Condé, Cardinal de Retz, and (for a brief space) Turenne resulted in a siege of Paris, during which more epigrams than balls were fired off; but the cannon of the Bastille, discharged by order of Mademoiselle de Montpensier, enabled Condé to enter the

city. Bloody riots followed, and came to an end only with the exhaustion of the populace and its voluntary submission to the king. Though Louis XIV. ceased to stay in Paris after he grew up, he did not neglect the work of embellishment. On the site of the fortifications of Étienne Marcel, which during the previous hundred years had been gradually disappearing, he laid out the line of boulevards connecting the quarter of the Bastille with that of the Madeleine. Though he no longer inhabited the Louvre (and it never was again the seat of royalty), he caused the great colonnade to be constructed after the plans of Claude Perrault. This immense and imposing façade, 548 feet long, has the defect of being quite out of harmony with the rest of the building, which it hides instead of introducing. The same desire for effect, altogether irrespective of congruity, appears again in the observatory erected by the same Perrault, without the smallest consideration of the wise suggestions made by Cassini. The Place Vendôme, the Place des Victoires, the triumphal gates of St Denis and

St Martin, and several fountains, are also productions of the reign of Louis XIV. The hospital of La Salpêtrière, with its majestically simple dome, was finished by Libéral Bruant. The Hôtel des Invalides, one of the finest institutions of the Grand Monarque, was also erected, with its chapel, between 1671 and 1675, by Bruant; but it was reserved for the architect Hardouin Mansart to give to this imposing edifice a complement worthy of itself: it was he who raised the dome, admirable alike for its proportions, for the excellent distribution of its ornaments, and for its gilded lantern, which rises 344 feet above the ground. "Private persons," says Voltaire, "in imitation of their king, raised a thousand splendid edifices. The number increased so greatly that from the neighbourhood of the Palais Royal and of St Sulpice there were formed in Paris two new towns much finer than the old one." All the aristocracy had not thought fit to take up their residence at Versailles, and the great geniuses of the century, Corneille, Racine, La Fontaine, Molière, Madame de Sévigné, had their houses

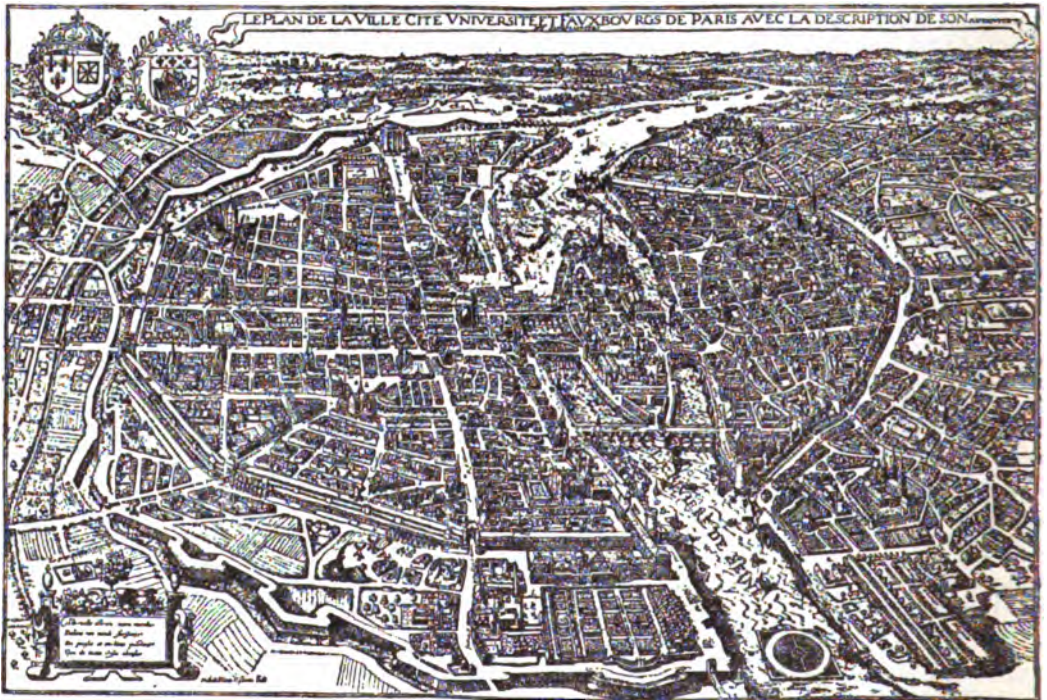

Paris in 1615.

in Paris; there also was the Hôtel de Rambouillet, so famous in the literary history of the 17th century.

The halls of the Palais Royal during the minority of Louis XV. were the scene of the excesses of the regency; later on the king from time to time resided at the Tuileries, which henceforward came to be customarily regarded as the official seat of the monarchy. To the reign of Louis XV. are due the rebuilding of the Palais Royal, the "Place" now called De la Concorde, the military school, the greater part of the church of Ste Geneviève or Panthéon (a masterpiece of the architect Soufflot), the church of St Roch, the palace of the Elysées (now the residence of the president of the republic), the Palais Bourbon (with the exception of the façade) now occupied by the chamber of deputies, and the mint, a majestic and scholarly work by the architect Antoine, as well as the rebuilding of the Collège de France.

↳ Louis XVI. finished or vigorously carried on the works

begun by his grandfather. He did not come to live in Paris till compelled by the Revolution. That historical movement began indeed at Versailles on June 17, 1789, when the states-general were transformed into a constituent assembly; but the first act of violence which proved the starting-point of all its excesses was performed in Paris on July 14, 1789, when Paris inaugurated, with the capture of the Bastille, its "national guard," organized and then commanded by the celebrated La Fayette. At the same time the assassination of the last provost of the merchants, Jacques de Flesselles, gave the opportunity of establishing, with more extended powers, the "mairie" (mayoralty) of Paris, which was first occupied by Bailly, and soon became, under the title of commune, a political power capable of effectively counterbalancing the central authority.

Paris had at that time once more outgrown its limits. The quarter on the left side of the river had more than



doubled its extent by the accession of the great monasteries, the faubourgs of St Germain and St Marceau, the Jardin des Plantes, and the whole of Mont Ste Geneviève. The line of the new enceinte is still marked by a circuit of boulevards passing from the Champs de Mars at Pont d'Ansterlitz by Place de l'Enfer and Place d'Italie. Similar enlargements, also marked out by a series of boulevards, incorporated with the town on the right side the faubourgs of St Antoine and Poissonnière and the quarters of La Chaussée d'Antin and Chaillot. In 1784 was begun, instead of a line of fortifications, a simple customs-wall, with sixty propylæas or pavilions in a heavy but characteristic style, of which the finest are adorned with columns or pilasters like those of Pæstum. In front of the Place du Trône (now Place de la Nation), which formed as it were a façade for Paris on the east side, there were erected two lofty rostral columns bearing the statues of Philip Augustus and St Louis. Towards the west, the city front was Place Louis XV. (Place de la Concorde), preceded by the magnificent avenue of the Champs Élysées. Between the barriers of La Villette and Pantin, where the highways for Flanders and Germany terminated, was built a monumental rotunda flanked on the ground floor by four peristyles arranged as a Greek cross, and in the second story lighted by low arcades supported by columns of the Pæstum type. None of these works were completed till the time of the empire. It was also in the latter part of the reign of Louis XIV., and under the first republic, that the quarter of La Chaussée d'Antin was built.

It does not enter into the plan of the present sketch to narrate the history of Paris during the Revolutionary period; that is the history rather of France, and to a certain extent of the whole world (see FRANCE). During the consulate hardly anything of note took place at Paris except the explosion of the infernal machine directed against Bonaparte on December 24, 1800.

The coronation of Napoleon by Pope Pius VII. was celebrated in Notre Dame on December 2, 1804. Eight years later, during the Russian campaign, the conspiracy of General Malet, happily suppressed, was on the point of letting loose on all France a dreadful civil war. The empire, however, was then on the wane, and Paris was witness of its fall when, after an heroic resistance of two days, the city was obliged to surrender to the allies on March 30, 1814.

After the return of the Bourbons, Paris had to submit to a treaty more humiliating than the capitulation. Already in 1763 Louis XV. had signed in his capital the treaty with England known as the shameful (*Honteuse*), by which he surrendered a great part of the American and Indian colonies, and notably Canada. That of May 30, 1814, was more truly disastrous, since it dismembered the mother-country, cancelled almost all the conquests of the republic and the empire, and lessened the military strength of France by robbing it of half its fleet. And worse even than this was the treaty of 28th November 1815, which not only suppressed the slight accessions of territory recognized by the treaty of 1814, and doomed to demolition the fortifications of Huningue, but exacted a war indemnity of 700 million francs (£28,000,000), and demanded the maintenance in seven departments of 150,000 soldiers of the allied army until the payment of the entire sum.

Under Louis XVIII. the only event of note that occurred in Paris was the assassination of the duke of Berry by Louvel, February 13, 1820. Ten years later the revolution of 1830, splendidly commemorated by the Column of July in Place de la Bastille, put Charles X. to flight and inaugurated the reign of Louis Philippe, a troublous period which was closed by the revolution of 1848 and a new republic. It was this reign, however, that surrounded Paris with

bastioned fortifications with ditches and detached forts. The republic of 1848 brought no greater quiet to the city than did the reign of Louis Philippe. The most terrible insurrection was that of June 23 to 26, 1848, distinguished by the devotion and heroic death of the Archbishop Affre. It was quelled by General Cavaignac, who then for some months held the executive power. Prince Louis Napoleon next became president of the republic, and after dissolving the chamber of deputies on December 2, 1851, caused himself to be proclaimed emperor just a year later.

The second empire completed that material transformation of Paris which had already been begun at the fall of the ancient monarchy. First came numerous cases of destruction and demolition caused by the suppression of the old monasteries and of many parish churches. A number of mediæval buildings, civil or military, were cleared away for the sake of regularity of plan and improvements in the public streets, or to satisfy the taste of the owners, who thought more of their comfort or profit than of the historic interest of their old mansions or houses. Destructions of this kind, in some instances of advantage, in other cases without excuse, still continue with more or less frequency. It was under the first empire that the new series of improvements were inaugurated which have made Paris a modern city. Napoleon began the Rue de Rivoli, built along this street the wing intended to connect the Tuileries with the Louvre, erected in front of the court of the Tuileries the triumphal arch of the Carrousel, in imitation of that of Septimius Severus at Rome. In the middle of the Place Vendôme was reared, on the model of Trajan's column, the column of the grand army, surmounted by the statue of the emperor. To immortalize this same grand army he ordered from the architect Pierre Vignon a Temple of Victory, which without changing the form of its Corinthian peristyle has become the church of the Madeleine; the entrance to the avenue of the Champs Élysées was spanned by the vast triumphal arch De l'Étoile (of the star), which owes its celebrity not only to its colossal dimensions and its magnificent situation, but also to one of the four subjects sculptured upon its faces—the *Chant du Départ* or *Marseillaise*, one of the masterpieces of Rude and of modern sculpture. Another masterpiece was executed by David of Angers, the pediment of the Panthéon, not less famous than Soufflot's dome. The museum of the Louvre, founded by decree of the Convention on July 27, 1793, was organized and considerably enlarged; that of the Luxembourg was created in 1805, but was not appropriated exclusively to modern artists till under the Restoration. The Conservatoire des Arts et Métiers, due to the Convention, received also considerable additions in the old priory or abbey of St Martin des Champs, where the council of the Five Hundred had installed it in 1798.

Under the Restoration and under the government of July many new buildings were erected; but, with the exception of the Bourse, constructed by the architects Brongniart and Lebarre, and the colonnade of the chamber of deputies, these are of interest not so much for their size as for the new artistic tendencies affected in their architecture. People had grown weary of the eternal Græco-Roman compilations rendered fashionable by the Renaissance, and reduced under the empire to mere imitations, in producing which all inspiration was repressed. The necessity of being rational in architecture, and of taking full account of practical wants, was recognized; and more suggestive and plastic models were sought in the past. These were to be found, it was believed, in Greece; and in consequence the government under Louis Philippe saw itself obliged to found the French school at Athens, in order to allow young artists to study their favourite types on the spot. In the case of churches it was deemed judicious to revive the

Christian basilicas of the first centuries, as at Notre Dame de Lorette and St Vincent de Paul; and a little later to bring in again the styles of the Middle Ages, as in the ogival church of Ste Clotilde.

Old buildings were also the object of labours more or less important. The Place de la Concorde was altered in various ways, and adorned with eight statues of towns and with two fountains; on October 25, 1836, the Egyptian obelisk, brought at great expense from Luxor, was erected in the centre. The general restoration of the cathedral of Notre Dame was voted by the Chamber in 1845, and entrusted to Viollet-le-Duc; and the palace of the Luxembourg and the Hôtel de Ville were considerably enlarged at the same time, in the style of the existing edifices.

But the great transformer of Paris in modern times was Napoleon III. To him or to his reign we owe the Grand Opéra, the finest theatre in the world, and the masterpiece of the architect Garnier; the new Hôtel-Dieu; the finishing of the galleries which complete the Louvre and connect it with the Tuileries; the extension of the Palais de Justice and its new front on the old Place Dauphine; the tribunal of commerce; the central markets; several of the finest railway stations; the viaduct at Auteuil; the churches of La Trinité, St Augustin, St Ambroise, St François Xavier, Belleville, Ménilmontant, &c. For the first international Paris exhibition (that of 1855) was constructed the "palace of industry"; the enlargement of the national library was commenced; the museum of French antiquities was created by the savant Du Sommerard, and installed in the old "hôtel" built at the end of the 15th century for the abbots of Cluny.

All this is but the smallest part of the memorials which Napoleon III left of his presence. Not only was the city traversed in all directions by new thoroughfares, and sumptuous houses raised or restored in every quarter, but the line of the fortifications was made in 1859 the limit of the city. The area was thus doubled, extending to 7450 hectares or 18,410 acres, instead of 3402 hectares or 8407 acres. It was otherwise with the population; to the 1,200,000 inhabitants which Paris possessed in 1858 the incorporation of the suburban zone only added 600,000.

Paris had to pay dear for its growth and prosperity under the second empire. This Government, which, by straightening and widening the streets, thought it had effectually guarded against the attempts of its internal enemies, had not sufficiently defended itself from external attack, and at the first reverses of 1870 Paris found itself prepared to overthrow the empire, but by no means able to hold out against the approaching Prussians.

The two sieges of Paris in 1870-71 are among the most dramatic episodes of its history. The first siege began on September 19, 1870, with the occupation by the Germans of the heights on the left side of the river and the capture of the unfinished redoubt of Châtillon. Two days later the investment was complete. General Trochu, head of the French Government and governor of the city, had under his command 400,000 men—a force which ought to have been able to hold out against the 240,000 Germans by whom it was besieged, had it not been composed for the most part of hurried levies of raw soldiers with inexperienced officers, and of national guards who, never having been subjected to strict military discipline, were a source of weakness rather than of strength. The guards, it is true, displayed a certain warlike spirit, but it was for the sole purpose of exciting disorder. Open revolt broke out on October 31; it was suppressed, but increased the demoralization of the besieged and the demands of the Prussians. The partial successes which the French obtained in engagements on both sides of the river were rendered useless by the Germans recapturing all the best positions;

the severity of winter told heavily on the garrison, and the armies in the provinces which were to have co-operated with it were held in check by the Germans in the west and south. In obedience to public opinion a great sortie was undertaken; this, in fact, was the only alternative to a surrender; for, the empire having organized everything in expectation of victory and not of disaster, Paris, insufficiently provisioned for the increase of population caused by the influx of refugees, was already suffering the horrors of famine. Accidental circumstances combined with the indecision of the leaders to render the enterprise a failure. Despatches sent by balloon to the army of the Loire instructing it to make a diversion reached their destination too late; the bridge of Champigny over the Marne could not be constructed in time; the most advantageous positions remained in the hands of the Germans; and on the 2nd and 3rd December the French abandoned the positions they had seized on the 29th and 30th of November. Another sortie made towards the north on December 21st was repulsed, and the besieged lost the Avron plateau, the key to the positions which they still held on that side. The bombardment began on December 27th, and great damage was done to the forts on the left of the Seine, especially those of Vanves and Issy, directly commanded by the Châtillon battery. A third and last sortie (which proved fatal to Regnault the painter) was attempted in January 1871, but resulted in hopeless retreat. An armistice was signed on January 27th, the capitulation on the 28th. The revictualing of the city was not accomplished without much difficulty, in spite of the generous rivalry of foreign nations (London alone sending provisions to the value of £80,000).

On the 1st of March the Germans entered Paris. This event, which marked the close of the siege, was at the same time the first preparation for the "commune;" for the national guard, taking advantage of the general confusion and the powerlessness of the regular army, carried a number of cannon to the heights of Montmartre and Belleville under pretext of saving them. President Thiers, appreciating the danger, attempted on March 18th to remove the ordnance; his action was the signal of an insurrection which, successful from the first, initiated a series of terrible outrages by the murder of the two generals, Lecomete and Thomas. The Government, afraid of the defection of the troops, who were demoralized by failure and suffering, had evacuated the forts on the left side of the river and concentrated the army at Versailles (the forts on the right side were still to be held for some time by the Germans). Mont Valérien happily remained in the hands of the Government, and became the pivot of the attack during the second siege. All the sorties made by the insurgents in the direction of Versailles (where the National Assembly was in session from March 20) proved unsuccessful, and cost them two of their improvised leaders—Generals Flourens and Duval. The incapacity and mutual hatred of their chiefs rendered all organization and durable resistance impossible. On Sunday May 21st the Government forces, commanded by Marshal M'Mahon, having already captured the forts on the right side of the river, made their way within the walls; but they had still to fight hard from barricade to barricade before they were masters of the city; Belleville, the special Red Republican quarter, was not assaulted and taken till Friday. Meanwhile the communists were committing the most horrible excesses: the archbishop of Paris (GEORGES DARBOY, *q.v.*), President Bonjean, priests, magistrates, journalists, and private individuals, whom they had seized as hostages, were shot in batches in the prisons; and a scheme of destruction was ruthlessly carried into effect by men and women with cases of petroleum (*pétroleurs* and

*piétoleses*). The Hôtel de Ville, the Palais de Justice, the Tuileries, the Ministry of Finance, the palace of the Legion of Honour, that of the Council of State, part of the Rue de Rivoli, &c., were ravaged by the flames; barrels of gunpowder were placed in Notre Dame and the Panthéon, ready to blow up the buildings; and the whole city would have been involved in ruin if the national troops had not gained a last and crowning victory in the neighbourhood of La Roquette and Père-la-Chaise on May 28th. Besides the large number of insurgents who, taken in arms, were pitilessly shot, others were afterwards condemned to death, to penal servitude, to transportation; and the survivors only obtained their liberty by the decree of 1879.

From this double trial Paris emerged diminished and almost robbed of its dignity as capital; for the parliamentary assemblies and the Government went to sit at Versailles. For a little it was thought that the city would not recover from the blow which had fallen on it. All came back, however—confidence, prosperity, and, along with that, increasing growth of population and the execution of great public works. The Hôtel de Ville has been rebuilt, the school of medicine adorned with an imposing

façade, a vast school of pharmacy established in the old gardens of the Luxembourg, and boulevards completed. The exhibition of 1878 was more marvellous than those of 1855 and 1867, and unlike that of the latter year has left a lasting memorial, the palace of the Trocadéro. Finally the chambers in 1879 considered quiet sufficiently restored to take possession of their customary quarters in the Palais Bourbon and the Luxembourg. This happy event closes for the present the annals, at times only too dramatic, of the capital of France.

(A. S.-P.)

*Bibliography.*—From the immense list of works relating to Paris it is possible to make but a small selection here. For the history of the city the reader may consult Senval, *Histoire de Paris*, 3 vols. fol., 1724; Dom Félibien, *Histoire de Paris*, 5 vols. fol., 1728; Labaud, *Histoire de la ville et du diocèse de Paris*, 16 vols. 12mo, 1754-57, new ed. by Cochard, 1863 sq.; Jallot, *Recherches sur Paris*, 5 vols. 8vo, 1772-74; Dulaure, *Histoire de Paris*, often reprinted; Berty, *Topographie historique du vieux Paris*, 3 vols. 4to, 1866-68, and *Atlas des anciens plans de Paris*, published by the city and edited by Ducher. For the libraries and art treasures of Paris the following works may be referred to:—Franklin, *Les anciennes bibliothèques de Paris* (1867); L. Dellea, *Le cabinet des manuscrits de la bibliothèque impériale* (1868); *Inventaire général des richesses d'art de la France, publié par le Ministère de l'Instruction publique et des Beaux-Arts* (the volumes relating to Paris), and the *Inventaire général des œuvres d'art appartenant à la ville de Paris*, in course of publication by the municipality. As regards the modern city, see the official *Annuaire statistique de la ville de Paris*; the *Atlas de la ville de Paris par arrondissement*, published by the municipality; Maxime Ducaup, *Paris, ses organes, ses fonctions, sa vie* (6 vols. 8vo and 6 vols. 16mo, 1868-1876); Lacroix and Verbitschewski, *Paris-Guide, par les principaux écrivains et artistes de la France*, 1867; and A. Joanna, *Paris illustré*, 1861.

PARIS, the son of Priam, king of Troy. Before he was born his mother Hecuba dreamed that she was delivered of a firebrand. The dream was interpreted that her child would ruin his country, and when Paris was born he was exposed on Mount Ida. His life was saved by the herdsmen, and he grew up among them, distinguished for beauty and strength, till he was recognized and received by his parents. When the strife arose at the marriage of Peleus and Thetis between Hera, Athena, and Aphrodite, each claiming the apple that should belong to the most beautiful, Paris was selected as the judge. The three rivals unveiled their divine charms before a mortal judge on Mount Ida. The scene afterwards became a favourite subject in Greek art, and it is usual to represent Hermes escorting the goddesses. Each tried to bribe the judge, Hera by promising power, Athena wisdom, Aphrodite the most beautiful woman in the world. Paris decided in favour of Aphrodite, and thus made Hera and Athena the bitter enemies of his country. To gain the woman whom Aphrodite had promised, Paris set sail for Lacedæmon, deserting his old love, Enone, daughter of the river-god Cabren, who in vain tried to induce him to give up his purpose. He was hospitably received by Menelaus, whose kindness he repaid by seducing his wife Helena to flee with him to Troy. The details of the flight are variously related (see *HELEN*). The siege of Troy by the united Greeks followed. Paris proved a lazy and backward fighter, though not wanting in actual courage when he could be roused to exert himself. Before the capture of the city he was mortally wounded by Philoctetes with an arrow. He then bethought him of the slighted nymph Enone, who he knew could heal the wound. He was carried into her presence, but she refused to save him. Afterwards, when she found he was dead, she committed suicide. Paris is represented in Greek art as a beautiful young man, beardless, wearing the pointed Phrygian cap, and often holding in his hand the apple.

PARIS, MATTHEW OF. See vol. xv. p. 633.

PARISH. In England the parish may be regarded as essentially an ecclesiastical institution, being defined as the township or cluster of townships which was assigned to the ministrations of a single priest, to whom its tithes and other ecclesiastical dues were paid; and it has been decided that if a place has not a church, churchwardens, and sacramentalia it is not a parish in this original sense of the term.

The word has now acquired several distinct meanings, which must be separately mentioned and investigated.

*The Old Ecclesiastical Parish.*—In the absence of evidence to the contrary, the ecclesiastical parish is presumed to be composed of a single township or vill, and to be co-terminous with the manor within the ambit of which it is comprised. Before the process of subinfeudation became prevalent, the most ancient manors were the districts which we call by that name when speaking of the tenants, or "townships" when we regard the inhabitants, or "parishes" as to matters ecclesiastical. The parish as an institution is in reality later in date than the township. The latter has been in fact the unit of local administration ever since the country was settled by the English in their several states and kingdoms; the beginnings of the parochial system are attributed to Theodore of Tarsus, who was archbishop of Canterbury towards the close of the 7th century. The system was extended in the reign of Edgar, and it appears not to have been complete until the reign of Edward III. It has been considered that the intimate connexion of church and state militates against the view that the parochial system was founded as a national institution, since any legislation on the subject of the township and parochial systems would probably have resulted in the merging of the one into the other. "The fact that the two systems, the parish and the township, have existed for more than a thousand years side by side, identical in area and administered by the same persons, and yet separate in character and machinery, is a sufficient proof that no legislative Act could have been needed in the first place; nor was there any lay council of the whole nation which could have sanctioned such a measure" (Stubbs, *Const. Hist.*, i. 227). The boundaries of the old ecclesiastical parishes are usually identical with those of the township or townships comprised within its precinct; they are determined by usage, in the absence of charters or records, and are evidenced by perambulations, which formerly took place on the "gang-days" in Rogation week, but are now for the most part held triennially, the Poor-Law Act of 1844 permitting the parish officers to charge the expense on the poor-rate, "provided the perambulations do not occur more than once in three years." The expense of preserving the boundary by land-marks or bound-stones is chargeable to the same rate. Many parishes contain more than one township, and this is especially the case in the northern

counties, where the separate townships are organized for administrative purposes under an Act passed in 1662. In the southern and midland districts the parishes are for the most part subdivided into hamlets or other local divisions known as "tythings," "boroughs," and the like; the distinction between a parish and a subordinate district lies chiefly in the fact that the latter will be found to have never had a church or a constable to itself. The select committee of 1873, appointed to inquire into parochial boundaries, reported to the effect that the parish bears no definite relation to any other administrative area, except indeed to the Poor-Law Union. It may be situated in different counties or hundreds, and in many instances it contains, in addition to its principal district, several outlying portions intermixed with the lands in other parishes. Since the abolition of compulsory church rates in 1868 (subject to certain exceptions as to rates which had already been mortgaged), the old ecclesiastical parish has ceased to be of importance as an instrument of local government. Its officers, however, have still important duties to perform. The rector, vicar, or incumbent is a corporation-sole, in whom is vested the freehold of the church and churchyard, subject to the parishioners' rights of user; their rights of burial have been enlarged by the Burial Laws Amendment Act, 1880, and an Act passed in 1882 to regulate the interment of suicides. The churchwardens are the principal lay officers. Their duties consist in keeping the church and churchyard in repair and in raising a voluntary rate for the purpose to the best of their power; they have also the duty of keeping order in church during divine service; and by Acts passed in 1860 and 1877 they are required to furnish annual accounts to the Local Government Board. The other officials are the parish-clerk and sexton. They have freeholds in their offices, and are paid by customary fees. The office of the clerk is regulated by an Act of 1844, enabling a curate to undertake its duties, and providing facilities for vacating the office in case of misconduct. It is said that the only civil function of the parish-clerk now remaining is to undertake the custody of maps and documents, which may be deposited under the provisions of the Railway Clauses Act, 1845.

*The New Ecclesiastical Parish.*—Under the powers given by the Church Building Acts, many populous parishes have been subdivided into smaller ecclesiastical parishes. This division has not affected the parish in its civil aspect (Chalmers, *Local Government*, 39). The change has helped to increase the distinction between the ecclesiastical and civil parishes. Mr Chalmers estimates that there are now about 15,000 civil and 13,000 ecclesiastical parishes in England, and that in 1871 not more than 10,000 civil parishes coincided with the ecclesiastical districts of the same names.

*The Poor-Law Parish.*—For the purposes of civil government the term "parish" means a district for which a separate poor-rate is or can be made, or for which a separate overseer is or can be appointed; and by the Poor Law Amendment Act, 1866, this definition is to be used in interpreting all statutes except where the context is inconsistent therewith. This district may of itself constitute a poor law union; but in the great majority of cases the unions, or areas under the jurisdiction of boards of guardians according to the Poor-Law Amendment Act of 1834, are made up of aggregated poor-law parishes. Each of these poor-law parishes may represent the extent of an old ecclesiastical parish, or a township separately rated by custom before the practice was stayed in 1819 or separated from a large parish under the Act of 1662, or it may represent a chapelry, tything, borough, ward, quarter, or hamlet, or other subdivision of the ancient parish, or an area formed by the merger of an extra-parochial place with an

adjoining district under the Acts of 1857 and 1869, or by the union of detached portions with adjoining parishes under the Acts of 1876 and 1879, or by the subdivision of a large parish for the better administration of the relief of the poor under the Poor-Law Amendment Act of 1867 and the Local Government Board Act of 1871. The civil importance of the poor-law parishes may be dated from the introduction of the poor law by the statute of 43 Elizabeth, which directed overseers of the poor to be appointed in every parish, and made the churchwardens into *ex officio* overseers. The statute was preceded by tentative provisions of the same kind enacted in the reigns of Edward the VI and Mary and in the fifth year of Elizabeth, and after several renewals was made perpetual in the reign of Charles I. The chief part of the parochial organization is the vestry-meeting. It derives its name from the old place of assembly, which in parishes exceeding two thousand in population may now be replaced by a vestry-hall. The vestry represents the old assembly of the township, and retains so much of its business as has not been insensibly transferred to the court-baron and court-leet. The freemen, now appearing as the ratepayers, elect the "parish officers," as the churchwardens and way-wardens, the assessors, the overseers, and (if required) paid assistant-overseers, a secretary or vestry-clerk, and a collector of rates if the guardians apply for his appointment. A meeting for the election of guardians is held in April every year, subject to the rules laid down by the Local Government Board as to the number of guardians for each parish, and the union of parishes for voting purposes. In case of a contest the election is conducted under Sturges Bourne's Act. Common vestries are meetings of all the ratepayers assembled on a three days' notice; the minister of the ecclesiastical parish is chairman, if present; the meeting acts by show of hands unless a poll is demanded; if demanded, the poll is conducted by plural voting according to payment of rates. Select vestries are regulated by the local custom, or may derive their power from Hobhouse's Act passed in 1831, now repealed in the Metropolitan District, and not much used elsewhere. The functions of the vestry, apart from elections, are practically confined to the management of the property of the parish. The vestry, however, has power to adopt the Free Libraries Act, or the Lighting and Watching Act of 1833, and may appoint a new burial board if a new burial-ground is required; but with these exceptions, most of its active powers and duties have now been taken away by the Acts relating to the poor laws and public health.

*The Land-Tax Parish.*—The parishes or places separately assessed for land tax form another class. They are described in the series of land-tax accounts from 1692 to the present time, and are also defined in the Taxes Management Act of 1880.

*The Burial Acts Parish.*—The Burial Acts from 1852 to 1875 deal with areas which are treated as parishes for the purposes of those Acts, but which have no necessary connexion with the boundaries of the civil and ecclesiastical districts known as parishes in the ordinary sense of the term.

*The Highway Parish.*—The word "parish" is used in a very wide and vague manner in the Highway Acts. It includes any civil district less than the county, such as wapentakes, hundreds, cities, liberties, or franchises, as well as subdivisions of the ordinary parish, such as townships and hamlets, if by reason of tenure or custom or otherwise such larger or smaller district either maintains its own highways or would do so if it were not included in a highway district composed of several highway parishes or in an urban sanitary district. The constitution of the highway parish is discussed in the Report of the Lords' Committee on Highways. (c. l. n.)

*The Parish in Scotland.*—There can be little doubt that about the beginning of the 13th century the whole, or almost the whole, of the kingdom of Scotland was parochially divided. It seems probable (though the point is obscure) that the bishops presided at the first formation of the parishes—the parish being a subdivision of the diocese—and at any rate down to the date of the Reformation they exercised the power of creating new parishes within their respective dioceses (Duncan, *Parochial Law*, p. 4). After the Reformation the power of altering parishes was assumed by the legislature. The existing parochial districts being found unsuited to the ecclesiastical requirements of the time, a general Act was passed in 1581, which made provision for the parochial clergy, and, *inter alia*, directed that "a sufficient and competent" district should be appropriated to each church as a parish (1581, cap. 100). Thereafter, by a series of special Acts in the first place, and, subsequent to the year 1617, by the decrees of parliamentary commissions, the creation of suitable parochial districts was proceeded with. The powers conferred on the parliamentary commissions embraced what are technically known as (1) the disjunction and erection of parishes, (2) the union of parishes, and (3) the disjunction and annexation of parishes. In altering and defining parochial areas in those several ways, the object which the commissioners had in view was to provide for the spiritual wants of particular districts of the country, and to procure from the lands in the parish a proper stipend for the clergy. In the year 1707 the powers exercised by these commissioners were permanently transferred to the Court of Session, whose judges were appointed to act in future as "Commissioners for the Plantation of Kirks and Valuation of Teinds" (Act, 1707, cap. 9). Under this statute the areas of parishes continued to be altered and defined down to 1844, when the Act commonly known as Graham's Act was passed, (7 & 8 Vict. c. 44). This Act, which applies to the disjunction and erection of parishes, introduced a simpler form of procedure, and to some extent dispensed with the consent of the heritors, which had been required under the earlier statute. Since 1844 proceedings for disjunction and erection of parishes have been taken under it.

The main division of parishes in Scotland as they now exist is into civil and ecclesiastical, or, to speak more accurately, into parishes proper (*i.e.*, for all purposes, civil and ecclesiastical) and ecclesiastical parishes. This division is expressed in legal language by the terms, parishes *quoad omnia* (*i.e.*, *quoad civitas et sacra*) and parishes *quoad sacra—civitas* being such matters as church rates, education, poor law, and sanitary purposes, and *sacra* being such as concern the administration of church ordinances, and fall under the cognizance of the church courts. There are other minor divisions which will be noticed below. (1) *The Parish Proper.*—In a number of instances it is difficult to determine the exact areas of such parishes at the present day. The boundaries of the old ecclesiastical parish were nowhere recorded, and the descriptions in the titles of private properties which appear to lie in the parish have sometimes to be taken as evidence, and sometimes the fact that the inhabitants attended a particular church or made payments in favour of a particular minister. Where there has been a union or disjunction and erection of parishes the evidence of the boundaries is the relative statute, order in council, or decree of commission or of Court of Teinds. The total number of parishes proper in Scotland is eight hundred and eighty-six, and they vary to a great degree both in size and population. For ecclesiastical purposes, the minister and kirk-session constitute the parochial authority. The minister is vested with the manse and glebe, to be held by him for himself and his successors in office, and along with the kirk-session he administers church ordinances and exercises church discipline. For purposes of local government, on the other hand, the Scottish parish, unlike that of England, has been largely utilized by modern legislation. The oldest governing authority is the meeting of the heritors or landowners of the parish. Though shorn of much of its old importance, the heritors' meeting has still the power of imposing an assessment for the purpose of providing and maintaining a church and churchyard and a manse and glebe for the minister. It also possesses power to assess under the Parochial Buildings Acts of 1862 and 1866. In a certain number of parishes also, which have not adopted a parochial board under the Poor-Law Act, 1845, the heritors along with the kirk-session provide for the relief of the poor, and administer the funds legally destined for that purpose. In the great majority, however, of civil parishes the chief governing authority is the parochial board, which in non-burghal parishes is composed of owners of land of £20 annual value and upwards, and representatives of the kirk-session and of the magistrates of any burgh within the parish and of the rate-payers—the number of representative members being in each case fixed by the Board of Supervision. Another local authority of great importance is the school board, created by the recent Education Acts. Speaking generally, the matters administered in the civil parish are poor relief, education, public health, burial, registration, and church rates. (2) *Quoad Sacra Parishes.*—The ecclesiastical or *quoad sacra* parish is a modern creation. Under Graham's Act, above mentioned,

a parish may be disjoined and erected *quoad sacra tantum* on the application of persons who have built and endowed a church, and who offer securities for its proper maintenance. The creation is made purely on a consideration of the spiritual interests of a particular district, and not for any purposes of civil administration. By the Education Act of 1872, however, the *quoad sacra* parish has been adopted as a separate school district. There are three hundred and twenty-five such parishes in Scotland. (3) *Extra-Burghal Parishes.*—For sanitary purposes, highways, and some others, certain classes of burghs have been made separate areas from the parishes in which they lie. This fact creates a set of incomplete parishes, which are called extra-burghal. (4) *Burghal, Landward, and Burghal-Landward (or Miced) Parishes.*—This division of parishes depends, as the names imply, upon local character and situation of the parochial districts. The importance of the distinction arises in connexion with the rule of assessment which is to be adopted for various parochial burdens, and the nature of the rights of the minister and corresponding obligations of the parishioners. (5) *Combined Parishes.*—Under the Poor-Law, Education, and Registration Acts power is given to the central authority to combine parishes for purposes of local administration. (6) *The Parish in the United States.*—The term "parish" is not in use as a territorial designation except in Louisiana, the fifty-eight parishes of which correspond to the counties of the other States of the Union.

The principal records from which information may be gained as to the oldest parochial system in England are the records called *Nomena Villarum*, the *Favrite* *Papae Nicolai* made in 1291, the *Nomenum Inquisitiones* relating to assessments made upon the clergy, the *Valor Ecclesiasticus* of Henry VIII., the lay subsidies from the reign of Edward III. to that of Charles II., the hearth-tax assessments, and the land-tax accounts. On the subject of the parish generally the reader should consult Stubbs's *Constitutional History*, Glen's *Parish Law*, Tomlin Smith's work on the *Parish*, Holdsworth's *Handy Book of Parish Law*, and M. D. Chalmer's work on *Local Government*, published in the English Citizen Series. For fuller information regarding the Scottish parish the following works may be consulted:—Connell on *Teinds*; Duncan's *Parochial Ecclesiastical Law*; the Cobden Club essays on *Local Government and Taxation in the United Kingdom*, published in 1883; Goudy and Smith's *Local Government in Scotland*.

PARK, MURDO (1771–1806 †), a celebrated African traveller, was born in Selkirkshire, Scotland, on the 20th September 1771, at Fowlshiels on the Yarrow,—the farm which his father rented from the duke of Buccleuch. He was the seventh in a family of thirteen. Having received a good education (at home from a private tutor, and afterwards at the grammar school of Selkirk), he was apprenticed to a surgeon named Anderson, in Selkirk, and then attended the university of Edinburgh for three sessions (1789–91). By his brother-in-law, James Dickson, a botanist of repute, he was introduced to Sir Joseph Banks, and through his good offices he obtained the post of assistant-surgeon on board the "Worcester" East Indiaman. In this capacity he made the voyage in 1792 to Bencoolen in Sumatra, and on his return in 1793 he contributed a description of eight new Sumatran fishes to the *Transactions* of the Linnean Society. Park next offered his services to the African Association, then looking out for a successor to the unfortunate Major Houghton, and, again supported by the influence of Sir Joseph Banks, he was successful in his application. On the 21st June 1795 he reached the Gambia, but it was not till December 2d that he started for Pisanía with only two Negro servants (Johnson and Demba) on the hazardous and difficult expedition into the interior, from which he was to return with the proud distinction of being the first of modern Europeans to reach the well-nigh fabulous waters of the Niger. Striking north-eastward across the upper basin of the Senegal, he advanced through Kaarta and El Hodh, and descended upon the great river of his quest at Segu on the north bank, about 13° 5' N. lat. and 6° 20' W. long. Though he was not able to proceed down stream any farther than Mursan and Silla, he managed on his home journey to follow the river valley as far up as Bannako, a distance of about 300 miles. By the 10th June he was again at Pisanía, but he did not reach England till December 22, 1796. An account of his journey was at once drawn up for the Association by Bryan Edwards, and a detailed narrative from his own pen appeared in 1799 (*Travels in the Interior of Africa*). Abundance of incident, and an unaffected charm of style, at once rendered

the work extremely popular, and it still holds its place as one of the acknowledged classics in this department of literature. It seemed for a time as if Park was now to settle down quietly at home; he married a daughter of his old master, Mr Anderson, and commenced practice as a country doctor at Peebles, where at least he could enjoy "a glass of strong beer and a peep at the sky through Mr Oman's telescope"; but he was ill at ease—his heart was in Africa. In 1804 the people of Peebles were amused and alarmed by the vagaries of Sidi Omback Boubi from Mogador, who had come to teach their doctor Arabic; and in autumn Park parted from Sir Walter Scott, who had been one of his best friends, with the hopeful proverb on his lips, "Freits (omens) follow those that look to them." He had accepted Lord Hobart's proposal that he should take command of a Niger expedition. He sailed from Portsmouth on January 30, 1805; and the expedition started from Pisisia on May 4th. Unfortunately the rainy season soon afterwards commenced; by the time Bamako was reached the party was reduced from forty-four Europeans to eleven, and from Sansanding the leader had to report "five only are at present alive, viz., three soldiers (one deranged in his mind), Lieutenant Martyn, and myself." Among those who had died at Sansanding was his brother-in-law Mr Anderson. On November 19th he set sail down the river from Sansanding with the "fixed resolution to discover the termination of the Niger or perish in the attempt." Isaac, the Mandingo guide who had accompanied the expedition up to this point, was afterwards sent on a mission to find out the fate of the voyagers; it was learned that they had managed to make their way through countless perils to Bussa (Boussa) between 9° and 10° N. lat., and that they were there attacked by the natives, and were drowned in endeavouring to escape. Park was 6 feet in height, active and robust; his countenance was prepossessing, his manner in company plain and simple, but somewhat cold and reserved.

See the *Life* (by Wislawa) prefixed to *Journal of a Mission into the Interior of Africa in 1805*, London, 1816; H. B., *Life of Mungo Park*, Edinburgh, 1836; and an interesting passage in Lockhart's *Life of Sir Walter Scott*, vol. ii.

PARKER, JOHN HENRY (1806-1884), architectural archæologist, was the son of a London merchant, and was born in 1806. He was educated at Manor House School, Chiswick, and in 1821 entered business as a bookseller. Succeeding his uncle Joseph Parker as a bookseller at Oxford in 1832, he conducted the business with great success, the most important of the firm's publications being perhaps the series of the "Oxford Pocket Classics." The cares of business did not prevent him from devoting, in the earlier period of his life, much of his time to those architectural studies which latterly engaged his chief attention. In 1836 he brought out his *Glossary of Architecture*, which, published in the earlier years of the Gothic revival, had considerable influence in extending the movement, and supplied a valuable help to young architects. In 1848 he edited the fifth edition of Rickman's *Gothic Architecture*, and in 1849 he published a handbook based on his earlier volume, and entitled *Introduction to the Study of Gothic Architecture*. The completion of Hudson Turner's *Domestic Architecture of the Middle Ages* next engaged his attention, three volumes being published (1853-60). In 1858 he published *Medieval Architecture of Chester*. Parker was one of the chief advocates of the "restoration" of ecclesiastical buildings, and published in 1866 *Architectural Antiquities of the City of Wells*. Latterly he devoted much attention to explorations of the history of Rome by means of excavations, and succeeded in satisfying himself of the historical truth of much usually regarded as legendary. Two volumes of his *Archæology*

of Rome have been published, the one in 1873, and the other in 1875, while six additional parts have also appeared, and two others were in the press at his death. In recognition of his labours he was decorated by the king of Italy, and received a medal from Pope Pius IX. In 1869 he endowed the keepership of the Ashmolean Museum with a sum yielding £250 a year, and under the new arrangement he was appointed the first keeper. In 1871 he was nominated C.B. He died 31st January 1884.

PARKER, MATTHEW (1504-1575), archbishop of Canterbury, the eldest surviving son of William Parker and Alice Monins, his wife, was born at Norwich 6th August 1504. His father was an artisan, a calenderer of woollen stuffs, but through his mother he could afterwards trace his descent from the earls of Nottingham. He was instructed in reading by Thomas Benis, rector of St Clement's, Norwich, and in the elements of Latin by one William Neve; in the latter he found (a somewhat exceptional experience in those days) a kind and sympathizing teacher. When Matthew was twelve years of age he lost his father; but his mother was, notwithstanding, able to send him at the commencement of the Michaelmas term, 1521, to Cambridge, and to maintain him there until his merits secured some recognition. He was educated partly in St Mary's Hostel and partly in Corpus Christi College. In March 1523 he was elected to a bible-clerkship in the college, an office which involved reading the Bible aloud on prescribed occasions, and waiting at the fellows table at dinner. In the March of the following year he was admitted B.A.; he was subsequently made a deacon and a priest, in 1527 was elected to a fellowship, and in 1528 commenced M.A.

His industry as a student and his general ability marked him out for early notice; and when, in 1521, Wolsey was founding Cardinal College (afterwards Christ Church), Oxford, Parker was one among a number of rising Cambridge students who were invited to become fellows of the new society. Fortunately, however, for himself and for Cambridge he elected to stay at Corpus. The university was at this time becoming a great centre of the Reformation movement, and he found himself attracted to the meetings held at the White Horse (an inn in the town), which the Catholic party derisively styled "Germany," from the fact that it was the known rendezvous of the supporters of Lutheran tenets. Among those with whom he was thus brought into contact was Bilney, the martyr; and when, in 1531, the latter was burned at Norwich, Parker attended him in his last hours, and afterwards bore testimony to his constancy. On Cramer's election to the archbishopric of Canterbury, Parker received a licence to preach, and soon became known in Cambridge and its neighbourhood as a divine of considerable oratorical power. He was summoned to preach at court; and in 1535 the queen, Ann Boleyn, appointed him her chaplain. He shortly after received a further mark of her favour by being made dean of the college of St John the Baptist, at Stoke, near Clare, Suffolk—an institution for the training of the secular clergy. Here he gave the earliest indication of his skill as an administrator; and the new statutes which he drew up for the college were deemed so judicious that the duke of Norfolk, in 1540, adopted them as a model for the code which he gave to a similar foundation at Thetford. Parker's retired life at Stoke did not altogether secure him from attack on account of his courageously avowed sympathies with the Reformation, and in the year 1539 he was accused by the townsmen of Clare of manifesting undue contempt for the Catholic ritual.

At Stoke Parker continued to reside more or less until the year 1545. His disposition throughout life was naturally retiring. In one of his letters to Cecil, written



about 1543, he confesses to a "natural viciousity of over-much shamefacedness"; and this constitutional defect would seem, at this time, to have been aggravated by a state of health which made it necessary for him to obtain the permission of the university, when preaching in St Mary's, Cambridge, to do so with his head covered. In the year 1538 he was created D.D. Although his indifferent health and love of study alike inclined him to a retired life, his seclusion was frequently broken in upon by honours and preferment which came unsought. He was selected by Thomas Cromwell to preach at Paul's Cross, on account of "his learning in holy letters and uncorrupt judgment in the same." He was appointed one of the king's chaplains, and in the year 1541 was made a canon of Ely. In 1542 his own college of Stoke presented him to an Essex living. About this time it began to be rumoured that the dissolution of Stoke College could not be averted, and the arguments for Parker's return to his university, in whose welfare his interest had continued undiminished, were such as he could no longer resist. The mastership of Corpus having fallen vacant, he consented to be elected to the post, at that time scarcely of the annual value of £10; to this, however, the society shortly after added the rectory of Landbeach. In January 1545 he was elected to the vice-chancellorship of the university by a large majority. The colleges of both universities were at this period in continual fear of being, sooner or later, handed over, as the monasteries had been, to the greed of the despoiler. It was accordingly resolved, in order to anticipate a commission consisting of unscrupulous courtiers and lawyers, that the university should obtain the royal authority for a commission composed of those who were intimately acquainted with the real state of affairs, and, through the good offices of Catherine Parr, Parker, along with two other heads of colleges, was selected for the task. When their survey had been completed, they repaired to Hampton Court, and laid their statement before the king. Henry, on reading the report, expressed his emphatic admiration at the economical management of the colleges, and dismissed the commission with assurances which completely baffled the expectations of the courtiers. The fate which was averted from Cambridge fell, however, upon Stoke College. Its estate was confiscated, but subject to a charge of £40 per annum as compensation. The purchaser was Sir John Cheke, Parker's personal friend, by whom the money was regularly paid to the former dean. Parker now entered upon the married state, and espoused a Norfolk lady named Margaret Harleston. His choice appears to have been singularly fortunate. His wife proved a true helpmate, and was distinguished for the graceful hospitality she extended to the poor clergy whom Parker was in the habit of inviting to the college lodge at Cambridge.

In the measures which marked the further progress of the Reformation during Edward's reign Parker seems to have cordially co-operated. But he had no sympathy with the bigotry which now began to characterize the contending sects of Protestantism abroad; and when Martin Bucer was fain to quit Strasburg, after the failure of his efforts to mediate between the Lutherans and the Zwinglians, the master of Corpus extended to that eminent theologian a cordial welcome to England. During the short time that the latter filled the post of regius professor of divinity at Cambridge, he found in Parker a firm friend, and it was by Parker that his funeral sermon was preached. Parker's services to his party were not unrecognized. He was occasionally appointed to preach before the young king, and was promoted to the deanery of Lincoln and to the prebend of Corringham in that cathedral. On the occasion of Kett's rebellion in Norfolk, happening to be in Norwich, he visited the rebels'

camp and ventured to preach submission to the constituted authorities.

When Queen Mary ascended the throne, most of the college heads at Cambridge were deprived of office, and Parker only forestalled a like fate by resignation. The fact of his being a married man alone sufficed to entail the loss of all his ecclesiastical preferments. He did not, however, like many of the leaders of his party, fly from the country, but lived in strict retirement, his place of residence being a secret which appears to have died with him. This feature in his career is deserving of note, as offering an important point of contrast to the experiences of those other eminent churchmen who, known as the Marian exiles, returned to England after a long sojourn at the chief centres of the Reformed party on the Continent, strongly prejudiced in favour of Calvinistic doctrine, and bigotedly intolerant of everything approaching to the Roman discipline and ritual. Parker, like Whitgift, stayed in England, and was thus probably better able afterwards to maintain a fairly impartial position in relation to contending religious parties. He himself speaks of these years of his life, passed as they were in solitude among his books and in meditation, but cheered by the possession of a clear conscience, as productive of far more solid enjoyment than he afterwards found in the varied duties and anxieties of the episcopal office.

A fall from horseback, when he was on one occasion compelled to flee by night from Mary's emissaries, resulted in a permanent injury (his language appears to imply a rupture) which still further disinclined him to active and laborious public duties; and upon Elizabeth's accession he evinced little readiness to avail himself of prospects of preferment held out by Sir Nicholas Bacon, the lord keeper. He believed himself to be summoned by duty to return to his former sphere of labour at Cambridge, at that time, like Oxford, in a singularly depressed and unsatisfactory condition. "Of all places in England," he writes to Bacon, "I would wish to bestow most of my time in the university, the state whereof is miserable at this present." His services were needed, however, for a wider sphere of action; and in December 1558 he was summoned by royal command to London, where it was intimated to him that he was to be appointed to the primacy. His election to the office took place on the first of the following August, and his consecration on the 17th December, in the chapel at Lambeth Palace. He was consecrated by Bishop Barlow, formerly bishop of Bath and Wells, bishop-elect of Chichester; John Scory, formerly bishop of Chichester, bishop-elect of Hereford; Miles Coverdale, late bishop of Exeter; and John Hodgkin, suffragan bishop of Bedford. The delay which took place in his consecration arose from the fact that the three bishops named in the original warrant (Tonstal, Bourne, and Poole) refused to act, and a second warrant was consequently found necessary. In the following century the Romanist party sought, by circulating the "Nag's Head fable," to throw discredit on Parker's consecration by representing that he, together with certain other bishops, was simply ordained, and that too in an irreverent and uncanonical fashion, at a tavern in Fleet Street. The evidence which contravenes this story (see Pocock's edition of Burnet's *History of the Reformation*, vol. v.) is, however, singularly full and satisfactory.

During the fifteen years of his primacy, Parker's best energies were devoted to defining more accurately the discipline and belief of the newly constituted Church of England, and to bringing about a general conformity. The Thirty-Nine Articles were passed by convocation under his presidency in 1562. In the year 1566 he issued his celebrated "Advertisements," "for the due order in the

public administration of common prayers and using the holy sacraments, and for the apparel of all persons ecclesiastical." Notwithstanding that they related mainly to questions of detail and ceremonial, these new regulations excited strenuous opposition from the Puritan party, owing to the fact that, although they enjoined the discontinuance of "gorgeous vestments" and the cope, they prescribed the use of the surplice. It is asserted that they were promulgated by the command of Elizabeth, who subsequently withheld her formal sanction, and permitted the obloquy they evoked to fall on Parker. It is certain that they added materially to the embarrassment of his position. The revised translation of the Scriptures known as the Bishops' Bible (1568 and 1572) owed its origin to Parker, and is regarded by English Churchmen as a valuable service to their communion, from the fact that it served to prevent the adoption of the Geneva Bible until superseded by the authorized version.

The determination which Parker showed to withstand, and if possible repress, the growing boldness of the Puritan party, involved him during the latter years of his primacy in a struggle which was detrimental to his health, his temper, and his reputation. In August 1570 his wife died, and the blow was severely felt. He was still able, however, to discharge with efficiency the duties of his office; and in 1573 he entertained Elizabeth with great splendour and sumptuousness in the grand hall of his palace at Canterbury. Among his last measures of reform are to be noted his personal visitation of the church and chapter at Canterbury, and the drawing up of a series of injunctions for their more efficient regulation, the issuing of a commission for the visitation of his diocese, and the publication of new constitutions for the Court of Arches. In 1575 his health began rapidly to give way, and he died on the 17th May in that year, giving evidence almost to the last of that vigorous intellect and strong will by which he was distinguished throughout life.

As an author, Parker cannot be held entitled to any high place. He compiled a Latin treatise, *De Antiquitate Britannicæ Ecclesiæ et Privilegiis Ecclesiæ Cantuariensis*, printed by John Day in 1572, which shows considerable research in connexion with the circumstances under which Christianity was introduced into Britain. In this, however, as in most of his more learned works, he was probably largely assisted by his secretary, Josselin. His letters, which have been published under the title of the *Parker Correspondence* (Parker Society, 1858), are marked throughout by his usual natural good sense and sobriety of judgment, but are characterized neither by originality nor brilliancy of thought. His other writings are chiefly statutes for various ecclesiastical or collegiate foundations, sermons, forms of prayer, and ordinances for the church.

As an editor, while his industry must be admitted by all, he had but an imperfect sense of the responsibilities attaching to such a function and of the limits to be observed in its exercise. He edited *Elfric's Anglo-Saxon Homily*, a treatise much valued by religious controversialists as exhibiting the theory of the early English Church in relation to the doctrine of transubstantiation. The treatise of Gildas, *De Excidio Britannicæ*, next appeared; but this was mainly, if not entirely, the work of Josselin. The *Flora Historiarum* (probably the work of Roger of Wendover) was edited by Parker under the belief that it was the work of an unknown "Matthew of Westminster." The other chronicles which he published were the *Historia Major* of Matthew Paris, the *Historia Anglica* of Walsingham, the life of Alfred (*Gesta Alfredi*) of Asser, and the *Itinerarium* of Giraldus Cambrensis. The extreme licence in which he indulged in altering the texts of these writers, and especially that of Matthew Paris, renders his editions, however, almost worthless, and has met with the severest censures from succeeding historical scholars.

But, notwithstanding these errors and defects, Parker's memory must ever be venerated by Englishmen and by scholars; and his country, his university, and his college were alike laid by him under no ordinary debt of gratitude. He revived the study of Saxon literature and of the *origines* of our national history; and the *scriptorium* which he maintained at Lambeth (after the fashion of the mediæval monasteries) was a busy scene where the transcriber, the illuminator, the engraver, and the bookbinder each plied his craft, to the no small advantage of letters and of art. Among the printers whom he patronised were Richard Juge, John Day,

and Richard Grafton. As a collector of books and manuscripts he was indefatigable; and one of his numerous agents, named Batman, is stated to have collected in four years no less than 6700 volumes, chiefly works which had been scattered on the dissolution of the monasteries. The greater part of this splendid collection, styled by Fuller "the sun of English antiquity," Parker bequeathed to Corpus Christi College. His interest in his university at large did not diminish after his elevation to the archbishopric, and the Regent Walk (an improved approach to the public schools) and the university library were long-standing memorials of his munificence. He also founded a grammar school at Rochdale, and numerous scholarships and annual charities elsewhere. That he died rich cannot be denied; and his enemies have asserted that he was far from scrupulous in the means which he employed in acquiring wealth, especially in "admitting children to eures." On the other hand, it must be allowed that he made a good and generous use of his wealth, and his contemporary biographer claims for him the rare merit of combining strict economy with liberality. Parker had five children. Of these the eldest, John, who was knighted by King James in 1608, alone survived him; he died at Cambridge in 1620, in great want, the cost of his funeral being defrayed by Corpus Christi College.

The best source of information in all that relates to Parker is his *Life and Acts*, by Styrpe (2 vols., Oxford, 1824), a performance on which that distinguished antiquary bestowed even more than his usual amount of painstaking research. A copy of the folio edition (1711), preserved in the library of St John's College, Cambridge, is enriched with numerous and valuable MS. notes by the donor, the eminent Thomas Baker. The titles of the books which he presented to his own college will be found in Nassmith's *Cat. of the C.C. MSS.* (1777). (J. B. M.)

PARKER, THEODORE (1810-1860), a distinguished American rationalistic preacher and social reformer, born at Lexington, Massachusetts, August 24, 1810, was the youngest of eleven children. His father, John Parker, a small farmer and skilful mechanic, was a typical New England yeoman, a man of sterling moral worth, of strong intellect, meditative, and fond of reading,—a strict disciplinarian in his house, a Unitarian in his theology before Unitarianism was known in New England as a system, and a Federalist in his politics when there were but four Federalists in Lexington. His mother, "an imaginative, delicate-minded, poetic, yet very practical woman," took great pains with the religious education of her children, "caring, however, but little for dogmas," and making religion to consist of love and good works. Theodore's paternal grandfather, Captain John Parker, fired the first shot upon the British at the battle of Lexington, commanding on that occasion a troop of seventy men. The historic musket from which that shot was fired became one of the most valued ornaments of the grandson's study. His mother taught him to listen to the monitions of conscience as the voice of God, and from his infancy his life was dominated by moral and religious emotions and ideas of overpowering force. The boy was richly endowed intellectually and physically. His memory was marvelously retentive. The acquisition of languages was a delight and recreation to him. He obtained the elements of knowledge in the schools of the district, which were open during the winter months only. During the rest of the year he worked on his father's farm. He was all the time an immense and omnivorous reader, and his powerful memory enabled him to remember all that he read. At the age of seventeen he became himself a winter schoolmaster, and in his twentieth year he entered himself at Harvard, working on the farm as usual while he followed his studies, and going over to Cambridge for the examination only. For the theological course he took up in 1834 his residence in the college, meeting his expenses by a small sum amassed by school-keeping and by help from a poor students' fund. He studied fourteen hours a day, not only following the usual course of the college, but plunging deep into German theology and Biblical criticism, and especially the history of non-Christian religions. At the close of his college career he began his translation of *De Wetste's Introduction to the Old Testament*. His journal and letters show that he had made acquaintance with a large number of languages, including Hebrew, Chaldee, Syriac, Arabic, Coptic, Ethiopic, as well as the classical and the

principal modern European languages. When he entered the divinity school he was an orthodox Unitarian; when he left it, he entertained strong doubts about the infallibility of the Bible, the possibility of miracles, and the exclusive claims of Christianity and the church. Emerson's transcendentalism greatly influenced him, and Strauss's *Leben Jesu* left its mark upon his thought. His first ministerial charge was over a small village parish, Roxbury, a few miles from Boston. He was ordained June 1837, and held his pastorate there until the autumn of 1843. He was extremely happy in his position. His parishioners loved him, he had ample time to pursue his studies, and the neighbourhood of Boston gave him congenial society. His views were slowly assuming the form which subsequently found such strong expression in his writings; but the process was slow, and the cautious reserve of his first rationalistic utterances was in striking contrast with his subsequent rashness. But in 1841 he preached at Boston a sermon on "the transient and permanent in Christianity," which presented in embryo the main principles and ideas of his final theological position, and the preaching of which determined his subsequent relations to the churches with which he was connected and to the whole ecclesiastical world. The only permanent element he discovered in the Bible, in Christianity, in Christ, was "absolute, pure morality, absolute, pure religion, the love of man, the love of God acting without let or hindrance." He denied all special authority to the Bible, to Christ, to Christianity. He maintained that "Jesus had not exhausted the fitness of God." The Boston Unitarian clergy denounced the preacher, and declared that the "young man must be silenced." No Unitarian publisher could be found for his sermon, and nearly all the pulpits of the city were closed against him. To exchange with him was fatal to a minister's reputation for Unitarian orthodoxy. But when the Unitarian clergy cast Parker off the laity took him up. A number of gentlemen in Boston invited him to give a series of lectures there. The result was that he delivered in the Masonic Hall, in the winter of 1841-42, as lectures, substantially the volume afterwards published as the *Discourses of Matters pertaining to Religion*. The lectures in their published form made his name famous throughout America and Europe, and confirmed the stricter sect of the American Unitarians in their attitude towards him and his supporters. His friends, however, resolved that he should be heard in Boston. They engaged for him the Music Hall in that city, in which he regularly preached to a congregation of some three thousand persons during the remaining fourteen years of his life. Previous to his removal from Roxbury to Boston, Parker spent a year in Europe, calling in Germany upon Paulus, Gervinus, De Wette, and Ewald amongst other savants, and preaching in Liverpool in the pulpits of James Martineau and J. H. Thom. Soon after his return, in 1844, to America he resigned his charge at Roxbury, and devoted himself exclusively to his work in Boston. In addition to his Sunday labours, he lectured throughout the States, and prosecuted his wide studies, collecting particularly the materials for an *opus magnum* on the development of religion in mankind. Above all he took up the question of the emancipation of the slaves, and at the imminent risk of his life nobly and powerfully advocated in Boston and throughout the States, from the platform and through the press, the cause of the negroes. Indeed, he did more. He assisted actively in the escape of fugitive slaves, and helped to furnish John Brown with means for carrying out his schemes of liberation. His Sunday sermons were themselves often elaborate essays, almost treatises, on great questions of social and political reform, and he was all along contributing articles and papers on literary,

political, social, and theological subjects to the periodical press. By his voice, his pen, and his utterly fearless action in social and political matters, he became a great power in Boston and America generally. But his days were numbered. From his mother he inherited consumption, and the reckless disregard of the laws of health which he was guilty of in his early years, combined with the tremendous strain of his ordinary work, and the terrible privations and fatigues of his lecturing tours, developed in the prime of his life the fatal seeds. In January 1859 he had an attack of bleeding of the lungs, and sought relief by retreating first to Santa Cruz, and afterwards to Europe. He died at Rome, May 10, 1860.

The fundamental articles of Parker's religious faith were the three "instinctive intuitions" of God, of a moral law, and of immortality. His own mind, heart, and life were undoubtedly pervaded, sustained, and ruled by the feelings, convictions, and hopes which he formulated in these three articles. But he cannot be said to have achieved success when he came to strictly define, expound, and establish them. In his doctrine of God as maintains that man has an innate idea of God as a being of infinite power, goodness, and wisdom; but he often uses language which borders on pantheism, while his criterion of the notions men have formed of the Divine Being appears to leave him no foundation for anything higher than an abstract pantheistic idea of Him. His proof of his fundamental creed is no less at fault than his statement and exposition of it. It is strange that a man who had read so widely and honestly the best literature of his day on the religious ideas of mankind should have referred to the *consensus gentium* for his main proof of the universality of his triad of religious ideas. His own chapter on the immortality of the soul in his *Discourses* abundantly illustrates the weakness of his proof from induction. The distinction he was compelled to draw between the conception and the idea of God illustrates the weakness of his deductive proof. Parker's definitions of religion are various, and show that he had never closely traced its true nature. Of revelation—the counterpart of religion—his notions were of the vaguest description. He could ask "Is Newton less inspired than Simon Peter?" He had never formed any approximately just conception of the work of a great religious teacher, and could say, "Christianity, if true at all, would be just as true if Herod or Catiline had taught it." Naturally, therefore, he never formed an adequate idea of the place of Christianity amongst the world's religions, though he often used language about Christ which in the case of a closer thinker would have indicated the acceptance of Christianity as the absolute and final religion for man. But in truth Parker was more of a speaker than a thinker, of a reformer than a philosopher. He had a wide and firm grasp of facts and principles, but his thought was neither profound nor subtle, neither accurate nor self-consistent. Although rich in poetic elements, he was singularly defective, too, in artistic faculty. He has produced nothing that is perfect in form, while all his works are disfigured by outrageous violations of taste and good feeling. But with all his numerous defects Parker ranks amongst America's great and noble sons, and may perhaps obtain finally a place amongst the world's great men. A future biographer will have to assign him his final position. The three biographies which at present exist—Weiss's (1868), Frothingham's (1874), and Dean's (1877)—are the work of eager partisans and admiring panegyrists rather than of calm critics and historians.

Parker's principal works are *A Discourse on Matters pertaining to Religion*, 1842; *Ten Sermons of Religion*, 1859; *Schem, Atheism, and the Populair Theology*, 1863. A collected edition of his works has been published in England by Frances Power Cobbe, in 12 vols. A German translation of part of his works was made by Zethen, Leipzig, 1864-67. Valuable reviews of his theological position and of his character and work have appeared—by James Martineau, in the *National Review* (April 1860), and J. H. Thom, in the *Theological Review* (March 1864).

PARKERSBURG, a city of the United States, next to Wheeling the largest city in West Virginia, is the capital of Wood county, and lies on the left bank of the Ohio, at the mouth of the Little Kanawha. It is the western terminus of the Baltimore and Ohio Railroad, and is connected by a fine railway bridge (1½ miles in length, and constructed at a cost of more than \$1,000,000 in 1869-1871) with Belpré, where the Marietta and Cincinnati Railroad begins. Steamers ply both on the Ohio and the Little Kanawha (rendered navigable for 88 miles). The staple industry is the refining of petroleum, but there are also foundries, flour-mills, saw-mills, brickyards (most of the buildings are of brick), &c. The population was 2493 in 1860, 5546 in 1870, and 6582 in 1880. As a town Parkersburg dates from 1820, as a city from 1860.

## P A R L I A M E N T

THE British Parliament is the supreme legislature of the United Kingdom of Great Britain and Ireland, consisting of the King, or Queen, and the three estates of the realm, viz., the Lords Spiritual, the Lords Temporal, and the Commons.

## HISTORY.

An inquiry into the early growth and later development of this powerful institution presents at once an interesting historical study and profound political instruction. Its great antiquity, its continuous but ever-changing life, and the social and political causes which have shaped its present constitution and authority are themes which can never fail to attract the historian and the statesman; while speculations regarding its future course concern the destinies of the British empire.

*The Anglo-Saxon Polity.*—The origin of parliament is to be traced to Anglo-Saxon times. The Angles, Saxons, and other Teutonic races who conquered Britain brought to their new homes their own laws and customs, their settled framework of society, their kinship, their village communities, and a certain rude representation in local affairs. And we find in the Anglo-Saxon polity, as developed during their rule in England, all the constituent parts of parliament. In their own lands they had chiefs and leaders, but no kings. But conquest and territorial settlement were followed by the assumption of royal dignities; and the victorious chiefs were accepted by their followers as kings. They were quick to assume the traditional attributes of royalty. A direct descent from their god Woden, and hereditary right, at once clothed them with a halo of glory and with supreme power; and, when the pagan deity was deposed, the king received consecration from a Christian archbishop, and was invested with sacred attributes as "the Lord's anointed." But the Saxon monarch was a patriarchal king of limited authority, who acted in concert with his people; and, though his succession was hereditary, in his own family, his direct descendant was liable to be passed over in favour of a worthier heir. Such a ruler was a fitting precursor of a line of constitutional kings, who in later times were to govern with the advice and consent of a free parliament.

Meanwhile, any council approaching the constitution of a House of Lords was of slow growth. Anglo-Saxon society, indeed, was not without an aristocracy. The highest in rank were *sethings*—generally, if not exclusively, sons and brothers of the king. The *ealdorman*, originally a high officer, having the executive government of a shire, and a seat in the king's *witan*, became hereditary in certain families, and eventually attained the dignity of an earl. But centuries were to pass before the English nobility was to assume its modern character and denominations. At the head of each village was an earl, the chief of the freemen, or *ceorls*—their leader in war and patron in peace. The king's *gesiths* and *thegns* formed another privileged class. Admitted to offices in the king's household and councils, and enriched by grants of land, they gradually formed a feudal nobility.

The revival of the Christian church, under the Anglo-Saxon rule, created another order of rulers and councillors, destined to take a leading part in the government of the state. The archbishops and bishops, having spiritual authority in their own dioceses, and exercising much local influence in temporal affairs, were also members of the national council, or *witenagemót*, and by their greater

learning and capacity were not long in acquiring a leading part in the councils of the realm. Ecclesiastical councils were also held, comprising bishops, abbots, and clergy, in which we observe the origin of convocation. The abbots, thus associated with the bishops, also found a place with them in the *witenagemót*. By these several orders, summoned to advise the king in affairs of state, was formed a council of magnates—to be developed, in course of time, into an Upper Chamber, or House of Lords.

The rise of the commons, as a political power in the national councils, was of yet slower development; but in the Anglo-Saxon moots may be discerned the first germs of popular government in England. In the town-moot the assembled freemen and cultivators of the "folk-lands" regulated the civil affairs of their own township, tithing, village, or parish. In the burgh-moot the inhabitants administered their municipal business, under the presidency of a reeve. The hundred-moot assumed a more representative character, comprising the reeve and a selected number of freemen from the several townships and burghs within the hundred. The shire-moot, or shire-gemót, was an assembly yet more important. An *ealdorman* was its president, and exercised a jurisdiction over a shire, or district comprising several hundreds. Attended by a reeve and four freemen from every hundred, it assumed a distinctly representative character. Its members, if not elected by the popular voice, were, in some fashion, deputed to act on behalf of those whose interests they had come to guard. The shire-moot was also the general folk-moot of the tribe, assembled in arms, to whom their leaders referred the decision of questions of peace and war.

Superior to these local institutions was the *witenagemót*, or assembly of wise men, with whom the king took counsel in legislation and the government of the state. This national council was the true beginning of the parliament of England. Such a council was originally held in each of the kingdoms commonly known as the Heptarchy; and after their union in a single realm, under King Edgar, the *witenagemót* became the deliberative and legislative assembly, or parliament, of the extended estate.

The *witenagemót* made laws, imposed taxes, concluded treaties, advised the king as to the disposal of public lands and the appointment and removal of officers of state, and even assumed to elect and depose the king himself. The king had now attained to greater power, and more royal dignities and prerogatives. He was unquestionably the chief power in the *witenagemót*; but the laws were already promulgated, as in later times, as having been agreed to with the advice and consent of the *witan*. The *witan* also exercised jurisdiction as a supreme court. These ancient customs present further examples of the continuity of English constitutional forms.

The constitution of the *witenagemót*, however, was necessarily less popular than that of the local moots in the hundred or the shire. The king himself was generally present; and at his summons came prelates, abbots, *ealdormen*, the king's *gesiths* and *thegns*, officers of state and of the royal household, and leading tenants in chief of lands held from the crown. Crowds sometimes attended the meetings of the *witan*, and shouted their acclamations of approval or dissent; and, so far, the popular voice was associated with its deliberations; but it was at a distance from all but the inhabitants of the place in which it was assembled, and until a system of representation had slowly grown up there could be no further admission of the

people to its deliberations. In the town-moot the whole body of freemen and cultivators of the folk-lands met freely under a spreading oak, or on the village green; in the hundred-moot, or shire-gemót, deputies from neighbouring communities could readily find a place; but all was changed in the wider council of a kingdom. When there were many kingdoms, distance obstructed any general gathering of the commons; and in the wider area of England such a gathering became impossible. Centuries were yet to pass before this obstacle was to be overcome by representation; but, in the meantime, the local institutions of the Anglo-Saxons were not without their influence upon the central council. The self-government of a free people informed the bishops, ealdormen, eorls, and thegns who dwelt among them of their interests and needs, their sufferings and their wrongs; and, while the popular forces were increasing with an advancing society, they grew more potential in the councils of their rulers. Some writers, naturally sympathizing with every tradition of English liberty, have discovered proofs of an earlier representation; but popular franchises are now too firmly established to need support from doubtful traces of antiquity.

Another circumstance must not be overlooked in estimating the political influence of the people in Anglo-Saxon times. For five centuries the country was convulsed with incessant wars—wars with the Britons, whom the invaders were driving from their homes, wars between the several kingdoms, wars with the Welsh, wars with the Picts, wars with the Danes. How could the people continue to assert their civil rights amid the clash of arms and a frequent change of masters? The warrior-kings and their armed followers were rulers in the land which they had conquered.

At the same time the unsettled condition of the country repressed the social advancement of its people. Agriculture could not prosper when the farm of the husbandman too often became a battlefield. Trade could not be extended without security to property and industry. Under such conditions the great body of the people continued as peasants, handicraftsmen, and slaves. The time had not yet come when they could make their voice heard in the councils of the state.

*The Norman Conquest.*—The Anglo-Saxon polity was suddenly overthrown by the Norman Conquest. A stern foreign king had seized the crown, and was prepared to rule his conquered realm by the sword. He brought with him the absolutist principles of Continental rulers, and the advanced feudal system of France and Normandy. Feudalism had been slowly gaining ground under the Saxon kings, and now it was firmly established as a military organization. William the Conqueror at once rewarded his warlike barons and followers with enormous grants of land. The Saxon landowners and peasants were despoiled, and the invaders settled in their homesteads. The king claimed the broad lands of England as his own, by right of conquest; and when he allowed his warriors to share the spoil he attached the strict condition of military service in return for every grant of land. An effective army of occupation of all ranks was thus quartered upon every province throughout the realm. England was held by the sword; a foreign king, foreign nobles, and a foreign soldiery were in possession of the soil, and swore fealty to their master, from whom they held it. Saxon bishops were deposed, and foreign prelates appointed to rule over the English Church. Instead of calling a national witenagemót, the king took counsel with the officers of his state and household, the bishops, abbots, earls, barons, and knights by whom he was pleased to surround himself. Some of the forms of a national council

were indeed maintained, and its counsel and consent were proclaimed in the making of laws; but, in truth, the king was absolute.

Such a revolution seemed fatal to the liberties and ancient customs of Saxon England. What power could withstand the harsh conqueror? But the indestructible elements of English society prevailed over the sword. The king grasped, in his own hands, the higher administration and judicature of the realm; but he continued the old local courts of the hundred and the shire, which had been the basis of Saxon freedom. The Norman polity was otherwise destined to favour the liberties of the people, through agencies which had been designed to crush them. The powerful nobles, whom William and his successors exalted, became formidable rivals of the crown itself; while ambitious barons were in their turn held in check by a jealous and exacting church. The ruling powers, if combined, would have reduced the people to slavery; but their divisions proved a continual source of weakness. In the meantime the strong rule of the Normans, bitter as it was to Englishmen, repressed intestine wars and the disorders of a divided realm. Civil justice was fairly administered. When the spoils of the conquerors had been secured, the rights of property were protected, industry and trade were left free, and the occupation of the soil by foreigners drove numbers of landowners and freemen into the towns, where they prospered as merchants, traders, and artificers, and collected thriving populations of townsmen. Meanwhile, foreign rulers having brought England into closer relations with the Continent, its commerce was extended to distant lands, ports and shipping were encouraged, and English traders were at once enriched and enlightened. Hence new classes of society were growing, who were eventually to become the commons of England.

*The Crown, the Barons, the Church, and the People.*—While these social changes were steadily advancing, the barons were already preparing the way for the assertion of popular rights. Ambitious, turbulent, and grasping, they were constantly at issue with the crown. Enjoying vast estates and great commands, and sharing with the prelates the government of the state, as members of the king's council, they were ever ready to raise the standard of revolt. The king could always count upon barons faithful to his cause, but he also appealed for aid to the church and the people. The baronage was thus broken by insurrections, and decimated by civil wars, while the value of popular alliances was revealed. The power of the people was ever increasing, while their oppressors were being struck down. The population of the country was still Saxon; they had been subdued, but had not been driven forth from the land, like the Britons in former invasions. The English language was still the common speech of the people; and Norman blood was being mingled with the broader stream of Saxon life. A continuous nationality was thus preserved, and was outgrowing the foreign element.

The crown was weakened by disputed successions and foreign wars, and the baronage by the blood-stained fields of civil warfare; while both in turn looked to the people in their troubles. Meanwhile the church was struggling, alike against the crown and the barons, in defence of its ecclesiastical privileges and temporal possessions. Its clergy were brought by their spiritual ministrations into close relations with the people, and their culture contributed to the intellectual growth of English society. When William Rufus was threatened by his armed barons, he took counsel with Archbishop Lanfranc, and promised good laws and justice to the people. His promises were broken; but, like later charters, as lightly set aside, they

were a recognition of the political rights of the people. By the charter of Henry I. restoring to the people the laws of Edward the Confessor, the continuity of English institutions was acknowledged; and this concession was also proclaimed through Archbishop Anselm, the church and the people being again associated with the crown against the barons. And throughout his reign the clergy and the English people were cordially united in support of the crown. In the anarchic reign of Stephen—also distinguished by its futile charters—the clergy were driven into opposition to the king, while his oppressions alienated the people. Henry II. commenced his reign with another charter, which may be taken as a profession of good intentions on the part of the new king. So strong-willed a king, who could cripple his too powerful nobles, and forge shackles for the church, was not predisposed to extend the liberties of his people; but they supported him loyally in his critical struggles; and his vigorous reforms in the administrative, judicial, and financial organisation of his realm promoted the prosperity and political influence of the commons. At the same time the barons created in this and the two previous reigns, being no longer exclusively Norman in blood and connexion, associated themselves more readily with the interests and sympathies of the people. Under Richard I. the principle of representation was somewhat advanced, but it was confined to the assessment and collection of taxes in the different shires.

*The Great Charter.*—It was under King John that the greatest progress was made in national liberties. The loss of Normandy served to draw the baronage closer to the English people; and the king soon united all the forces of the realm against him. He outraged the church, the barons, and the people. He could no longer play one class against another; and they combined to extort the Great Charter of their liberties at Runnymede. It was there ordained that no scutage or aid, except the three regular feudal aids, should be imposed, save by the common council of the realm. To this council the archbishops, bishops, abbots, earls, and greater barons were to be summoned personally by the king's letters, and tenants in chief by a general writ through the sheriff. The summons was required to appoint a certain place, to give forty days' notice at least, and to state the cause of meeting. At length we seem to reach some approach to modern usage.

*Growth of the Commons.*—The improved administration of successive kings had tended to enlarge the powers of the crown. But one hundred and fifty years had now passed since the Conquest, and great advances had been made in the condition of the people, and more particularly in the population, wealth, and self-government of towns. Many had obtained royal charters, elected their own magistrates, and enjoyed various commercial privileges. They were already a power in the state, which was soon to be more distinctly recognized.

The charter of King John was again promulgated under Henry III., for the sake of a subsidy; and henceforth the commons learned to insist upon the redress of grievances in return for a grant of money. This reign was memorable in the history of parliament. Again the king was in conflict with his barons, who rebelled against his gross misgovernment of the realm. Simon de Montfort, earl of Leicester, was a patriot, in advance of his age, and fought for the English people as well as for his own order. The barons, indeed, were doubtful allies of the popular cause, and leaned to the king rather than to Simon. But the towns, the clergy, the universities, and large bodies of the commonalty rallied round him, and he overthrew the king and his followers at Lewes. He was now master of the realm, and proclaimed a new constitution. Kings had

made promises, and granted illusory charters; but the rebel earl called an English parliament into being. Churchmen were on his side, and a few barons; but his main reliance was upon the commons. He summoned to a national council, or parliament, bishops, abbots, earls, and barons, together with two knights from every shire and two burgesses from every borough. Knights had been summoned to former councils; but never until now had representatives from the towns been invited to sit with bishops, barons, and knights of the shire.

In the reign of Edward I. parliament assumed substantially its present form of king, lords, and commons. The irregular and unauthorized scheme of Simon de Montfort was fully adopted in 1295, when the king himself summoned to a parliament two knights from every shire, elected by the freeholders at the shire court, and two burgesses from every city, borough, and leading town. The rebel earl had enlarged the basis of the national council; and, to secure popular support, the politic king accepted it as a convenient instrument of taxation. The knights and freeholders had increased in numbers and wealth; and the towns, continually advancing in population, trade, and commerce, had become valuable contributors to the revenue of the state. The grant of subsidies to the crown, by the assembled baronage and representatives of the shires and towns, was a legal and comprehensive impost upon the entire realm.

*Secession of the Clergy.*—It formed part of Edward's policy to embrace the clergy in his scheme for the representation of all orders and classes of his subjects. They were summoned to attend the parliament of 1295 and succeeding parliaments of his reign, and their form of summons has been continued until the present time; but the clergy resolutely held aloof from the national council, and insisted upon voting their subsidies in their own convocations of Canterbury and York. The bishops retained their high place among the earls and barons, but the clergy sacrificed to ecclesiastical jealousies the privilege of sharing in the political councils of the state. As yet, indeed, this privilege seemed little more than the voting of subsidies, but it was soon to embrace the redress of grievances and the framing of laws for the general welfare of the realm. This great power they forfeited; and who shall say how it might have been wielded, in the interests of the church, and in the legislation of their country? They could not have withstood the Reformation; they would have been forced to yield to the power of the crown and the heated resolution of the laity; but they might have saved a large share of the endowments of the church, and perhaps have modified the doctrines and formularies of the reformed establishment.

*Reluctance of the Commons to Attend.*—Meanwhile the commons, unconscious of their future power, took their humble place in the great council of the realm. The knights of the shire, as lesser barons, or landowners of good social standing, could sit beside the magnates of the land without constraint; but modest traders from the towns were overawed by the power and dignity of their new associates. They knew that they were summoned for no other purpose than the taxing of themselves and their fellow townsmen; their attendance was irksome; it interrupted their own business; and their journeys exposed them to many hardships and dangers. It is not surprising that they should have shrunk from the exercise of so doubtful a privilege. Considerable numbers absented themselves from a thankless service; and their constituents, far from exacting the attendance of their members, as in modern times, begrudged the sorry stipend of 2s. a day, paid to their representatives while on duty, and strove to evade the burden imposed upon them by the crown. Some



even purchased charters, withdrawing franchises which they had not yet learned to value. Nor, in truth, did the representation of towns at this period afford much protection to the rights and interests of the people. Towns were enfranchised at the will or caprice of the crown and the sheriffs; they could be excluded at pleasure; and the least show of independence would be followed by the omission of another writ of summons. But the principle of representation, once established, was to be developed with the expansion of society; and the despised burgesses of Edward I., not having seceded, like the clergy, were destined to become a potential class in the parliaments of England.

*Sitting of Parliament at Westminster.*—Another constitutional change during this reign was the summoning of parliament to Westminster instead of to various towns in different parts of the country. This custom invested parliament with the character of a settled institution, and constituted it a high court for the hearing of petitions and the redress of grievances. The growth of its jurisdiction, as a court of appeal, was also favoured by the fixity of its place of meeting.

*Authority of Parliament recognised by Law.*—Great was the power of the crown, and the king himself was bold and statesmanlike; but the union of classes against him proved too strong for prerogative. In 1297, having outraged the church, the barons, and the commons by illegal exactions, he was forced to confirm the Great Charter and the Charter of Forests, with further securities against the taxation of the people without their consent, and, in return, obtained timely subsidies from the parliament.

Henceforth the financial necessities of a succession of kings ensured the frequent assembling of parliaments. Nor were they long contented with the humble function of voting subsidies, but boldly insisted on the redress of grievances and further securities for national liberties. In 1322 it was declared by statute 15th Edward II. that "the matters to be established for the estate of the king and of his heirs, and for the estate of the realm and of the people, should be treated, accorded, and established in parliament, by the king, and by the assent of the prelates, earls, and barons, and the commonalty of the realm, according as had been before accustomed." The constitutional powers of parliament as a legislature were here amply recognized,—not by royal charter, or by the occasional exercise of prerogative, but by an authoritative statute. And these powers were soon to be exercised in a striking form. Already parliament had established the principle that the redress of grievances should have precedence of the grant of subsidies; it had maintained the right of approving councillors of the crown, and punishing them for the abuse of their powers; and in 1327 the king himself was finally deposed, and the succession of his son, Edward III., declared by parliament.

*Union of Knights of the Shire and Burgesses.*—At this period the constitution of parliament was also settling down to its later and permanent shape. Hitherto the different orders or estates had deliberated separately, and agreed upon their several grants to the crown. The knights of the shire were naturally drawn, by social ties and class interests, into alliance with the barons; but at length they joined the citizens and burgesses, and in the first parliament of Edward III. they are found sitting together as "the Commons."

This may be taken as the turning point in the political history of England. If all the landowners of the country had become united as an order of nobles, they might have proved too strong for the development of national liberties, while the union of the country gentlemen with the

burgesses formed an estate of the realm, which was destined to prevail over all other powers. The withdrawal of the clergy, who would probably have been led by the bishops to take part with themselves and the barons, further strengthened the united commons.

*Increasing Influence of Parliament.*—The reign of Edward III. witnessed further advances in the authority of parliament, and changes in its constitution. The king, being in continual need of subsidies, was forced to summon parliament every year, and in order to encourage its liberality he frequently sought its advice upon the most important issues of peace or war, and readily entertained the petitions of the commons praying for the redress of grievances. During this reign also, the advice and consent of the commons, as well as of the lords spiritual and temporal, was regularly recorded in the enacting part of every statute.

*Separation of the Two Houses.*—But a more important event is to be assigned to this reign,—the formal separation of parliament into the two Houses of Lords and Commons. There is no evidence—nor is it probable—that the different estates ever voted together as a single assembly. It appears from the Rolls of Parliament that in the early part of this reign, the causes of summons having been declared to the assembled estates, the three estates deliberated separately, but afterwards delivered a collective answer to the king. While their deliberations were short, they could be conducted apart, in the same chamber; but, in course of time, it was found convenient for the commons to have a chamber of their own, and they adjourned their sittings to the chapter-house of the abbot of Westminster, where they continued to be held after the more formal and permanent separation had taken place. The date of this event is not clearly established, but is generally assigned to the 17th Edward III.

*The Commons as Petitioners.*—Parliament had now assumed its present outward form. But it was far from enjoying the authority which it acquired in later times. The crown was still paramount; the small body of earls and barons—not exceeding forty—were connected with the royal family, or in the service of the king, or under his influence; the prelates, once distinguished by their independence, were now seekers of royal favour; and the commons, though often able to extort concessions in return for their contributions to the royal exchequer, as yet held an inferior position among the estates of the realm. Instead of enjoying an equal share in the framing of laws, they appeared before the king in the humble guise of petitioners. Their petitions, together with the king's answers, were recorded in the Rolls of Parliament; but it was not until the parliament had been discharged from attendance that statutes were framed by the judges, and entered on the statute rolls. Under such conditions legislation was, in truth, the prerogative of the crown rather than of parliament. Enactments were often found in the statutes at variance with the petitions and royal answers, and neither prayed for by the commons nor assented to by the lords. In vain the commons protested against so grave an abuse of royal authority; but the same practice was continued during this and succeeding reigns. Henry V., in the second year of his reign, promised "that nothing should be enacted to the petitions of the commons, contrary to their asking, whereby they should be bound without their assent"; but, so long as the old method of framing laws was adhered to, there could be no security against abuse; and it was not until the reign of Henry VI. that the introduction of the more regular system of legislating by bill and statute ensured the thorough agreement of all the estates in the several provisions of every statute.

*Increasing Boldness of the Commons.*—The commons, however, notwithstanding these and other discouragements, were constantly growing bolder in the assertion of their rights. They now ventured to brave the displeasure of the king, without seeking to shelter themselves behind powerful barons, upon whose forwardness in the national cause they could not reckon. Notably in 1376 their stout Speaker, Peter de la Warr, inveighed, in their name, against the gross mismanagement of the war, impeached ministers of the realm, complained of the heavy burdens under which the people suffered, and even demanded that a true account should be rendered of the public expenditure. The brave Speaker was cast into prison, and a new parliament was summoned which speedily reversed the resolutions of the last. But the death of the king changed the aspect of affairs. Another parliament was called, when it was found that the spirit of the commons was not subdued. Peter de la Warr was released from prison, and again elected to the chair. The demands of the former parliament were reiterated with greater boldness and persistence, the evil councillors of the late reign were driven out, and it was conceded that the principal officers of state should be appointed and removed, during the minority of Richard II., upon the advice of the lords. The commons also insisted upon the annual assembling of parliament under the stringent provisions of a binding law. They claimed the right, not only of voting subsidies, but of appropriating them, and of examining public accounts. They inquired into public abuses, and impeached ministers of the crown. Even the king himself was deposed by the parliament. Thus during this reign all the great powers of parliament were asserted and exercised. The foreign wars of Henry IV. and Henry V., by continuing the financial necessities of the crown, maintained for a while the powers which parliament had acquired by the struggles of centuries.

*Relapse of Parliamentary Influence.*—But a period of civil wars and disputed successions was now at hand, which checked the further development of parliamentary liberties. The effective power of a political institution is determined, not by assertions of authority, nor even by its legal recognition, but by the external forces by which it is supported, controlled, or overborne. With the close of the Wars of the Roses the life of parliament seems to have well-nigh expired.

To this constitutional relapse various causes contributed at the same period. The crown had recovered its absolute supremacy. The powerful baronage had been decimated on the battlefield and the scaffold; and vast estates had been confiscated to the crown. Kings had no longer any dread of their prowess as defenders of their own order or party, or as leaders of the people. The royal treasury had been enriched by their ruin; while the close of a long succession of wars with France and Scotland relieved it of that continual drain which had reduced the crown to an unwelcome dependence upon parliament. Not only were the fortunes of the baronage laid low, but feudalism was also dying out in England as on the Continent. It was no longer a force which could control the crown; and it was being further weakened by changes in the art of war. The mailed horseman, the battle-axe and cross-bow of burgher and yeoman, could not cope with the cannon and arquebus of the royal army.

In earlier times the church had often stood forth against the domination of kings, but now it was in passive submission to the throne. The prelates were attracted to the court, and sought the highest offices of state; the inferior clergy had long been losing their influence over the laity by their ignorance and want of moral elevation, at a period of increasing enlightenment; while the church at large was

weakened by schisms and a wider freedom of thought. Hence the church, like the baronage, had ceased to be a check upon the crown.

Meanwhile what had become of the ever-growing power of the commons? It is true they had lost their stalwart leaders, the armed barons and outspoken prelates, but they had themselves advanced in numbers, riches, and enlightenment; they had overspread the land as knights and freeholders, or dwelt in populous towns enriched by merchandise. Why could they not find leaders of their own? Because they had lost the liberal franchises of an earlier age. All freeholders, or suitors present at the county court, were formerly entitled to vote for a knight of the shire; but in the eighth year of Henry VI. (1430) an Act was passed (c. 37) by which this right was confined to 40s. freeholders, resident in the county. Large numbers of electors were thus disfranchised. In the view of parliament they were "of no value," and complaints had been made that they were under the influence of the nobles and greater landowners; but a popular element had been withdrawn from the county representation, and the restricted franchise cannot have impaired the influence of the nobles.

As for the cities and boroughs, they had virtually renounced their electoral privileges. As we have seen, they had never valued them very highly; and now by royal charters, or by the usurpation of small self-elected bodies of burgesses, the choice of members had fallen into the hands of town councils and neighbouring landowners. The anomalous system of close and nomination boroughs, which had arisen thus early in our history, was suffered to continue without a check for four centuries, as a notorious blot upon our free constitution.

All these changes exalted the prerogatives of the crown. Amid the clash of arms and the strife of hostile parties, the voice of parliament had been stifled; and, when peace was restored, a powerful king could dispense with an assembly which might prove troublesome, and from whom he rarely needed help. Hence for a period of two hundred years, from the reign of Henry VI. to that of Elizabeth, the free parliaments of England were in abeyance. The institution retained its form and constituent parts; its rights and privileges were theoretically recognized, but its freedom and national character were little more than shadows.

*The Three Estates of the Realm.*—This check in the fortunes of parliament affords a fitting occasion for examining the composition of each of the three estates of the realm.

*Lords Spiritual and Temporal.*—The archbishops and bishops had held an eminent position in the councils of Saxon and Norman kings, and many priors and abbots were from time to time associated with them as lords spiritual, until the suppression of the monasteries by Henry VIII. They generally outnumbered their brethren, the temporal peers, who sat with them in the same assembly.

The lords temporal comprised several dignities. Of these the baron, though now the lowest in rank, was the most ancient. The title was familiar in Saxon times, but it was not until after the Norman Conquest that it was invested with a distinct feudal dignity. Next in antiquity was the earl, whose official title was known to Danes and Saxons, and who after the Conquest obtained a dignity equivalent to that of count in foreign states. The highest dignity, that of duke, was not created until Edward III. conferred it upon his son, Edward the Black Prince. The rank of marquis was first created by Richard II., with precedence after a duke. It was in the reign of Henry VI. that the rank of viscount was created, to be placed

between the earl and the baron. Since that time no new dignity has been invented, and the peerage consists of the five dignities of duke, marquis, earl, viscount, and baron. During the 15th century the number of temporal peers summoned to parliament rarely exceeded fifty, and no more than twenty-nine received writs of summons to the first parliament of Henry VII. There were only fifty-nine at the death of Queen Elizabeth. At the accession of William III. this number had been increased to about one hundred and fifty.

*Life Peerages.*—The several orders of the peerage are alike distinguished by the hereditary character of their dignities. Some life peerages, indeed, were created between the reigns of Richard II. and Henry VI., and several ladies had received life peerages between the reigns of Charles II. and George II. The highest authorities had also held that the creation of life peerages was within the prerogative of the crown. But four hundred years had elapsed since the creation of a life peer, entitled to sit in parliament, when Queen Victoria was advised to create Sir James Parke, lately an eminent judge, a baron for life, under the title of Lord Wensleydale. The object of this deviation from the accustomed practice was to strengthen the judicature of the House of Lords, without unduly enlarging the numbers of the peerage. But the lords at once took exception to this act of the crown, and, holding that a prerogative so long disused could not be revived, in derogation of the hereditary character of the peerage, resolved that Lord Wensleydale was not entitled by his letters patent, and writ of summons, to sit and vote in parliament. His lordship accordingly received a new patent, and took his seat as an hereditary peer. But the necessity of some such expedient for improving the appellate jurisdiction of the House of Lords could not be contested; and in 1876 three lords of appeal in ordinary were constituted by statute, enjoying the rank of baron for life, and the right of sitting and voting in the House of Lords so long as they continue in office.

*The Commons.*—The commons formed a more numerous body. In the reign of Edward I. there were about 275 members, in that of Edward III. 250, and in that of Henry VI. 300. In the reign of Henry VIII. parliament added 27 members for Wales and 4 for the county and city of Chester, and in the reign of Charles II. 4 for the county and city of Durham. Between the reigns of Henry VIII. and Charles II. 130 members were also added by royal charter.

*Parliament under Henry VIII.*—To resume the history of parliament at a later period, let us glance at the reign of Henry VIII. Never had the power of the crown been greater than when this king succeeded to the throne, and never had a more imperious will been displayed by any king of England. Parliament was at his feet to do his bidding, and the Reformation enormously increased his power. He had become a pope to the bishops; the old nobles who had resisted his will had perished in the field or on the scaffold; the new nobles were his creatures; and he had the vast wealth of the church in his hands as largesses to his adherents. Such was the dependence of parliament upon the crown and its advisers during the Reformation period that in less than thirty years four vital changes were decreed in the national faith. Each of the successive reigns inaugurated a new religion.

*Queen Elizabeth and her Parliaments.*—With the reign of Elizabeth commenced a new era in the life of parliament. She had received the royal prerogatives unimpaired, and her hand was strong enough to wield them. But in the long interval since Edward IV. the entire framework of English society had been changed; it was a new England

that the queen was called upon to govern. The coarse barons of feudal times had been succeeded by English country gentlemen, beyond the influence of the court, and identified with all the interests and sympathies of their country neighbours. From this class were chosen nearly all the knights of the shire, and a considerable proportion of the members for cities and boroughs. They were generally distinguished by a manly independence, and were prepared to uphold the rights and privileges of parliament and the interests of their constituents. A change no less remarkable had occurred in other classes of society. The country was peopled with yeomen and farmers, far superior to the cultivators of the soil in feudal times; and the towns and seaports had grown into important centres of commerce and manufactures. Advances not less striking had been made in the enlightenment and culture of society. But, above all, recent religious revolutions had awakened a spirit of thought and inquiry, by no means confined to questions of faith. The Puritans, hostile to the church, and jealous of every semblance of Catholic revival, were embittered against the state, which was identified, in their eyes, with many ecclesiastical enormities; and their stubborn temper was destined to become a strong motive force in restoring the authority of parliament.

The parliaments of Elizabeth, though rarely summoned, displayed an unaccustomed spirit. They discussed the succession to the crown, the marriage of the queen, and ecclesiastical abuses; they upheld the privileges of the commons, and their right to advise the crown upon all matters of state; and they condemned the grant of monopolies. The bold words of the Wentworths and Yelvertons were such as had not been heard before in parliament. The conflicts between Elizabeth and the commons marked the revival of the independence of parliament, and foreshadowed graver troubles at no distant period.

*Conflicts of James I. with the Commons.*—James I., with short-sighted pedantry, provoked a succession of conflicts with the commons, in which abuses of prerogative were stoutly resisted and the rights and privileges of parliament resolutely asserted. The "remonstrances" of 1610 and the "protestation" of 1621 would have taught a politic ruler that the commons could no longer be trifled with; but those lessons were lost upon James and upon his ill-fated son.

*Charles I. and the Commonwealth.*—The momentous struggles between Charles I. and his parliaments cannot be followed in this place. The earlier parliaments of this reign fairly represented the earnest and temperate judgment of the country. They were determined to obtain the redress of grievances, and to restrain undue prerogatives; but there was no taint of disloyalty to the crown; there were no dreams of revolution. But the contest at length became embittered, until there was no issue but the arbitrament of the sword. The civil war and the commonwealth, however memorable in the history of England, are beyond the range of this narrative. But this period proved the supreme power of the commons, when supported by popular forces. Everything gave way before them. They raised victorious armies in the field, they overthrew the church and the House of Lords, and they brought the king himself to the scaffold. It also displayed the impotence of a parliament which has lost the confidence of the country, or is overborne by mobs, by an army, or by the strong will of a dictator.

*Political Agitation of this Period.*—It is to this time of fierce political passions that we trace the origin of political agitation, as an organized method of influencing the deliberations of parliament. The whole country was then aroused by passionate exhortations from the pulpit and in the press. No less than thirty thousand political

tracts and newspapers during this period have been preserved. Petitions to parliament were multiplied in order to strengthen the hands of the popular leaders. Clamorous meetings were held to stimulate or overawe parliament. Such methods, restrained after the Restoration, have been revived in later times, and now form part of the acknowledged system of parliamentary government.

*Parliament after the Restoration.*—On the restoration of Charles II. parliament was at once restored to its old constitution, and its sittings were revived as if they had suffered no interruption. No outward change had been effected by the late revolution; but that a stronger spirit of resistance to abuses of prerogative had been aroused was soon to be disclosed in the deposition of James II. and the "glorious revolution" of 1688. At this time the full rights of parliament were explicitly declared, and securities taken for the maintenance of public liberties. The theory of a constitutional monarchy and a free parliament was established; but after two revolutions it is curious to observe the indirect methods by which the commons were henceforth kept in subjection to the crown and the territorial aristocracy. The representation had long become an illusion. The knights of the shire were the nominees of nobles and great landowners; the borough members were returned by the crown, by noble patrons, or close corporations; even the representation of cities, with greater pretensions to independence, was controlled by bribery. Nor were rulers content with their control of the representation, but, after the Restoration, the infamous system of bribing the members themselves became a recognized instrument of administration. The country gentlemen were not less attached to the principles of rational liberty than their fathers, and would have resisted further encroachments of prerogative; but they were satisfied with the Revolution settlement and the remedial laws of William III., and no new issue had yet arisen to awaken opposition. Accordingly, they ranged themselves with one or other of the political parties into which parliament was now beginning to be divided, and bore their part in the more measured strifes of the 18th century. From the Revolution till the reign of George III. the effective power of the state was wielded by the crown, the church, and the territorial aristocracy; but the influence of public opinion since the stirring events of the 17th century had greatly increased. Both parties were constrained to defer to it; and, notwithstanding the flagrant defects in the representation, parliament generally kept itself in accord with the general sentiments of the country.

*Union of Scotland.*—On the union of Scotland in 1707, important changes were made in the constitution of parliament. The House of Lords was reinforced by the addition of sixteen peers, representing the peerage of Scotland, and elected every parliament; and the Scottish peers, as a body, were admitted to all the privileges of peerage, except the right of sitting in parliament, or upon the trial of peers. No prerogative, however, was given to the crown to create new peerages after the Union; and, while they are distinguished by their antiquity, their number is consequently decreasing. To the House of Commons were assigned forty-five members, representing the shires and burghs of Scotland.

*Parliament under George III.*—With the reign of George III. there opened a new period in the history of parliament. Agitation in its various forms, an active and aggressive press, public meetings and political associations, the free use of the right of petition, and a turbulent spirit among the people seriously changed the relations of parliament to the country. And the publication of debates, which was fully established in 1771, at once increased the direct responsibility of parliament to the

people, and ultimately brought about other results, to which we shall presently advert.

*Union of Ireland.*—In this reign another important change was effected in the constitution of parliament. Upon the union with Ireland, in 1801, four Irish bishops were added to the lords spiritual, who sat by rotation of sessions, and represented the episcopal body of the Church of Ireland. But those bishops were deprived of their seats in parliament in 1869, on the disestablishment of the Church of Ireland. Twenty-eight representative peers, elected for life by the peerage of Ireland, were admitted to the House of Lords. All the Irish peers were also entitled to the privilege of peerage. In two particulars the Irish peerage was treated in a different manner from the peerage of Scotland. The crown was empowered to create a new Irish peerage whenever three Irish peerages in existence at the time of the Union have become extinct, or when the number of Irish peers, exclusive of those holding peerages of the United Kingdom, has been reduced to one hundred. And, further, Irish peers were permitted to sit in the House of Commons for any place in Great Britain, forfeiting, however, the privilege of peerage while sitting in the Lower House. The expediency of both these provisions has often been called in question.

At the same time one hundred representatives of Ireland were added to the House of Commons. This addition raised the number of members to six hundred and fifty-eight. Parliament now became the parliament of the United Kingdom, and high hopes were entertained of a salutary fusion of diverse nationalities into a single assembly; but these hopes have scarcely been realized, and the relations of the Irish people to Great Britain and the imperial government continue to be a source of the gravest embarrassment and danger.

*Schemes for improving the Representation.*—By the union of Scotland and Ireland, the electoral abuses of those countries were combined with those of England. Notwithstanding a defective representation, however, parliament generally sustained its position as fairly embodying the political sentiments of its time. Public opinion had been awakened, and could not safely be ignored by any party in the state. Under a narrow and corrupt electoral system, the ablest men in the country found an entrance into the House of Commons; and their rivalry and ambition ensured the acceptance of popular principles and the passing of many remedial measures. As society expanded, and new classes were called into existence, the pressure of public opinion upon the legislature was assuming a more decisive character. The grave defects of the representation were notorious, and some minor electoral abuses had been from time to time corrected. But the fundamental evils,—nomination boroughs, limited rights of election, the sale of seats in parliament, the prevalence of bribery, and the enormous expense of elections,—though constantly exposed, long held their ground against all assailants. So far back as 1770 Lord Chatham had denounced these flagrant abuses. "Before the end of this century," he said, "either the parliament will reform itself from within, or be reformed with a vengeance from without." In 1782, and again in 1783 and 1785, his distinguished son, William Pitt, condemned the abuses of the representation, and proposed schemes of parliamentary reform. In 1793 Mr Grey (afterwards Earl Grey) submitted a motion on the same subject; but the excesses of the French Revolution, political troubles at home, and exhausting wars abroad discouraged the supporters of reform for many years. Under more favourable conditions the question assumed greater proportions. Lord John Russell especially distinguished himself in 1820, and in several succeeding years,

by the able exposure of abuses and temperate schemes of reform. His efforts were assisted by the scandalous disclosures of bribery at Grampound, Penryn, and East Retford. All moderate proposals were rejected; but the concurrence of a dissolution, on the death of George IV., with the French Revolution of 1830, and an ill-timed declaration of the duke of Wellington that the representation was perfect and could not be improved, suddenly precipitated the memorable crisis of parliamentary reform. It now fell to the lot of Earl Grey, as premier, to be the leader in a cause which he had espoused in his early youth.

*The Reform Acts of 1832.*—The result of the memorable struggle which ensued may be briefly told. By the Reform Acts of 1832 the representation of the United Kingdom was reconstructed. In England, fifty-six nomination boroughs returning one hundred and eleven members were disfranchised; thirty boroughs were each deprived of one member, and Weymouth and Melcombe Regis, which had returned four members, were now reduced to two. Means were thus found for the enfranchisement of populous places. Twenty-two large towns, including metropolitan districts, became entitled to return two members, and twenty less considerable towns acquired the right of returning one member each. The number of county members was increased from ninety-four to one hundred and fifty-nine, the larger counties being divided for the purposes of representation.

The elective franchise was also placed upon a new basis. In the boroughs a £10 household suffrage was substituted for the narrow and unequal franchises which had sprung up,—the rights of freemen, in corporate towns, being alone respected. In the counties, copyholders and leaseholders for terms of years, and tenants at will paying a rent of £50 a year, were added to the 40s. freeholders.

By the Scottish Reform Act, the number of members representing Scotland was increased from forty-five, as arranged at the Union, to fifty-three, of whom thirty were assigned to counties and twenty-three to cities and boroughs. In counties the franchise was conferred upon owners of property of £10 a year, and certain classes of leaseholders; in burghs, upon £10 householders, as in England.

By the Irish Reform Act, no boroughs, however small, were disfranchised; but the franchise was given to £10 householders, and county constituencies were enlarged. These franchises, however, were extended in 1850, when an £8 household suffrage was given to the boroughs, and additions were made to the county franchises. The hundred members assigned to that country at the Union were increased to one hundred and five. Notwithstanding these various changes, however, the total number of the House of Commons was still maintained at 658.

*The Reformed Parliament.*—The legislature was now brought into closer relations with the people, reflected their opinions, and was sensitive to the pressure of popular forces. The immediate effects of this new spirit were perceptible in the increased legislative activity of the reformed parliament, its vigorous grappling with old abuses, and its preference of the public welfare to the narrower interests of classes. But, signal as was the regeneration of parliament, several electoral evils still needed correction. Strenuous efforts were made, with indifferent success, to overcome bribery and corruption, and proposals were often ineffectually made to restrain the undue influence of landlords and employers of labour by the ballot; improvements were made in the registration and polling of electors, and the property qualification of members was abolished. Complaints were also urged that the middle classes had been admitted to power, while the working classes were excluded from the late scheme of enfranchisement. Twenty

years after the settlement of 1832, its revision was seriously approached.

*Later Measures of Reform.*—In 1852, and again in 1854, Lord John Russell introduced further measures of reform; but constitutional changes were discouraged by the Russian war. In 1859 Lord Derby's Conservative government proposed another scheme of reform, which was defeated; and in 1860 Lord John Russell brought in another Bill, which was not proceeded with; and the question of reform continued in abeyance until after the death of Lord Palmerston. Earl Russell, who succeeded him as premier, was prompt to redeem former pledges, and hastened to submit to a new parliament, in 1866, another scheme of reform. This measure, and the ministry by whom it was promoted, were overthrown by a combination of the Conservative opposition and the memorable "cave" of members of the Liberal party. But the popular sentiment in favour of reform, which had for some years been inert, was suddenly aroused by the defeat of a Liberal ministry, and the triumph of the party opposed to reform. Lord Derby and his colleagues were now constrained to undertake the settlement of this embarrassing question; and by a strange concurrence of political events and party tactics, a scheme far more democratic than that of the Liberal Government was accepted by the same parliament, under the auspices of a Conservative ministry.

*The Reform Acts of 1867-68.*—By the English Reform Act of 1867, four corrupt boroughs were disfranchised, and thirty-eight boroughs returning two members were henceforth to return one only. A third member was given to Manchester, Liverpool, Birmingham, and Leeds; a second member to Merthyr Tydfil and Salford; the Tower Hamlets were divided into two boroughs, each returning two members; and ten new boroughs were created, returning one member each, with the exception of Chelsea, to which two were assigned. By these changes twenty-six seats were taken from boroughs, while a member was given to the university of London. But before this Act came into operation, seven other English boroughs were disfranchised by the Scottish Reform Act of 1868, these seats being given to Scotland. Thirteen new divisions of counties were erected, to which twenty-five members were assigned. In counties, the franchise of copyholders and leaseholders was reduced from £10 to £5, and the occupation franchise from £50 to £12. In boroughs the franchise was extended to all occupiers of dwelling-houses rated to the poor-rates, and to lodgers occupying lodgings of the annual value of £10 unfurnished.

By the Scottish Reform Act of 1868, the number of members representing Scotland was increased from fifty-three to sixty,—three new members being given to the shires, two to the universities, and two to cities and burghs. The county franchise was extended to owners of lands and heritages of £5 yearly value, and to occupiers of the rateable value of £14; and the burgh franchise to all occupiers of dwelling-houses paying rates, and to tenants of lodgings of £10 annual value unfurnished.

By the Irish Reform Act of 1868, no change was made in the number of members nor in the distribution of seats; but the boroughs of Sligo and Cashel, already disfranchised, were still left without representation. The county franchise was left unchanged; but the borough franchise was extended to occupiers of houses rated at £4, and of lodgings of the annual value of £10 unfurnished.

*Present Position of Parliamentary Reform.*—That these changes in the representation—especially the household suffrage in boroughs—were a notable advance upon the reforms of 1832, in the direction of democracy, cannot be questioned. The enlarged constituencies speedily overthrew the ministry to whom these measures were due; and

the new parliament further extended the recent scheme of reform, by granting to electors the protection of the ballot, for which advanced reformers had contended since 1832. Nor was the representation, as lately determined, long suffered to continue without question. First, it was proposed, in 1872, by Mr Trevelyan, to extend the household franchise to counties, and this proposal found favour in the country and in the House of Commons; but, the Conservative party having been restored to power in 1874, no measure of that character could be promoted with any prospect of success. At the dissolution in 1880 a more general revision of the representation was advocated by leading members of the Liberal party, who were soon restored to power; and further measures of reform are now under the consideration of parliament. Meanwhile, trenchant enactments have been made in restraint of corrupt practices, and for reducing the excessive cost of elections.

*Relations of the Commons to the Crown and the Lords.*—Having brought this rapid sketch of the history and constitution of parliament to a close, a few remarks may be offered as to the relations of the House of Commons to the crown, the House of Lords, and the people. Prior to the reign of Charles I. the condition of society was such as naturally to subordinate the Commons to the crown and the Lords. After the Revolution of 1688, society had so far advanced that, under a free representation, the Commons might have striven with both upon equal terms. But, as by far the greater part of the representation was in the hands of the king and the territorial nobles, the large constitutional powers of the Commons were held safely in check. Since 1832, when the representation became a reality, a corresponding authority has been asserted by the Commons. For several years, indeed, by reason of the weakness of the Liberal party, the Lords were able successfully to resist the Commons upon many important occasions; but it was soon acknowledged that they must yield whenever a decisive majority of the Commons, supported by public opinion, insisted upon the passing of any measure, however repugnant to the sentiments of the Upper House. And it became a political axiom that the Commons alone determined the fate of ministries, and the policy of the state. The relations of the two Houses, however, can only be understood in connexion with the action of political parties. The Lords may be said, generally, to represent the opinions prevalent before 1832, while, during the greater part of the period since that time, the Commons, under leaders of the Liberal party, have represented the progressive views of a later generation. Hence, under Liberal administrations, the two Houses have been in frequent conflict; under Conservative administrations they have been brought into general agreement, the electors having supported the party which commanded a majority in both Houses. In the conflict of parties, the ultimate appeal is to the country. But as the representation of the people is further extended, an accord between the two Houses will be more difficult, while the power of resistance on the part of the Lords will be proportionately weakened.

*Severe Pressures upon the House of Commons.*—The House of Commons having thus become the centre of political power, it has been impelled to extraordinary activity. The legislation of the last fifty years affords the only example in history of so wide a reconstruction of institutions, and so bold a redress of grievances, having been accomplished without a revolution. But this prodigious work, of which the main burthen has rested upon the Commons, has formed only a part of their labours. The voting of supplies for the public service, and financial policy, are their exclusive province, and offer unbounded opportunities for debate. They have also assumed a large

share of executive power. Every act of administration is open to question, controversy, and censure. Matters of executive policy—foreign, colonial, and domestic—are eagerly discussed in this numerous and excited assembly. Nor are discussions mainly directed to such important topics. The close connexion of the Commons with the people, the publicity of debates, the rapidity of communications with all parts of the world, and the activity of the press, have made the floor of that House the popular platform of the country. On that arena are discussed every conceivable grievance, complaint, opinion, project, or delusion. Subjects the most trivial are forced upon the attention of the House, by means of questions and incidental debates; and after weary sittings, such as no other deliberative assembly has ever been willing to endure, matters of the first importance fail to obtain a hearing. These difficulties were apparent in the first reformed parliaments after 1832; and they have since been aggravated so seriously as to threaten the character and competency of the most powerful branch of the legislature.

Such difficulties, grave enough in themselves, have lately assumed more dangerous proportions under the pernicious tactics of obstruction. The liberal opportunities provided, by the rules of the House, for free discussion have been perverted and abused; and the effective power of the House has often been held in check, and sometimes nearly paralysed. Already some partial remedies have been applied to this acknowledged evil, but further measures are still needed for facilitating the action of parliament. It were strange, indeed, if the House of Commons, having attained pre-eminence in the legislature, should now prove unequal to the responsibilities of its freedom and its power. The methods of earlier times, and other political conditions, will assuredly be reviewed, and adapted to the multiplied obligations of an assembly whose fruitful labours are essential to the welfare of the country.

#### POWERS AND PRIVILEGES OF PARLIAMENT.

Such being the history and constitutional character of parliament, this survey would be incomplete without a more detailed view of the powers and privileges of each of its constituent parts, and of its ordinary proceedings.

*Prerogatives of the Crown.*—The crown, pre-eminent in rank and dignity, is also the legal source of parliamentary authority. The Queen virtually appoints the Lords Spiritual, and all the peerages of the Lords Temporal have been created by herself or her predecessors. Thus the entire House of Lords is the creation of the crown. The Queen summons parliament to meet, and prescribes the time and place of its meeting, prorogues and dissolves it, and commands the issue of writs for the election of members of the House of Commons. By several statutes, beginning with the 4th Edward III. c. 14, the annual meeting of parliament had been ordained; but these statutes, continually disregarded, were virtually repealed in the reigns of Charles II. and William and Mary (16 Ch. II., 31; 6 & 7 Will. and Mary, 32). The present statute law merely exacts the meeting of parliament once in three years; but the annual voting of supplies has long since superseded obsolete statutes. When parliament is assembled, it cannot proceed to business until the Queen has declared the causes of summons, in person or by commission. Other prerogatives of the crown, in connexion with parliament, will be noticed in reference to the proceedings of the two Houses.

*Powers of the House of Lords.*—The House of Lords, which at present consists of about five hundred and twenty members, is distinguished by peculiar dignities, privileges, and jurisdictions. Peers individually enjoy the rank and



precedence of their several dignities, and are hereditary councillors of the crown. Collectively with the Lords Spiritual they form a permanent council of the crown; and, when assembled in parliament, they form the highest court of judicature in the realm, and are a co-equal branch of the legislature, without whose consent no laws can be made. Their judicature is of various kinds, viz., for the trial of peers; for determining claims of peerage and offices of honour, under references from the crown; for the trial of controverted elections of Scotch and Irish peers; for the final determination of appeals from courts in England, Scotland, and Ireland; and, lastly, for the trial of impeachments.

*Powers of the House of Commons.*—The House of Commons also has its own peculiar privileges and jurisdictions. Above all, it has the paramount right of originating the imposition of all taxes, and the granting of supplies for the service of the state. It has also enjoyed, from early times, the right of determining all matters concerning the election of its own members, and their right to sit and vote in parliament. This right, however, has been greatly abridged, as, in 1868, the trial of controverted elections was transferred to the courts of law; but its jurisdiction in matters of election, not otherwise provided for by statute, is still retained intact. As part of this jurisdiction, the House directs the Speaker to issue warrants to the clerk of the crown to make out new writs for the election of members to fill up such vacancies as occur during the sitting of parliament.

*Privileges of Parliament.*—Both Houses are in the enjoyment of certain privileges, designed to maintain their authority, independence, and dignity. These privileges are founded mainly upon the law and custom of parliament, while some have been confirmed, and others abridged or abrogated by statute. The Lords rely entirely upon their inherent right, as having "a place and voice in parliament"; but, by a custom dating from the 6th Henry VIII., the Commons lay claim, by humble petition to the crown at the commencement of every parliament, "to their ancient and undoubted rights and privileges." Each House has its separate rights and jurisdictions; but privileges properly so-called, being founded upon the law and custom of parliament, are common to both Houses. Each House adjudges whether any breach of privilege has been committed, and punishes offenders by censure or commitment. This right of commitment is incontestably established, and it extends to the protection of officers of the House, lawfully and properly executing its orders, who are also empowered to call in the assistance of the civil power. The causes of such commitments cannot be inquired into by courts of law, nor can prisoners be admitted to bail. Breaches of privilege may be summarized as disobedience to any orders or rules of the House, indignities offered to its character or proceedings, assaults, insults, or libels upon members, or interference with officers of the House in discharge of their duty, or tampering with witnesses. Such offences are dealt with as contempts, according to the circumstances of the respective cases, of which numerous precedents are to be found in the journals of both Houses. The Lords may imprison for a fixed period, and impose fines; the Commons can only imprison generally, the commitment being concluded by the prorogation, and have long discontinued the imposition of fines.

*Freedom of Speech.*—Freedom of speech has been one of the most cherished privileges of parliament from early times. Constantly asserted, and often violated, it was finally declared by the Bill of Rights "that the freedom of speech, and debates and proceedings in parliament, ought not to be impeached or questioned in any court or place out of parliament." Such a privilege is essential to the independence of parliament, and to the protection of members in discharge of their duties. But, while it protects

members from molestation elsewhere, it leaves them open to censure or other punishment by the House itself, whenever they abuse their privilege and transgress the rules of orderly debate.

*Freedom from Arrest.*—Freedom from arrest is a privilege of the highest antiquity. It was formerly of extended scope, but has been reduced, by later legislation, within very narrow limits. Formerly not only the persons of members but their goods were protected, and their privilege extended to their servants. At present members are themselves free from arrest, but otherwise they are liable to all the processes of the courts. If arrested, they will be immediately discharged, upon motion in the court whence the process issued. Peers and peeresses are, by the privilege of peerage, free from arrest at all times. Members of the House of Commons are free only for forty days after prorogation and forty days before the next appointed meeting; but prorogations are so arranged as to ensure a continuance of the privilege. Formerly, even suits against members were stayed, but this offensive privilege has been abolished by statute. Exemption from attending as witnesses upon subpoena, once an acknowledged privilege, is no longer insisted upon; but immunity from service upon juries is at once an ancient privilege and a statutory right. The privilege of freedom from arrest is limited to civil causes, and has not been suffered to exempt members from the operation of the criminal law, nor even from commitments for contempt by other courts. But, whenever the freedom of a member is so interfered with, the courts are required immediately to inform the House of the causes of his commitment. Witnesses, suitors, counsel, and agents in attendance upon parliament are protected from arrest and molestation, and from the consequences of statements made by them, or other proceedings in the conduct of their cases.

*Conflicts between Privilege and Law.*—As both Houses, in enforcing their privileges, are obliged to commit offenders or otherwise interfere with the liberty of the subject, the exercise of these privileges has naturally been called in question before the courts. Each House is the sole judge of its own privileges; but the courts are bound to administer the law, and, where law and privilege have seemed to be at variance, a conflict of jurisdiction has arisen between parliament and the courts. Many interesting controversies have arisen upon such occasions; but of late years privilege has been so carefully restrained within the proper limits of the law, and the courts have so amply recognized the authority of parliament, that unseemly conflicts of jurisdiction have been averted.

#### PARLIAMENTARY PROCEDURE

We may now present a general outline of the proceedings of parliament during the transaction of its multifarious business.

On the day appointed by royal proclamation for the meeting of a new parliament, both Houses assemble in their respective chambers, when the Lords Commissioners for opening the parliament summon the Commons to the bar, by the gentleman usher of the black rod, to hear the commission read. The Lord Chancellor then states that, when the members of both Houses shall be sworn, Her Majesty will declare the causes of her calling this parliament; and, it being necessary that a Speaker of the House of Commons shall be first chosen, the Commons are directed to proceed to the appointment of a Speaker, and to present him, on the following day, for Her Majesty's royal approbation. The Commons at once withdraw to their own House and proceed to the election of their Speaker. The next day the Speaker-elect proceeds, with the House to the House of Lords, and, on receiving the royal approbation, lays claim, in the accustomed form, on

behalf of the Commons, "to their ancient and undoubted rights and privileges." The Speaker, now fully confirmed, returns to the House of Commons, and, after repeating his acknowledgments, reminds the House that the first thing to be done is to take and subscribe the oath required by law. Having first taken the oath himself, he is followed by other members, who come to the table to be sworn. The swearing of members in both Houses proceeds from day to day, until the greater number have taken the oath, or affirmation, when the causes of summons are declared by Her Majesty in person, or by commission, in "the Queen's speech." This speech being considered in both Houses, an address in answer is agreed to, which is presented to Her Majesty by the whole House, or by "the lords with white staves" in one House and privy councillors in the other.

*Sittings of Both Houses.*—The real business of the session now commences: the committees of supply and ways and means are set up; bills are introduced; motions are made; committees are appointed; and both Houses are, at once, in full activity. The Lord Chancellor presides over the deliberations of the Lords, and the Speaker over those of the Commons. A quorum of the House of Lords, including the Chancellor, is three; that of the House of Commons, including the Speaker, is forty. If forty members cannot be assembled at 4 o'clock, the House is at once adjourned; and so also if it be found, at a later hour, that less than that number are present. The Lords usually met at 5 o'clock, but have recently changed that hour to a quarter past 4. The usual hour for the meeting of the Commons is a quarter before 4, except on Wednesdays, when the House meets at 12 and adjourns at 6, and on other morning sittings from 2 till 7. In both Houses accommodation is provided for strangers and reporters, and there are separate galleries for ladies.

*Questions put from the Chair.*—Every matter is determined, in both Houses, upon questions put from the chair and resolved in the affirmative or negative, or otherwise disposed of by the withdrawal of the motion, by amendments, by the adjournment of the House, by reading the orders of the day, or by the previous question. Notices are required to be given of original motions; and the different stages of bills, and other matters appointed for consideration by the House, stand as orders of the day. Certain days in the week are appointed for notices of motions and orders of the day respectively; and on Monday and Thursday Government orders of the day have precedence. Questions of privilege are allowed precedence of all the business on any day; but this rule, being liable to grave abuses, is guarded by strict limitations. Debate arises when a question has been proposed from the chair; and at the close of the debate the question is put, with or without amendment, as the case may be, and is determined, when necessary, by a division. No question or bill, substantially the same as one upon which the judgment of the House has already been given, may be again proposed during the same session.

*Rules of Debate.*—Members claim to be heard in debate by rising in their places. When more than one member rises at the same time, in the Lords the member who is to speak is called by the House, in the Commons by the Speaker. Every member, when called, is bound to speak to the question before the House; and calls to order for irrelevance, or for referring to other matters which have been disposed of, or which stand for consideration on other days, are very frequent. A member may speak once only to any question, except to explain, or upon a point of order, or to reply when a member has himself submitted a motion to the House, or when an amendment has been moved which constitutes a new question. He may not refer to past debates, nor to debates in the other House; nor may he refer to any other member by name, or use offensive and disorderly language against the Queen, either House of Parliament, or other members. Members offending against any of the rules of debate are called to order by the Speaker, or the attention of the chair is directed to the breach of order by another member. Order is generally enforced by the authority of the chair; but in extreme cases, and especially when obstruction is being practised, the offending member is named by the Speaker, and suspended by an order of the House, or otherwise punished at the discretion of the House. And, when a debate has been unduly prolonged, the House may order it to be closed, but under such conditions and restrictions that this power can rarely be exercised. The rules to be observed by members in the House during a debate are such as to ensure the order and decorum becoming a deliberative assembly.

*Divisions.*—At the conclusion of a debate, unless the motion be withdrawn, or the question (on being put from the chair) be agreed to, or negatived, the House proceeds to a division, which effects the twofold purpose of ascertaining the numbers supporting and opposing the question, and of recording the names of members voting on either side. On each side of the House is a division lobby; and in the

Lords the "contents" and in the Commons the "eyes" are directed to go to the right, and the "not contents" or "noes" to the left. The former pass into the right lobby, at the back of the speaker's chair, and return to the House through the bar; the latter pass into the left lobby, at the bar, and return at the back of the chair. The opposing parties are thus kept entirely clear of one another. In each lobby there are two members acting as tellers, who count the members as they pass, and two division clerks who take down their names. After the division, the four tellers advance to the table, and the numbers are reported by one of the tellers for the majority. In case of an equality of numbers, in the Lords the question is negatived in virtue of the ancient rule "*semper presuntur pro negante*"; in the Commons the Speaker gives the casting vote.

*Committees of the Whole House.*—For the sake of convenience in the transaction of business, there are several kinds of committees. Of these the most important is a committee of the whole House, which, as it consists of the entire body of members, can scarcely be accounted a committee. It is presided over by a chairman, who sits in the clerk's chair at the table, the mace, which represents the authority of the House itself, being for the time placed under the table. In this committee are discussed the several provisions of bills, resolutions, and other matters requiring the consideration of details. To facilitate discussion, members are allowed to speak any number of times to the same question; otherwise the proceedings are similar to those of the House itself. In the Lords, the chair is taken by the chairman of committees; and in the Commons by the chairman of the committee of ways and means, or in his absence by any other member. The quorum of such a committee is the same as that of the House itself. It reports from time to time to the House, but has no power of adjournment.

*Grand and Standing Committees.*—In the House of Commons there were formerly four grand committees, viz., for religion, for grievances, for courts of justice, and for trade. They were founded upon the valuable principle of a distribution of labours among several bodies of members; but, having fallen into disuse, they were discontinued in 1832. The ancient committee of privileges, in which "all who come are to have voices," is still appointed at the commencement of every session, but is rarely called into action, as it has been found more convenient to appoint a select committee to inquire into any question of privilege as it arises. In 1882 a partial revival of grand committees was effected by the appointment of two standing committees for the consideration of bills relating to law and courts of justice and to trade; and there is reasonable ground for hoping that this system may be widely extended, so as to lighten the labours of the House, and facilitate the arduous work of legislation.

*Select Committees.*—In select committees both Houses find the means of delegating inquiries, and the consideration of other matters, which could not be undertaken by the whole House. The reports of such committees have formed the groundwork of many important measures; and bills are often referred to them which receive a fuller examination than could be expected in a committee of the whole House. Power is given to such committees, when required, to send for persons, papers, and records. In the Lords the power of examining witnesses upon oath has always been exercised, but it was not until 1871 that the same power was extended to the Commons, by statute.

*Communications between the Two Houses.*—In the course of the proceedings of parliament, frequent communications between the two Houses become necessary. Of these the most usual and convenient form is that of a message. Formerly the Lords sent a message by two judges, or two masters in chancery, and the Commons by a deputation of their own members; but since 1855 messages have been taken from one House to the other by one of the clerks at the table. A more formal communication is effected by a conference, in reference to amendments to bills or other matters; but this proceeding has been in great measure superseded by the more simple form of a message. The two Houses are also occasionally brought into communication by means of joint committees and of select committees communicating with each other.

*Communications between the Crown and Parliament.*—Communications, in various forms, are also conducted between the crown and both Houses of Parliament. Of these the most important are those in which the Queen, in person or by commission, is present in the House of Lords, to open or prorogue parliament, or to give the royal assent to bills. Her Majesty is then in direct communication with the three estates of the realm, assembled in the same chamber. The Queen also sends messages to both Houses under the royal sign manual, when all the members are uncovered. Verbal messages are also sent, and the Queen's pleasure, or royal recommendation or consent to bills, or other matters, signified through a minister of the crown or a privy councillor. Messages under the sign manual are acknowledged by addresses, except where grants of money are proposed, in which case no address is presented by the Commons, who acknowledge them by making provision accordingly.

Both Houses approach the crown, sometimes by joint addresses, but usually by separate addresses from each House. Such addresses are presented to Her Majesty, either by the whole House, or by the lords with white staves in one House and by privy councillors in the other. Her Majesty answers, in person, addresses presented by the whole House; but, when presented otherwise, an answer is brought by one of the lords with white staves, or by one of the privy councillors, by whom the address has been presented. Resolutions of either House are also sometimes directed to be laid before Her Majesty; and messages of congratulation or condolence are sent to other members of the royal family.

*The Passing of Public Bills.*—The passing of bills forms the most considerable part of the business of parliament; but a brief notice will suffice to explain the methods of procedure. These are substantially the same in both Houses; but the privileges of the Commons, in regard to supply and taxation, require that all bills imposing a charge upon the people should originate in that House. On the other hand, the Lords claim that bills for restoration of honours or in blood, or relating to their own privileges and jurisdiction, should commence in their House. An act of grace, or general pardon, originates with the crown, and is read once only in both Houses. Bills are divided into public and private; but here the former only are referred to. In the Lords any peer is entitled to present a bill, but in the Commons a member is required to obtain the previous leave of the House to bring in the bill; and, in the case of bills relating to religion, trade, grants of public money, or charges upon the subject, a preliminary committee is necessary before such leave will be given. A bill, when presented, is read a first time, and ordered to be printed; and a day is appointed for the second reading. At this latter stage, the principle of the bill is discussed; and, if disapproved of by an adverse vote, the bill is lost and cannot be renewed during the same session. If approved of, it is usually committed to a committee of the whole House, where every provision is open to debate and amendment. When the bill has been fully considered it is reported to the House, with or without amendments, and is ready to pass through its remaining stages. Sometimes, however, the bill is referred to a select committee before it is committed to a committee of the whole House.

By recent standing orders of the Commons, bills relating to law and courts of justice and to trade may be committed to standing committees, specially constituted, instead of to a committee of the whole House. When a bill has been reported from a committee of the whole House, or from a standing committee, with amendments, the bill, as amended, is ordered to be considered on a future day, when further amendments may be made, or the bill may be recommitted. The next and last stage is the third reading, when the principle of the measure, and its amended provisions, are open to review. Even at this stage the bill may be lost; but if the third reading be agreed to, it is at once passed and sent to the other House. There it is open to the like discussions and amendments, and may be rejected. If returned without amendment, the bill merely awaits the royal assent; but if returned with amendments, such amendments must be agreed to, or otherwise adjusted, by mutual concessions, by the two Houses, before it can be submitted for the royal assent; and in case of ultimate disagreement the bill is lost. The royal assent consummates the work of legislation, and converts the bill into an Act of Parliament.

*Petitions.*—Both Houses are approached by the people by means of petitions, of which prodigious numbers are presented to the House of Commons every session. They are referred to the committee on public petitions, under whose directions they are classified, analysed, and the number of signatures counted; and, when necessary, the petitions are printed *extenso*.

*Parliamentary Papers.*—Another source of information is found in parliamentary papers. These are of various kinds. The greater part are obtained either by a direct order of the House itself, or by an address to the crown for documents relating to matters in which the prerogatives of the crown are concerned. Other papers, relating to foreign and colonial affairs and other public matters, are presented to both Houses by command of Her Majesty. Again, many papers are annually presented, in pursuance of Acts of Parliament. In the House of Commons, these various printed documents occupy from eighty to one hundred volumes every year.

*The Granting of Supplies.*—The exclusive right of the Commons to grant supplies, and to originate all measures of taxation, imposes a very onerous service upon that House. This is mainly performed by two committees of the whole House,—the Committee of Supply, and the Committee of Ways and Means. The former deals with all the estimates for the public service presented to the House by command of Her Majesty; and the latter votes out of the Consolidated Fund such sums as are necessary to meet the supplies already granted, and originates all taxes for the service of the year. It is here that the annual financial statement of the chancellor of the exchequer, commonly known as "the Budget," is delivered. The resolutions of these committees are reported to the House, and, when agreed to, form the foundation of bills, to be passed by both

Houses, and submitted for the royal assent; and towards the close of the session an Appropriation Act is passed, applying all the grants for the service of the year.

*Elections.*—The extensive jurisdiction of the Commons in matters of election, already referred to, formerly occupied a considerable share of their time, but its exercise has now been contracted within narrow limits. Whenever a vacancy occurs during the continuance of a parliament, a warrant for a new writ is issued by the Speaker, by order of the House during the session, and in pursuance of statutes during the recess. The causes of vacancies are the death of a member, his being called to the House of Peers, his acceptance of an office from the crown, or his bankruptcy. When any doubt arises as to the issue of a writ, it is usual to appoint a committee to inquire into the circumstances of the case; and during the recess the Speaker may reserve doubtful cases for the determination of the House.

Controverted elections had been originally tried by select committees, afterwards by the committee of privileges and elections, and ultimately by the whole House, with scandalous partiality, but under the Grenville Act of 1770, and other later Acts, by select committees, so constituted as to form a more judicial tribunal. The influence of party bias, however, too obviously prevailed until 1839, when Sir Robert Peel introduced an improved system of nomination, which distinctly raised the character of election committees; but a tribunal constituted of political partisans, however chosen, was still open to jealousy and suspicion, and at length, in 1868, the trial of election petitions was transferred to judges of the superior courts, to whose determination the House gives effect, by the issue of new writs, or otherwise. The House, however, still retains and exercises its jurisdiction in all cases not relegated, by statute, to the judges.

*Impeachments and Trial of Peers.*—Other forms of parliamentary judicature still remain to be mentioned. Upon impeachments by the Commons, the Lords exercise the highest criminal judicature known to the law; but the occasions upon which it has been brought into action have been so rare, in modern times, that its procedure need not be dwelt upon. Another judicature is that of the trial of peers by the House of Lords. And, lastly, by a bill of attainder, the entire parliament is called to sit in judgment upon offenders.

*Private Bill Legislation.*—One other important function of parliament remains to be noticed,—that of private bill legislation. Here the duties of parliament are partly legislative and partly judicial. Public interests are promoted, and private rights secured. The vast industrial undertakings of the country—canals, docks, harbours, railways, waterworks, and the lighting and improvement of towns—have thus been sanctioned, at a cost far exceeding the amount of the national debt, while the rights of property have been jealously guarded. This whole jurisdiction has been regulated by special standing orders, and by elaborate arrangements for the nomination of capable and impartial committees. A prodigious legislative work has been accomplished,—but under conditions most costly to the promoters and opponents of private bills, and involving a serious addition to the onerous labours of members of parliament. Means have already been found, by general Acts and provisional orders, to lighten the pressure of private bill legislation; and further expedients will, doubtless, be devised for the relief of parliament from a branch of business which is scarcely compatible with the engagements of members in the weightier affairs of state.

*Varied Functions of Parliament.*—Such are the vast and varied functions of the imperial parliament,—to legislate for an empire, to control the executive government, to hear the complaints of the people, and to redress their grievances. To be equal to its high jurisdiction, it needs the guidance of accomplished statesmen, wisdom and patriotism in its members, and an organization which shall make fruitful the talents, the practical knowledge and experience, of the ablest men of their generation. Its history is bright with records of eloquence, of statesmanship, of wise legislation, and of generous sympathy with the people; and that its future greatness may be worthy of its past glories is the earnest hope of every good citizen.

*Literature.*—See *Rolls of Parliament, and Journals of both Houses; Parliamentary Hist.; Hansard, Parl. Hist. and Debates; Gray, Debates; Cavendish, Debates; Wilkins, Leges Anglo-Saxo; Kemble, The Saxons in England; Turner, Hist. of the Anglo-Saxons; and Hist. of England during the Middle Ages; Sir F. Palgrave, English Commonwealth; Id., Hist. of Normandy and of England; Id., Parliamentary Writs; Stubbs, Const. Hist. of England; Hollinghead, Chron.; Selden, Titles of Honour; Ruthead, Preface to Statutes; Cotton, Abridgment (Preface); Parry, Parliaments and Councils of England; Reports of Lords' Committee on the Dignity of the Peerage; Coke, Institutes; Lord Hale, History of the Common Law, Jurisdiction of the Lords; Lord Lyttelton, Hist. of Henry II.; D'Ewes, Journals of Queen Elizabeth; Elysage, Account of holding Parliaments; Hakewell, Modus Tenendi Parliamentum; Barrington, On the Statutes; Maxon, Hist. of the Exchequer; Blackstone, Comm.; Lord Colchester, Diary; Hallam, Middle Ages, and Constitutional History of England; Hatsell, Precedents; Sir T. Erskine May, Law and Usage of Parliament; Id., Const. Hist. of England; Id., Democracy in Europe, a History (vol. II.); Rules, Orders, and Forms of Proceeding of the House of Commons; Freeman, Growth of the English Constitution, and the Norman Conquest of England; Green, History of the English People, and the English Constitution. (F. R. M.)*

PARMA, one of the finest cities of northern Italy, is situated in 44° 48' N. lat. and 10° 20' E. long., 35½ miles by rail south-east of Piacenza and 32½ north-west of Modena, in a fertile tract of the Lombard plain within view of the Alps, and sheltered by the Apennines. From south to north it is traversed by the channel of the Parma, crossed here by three bridges; and from east to west for a distance of 6700 feet runs the line of the Æmilian Way, by which ancient Parma was connected on the one hand with Ariminum (Rimini), and on the other with Piacentia (Piacenza) and Mediolanum (Milan). The old ramparts and bastions (excluding the circuit of the citadel in the south-east) make an encinte of about 4½ miles, but the enclosed area is not all occupied by streets and houses; there is an extensive "royal garden" or public park in the north-west angle, as well as a botanical garden and public promenades in the neighbourhood of the citadel, and various open spaces in other parts. In the centre of the city the Æmilian Way widens out into the Piazza Grande, a large and picturesque-looking square which contains the Palazzo del Comune and a modern statue of Correggio, whose masterpieces form the chief artistic attraction of Parma. The cathedral of the Assumption (originally St Herculanus), erected between 1064 and 1074, and consecrated in 1106 by Pope Paschal II, is a Romano-Byzantine building in the form of a Latin cross, 230 feet long by 84 feet wide. The west front, 94 feet high and 90 feet broad, is relieved by three rows of semicircular arches, and has a central porch (there were at one time three) supported by huge red marble lions sculptured by Bono da Bisona. The walls and ceiling of the interior are covered with frescos; those of the octagonal cupola representing the Assumption of the Virgin are by Correggio, but much restored (see CORREGGIO, vol. vi. p. 437). The crypt contains the shrine of Bishop San Bernardino degli Uberti and the tomb of Bartolommeo Prato—the former by Prospero Clementi of Reggio. To the south-west of the cathedral stands the baptistery, designed by Benedetto Antelami; it was commenced in 1196 and completed in 1281. The whole structure, which has a height of 98 feet and a diameter of 76 feet, is composed of red and grey Verona marble. Externally it is an irregular octagon, each face consisting of a lower story with a semicircular arch (in three cases occupied by a portal), four tiers of small columns supporting as many continuous architraves, and forming open galleries, and above these a row of five engaged columns supporting a series of pointed arches and a cornice. Internally it is a polygon of sixteen unequal sides, and the cupola is supported by sixteen ribs, springing from the same number of columns. In the centre is an octagonal font bearing date 1298. To the east of the cathedral, and at no great distance, stands the church of San Giovanni Evangelista, which was founded along with the Benedictine monastery in 981, but as a building dates from the 16th century, and has a façade erected by Simone Moschino early in the 17th. The frescos on the cupola representing the vision of St John are by Correggio, and the arabesques on the vault of the nave by Anselmi. Madonna della Steccata (Our Lady of the Palisade), a fine church in the form of a Greek cross, erected between 1521 and 1539 after Zaccagni's designs, contains the tombs and monuments of many of the Bourbon and Farnese dukes of Parma, and preserves among a rich variety of paintings Parmigiano's Moses Breaking the Tables of the Law and Anselmi's Coronation of the Virgin. The ducal palace, usually called La Pilotta, is a vast and irregular group of buildings dating mainly from the 16th and 17th centuries; it now comprises the academy of fine arts (1752) and its valuable picture gallery (Correggio's St Jerome and Madonna della Scodella), the schools of painting, sculpture, and engraving, the

archæological museum (Trajan's *Tabula Alimentaria* and ruins from Velleia), and the great royal library (with De Rossi's Oriental MSS. and Zani's collection of engravings, Luther's Hebrew Psalter and Bodoni's types and matrices). The Teatro Farnese, a remarkable wooden structure erected in 1618-19 from Aleotti d'Argenta's designs, and capable of containing 4500 persons, has long been in a very ruined condition; the new theatre, opened in 1829, cost £80,000, and is celebrated as one of the best in Europe for the clear conveyance of sound. The royal university of Parma, founded in 1601 by Ranuccio I., and reconstituted by Philip of Bourbon in 1768, had 217 students in 1881-82. Among the benevolent institutions, in which the city is particularly rich, are a monte di pietà dating from 1488 and a hospital for incurables founded in 1332. Leather, silk-stuff for sieves, linen, hemp, and cotton stuffs, glass, crystal, and earthenware, wax candles, cast-iron wares, and pianofortes are all manufactured in or near the city; a very considerable trade is carried on in grain, cattle, and the dairy produce of the district. The "grana" cheese known as Parmesan is not now so well made at Parma as in some other parts of Italy—Lodi, for example. The population in 1861 was 47,067 for the city and 47,428 for the commune; the removal of the military and civil functionaries of the old duchy caused a considerable decrease, and the figures for 1881 were only 44,491 and 45,217.

The old Gallic town of Parma, which became a Roman colonia civium for 2000 colonists in 183 B.C., and after it had been plundered by Mark Antony's soldiers was recruited by Augustus, continued to be a place of importance till the later times of the empire. Under Theodoric its walls were rebuilt. The Greeks of the 6th century called it Chrysolopolis or City of Gold, and this name appears in the mediæval chronicles as Grisopolis. In 873 Carloman granted the city to bishop Widiboldus with the title of count. During the 11th, 12th, and 13th centuries Parma had its full share of the Guelph and Ghibelline struggles, and also carried on repeated hostilities with Borgo San Donnino and Piacenza. As a republic its government was mainly in the hands of the Rossi, Pallavicino, Correggio, and Sanvitale families. The fruitless siege of Parma in 1248 was the last effort of the unfortunate Frederick II. In 1303 the city became a lordship for Gilberto da Correggio, who laid the basis of its territorial power by conquering Reggio, Brascoello, and Guastalla, and was made commander-in-chief of the Guelphs by Robert of Apulia. The Correggio family never managed to keep possession of it for long, and in 1346 they sold it to the Visconti, and from them it passed to the Sforza. Becoming subject to Pope Julius II. in 1512, Parma remained (in spite of the French occupation from 1515 to 1521) a papal possession till 1545, when Paul III. (Alexander Farnese) invested his son Pierluigi with the duchies of Parma and Piacenza. There were eight dukes of Parma of the Farnese line—Pierluigi (died 1547), Ottavio (1586), Alessandro (1592), Ranuccio I. (1622), Odoardo (1646), Ranuccio II. (1694), Francesco (1727), Antonio (1781). See FARNESI, vol. ix. p. 36. Antonio and Francesco both having died childless, the duchy passed to Charles of Bourbon (Don Carlos), infante of Spain, who, becoming king of Naples in 1785, surrendered Parma and Piacenza to Austria, but retained the artistic treasures of the Farnese dynasty which he had removed from Parma to Naples. Spain reconquered the duchies in the war of succession (1746); they were recovered by Austria in 1746; and Maria Theresa again surrendered them to Don Philip, infante of Spain, in 1748. Ferdinand, Philip's son, who succeeded under Dutillet's regency in 1765, saw his states occupied by the revolutionary forces of France in 1796, and had to purchase his life-interest with 6,000,000 lire and 25 of the best paintings in Parma. On his death in 1802 the duchies were incorporated with the French republic and his son Louis became "king of Etruria." Parma was thus governed for several years by Moreau de Saint-Méry and by Junot. At the congress of Vienna, Parma, Piacenza, and Guastalla were assigned to Marie Louise (daughter of Francis I. of Austria and Napoleon's second consort), and on her death they passed in 1847 to Charles II. (son of Louis of Etruria and Marie Louise, daughter of Charles IV., king of Spain). The new duke, unwilling to yield to the wishes of his people for greater political liberty, was soon compelled to take flight, and the duchy was for a time ruled by a provisional Government and by Charles Albert of Sardinia; but in April 1849 Baron d'Aspre, with 15,000 Austrians, took possession of Parma, and the ducal government was restored under Austrian protection. Charles II. (who had in 1820 married Theresa, daughter of Victor Emmanuel of Sardinia) abdicated in favour of his son Charles III., March 14, 1849. On the

assassination of Charles III. in 1854, his widow, Marie Louise (daughter of Ferdinand, prince of Artois and duke of Berry), became regent for her son Robert. In 1860 his possessions were formally incorporated with the new kingdom of Italy.

The duchy of Parma in 1849 had an area of 2376 square miles, divided into five provinces—Borgo San Donnino, Valdiaro, Parma, Lunigiana Parmense, and Piacenza. Its population in 1851 was 497,843. Under Marie Louise (1815-47) the territory of Guastalla (50 square miles) formed part of the duchy, but it was transferred in 1847 to Modena in exchange for the communes of Bagnone, Flattiera, &c., which went to constitute the Lunigiana Parmense.

Parma has given birth to Sforza Pallavicino, Mazzola (Parmigiano) the painter, Antolami the architect, and Toschi the engraver. Guicciardini, the historian, was governor of the city under Leo X. See *Ann. Storia di Parma*, 1792-95; Scarsabelli, *Storia dei ducati di Parma, Piacenza, e Guastalla*, 1858; Buttafuoro, *Dizion. corogr. dei ducati*, &c., 1833; *Mon. Ital. ed. provinciarum Parmensium et Piacentinum pertinentium*, 1856, &c.; Ughelli, *Bulle Sacre*, vol. II.

**PARMENIDES OF ELMA**, the most notable of the philosophers of the Eleatic succession, is said by Diogenes Laertius (presumably on the authority of Apollodorus) to have been "in his prime" in Olymp. 69 (= 504-500 B.C.); whence it would appear that he was born about 539. Plato indeed (*Parmenides*, 127 B; compare *Theætetus*, 183 E, *Sophist*, 217 C) makes Socrates, who was born 470 or 469, see and hear Parmenides when the latter was about sixty-five years of age, in which case he cannot have been born before 519; but, in the absence of evidence that any such meeting took place, it is reasonable to regard this as one of Plato's many anachronisms. However this may be, Parmenides was a contemporary, perhaps a somewhat younger contemporary, of Heraclitus, with whom the first succession of physicists ended; while Anaxagoras and Empedocles, with whom the second succession of physicists began, as well as Protagoras, the earliest of those humanists whose rejection of physical research prepared the way for the Platonic metaphysics, were very decidedly his juniors. Belonging, it is said, to a rich and distinguished family, Parmenides attached himself, at any rate for a time, to the aristocratic society or brotherhood which Pythagoras had established at Croton; and accordingly one part of his system, the physical part, is apparently Pythagorean. To Xenophanes, the founder of Eleaticism,—whom he must have known, even if he was never in any strict sense of the word his disciple,—Parmenides was, perhaps, more deeply indebted, as the theological speculations of that thinker unquestionably suggested to him the theory of Being and Not-Being, of the One and the Many, by which he sought to reconcile Ionian monism with Italiote dualism. Tradition relates that Parmenides framed laws for the Eleates, who each year took an oath to observe them.

Parmenides embodied his tenets in a short poem called *Nature*, of which fragments, amounting in all to about a hundred and sixty lines, have been preserved in the writings of Sextus Empiricus, Simplicius, and others. *Nature* is traditionally divided into three parts—the "Proem," "Truth" (*τὰ πρὸς ἀλήθειαν*), and "Opinion" (*τὰ πρὸς δόξαν*). In "Truth," starting from the formula "the Ent (or existent) is, the Nonent (or non-existent) is not," Parmenides attempted to distinguish between the unity or universal element of nature and its variety or particularity, insisting upon the reality of its unity, which is therefore the object of knowledge, and upon the unreality of its variety, which is therefore the object, not of knowledge, but of opinion. In "Opinion" he propounded a theory of the world of seeming and its development, pointing out, however, that, in accordance with the principles already laid down, these cosmological speculations do not pretend to anything more than probability. In spite of the contemptuous remarks of Cicero and Plutarch about Parmenides's verification, *Nature* is not without literary merit. The introduction, though rugged, is forcible and picturesque; and the rest of the poem is written in a simple and effective style suitable to the sub-

ject. It is, however, a summary rather than an exposition, and its brevity sometimes leads to obscurity. Partly for this reason, but partly also in consequence of the mutilations and the corruptions of the text, the interpretation of the system which *Nature* represents early became a matter of controversy.

"Proem."—In the "Proem" the poet describes his journey from darkness to light. Borne in a whirling chariot, and attended by the daughters of the Sun, he reaches a temple sacred to an unnamed goddess (variously identified by the commentators with Nature, Wisdom, or Themis), by whom the rest of the poem is spoken. He must learn all things, she tells him, both truth, which is certain, and human opinions; for, though in human opinions there can be no confidence, they must be studied notwithstanding for what they are worth.

"Truth."—"Truth" begins with the declaration of Parmenides's principle in opposition to the principles of his predecessors. There are three ways of research, and three ways only. Of these, one asserts the non-existence of the existent and the existence of the non-existent [i.e., Thales, Anaximander, and Anaximenes suppose the single element which they respectively postulate to be transformed into the various sorts of matter which they discover in the world around them, thus assuming the non-existence of that which is elemental and the existence of that which is non-elemental]; another, pursued by "restless" persons, whose "road returns upon itself," assumes that a thing "is and is not" "is the same and not the same" [an obvious reference, as Bernays points out in the *Rheinisches Museum*, vii. 114 sq., to Heraclitus, the philosopher of flux]. These are ways of error, because they confound existence and non-existence. In contrast to them the way of truth starts from the proposition that "the Ent is, the Nonent is not."

On the strength of the fundamental distinction between the Ent and the Nonent, the goddess next announces certain characteristics of the former. The Ent is uncreated, for it cannot be derived either from the Ent or from the Nonent; it is imperishable, for it cannot pass into the Nonent; it is whole, indivisible, continuous, for nothing exists to break its continuity in space; it is unchangeable [for nothing exists to break its continuity in time]; it is perfect, for there is nothing which it can want; it never was, nor will be, but only is; it is evenly extended in every direction, and therefore a sphere, exactly balanced; it is identical with thought [i.e., it is the object, and the sole object, of thought as opposed to sensation, sensation being concerned with variety and change].

As then the Ent is one, invariable, and immutable, all plurality, variety, and mutation belong to the Nonent. Whence it follows that all the states and processes which we commonly recognize—generation and destruction, being and not-being [predicated of things], change of place, alteration of colour, and the like—are no more than empty words.

"Opinion."—The investigation of the Ent [i.e., the existent unity, extended throughout space and enduring throughout time, which reason discovers beneath the variety and the mutability of things] being now complete, it remains in "Opinion" to describe the plurality of things, not as they are, for they are not, but as they seem to be. In the phenomenal world then, there are, it has been thought [and Parmenides accepts the theory, which appears to be of Pythagorean origin], two primary elements—namely, fire, which is gentle, thin, homogeneous, and night [or earth], which is dark, thick, heavy. Of these elements [which, according to Aristotle, were, or rather were analogous to, the Ent and the Nonent respectively] all things consist, and from them they derive their several characteristics. The foundation for a cosmology having thus been laid in dualism, the poem went on to describe the generation of "earth, and sun, and moon, and air that is common to all, and the milky way, and furthest Olympus, and the glowing stars"; but the scanty fragments which have survived suffice only to show that Parmenides regarded the universe as a series of concentric rings or spheres composed of the two primary elements and of combinations of them, the whole system being directed by an unnamed goddess established at its centre. Next came a theory of animal development. This again was followed by a psychology, which made mind depend upon bodily structure, thought [as well as sensation, which was conceived to differ from thought only in respect of its object] being the excess of the one or the other of the two constituent elements, fire and night. "Such, opinion tells us, was the generation, such is the present existence, such will be the end, of those things to which men have given distinguishing names."

In the truism "the Ent is, the Nonent is not," *ἓν ἔστι, μὴ ἓν οὐκ ἔστι*, Parmenides breaks with his predecessors, the physicists of the Ionian succession. Asking themselves—What is the material universe? they had replied respectively—It is water, it is *μεταξύ τ'*, it is air, it is fire. Thus, while their question meant, or ought to have meant,

What is the single element which underlies the apparent plurality of the material world? their answers, Parmenides conceived, by attributing to the selected element various and varying qualities, reintroduced the plurality which the question sought to eliminate. If we would discover that which is common to all things at all times, we must, he submitted, exclude the differences of things, whether simultaneous or successive. Hence, whereas his predecessors had confounded that which is universally existent with that which is not universally existent, he proposed to distinguish carefully between that which is universally existent and that which is not universally existent, between  $\delta$ : and  $\mu\eta$   $\delta\nu$ . The fundamental truism is the epigrammatic assertion of this distinction.

In short, the single corporeal element of the Ionian physicists was, to borrow a phrase from Aristotle, a permanent *οὐσία* having *ᾤαθη* which change; but they either neglected the *ᾤαθη* or confounded them with the *οὐσία*. Parmenides sought to reduce the variety of nature to a single corporeal element; but he strictly discriminated the inconstant *ᾤαθη* from the constant *οὐσία*, and, understanding by "existence" universal, invariable, immutable being, refused to attribute to the *ᾤαθη* anything more than the semblance of existence.

Having thus discriminated between the permanent unity of nature and its superficial plurality, Parmenides proceeded to the separate investigation of the Ent and the Nonent. The universality of the Ent, he conceived, necessarily carries with it certain characteristics. It is one; it is eternal; it is whole and continuous, both in time and in space; it is immovable and immutable; it is limited, but limited only by itself; it is evenly extended in every direction, and therefore spherical. These propositions having been reached, apart from particular experience, by reflexion upon the fundamental principle, we have in them, Parmenides conceived, a body of information resting upon a firm basis and entitled to be called "truth." Further, the information thus obtained is the sum total of "truth," for, as "existence" in the strict sense of the word cannot be attributed to anything besides the universal element, so nothing besides the universal element can properly be said to be "known."

If Parmenides's poem had had "Being" for its subject, it would doubtless have ended at this point. Its subject is, however, "Nature"; and nature, besides its unity, has also the semblance, if no more than the semblance, of plurality. Hence the theory of the unity of nature is necessarily followed by a theory of its seeming plurality, that is to say, of the variety and mutation of things. The theory of plurality cannot indeed pretend to the certainty of the theory of unity, being of necessity untrustworthy, because it is the partial and inconstant representation of that which is partial and inconstant in nature. But, as the material world includes, together with a real unity, the semblance of plurality, so the theory of the material world includes, together with the certain theory of the former, a probable theory of the latter. "Opinion" is then no mere excrecence; it is the necessary sequel to "Truth."

Thus, whereas the Ionians, confounding the unity and the plurality of the universe, had neglected plurality, and the Pythagoreans, contenting themselves with the reduction of the variety of nature to a duality or a series of dualities, had neglected unity, Parmenides, taking a hint from Xenophanes, made the antagonistic doctrines supply one another's deficiencies; for, as Xenophanes in his theological system had recognized at once the unity of God and the plurality of things, so Parmenides in his system of nature recognized at once the rational unity of the Ent and the phenomenal plurality of the Nonent.

The foregoing statement of Parmenides's position differs

from Zeller's account of it in two important particulars. First, whereas it has been assumed above that Xenophanes was theologian rather than philosopher, whence it would seem to follow that the philosophical doctrine of unity originated, not with him, but with Parmenides, Zeller, supposing Xenophanes to have taught, not merely the unity of God, but also the unity of Being, assigns to Parmenides no more than an exacter conception of the doctrine of the unity of Being, the justification of that doctrine, and the denial of the plurality and the mutability of things. This view of the relations of Xenophanes and Parmenides is hardly borne out by their writings; and, though ancient authorities may be quoted in its favour, it would seem that in this case as in others they have fallen into the easy mistake of confounding successive phases of doctrine, "construing the utterances of the master in accordance with the principles of his scholar—the vague by the more definite, the simpler by the more finished and elaborate theory" (W. H. Thompson). Secondly, whereas it has been argued above that "Opinion" is necessarily included in the system, Zeller, supposing Parmenides to deny the Nonent even as a matter of opinion, regards that part of the poem which has opinion for its subject as no more than a revised and improved statement of the views of opponents, introduced in order that the reader, having before him the false doctrine as well as the true one, may be led the more certainly to embrace the latter. In the judgment of the present writer, Parmenides, while he denied the real existence of plurality, recognized its apparent existence, and consequently, however little value he might attach to opinion, was bound to take account of it: "pour celui même qui nie l'existence réelle de la nature," says Renouvier, "il reste encore à faire une histoire naturelle de l'apparence et de l'illusion."

The teaching of Parmenides variously influenced both his immediate successors and subsequent thinkers. By his recognition of an apparent plurality supplementary to the real unity, he effected the transition from the monism of the first physical succession to the pluralism of the second. While Empedocles and Democritus are careful to emphasize their dissent from "Truth," it is obvious that "Opinion" is the basis of their cosmologies. The doctrine of the deceitfulness of "the undiscerning eye and the echoing ear" soon established itself, though the grounds upon which Anaxagoras, Empedocles, and Democritus maintained it were not those which were alleged by Parmenides. Indirectly, through the dialectic of his pupil and friend Zeno and otherwise, the doctrine of the inadequacy of sensation led to the humanist movement, which for a time threatened to put an end to philosophical and scientific speculation. But the positive influence of Parmenides's teaching was not yet exhausted. To say that the Platonism of Plato's later years, the Platonism of the *Parmenides*, the *Philebus*, and the *Timæus*, is the philosophy of Parmenides enlarged and reconstituted, may perhaps seem paradoxical in the face of the severe criticism to which Eleaticism is subjected, not only in the *Parmenides*, but also in the *Sophist*. The criticism was, however, preparatory to a reconstruction. Thus may be explained the selection of an Eleatic stranger to be the chief speaker in the latter, and of Parmenides himself to take the lead in the former. In the *Sophist* criticism predominates over reconstruction, the Zenonian logic being turned against the Parmenidean metaphysic in such a way as to show that both the one and the other need revision: see 241 D, 244 B sq., 257 B sq., 258 D. In particular, Plato taxes Parmenides with his inconsistency in attributing (as he certainly did) to the fundamental unity extension and sphericity, so that "the worshipped  $\delta\nu$  is after all a pitiful  $\mu\eta$   $\delta\nu$ " (W. H. Thompson). In the *Parmenides* reconstruc-



tion predominates over criticism—the letter of Eleaticism being here represented by Zeno, its spirit, as Plato conceived it, by Parmenides. Not the least important of the results obtained in this dialogue is the discovery that, whereas the doctrine of the “one” and the “many” is suicidal and barren so long as the “solitary one” and the “indefinitely many” are absolutely separated (137 C sq. and 163 B sq.), it becomes consistent and fruitful as soon as a “definite plurality” is interpolated between them (142 B sq., 157 B sq., 160 B sq.). In short, Parmenides was no idealist, but Plato recognized in him, and rightly, the precursor of idealism.

*Bibliography.*—The fragments have been edited and annotated by G. G. Füllobron (*Fragmente des Parménides*, Züllrichau, 1795), C. A. Brandis (*Commentationes Eleaticæ*, Altona, 1813), S. Karsten (*Philos. Græcor. Reliquiæ*, I., ii., Amsterdam, 1835), F. W. A. Mullach (*Aristotelis de Metæ. Xenoph. et Gorg. disp. cum Eleaticorum fragm.*, Berlin, 1845; reprinted in the *Fragmenta Philos. Græcor.*, Paris, 1860, i. 109-130), T. Vatke (*Parmenidis doctrina qualis fuit, diss. inaug.*, Berlin, 1864), and H. Stein (*Die Fragmente des Parmenides resp. Platons*, in the *Symbola Philologorum Bonnensium in honorem F. Ritscheli collecta*, Leipzig, 1867, ii. 763-806). The study of Karsten and Stein jointly is recommended. The well-known *Historia Philosophiæ Gr. et Rom.* of Ritter and Preller contains all the important fragments. The extant remains have been translated into English hexameters by T. Davidson (*Journal of Speculative Philosophy*, St Louis, Mo., 1870, iv. 1-16), and paraphrased in English prose by W. L. Courtney (*Studies in Philosophy*, London, 1882, pp. 1-25).

The philosophical system has been treated by several of the writers already mentioned, especially Brandis, Karsten, and Vatke, by F. Riaux (*Essai sur Parménide d'Élée*, Paris, 1840), and by the historians of Greek philosophy, of whom it will suffice here to mention C. A. Brandis (*Handb. d. Griechisch-Römischen Philosophie*, Berlin, 1835), G. W. F. Hegel (*Vorlesungen über d. Geschichte d. Philosophie*, Berlin, 1840), Ch. Renouvier (*Manuel de Philosophie Ancienne*, Paris, 1844), L. Strümpell (*Gesch. d. theoretischen Philosophie d. Griechen*, Leipzig, 1854), J. F. Ferrier (*Lectures on Greek Philosophy*, Edinburgh, 1866), J. E. Erdmann (*Grundriss d. Gesch. d. Philosophie*, 2d ed., Berlin, 1869), A. Schwegler (*Gesch. d. Griech. Philos.*, 2d ed., Tübingen, 1870), F. Ueberweg (*Grundriss d. Gesch. d. Philosophie*, 4th ed., Berlin, 1871; English translation, 8d ed., London, 1880), E. Zeller (*Die Philosophie d. Griechen*, 4th ed., Leipzig, 1876; English translation, *Presocratic Philosophy*, London, 1881). On the cosmology, see A. B. Kriche (*Die theologischen Lehren d. Griechischen Denker*, Göttingen, 1840, pp. 97-116). On the relations of Eleaticism and Platonism, see W. H. Thompson, “On the Genuineness of Plato’s *Sophist*” in *Jour. of Philol.*, viii. 303 sq. (H. J. A.).

**PARMENIO** (Παρμενίων), a distinguished Macedonian general, born about 400 B.C., was the son of Philotas, and first appears in history as a favourite counsellor of Philip, in the course of whose reign he obtained a great victory over the Illyrians (356 B.C.), successfully upheld, at the head of an army, the Macedonian influence in Eubœa (342), and was appointed one of the commanders of the force that was sent to secure a footing in Asia, and to prepare for the future reduction of that country (336 B.C.). His influence became still greater in the succeeding reign; at Alexander’s council table he was always heard with deference, and in the field he was virtually second in command. He led the left wing of the army in the battles of the Granicus, Issus, and Arbela; and, while the king himself continued the pursuit of Darius into the wastes of Parthia and Hyrcania, Parmenio was entrusted with the task of completing the conquest of Media. Here he was stabbed by Cleander at the instance of the king, in 330, under circumstances which have been elsewhere described (see **ALEXANDER**, vol. i. p. 483).

**PARMIGLIANO** (1504-1540). The name of this celebrated painter of the Lombard school was, in full, Girolamo Francesco Maria Mazzuoli, or Mazzola; he dropped the name Girolamo, and was only known as Francesco. He has been more commonly named Il Parmigiano (or its diminutive, Il Parmigianino), from his native city, Parma. Francesco, born on 11th January 1504, was the son of a painter. Losing his father in early childhood, he was

brought up by two uncles, also painters, Michele and Pier-Ilario Mazzola. His faculty for the art developed at a very boyish age, and he addicted himself to the style of Correggio, who visited Parma in 1519. He did not, however, become an imitator of Correggio; his style in its maturity may be regarded as a fusion of Correggio with Raphael and Giulio Romano, and thus fairly original. Even at the age of fourteen (Vasari says sixteen) he had painted a Baptism of Christ, surprisingly mature. Before the age of nineteen, when he migrated to Rome, he had covered with frescos seven chapels in the church of S. Giovanni Evangelista, Parma. Prior to starting for the city of the popes in 1523, he deemed it expedient to execute some specimen pictures. One of these was a portrait of himself as seen in a convex mirror, with all the details of divergent perspective, &c., wonderfully exact,—a work which, both from this curiosity of treatment and from the beauty of the sitter—for Parmigiano was then “more like an angel than a man”—could not fail to attract. Arrived in Rome, he presented his specimen pictures to the pope, Clement VII., who gladly and admiringly accepted them, and assigned to the youthful genius the painting of the Sala de’ Pontefici, the ceilings of which had been already decorated by Giovanni da Udine. Patrons were willing to regard him as a second Raphael for art and for sweetness of manner, and he was almost as skilful at lute-playing as at painting; but, while fortune was winning him with her most insinuating smiles, the utter ruin of the sack by the Constable de Bourbon and his German and other soldiers overtook both Rome and Parmigiano. At the date of this hideous catastrophe he was engaged in painting that large picture which now figures in the London National Gallery, the Vision of St Jerome (with the Baptist pointing upward and backward to the Madonna and infant Jesus in the sky). It is said that through all the crash and peril of this barbarian irruption Parmigiano sat quietly before his vast panel, painting as if nothing had happened. A band of German soldiery burst into his apartment, breathing fire and slaughter; but, struck with amazement at the sight, and with some reverence for art and her votary (the other events of the siege forbid us to suppose that reverence for religion had any part in it), they calmed down, and afforded the painter all the protection that he needed at the moment. Their captain, being something of a connoisseur, exacted his tribute, however—a large number of designs. Rome was now no place for Parmigiano. He left with his uncle, intending apparently to return to Parma; but, staying in Bologna, he settled down there for a while, and was induced to remain three or four years. Here he painted for the nuns of St Margaret his most celebrated altarpiece (now in the Academy of Bologna), the Madonna and Child, with Margaret and other saints. This work became the idol of the Caracci and their school—Guido professing his preference for it even over the St Cecilia of Raphael.

Spite of the great disaster of Rome, the life of Mazzola had hitherto been fairly prosperous—the admiration which he excited being proportionate to his charm of person and manner, and to the precocity and brilliancy (rather than depth) of his genius; but from this time forward he became an unfortunate, and it would appear a soured and self-neglectful man. Greatly to his chagrin, a number of his drawings were stolen by his assistant for engraving purposes, Antonio da Trento. He painted, from observation without sittings, a portrait of the emperor Charles V. crowned by Fame, but through some mismanagement lost the advantages which it had bidden fair to procure him. In 1531 he returned to Parma, and was commissioned to execute an extensive series of frescos in the choir of the

church of S. Maria della Steccata. These were to be completed in November 1532; and half-payment, 200 golden scudi, was made to him in advance. A ceiling was allotted to him, and an arch in front of the ceiling; on the arch he painted six figures—two of them in full colour, and four in monochrome—Adam, Eve, some Virtues, and the famous figure (monochrome) of Moses about to shatter the tables of the law. But, after five or six years from the date of the contract, Parmigiano had barely made a good beginning with his stipulated work. According to Vasari, he neglected painting in favour of alchemy—he laboured over futile attempts to “congeal mercury,” being in a hurry to get rich anyhow. It is rather difficult to believe that the various graphic and caustic phrases which Vasari bestows upon this theory of the facts of Mazzola's life are altogether gratuitous and wide of the mark; nevertheless the painter's principal biographer, the Padre Affò, undertook to refute Vasari's statements, and most subsequent writers have accepted Affò's conclusions. Whatever the cause, Parmigiano failed to fulfil his contract, and was imprisoned in default. Promising to amend, he was released; but, instead of redeeming his pledge, he decamped to Casal Maggiore, in the territory of Cremona. Here, according even to Vasari, he relinquished alchemy, and resumed painting; yet he still hankered (or is said by Vasari to have hankered) after his retorts and furnaces, lost all his brightness, and presented a dim, poverty-stricken, hirsute, and uncivilized aspect. A fever carried him off on 24th August 1540, before he had completed his thirty-seventh year. By his own desire, he was buried naked in the church of the Servites called La Fontana, near Casal Maggiore.

Grace has always and rightly been regarded as the chief artistic endowment of Parmigiano,—grace which is genuine as an expression of the painter's nature, but partakes partly of the artificial and affected in its developments. “Un po' di grazia del Parmigianino” (a little, or, as we might say, just a spice, of Parmigianino's grace) was among the ingredients which Agostino Caracci's famed sonnet desiderates for a perfect picture. Mazzola constantly made many studies of the same figure, in order to get the most graceful attainable form, movement, and drapery—the last being a point in which he was very successful. The proportions of his figures are over-long for the truth of nature—the stature, fingers, and neck; one of his Madonnas, now in the Pitti Gallery, is currently named “La Madonna del collo lungo.” He used to ponder long over a picture, and construct it in his head before he began actual work upon it; he then proceeded rapidly, with a resolute pencil, his great exercise in drawing standing him in good stead. His pictures were executed with diligence and finish, although he was not on the whole a sedulous worker. Neither expression nor colour is a strong point in his works; the figures in his compositions are generally few—the chief exception being the picture of Christ Preaching to the Multitude. He was good at portraits and at landscape backgrounds, and famous for drawings; he etched a few plates, being apparently the earliest Italian painter who was also an etcher; but the statement that he produced several woodcuts does not seem to be correct.

The most admired easel-picture of Parmigiano is the Cupid Making a Bow, with two children at his feet, one crying, and the other laughing. This was painted in 1536 for Francesco Boiardi of Parma, and is now in the gallery of Vienna. There are various replicas of it, and some of these may perhaps be from Mazzola's own hand. Of his portrait-painting, two interesting examples are the likeness of Amerigo Vespucci (after whom America is named) in the Studj Gallery of Naples, and the painter's own portrait in the Uffizi of Florence. One of Parmigiano's principal pupils was his cousin, Girolamo di Michele Mazzola; probably some of the works attributed to Francesco are really by Girolamo. (W. M. R.)

PARNASSUS, a mountain of Greece, in the south of Phocia, rising over the town of Delphi. It had two prominent peaks, Tithorea and Lycoreia, besides smaller ones, Hyampeia, Nauplia, &c. Parnassus was one of the most holy mountains in Greece, hallowed by the worship of Apollo, of the Muses, and of the Corycian nymphs, and by the orgies of the Bacchantes. The Delphic oracle, the Castalian fountain, and the Corycian cave were all situated among the clefts in its densely wooded sides.

PARNELL, THOMAS (1679-1718), has a place in literature among the minor Queen Anne poets. He was a man of some private fortune, being the head of an English family settled in Ireland, and inheriting landed property both there and in Cheshire. Born in Dublin in 1679, and educated at Trinity College, he took orders and obtained various preferments in the Irish Church. But both as a landowner and a clergyman he was an absentee, and spent most of his time in London, where he was patronized by Harley, and received into the intimate friendship of Swift and Pope. He was a member of the Scriblerus Club, and co-operated in burlesquing the “Dunces” and defending the Tory ministry, at the same time attaining some repute in the London pulpits as a preacher. An easy-going wit, with interests mainly in literature and society, he made his peace with the Whigs on the accession of George, but still continued his alliance with Pope. When Pope published his *Homer*, Parnell produced a translation of the *Battle of the Frogs and Mice* (1717), and indirectly defended Pope against his critics in the accompanying “remarks of Zoilus” on the principles of translation. After his death in 1718—he died on his way to a living in Ireland—Pope published a collection of his poems. They are nearly all translations and adaptations. The best known of them, *The Hermit*, is sometimes overpraised on the supposition that it is original; all that Parnell did was to trick out a tale from the *Gesta Romanorum* with reflexions in the “elevated diction” of the period. “His praise,” Johnson says with justice, “must be derived from the easy sweetness of his diction; in his verses there is more happiness than pains; he is sprightly without effort, and always delights, though he never ravishes; everything is proper, yet everything seems casual.”

PARNY, ÉVARISTE DÉSIÈRE DE FORGES, VICOMTE DE (1753-1814), was born in the Isle of Bourbon on 6th February 1753. He was sent to France at nine years old and was educated at Rennes, and in 1771 entered the army. He was, however, shortly recalled to Bourbon, where he fell in love with a young lady whom he celebrated poetically as Éléonore. His earlier biographers state her to have been called Esther de Beif, while the later give her the name of Mdlle. Troussaille. His suit was not favoured by the lady's family. He returned to France, published his *Poésies Érotiques* in 1778, was saluted by Voltaire on his last visit to Paris as “Mon cher Tibulle,” and acquired at once a reputation for graceful and natural verse-writing which, though he lived many years and produced much inferior work, never entirely left him. He had some fortune, and he established himself near Paris. The Revolution impaired his means, but did not otherwise trouble him; indeed he obtained an appointment under it. In 1796 (he had published much else, but nothing of importance) appeared the *Guerre des Dieux*, a poem in the style of Voltaire's *Pucelle*, directed against Christianity, and containing some wit, but much more that is simply dull and indecent. It commended itself to the times, however, and the author is said to have afterwards amplified it into a *Christianiside*, the manuscript of which the Government of Louis XVIII., according to the story, bought for thirty thousand francs and destroyed. Parny devoted himself in his later years almost entirely to the religious or anti-religious and political burlesque. Under the consulate and the empire he turned his wrath from Christianity to England, and produced in 1805 an extraordinary allegoric poem attacking George III., his family, and his subjects, under the eccentric title of “Goddam! Goddam! par un French-dog.” The body of the poem is quite worthy of its title. Another and longer poem called *Les Rose-Croix*, though less extravagant, is still less readable; and indeed all Parny's later work is valueless except

as a curiosity. His early love poems or elegies, however, and some slight miscellaneous work of his more mature years, show, with something of the artificiality of the time, a remarkable grace and ease, a good deal of tenderness, and not inconsiderable fancy and wit. One famous piece, the *Elegy on a Young Girl*, is scarcely to be excelled in its kind. In the natural comparison of Parny with his younger English contemporary, Moore, whom he in many ways resembles, the palm must be given to the French poet for precision and enduring elegance of style at his best, though he has less melody and tenderness, and though he condescended to much work far inferior both morally and artistically to the worst of Moore's.

There is no complete edition of Parny's works, and the loss is small. There are several good selections containing almost everything of real value, among which may be mentioned that of Garnier Frères.

**PARODY** (*σάρασμα*, literally a song sung beside, a comic parallel) may be defined as an imitation of the form or style of a serious writing in matter of a meaner kind so as to produce a ludicrous effect. The lowest savages show a turn for comic mimicry, and it is almost as old in European literature as serious writing. The *Batrachomyomachia*, or "Battle of the Frogs and Mice," a travesty of the heroic epos, was ascribed at one time to Homer himself; and it is probably at least as old as the 5th century B.C. The great tragic poetry of Greece very soon provoked the parodist. Aristophanes parodied the style of Euripides in the *Acharnians* with a comic power that has never been surpassed. The debased grand style of mediæval romance was parodied in *Don Quixote*. Shakespeare parodied the extravagant heroics of an earlier stage, and was himself parodied by Marston, incidentally in his plays and elaborately in a roughly humorous burlesque of *Venus and Adonis*. The wits of the Queen Anne age succeeded better in mock-heroics than in serious composition. A century later the most celebrated parodists were the brothers Smith, whose *Rejected Addresses* may be regarded as classic in this kind of artificial production. The Victorian age has produced a plentiful crop of parodists in prose and in verse, in dramatic poetry and in lyric poetry. By common consent, the most subtle and dexterous of metrical parodists is the late Mr C. S. Calverley, who succeeded in reproducing not merely tricks of phrase and metre, but even manneristic turns of thought. Johnson's dictum about pastoral poetry, that most of it is "easy, vulgar, and therefore disgusting," might be applied to parody; but Calverley would escape the censure.

**PAROS**, or **PARO**, an island in the *Ægean Sea*, one of the largest of the group of the Cyclades, with a population of 8000. It lies to the west of Naxos, from which it is separated by a channel about 6 miles broad, and with which it is now grouped together, in popular language, under the common name of Paronaxia. It is in 37° N. lat. and 25° 10' E. long. Its greatest length from north-east to south-west is 13 miles, and its greatest breadth 10 miles. It is formed of a single mountain about 2400 feet high, sloping evenly down on all sides to a maritime plain, which is broadest on the north-east and south-west sides. The island is composed of marble, though gneiss and mica-schist are to be found in a few places. Grey and bare rises the mountain, but on the level ground as well as on some of the lower slopes corn and vines are cultivated with success. A sweetish dark red wine is exported in considerable quantities. The island is almost treeless; the olives, which formerly yielded abundance of oil, were cut down by the Venetians for firewood in the war of Candia. The capital, Paroikia or Parikia (Italian, *Parochia*), situated on a bay on the north-west side of the island, occupies the site of the ancient capital Paros. Its harbour admits small vessels; the

entrance is dangerous on account of rocks. Houses built in the Italian style with terraced roofs, shadowed by luxuriant vines, and surrounded by gardens of oranges and pomegranates, give to the town a picturesque and pleasing aspect. Here on a rock beside the sea are the remains of a mediæval castle built almost entirely of ancient marble remains. Similar traces of antiquity in the shape of bas-reliefs, inscriptions, columns, &c., are numerous in the town. Outside the town is the church of Katapoliani (ἡ Ἐκαποσταυλιανή), well known in the Archipelago. On the north side of the island is the bay of Naoussa (Nausa) or Agoussa, forming a safe and roomy harbour. In ancient times it was closed by a chain or boom. Another good harbour is that of Drios on the south-east side, where the Turkish fleet used to anchor on its annual voyage through the *Ægean*. The three villages of Tragoules, Marmora, and Kepidi (Κηρίδι, pronounced Tschipidi), situated on an open plain on the eastern side of the island, and rich in remains of antiquity, probably occupy the site of an ancient town. They are known together as the "villages of Kephala," from the steep and lofty headland of Kephala. On this headland stands an abandoned monastery of St Anthony, amidst the ruins of a mediæval castle, which belonged to the Venetian family of the Venieri, and was gallantly though fruitlessly defended against the Turkish general Barbarossa in 1537. In antiquity the island contained a famous altar, the sides of which were said to be a stadium (806 feet) long. But the celebrated marble quarries are the real centre of interest of the island. They lie on the northern side of the mountain anciently known as Marpessa (afterwards Capresso), a little below a former convent of St Mina. The marble, which was employed by Phidias, Praxiteles, and other great Greek sculptors, was obtained by means of subterranean quarries driven horizontally or at a descending angle into the rock, and the marble thus quarried by lamplight got the name of Lychnites, Lychnæus (from *lychnos*, a lamp), or Lygkos (Plin., *H. N.*, xxvi. 5, 14; Plato, *Eryxias*, 400 D; Athen., v. 2050; Diod. Sic., 2, 52). Several of these tunnels are still to be seen. At the entrance to one of them is a celebrated bas-relief dedicated to the Nymphs by one Adamas, of the Thracian tribe of the Odryæ; it represents a festival of Silenus or Pan.

*History*.—Like the rest of the Cyclades, Paros seems to have been peopled at an early date by Carians (Herod., i. 171; Thuc., i. 4)—perhaps also by the Phœnicians, whom we know from the Greek historians to have occupied other islands in the *Ægean*, including the neighbouring Thera (Herod., ii. 44; iv. 147; compare Thuc., i. 8). The institution of a form of sacrifice to the Graces, apparently peculiar to Paros, at which neither garlands nor flutes were made use of, was ascribed to Minos. The story that Paros was colonized by one Paros of Parrhasia, who brought with him a colony of Arcadians to the island (Heraclides, *De Hæbus Publicis*, 8; Steph. Byz., s.v. Πάρος), is one of those etymologizing fictions in which Greek legend abounds. Ancient names of the island are said to have been Plateia (or Pactia), Demetrias, Zacynthus, Hyria, Hylæssa, Minos, and Cabarnis (Steph. Byz.). From Athens the island afterwards received a colony of Ionians (Schol. Dionys., *Per.*, 525; comp. Herod., i. 171), under whom it attained a high degree of prosperity. It sent out colonies to Thasos (Thuc., iv. 104; Strabo, 457) and Parium on the Hellespont. In the former colony, which was planted in the 15th or 18th Olympiad, the poet Archilochus, a native of Paros, is said to have taken part. As late as 885 B.C. the Parians, in conjunction with Dionysius of Syracuse, founded a colony on the Illyrian island of Pharos (Diod. Sic., xv. 18). So high was the reputation of the Parians that they were chosen by the people of Miletus to arbitrate in a party dispute (Herod., v. 28 sq.). Shortly before the Persian War Paros seems to have been a dependency of Naxos (Herod., v. 81). In the Persian War Paros sided with the Persians and sent a trireme to Marathon to support them. In retaliation, the capital Paros was besieged by an Athenian fleet under Miltiades, who demanded a fine of 100 talents. But the town offered a vigorous resistance, and the Athenians were obliged to sail away after a siege of twenty-six days, during which they had laid the island waste. It was at a temple of Demeter Thesmo-

phorus in Paros that Miltiades received the hurt of which he afterwards died (Herod. vi. 133-136). By means of an inscription Ross was enabled to identify the site of the temple; it lies, in agreement with the description of Herodotus, on a low hill beyond the boundaries of the town. Paros also sided with Xerxes against Greece, but after the battle of Artemisium the Parian contingent remained in Cythnos watching the progress of events (Herod., viii. 67). For this unpatriotic conduct the islanders were punished by Themistocles, who exacted a heavy fine (Herod., viii. 112). Under the Athenian naval confederacy, Paros paid the highest tributes of all the islands subject to Athens,—80 talents annually, according to the assessment of Olymp. 88, 4 (429 a.c.). Little is known of the constitution of Paros, but inscriptions seem to show that it was democratic, with a senate (*Boule*) at the head of affairs (*Corpus Inscript.*, 2376-2383; Ross, *Inscr. Ined.*, ii. 147, 148). In 410 a.c. the Athenian general Theramenes found an oligarchy at Paros; he deposed it and restored the democracy (Diod. Sic., xiii. 47). Paros was included in the new Athenian confederacy of 378 a.c., but afterwards, along with Chios, it renounced its connexion with Athens, probably about 357 a.c. Thenceforward the island lost its political importance. From the inscription of Adule we learn that the Cyclades, and consequently Paros, were subject to the Ptolemies of Egypt. Afterwards they passed under the rule of Rome. When the Latins made themselves masters of Constantinople, Paros, like the rest, became subject to Venice. In 1537 it was conquered by the Turks. The island now belongs to the kingdom of Greece.

See Tournesfort, *Voyage de Levant*, vol. i. p. 232 sq., Lyons, 1717; Clarke, *Travels*, vol. iii., London, 1814; Leake, *Travels in Northern Greece*, vol. iii. p. 81 sq., London, 1825; Prokesch, *Denkwürdigkeiten*, vol. ii. p. 19 sq., Stuttgart, 1836; Ross, *Reisen auf den griechischen Inseln*, vol. i. p. 44 sq., Stuttgart and Tübingen, 1840; Fiedler, *Reise durch alle Theile des Königreichs Griechenland*, vol. ii. p. 179 sq., Leipzig, 1841; Barilan, *Geographie von Griechenland*, vol. ii. p. 483 sq., Leipzig, 1872.

PARQUETRY is a kind of mosaic of wood used for ornamental flooring. Materials contrasting in colour and grain, such as oak, walnut, cherry, lime, pine, &c., are employed; and in the more expensive kinds the richly coloured tropical woods are also used. The patterns of parquet flooring are entirely geometrical and angular (squares, triangles, lozenges, &c.), curved and irregular forms being avoided on account of the expense and difficulty of fitting. There are two classes of parquetry in use—veneers and solid parquet. The veneers are usually about a quarter of an inch in thickness, and are laid over already existing floors. Solid parquet of an inch or more in thickness consists of single pieces of wood grooved and tongued together, having consequently the pattern alike on both sides. It forms in itself a sufficient floor of great strength and durability; but veneer, on the other hand, is generally more elegant and complex in design.

PARR. This name was originally applied to small Salmonoids which are abundant in British rivers, and were for a long time considered to constitute a distinct species (*Salmo salmulus*). They possess the broad head, short snout, and large eye characteristic of young Salmonoids, and are ornamented on the sides of the body and tail with about eleven or more broad dark cross-bars, the so-called parr-marks. However, John Shaw proved, by experiment, that these fishes represent merely the first stage of growth of the salmon, before it assumes, at an age of two years, and when about six inches long, the silvery smolt-dress preparatory to its first migration to the sea. The parr-marks are produced by a deposit of black pigment in the skin, and appear very soon after the exclusion of the fish from the egg; they are still visible for some time below the new coat of scales of the smolt-stage, but have entirely disappeared on the first return of the young salmon from the sea. Although the juvenile condition of the parr is now almost universally admitted, it is a remarkable fact, which has not yet received a satisfactory explanation, that many male parr, from 1 to 8 inches long, have their sexual organs fully developed, and that their milt has all the fertilizing properties of the seminal fluid of a full-grown and sexually matured salmon. On the other hand, no female parr has ever been obtained with mature ova. Not only the salmon, but also the other species of *Salmo*, the grayling, and probably also the *Coregoni*, pass through a

parr-stage of growth. The young of all these fishes are barred, the salmon having generally eleven or more bars, and the parr of the migratory trout from nine to ten, or two or three more than the river-trout. In other respects these parr are very similar to one another; and in the first year of their life it is very difficult and sometimes almost impossible to ascertain their parentage, whilst in the second year the specific characteristics become more and more conspicuous. In some of the small races or species of river-trout the parr-marks are retained throughout life, but subject to changes in intensity of colour.

PARR, SAMUEL (1747-1825), the son of Samuel Parr, surgeon at Harrow-on-the-Hill, was born there 15th January 1747. At Easter 1753 he was sent to Harrow School as a free scholar, where he made the acquaintance of many pupils, such as Bishop Bennet, Sir William Jones, and Warburton Lytton, who became eminent in after life. They read in the same class, they shared in the same sports, and their friendship lasted from youth to age. As Parr was destined for his father's profession, he was removed from school in the spring of 1761, and for the next few years assisted his father in his practice. When the old surgeon realized that his son was but ill-adapted for this pursuit, the boy was sent to Emmanuel College, Cambridge (autumn of 1765), but on his father's death shortly afterwards he was compelled, through lack of means, to return to Harrow. From February 1767 to the close of 1771 he acted as head assistant at Harrow School to Dr Sumner, a teacher whom he idolized, and had under his care many pupils, of whom Sheridan was the best known. When the headmaster died in September 1771 Parr became a candidate for the place, but was rejected, chiefly on account of his youth, whereupon he started another school at Stanmore, and drew after him about forty of his former scholars. After a trial of five years he found himself unable to bear up against the attractions of his old establishment, and dismissed the boys entrusted to his charge, becoming first the headmaster of Colchester Grammar School (1776-78) and then of Norwich School (1778-86). The small rectory of Asterby in Lincolnshire was conferred upon him in 1780, and it was followed three years later by the vicarage of Hatton near Warwick. Though he exchanged this latter benefice for Wadenhoe in Northamptonshire in 1789, he stipulated to be allowed to reside, as assistant curate, in the parsonage of Hatton. In this retirement he spent the rest of his days, cheered by the attractions of an excellent library, described by Mr H. G. Bohn in *Bibliotheca Parriana* (1827), and the converse of his classical friends, some of whom, like Porson and E. H. Barker, passed many months in his company. The degree of LL.D. was conferred on him by the university of Cambridge in 1781. Parr died at Hatton vicarage, 6th March 1825, and was buried in the chancel of its church. He had to middle age felt the pressure of poverty, but through the gift in 1788 of the prebendal stall of Wenlock Barns in St Paul's Cathedral (then worth only a reserved rent of £20 a year, but on the lapse of the lease in 1804 a preferment of considerable value), and through the purchase for him by his friends in 1789 of an annuity of £300, he died possessed of a large fortune.

Dr Parr's writings fill several volumes, but they are all beneath the reputation which he acquired through the variety of his knowledge and the dogmatism of his conversation. The chief of them are his character of Charles James Fox; his Latin preface, a long eulogy of Burke, North, and Fox, to a new edition of three books of Bellendenus; and his reprint of the *Tracts of Warburton and a Warburtonian, not admitted into their works*, a volume still not without interest for its scathing exposure of Warburton and Hurd. The character of Parr's compositions may be gathered from a passage in the *Edinburgh Review* (October 1802) on his Spital sermon, "a discourse of no common length . . . an immeasurable mass of notes which appear to concern every learned thing, every

learned man, and almost every unlearned man since the beginning of the world." Even amid the terrors of the French Revolution he adhered to Whiggism, and his correspondence included every man of eminence, either literary or political, who adopted the same creed. There are two memoirs of his life, one by the Rev. William Field (1828, 2 vols.), the other, with his works and his letters, by John Johnstone (1828, 8 vols.); and E. H. Barker published in 1828-29 two volumes of *Parrissia*, a confused mass of information on Parr and his friends. An essay on his life is included in De Quincey's works, vol. v., and a little volume of the *Aphorisms, Opinions, and Reflections of the late Dr Parr* appeared in 1826.

**PARRAMATTA**, a town of New South Wales, at the head of the navigation of the Parramatta river, and 14 miles to the west of Sydney, with which it is connected by railway, was one of the earliest inland settlements, and the seat of many of the public establishments connected with the working of the convict system. Many of these still remain in another form (the district hospital, the lunatic asylum, the gaol, two asylums for the infirm and destitute, the Protestant and Catholic orphan schools), involving a Government expenditure which partly sustains the business of the town. Parramatta was one of the earliest seats of the tweed manufacture, but its principal industrial dependence has been on the fruit trade. With the exception of Prospect and Pennant Hills, where there is an outburst of trap rock, the surface soil is the disintegration of the Wainamatta shale, which is well suited for oranges and orchards. The value of the annual fruit crop is estimated at £100,000. The earlier governors had their country residence near the town, but the domain is now a public park in the hands of the municipality. Close by was an early observatory where, in 1822, were made the observations for the *Parramatta Catalogue*, numbering 7385 stars, but it has long been abandoned. The Church of England grammar school (King's School), which accommodates ninety boarders, is on the north side of the river. The population in 1881 was 8453.

**PARRHASIUS**, of Ephesus, was one of the greatest painters of Greece. He settled in Athens, and may be ranked among the Attic artists. The period of his activity is fixed by the anecdote which Xenophon records of the conversation between him and Socrates on the subject of art; he was therefore distinguished as a painter before 399 B.C. Seneca relates a tale that Parrhasius bought one of the Olynthians whom Philip sold into slavery, 346 B.C. (see **OLYNTHUS**), and tortured him in order to have a model for his picture of Prometheus; but the story, which is similar to one told of Michelangelo, is chronologically impossible. Another tale recorded of him describes his contest with Zeuxis. The latter painted some grapes so perfectly that birds came to peck at them. He then called on Parrhasius to draw aside the curtain and show his picture, but, finding that his rival's picture was the curtain itself, he acknowledged himself to be surpassed, for Zeuxis had deceived birds, but Parrhasius had deceived Zeuxis. The arrogance and vanity of Parrhasius are the subject of many other anecdotes. He dressed himself in the purple robe, golden crown, and staff of a king, called himself the prince, and boasted his descent from Apollo. As to his artistic position, it is impossible for us in the entire absence of direct evidence to do more than repeat the opinion of ancient critics, as retailed by Pliny. He was universally placed in the very first rank among painters. His skilful drawing of outlines is especially praised, and many of his drawings on wood and parchment were preserved and highly valued by later painters for purposes of study. He first attained skill in making his figures appear to stand out from the background. His picture of Theseus adorned the Capitol in Rome. His other works, besides the obscene subjects with which he is said to have amused his leisure, are chiefly mythological groups. A picture of the Demos, the personified People of

Athens, is famous; according to the story, the twelve prominent characteristics of the people, though apparently quite inconsistent with each other, were distinctly expressed in this figure. The way in which this was accomplished is an insoluble riddle.

**PARROT**, according to Prof. Skeat (*Etymol. Dictionary*, p. 422), from the French *Perrot* or *Pierrot*, a proper name and the diminutive of *Pierre*,<sup>1</sup> the name given genera "a large and very natural group of Birds, which for more than a score of centuries have attracted attention, not only from their gaudy plumage, but, at first and chiefly, it would seem, from the readiness with which many of them learn to imitate the sounds they hear, repeating the words and even phrases of human speech with a fidelity that is often astonishing. It is said that no representation of any Parrot appears in Egyptian art, nor does any reference to a bird of the kind occur in the Bible, whence it has been concluded that neither painters nor writers had any knowledge of it. Aristotle is commonly supposed to be the first author who mentions a Parrot; but this is an error, for nearly a century earlier Ctesias in his *Indica* (cap. 3),<sup>2</sup> under the name of *Bérracos* (*Bittacus*), so neatly described a bird which could speak an "Indian" language—naturally, as he seems to have thought—or Greek—if it had been taught so to do—about as big as a Sparrow-Hawk (*Hierax*), with a purple face and a black beard, otherwise blue-green (*cyaneus*) and vermilion in colour, so that there cannot be much risk in declaring that he must have had before him a male example of what is now commonly known as the Blossom-headed Parakeet, and to ornithologists as *Palæornis cyanocephalus*, an inhabitant of many parts of India. Much ingenuity has been exercised in the endeavour to find the word whence this, and the later form of the Greek name, was derived, but to little or no purpose. After Ctesias comes Aristotle's *ψιττάκη* (*Psittake*), which Sundevall supposes him to have described only from hearsay, a view that the present writer is inclined to think insufficiently supported. But this matters little, for there can be no doubt that the Indian conquests of Alexander were the means of making the Parrot better known in Europe, and it is in reference to this fact that another Eastern species of *Palæornis* now bears the name of *P. alexandri*, though from the localities it inhabits it could hardly have had anything to do with the Macedonian hero. That Africa had Parrots does not seem to have been discovered by the ancients till long after, as Pliny tells us (vi. 29) that they were first met with beyond the limits of Upper Egypt by explorers employed by Nero. These birds, highly prized from the first, reprobated by the moralist, and celebrated by more than one classical poet, in the course of time were brought in great numbers to Rome, and ministered in various ways to the luxury of the age. Not only were they lodged in cages of tortoise-shell

<sup>1</sup> "Parakeet" (in Shakespeare, *1 Hen. IV.*, ii. 3, 88, "Parquito") is said by the same authority to be from the Spanish *Perquito* or *Perroqueto*, a small Parrot, diminutive of *Perico*, a Parrot, which again may be a diminutive from *Pedro*, the proper name. Parakeet (spelt in various ways in English) is usually applied to the smaller kinds of Parrots, especially those which have long tails, not as *Perroquet* in French, which is used as a general term for all Parrots, *Perruche*, or sometimes *Perriche*, being the ordinary name for what we call Parakeet. The old English "Popinjay" and the old French *Papepant* have almost passed out of use, but the German *Papagei* and Italian *Papagallo* still continue in vogue. These names can be traced to the Arabic *Babaghā*; but the source of that word is unknown. The Anglo-Saxon name of the Parrot, a river in Somerset, is *Pedra* or *Pedrida*, which at first sight looks as if it had to do with the proper name, *Petrus*; but Prof. Skeat believes there is no connexion between them—the latter portion of the word being *rid*, a stream.

<sup>2</sup> The passage seems to have escaped the notice of all naturalists except Broderip, who mentioned it in his article "Psittacidae," in the *Penny Cyclopædia* (vol. xix. p. 83).

and ivory, with silver wires, but they were professedly esteemed as delicacies for the table, and one emperor is said to have fed his lions upon them! But there would be little use in dwelling longer on these topics. With the decline of the Roman empire the demand for Parrots in Europe lessened, and so the supply dwindled, yet all knowledge of them was not wholly lost, and they are occasionally mentioned by one writer or another until in the 15th century began that career of geographical discovery which has since proceeded uninterruptedly. This immediately brought with it the knowledge of many more forms of these birds than had ever before been seen, for whatever races of men were visited by European navigators—whether in the East Indies or the West, whether in Africa or in the islands of the Pacific—it was almost invariably found that even the most savage tribes had tamed some kind of Parrot; and, moreover, experience soon showed that no bird was more easily kept alive on board ship and brought home, while, if it had not the merit of "speech," it was almost certain to be of beautiful plumage. Yet so numerous is the group that even now new species of Parrots are not uncommonly recognized, though, looking to the way in which the most secluded parts of the world are being ransacked, we must soon come to an end of this.

The home of the vast majority of Parrot-forms is unquestionably within the tropics, but the popular belief that Parrots are tropical birds only is a great mistake. In North America the Carolina Parakeet, *Conurus carolinensis*, at the beginning of the present century used to range in summer as high as the shores of Lakes Erie and Ontario—a latitude equal to that of the south of France; and even within the last forty years it reached, according to trustworthy information, the junction of the Ohio and the Mississippi, though now its limits have been so much curtailed that its occurrence in any but the Gulf States is doubtful. In South America, at least four species of Parrots are found in Chili or La Plata, and one, *Conurus patagonus*, is pretty common on the bleak coast of the Strait of Magellan. In Africa, it is true that no species is known to extend to within some ten degrees of the tropic of Cancer; but *Pionias robustus* inhabits territories lying quite as far to the southward of the tropic of Capricorn. In India the northern range of the group is only bounded by the slopes of the Himalaya, and further to the eastward Parrots are not only abundant over the whole of the Malay Archipelago, as well as Australia and Tasmania, but two very well-defined Families are peculiar to New Zealand and its adjacent islands (see KAKAPO, vol. xiii. p. 825; and NESTOR, vol. xvii. p. 354). No Parrot has recently inhabited the Palearctic Region,<sup>1</sup> and but one (the *Conurus carolinensis*, just mentioned) probably belongs to the Nearctic; nor are Parrots represented by many different forms in either the Ethiopian or the Indian Regions. In continental Asia the distribution of Parrots is rather remarkable. None extend further to the westward than the valley of the Indus,<sup>2</sup> which, considering the nature of the country in Baluchistan and Afghanistan, is perhaps intelligible enough; but it is not so easy to under-

stand why none are found either in Cochin China or China proper; and they are also wanting in the Philippine Islands, which is the more remarkable and instructive when we find how abundant they are in the groups a little further to the southward. Indeed Mr Wallace has well remarked that the portion of the earth's surface which contains the largest number of Parrots, in proportion to its area, is undoubtedly that covered by the islands extending from Celebes to the Solomon group. "The area of these islands is probably not one-fifteenth of that of the four tropical regions, yet they contain from one-fifth to one-fourth of all the known Parrots" (*Geogr. Distr. Animals*, ii. p. 330). He goes on to observe also that in this area are found many of the most remarkable forms—all the red Lories, the great black Cockatoos, the pigmy *Nasiterna*, and other singularities. In South America the species of Parrots, though numerically nearly as abundant, are far less diversified in form, and all of them seem capable of being referred to two or, at most, three sections. The species that has the widest range, and that by far, is the common Ring-necked Parakeet, *Palæornis torquatus*, a well-known cage-bird which is found from the mouth of the Garubia across Africa to the coast of the Red Sea, as well as throughout the whole of India, Ceylon, and Burmah to Tenasserim.<sup>3</sup> On the other hand there are plenty of cases of Parrots which are restricted to an extremely small area—often an island of insignificant size, as *Conurus xantholæmus*, confined to the island of St Thomas in the Antilles, and *Palæornis casti* to that of Rodrigues in the Indian Ocean—to say nothing of the remarkable instance of *Nestor productus* before mentioned (vol. xvii. p. 355).

The systematic treatment of this very natural group of birds has long been a subject of much difficulty, and the difference of opinion among those who have made it their study is most striking, for there is hardly an approach to unanimity to be found, beyond the somewhat general belief which has grown up within the last forty years that the Parrots should be regarded as forming a distinct Order of the Class, though there are some men, justly accounted authorities, who even question this much. A few systematists, among whom Bonaparte was chief, placed them at the top of the Class, conceiving that they were the analogues of the *Primates* among mammals. Prof. Huxley has recognized the *Psittacomorphs* as forming one of the principal groups of Carinate birds, and, by whatever name we call them, that much seems to be evident. It will here, however, be unnecessary to discuss the exact rank which the Parrots as a group should hold, for sufficient on that score has already been said above (ORNITHOLOGY, p. 47), and it is quite enough of a task to consider the most natural or—if we cannot hope at present to reach that—at least the most expedient way of subdividing them. It must be admitted as a reproach to ornithologists that so little satisfactory progress has been made in this direction, for of that the existing differences of opinion—differences as wide as have ever existed in any branch of ornithic taxonomy—are sufficient proof. Moreover, the result is all the more disheartening, seeing that there is no group of exotic birds that affords equal opportunities for anatomical examination, since almost every genus extant, and more than two-thirds of the species, have within recent times been kept in confinement in one or another of our zoological gardens, and at their death have furnished subjects for dissection. Yet the laudable attempt

<sup>1</sup> A few remains of a Parrot have been recognized from the Miocene of the Allier in France, by Prof. A. Milne-Edwards (*Ois. Foss. France*, ii. p. 525, pl. cc.), and are said by him to show the greatest resemblance to the common Grey Parrot of Africa, *Psittacus erithacus*, through having also some affinity to the Ring-necked Parakeet of the same country, *Palæornis torquatus*. He refers them, however, to the same genus as the former, under the name of *Psittacus verreauxi*.

<sup>2</sup> The statements that have been made, and even repeated by writers of authority, as to the occurrence of "a green parrot" in Syria (Chesney, *Expéd. Survey Euphrates and Tigris*, i. pp. 443, 537) and of a Parrot in Turkestan (*Jour. Ac. Soc. Bengal*, viii. p. 1007) originated with gentlemen who had no ornithological knowledge, and are evidently erroneous.

<sup>3</sup> It is right to state, however, that the African examples of this bird are said to be distinguishable from the Asiatic by their somewhat shorter wings and weaker bill, and hence they are considered by some authorities to form a distinct species or subspecies, *P. docthis*; but in this regarding them the difference of locality seems to have influenced opinion, and without that difference they would scarcely have been separated, for in many other groups of birds distinctions so slight are regarded as barely evidence of local races.



of M. Blanchard (*Comptes Rendus*, xliii. 1097-1100 and xlv. 518-521) has not been regarded as successful, and it cannot be affirmed positively that the latest arrangement of the *Psittaci* is really much more natural than that planned by Buffon one hundred and twenty years ago. He was of course unaware of the existence of some of the most remarkable forms of the group, in particular of *Strigops* and *Nestor*; but he began by making two great divisions of those that he did know, separating the Parrots of the Old World from the Parrots of the New, and subdividing each of these divisions into various sections somewhat in accordance with the names they had received in popular language—a practice he followed on many other occasions, for it seems to have been with him a belief that there is more truth in the discrimination of the unlearned than the scientific are apt to allow. The result is that he produced a plan which is comparatively simple and certainly practical, while as just stated it cannot be confidently declared to be unnatural. However, not to go so far back as twenty years, in 1867-68 Dr Finsch published at Leyden an elaborate monograph of the Parrots,<sup>1</sup> regarding them as a Family, in which he admitted 26 genera, forming 5 Subfamilies:—(1) that composed of *Strigops* (KAKAPO, *ut sup.*) only; (2) that containing the crested forms or Cockatoos; (3) one which he named *Sittacina*, comprising all the long-tailed species—a somewhat heterogeneous assemblage, made up of MACAWS (vol. xv. p. 180) and what are commonly known as Parakeets; (4) the Parrots proper with short tails; and (5) the so-called “brush-tongued” Parrots, consisting of the LORIES (vol. xv. p. 7) and NESTORS (*ut sup.*). Except in the characters of the last group he recognized none that were not external, and that fact is sufficient to cast suspicion on his scheme being natural.

In 1874 the late Prof. Garrod communicated to the Zoological Society the results of his dissection of examples of 82 species of Parrots, which had lived in its gardens, and these results were published in its *Proceedings* for that year (pp. 586-598, pla. 70, 71). The principal points to which he attended were the arrangement of the carotid artery, and the presence or absence of an ambiens muscle, an oil-gland, and a furcula; but except as regards the last character he unfortunately almost wholly neglected the rest of the skeleton, looking upon such osteological features as the formation of an orbital ring and peculiarities of the atlas as “of minor importance”—an estimate to which nearly every anatomist will demur; for, though undoubtedly the characters afforded by blood-vessels and muscles are useful in default of osteological characters, it is obvious that these last, drawn from the very framework of any vertebrate's structure, cannot be inferior in value to the former. Indeed the investigations of Prof. A. Milne-Edwards (*Ann. Sc. Nat. Zoologie*, ser. 5, vi. pp. 91-111; viii. pp. 145-156) on the bones of the head in various Psittacine forms make it clear that these alone present features of much significance, and if his investigations had not been carried on for a special object, but had been extended to other parts of the skeleton, there is little doubt that they would have removed some of the greatest difficulties. The one osteological character to which Garrod trusted, namely, the condition of the furcula, cannot be said to contribute much towards a safe basis of classification. That it is wholly absent in some genera of Parrots had long been known, but its imperfect ossification, it appears, is not attended in some cases by any diminution of volant powers, which tends to shew that it is an unimportant character, an inference confirmed by the fact that it is found wanting in genera placed geographically so far apart that the loss must have had in some of them an independent origin. Summarily

expressed, Garrod's scheme was to divide the Parrots into two Families, *Palaeornithida* and *Psittacida*, assigning to the former three Subfamilies *Palaeornithina*, *Cacatuina*, and *Stringopina*, and to the latter four, *Arina*, *Pyrrhurina*, *Platycercina*, and *Chrysotina*. That each of these sections, except the *Cacatuina*, is artificial any regard to osteology would shew, and it would be useless here to further criticize his method, except to say that its greatest merit is that, as before mentioned (LOVE-BIRD, vol. xv. p. 28), he gave sufficient reasons for distinguishing between the genera *Agapornis* and *Psittacula*. In the *Journal für Ornithologie* for 1881 Dr Reichenow published a *Conspectus Psittacorum*, founded, as several others<sup>2</sup> have been, on external characters only. He makes 9 Families of the group, and recognizes 45 genera, and 442 species, besides subspecies. His grouping is generally very different from Garrod's, but displays as much artificiality; for instance, *Nestor* is referred to the Family which is otherwise composed of the Cockatoos. Still more recently we have the arrangement followed by Mr Sclater in the *List* of those exhibited of late years in the gardens of the Zoological Society, and published in 1883. This is more in accordance with the views that the present writer is inclined to hold, and these views may here, though with much diffidence, be stated. First there is *Strigops*, which must stand alone, unless, as before hinted (vol. xiii. p. 826), *Geopsittacus* and *Pezoporus* may have to be placed with it in a Family *Strigopida*. Next *Nestor*, from its osteological peculiarities, seems to form a very separate type, and represents a second Family *Nestorida*. These two Families being removed, all the Parrots that remain will be found to have a great resemblance among themselves, and perhaps it is impossible justifiably to establish any more Families. For the present at any rate it would seem advisable to keep them in a single Family *Psittacida*, but there can be no objection to separating them into several Subfamilies. The Cockatoos, for instance, can be without much difficulty defined, and may stand as *Cacatuina*, and then the brush-tongued Lories as *Lorina*, after which the Macaws, *Arina*—including possibly *Conurus* and its allies. *Platycercus* and its neighbours may form another section, and the same with *Palaeornis*; but for the rest there is not yet material for arriving at any determination, though *Chrysotis* and *Psittacus* seem to furnish two different types, to the former of which *Psittacula* appears to bear much the same relation as *Agapornis* does to the latter. Amongst the genera *Chrysotis*, *Palaeornis*, and *Psittacus* are probably to be found the most highly organized forms, and it is these birds in which the faculty of so-called “speech” reaches its maximum development. But too much importance must not be assigned to that fact; since, while *Psittacus erithacus*—the well-known Grey Parrot with a red tail—is the most accomplished spokesman of the whole group, it is fairly approached by some species of *Chrysotis*—usually styled Amazons—and yet its congener *P. timneh* is not known to be at all loquacious.<sup>3</sup>

Considering the abundance of Parrots both as species and individuals, and their wide extent over the globe, it is surprising how little is known of their habits in a wild state. Even the species with which Englishmen and their descendants have been more in contact than any other has an almost unwritten history, compared with that of many other birds; and, seeing how it is oppressed by and yielding to man's occupation of its ancient haunts, the

<sup>1</sup> Such, for instance, as Kuhl's treatise with the same title, which appeared in 1820, and Wagler's *Monographia Psittacorum*, published in 1832—both good of their kind and time.

<sup>2</sup> In connection with the “speaking” of Parrots, one of the most curious circumstances is that recorded by Humboldt, who in South America met with a venerable bird which remained the sole possessor of a literally dead language, the whole tribe of Indians, Aures by name, who alone had spoken it having become extinct.

<sup>1</sup> *Die Papageien, monographisch bearbeitet.*

extirpation of the Carolina Parakeet is certain, and will probably be accomplished before several interesting and some disputed points in its economy have been decided. The same fate possibly awaits several of the Australian species and all those in New Zealand—indeed the experience of small islands only foreshadows what will happen in tracts of greater extent, though there more time is required to produce the same result; but, the result being inevitable, those who are favourably placed for observations should neglect no opportunities of making them ere it be too late. (A. N.)

**PARROT-FISHES**, more correctly called **PARROT-WRASSES**, are marine fishes, belonging to the Wrasse family, and referred to four closely-allied genera, viz., *Scarus*, *Scarichthys*, *Calliodon*, and *Pseudoscarus*. They are easily recognized by their large scales, of which there are from twenty-one to twenty-five in the lateral line, by having invariably nine spines and ten rays in the dorsal fin and two spines with eight rays in the anal, and especially by their singular dentition, of jaws as well as pharynx. The teeth of the jaws are soldered together, and form a sharp-edged beak similar to that of a parrot, but without a middle projecting point, and the upper and lower beak are divided into two lateral halves by a median suture. In a few species the single teeth can be still distinguished, but in the majority (*Pseudoscarus*) they are united into a homogeneous substance with polished surface. By this sharp and hard beak parrot-fishes are enabled to bite or scrape off those parts of coral-stocks which contain the animalcules, or to cut off branches of tough fucua, which in some of the species forms the principal portion of their diet. The process of triturating the food is performed by the pharyngeal teeth, which likewise are united, and form plates with broad masticatory surface, not unlike the grinding surface of the molars of the elephant. Of these plates there is one pair above, opposed to and fitting into the single one which is coalesced to the lower pharyngeal bone. The contents of the alimentary canal, which are always found to be finely divided and reduced to a pulp, prove the efficiency of this triturating apparatus; in fact, ever since the time of Aristotle it has been maintained that the *Scarus* ruminatae. Nearly one hundred species of parrot-fishes are known from the tropical and subtropical parts of the Indo-Pacific and Atlantic Oceans; like other coral-feeding fishes, they are absent on the Pacific coasts of tropical America and on the coast of tropical West Africa. The most celebrated is the *Scarus* of the Mediterranean. Beautiful colours prevail in this group of wrasses, but are subject to great changes and variation in the same species; almost all are evanescent, and cannot be preserved after death. The majority of parrot-fishes are eatable, some even esteemed; but they (especially the carnivorous kinds) not infrequently acquire poisonous properties after they have fed on corals or medusæ containing an acrid poison. Many attain to a considerable size, upwards of 3 feet in length.

**PARRY, SIR WILLIAM EDWARD** (1790-1855), arctic navigator, was the fourth son of Dr Caleb Hillier Parry, a physician of some celebrity in Bath, and was born there 19th December 1790. He was educated at the Bath Grammar School, and was intended for the medical profession, but through the intervention of a lady friend of the family he was permitted, through the kindness of Admiral Cornwallis, to join the "Ville de Paris," the flagship of the Channel fleet, as a first-class volunteer. In 1806 he became a midshipman in the "Tribune" frigate, from which he was, in the spring of 1808, transferred to the "Vanguard" in the Baltic fleet. After obtaining his lieutenant's commission he joined the "Alexander" frigate, employed in the protection of the Spitzbergen whale

fishery. Taking advantage of the opportunity for the study of astronomy, and the observation of the fixed stars in the northern hemisphere, he afterwards published the result of his studies in a small volume on *Nautical Astronomy*. He also employed himself in preparing accurate charts of the northern navigation. Having joined the "La Hogue" at the North-American station, he remained there till 1817, distinguishing himself in an expedition up the Connecticut river, for which he received a medal. Shortly after his return to England he obtained an appointment to the "Alexander" brig in the expedition of Sir John Ross to discover the probabilities of a North-West Passage to the Pacific. Ross, mistaking clouds for the Croker mountains barring his way westwards, returned to England in the belief that further perseverance was hopeless; but Parry, confident, as he expressed it, "that attempts at polar discovery had been hitherto relinquished just at a time when there was the greatest chance of succeeding," obtained the command of a new expedition, consisting of two ships, the "Griper" and "Hecla," with which he sailed from the Thames in May 1819. Passing up Baffin's Bay, he explored and named Barrow's Straits, Prince Regent's Inlet, and Wellington Channel, and reached Melville Island at the beginning of September, having crossed longitude 110° W., thus becoming entitled to the reward of £5000 offered by parliament. After wintering in Melville Island he made an effort to force a passage to Behrings Straits, but, the state of the ice rendering this impossible, he returned to England, re-entering the Thames in November 1820. A narrative of the expedition appeared in 1821. Shortly after his return he was promoted to the rank of commander, presented with the freedom of Bath and Norwich, and elected a member of the Royal Society. With the "Fury" and the "Hecla" he set sail on a second expedition in May 1821, and after great hardships returned to England in November 1823 without achieving his purpose. During his absence he had in November 1821 been promoted to post rank, and on 1st December 1823 he was chosen acting hydrographer to the navy. His *Journal of a Second Voyage for the Discovery of the North-West Passage* appeared in 1824. With the same ships he, in May 1824, set sail on a third expedition, which, however, was also unsuccessful, and after the wreck of the "Fury" he returned home in October 1825 with a double ship's company. Of this voyage he published an account in 1826. Having obtained the sanction of the Admiralty to journey to the North Pole from the northern shores of Spitzbergen in boats that could be fitted to sledges, he set sail with the "Hecla," March 27, 1827, and in June set out for the Pole. He, however, failed to find the solid plain of ice he expected; and as, moreover, owing to the ice drift, he found his efforts at progress northwards in great degree frustrated, he was compelled, after reaching 82° 45' N. lat., to retrace his steps, and arrived in England in October. Of his journey he published an account under the title of *Narratives of the Attempt to reach the North Pole in Boats*, 1827. On April 29, 1829, he received the honour of knighthood, Sir John Franklin being also knighted on the same occasion. After continuing his duties as hydrographer till May 1829, he went to New South Wales as commissioner to the Australian Agricultural Company. On his return to England in 1835 he was appointed assistant poor-law commissioner in Norfolk. This he in little more than a year resigned, and in 1837 he was employed in organizing the packet service between Liverpool, Holyhead, and Dublin. For nine years from 1837 he was comptroller of the steam department of the navy. On retiring from active service he was appointed captain-superintendent of Haslar Hospital. He vacated this office in 1852 on obtain-

ing the rank of rear-admiral, and in 1853 he was appointed governor of Greenwich Hospital, which post he retained till his death, 8th July 1855. Besides the journals of his different voyages, Parry was the author of a *Lecture to Seamen, and Thoughts on the Parental Character of God*.

See *Memoirs of Rear-Admiral Sir W. E. Parry*, by his son Rev. Edward Parry, M.A., 8d ed., 1857.

**PARSIS, or PARSEES.** The resident in Bombay who wanders to the Bäck Bay beach at sunset to inhale the fresh sea-breezes from Malabar Hill will there observe a congregation of the most interesting people of Asia. They are the Parats, the followers of Zarathustra, and the descendants of the ancient Persians who emigrated to India on the conquest of their country by the Arabs, about the year 720 A.D.

The men are well-formed, active, handsome, and intelligent. They have light olive complexions, a fine aquiline nose, bright black eyes, a well-turned chin, heavy arched eyebrows, thick sensual lips, and usually wear a light curling moustache. The women are delicate in frame, with small hands and feet, fair complexions, beautiful black eyes, finely arched eyebrows, and a luxurious profusion of long black hair, which they dress to perfection, and ornament with pearls and gems.

The Parats are much more noble in their treatment of females than any other Asiatic race; they allow them to appear freely in public, and leave them the entire management of household affairs. They are proverbial for their benevolence, hospitality, and sociability. They are good scholars, and usually learn several languages—Gujarâti, Hindûstâni, and English. The Parats are notoriously fond of good living, and do not hesitate to spend their money freely for the best the market affords. They indulge in wines, but do not reach the vice of intoxication.

On getting out of bed in the morning, an orthodox Parat first says his prayers. He then rubs a little *strang* (cow-urine) upon his face, hands, and feet, reciting during the ceremony a prayer or incantation against the influence of *devas*, or evil spirits, for which the "nrang" is considered a specific. He next takes his bath, cleans his teeth, and repeats his prayers. He then takes his morning meal, a light breakfast,—say, tea or chocolate, bread, and fruits. The dinner is more abundant, and is composed of the dishes of the country—meats, stews, vegetables, rice, fruits, &c. These dishes are seasoned with pungent sauces, curries, chutneys, pickles, &c., one of which, famous in Bombay, is marked with the mild initials H. F. (hell-fire). The evening meal is taken after sunset, when the labours and ceremonies of the day are over, and is the signal for licence in eating, drinking, and conversation. A *tut*, or parting drink for the night, is a time-honoured custom among the Parats.

The costume of the Parat is loose and flowing, very picturesque in appearance, and admirably adapted to the climate in which he lives. The *sadara*, or shirt, which is considered the most sacred garment, because it is worn next the skin, is a plain loose vest, usually made of muslin, or with the opulent of fine white linen. A long coat or gown is worn over the sadara, extending to the knees, and fastened round the waist with the *kust*, or sacred cord, which is carried round three times, and fastened in front with a double knot. The *pyjamis*, or loose trousers, are fastened round the waist by a silken cord with tassels at the ends, which are run through a hem. The material of these pyjamis among the common classes is cotton, but the rich indulge in fancy-coloured silks and satins. The head is covered with a turban, or a cap of a fashion peculiar to the Parats; it is made of stiff material, something like the European hat, without any rim, and has an angle from the top of the forehead backwards. It would

not be respectful to uncover in presence of an equal, much less of a superior. The colour is chocolate or maroon, except with the priests, who wear a white turban. The shoes are of red or yellow morocco, turned up at the toes.

The dress of Parat ladies is something gorgeous. They are enveloped in a maze of mysteriously wound silk. They appear as hours floating about the earth in silk balloons, with a ballasting of anklets, necklaces, earrings, and jewellery. The dressmakers' bills, fortunately for the head of the family, are not exorbitant, as the costumes have not been through the hands of the modists, but are composed of many yards of fancy-coloured silks wound round the nether limbs and gradually enfolding the body, covering part of the bosom, and then thrown over the shoulders and head, drooping on the left arm, as a shield against the inquisitive gaze of a stranger. The pyjamis, or drawers, are common to both sexes, but the ladies of course excel in the fine texture and fanciful colours of these garments.

A Parat must be born upon the ground floor of the house, as the teachings of their religion require life to be commenced in humility, and by "good thoughts, words, and actions" alone can an elevated position be attained either in this world or the next. The mother is not seen by any member of the family for forty days. Upon the seventh day after the birth of the child, an astrologer is invited, who is either a Brâhmana or a Parat priest, to cast the nativity of the child. He has first to enumerate the names which the child may bear, and the parents have the right to make choice of one of them. Then he draws on a wooden board a set of hieroglyphics in chalk, and his dexterity in counting or recounting the stars under whose region or influence the child is declared to be born is marvelled at by the superstitious creatures thronging around him. All the relatives press forward to hear the astrologer predict the future life and prospects of the babe. This document is preserved in the family archives as a guidance and encouragement to the child through life, and may exert some influence in shaping its destiny. At the age of seven years or thereabouts, according to the judgment of the priest, the first religious ceremony of the Parats is performed upon the young Zarathustrian. He is first subjected to the process of purification, which consists of an ablution with "nrang." The ceremony consists in investing the young Parat with the cincture, or girdle of his faith. This cincture is a cord woven by women of the priestly class only. It is composed of seventy-two threads, representing the seventy-two chapters of the *Yadna*, a portion of the Zand-Avestâ, in the sacredness of which the young neophyte is figuratively bound. The priest ties the cord around the waist as he pronounces the benediction upon the child, throwing upon its head at each sentence slices of fruits, seeds, perfumes, and spices. He is thus received into the religion of Zarathustra. After the performance of this ceremony, the child is considered morally accountable for its acts. If a child die before the performance of this ceremony, it is considered to have gone back to Ahurâ-Mazdâ, who gave it, as pure as it entered into this world, having not reached the age of accountability. The ceremony of the *kust*, or encircling with the girdle, is closed by the distribution of refreshments to the friends and relatives of the family who have attended the investiture of the younger follower of Zarathustra with the sacred girdle of his faith.

The marriages of children engage the earliest attention of the parents. Though the majority of Parat marriages are still celebrated while the children are very young, instances frequently occur of marriages of grown-up boys and girls. The wedding day is fixed by an astrologer, who consults the stars for a happy season. The wedding day being

fixed, a Parsi priest goes from house to house with a list of the guests to be invited, and delivers the invitations with much ceremony. The father of the bride waits upon near relatives and distinguished personages, soliciting the honour of their attendance. A little before sunset a procession is formed at the house of the bridegroom, and proceeds with a band of music, amid great pomp and ceremony, to the house of the bride's father. Here a number of relatives and friends are collected at the door to receive the bridegroom with due honour. Presents are sent before, according to the time-honoured customs of the East. Upon the arrival of the procession at the house of the bride, the gentlemen gallantly remain outside, leaving room for the ladies to enter the house with the bridegroom as his escort. As he passes the threshold, his future mother-in-law meets him with a tray filled with fruits and rice, which she strews at his feet. The fathers of the young couple are seated side by side, and between them stands the priest ready to perform the magic ceremony. The young couple are seated in two chairs opposite each other, their right hands tied together by a silken cord, which is gradually wound around them as the ceremony progresses, the bride in the meantime being concealed with a veil of silk or muslin. The priest lights a lamp of incense, and repeats the nuptial benediction first in Zand and then in Sanakrit. At the conclusion of the ceremony they each throw upon the other some grains of rice, and the most expeditious in performing this feat is considered to have got the start of the other in the future control of the household, and receives the applause of the male or female part of the congregation as the case may be. The priest now throws some grains of rice upon the heads of the married pair in token of wishing them abundance; bouquets of flowers are handed to the assembled guests, and rose-water is showered upon them. The bride and bridegroom now break some sweetmeats, and, after they have served each other, the company are invited to partake of refreshments. At the termination of this feast the procession forms, and with lanterns and music escorts the bridegroom back to his own house, where they feast until midnight. As midnight approaches, they return to the house of the bride, and escort her, with her dowry, to the house of the bridegroom, and, having delivered her safely to her future lord and master, disperse to their respective homes. Eight days after the bridal ceremony a wedding feast is given by the newly-married couple, to which only near relatives and particular friends are invited. This feast is composed entirely of vegetables, but wine is not forbidden; at each course the wine is served, and toasts are proposed, as "happiness to the young couple," &c.

The funerals ceremonies of the Parsis are solemn and imposing. When the medical attendant declares the case of a Parsi hopeless, a priest advances to the bed of the dying man, repeats sundry texts of the Zand-Avesta, the substance of which tends to afford consolation to the dying man, and breathes a prayer for the forgiveness of his sins. After life is extinct, a funeral sermon is delivered by the priest, in which the deceased is made the subject of an exhortation to his relatives and friends to live pure, holy, and righteous lives, so that they may hope to meet again in paradise. The body is then taken to the ground floor where it was born, and, after being washed and perfumed, is dressed in clean white clothes, and laid upon an iron bier. A dog is brought in to take a last look at his inanimate master in order to drive away the evil spirits or *Nafus*. This ceremony is called *sagdd*. A number of priests attend and repeat prayers for the repose of the soul of the departed. All the male friends of the deceased go to the door, bow down, and raise their two hands from touching the floor to their heads to indicate their deepest

respect for the departed. The body, when put upon the bier, is covered over from head to foot. Two attendants bring it out of the house, holding it low in their hands, and deliver it to four pall-bearers, called *nasasals*, all clad in well-washed, clean, white clothes. All the people present stand up as the body is taken out of the house, and bow to it in respect as it passes by. A procession is formed by the male friends of the deceased, headed by a number of priests in full dress, to follow the body to the *dakhma*, or "tower of silence," the last resting-place of the departed Parsi. These towers are erected in a beautiful garden on the highest point of Malabar Hill, amid tropical trees swarming with vultures; they are constructed of stone, and rise some 25 feet high, with a small door at the side for the entrance of the body. Upon arriving at the "tower of silence" the bier is laid down, and prayers are said in the *sagrt*, or house of prayer, containing a fire-sanctuary, which is erected near the entrance to the garden. The attendants then raise the body to its final resting-place, lay it upon its stony bed, and retire. A round pit about 6 feet deep is surrounded by an annular stone pavement about 7 feet wide, on which the body is exposed to the vultures, where it is soon denuded of flesh, and the bones fall through an iron grating into a pit beneath, from which they are afterwards removed into a subterranean entrance prepared for their reception. On the third day after death an assemblage of the relatives and friends of the deceased takes place at his late residence, and thence proceed to the *Atish-bahrdm*, or "temple of fire." The priests stand before the urns in which the celestial fire is kept burning, and recite prayers for the soul of the departed. The son or adopted son of the deceased kneels before the high-priest, and promises due performance of all the religious duties and obsequies to the dead. The relatives and friends then hand the priest a list of the contributions and charities which have been subscribed in memory of the deceased, which concludes the ceremony of "rising from mourning," or "the resurrection of the dead." On each successive anniversary of the death of a Parsi, funeral ceremonies are performed in his memory. An iron framework is erected in the house, in which shrubs are planted and flowers cultivated to bloom in memory of the departed. Before the frame, on iron stands, are placed copper or silver vases, filled with water and covered with flowers. Prayers are said before these iron frames two or three times a day. These ceremonies are called *muktad*, or ceremonies of departed souls.

The numerical strength of the followers of Zoroaster at the present day does not exceed 82,000 persons, including the Parsis of Persia at Kermán, Yazd, and Teherán. The greater number is found in Bombay, and in some of the cities of Gujarát, as Now-sar, Surat, Bharoch, Ahmedábad, &c. Parsis have also settled for the purpose of trade in Calcutta, Madras, and in other cities of British India, in Burmah, China, and in other parts of Asia. According to the census of 1881, there are in the Bombay presidency 72,065 Parsis, and in Persia 8499, according to Houtum-Schindler (see *Journal of the Oriental German Society*, vol. xxxvi. p. 54).

The Parsis of India are divided into two sects, the Shenshahs and the Kadmis. They do not differ on any point of faith; the dispute is solely confined to a quarrel as to the correct chronological date for the computation of the era of Yazdagird, the last king of the Sassanian dynasty, who was dethroned by the caliph Omar about 640 A. D. The difference has been productive of no other inconvenience than arises from the variation of a month in the celebration of the festivals. The Shenshah sect, represented by Sir Jamsetji Jijibhai, Bart., greatly outnumbers the Kadmis, formerly headed by the late famous high-priest Mullá Frós.

The Parsis, as stated above, compute time from the fall of Yazdagird. Their calendar is divided into twelve months of thirty days each; the other five days, being added for holy days, are not counted. Each day is named after some particular angel of bliss, under whose special protection it is passed. On feast days a division of five watches is made under the protection of five different divinities. In midwinter a feast of six days is held in commemo-

tion of the six periods of creation. About the 21st of March, the vernal equinox, a festival is held in honour of agriculture, when planting begins. In the middle of April a feast is held to celebrate the creation of trees, shrubs, and flowers. On the fourth day of the sixth month a feast is held in honour of Sahršvar, the deity presiding over mountains and mines. On the sixteenth day of the seventh month a feast is held in honour of Mithra, the deity presiding over and directing the course of the sun, and also a festival to celebrate truth and friendship. On the tenth day of the eighth month a festival is held in honour of Farvardin, the deity who presides over the departed souls of men. This day is especially set apart for the performance of ceremonies for the dead. The people attend on the hills where the "towers of silence" are situated, and perform in the *sagrt's* prayers for the departed souls. The Parsis are enjoined by their religion to preserve the memory of the dead by annual religious ceremonies performed in the house, as said above; but such of their friends as die on long voyages, or in unknown places, and the date of whose death cannot be known, are honoured by sacred rites on this day. The Parsi scriptures require the last ten days of the year to be spent in doing deeds of charity, and in prayers of thanksgiving to Ahurā-Mazdā. On the day of Yazdagird, or New Year's Day, the Parsis emulate the Western world in rejoicing and social intercourse. They rise early, and after having performed their prayers and ablutions dress themselves in a new suit of clothes, and sally forth to the "fire-temples," to worship the emblem of their divinity, the sacred fire, which is perpetually burning on the altar. Unless they duly perform this ceremony they believe their souls will not be allowed to pass the bridge "Chinvad," leading to heaven. After they have performed their religious services, they visit their relations and friends, when the ceremony of "hamijur," or joining of hands, is performed. The ceremony is a kind of greeting by which they wish each other "a happy new year." Their relatives and friends are invited to dinner, and they spend the rest of the day in feasting and rejoicing; alms are given to the poor, and new suits of clothes are presented to the servants and dependants.

There are only two distinct castes among the Parsis,—the priests (*dastūrs*, or high priests; *mobeds*, or the middle order of priests; and *herbads*, or the lowest order of priests) and the people (*behadis*, *behdits*, or "followers of the best religion"). The priestly office is hereditary, and no one can become a priest who was not born in the purple; but the son of a priest may become a layman.

The secular affairs of the Parsis are managed by an elective committee, or *Panchayat*, composed of six *dastūrs* and twelve *mobeds*, making a council of eighteen. Its functions resemble the Venetian council of ten, and its objects are to preserve unity, peace, and justice amongst the followers of Zarathustra. One law of the *Panchayat* is singular in its difference from the law or custom of any other native community in Asia; nobody who has a wife living shall marry another, except under peculiar circumstances, such as the barrenness of the living wife, or her immoral conduct. It is a matter of just pride that we find the Parsis have not imitated the barbarous and tyrannical custom of prohibiting widows from remarrying which is so prevalent among the Hindūs.

Their religion teaches them benevolence as the first principle, and no people practise it with more liberality. A beggar among the Parsis is unknown, and would be a scandal to the society. In the city of Bombay alone they have thirty-two different charitable institutions. The sagacity, activity, and commercial enterprise of the Parsis are proverbial in the East, and their credit as merchants is almost unlimited. They frequently control the opium production of India, which amounts annually to something like £10,000,000 sterling. They have some fifty large commercial houses in Bombay, fourteen in Calcutta, twenty in Hong-Kong, ten in Shanghai, four in London, three in Amoy, two in Yokohama, and many throughout India, Persia, and Egypt. Further, their interest in the extension of agriculture in India is prominent; they are also very much esteemed as railway contractors or railway guards. It is often said that the Parsis are superstitious about extinguishing fire, but this is a mistake. They are the only people in the world who do not smoke tobacco, or some other stimulating weed. Their reverence for fire as a symbol of Ahurā-Mazdā prevents them from dealing with it lightly. They would not play with fire, nor extinguish it unnecessarily; and they generally welcome the evening blaze with a prayer of thanksgiving. Their religion forbids them to defile any of the creations of Ahurā-Mazdā, such as the earth, water, trees, flowers, &c., and on no account would a Parsi indulge in the disgusting habit of expectoration. They have been accustomed to the refinement of finger-bowls after meals for several thousand years, and resort to ablutions frequently.

Of all the natives of India the Parsis are most desirous of receiving the benefits of an English education, and their eagerness to embrace the sciences and literature of the West has been conspicuous in the wide spread of female education among them. The difference between the Parsis of thirty years ago and those of the present day

is simply the result of English education and intercourse with Englishmen. The condition of the Parsi priesthood, however, demands improvement. Very few of them understand their liturgical Zand works, although able to recite parrot-like all the chapters requiring to be repeated on occasions of religious ceremonies, for which services they receive the regulated fees, and from them mainly they derive a subsistence. It is, however, very gratifying to notice an attempt that is now being made to impart a healthy stimulus to the priesthood for the study of their religious books. Two institutions, styled the "Mulla Firōz Madrasa" and the "Sir Jamsēt Jītibhāi Madrasa," have been established under the superintendence of competent teachers. Here the study of Zand, Pārand, Pahlavi, and Persian is cultivated; and many of the sons of the present ignorant priests will occupy a higher position in the society of their countrymen than their parents now enjoy. The present *dastūrs* are intelligent and well-informed men, possessing a sound knowledge of their religion; but the mass of the *mobeds* and *herbads* are profoundly ignorant of its first principles. As active measures are being devised for improvement, the darkness of the present will doubtless be succeeded by a bright dawn in the future. (A. F.)

PARSON is a technical term of English law, and is a corruption of *persona*, the parson being, as it were, the *persona ecclesie*, or representative of the church in the parish. Parson impersones (*persona impersonata*) is he that as rector is in possession of a church parochial, and of whom the church is full, whether it be presentative or improper (Coke upon Littleton, 300 b). The word parson is properly used only of a rector, though it is sometimes loosely extended to any one in holy orders. Though every parson is a rector, every rector is not a parson. A parson must be in holy orders; hence a lay rector could not be called a parson. The parson is tenant for life of the parsonage house, the glebe, the tithes, and other dues, so far as they are not appropriated. Further information on this subject will be found under ADVOWSON, BENEFICE, and TITHES.

PARSONS, or PARSONS, ROBERT (1546–1610), a celebrated Jesuit, was the son of a blacksmith, and was born at Nether Stowey, near Bridgwater, England, in 1546. His precocity attracted the attention of the vicar of the parish, who gave him private instruction, and procured his entrance in 1563 as an exhibitioner to Balliol College, Oxford. He graduated B.A. in 1568, and M.A. in 1572. He was fellow, bursar, and dean of his college, but in 1574 he resigned his fellowship and offices, for reasons which have been disputed, some alleging improprieties of conduct, and others suspected disloyalty. Soon after his resignation he went to London, and thence in June to Louvain, where he spent some time in the company of Father William Good, a Jesuit. He then proceeded to Padua to carry out a previously conceived intention to study medicine, but further intercourse with English Jesuits so influenced his mind, that in July 1575 he entered the Jesuit Society at Rome. In 1580 he was selected along with Campian, a former associate at Oxford, and others, to undertake a secret mission to England against Elizabeth. Through the vigilance of Burghley the plot was discovered and Campian arrested, but Parsons made his escape to Rouen, and occupied himself for some time in the composition of treasonable tracts against Elizabeth, which he caused to be secretly sent to England. In 1583 he returned to Rome, where he was appointed prefect of the English mission, and in 1586 chosen rector of the English seminary. He also devoted much energy to the establishment of seminaries elsewhere on the Continent, for the training of priests to be despatched to England to aid in reviving the cause of Romanism. After the disaster to the Spanish Armada in 1588, he endeavoured to persuade the Spanish monarch to undertake a second invasion, and, unsuccessful in this, he incited various plots against Elizabeth, all of which were, however, abortive. On the death of Cardinal Allen in 1594 he made strenuous efforts to be appointed his successor, and, failing in this, he retired to Naples until

the death of Clement VIII in 1606. From this time he continued his active intrigues against Protestantism in England until his death, 18th April 1610.

Parsons was the author of a large number of polemical tracts, a list of which, to the number of thirty-three, is given in Chalmers's *Biographical Dictionary*. For portrait, see *Gentleman's Magazine*, vol. lxiv.

**PARSONSTOWN**, formerly **BIRR**, a market-town of King's County, Ireland, is situated on an acclivity rising above the Birr, and on a branch of the Great Southern and Western Railway, 12½ miles north of Roscrea and 7½ south of Banagher. Cumberland Square, in which there is a Doric column, surmounted by a statue of the duke of Cumberland to commemorate the battle of Culloden, contains a number of good shops, and the streets diverging from it are wide and well built. The fine castle of Birr, besides its historical interest, has gained celebrity on account of the reflecting telescope erected there (1828-45) by the third earl of Rossa. The other principal buildings are the court-house, the Protestant Episcopal and Roman Catholic churches, the convent of the sisters of mercy, the model school, the mechanics' institute, the fever hospital, and the infirmary. There is a bronze statue by Foley of the late Lord Kcsse. Some trade is carried on in corn and timber, and the town possesses a distillery and brewery. The population was 5401 in 1861, 4939 in 1871, and 4955 in 1881.

An abbey was founded at Birr by St Brendan. The district formed part of Ely O'Carrol, and was not included in King's County till the time of James I. A great battle is said to have been fought near Birr in the 3d century between Cormac, son of Cond of the Hundred Battles, and the people of Munster. The castle was the chief seat of the O'Carrols. In the reign of James I. it and its appendages were assigned to Lawrence Parsons, brother of Sir William Parsons, surveyor-general. It was more than once besieged in the time of Cromwell, and was taken by Ireton in 1650. It also suffered assault in 1688 and 1690.

**PARTÁBGARH**, **PRATÁBGARH**, or **PERTABGURH**, a district of Oudh, India, situated between 25° 34' and 26° 10' 30" N. lat., and between 81° 22' and 82° 29' 45" E. long., is bounded on the N. by Rái Bareli and Sultánpur, and on the E., S., and W. by Jaunpur and Allahábád districts. The Ganges forms the south-western boundary line, while the Gumti marks the eastern boundary for a few miles. The area (1881) is 1436 square miles. The general aspect of Partábgarh is that of a richly wooded and fertile plain, here and there relieved by gentle undulations, and in the vicinity of the rivers and streams broken into ravines. The one important river (the Ganges and Gumti nowhere entering the district) is the Sáí, which is navigable in the rains, but in the hot season runs nearly dry. The only mineral products are salt, saltpetre, and *kankar* or nodular limestone. The manufacture of salt and saltpetre from the saliferous tracts is prohibited. Tigers and leopards are hardly ever met with; but wolves still abound in the ravines and grass lands. *Nyááí*, wild cattle, hogs, and monkeys do much damage to the crops. Snakes are not numerous. Small game abounds.

The population in 1881 was 847,047 (420,730 males, 426,317 females; 763,054 Hindus, 83,944 Mohammedans, 48 Christians). The principal grain crops are barley, wheat, and rice. Other food crops are gram, peas, *arhar*, *jadra*, and *deíra*. Sugar-cane cultivation has largely increased of late years, and poppy is grown under the superintendence of the Opium Department. Miscellaneous crops include tobacco of superior quality, indigo, fibres, *pad*, &c. Irrigation is extensively carried on, and manure is made use of wherever procurable. Rents have steadily increased since the introduction of British rule, and still show a tendency to rise. Artisans and skilled labourers have much improved in circumstances of late years; but agricultural labour is still paid in kind at about the same rates that prevailed under native rule. Partábgarh is now well opened up by roads. Four large ferries are maintained on the Ganges, and two on the Gumti. Partábgarh forms a great grain-exporting district. Other important exports comprise

tobacco, sugar, molasses, opium, oil, *ghá*, cattle and sheep, hides, &c. The imports consist mainly of salt, cotton, metals and hardware, country cloth, and dyes. The manufactures of the district comprise sugar, blanket weaving, glass beads and bracelets, water-bottles, &c. The gross revenue of the district in 1882-83 was £175,735, of which the land revenue contributed £98,220. Education is afforded by 91 schools, on the rolls of which on 31st March 1883 there were 3483 scholars. The climate is healthy. The average rainfall for the fourteen years ending 1881 was 37 inches.

**PARTÁBGARH**, or **PERTABGURH**, a native state in Rájputána, India, lying between 23° 14' and 24° 14' N. lat., and between 74° 27' and 75° E. long., and entirely surrounded by native territory, has an estimated area of 1460 square miles, and an estimated population (1881) of 80,568, mostly Bháls and other aboriginal tribes. The revenue is about £60,000, of which about £20,000 are enjoyed by feudatory chiefs and nobles. It is a hilly country, mainly producing maize and *jadra* (*Holcus sorghum*).

**PARTHENIUS**, a Bithynian poet, said to have been captured in the Mithradatic war and carried to Rome. He lived there for many years, as late as the time of Tiberius. His poems were on erotic subjects, and many of them treated of obscure mythological stories. The only work of his which is preserved is a collection of short love-tales in prose, dedicated to the poet Cornelius Gallus, but apparently not intended for publication.

**PARTHENON**. See **ATHENS**, vol. iii. p. 5.

**PARTHIA**. See **PERSIA**.

**PARTINICO**, a town of Sicily, in the province of Palermo, and 28½ miles W. of Palermo by rail, has a good trade in wine and oil, and in 1881 had 21,000 inhabitants.

**PARTITION**, in law, is the division between several persons of land or goods belonging to them as co-proprietors. It was a maxim of Roman law, followed in modern systems, that *in communiōe vel sociatōe nemo potest invito detineri*. Partition was either voluntary or was obtained by the *actio communi dividenda*. In English law the term partition applies only to the division of lands, tenements, and hereditaments, or of chattels real between coparceners, joint tenants, or tenants in common. It is to be noticed that not all hereditaments are capable of partition. There can be no partition of homage, fealty, or common of turbary, or of an inheritance of dignity, such as a peerage. Partition is either voluntary or compulsory. Voluntary partition is effected by mutual conveyances, and can only be made where all parties are *sui juris*. Since 8 & 9 Vict. c. 106, § 3, it must be made by deed, except in the case of copyholds. Compulsory partition is effected by private Act of Parliament, by judicial process, or through the inclosure commissioners. At common law none but coparceners were entitled to partition against the will of the rest of the proprietors, but the Acts of 31 Henry VIII. c. 1 and 32 Henry VIII. c. 32 gave a compulsory process to joint tenants and tenants in common of freeholds, whether in possession or in reversion, by means of the writ of partition. In the reign of Elizabeth the Court of Chancery began to assume jurisdiction in partition, and the writ of partition, after gradually becoming obsolete, was finally abolished by 3 & 4 Will. IV. c. 27. The Court of Chancery could not decree partition of copyholds until 4 & 5 Vict. c. 35, § 85. By the Judicature Act, 1873, § 34, partition is one of the matters specially assigned to the Chancery Division. An order for partition is a matter of right, subject to the discretion vested in the court by the Partition Act, 1868 (31 & 32 Vict. c. 40, amended by 39 & 40 Vict. c. 17). By § 3 of the Act of 1868 the court may, on the request of a party interested, direct a sale instead of a partition, if a sale would be more beneficial than a partition. By § 12 a county court has jurisdiction in partition where the property does not exceed £500 in value. Under the powers of the Inclosure Act, 1845,



8 & 9 Vict. c. 116, and the Acts amending it, the inclosure commissioners have power of enforcing compulsory partition among the joint owners of any inclosed lands. An order of the inclosure commissioners or a private Act vests the legal estate, as did also the old writ of partition. But an order of the Chancery Division only declares the rights, and requires to be perfected by mutual conveyances so as to pass the legal estate. Where, however, all the parties are not *in jure*, the court may make a vesting order under the powers of the Trustee Act, 1850, 13 & 14 Vict. c. 60, § 30.

Partition is not a technical term of Scots law. In Scotland division of common property is effected either extra-judicially, or by action of declarator and division or division and sale in the Court of Session, or (to a limited extent) in the sheriff courts. Rights of common are not divisible in English law without an Act of Parliament or a decree of the inclosure commissioners, but in Scotland the Act of 1695, c. 28, made all commonities, except those belonging to the king or royal burghs, divisible, on the application of any having interest, by action in the Court of Session. By 40 & 41 Vict. c. 50, § 8, the action for division of common property or common is competent in the sheriff court, when the subject in dispute does not exceed in value £50 by the year, or £1000 *valua*. Runrig lands, except when belonging to corporations, were made divisible by the Act of 1695, c. 28. A decree of division of commonity, common property, or runrig lands has the effect of a conveyance by the joint proprietors to the several participants (37 & 38 Vict. c. 94, § 35).

In the United States, "it is presumed," says Chancellor Kent, (4 *Comm.*, lect. lxxiv.), "that the English statutes of 31 & 32 Henry VIII have been generally re-enacted and adopted, and probably with increased facilities for partition." In a large majority of the States, partition may be made by a summary method of petition to the courts of common law. In the other States the courts of equity have exclusive jurisdiction. As between heirs and devisees the probate courts may in some States award partition. The various State laws with regard to partition will be found in Washburn, *Real Property*, bk. I. ch. xiii., § 7.

**PARTNERSHIP**, in law, is a voluntary association of two or more persons for the purposes of gain. This is of course not an exhaustive definition, but will serve to include most of the definitions of partnership which have been attempted.<sup>1</sup> The word *partner* is a contracted form of *partnerer*.

The partnership of modern legal systems is based upon the *societas* of Roman law. *Societas* is not defined by any of the Roman jurists. But the Roman view is no doubt sufficiently expressed in the definition by Voet:—*societas est contractus juris gentium, bonæ fidei, consensus constans, semper re honesta, de lucrî et damni communiõne*. *Societas* was either *universorum bonorum*, a complete communion of property; *negotiationis alicujus*, for the purpose of a single transaction; *vectigalis*, for the collection of taxes; or *rei usus*, joint ownership of a particular thing. The prevailing form was *societas universorum quæ ex quatuor veniunt*, or trade partnership, from which all that did not come under the head of trade profit (*quæstus*) was excluded. This kind of *societas* was presumed to be contemplated in the absence of proof that any other kind was intended. *Societas* was a consensual contract, and rested nominally on the consent of the parties—really, no doubt (though this was not in terms acknowledged by the Roman jurists), on the fact of valuable consideration moving from each partner. No formalities were necessary for the constitution of a *societas*. Either property or labour must be contributed by the *socius*; if one party contributed neither property nor labour, or if one partner was to share in the loss but not in the profit (*leonina societas*), there was no true *societas*. *Societas* was dissolved on grounds substantially the same as those of English law (see below). The only ground peculiar to Roman law was change of *status* (*capitis deminutio*). Most of the Roman law on the subject of *societas* is contained in *Dig.* xvii. tit. 2, *Pro Socio*. The

main points of difference between the Roman and English law will be treated below.

There is no statutory or judicial definition of partnership in English law. It is defined by the Indian Contract Act, § 239,<sup>2</sup> as "the relation which subsists between persons who have agreed to share the profits of a business carried on by all or any of them on behalf of all of them." Sir N. Lindley declines to pledge himself to any definition, but lays down the following principles:—(1) partnership is the result of an agreement to share profits and losses; (2) partnership is *prima facie* the result of an agreement to share profits, although nothing may be said about losses, and although there may be no common stock; (3) partnership is *prima facie* the result of an agreement to share profits, although community of loss is stipulated against; (4) partnership is not the result of an agreement to share gross returns; (5) partnership is not the result of an agreement which is not concluded; (6) partnership is not the result of an agreement to share profits so long as anything remains to be done before the right to share them accrues (1 Lindley, bk. i. ch. i., § 1). It was held in 1793, in the case of *Waugh v. Carver*, (2 H. Blackstone, 235), that sharing in profits constituted partnership, though no partnership was in fact contemplated by the parties. But in 1860 the House of Lords in *Cox v. Hickman* (8 House of Lords Cases, 268), established the principle that persons who share the profits of a business do not incur the liabilities of partners unless the business is carried on by themselves or their real or ostensible agents. In 1865 the Act 28 & 29 Vict. c. 86 (which applies to the United Kingdom, and is commonly called Bovill's Act) was passed in order to remove certain difficulties arising from *Cox v. Hickman*. It enacts that the advance by way of loan to a person engaged or about to engage in any trade or undertaking, upon a contract in writing that the lender is to receive a rate of interest varying with the profits, or a share of the profits, is not of itself to constitute the lender a partner (§ 1); that no contract for the remuneration of a servant or agent by a share of the profits is of itself to render such servant or agent responsible as a partner or give him the rights of a partner (§ 2); that no widow or child of a partner of a trader receiving by way of annuity a portion of the profits is, by reason only of such receipt, to be deemed to be a partner (§ 3); that no person receiving by way of annuity or otherwise a portion of the profits in consideration of the sale of the goodwill is, by reason only of such receipt, to be deemed to be a partner (§ 4); that in the event of any such trader being adjudged bankrupt, &c., the lender of any such loan is not to be entitled to recover his principal or profits and interest, or the vendor of a goodwill his profits, until the claims of the other creditors for valuable consideration have been satisfied. Participation in profits has thus ceased to be an absolute test of partnership. Another test that has been proposed is the existence of such a participation as to constitute the relation of principal and agent. But this has been objected to on the ground that agency is deducible from partnership and not partnership from agency (see *Holme v. Hammond*, *Law Rep.* 7 Exch. 218). The principles laid down by Sir N. Lindley above no doubt form the best means of deciding the matter, but every case must depend to a large extent upon its own particular circumstances. Though participation in profits is of itself no evidence of partnership, on the other hand societies and clubs, the object of which is not to share profits, are not partnerships. The liability of clubs or provisional committee men depends entirely upon

<sup>1</sup> The difficulties of definition are pointed out by Sir N. Lindley, *On Partnership*, I., *Intro.*

<sup>2</sup> The definition was adopted in the Partnership Bill which was introduced into parliament in 1880; see Appendix to Pollock's *Digest of the Law of Partnership*.

the question of agency. They are not as a rule in the position of partners as against third persons. No partnership can exist in an office depending upon personal confidence, as the office of executor or trustee. Joint tenants or tenants in common are not necessarily partners. If A and B agree to contribute a sum for the purchase of goods to be divided between them, they are joint owners after purchase and before division. But if they resell the goods and divide the profits, they then become partners (*Smith's Mercantile Law*, bk. i. ch. ii.).

A valid contract of partnership can be entered into by any person not under the disability of minority or unsoundness of mind, or of being a convict within the Felony Act, 1870 (33 & 34 Vict. c. 23), or an alien enemy. It is presumed that the disability of coverture no longer exists since the Married Women's Property Act, 1882. An infant may nominally be a partner, but he incurs no liability, and may disaffirm past transactions when he comes of age. A clergyman becoming a partner for purposes of trade is (with certain exceptions) liable to ecclesiastical penalties, but the contracts of the partnership are not void, 1 & 2 Vict. c. 106, § 31. At common law there is no limit to the number of partners, but by the Companies Act, 1862 (25 & 26 Vict. c. 89, § 4), not more than ten persons can carry on the business of bankers, and not more than twenty any other business, unless (with some exceptions) they conform to the provisions of the Act. (See COMPANY.)

A partnership may be constituted by deed or other writing, or it may be implied from acts. It is usually, though not of necessity, evidenced by deed. The usual clauses in a partnership deed provide for the nature of the business, the time of the commencement of the partnership and its duration, the premium, the capital and property, the interest and allowances, the conduct and powers of the partners, the custody of the books, the taking of the accounts, retirement, dissolution, and expulsion, the valuation and transmission of shares, annuities to widows of deceased partners, prohibition against carrying on business in opposition after retirement, sale of goodwill, getting in debts, indemnity to outgoing partners, and arbitration clauses. Though a deed may serve to adjust the rights of the partners *inter se*, their liabilities to third persons cannot be affected by provisions in a deed of which the latter are ignorant. Whether a partnership exists in a particular case is a mixed question of law and fact. The partnership may last for any time agreed upon by the partners. It is determinable at will unless it has been agreed that it shall endure for a specified period, or unless it is dissolved by some of the circumstances which will be hereafter mentioned. A partnership may be general or special, e.g., the ownership of a single race-horse, or the conduct of a single case by a firm of solicitors. The rights and liabilities of partners may be considered as they affect the partners (1) *inter se*, and (2) in their relation to third persons.

1. The shares of partners are *prima facie* equal. Inequality must be proved by evidence. Each member of a partnership is entitled to take a share in its management, unless, as is frequently the case, one member is appointed managing partner. A partner is in a fiduciary position. It is therefore his duty to use reasonable diligence, to keep within the limits of his authority, and to observe good faith, e.g., not to compete with the partnership. He may be a partner in another firm, and the fact of his being a partner in firms A and B does not make A and B partners, for *socius mei sociis non est meus socius*. In matters which are within the ordinary course of the business of the partnership, such as the period of division of profits, if the partnership articles be silent on the subject, the minority

must yield to the majority. In matters beyond the scope of the partnership business, such as a change in the character of the business, one dissident can forbid a change, and can obtain an injunction to prevent the change from being carried out. A partner is entitled to have accounts kept, and to inspect them at proper times. Where a partner has as agent for the firm paid more than his share, he is entitled to contribution from the rest. One partner cannot be expelled by the others unless there is a special power of expulsion given by the articles. A partner has no right to assign his share without the express or implied consent of the other partners. If the partnership be one at will, the assignment *ipso facto* dissolves it; if not at will, the others are entitled to treat the assignment as a ground of dissolution. The assignee takes the share subject to the claims of the other partners. Each partner has an equitable lien upon the partnership property, enabling him within certain limits to control the disposition of it. On the death of a partner his share goes to his representatives, not, as in joint-tenancy, by accretion to the survivors. It is an ancient maxim of law that *jus accrescendi inter mercatores non habet locum* (Coke upon Littleton, 182 a).

2. A more important and difficult question is the relation of partners to those not members of the partnership. From this point of view partnership is to a great extent a branch of the law of agency (see AGENCY). As far as contracts are concerned, it is the rule that one partner is its general agent for the transaction of its business in the ordinary way, and the firm is responsible for whatever is done by any of the partners when acting for the firm within the limits of the authority conferred by the nature of the business which it carries on (1 Lindley, bk. ii. ch. i.). The authority is defined by the business, not by any private understanding between the partners. Thus a merchant can bind his partners by accepting a bill of exchange for the firm, but a solicitor or medical man cannot. A partner cannot execute a deed, except a simple release of a debt, so as to bind the firm. In many cases an act not warranted by authority, such as a submission to arbitration, may be adopted by ratification so as to bind the firm. And in other cases the rights of a *bona fide* claimant will prevail, even though the authority has been exceeded and there has been no ratification, e.g., where a bill given by a partner on his private account passes into the hands of a *bona fide* holder for value. Where the partner contracts on behalf of the partnership, it is the latter and not the individual who is primarily liable. If the name of a firm and an individual is the same, a bill drawn in that name for partnership purposes is *prima facie* a bill of the firm (Yorkshire Banking Co. v. Beaton, *Law Rep.*, 5 C. P. D., 109). But a partner may hold himself out as the sole partner, and so make himself separately liable. Every member of a partnership is at common law liable *in solido* for the debts of the firm, a liability co-extensive with his power to transfer the whole property of the firm. This liability cannot be restricted except by statute (as the Companies Act) or by express contract with the creditors. A dormant partner is liable, like an ostensible partner, for debts contracted during his partnership; if, however, the ostensible partners have been sued to judgment, an action cannot be brought to charge the dormant partner (Kendall v. Hamilton, *Law Rep.*, 4 App. Cas., 504). The liability of a dormant and an ostensible partner terminates in a different manner, in the former case by his simple retirement without notice, in the latter only after notice, a general notice in the *Gazette* being the usual means of informing the public of the change, while special notice is given to known customers. It is a question of fact whether the liability of the new

firm has been accepted in place of that of the previous firm. A guarantee to or for a firm ceases upon a change in the firm unless it appears by express stipulation or necessary implication that the guarantee is to continue, 19 & 20 Vict. c. 97, § 4. There are cases in which a relation of quasi-partnership is created, i.e., in which persons not partners *inter se* become partners *qua* third persons. A person who holds himself out as a partner incurs the liability of a partner. This was clearly laid down by Lord Chief Justice Eyre in *Waugh v. Carver*, and is now an established principle of law. "Holding out" means that credit has been obtained by the use of his name, or even by permitting reference to him as one who wishes to have his name concealed.

Where the liability arises out of tort, the law is not quite the same as it is where the liability arises from contract. The presumption is against the authority of a partner to commit a tort, and so opposed to the presumption in the case of contract. But a partnership is liable jointly and severally for any wrongful act or omission of one of its members in conducting the business of the firm, e.g., the neglect of a managing partner to keep the shaft of a mine in order, but not for a wilful wrong unconnected with the business, e.g., malicious prosecution. With respect to fraud by misappropriation of money, some obligation on the part of the firm to take care of the money must be shown. A receipt from the firm *prima facie* imposes this obligation.

An action should be brought by all the partners (except merely nominal partners, who need not be joined unless in an action on a contract under seal). They cannot delegate a right of action to one of themselves for convenience. This can only be done by statute, as 7 Geo. IV. c. 46, enabling banking companies to sue and be sued by a public officer. All the partners ought to be sued, subject to any statutory exception, as that contained in the Carriers' Act, 11 Geo. IV., and 1 Will. IV. c. 68, §§ 5, 6. But misjoinder or nonjoinder of parties does not defeat an action (*Rules of the Supreme Court*, 1883, ord. xvi. r. 11). The method of procedure does not affect the principle of the liability of each partner *in solido*, a principle on which is based one of the main points of difference between a partnership and a corporation. In a corporation the collective whole is distinct from the individuals composing it (see CORPORATION). But in a partnership the firm, as distinct from the individual partners, is recognized by English law only to a very limited extent, and as matter of procedure rather than of substantive law. Since the Judicature Acts, in an action against a partnership, power is given to sue and be sued in the firm name, but the partners are bound to disclose the names of the persons constituting the firm, and, though judgment goes against the firm, execution may issue against a partner (*Rules of the Supreme Court*, 1883, ord. vii. r. 2, xvi. r. 14, xlii. r. 10). An adjudication of bankruptcy cannot be made against the firm in the firm name, but only against the partners individually (*Bankruptcy Rules*, 1883, r. 197).

A partnership at will is dissolved by determination of the will or assignment of the partnership share. A partnership other than a partnership at will is dissolved by (1) effluxion of time; (2) retirement of a partner; (3) alienation by operation of law of a partner's share, e.g., by bankruptcy or (formerly) by marriage of a female partner; (4) death; (5) business becoming unlawful, as by a partner becoming an alien enemy; (6) assignment of partnership share; (7) lunacy; (8) liability of a partner to criminal prosecution; (9) impossibility of carrying on the business. In the last four cases the partnership is not *ipso facto* dissolved, but they are grounds on which the

court may order a dissolution (see Pollock, art. 47 *sq.*). Where a partner has been induced to enter into a partnership by fraud, he has in general the option of affirming or rescinding the contract at his election.

The dissolution of partnerships and the taking of partnership accounts are matters specially assigned to the Chancery Division (Judicature Act, 1873, § 34). After dissolution the persons who constituted the partnership become tenants in common of the partnership property until the division of assets, unless any other provision is made by agreement. The partnership debts are paid out of the partnership assets, and the private debts out of the private assets.

The principle of law that a partnership debt is joint and several comes into operation where the partnership is dissolved by bankruptcy or death. The joint estate is the primary fund for the payment of joint debts, but the joint creditors can look to any surplus of the separate estate (after payment of the separate debts) to satisfy any deficiency in the joint estate. See the Bankruptcy Act, 1883, § 59. Partners cannot compete with the creditors of the firm either against the joint estate or the several estate of a partner; that is to say, they cannot be satisfied until all the debts of the firm have been paid. In the case of death, although the partnership is dissolved by death, it is still treated as subsisting for the purposes of administration. The creditor has the same rights against the estate of the deceased as he would have had in his lifetime in some cases, so that he may proceed against this estate in the first instance, without recourse to the surviving partners (see the judgment of Lord Selborne in *Kendall v. Hamilton*, *Law Rep.*, 5 App. Cas. 539). Further, the death of a partner has the result of converting the real property of the firm. "Whenever a partnership purchases real estate for partnership purposes, and with partnership funds, it is, as between the real and personal representatives of the partners, personal estate" (*Darby v. Darby*, 3 Drewry 506).

At common law no criminal prosecution was maintainable by one partner against another for stealing the property of the firm. But this difficulty has been removed by 31 & 32 Vict. c. 116.

Though the English law of partnership is based upon Roman law, there are several matters in which the two systems differ. (1) There was no limit to the number of partners in Roman law. (2) In *societas* one partner could generally bind another only by express *mandatum*; one partner was not regarded as the implied agent of the others. (3) The debts of a *societas* were apparently joint, and not joint and several. (4) The *heres* of a deceased partner could not succeed to the rights of the deceased, even by express stipulation. There is no such disability in England. (5) In actions between partners in Roman law, the *beneficium competentis* applied, that is, the privilege of being condemned only in such an amount as the partner could pay without being reduced to destitution. (6) The Roman partner was in some respects more strictly bound by his fiduciary position than is the English partner. For instance, a Roman partner could not retire in order to enjoy alone a gain which he knew was awaiting him. (7) There was no special tribunal to which matters arising out of *societas* were referred.

The law of Scotland as to partnership agrees in the main with the law of England. The principal difference is that Scots law recognizes the firm as an entity distinct from the individuals composing it. English law, as has been said, does this only to a very limited extent. The firm of the company<sup>1</sup> is either proper or descriptive. A proper or personal firm is a firm designated by the

<sup>1</sup> The term "company" is not confined, as in England, to an association existing by virtue of the Companies Act, 1862, or similar Acts.

name of one or more of the partners. A descriptive firm does not introduce the name of any of the partners. The former may sue and be sued under the company name; the latter only with the addition of the names of three at least (if there are so many) of the partners. A consequence of this view of the company as a separate person is that an action cannot be maintained against a partner personally without application to the company in the first instance, the individual partners being in the position of cautioners for the company rather than of principal debtors. The provisions of the Mercantile Law Amendment Act, 1856 (19 & 20 Vict. c. 60, § 8), do not affect the case of partners. But, though the company must first be discussed, diligence must necessarily be directed against the individual partners. Heritable property cannot be held in the name of a firm; it can only stand in the name of individual partners. Notice of the retirement of even a dormant partner is necessary. The law of Scotland draws a distinction between joint adventure and partnership. Joint adventure or joint trade is a partnership confined to a particular adventure or speculation, in which the partners, whether latent or unknown, use no firm or social name, and incur no responsibility beyond the limits of the adventure. In the rules applicable to cases of insolvency and bankruptcy of a company and partners, Scots law differs in several respects from English. Thus a company can be made bankrupt without the partners being made so as individuals. And, when both company and partners are bankrupt, the company creditors are entitled to rank on the separate estates of the partners for the balance of their debts equally with the separate creditors. But in sequestration, by 19 & 20 Vict. c. 79, § 68, the creditor of a company, in claiming upon the sequestrated estate of a partner, must deduct from the amount of his claim the value of his right to draw payment from the company's funds, and he is ranked as creditor only for the balance. (See Erskine's *Inst.*, bk. iii. tit. iii.; Bell's *Comm.*, ii. 500-562; Bell's *Principles*, §§ 350-403.)

In the United States the English common law is the basis of the law. Most States have, however, their own special legislation on the subject. Partnership is defined by Chancellor Kent to be "a contract of two or more competent persons to place their money, effects, labour, and skill, or some or all of them, in lawful commerce or business, and to divide the profit and bear the loss in certain proportions" (3 Kent's *Comm.*, lect. xliii.). The definition of the New York Civil Code, art. 1283, runs thus:—"partnership is the association of two or more persons for the purpose of carrying on business together, and dividing its profits between them." The most striking feature of the law in the United States is the existence of limited partnerships, corresponding to the *société en commandite* established in France by the ordinance of 1673. The State of New York was the first to introduce this kind of partnership by legislative enactment. The provisions of the New York Act have been followed by most of the other States. In many States there can be no limited partnership in banking and insurance. In this form of partnership one or more persons responsible *in solido* are associated with one or more dormant partners liable only to the extent of the funds supplied by them. In Louisiana such partnerships are called partnerships *in commendam* (Civil Code, art. 2810). In New York the responsible partners are called *general* partners, the others *special* partners. Such partnerships must, by the law of most States, be registered. (In 1880 a bill providing for the legislation of such partnerships in the United Kingdom was introduced in the House of Commons, but failed to become law.) In Louisiana universal partnerships (the *societas universorum bonorum* of Roman law) must be created in writing and registered (Civil Code, art. 2800). In some States the English law as it stood before *Cox v. Hickman* is followed, and participation in profits is still regarded as the test of partnership, e.g., *Leggett v. Hyde* (58 New York Rep. 272). In some States nominal partners are not allowed. Thus in New York, where the words "and Company" or "and Co." are used, they must represent an actual partner or partners. A breach of this rule subjects offenders to penalties. In most States claims against the firm after the death of a partner must, in the first instance, be made to the survivors. The creditors cannot, as in England, proceed directly against the representatives of the deceased. The law as to the conversion of realty into personality on the administration of the estate of a deceased partner in some States agrees with English law, in others does not. (See 3 Kent's *Comm.*, lect. xliii.; Story, *On Partnerships*; Troubat, *On Limited Partnerships*; and Angell, *On Private Corporations*.) (J. Wt.)

PARTRIDGE, in older English *PERTRICHE*, Dutch *Partrij*, French *Perdrix*, all from the Latin *Perdix*, which word in sound does not imitate badly the call-note of this bird, so well known throughout the British Islands and the greater part of Europe as to need no description or account of its habits here. The English name properly denotes the only species indigenous to Britain, often nowadays called the Grey Partridge (to distinguish it from

others, of which more presently), the *Perdix cinerea* of ornithologists, a species which may be regarded as the model game-bird—whether from the excellence of the sport it affords in the field, or the no less excellence of its flesh at table, which has been esteemed from the time of Martial to our own—while it is on all hands admitted to be wholly innocuous, and at times beneficial to the agriculturist. It is an undoubted fact that the Partridge thrives with the highest system of cultivation; and the lands that are the most carefully tilled, and bear the greatest quantity of grain and green crops, generally produce the greatest number of Partridges. Yielding perhaps in economic importance to the Red Grouse, what may be called the social influence of the Partridge is greater than that excited by any other wild bird, for there must be few rural parishes in the three kingdoms of which the inhabitants are not more or less directly affected in their movements and business by the coming in of Partridge-shooting, and therefore a few words on this theme may not be out of place.

From the days when men learned to "shoot flying" until some forty years ago, dogs were generally if not invariably used to point out where the "covey," as a family party of Partridges is always called, was lodged, and the greatest pains were taken to break in the "pointers" or "setters" to their duty. In this way marvellous success was attained, and the delight lay nearly as much in seeing the dogs quarter the ground, wind and draw up to the game, helping them at times (for a thorough understanding between man and beast was necessary for the perfection of the sport) by word or gesture, as in bringing down the bird after it had been finally sprung. There are many who lament that the old-fashioned practice of shooting Partridges to dogs has, with rare exceptions, fallen into desuetude, and it is commonly believed that this result has followed wholly from the desire to make larger and larger bags of game. The opinion has a certain amount of truth for its base; but those who hold it omit to notice the wholly changed circumstances in which Partridge-shooters now find themselves. In the old days there were plenty of broad, tangled hedgerows which afforded permanent harbour for the birds, and at the beginning of the shooting-season admirable shelter or "lying" (to use the sportsman's word) was found in the rough stubbles, often reaped knee-high, foul with weeds and left to stand some six or eight weeks before being ploughed, as well as in the turnips that were sown broadcast. Throughout the greater part of England now the fences are reduced to the narrowest of boundaries and are mostly trimly kept; the stubbles—mown, to begin with, as closely as possible to the ground—are ploughed within a short time of the corn being carried, and the turnips are drilled in regular lines, offering inviting alleys between them along which Partridges take foot at any unusual noise. Pointers in such a district—and to this state of things all the arable part of England is tending—are simply useless, except at the beginning of the season, when the young birds are not as yet strong on the wing, and the old birds are still feeble from moulting their quill-feathers. Of late years therefore other modes of shooting Partridges have had to be employed, of which methods the most popular is that known as "driving"—the "guns" being stationed in more or less concealment at one end of the field, or series of fields, which is entered from the other by men or boys who deploy into line and walk across it making a noise. It is the custom with many to speak depreciatingly of this proceeding, but it is a fact that as much knowledge of the ways of Partridges is needed to ensure a successful day's "driving" as was required of old when nearly everything was left to the intelligence of the dogs, for the course

of the birds' flight depends not only on the position of the line of beaters, but almost on the station of each person composing it, in relation to the force and direction of the wind and to the points on which it is desired that the Partridges should converge. Again, the skill and alacrity wanted for bringing down birds flying at their utmost velocity, and often at a considerable height, is enormously greater than that which sufficed to stop those that had barely gone 20 yards from the dog's nose, though admittedly Partridges rise very quickly and immediately attain great speed. Moreover, the shooting of Partridges to pointers came to an end in little more than six weeks, whereas "driving" may be continued for the whole season, and is never more successful than when the birds, both young and old, have completed their moult, and are strongest upon the wing. But, whether the new fashion be objectionable or not, it cannot be doubted that to go back to the old one with success would necessitate a reversion to the slovenly methods of agriculture followed in former years, and therefore is as impossible as would be a return to the still older practice of taking Partridges in a setting-net, described by Gervase Markham or Willughby.

The Grey Partridge has doubtless largely increased in numbers in Great Britain since the beginning of the present century, when so much down, heath, and moorland was first brought under the plough, for its partiality to an arable country is very evident. It has been observed that the birds which live on grass lands or heather only are apt to be smaller and darker in colour than the average; but in truth the species when adult is subject to a much greater variation in plumage than is commonly supposed, and the well-known chestnut horse-shoe mark, generally considered distinctive of the cock, is very often absent. In Asia our Partridge seems to be unknown, but in the temperate parts of Eastern Siberia its place is taken by a very nearly allied form, *P. barbata*, and in Tibet there is a bird, *P. hodgsonia*, which can hardly with justice be generically separated from it. The relations of some other forms inhabiting the Indian Region are at present too obscure to make any notice of them expedient here.

The common Red-legged Partridge of Europe, generally called the French Partridge, *Caccabis rufa*, seems to be justifiably considered the type of a separate group.<sup>1</sup> This bird has been introduced into England within little more than one hundred years ago, and has established itself in various parts of the country, notwithstanding a widely-spread, and in some respects unreasonable prejudice against it. It has certainly the habit of trusting nearly as much to its legs as to its wings, and thus incurred the obloquy of old-fashioned sportsmen, whose dogs it vexatiously kept at a running point; but, when it was also accused of driving away the Grey Partridge, the charge only shewed the ignorance of those that brought it, for as a matter of fact the French Partridge rather prefers ground which the common species avoids—such as the heaviest clay-soils, or the most infertile heaths. But even where the two species meet, the present writer can declare from the personal observation of many years that the alleged antipathy between them is imaginary, and unquestionably in certain parts of the country the "head of game" has been increased by

the introduction of the foreigner.<sup>2</sup> The French Partridge has several congeners, all with red legs and plumage of similar character. In Africa north of the Atlas there is the Barbary Partridge, *C. petrosa*; in southern Europe another, *C. saxatilis*, which extends eastward till it is replaced by *C. chukar*, which reaches India, where it is a well-known bird. Two very interesting desert-forms, supposed to be allied to *Caccabis*, are the *Ammoperdix heyi* of North Africa and Palestine and the *A. bonhamsi* of Persia; but the absence of the metatarsal knob, or incipient spur, suggests (in our ignorance of their other osteological characters) an alliance rather to the genus *Perdix*. On the other hand the groups of birds known as Francolins and Snow-Partridges are generally furnished with strong but blunt spurs, and therefore probably belong to the Caccabine group. Of the former, containing many species, there is only room here to mention the Francolin, which used to be found in many parts of the South of Europe, *Francolinus vulgaris*, which also extends to India, where it is known as the Black Partridge. This seems to have been the *Attagas* or *Attagen* of classical authors,<sup>3</sup> a bird so celebrated for its exquisite flavour, the strange disappearance of which from all or nearly all its European haunts has been before noticed (BIRDS, vol. iii. p. 736, note), and still remains inexplicable. It is possible that this bird has been gradually vanishing for several centuries, and if so to this cause may be attributed the great uncertainty attending the determination of the *Attagen*—it being a common practice among men in all countries to apply the name of a species that is growing rare to some other that is still abundant. Of the Snow-Partridges, *Tetraogallus*, it is only to be said here that they are the giants of their kin, and that nearly every considerable range of mountains in Asia seems to possess its specific form.

By English colonists the name Partridge has been very loosely applied, and especially so in North America. Where a qualifying word is prefixed no confusion is caused, but without it there is sometimes a difficulty at first to know whether the Ruffed Grouse (*Bonasa umbellus*) or the Virginian Colin (*Ortyx virginianus*) is intended. (A. N.)

PASCAL, BLAISE (1623-1662), was born at Clermont Ferrand on the 19th June 1623. His father was Étienne Pascal, president of the Court of Aids at Clermont; his mother's name was Antoinette Bégon. The Pascal family were Auvergnats by extraction as well as residence, and they had for many generations held posts in the civil service. They were ennobled by Louis XI. in 1478, but, as in many other cases, no attempt seems to have been made to assume the privileged particle *de*. The earliest anecdote of Pascal is a singular story recorded by his niece, Marguerite Perier (the heroine of the Holy Thorn miracle), of his being bewitched, and freed from the spell by the witch with strange ceremonies. His mother died when he was about four years old (the exact date is differently stated), and left him with two sisters—Gilberte, who afterwards married M. Perier, and Jaqueline. Both sisters are of importance in their brother's history, and both are said to have been beautiful and accomplished. When Pascal was about seven years old, his mother having been already dead for some time, Étienne Pascal the father gave up his official post at Clermont, and betook himself

<sup>1</sup> Prof. Parker first (*Trans. Zool. Soc.*, v. p. 155) and, after him, Prof. Huxley (*Proc. Zool. Soc.*, 1863, pp. 299-302) have pointed out that the true *Gallina* offer two types of structure, "one of which may be called Gallina, and the other Tetraonina," to use the latter's words, though he is "by no means clear that they do not graduate into one another"; and, according to the characters assigned by him, *Caccabis* lies "on the Gallina side of the boundary," while *Perdix* belongs to the Tetraonina group. Further investigation of this matter is very desirable, and, with the abundant material possessed by biological gardens, it might easily be carried out.

<sup>2</sup> It is a singular fact that the game-preservers who object most strongly to the Red-legged Partridge are not agreed on the exact grounds of their objection. One party will declare that it vanquishes the Grey Partridge, while the other holds that, though the latter, the "English" Partridge, is much vexed by the introduced species, it invariably beats off the "Frenchman"!

<sup>3</sup> However, many naturalists have maintained a different opinion—some making it a Woodcock, a Godwit (*g.v.*), or even the Hazel-hen (see GROUSE, vol. xi. p. 223). The question has been well discussed by Lord Lilford (*Ibid.*, 1862, pp. 352-356).

to Paris for the education of his children and for his own indulgence in scientific society. It does not appear that Blaise, who went to no school, but was taught by his father, was at all forced, but rather the contrary. Nevertheless he has a distinguished place in the story of precocious children, and in the much more limited chapter of children whose precocity has been followed by great performance at maturity, though he never became what is called a learned man, perhaps did not know Greek, and was pretty certainly indebted for most of his miscellaneous reading to Montaigne. How, purposely kept from books, he worked out the more elementary problems of geometry for himself; how at sixteen he wrote a treatise on conic sections which Descartes refused to believe in except as the work of a master and not of a student; how he wrote treatises on acoustics at twelve, and began elaborate calculating machines when he was still a boy,—are things dwelt upon in all biographies of him. In this notice his attainments in mathematical and physical science, except those which have some special connexion with his life and history, will be dealt with separately and later.

The Pascal family, some years after settling in Paris, had to go through a period of adversity. Étienne Pascal, on leaving Clermont, had bought certain of the *Hôtel de Ville rentes*, almost the only regular investment open to Frenchmen at the time. Richelieu reduced the interest and the investors protested, Pascal amongst them. But the great cardinal did not understand such protests, and to escape the Bastille Pascal had to go into hiding. He was, according to the story, restored to favour owing to the good acting and graceful appearance of his daughter Jacqueline in a representation of Scudéry's *Amour Tyrannique* before Richelieu. Indeed Jacqueline, who was only fourteen, herself gives the account in a pleasant letter which is extant, and which contains an allusion to her brother's mathematical prowess. Madame d'Aiguillon's intervention in the matter was perhaps as powerful as Jacqueline's acting, and Richelieu not only relieved Étienne Pascal from the necessity of keeping out of the way, but gave him (in 1641) the important and lucrative though somewhat troublesome intendency of Rouen. The family accordingly removed to the Norman capital, though Gilberte Pascal shortly after, on her marriage, returned to Clermont. At Rouen they became acquainted with Corneille, and Blaise Pascal pursued his studies with such vehemence that he already showed signs of an injured constitution. Nothing, however, of importance happened till the year 1646. Then Pascal the elder was confined to the house by the consequences of an accident on the ice, and was visited by certain gentlemen of the neighbourhood who had come under the influence of St Cyran and the Jansenists. It does not appear that up to this time the Pascal family had been contempters of religion, but they now eagerly embraced the creed, or at least the attitude of Jansenism. One of the more immediate results of this conversion has rather shocked some modern admirers of Pascal, who forget that toleration, except of the Gallic kind, is an idea which had no place in men's minds in Pascal's day. He came into contact with a Capuchin known as Père St Ange, but whose real name was Forton, and who seems to have entertained some speculative ideas on theological points which were not strictly orthodox. Thereupon Pascal with some of his friends lodged an information against the heretic with the representative of the archbishop of Rouen. There seems to have been no lack of zeal about the accusers, but the accused made no difficulty whatever in making profession of orthodoxy, and the judge appears to have been by no means anxious to push the matter home. No doubt Pascal was perfectly sincere, and like most of his contemporaries held the

opinion attributed to a great English nonconformist contemporary of his, that, while it was very shocking that men who were in the right should not be tolerated, it was almost equally shocking that men who were in the wrong should be.

His bodily health was at this time very far from satisfactory, and he appears to have suffered, not merely from acute dyspepsia, but from a kind of paralysis. He was, however, except when physicians positively forbade study, and probably sometimes when they did so forbid, indefatigable in his mathematical work. In 1647 he published his *Nouvelles Expériences sur le Vide*, and in the next year the famous experiment with the barometer on the Puy de Dome was carried out for him by his brother-in-law Perier, and repeated on a smaller scale by himself at Paris, to which place by the end of 1647 he and his sister Jacqueline had removed, to be followed shortly by their father. In a letter of Jacqueline's dated the 27th of September, an account of a visit paid by Descartes to Pascal is given, which, like the other information on the relations of the two, gives strong suspicion of mutual jealousy. Descartes, however, gave Pascal the very sensible advice to stay in bed as long as he could (it may be remembered that the philosopher himself never got up till eleven) and to take plenty of beef tea. But the relations of Pascal with Descartes belong chiefly to the scientific achievements of the former. He had, however, other relations, both domestic and miscellaneous, which had nothing to do with science. As early as May 1648 Jacqueline Pascal was strongly drawn to Port Royal, and her brother frequently accompanied her to its church. She desired indeed to join the convent, but her father, who at the date above mentioned returned to Paris with the dignity of counsellor of state (his functions at Rouen having ceased), disapproved of the plan, and took both brother and sister to Clermont. Pascal stayed in Auvergne for the greater part of two years, but next to nothing is known of what he did there. Fléchier, in his account of the *Grands Jours* at Clermont many years after, speaks of a "belle savante" in whose company Pascal had frequently been—a trivial mention on which, as on many other trivial points of scantily known lives, the most childish structures of comment and conjecture have been based. It is sufficient to say that at this time, despite the Rouen "conversion," there is no evidence to show that Pascal was in any way a recluse, an ascetic, or in short anything but a young man of great intellectual promise and performance who was not indifferent to society, but whose aptitude both for society and study was affected by weak health and the horse-doctoring of the time. He, his sister, and their father returned to Paris in the late autumn of 1650, and in September of the next year Étienne Pascal died. Almost immediately afterwards Jacqueline fulfilled her purpose of joining Port Royal—a proceeding which led to some soreness, finally healed, between herself and her brother and sister as to the disposal of her property. Perhaps this difference, but more probably the mere habitual use of the well-known dialect of Port Royal, led Jacqueline to employ in reference to her brother expressions which have led biographers into most unnecessary excursions of fancy. For these they have seemed to find further warrant in similar phrases used by the Periers, mother and daughter. It has been supposed that Pascal, from 1651 or earlier to the famous accident of 1654, lived a dissipated, extravagant, worldly, luxurious (though admittedly not vicious) life with his friend the Duc de Roannes and others. His *Discours sur les Passions de l'Amour*, a striking and characteristic piece, only recently discovered and printed, has also been assigned to this period, and has been supposed to indicate a hope-



less passion for Charlotte de Roannez, the duke's sister. It cannot be too decidedly said that all this is sheer romancing. The extant letters of Pascal to the lady show no trace of any affection (stronger than friendship) between them. As to Pascal's worldly life, it might be thought that only the completest ignorance of the usual dialect of the stricter religious sects and societies (and it may be added of Port Royal in particular) could induce any one to lay much stress on that. A phrase of Jacqueline's about the "horribles attaches" which bound her brother to the world may pair off with hundreds of similar expressions from Bunyan downwards. It is, however, certain that in the autumn of 1654 Pascal's second "conversion" took place, and that it was lasting. He betook himself at first to Port Royal, and began to live a recluse and austere life there. Madame Perier simply says that Jacqueline persuaded him to abandon the world. Jacqueline represents the retirement as the final result of a long course of dissatisfaction with mundane life. But there are certain anecdotic embellishments of the act which are too famous to be passed over, though they are in part apocryphal. It seems that Pascal in driving to Neuilly was run away with by the horses, and would have been plunged in the river but that the traces fortunately broke. To this, which seems authentic, is usually added the late and more than doubtful tradition (due to the Abbé Boileau) that afterwards he used at times to see an imaginary precipice by his bedside or at the foot of the chair on which he was sitting. Further, from November 23, 1654, dates the singular document usually known as "Pascal's amulet," a parchment slip which he wore constantly about him, and which bears the date followed by some lines of incoherent and strongly mystical devotion.

But, whatever may have been the immediate cause of Pascal's conversion and (for a time) domestication at Port Royal, it certainly had no evil effect on his intellectual or literary powers. Indeed, if he had been drowned at Neuilly he would hardly be thought of now as anything but an extraordinarily gifted man of science. It must also be noted that, though he lived much at Port Royal, and partly at least observed its rule, he never actually became one of its famous solitaries. But for what it did for him (and for a time his health as well as his peace of mind seems to have been improved) he very soon paid the most ample and remarkable return that any man of letters ever paid to any institution. At the end of 1655 Arnauld, the chief light of Port Royal, was condemned by the Sorbonne for a letter which he had published expressing doubt whether the famous five propositions were to be found in Jansen, and, as much was made of this condemnation, it was thought important by the Jansenist and Port Royal party that steps should be taken to disburse the popular mind on the whole controversy. Arnauld would have undertaken the task himself, but his wiser friends knew that his style was anything but popular, and overruled him. It is said that he personally suggested to Pascal to try his hand, and that the first of the famous *Provincial Letters* (this familiar name, or rather misnomer, is an abbreviation from the proper title of *Lettres Ecrites par Louis de Montalte à ses Provinciaux de ses Amis*) was written in a few days, or, less probably, in a day. It was printed on the 23d January 1656, and, being immensely popular and successful, was followed by others to the number of eighteen, in which not merely the special points at issue but the whole ethical and doctrinal system of the Jesuits was pulled to pieces.

In the *Provinciales* Pascal, who it must be remembered published under a strict incognito, denies that he belongs to Port Royal, and in fact, though during the last years of his life he was wholly devoted to its interests, he was

never a regular resident there, and usually abode in his own house at Paris. Shortly after the appearance of the *Provinciales*, on May 24, 1656, occurred the miracle of the Holy Thorn, a fragment of the crown of Christ preserved at Port Royal, which cured the little Marguerite Perier of a fistula lacrymalis. The Jesuits were much mortified by this Jansenist miracle, which, as it was officially recognised, they could not openly deny. Pascal and his friends rejoiced in proportion. But the details of his later years after this incident are somewhat scanty, and as recorded by his sister and niece they tell of increasing ill health, and of ascetic practices and beliefs increasing still more. One curious incident, contrasting equally with this state of things and with Pascal's studious character and renown, is what Madame Perier calls "l'affaire des carrosses," a scheme of the Duc de Roannez and others for running omnibuses in Paris, which was actually carried out, of which Pascal was in some sort manager, and from which he derived some profit. This, however, is an exception. Otherwise, for years before his death, we hear only of acts of charity and of, as it seems to modern ideas, extravagant asceticism. Thus Madame Perier tells us that he disliked to see her caress her children, and would not allow the beauty of any woman to be talked of in his presence. What may be called his last illness began as early as 1658, after which year he never seems to have enjoyed even tolerable health, and as the disease progressed it was attended with more and more pain, chiefly in the head. In June 1662, having given up his own house to a poor family who were suffering from small-pox, and being unwilling that his sister should expose herself to infection, he went to her house to be nursed, and never afterwards left it. His state was, it seems, mistaken by his physicians, who to the last maintained that there was little danger—so much so that the offices of the church were long put off. He was able, however, to receive the eucharist, and soon afterwards died in convulsions on August 19th. A *post mortem* examination was held, which showed not only grave derangement in the stomach and other organs, but a serious lesion of the brain.

Eight years after Pascal's death appeared, in a small volume, the book which has given most trouble to all students of Pascal, and most pleasure to some of them. It purported to be Pascal's *Pensées*, and a preface by his nephew Perier gave the world to understand that these were fragments of a great projected apology for Christianity which the author had in conversation with his friends planned out years before. The editing of the book was peculiar. It was submitted to a committee of influential Jansenists, with the Duc de Roannez at their head, and, in addition, it bore the imprimatur of numerous unofficial approvers who testified to its orthodoxy. It does not appear that there was much suspicion of the garbling which had been practised,—garbling not unusual at the time, and excused in this case by the fact of a lull in the troubles of Port Royal and a great desire on the part of its friends to do nothing to disturb that lull. But as a matter of fact no more entirely fictitious book ever issued from the press. The fragments which it professed to give were in themselves confused and incoherent enough, nor is it easy to believe that they all formed part of any such single and coherent design as that referred to above. But the editors omitted, altered, added, separated, combined, and so forth entirely at their pleasure, actually making some changes which seem to have been thought improvements of style. As an instance of their anxiety to avoid offence, it may be noticed that they rejected, apparently as too outspoken, Madame Perier's invaluable life of her brother, which was written to accompany the second edition of the *Pensées*, but did not actually appear with them till 1684.

This *rifacimento* remained the standard text with a few unimportant additions for nearly two centuries, except that by a truly comic revolution of public taste Condorcet in 1776 published, after study of the original, which remained accessible in manuscript, another garbling, conducted this time in the interests of unorthodoxy. It was not till 1842 that Victor Cousin drew attention to the absolutely untrustworthy condition of the text, nor till 1844 that M. Faugère edited that text from the MS. in something like a condition of purity, though, as subsequent editions have shown, not with absolute fidelity. But even in its spurious condition the book had been recognized as remarkable and almost unique. Its contents, as was to be expected, are of a very chaotic character—of a character so chaotic indeed that the reader is almost at the mercy of the arrangement, perforce an arbitrary arrangement, of the editors. But the subjects dealt with concern more or less all the great problems of thought on what may be called the theological side of metaphysics:—the sufficiency of reason, the trustworthiness of experience, the admissibility of revelation, free will, foreknowledge, and the rest. The peculiarly disjointed and fragmentary condition of the sentiments expressed by Pascal aggravates the appearance of universal doubt which is present in the *Pensées*, just as the completely unfinished condition, from the literary point of view, of the work constantly causes slighter or graver doubts as to the actual meaning which the author wished to express. Accordingly the *Pensées* have always been a favourite exploring ground, not to say a favourite field of battle, to persons who take an interest in the problems. Speaking generally, their tendency is towards the combating of scepticism by a deeper scepticism, or, as Pascal himself calls it, Pyrrhonism, which occasionally goes the length of denying the possibility of any natural theology. Pascal explains all the contradictions and difficulties of human life and thought by the doctrine of the fall, and relies on faith and revelation alone to justify each other. Comparison of the *Pensées* with the *Provinciales* is, considering the radical differences of state (the one being a finished work deliberately issued from the master's hands, the other not even a rough draught, scarcely even "heads" or "outlines," but a collection of loose and uncorrected notes settled neither as to the exact form of each nor as to the relation of each to any whole), impossible. But it may be said that no one can properly perceive how great a man of letters Pascal was from the *Pensées* alone, and that no one can perceive how deep if not wide a thinker he was from the *Provinciales* alone. An absolute preference of either argues a certain oneness in the relative estimate of matter and form. The wiser mind distinctly prefers both, and recognizes that if either were lacking the greatness of Pascal would fail to be perceived, or at least to be perceived fully.

Excluding his scientific attainments, which, as has been noted above, will be the subject of separate notice, Pascal presents himself for comment in two different lights, the second of which is, if the expression be permitted, a composite one. The first exhibits him as a man of letters, the second as a philosopher, a theologian, and a man. If this last combination seems to be audacious or clumsy, it can only be said that in hardly any thinker are theological thoughts, and thoughts more strictly to be called philosophical or metaphysical, so intimately, so inextricably blended as in Pascal, and that in none is the colour of the theology and the philosophy more distinctly personal. This latter fact adds to the difficulty of the problem; for, though Pascal has written not a little, and though a vast amount has been written about him, it cannot be said that his character as a man, not a writer, is very distinct.

The accounts of his sister and niece have the defect of all hagiology (to use the term with no disrespectful intention); they are obviously written rather with a view to the ideas and the wishes of the writers than with a view to the actual and absolute personality of the subject. Except from these interesting but somewhat tainted sources, we know little or nothing about him. Hence conjecture, or at least inference, must always enter largely into any estimate of Pascal, except a purely literary one.

On that side, fortunately, there is no possibility of doubt or difficulty to any competent inquirer. The *Provinciales Letters* are the first example of French prose which is at once considerable in bulk, varied and important in matter, perfectly finished in form. They owe not a little to Descartes, for Pascal's indebtedness to his predecessor is unquestionable from the literary side, whatever may be the case with the scientific. But Descartes had had neither the opportunity, nor the desire, nor probably the power, to write anything of the literary importance of the *Provinciales*. The unanimity of eulogy as to the style of this wonderful book has sometimes tempted foreigners, who feel or affect to feel an inability to judge for themselves, into a kind of scepticism for which there is absolutely no ground. The first example of polite controversial irony since Lucian, the *Provinciales* have continued to be the best example of it during more than two centuries in which the style has been sedulously practised, and in which they have furnished a model to generation after generation without being surpassed by any of the works to which they have shown the way. The unflinching freshness and charm of the contrast between the importance, the gravity, in some cases the dry and abstruse nature, of their subjects and the lightness sometimes almost approaching levity in its special sense of the manner in which these subjects are attacked is a triumph of literary art of which no familiarity dims the splendour, and which no lapse of time, affecting as that lapse has already done to a great extent the attraction of the subjects themselves, can ever impair. The tools of phrase and diction by which this triumph is achieved were not in all cases Pascal's invention—Descartes and Corneille had been beforehand with him to some extent—but many of them were actually new, and all were newly and more skilfully applied. Nor perhaps is this literary art really less evident in the *Pensées*, though it is less clearly displayed, owing to the fragmentary or rather chaotic condition of the work, and partly also to the fact that the subject here for many readers and in many places claims attention almost to the disregard of the form. The vividness and distinction of Pascal's phrase, his singular faculty of inserting in the gravest and most impassioned meditation what may be almost called quips of thought and diction without any loss of dignity, the intense earnestness of meaning weighting but not confusing the style, all appear here, and some of them appear as they have no chance of appearing in at least the earlier *Provinciales*.

No such positive statements as these are, however, possible as to the substance of the *Pensées* and the attitude of their author towards "les grands sujets." In the space and circumstances of the present notice nothing more can be attempted than a summary of the opinions hitherto advanced on the subject, and an indication of the results which may seem most probable to unprejudiced inquirers who possess a fair knowledge of and interest in the problems concerned. Hitherto the widest differences have been manifested in the estimate of Pascal's opinions on the main questions of philosophy, theology, and human conduct. He has been represented as a determined apologist of intellectual orthodoxy animated by an almost fanatical "hatred of reason," and possessed with a purpose

overthrow the appeal to reason; as a sceptic and pessimist of a far deeper dye than Montaigne, anxious chiefly to show how any positive decision on matters beyond the range of experience is impossible; as a nervous believer clinging to conclusions which his clearer and better sense showed to be indefensible; as an almost ferocious ascetic and paradoxer affecting the *credo quia impossibile* in intellectual matters and the *odi quia amabile* in matters moral and sensuous; as a wanderer in the regions of doubt and belief, alternately bringing a vast though vague power of thought and an unequalled power of expression to the expression of ideas incompatible and irreconcilable. In these as in all other matters the first requisite seems to be to clear the mind of prepossession and commonplace. It has already been hinted that far too much stress may be laid on the description of Pascal by his family as a converted sinner, and it may be added that at least as much stress has been laid on the other side of the notion of him as of a clear-headed materialist and expert in positive science, who by ill-health, overwork, and family influence was persuaded to adopt, half against his will, supernaturalist opinions. An unbiassed study of the scanty facts of his history, and of the tolerably abundant but scattered and chaotic facts of his literary production, ought to enable any one to steer clear of these exaggerations, while admitting at the same time that it is impossible to give a complete and final account of his attitude towards the riddles of this world and others. He certainly was no mere advocate of orthodoxy; he as certainly was no mere victim of terror at scepticism; least of all was he a free-thinker in disguise. He appears, as far as can be judged from the fragments of his *Pensées*, to have seized much more firmly and fully than has been usual for two centuries at least the central idea of the difference between reason and religion. Where the difficulty rises respecting him is that most thinkers since his day who have seen this difference with equal clearness have advanced from it to the negative side, while he advanced to the positive. In other words, most men since his day who have not been contented with a mere concordat, have let religion go and contented themselves with reason. Pascal, equally discontented with the concordat, held fast to religion and continued to fight out the questions of difference with reason. The emotion, amounting to passion, which he displays in conducting this campaign, and the superfluous energy of his debate on numerous points which, for instance, such a man as Berkeley was content to leave in the vague must be traced to temperament, aggravated no doubt by his extreme intellectual activity, by ill health, and by his identification comparatively late in life and under peculiar circumstances with a militant and so to speak sectarian form of religious or ecclesiastical belief. Surveying these positions, we shall not be astonished to find much that is surprising and some things that are contradictory in Pascal's utterances on "les grands sujets." But the very worst method that can be taken for dealing with these contradictions is to assume, as his critics on one side too often do, that so clever a man as Pascal could not possibly be a convinced acceptor of dogmatic Christianity, or to assume, as too many of his critics on the other do, that so pious and orthodox a man as Pascal could not entertain any doubts or see any difficulties in reference to dogmatic Christianity. He had taken to the serious contemplation of theological problems comparatively late; for the Rouen escapade noted above is merely a specimen of the kind of youthful intolerance which counts for nothing when justly viewed. The influence exercised on him by Montaigne is the one fact regarding him which has not been and can hardly be exaggerated, and his well-known *Entretien* with Sacy on the subject (the restoration of

which to its proper form is one of the most valuable results of recent criticism) leaves no doubt possible as to the source of his "Pyrrhonian" method. The atmosphere of somewhat heated devotion in which he found himself when he retired to Port Royal must naturally count for something in the direction and expression of his thoughts; his broken health for something more. It is unfortunately usual with societies like Port Royal to generate a kind of mist and mirage which deceives and distorts, even the keenest sight that looks through their eyes. But it is impossible for any one who takes Pascal's *Pensées* simply as he finds them in connexion with the facts of Pascal's history to question his theological orthodoxy, understanding by theological orthodoxy the acceptance of revelation and dogma; it is equally impossible for any one in the same condition to declare him absolutely content with dogma and revelation. Excursions into the field beyond formularies were necessary to him, and he made them freely; but there is no evidence that these excursions tempted him to remain outside, and it appears particularly erroneous to take his celebrated "wager" thoughts (the argument that, as another world and its liabilities, if accepted, imply no loss and much possible gain, they should be accepted) as an evidence of weakened belief or a descent from rational religion. It is of the essence of an active mind like Pascal's to explore and state all the arguments of whatever degree of goodness which make for or make against the conclusion it is investigating, and this certainly is neither the least obvious nor the weakest of the arguments which must have presented themselves to him.

In ecclesiastical questions as distinguished from theological Pascal appears to have been an ardent Jansenist, adopting without very much discrimination the standpoint of his friends and religious directors Sacy, Arnould, Singlin, and others. In one point he went beyond them, boldly disputing the infallibility of the pope, and hinting not obscurely at the propriety of agitation against erroneous papal decisions. The Jansenists as a body could not muster courage to adopt this attitude. But it is not easy to discuss isolated points of this kind here; indeed their discussion belongs more properly to the general subject of Jansenism, and the history of Port Royal.

To sum up, the interest and value of the *Pensées* is positively diminished if they are taken as gropings after self-satisfaction or feeble attempts at freethinking. They are excursions into the great unknown made with a full acknowledgment of the greatness of that unknown, but with no kind of desire for something more known than the writer's own standpoint. If to any one else they communicate such a desire that is not Pascal's fault; and, if it seems to any one that without such a desire they could not have been indulged in, that comes mainly from an alteration of mental attitude, and from a want of familiarity with the mental attitude of Pascal's own time. From the point of view that belief and knowledge, based on experience or reasoning, are separate domains with an unexplored sea between and round them, Pascal is perfectly comprehensible, and he need not be taken as a deserter from one region to the other. To those who hold that all intellectual exercise outside the sphere of religion is impious, or that all intellectual exercise inside that sphere is futile, he must remain an enigma.

There are few writers who are more in need than Pascal of being fully and competently edited. The chief nominally complete edition at present in existence is that of Bossut (1779, 5 vols., and since reprinted), which not only appeared before any attempt had been made to restore the true text of the *Pensées*, but is in other respects quite inadequate. The edition of Lahure, 1858, is not much better, though the *Pensées* appear in their more genuine form. An

edition has been long promised for the excellent collection of *Les Grands Écrivains de la France*; it has been understood to be under the charge of M. Faugère. Meanwhile, with the exception of the *Provinciales* (of which there are numerous editions, no one much to be preferred to any other, for the text is undisputed and the book itself contains almost all the exegesis of its own contents necessary), Pascal can be read only at a disadvantage. There are four chief editions of the true *Pensées*: that of M. Faugère (1844), the *editio princeps*; that of M. Havet (1852, 1867, and 1881), on the whole the best; that of M. Victor Rochet (1878), good, but arranged and edited with the deliberate intention of making Pascal first of all an orthodox apologist; and that of M. Molinier (1877-79), a carefully edited and interesting text, the important corrections of which have been introduced into M. Havet's last edition. Unfortunately, none of these can be said to be exclusively satisfactory. The minor works must chiefly be sought in Bosaut or reprints of him. Works on Pascal are innumerable: Sainte-Beuve's *Port Royal*, Cousin's writings on Pascal and his *Jacquelles Pascal*, and the essays of the editors of the *Pensées* just mentioned are the most noteworthy. Principal Tulloch has contributed a useful little monograph to the series of *Foreign Classics for English Readers* (Edinburgh and London, 1878).

*Pascal as Natural Philosopher and Mathematician.*—Great as is Pascal's reputation as a philosopher and man of letters, it may be fairly questioned whether his claim to be remembered by posterity as a mathematician and physicist is not even greater. In his two former capacities all will admire the form of his work, while some will question the value of his results; but in his two latter capacities no one will dispute either. He was a great mathematician in an age which produced Descartes, Fermat, Huygens, Wallis, and Roberval. There are wonderful stories on record of his precocity in mathematical learning, which is sufficiently established by the well-attested fact that he had completed before he was sixteen years of age a work on the conic sections, in which he had laid down a series of propositions, discovered by himself, of such importance that they may be said to form the foundations of the modern treatment of that subject. Owing partly to the youth of the author, partly to the difficulty in publishing scientific works in those days, and partly no doubt to the continual struggle on his part to devote his mind to what appeared to his conscience more important labour, this work (like many others by the same master-hand) was never published. We know something of what it contained from a report by Leibnitz, who had seen it in Paris, and from a résumé of its results published in 1640 by Pascal himself, under the title *Essai pour les Coniques*. The method which he followed was that introduced by his contemporary Desargues, viz., the transformation of geometrical figures by conical or optical projection. In this way he established the famous theorem that the intersections of the three pairs of opposite sides of a hexagon inscribed in a conic are collinear. This proposition, which he, called the mystic hexagram, he made the keystone of his theory; from it alone he deduced more than four hundred corollaries, embracing, according to his own account, the conics of Apollonius, and other results innumerable.

Pascal also distinguished himself by his skill in the infinitesimal calculus, then in the embryonic form of Cavalieri's method of indivisibles. The cycloid was a famous curve in those days; it had been discussed by Galileo, Descartes, Fermat, Roberval, and Torricelli, who had in turn exhausted their skill upon it. Pascal solved the hitherto refractory problem of the general quadrature of the cycloid, and proposed and solved a variety of others relating to the centre of gravity of the curve and its segments, and to the volume and centre of gravity of solids of revolution generated in various ways by means of it. He published a number of these theorems without demonstration as a challenge to contemporary mathematicians. Solutions were furnished by Wallis, Huygens,

Wren, and others; and Pascal published his own in the form of letters from Amos Dettonville (his assumed name as challenger) to M. Cercavi. There has been some discussion as to the fairness of the treatment accorded by Pascal to his rivals, but no question of the fact that his initiative led to a great extension of our knowledge of the properties of the cycloid, and indirectly hastened the progress of the differential calculus.

In yet another branch of pure mathematics Pascal ranks as a founder. The mathematical theory of probability and the allied theory of the combinatorial analysis were in effect created by the correspondence between Pascal and Fermat, concerning certain questions as to the division of stakes in games of chance, which had been propounded to the former by the gaming philosopher De Méris. A complete account of this interesting correspondence would surpass our present limits; but the reader may be referred to Todhunter's *History of the Theory of Probability* (Cambridge and London, 1865) pp. 7-31. It appears that Pascal contemplated publishing a treatise *De Aleæ Geometria*; but all that actually appeared was a fragment on the arithmetical triangle ("Properties of the Figurate Numbers") printed in 1654, but not published till 1665, after his death.

Pascal's work as a natural philosopher was not less remarkable than his discoveries in pure mathematics. His experiments and his treatise (written 1653, published 1662) on the equilibrium of fluids entitle him to rank with Galileo and Stevinus as one of the founders of the science of hydrodynamics. The idea of the pressure of the air and the invention of the instrument for measuring it were both new when he made his famous experiment, showing that the height of the mercury column in a barometer decreases when it is carried upwards through the atmosphere. This experiment was made in the first place by himself in a tower at Paris, and was afterwards carried out on a grand scale under his instructions by his brother-in-law Perier on the Puy de Dôme in Auvergne. Its success greatly helped to break down the old prejudices, and to bring home to the minds of ordinary men the truth of the new ideas propounded by Galileo and Torricelli.

Whether we look at his pure mathematical or at his physical researches we receive the same impression of Pascal; we see the strongest marks of a great original genius creating new ideas, and seizing upon, mastering, and pursuing farther everything that was fresh and unfamiliar in his time. After the lapse of more than two hundred years, we can still point to much in exact science that is absolutely his; and we can indicate infinitely more which is due to his inspiration. (A. C. E.)

PASCHAL I., pope from 817 to 824, a native of Rome, was raised to the pontificate by popular acclamation, shortly after the death of Stephen IV., and before the sanction of the emperor (Louis the Pious) had been obtained—a circumstance for which it was one of his first cares to apologize. His relations with the imperial house, however, never became cordial; and he was also unsuccessful in retaining in Rome itself the popularity to which he had owed his election. He died at Rome while the imperial commissioners were investigating the circumstances under which two important officers of Lothair, the eldest son of Louis, had been seized at the Lateran, blinded, and afterwards beheaded; Paschal had shielded the murderers but denied all personal complicity in their crime. The Roman people refused him the honour of burial within the church of St Peter, but he now holds a place in the Roman calendar (May 16). Like one or two of his more immediate predecessors he was liberal in his donations to several churches of the city, St Cecilia in Trastevere having been restored and St Maria in Domnica

rebuilt by him; he also built the church of St Prassede. The successor of Paschal I. was Eugenius II.

**PASCHAL II.**, pope from 1099 to 1118, was the successor of Urban II. Of his early history nothing is known except that his proper name was Rainieri, that he was of Tuscan origin, and that in early life he became a monk, probably of Cluny. He was raised to the cardinalate by Gregory VII. about 1076, and was elected to the papal chair on August 13, 1099. In the long struggle with the imperial power about *INVESTITURE* (*q.v.*) he zealously carried on the Hildebrandine policy, but hardly with Hildebrandine success. One of his first acts was to expel from Rome the antipope Clement III., otherwise known as Guibert of Ravenna, and to renew his predecessor's sentence of excommunication against the emperor Henry IV., by the help of whose rebellious son it seemed at one time as if the claims of the church were to become wholly triumphant. But Prince Henry, who succeeded to the purple in 1106 (see **HENRY V.**), proved a still more active and persistent opponent of papal pretensions than ever his father had been. Paschal was courteously invited to Germany to assist in arranging definitely the affairs of the empire (1107), but, while the pope delayed his journey, the emperor proceeded actually to exercise all the rights of investiture to the fullest extent, and, having disposed of various wars in Bohemia, Hungary, and Poland, announced in 1110 the intention of proceeding to Rome to be crowned and to re-establish order in Italy. From Arras he sent ambassadors to Rome, and the pope after negotiation agreed to his coronation on the footing that the church should surrender all the possessions and royalties it had received of the empire and kingdom of Italy from the days of Charlemagne, while Henry on his side gave up the form of investiture. But on Henry's arrival in Rome (Feb. 1111), where feeling was strong against this pact, Paschal was slow to implement it, and the emperor ultimately found it necessary to withdraw from the city,—not, however, until he had compelled the pope and many of the cardinals to accompany him. After two months the pope yielded; the coronation took place in the church of St Peter on April 13, and forthwith the emperor withdrew beyond the Alps after exacting a promise that no revenge should be taken for what had passed. The Lateran council, however, held in March 1112, repudiated as void, under penalty of excommunication, the concessions that had been extorted by the violence of Henry; and a council held at Vienne some months afterwards actually excommunicated him, the pope himself ratifying the decree. On the death of the Countess Matilda of Tuscany, who had bequeathed her whole possessions to the church (1115), the emperor at once laid claim to them as imperial fiefs, and, descending into Italy, drove the pope first to Monte Casino and then to Benevento. Paschal returned to Rome, after the emperor's withdrawal, in the beginning of 1118, but died within a few days (January 21, 1118). His successor was Gelasius II.

**PASCHAL CONTROVERSY.** See **EASTER**, vol. vii. p. 614.

**PASCO.** See **CERRO DE PASCO**, vol. v. p. 347.

**PAS DE CALAIS**, a maritime department of northern France, formed in 1790 of nearly the whole of Artois and the northern maritime portion of Picardy, including the Boulonnais, Calaisis, Ardrésis, and the districts of Langle and Bredegarde, lies between 50° 2' and 51° N. lat. and 1° 35' and 3° 10' E. long., and is bounded N. by the Straits of Dover ("Pas de Calais"), E. by the department of Nord, S. by that of Somme, and W. by the English Channel. The distance from England is only 21 miles. Nord, which separates Pas de Calais from Belgium, is at one place only 3 miles wide, and from Arras (the chief

town) to Paris in a direct line is about 100 miles. Except in the neighbourhood of Boulogne, with its *côtes de fer* or "iron coasts," the seaboard of the department, which measures 65 miles, consists of dunes. From the mouth of the Aa (the limit towards Nord) it trends west-south-west to Gris Nez, the point of France nearest to England; in this section lie the port of Calais, Cape Blanc Nez, rising 440 feet above the sandy shores, and the port of Wisant (Wishant). Beyond Gris Nez the direction is due south; in this section are the port of Ambleteuse, Boulogne at the mouth of the Liane, and the two bays formed by the estuaries of the Canche and the Authie (the limit towards Somme). The highest point in the department (700 feet) is in the west, between Boulogne and St Omer. From the uplands in which it is situated the Lys and Scarpe flow east to the Scheldt, the Aa north to the German Ocean, and the Slack, Wimeroux, and Liane to the Channel. Farther south are the valleys of the Canche and the Authie, running from east-south-east to west-north-west, and thus parallel with the Somme. Vast plains, open and monotonous, but extremely fertile and well cultivated, occupy most of the department. The greenest and most picturesque valleys are in the west. To the north of the hills running between St Omer and Boulogne, to the south of Gravelines and the south-east of Calais, lies the district of the Watergardens, fens now drained by means of canals and dykes, and turned into highly productive land. The climate is free from extremes of heat and cold, but damp and changeable. At Arras the mean annual temperature is 47°; on the coast it is higher. The rainfall in the one case is 23 inches, in the other 31.

With a total area of 2550 square miles, the department has 1899 square miles (more than two-thirds) of arable land, while woods and pasture land each occupy only about a twentieth. The live stock in 1880 comprised 76,234 horses, 9642 asses or mules, 156,060 cows, 35,272 calves, 5080 bulls or oxen, 256,031 sheep, 131,723 pigs, 26,760 goats. The sheep in 1880 yielded 867 tons of wool, worth £57,398. The national sheepfolds of Tingry are in Pas de Calais. The 22,260 beehives of the department yielded in 1878 1758 tons of honey and 39½ tons of wax. No department except Somme breeds fowls so extensively. Wheat, beetroot, and oil seeds are the principal crops. In 1882 wheat gave 9,855,483 bushels, malting 920,023 bushels; in 1879, rye 781,150 bushels, barley 2,862,123 bushels, oats 2,421,818 bushels, beetroot 1,576,355 tons (almost entirely consumed by the sugar works), potatoes 7,250,813 bushels, vegetables 581,737, and colza seed 30,263. Besides there were considerable quantities of poppy-seed, flax (of excellent quality), hops, hemp, and tobacco (1575 tons). There are two great coal-fields, that of Pas de Calais proper, a continuation of the coal-field of Valenciennes and Hainault; and that of Boulonnais. The former contains a total area of 134,270 acres; the latter is about a tenth of that size. Taken together they number 73 pits, 57 of which are active. In 1882 5,036,455 tons of coal were extracted and 1,378,818 consumed in the department; the industry gives employment to 22,925 persons. Peat (to the amount of 375,034 tons in 1882) is obtained in the valleys of the Scarpe and the Aa. Iron-mines in the arrondissement of Boulogne employ 162 workmen (26,674 tons); the stone and marble quarries 2130 workmen; and about 800 are engaged in obtaining phosphates of lime (295,566 tons), which are exported for manure. Blast-furnaces, foundries, engineering works, zinceries, boiler-works, agricultural implement factories, and steel-works are all carried on in the department. In 1888 305 tons of iron, 16,355 tons of steel, 65,025 tons of cast iron were manufactured; and the average production of pens is 400,000,000 per annum. The establishments at Blache St Vaast melt, refine, and roll copper and zinc, and also work lead and auriferous silver. The shipyards do not launch any large vessels, but in 1881 they built eighty luggers or sloops, with an aggregate burden of 2456 tons. The eighty-nine sugar-works in 1880 produced 42,121 tons of sugar and 29,730 of molasses; the distilleries 4,658,984 gallons of spirits; the oil works 15 tons of hempseed oil, 389 tons of linseed oil, 2066 tons of poppyseed, rapeseed, and camelline oil, &c., and 797 tons of colza oil. There are 563 breweries in the department. Cotton-spinning and weaving employ 116,864 spindles and 625 looms; wool-spinning 24,300 spindles; and the flax, hemp, and jute manufacture 35,700 spindles and 497 looms. St Pierre-les-Calais carries on the weaving of tulles in linen, cotton, and silk, employing 10,000 hands, and producing with its 1506 looms goods to the value of £2,400,000 per annum. There are besides in the department establishments

for the manufacture of paper and cardboard, hosiery, embroidery, boots and shoes (for exportation), flooring, pipes, glass wares, chemical products, pottery, chicory, starch, biscuits (800 to 400 workmen), and gin. The national powder-mills of Esquerdes are among the largest in France. The port towns fit out a considerable number of vessels for the mackerel, cod, and herring fishing—a growing industry. In 1882 Boulogne and Stapes had 340 boats (13,919 tons) and 4586 fishermen, and Calais 37 boats (265 tons) and 281 fishermen, and their united take was 2356 tons. There is a large export of sugar, spirits, calves, sheep, and eggs to England. In 1882 the port of Boulogne had a movement of 3614 vessels and that of Calais 4436, with a total burden for the two ports of 3,212,920 tons. In 1878 404,769 travellers passed by this way between France and England. Calais is emphatically a transit port; Boulogne has besides an export trade in local products such as marble, freestone, minerals, and Boulogne horses, remarkable for size and strength. The roads of the department (national, departmental, &c.) make a length of 9393 miles, the waterways 105½ miles, the railways 546 miles, and the industrial railways 60 miles. The canal system comprises part of the Aa, the Lys, the Scarpe, the Deule (a tributary of the Lys passing by Lille), the Laws (a tributary of the Lys passing by Bethune), and the Seneze (an affluent of the Scheldt), as well as the various canals proper from Aire to La Bassée, Neufossé, Calais, &c., and in this way a line of communication is formed from the Scheldt to the sea by Bethune, St Omer, and Calais, with branches to Gravelines and Dunkirk in Nord. The total tonnage of the whole inland navigation was 2,124,442 tons in 1878.

In 1881 Pas de Calais had 819,022 inhabitants (311 per square mile), ranking sixth among the departments in density of population. It forms the diocese of Arras in the archbishopric of Cambrai, belongs to the district of the first (or Lille) corps d'armée, and is within the jurisdiction of the Douai court of appeal. There are six arrondissements bearing the names of their chief towns—Arras (27,041 inhabitants), Bethune (10,374), Boulogne (44,842), Montreuil (3352), St Omer (20,479), and St Pol (3694). Other places of importance are St Pierre-les-Calais (20,786 inhabitants), the industrial town of Calais (18,529), Lens (10,515), Lievin (8281), Carvin (6480)—the last three with important coal-mines, and Aire (5000), formerly a fortified place.

PASIPHAE. See MINOS.

PASKEWITCH, IVAN FEDOROWITZ (1782-1856), prince of Warsaw, and general-in-chief of the Russian army, was descended from an old and wealthy family, and was born at Poltava 8th May 1782. He was educated at the imperial institution for pages, where his progress was so rapid that after his first examination he received the promise of a lieutenant's commission in the guards, and was named aide-de-camp to the emperor. His first active service was in 1805, in the auxiliary army sent to the assistance of Austria against France, when he took part in the battle of Austerlitz. From 1807 to 1812 he was engaged in the campaigns against Turkey, and distinguished himself by many brilliant and daring exploits. During the French war of 1812-14 he was present, in command of the 26th division of infantry, at all the most important engagements; at the battle of Leipzig he took 4000 prisoners. On the outbreak of war with Persia in 1826 he was appointed second in command, and, succeeding in the following year to the chief command, gained rapid and brilliant successes which compelled the shah to sue for peace 19th February 1828. In reward of his services he was raised by the emperor to the rank of count of the empire, with the surname of Erivan, and received a million of roubles and a diamond-mounted sword. From Persia he was sent to Turkey in Asia, and, having captured in rapid succession the fortresses of Kara, Erzerum, and Akalkalaki, he was at the end of the campaign made a field marshal. In 1831 he was entrusted with the command of the army sent to suppress the revolt of Poland, and after the fall of Warsaw, which gave the death-blow to Polish independence, he was raised to the dignity of prince of Warsaw, and created viceroy of the kingdom of Poland. In this position he is said to have manifested the highest qualities as an administrator, and in his relations with the kings of Prussia and Austria he secured their confidence and esteem. On the outbreak of the insurrection of Hungary in 1848

he was appointed to the command of the Russian troops sent to the aid of Austria, and finally compelled the insurgents to lay down their arms at Vilagos. In April 1854 he again took the field in command of the army of the Danube, but on the 9th June, at Silistria, where he suffered defeat, he received a contusion which compelled him to retire from active service. He died 29th January 1856.

Tolstoy, *Essai Biographique et Historique sur le Feld-Marschal Prince de Varovie*, Paris, 1835; *Notices Biographiques sur le Marschal Paskevitch*, Leipsic, 185.

PASQUIER, ÉTIENNE (1529-1615), one of the glories of the French bar, and one of not the least remarkable men of letters of the 16th century, was born at Paris on the 7th June 1529 by his own account, according to others a year earlier. Nothing is known of his family, and hardly anything of his youth, but he seems to have inherited a small property at Châtelet in the district of Brie. He certainly studied law early, and in 1547 was a pupil of the famous Cujas at Toulouse. Thence, like many of his contemporaries, he went to finish his studies in Italy. He was called to the Paris bar in November 1549, having not yet (or at most barely) reached his majority. He practised diligently and with success, but by no means neglected literature. Some of his work both at this time and later is light and almost frivolous. A treatise on love, the *Monopside*, appeared in 1554, and not a few similar publications followed it, one of them, the *Ordonnances d'Amour*, being somewhat Rabelaisian in character. Pasquier, however, though not a stoic, was a man of perfectly regular life, and he married early; his wife, who was of his own age, affluent, and, it is said, handsome, being a widow for whom he had gained a lawsuit. The next year he had the misfortune to eat some poisonous mushrooms and very nearly died of them; indeed he did not recover fully for two years. This lost him his practice for the time, and he again betook himself to general literature, publishing in 1560 the first book of his great work the *Recherches de la France*. Before very long, however, clients once more came to him, and in 1565, when he was thirty-seven, his fame was established by a great speech still extant, in which he pleaded the cause of the university of Paris against the Jesuits, and won it. He was thenceforward constantly employed in the most important cases of the day, and his speeches, many of which we possess, displayed a polished eloquence which was new in his time. But he did not neglect general literature, pursuing the *Recherches* steadily, and publishing from time to time much miscellaneous work. His literary and his legal occupations coincided in a curious fashion at the Grands Jours of Poitiers in 1579. These Grand Jours (an institution which fell into desuetude at the end of the 17th century, with bad effects on the social and political welfare of the French provinces) were a kind of irregular assize in which a commission of the parlement of Paris, selected and despatched at short notice by the king, had full power to hear and determine all causes, especially those in which seigniorial rights had been abused. At the Grands Jours of Poitiers of the date mentioned, and at those of Troyes in 1583, Pasquier officiated; and each occasion has left a curious literary memorial of the kind of high jinks with which he and his colleagues relieved their graver duties. The Poitiers work was the celebrated collection of poems on a flea, of which English readers may find a full account in Southey's *Doctor*. Up to this time Pasquier had held no regular office except the lieutenant-generalship of Cognac, where his wife had property; but in 1535 Henry III. made him advocate-general at the Paris Cours des Comptes, an important body having political as well as financial and legal functions. Pasquier distinguished himself here



particularly by opposing, sometimes successfully, the mischievous system of selling hereditary places and offices, which more perhaps than any single thing was the curse of the older French monarchy. He was present at the famous States of Blois, where Guise was assassinated, and he met Montaigne there. The civil wars brought him much personal sorrow. His wife and children had remained in Paris much harassed by the Leaguers; Madame Pasquier was even imprisoned, and, though she regained her liberty, she died shortly afterwards, in 1590. Her youngest son was killed fighting on the royalist side the year before. For some years Pasquier lived at Tours, working steadily at his great book, but he returned to Paris in Henry IV.'s train on the 22d March 1594. He continued until 1604 at his work in the *Chambre des Comptes*; then he retired. He survived this retirement more than ten years, producing much literary work, and died after a few hours' illness on September 1, 1615, at the age of at least eighty-six.

In so long and so laborious a life Pasquier's work was naturally considerable, and it has never been fully collected or indeed printed. The standard edition is that of Amsterdam, 1723, 2 vols. folio. But for ordinary readers the selections of M. Léon Feugère, published at Paris in 2 vols. 8vo, 1849, with an elaborate introduction, are most accessible. As a poet, though very far from contemptible, Pasquier is chiefly interesting as a minor member of the *Pléiade* movement. As a prose writer he is of much more account. The three chief divisions of his prose work are his *Recherches*, his letters, and his professional speeches. All are of much value as important documents in the history of the progress of French style. The *Recherches* and the letters have a value independent of this. The letters are of much biographical interest and historical importance, and the *Recherches* contain in a somewhat miscellaneous fashion invaluable information on a vast variety of subjects, literary, political, antiquarian, and other.

PASQUINADE is a variety of libel or lampoon, of which it is not easy to give an exact definition, separating it from other kinds. It should, perhaps, more especially deal with public men and public things. The distinction, however, has been rarely observed in practice, and the chief interest in the word is in its curious and rather legendary origin. According to the received tradition, Pasquino was a tailor (others say a cobbler) who had a biting tongue, and lived in the 15th century at Rome. His name, at the end of that century or the beginning of the next, was transferred to a statue which had been dug up in a mutilated condition (some say near his shop) and was set up at the corner of the Palazzo Orsini (*al. Palazzo Braschi*). To this statue it became the custom to affix squibs on the papal Government and on prominent persons. At the beginning of the 16th century Pasquin had a partner provided for him in the shape of another statue found in the Campus Martius, said to represent a river god, and dubbed Marforio, *a foro Martia*. The regulation form of the pasquinade then became one of dialogue or rather question and answer, in which Marforio usually addressed leading inquiries to his friend. The proceeding soon attained a certain European notoriety, and a printed collection of the squibs due to it (they were long written in Latin verse, with an occasional excursion into Greek) appeared in 1510. In the first book of *Pantagruel* (1532 or thereabouts) Rabelais introduces books by Pasquillus and Marphurius in the catalogue of the library of St Victor, and later he quotes some utterances of Pasquin's in his letters to the bishop of Maillezaia. These, by the way, show that Pasquin was by no means always satirical, but dealt in grave advice and comment. The 16th century was indeed Pasquin's palmy time, and in not a few of the rare printed collections of his utterances Protestant polemic (which was pretty certainly not attempted on the actual statue) is mingled. These utterances were not only called pasquinades but simply pasquils (*Pasquillus, Pasquillo, Pasquille*), and this form was sometimes used for the mythical personage himself. Under this title a con-

siderable satirical literature of quite a different kind from the original personal squibs and political comments grew up in England at the end of the 16th and the beginning of the 17th century under the titles of *Pasquil's Apology, Pasquil's Nightcap*, &c. The chief writers were Thomas Nash and, after his death, Nicholas Breton. These pieces (of extreme rarity, but lately reissued by the Rev. A. B. Grosart, in private reprints of the works of their authors) were in prose. The French pasquils (examples of which may be found in Fournier's *Variétés Historiques et Littéraires*) were more usually in verse. In Italy itself Pasquin is said not to have condescended to the vernacular till the 18th century. During the first two hundred years of his career few mornings, if any, found him unplaced, and the institution supplied a kind of rough and scurrilous gazette of public opinion. But the proceeding gradually lost its actuality, and was, moreover, looked on with less and less favour by the authorities. Indeed a sentinel was latterly posted to prevent the placarding. It is said, however, that isolated pasquinades, having at least local appropriateness, occurred not many years ago. Marforio, it should be added, was soon removed from his companion's neighbourhood to the Capitol. Contemporary comic periodicals, especially in Italy, still occasionally use the Marforio-Pasquin dialogue form. But this survival is purely artificial and literary, and pasquinade has, as noted above, ceased to have any precise meaning.

PASSAU, an ancient town and episcopal see of Bavaria, lies in the district of Lower Bavaria, and occupies a highly picturesque situation at the confluence of the Danube, the Inn, and the Ilz, 90 miles to the north-east of Munich, and close to the Austrian frontier. It consists of the town proper, on the rocky tongue of land between the Danube and the Inn, and of the three suburbs of Innstadt, on the right bank of the Inn, Ilzstadt, on the left bank of the Ilz, and Anger, in the angle between the Ilz and the Danube. Passau is one of the most beautiful places on the Danube, a fine effect being produced by the way in which the houses are piled one above another on the heights rising from the river. The best general view is obtained from the Oberhaus, an old fortress now used as a prison, which crowns a hill 300 feet high on the left bank of the Danube. A detailed inspection of the buildings of the town, most of which date from the 17th and 18th centuries, scarcely fulfils the expectation aroused by their imposing appearance as a whole. The most noteworthy are the cathedral, a florid rococo structure on the site of an earlier church, which claims to have been founded in the 5th century; the post-office, in which the treaty of Passau was signed; the episcopal palace; the old Jesuit college, with a library of 30,000 volumes; the arsenal; the Romanesque church of the Holy Cross; and the double church of St Salvator. The old forts and bastions have been demolished, but the Niederhaus, at the base of the Oberhaus, is still extant, though no longer maintained as a fortress. The chief products of the insignificant industry of the town are tobacco, leather, and paper. It also possesses iron and copper foundries and a few barge-building yards. The well-known Passau crucibles are made at the neighbouring village of Oberzell. Trade is carried on in iron and timber, large quantities of the latter being floated down the Ilz. The inhabitants (15,365 in 1880) are nearly all Roman Catholics.

Passau is a town of very ancient origin. The first settlement here is believed to have been the Celtic *Boindurum*, on the site of the present Innstadt; and the Romans afterwards established a colony of Batavian veterans (*Castra Batava*) on the site of the town proper. The bishopric was founded in the 8th century, and most of the subsequent history of Passau is made up of broils between the bishops and the townsmen. The fortress of Oberhaus was erected by the former in consequence of a revolt in the 13th century, and at a later

period its guns were often turned on the town. In 1552 Charles V. and Elector Maurice of Saxony here signed the treaty of Passau, by which the former was constrained to acknowledge the principle of religious toleration. The town was a frequent object of dispute in the war of the Spanish succession, and it was taken by the Austrians in 1806. The bishopric was secularized in 1808, and its territory annexed to Bavaria two years later. The present bishopric was established in 1817.

PASSERAT, JEAN (1534–1602), a poet of merit and a contributor to the *Satire Ménippée*, was born at Paris in 1534. He was well educated, but is said to have played truant from school and to have had some curious adventures—at one time working in a mine. He was, however, a scholar by natural taste, and after a time he returned to his studies. Having finished them he became in his turn a teacher at the Collège de Plessis, and at the death of Ramus was made professor of Latin in the Collège de France. This, however, was not till 1572. In the meanwhile Passerat had studied law, and had composed much agreeable poetry in the *Pléiade* style, the best pieces being his short ode "On the First of May," and the charming *villanelle* "J'ai perdu ma tourterelle." Like most of the men of letters and learning at the time, Passerat belonged to the *politiques* or moderate royalist party, and was strongly opposed to the League. His exact share in the *Ménippée*, the great manifesto of the *politiques* party when it had declared itself for Henry of Navarre, is differently stated; but it is agreed that he wrote most of the verse, and the charming harangue of the guerilla chief Rienx is sometimes attributed to him. Towards the end of his life, after he had re-entered on the duties of his professorship, he became blind. He died at Paris in 1602, and his poems were not published completely till four years later. Passerat united with his learning abundant wit and a faculty of elegant and tender verse, and was altogether a good specimen of the man of letters of the time, free from pedantry while full of scholarship, and combining a healthy interest in politics and a taste for light literature with serious accomplishments. He had also a considerable reputation as an orator.

PASSIONFLOWER (*Passiflora*) is the typical genus of the order to which it gives its name. The species are mostly natives of western tropical South America; others are found in various tropical and subtropical districts of both hemispheres. The *tacsonias*, by some considered to form part of this genus, inhabit the Andes at considerable elevations. They are mostly climbing plants (fig. 1) having a woody stock and herbaceous or woody branches, from the sides of which tendrils are produced which enable the branches to support themselves at little expenditure of tissue. Some few form trees of considerable stature destitute of tendrils, and with broad magnolia-like leaves in place of the more or less palmately-lobed leaves which are most generally met with in the order. Whatever be the form of leaf, it is usually provided at the base of the leaf-stalk with stipules, which are inconspicuous, or large and leafy; and the stalk is also furnished with one or more glandular excrescences, as in some cases are the leaf itself and the bracts. The inflorescence is of a cymose character, the terminal branch being represented by the tendril, the side-branches by flower-stalks, or the inflorescence may be reduced to a single stalk. The bracts on the flower-stalk are either small and scattered or large and leafy, and then placed near the flower forming a sort of outer calyx or epicalyx. The flower itself (seen in section in fig. 2) consists of a calyx varying in form from that of a shallow saucer to that of a long cylindrical or trumpet-shaped tube, thin or fleshy in consistence, and giving off from its upper border the five sepals, the five petals (rarely these latter are absent), and the threads or membranous processes constituting the "corona." This coronet forms

the most conspicuous and beautiful part of the flower of many species, and consists of outgrowths from the tube formed subsequently to the other parts, and having little morphological significance, but being physiologically useful in favouring the cross-fertilization of the flower by means of insects. Other outgrowths of similar character, but less conspicuous, occur lower down the tube, and



FIG. 1.—*Passiflora curvipes*, var., showing leaf, stipule, tendril, and detached flower.

their variations afford useful means of discriminating between the species. From the base of the inner part of the tube of the flower, but quite free from it, uprises a cylindrical stalk surrounded below by a small cup-like out-

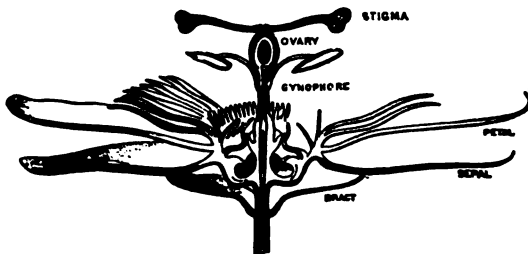

FIG. 2.—Flower of Passionflower cut through the centre to show the arrangement of its constituent parts.

growth, and bearing above the middle a ring of five flat filaments each attached by a thread-like point to an anther. Above the ring of stamens is the ovary itself, upraised on a prolongation of the same stalk which bears the filaments, or sessile. The stalk supporting the stamens and ovary is called the "gynophore" or the "gynandrophore," and is a special characteristic of the order, shared

in by the Capparids and no other order. The ovary of passionflowers is one-celled with three parietal placentas, and bears at the top three styles, each capped by a large berry-like stigma. The ovary ripens into a berry-like, very rarely capsular, fruit with the three groups of seeds arranged in lines along the walls, but embedded in a pulpy arillus derived from the stalk of the seed. This succulent berry is in some cases highly perfumed, and affords a delicate fruit for the dessert-table as in the case of the "granadilla," *P. quadrangularis*, *P. edulis*, *P. macrocarpa*, and various species of *Tacsonia* known as "crubas" in Spanish South America. The fruits in question do not usually exceed in size the dimensions of a hen's or of a swan's egg, but that of *P. macrocarpa* is a gourd-like oblong fruit attaining a weight of 7 to 8 lb. Many species are cultivated for the beauty of their flowers, and one or two species are nearly hardy in south and western Britain and Ireland, the commonest, *P. carulea*, being, singular to say, a native of southern Brazil. Many species of the *Tacsonia* would probably prove equally hardy. The name passionflower—*flos passionis*—arose from the supposed resemblance of the corona to the crown of thorns, and of the other parts of the flower to the nails, or wounds, while the five sepals and five petals were taken to symbolize the ten apostles,—Peter, who denied, and Judas, who betrayed, being left out of the reckoning. In some of the botanical books of the 16th and 17th centuries curious illustrations of these flowers are given, in which the artist's faith or imagination has been exercised at the expense of actual fact.

**PASSION PLAYS.** See **DRAMA**, vol. vii. p. 404. On the Oberammergau Passion Play, see **OSBERAMMERGAU**.

**PASSION WEEK**, the fifth week in Lent, begins with Passion Sunday (*Dominica Passionis* or *de Passione Domini*), so called from very early times because with it begins the more special commemoration of Christ's passion. In non-Catholic circles Passion Week is often identified with **HOLY WEEK** (*q. v.*), but incorrectly.

**PASSOVER AND FEAST OF UNLEAVENED BREAD.** It is explained in the article **PENTATEUCH** (p. 511) that the ancient Israelites were accustomed to open the harvest season by a religious feast. No one tasted the new grain, not even parched or fresh ears of corn, till the first sheaf had been presented to Jehovah, and then all hastened to enjoy the new blessings of divine goodness by eating unleavened cakes, without waiting for the tedious process of fermenting the dough. This natural usage became fixed in custom, and at a comparatively early date a new significance was added to it by a reference to the exodus from Egypt, when, as tradition ran, the people in their hasty departure had no time to leaven the dough already in their troughs. The two elements of a thankful recognition of God's goodness in the harvest, which every one was eager to taste the moment that Jehovah had received His tribute at the sanctuary, and of grateful remembrance of the first proof of His kingship over Israel, went very fittingly together. A similar combination is found in the thanksgiving of Deut. xxvi. 5 *sq.*, in the law, Deut. xxiv. 19–23, and elsewhere; the yearly blessings of the harvest were the proof of the continued goodness of Him who brought Israel forth from Egypt to set him in a fruitful and pleasant land.

The feast of unleavened bread (Hebrew **חמץ**, *maḥḥāh*), with the presentation of the harvest sheaf, which is its leading feature, presupposes agriculture and a fixed residence in Canaan. In the pastoral life the same religious feelings find their natural expression in thank-offerings for the increase of the flocks and herds, consisting of sacrifices "of the firstlings of the flock and the fatlings thereof," such as Gen. iv. 4 makes to date back from the very

beginnings of human history. The firstlings answer to the first fruits; the increase of cattle falls mainly in the spring; and spring is also the time of the best pasture in a climate where the harvest-tide lies between Easter and Whitsunday, the time therefore when a fat sacrifice can be selected and when vows would generally be fulfilled; especially as the latter, among the pastoral Hebrews as among the Arabs, would frequently have reference to the multiplication of the flock. Abel's sacrifice of firstlings and fatlings corresponds in fact exactly to the old Arabic *farā* and *attra*, the former of which was the firstborn of the herd and the latter a sacrifice offered in the spring month Rajab in fulfilment of a vow conditional on the good increase of the herd.<sup>1</sup> The accumulation of the sacrifices of firstlings and fatlings at one season of the year would readily give rise to a spring feast, and it appears from the Jehovahist that something of this kind existed before the exodus (see **PENTATEUCH**), and gave occasion to the request of Moses for leave to lead the people out into the wilderness to sacrifice to Jehovah. Pharaoh's refusal was appropriately punished by the destruction of the firstborn of man and the firstlings of beasts in Egypt. The recollection of this fact reacted on the old Hebrew usage, and supplied a new reason for the sacrifice of all male firstlings after the Israelites were settled in Canaan (Exod. xiii. 11 *sq.*). Up to the time of Deuteronomy this sacrifice was not tied to any set feast (contrast Exod. xxiii. 30 with Deut. xv. 20); the old sacrificial spring feast, like the Arabic feast of Rajab, was not wholly dependent on the firstlings, but might also be derived from vows. But when Israel was thoroughly united under the kings the tendency plainly lay towards a concentration of acts of cultus in public feasts at the great sanctuaries; and the final result of this tendency, which appears to some degree in earlier laws, but reached its goal only through the Deuteronomic centralization of all sacrifices at the one sanctuary, was that the spring pastoral feast coalesced with the agricultural *Maḥḥāh*, and that its sacrifices were swollen by the prohibition of continued private sacrifices of the male firstlings. This is the form of the Deuteronomic passover (Deut. xvi. 1 *sq.*). The passover is a sacrifice drawn from the flock or the herd, presented at the sanctuary and eaten with unleavened bread. It is slain on the evening of the first day of the feast, so that the sacrificial feast is nocturnal; and the pilgrims may return to their homes next morning, but the abstinence from leaven lasts seven days, and the seventh day, observed as a day of rest, is the *aseraḥ* or closing day of the feast. The passover is now viewed specially as a commemoration of the Exodus; and by and by, in Exod. xii. 27, its name (Heb. **פסח**, Gr. *πάσχα*, Lat. *pascha*) is explained from Jehovah "passing over" the Israelites when he smote Egypt. That this was the original meaning is by no means clear; there is no certain occurrence of the name before Deuteronomy (in Exod. xxxiv. 25 it looks like a gloss), and the corresponding verb denotes some kind of religious performance, apparently a dance, in 1 Kings xviii. 26. A nocturnal ceremony at the consecration of a feast is already alluded to in Isa. xxx. 29, who also perhaps alludes to the received derivation of **חמץ** in ch. xxxi. 5. But the Deuteronomic passover was a new thing in the days of Josiah (2 Kings xxiii. 21 *sq.*). It underwent a farther modification in the exile, when sacrifices in the proper sense of the word were impossible, but the commemorative side of the feast was perpetuated in the household meal of the paschal lamb, eaten with unleavened bread and bitter herbs (Exod. xii.—from the Priestly Code). The paschal lamb is quite different from the paschal

<sup>1</sup> Zdzien on Hārith's *Moth.*, l. 69; Bokhart, vl. 207 (Bulak vocalized edition).

sacrifices of Deuteronomy and from the ancient firstlings. In Deuteronomy, for example, the sacrifices may be either from the flock or from the herd, and are boiled, not roasted (A. V. in Deut. xvi. 7 mistranslates); the paschal lamb is necessarily roasted, and the only traces of sacrificial character that remain to it are the sprinkling of the blood on the lintel and door-posts,<sup>1</sup> and the burning of what is not eaten of it. After the restoration the passover seems to have retained its domestic character, for, though the feast at the sanctuary was renewed, its public features now consisted of a series of holocausts and sin-offerings continued for seven days (Num. xxix. 16 sq.). The feast is now exactly dated.<sup>2</sup> The paschal lamb is chosen on the tenth day of the first month (Abib or Nisan) and slain on the evening of the fourteenth. Next day—that is, the fifteenth—is now the first day of the feast proper (a change from the Deuteronomic ordinance naturally flowing from the fact that the properly paschal ceremony is now not festal but domestic), so that the seven days end with the twenty first and close with a “holy assembly” at Jerusalem. The old ceremony of presenting the first sheaf had been fixed, in Lev. xxiii. 11, for the “morrow after the Sabbath.” This naturally means that the solemn opening of harvest was to take place on a Sunday. But when the feast was fixed to set days of the month the “Sabbath” was taken to mean the first day of the feast or of unleavened bread (Nisan 15), and the sheaf was presented on the sixteenth.<sup>3</sup> As the feast was now again a great pilgrimage occasion, there was a natural tendency to restore to the paschal lamb a more strictly sacrificial character. This tendency does not appear as yet in the Pentateuch, where the latest provisions are those put in historical form in Exod. xii.; but in 2 Chron. xxxv., which must be taken as describing the practice of the author’s own time, the paschal lamb is slain before the temple, the blood is sprinkled and the fat burned (1 verse 14) on the altar; and at the same time we find the Deuteronomic paschal sacrifices existing side by side with the paschal lamb of the later law as subsidiary sacrifices. The later Jewish usage followed this practice; the Deuteronomic sacrifices in their new subsidiary form constituted the so-called *ḥagiga*. The pre-eminent importance which the passover (with the feast of unleavened bread) acquired after the exile, from the fact that its rites, like those of the Sabbath and of circumcision, could be in great part adapted to the circumstances of the dispersion, was still further increased by the fall of the second temple, and the ritual of the Mishna (*Peṣāḥim*) was supplemented by the later paschal Haggada. The lamb, however, not being slain at the temple, is not in later praxis regarded as strictly the paschal lamb of the law. Some of the post-Biblical features are of interest in connexion with the New Testament, and especially with the last supper. The company for a single lamb varied from ten to twenty; the bitter herbs and unleavened cakes were dipped in a kind of sweet sauce called *haroseeth*; and the meal was accompanied by the circulation of four cups of wine and by songs of praise, particularly the Hallel (Ps. cxiii.—cxviii.).

The history of the passover is one of the most complicated subjects in Hebrew archeology, and has been a great battlefield of Pentateuch criticism. The present article should therefore be read with the article PENTATEUCH. The older books on Hebrew archeology are of little use, except for the later Jewish practice;

<sup>1</sup> The sprinkling of blood on a tent in order to put it under divine protection appears also among the Arabs; Wáikidí, ed. Kræmer, p. 28.

<sup>2</sup> In everything that has to do with sacrifice a day means the day-time with the following night; in other words, the feast days do not begin in the evening. Compare Reland, *Ant. Heb.*, iv. § 15.

<sup>3</sup> This exegesis and practice are as old as the LXX. version of Leviticus. The passage of Leviticus has given rise to much controversy; see the commentaries and Lightfoot’s *Notes* on Luke vi. 1, Acts ii. 1.

on this fall details will be found in Bartolucci’s *Bibliotheca Rabbinica*, or in Bodeuschatz’s *Kirchliche Verfassung der Juden*. The Biblical data can only be understood in connexion with a critical view of the Pentateuch, and have been discussed in this connexion by Kuenen (*Geschiedenis*), Wellhausen (*Prolegomena*), and others. The present position of those who oppose the Grafian hypothesis may be gathered from Delitzsch’s art. “Passah” in Riehm’s *Handwörterbuch*, and from Dillmann’s commentary on Exodus and Leviticus. Hupfeld, *De vera et primitiva Fœderum . . . ratione*, 1852–56, and Ewald’s *Antiquities*, may also be consulted. (W. B. S.)

**PASSPORT.** A passport or safe conduct in time of war is a document granted by a belligerent power to protect persons and property from the operation of hostilities. In the case of the ship of a neutral power, the passport is a requisition by the Government of the neutral state to suffer the vessel to pass freely with her crew, cargo, passengers, &c., without molestation by the belligerents. The requisition, when issued by the civil authorities of the port from which the vessel is fitted out, is called a sea-letter. But the terms passport and sea-letter are often used indiscriminately. A form of sea-letter (*litteræ salvi conductus*) is appended to the treaty of the Pyrenees, 1659. The passport is frequently mentioned in treaties, e.g., the treaty of Copenhagen, 1670, between Great Britain and Denmark. The violation of a passport, or safe conduct, is a grave breach of international law. The offence in the United States is punishable by fine and imprisonment where the passport or safe conduct is granted under the authority of the United States (Act of Congress, April 30, 1790). In time of peace a passport is still necessary for foreigners travelling in certain countries, and is always useful, even when not necessary, as a ready means of proving identity. It is usually granted by the foreign office of a state, or by its diplomatic agents abroad. Passports granted in England are subject to a stamp duty of sixpence. They may be granted to naturalized as well as natural-born British subjects. Sweden was the first country to abolish passports in time of peace, and Russia is one of the last to retain them. They are demandable from foreigners in England on their arrival from abroad by 6 & 7 Will. IV. c. 11, § 3; but this provision is not enforced in practice.

**PASTE, or STRASS.** See GLASS, vol. x. p. 665.

**PASTON LETTERS.** This invaluable collection of documents consists of the correspondence of the principal members of the Paston family in Norfolk between the years 1424 and 1506, including several state papers and other documents accidentally in their possession. The papers appear to have been sold by William Paston, second earl of Yarmouth, the last representative of the family, to the antiquary Le Neve early in the 18th century. After Le Neve’s death in 1729 they came into the hands of Mr Thomas Martin of Palgrave, who had married his widow, and upon Martin’s death in or about 1771 were purchased by Worth, a chemist at Diss, from whose executors they were subsequently bought by Mr (afterwards Sir) John Fenn. In 1787 Fenn published two volumes of selections from the MSS., whose extreme value was at once recognized by Horace Walpole and other competent judges. In acknowledgment of his services Fenn received the honour of knighthood, and on this occasion, May 23, 1787, presented to the king three bound volumes of MSS. containing the originals of the documents printed by him. Most unfortunately these volumes have disappeared, and the originals of two more subsequently published by Sir John Fenn, and of a fifth edited after his death by Mr Serjeant Frere, were also lost until very recently. Under these circumstances it is not surprising that doubts should have been raised as to the authenticity of the papers. Their genuineness was impugned by Mr Herman Merivale in No. 8 of the *Fortnightly Review*, but

satisfactorily vindicated on grounds of internal evidence by Mr James Gairdner of the Record Office in No. 11 of the same periodical. Within a year Mr Gairdner's position was established by the discovery (1865) of the originals of the fifth volume at Mr Serjeant Frere's house at Dungate, Cambridgeshire. In 1875 the original MSS. of the third and fourth, with many additional letters, were found at the family mansion of the Freres at Roydon Hall, near Diss. The MSS. presented to the king have not been found, and were probably appropriated by some person about the court. In 1872-75 Mr Gairdner published a most careful and accurate edition in three volumes in Arber's English reprints, accompanied with valuable introductions to each volume, including an historical survey of the reign of Henry VI., notes, and index, and incorporating more than four hundred additional letters derived from Magdalen College, Oxford, and other quarters. Abstracts of some of the additional letters discovered at Roydon were added in an appendix. The total number of documents printed wholly or in abstract is one thousand and six.

A thousand family letters of the 15th century must in any case be full of interest; the Paston letters are peculiarly interesting from the importance and in some respects the representative character of the family. The founder was Clement Paston, a humble peasant living at the end of the 14th century, who threw in the world and gave his son William the sound education which enabled him to rise to the position of justice of the common pleas. Judge Paston acquired much landed property in Norfolk, and in the days of his son John, in 1459, the family was greatly enriched by a bequest from the stout old soldier but grasping usurer Sir John Fastolf, a kinsman of Sir John Paston's wife. The Pastons, however, were even at that time greatly harassed by rival claimants to their estates; and Sir John's legacy involved them in a fresh set of troubles and contentions, which were not allayed until the time of the third Sir John Paston, about 1480. This perturbed state of affairs imparts especial interest to the correspondence, causing it to reflect the general condition of England during the period. It was a time of trouble, when the weakness of the Government had disorganized the administration in every branch, when the succession to the crown itself was contested, when great nobles lived in a condition of civil war, when the prevalent anarchy and discontent found expression in tumultuary insurrections like Cade's, countenanced, as the Paston letters show, by persons of condition, when any man's property might be assailed with or without colour of law by covetous rivals, and upstart families like the Pastons were especially exposed to attack. The correspondence therefore exhibits them in a great variety of relations to their neighbours, friendly or hostile, and abounds with illustrations of the course of public events, as well as of the manners and morals of the time. Nothing is more remarkable than the habitual acquaintance of educated people with the law, which was evidently indispensable to a person of substance. In its broader aspects the correspondence exhibits human nature much as it is now, except for the notable deficiency in public spirit, and the absence of large views or worthy interests in life. The contrast with our own times is instructive, showing how largely commerce and literature, art and travel, have contributed to augment moral and intellectual as well as material wealth. After the death of the second Sir John Paston, grandson of the judge, in 1479, the letters become scanty and of merely personal interest. The family continued to flourish. In the next century it produced Clement Paston, a distinguished naval commander under Henry VIII.; and in the days of Charles II. Sir Robert Paston was raised to the peerage as earl of Yarmouth. His son dissipated

the hereditary property, and the title and the family became extinct upon his death in 1732. (R. G.)

PASTORAL is the name given to a certain class of modern literature in which the "idyl" of the Greeks and the "eclogue" of the Latins are imitated. It was a growth of humanism at the Renaissance, and its first home was Italy. Virgil had been imitated, even in the Middle Ages, but it was the example of *THEOCRITUS* (q.v.) that was originally followed in pastoral. Pastoral, as it appeared in Tuscany in the 16th century, was really a developed eclogue, an idyl which had been expanded from a single scene into a drama. The first dramatic pastoral which is known to exist is the *Favola di Orfeo* of Politian, which was represented at Mantua in 1472. This poem, which has been elegantly translated by Mr J. A. Symonds, was a tragedy, with choral passages, on an idyllic theme, and is perhaps too grave in tone to be considered as a pure piece of pastoral. It led the way more directly to tragedy than to pastoral, and it is the *Il Saggiato* of Agostino Beccari, which was played at the court of Ferrara in 1554, that is always quoted as the first complete and actual dramatic pastoral in European literature.

In the west of Europe there were various efforts made in the direction of non-dramatic pastoral, which it is hard to classify. Early in the 16th century Alexander Barclay, in England, translated the Latin eclogues of Mantuanus, a scholastic writer of the preceding age. Barnabe Googe, a generation later, in 1563, published his *Eglogs, Epytaphes, and Sonnettes*, a deliberate but not very successful attempt to introduce pastoral into English literature. In France it is difficult to deny the title of pastoral to various productions of the poets of the Pliade, but especially to Rémy Belleau's pretty miscellany of prose and verse in praise of a country life, called *La Bergerie* (1565). But the final impulse was given to non-dramatic pastoral by the publication, in 1504, of the famous *Arcadia* of G. Sannazaro, a work which passed through sixty editions before the close of the 16th century, and which was abundantly copied. Torquato Tasso followed Beccari after an interval of twenty years, and by the success of his *Aminta*, which was performed before the court of Ferrara in 1573, secured the popularity of dramatic pastoral. Most of the existing works in this class may be traced back to the influence either of the *Arcadia* or of the *Aminta*. Tasso was immediately succeeded by Alvisio Pasqualigo, who gave a comic turn to pastoral drama, and by Cristoforo Castelletti, in whose hands it grew heroic and romantic, while, finally, Guarini produced in 1590 his famous *Pastor Fido*, and Ongaro his fishermen's pastoral of *Aleo*. During the last quarter of the 16th century pastoral drama was really a power in Italy. Some of the best poetry of the age was written in this form, to be acted privately on the stages of the little court theatres that were everywhere springing up. In a short time music was introduced, and rapidly predominated, until the little forms of tragedy, and pastoral altogether, were merged in opera.

With the reign of Elizabeth a certain tendency to pastoral was introduced in England. In Gascoigne and in Whetstone traces have been observed of a tendency towards the form and spirit of eclogue. It has been conjectured that this tendency, combined with the study of the few extant eclogues of Clément Marot, led Spenser to the composition of what is the finest example of pastoral in the English language, the *Shepherd's Calendar*, printed in 1579. This famous work is divided into twelve eclogues, and is remarkable because of the constancy with which Spenser turns in it from the artificial Latin style of pastoral then popular in Italy, and takes his inspiration direct from Theocritus. It is important to note that this is the first effort made in European litera-

ture to bring upon a pastoral stage the actual rustics of a modern country, using their own peasant dialect. That Spenser's attempt was very imperfectly carried out does not militate against the genuineness of the effort, which the very adoption of such names as Willie and Cuddie, instead of the customary Damon and Daphnia, is enough to prove. Having led up to this work, the influence of which was to be confined to England, we return to Sannazaro's *Arcadia*, which left its mark upon every literature in Europe. This remarkable romance, which was the type and the original of so many succeeding pastorals, is written in rich but not laborious periods of musical prose, into which are inserted at frequent intervals passages of verse, contests between shepherds on the "humile fistula di Coridone," or laments for the death of some beautiful virgin. The characters move in a world of supernatural and brilliant beings; they commune without surprise with "i gloriosi spirti degli boschi," and reflect with singular completeness their author's longing for an innocent voluptuous existence, with no hell or heaven in the background.

It was in Spain that the influence of the *Arcadia* made itself most rapidly felt outside Italy. Gil Vicente, who was also a Portuguese writer, had written Spanish religious pastorals early in the 16th century. But Garcilaso de la Vega is the founder of Spanish pastoral. His first eclogue, *El dulce lamentar de los pastores*, is considered one of the finest poems of its kind in ancient or in modern literature. He wrote little and died early, in 1536. Two Portuguese poets followed him, and composed pastorals in Spanish, Francisco de Sá de Miranda, who imitated Theocritus, and the famous Jorge de Montemayor, whose *Diana* (1524) was founded on Sannazaro's *Arcadia*. Gaspar Gil Polo, after the death of Montemayor in 1561, completed his romance, and published in 1564 a *Diana enamorada*. It will be recollected that both these works are mentioned with respect, in their kind, by Cervantes. The author of *Don Quixote* himself published an admirable pastoral romance, *Galeata*, in 1584. The rise of the taste for picaresque literature in Spain towards the close of the 16th century was fatal to the writers of pastoral. In Portugal it can hardly be said that this form of literature has ever existed, although Camoens published idyls.

In France there has always been so strong a tendency towards a graceful sort of bucolic literature that it is hard to decide what should and what should not be mentioned here. The charming *pastourelles* of the 13th century, with their knight on horseback and shepherdess by the roadside, need not detain us further than to hint that when the influence of Italian pastoral began to be felt in France these earlier lyrics gave it a national inclination. We have mentioned the *Bergerie* of Rémy Belleau, in which the art of Sannazaro seems to join hands with the simple sweetness of the mediæval *pastourelle*. But there was nothing in France that could compare with the school of Spanish pastoral writers which we have just noticed. Even the typical French pastoral, the *Astrée* of Honoré d'Urfé (1610), has almost more connexion with the knightly romances which Cervantes laughed at than with the pastorals which he praised. D'Urfé had been preceded by Nicolas de Montreux, whose *Bergerie de Juliette* are just worthy of mention. The famous *Astrée* was the result of the study of Tasso's *Aminta* on the one hand and Montemayor's *Diana* on the other, with a strong flavouring of the romantic spirit of the *Amadis*. To remedy the pagan tendency of the *Astrée* a priest, Camus de Pontcarré, wrote a series of Christian pastorals. Of the romances which followed in the wake of the *Astrée*, and in which the pastoral element was gradually reduced to a minimum, a succinct but admirable account is given in Mr Saintsbury's

*Short History of French Literature*. The main authors in this style were Mademoiselle de Scudéry, La Calprenède, and Gomberville. Racon produced in 1625 a pastoral drama, *Les Bergeries*, founded on the *Astrée* of D'Urfé.

In England the movement in favour of Theocritean simplicity which had been introduced by Spenser in the *Shepherd's Calendar* was immediately defeated by the success of Sir Philip Sidney's *Arcadia*, a romance closely modelled on the masterpiece of Sannazaro. So far from attempting to sink to colloquial idiom, and adopt a realism in rustic dialect, the tenor of Sidney's narrative is even more grave and stately than it is conceivable that the conversation of the most serious nobles can have ever been. In these two remarkable books, then, we have two great contemporaries and friends, the leading men of letters of their generation, trying their earliest fights in the region of pastoral, and producing typical masterpieces in each of the two great branches of that species of poetry. Henceforward, in England, pastoral took one or other of these forms. It very shortly appeared, however, that the Sannazarean form was more suited to the temper of the age, even in England, than the Theocritean. In 1583 a great impetus was given to the former by Robert Greene, who was composing his *Morando*, and still more in 1584 by the publication of two pastoral dramas, the *Gallathea* of Lyly and the *Arraignement of Paris* of Peela. It is doubtful whether either of these writers knew anything about the *Arcadia* of Sidney, which was posthumously published, but Greene, at all events, became more and more imbued with the Italian spirit of pastoral. His *Menaphon* and his *Never too Late* are pure bucolic romances. While in the general form of his stories, however, he follows Sidney, the verse which he introduces is often, especially in the *Menaphon*, extremely rustic and colloquial. In 1589 Lodge appended some eclogues to his *Scilla's Metamorphosis*, but in his *Rosalynde* (1590) he made a much more important contribution to English literature in general, and to Arcadian poetry in particular. This beautiful and fantastic book is modelled more exactly upon the masterpiece of Sannazaro than any other in our language. The other works of Lodge scarcely come under the head of pastoral, although his *Phyllis* in 1593 included some pastoral sonnets, and his *Margarite of America* (1596) is modelled in form upon the *Arcadia*. The *Sire Idyllia* of 1588, paraphrases of Theocritus, are anonymous, but conjecture has attributed them to Sir Edward Dyer. In 1598 Bartholomew Young published an English version of the *Diana* of Montemayor.

In 1585 Watson published his collection of Latin elegiacal eclogues, entitled *Amyntas*, which was translated into English by Abraham Fraunce in 1587. Watson is also the author of two frigid pastorals, *Melibæus* (1590) and *Amyntus Gaudia* (1592). John Dickenson printed at a date unstated, but probably not later than 1592, a "passionate eclogue" called *The Shepherd's Complaint*, which begins with a harsh burst of hexameters, but which soon settles down into a harmonious prose story, with lyrical interludes. In 1594 the same writer published the romance of *Arisbas*. Drayton is the next pastoral poet in date of publication. His *Idea: Shepherd's Garland* bears the date 1593, but was probably written much earlier. In 1595 the same poet produced an *Endimion and Phæbe*, which was the least happy of his works. He then turned his fluent pen to the other branches of poetic literature; but after more than thirty years, at the very close of his life, he returned to this early love, and published in 1627 two pastorals, *The Quest of Cynthia* and *The Shepherd's Sirena*. The general character of all these pieces is rich, but vague and unimpassioned. The *Queen's Arcadia* of Daniel must be allowed to lie open to the same



charge, and to have been written rather in accordance with a fashion, than in following of the author's predominant impulse. It may be added that the extremely bucolic title of Warner's first work, *Pan: his Syrinx*, is misleading. These prose stories have nothing pastoral about them. The singular eclogue by Barnfield, *The Affectionate Shepherd*, printed in 1594, is an exercise on the theme "O crudelis Alexi, nihil mea carmina curas," and, in spite of its juvenility and indiscretion, takes rank as the first really poetical following of Spenser and Virgil, in distinction to Sidney and Sannazaro. Marlowe's pastoral lyric *Come live with Me*, although not printed until 1599, has been attributed to 1589. In 1600 was printed the anonymous pastoral comedy in rhyme, *The Maid's Metamorphosis*, long attributed to Lyly.

With the close of the 16th century pastoral literature was not extinguished in England as suddenly or as completely as it was in Italy and Spain. Throughout the romantic Jacobean age the English love of country life asserted itself under the guise of pastoral sentiment, and the influence of Tasso and Guarini was felt in England just when it had ceased to be active in Italy. In England it became the fashion to publish lyrical eclogues, usually in short measure, a class of poetry peculiar to the nation and to that age. The lighter staves of *The Shepherd's Calendar* were the model after which all these graceful productions were drawn. We must confine ourselves to a brief enumeration of the principal among these Jacobean eclogues. Nicholas Breton came first with his *Passionate Shepherd* in 1604. Wither followed with *The Shepherd's Hunting* in 1615, and Braithwaite, an inferior writer, published *The Poet's Willow* in 1613 and *Shepherd's Tales* in 1621. The mention of Wither must recall to our minds that of his friend William Browne, who published in 1613-16 his beautiful collection of Devonshire idyls called *Britannia's Pastorals*. These were in heroic verse, and less distinctly Spenserian in character than those eclogues recently mentioned. In 1614 Browne, Wither, Christopher Brook, and Davies of Hereford united in the composition of a little volume of pastorals entitled *The Shepherd's Pipe*. Meanwhile the composition of pastoral dramas was not entirely discontinued. In 1606 Day dramatized part of Sidney's *Arcadia* in his *Isle of Gulls*, and about 1625 the Rev. Thomas Goffe composed his *Careless Shepherdess*, which Ben Jonson deigned to imitate in the opening lines of his *Sad Shepherd*. In 1610 Fletcher produced his *Faithful Shepherdess* in emulation of the *Aminta* of Tasso. This is the principal pastoral play in our language, and, in spite of its faults in moral taste, it preserves a fascination which has evaporated from most of its fellows. The *Arcades* of Milton is scarcely dramatic; but it is a bucolic ode of great stateliness and beauty. In the *Sad Shepherd*, which was perhaps written about 1635, and in his pastoral masques, we see Ben Jonson not disdain to follow along the track that Fletcher had pointed out in the *Faithful Shepherdess*. With the *Picatory Eclogues* of Phineas Fletcher, in 1633, we may take leave of the more studied forms of pastoral in England early in the 17th century.

When pastoral had declined in all the other nations of Europe, it enjoyed a curious recrudescence in Holland. More than a century after date, the *Arcadia* of Sannazaro began to exercise an influence on Dutch literature. Johan van Heemskirk led the way with his popular *Batavische Arcadia* in 1637. In this curious romance the shepherds and shepherdesses move to and fro between Katwijk and the Hague, in a landscape unaffectedly Dutch. Heemskirk had a troop of imitators. Hendrik Zoeteboom published his *Zaanlandische Arcadia* in 1658, and Lambertus Bos his *Dordtsche Arcadia* in 1662. These local imitations of the naive Italian pastoral were followed by still more crude

romances, the *Rotterdamse Arcadia* of Willem den Elger, the *Walcherse Arcadia* of Gargon, and the *Noordwijker Arcadia* of Jacobus van der Valk. Germany has nothing to offer us of this class, for the *Diana* of Werder (1644) and *Die adriatische Rosamund* of Zesen (1645) are scarcely pastorals even in form.

In England the writing of eclogues of the sub-Spenserian class of Breton and Wither led in another generation to a rich growth of lyrics which may be roughly called pastoral, but are not strictly bucolic. Carew, Lovelace, Suckling, Stanley, and Cartwright are lyricists who all contributed to this harvest of country-song, but by far the most copious and the most characteristic of the pastoral lyricists is Herrick. He has, perhaps, no rival in modern literature in this particular direction. His command of his resources, his deep originality and observation, his power of concentrating his genius on the details of rural beauty, his interest in recording homely facts of country life, combined with his extraordinary gift of song to place him in the very first rank among pastoral writers; and it is noticeable that in Herrick's hands, for the first time, the pastoral became a real and modern, instead of being an ideal and humanistic thing. From him we date the recognition in poetry of the humble beauty that lies about our doors. His genius and influence were almost instantly obscured by the Restoration. During the final decline of the Jacobean drama a certain number of pastorals were still produced. Of these the only ones which deserve mention are three dramatic adaptations, Shirley's *Arcadia* (1640), Fanshawe's *Pastor Fido* (1646), and Leonard Willan's *Astræa* (1651). The last pastoral drama in the 17th century was Settle's *Pastor Fido* (1677). The Restoration was extremely unfavourable to this species of literature. Sir Charles Sedley, Aphra Behn, and Congreve published eclogues, and the *Pastoral Dialogue between Thirsis and Strephon* of the first-mentioned was much admired. All of these, however, are in the highest degree insipid and unreal, and partook of the extreme artificiality of the age.

Pastoral came into fashion again early in the 18th century. The controversy in the *Guardian*, the famous critique on Ambrose Philips's *Pastorals*, the anger and rivalry of Pope, and the doubt which must always exist as to Steele's share in the mystification, give 1708 a considerable importance in the annals of bucolic writing. Pope had written his idyls first, and it was a source of infinite annoyance to him that Philips contrived to precede him in publication. He succeeded in throwing ridicule on Philips, however, and his own pastorals were greatly admired. Yet there was some nature in Philips, and, though Pope is more elegant and faultless, he is not one whit more genuinely bucolic than his rival. A far better writer of pastoral than either is Gay, whose *Shepherd's Week* was a serious attempt to throw to the winds the ridiculous Arcadian tradition of nymphs and swains, and to copy Theocritus in his simplicity. Gay was far more successful in executing this pleasing and natural cycle of poems than in writing his pastoral tragedy of *Dione* or his "tragi-comic pastoral farce" of *The What d'ye call it* (1715). He deserves a very high place in the history of English pastoral on the score of his *Shepherd's Week*. Swift proposed to Gay that he should write a Newgate pastoral in which the swains and nymphs should talk and warble in slang. This Gay never did attempt; but a northern admirer of his and Pope's achieved a veritable and lasting success in Lowland Scotch, a dialect then considered no less beneath the dignity of verse. Allan Ramsay's *Gentle Shepherd*, published in 1725, was the last, and remains the most vertebrate and interesting, bucolic drama produced in Great Britain. The literary value of this play has been exaggerated, but it is a very clever and natural essay, and

the best proof of its success as a painting of bucolic life is that it is still a favourite, after a hundred and fifty years, among lowland reapers and milkmaids.

With the *Gentle Shepherd* the chronicle of pastoral in England practically closes. This is at least the last performance which can be described as a developed eclogue of the school of Tasso and Guarini. It is in Switzerland that we find the next important revival of pastoral properly so-called. The taste of the 18th century was very agreeably tickled by the religious idyls of Salomon Gessner, who died in 1787. His *Daphnis und Phillis* and *Der Tod Abels* were read and imitated throughout Europe. In German literature they left but little mark, but in France they were cleverly copied by Arnaud Berquin. A much more important pastoral writer is Jean Pierre Clovis de Florian, who began by imitating the *Galatea* of Cervantes, and continued with an original bucolic romance entitled *Estelle*. His eclogues had a great popularity, but it was said that they would be perfect if only there were sometimes wolves in the sheepfolds. The tone of Florian, as a matter of fact, is tame to fatuity. Neither in France nor in Germany did the shepherds and shepherdesses enjoy any considerable vogue. It has always been noticeable that pastoral is a form of literature which disappears before a breath of ridicule. Neither Gessner nor his follower Abbt were able to survive the laughter of Herder. Since Florian and Gessner there has been no reappearance of bucolic literature properly so-called. The whole spirit of romanticism was fatal to pastoral. Voss in his *Luise* and Goethe in *Hermann und Dorothea* replaced it by poetic scenes from homely and simple life.

Half a century later something like pastoral reappeared in a totally new form, in the fashion for *Dorfgeschichten*. About 1830 the Danish poet S. S. Blicher, whose work connects the grim studies of our own Crabbe with the milder modern strain of pastoral, began to publish his studies of out-door romance among the poor in Jutland. Immermann followed in Germany with his novel *Der Oberhof* in 1839. Auerbach, who has given to the 19th-century idyl its peculiar character, began to publish his *Schwarzwälder Dorfgeschichten* in 1843. Meanwhile George Sand was writing *Jeanne* in 1844, which was followed by *La Mare au Diable* and *François le Champi*, and in England Clough produced in 1848 his remarkable long-vacation pastoral *The Boatie of Tober-na-Vuolich*. It seems almost certain that these writers followed a simultaneous but independent impulse in this curious return to bucolic life, in which, however, in every case, the old tiresome conventionality and affectation of lady-like airs and graces were entirely dropped. This school of writers was presently enriched in Norway by Björnson, whose *Synnöve Solbakken* was the first of an exquisite series of pastoral romances. But perhaps the best of all modern pastoral romances is Frits Reuter's *Ut mine Stromtid*, written in the Mecklenburg dialect of German. In England the Dorsetshire poems of Mr Barnes and the Dorsetshire novels of Mr Hardy belong to the same class, which has finally been augmented by the appearance of Mr Munby's remarkable idyl *Dorothy*. It will be noticed of course that all these recent productions have so much in common with the literature which is produced around them that they almost evade separate classification. It is conceivable that some poet, in following the antiquarian tendency of the age, may enshrine his fancy once more in the five acts of a pure pastoral drama of the school of Tasso and Fletcher, but any great vitality in pastoral is hardly to be looked for in the future. (z. w. o.)

PASTORAL EPISTLES, the name given to three epistles of the New Testament which bear the name of St Paul, and of which two are addressed to Timothy and one to Titus. The reason of their being grouped together

is that they are marked off from the other Pauline epistles by certain common characteristics of language and subject-matter; and the reason of their special name is that they consist almost exclusively of admonitions for the pastoral administration of Christian communities. None of the Pauline epistles have given greater ground for discussion, partly on account of the nature of their contents, partly on account of their philological peculiarities, and partly on account of their historical difficulties.

1. *Contents*.—The Pastoral Epistles are chiefly distinguished from the other Pauline epistles by the prominence which they give to doctrine. From an objective point of view Christian teaching is "the word" (2 Tim. iv. 2), or "the word of God" (2 Tim. ii. 9), or "the doctrine of God our Saviour" (Tit. ii. 10), or "the truth" (1 Tim. iii. 15, 2 Tim. ii. 18; iv. 4; Tit. i. 14), or "the faith" (1 Tim. iv. 1). From the point of view of the individual it is "the knowledge of the truth" (2 Tim. ii. 25; iii. 7); and Christians are those who "believe and know the truth" (1 Tim. iv. 3). It had existed long enough to have become perverted, and hence a stress is laid upon "sound" doctrine<sup>1</sup> (1 Tim. i. 10; 2 Tim. iv. 3; Tit. i. 9; ii. 1; in the plural, "sound words," 1 Tim. vi. 3; 2 Tim. i. 13). It had also tended to become dissociated from right conduct; hence a stress is laid upon a "pure conscience" (1 Tim. i. 19; iii. 8), and the end which it endeavours to attain is "love out of a pure heart, and out of a good conscience, and out of unfeigned faith" (1 Tim. i. 5). Consequently the "things that befit the sound doctrine" are moral attributes and duties (Tit. ii. 1 sq.), and the things that are "contrary to the sound doctrine" (1 Tim. i. 10) are moral vices. This combination of sound doctrine and right conduct is "piety" (*εὐσέβεια*, 1 Tim. ii. 2; iii. 16; iv. 7, 8; vi. 5, 6, 11; 2 Tim. iii. 4) or "godliness" (*θεοσεβεία*, 1 Tim. ii. 10); and sound doctrine is, in other words, "the doctrine," or "the truth, that is in harmony with piety" (1 Tim. vi. 3; Tit. i. 1). This doctrine or truth is regarded as a sacred deposit in the hands of the church or community (1 Tim. vi. 20; 2 Tim. i. 14), and is therefore a "common faith" (Tit. i. 4), of which the church is the "pillar and stay" (1 Tim. iii. 15). Its substance appears to be given in 1 Tim. iii. 16, which has been regarded, not without reason, as a rudimentary form of creed, and possibly part of a liturgical hymn. But the church is no longer identical with "them that are being saved" or "the elect"; it is compared to "a great house" which contains vessels "some unto honour, and some unto dishonour" (2 Tim. ii. 20). It is in other words no longer an ideal community, the "Israel of God" (Gal. vi. 16), but a visible society. And, being such, its organization had come to be of more importance than before. But the nature of the organization to which these epistles point is an unsolved problem. The solution of that problem is attended by the preliminary question, which in the absence of collateral evidence cannot be definitely answered, of the relation in which Timothy and Titus are conceived to stand to the other or ordinary officers. According to a tradition mentioned by Eusebius, but for which he gives no definite authority, Timothy was "bishop" of Ephesus and Titus of Crete; according to others their position was rather that of the later "metropolitans"; and some modern writers, accepting one or other of these views, take it as part of the proof that the epistles belong to a period of the 2d century in which the monarchical idea of the episcopate was struggling to assert itself. On the

<sup>1</sup> Most commentators have omitted to note that the word rendered "sound" is a common expression of some of the later Greek philosophers, denoting simply "true," e.g., Epictet., *Dissert.*, i. 11, 28; ii. 15, 2.

other hand, it appears from the epistles themselves that the positions of Timothy and Titus were temporary rather than permanent, and that they were special delegates rather than ordinary officers (1 Tim. iii. 14, 15; iv. 13; Tit. iii. 12). For the ordinary officers the qualifications are almost all moral, and they are so similar to each other, and to the moral qualifications of all Christians, as to imply that the sharp distinctions of later times between one grade of office and another, and between the officers and the other members of the communities, were not yet developed (1 Tim. iii. 2-12; Tit. i. 6-9, possibly also ii. 2-6). The most probable solution of the difficulties which present themselves in relation to the apparent interchange of the names "bishop" and "elder," and to the apparent double use of the word "elder," sometimes as a title and sometimes as a designation of age, is that in these epistles there is an imperfect amalgamation of two forms of organization, Jewish and Gentile: in the former the distinction between the governing and the governed classes was mainly that of age, and the functions of the governing class were mainly those of discipline; in the latter the distinction was mainly that of functions, and the functions were mainly those of administration. (1) The distinction between elder and younger appears in regard to both men and women (1 Tim. v. 1, 2; Tit. ii. 2-6). Out of the elder men some appear to have been chosen or appointed to preside (of *πρεσβύτερος*, 1 Tim. v. 17; a cognate form of the designation is found in Rom. xii. 8, 1 Thess. v. 12, and constitutes almost the only link of connexion between the organization of these and that of the other Pauline epistles), and to have constituted a collective body or "presbytery" (1 Tim. iv. 14, the word was in use to designate the Jewish councils of elders, for which the more common word was *γερουσία*). Their functions, like those of the corresponding officers in the Jewish communities, were probably for the most part disciplinary; to these some of them added the function of teaching (1 Tim. v. 17). The elder women also were charged with disciplinary functions; they had to "train the young women to love their husbands, to love their children, to be sober-minded" (Tit. ii. 3, 4). Out of such of them as were widows some were specially entered on the roll of church-officers (*καρδολογος*), and formed a class which, though it did not long survive the growth of monasticism, is mentioned in almost all early documents which refer to ecclesiastical order (see Smith and Cheetham, *Dict. of Chris. Antiq.*, s.v. "Widows"). Whether the younger men and women, or a selected number of them had, as such, corresponding duties is not clear, but an inference in favour of the supposition may be drawn from a comparison of 1 Tim. v. 1, 2, 13, Acts v. 6, 10. (2) Side by side with this, and sometimes, but not always, blended with it, was the organization which was probably adopted from the contemporary civil societies, especially those in which, as in the Christian communities, there were funds to be administered; the presiding elders, or some of them, were also "bishops" or administrators, and some of the younger men were "deacons" or servants. A bishop was "God's steward" (Tit. i. 7); a deacon was the active helper of the bishops in both administration and discipline.

2. *Language.*—These epistles are distinguished from the other Pauline epistles by many peculiarities of language, of which only a few can be mentioned here. (1) In 1 Timothy there are seventy-four words which are not elsewhere in the New Testament; in 2 Timothy there are forty-six such words, and in Titus forty-eight. In the three epistles taken together there are one hundred and thirty-three words which are not found in the other Pauline epistles, though they are found elsewhere in the New Testament; and many of the most marked and

frequent expressions of St Paul are absent. (2) There is a tendency which is not found elsewhere in the Pauline epistles to form unusual compounds, e.g., *λογωμαχικόν, ἐπεροδιδασκαλεῖν, ἐγγηλοφρονεῖν, ἀντοκατάκριτος*. (3) Words are used for which the other Pauline epistles invariably substitute a different, though nearly synonymous, word; e.g., *θεσπότης* is used for *κύριος, κτίσμα* for *κτίσις*. (4) The particles, which are even better tests of identity of style than nouns and verbs, are different: the Pauline *γάρ* is rare; *ἄρα, ἄρα οὖν, ἐτι, μήπως, πάλιν, ὥστε*, are absent. (5) "In the other Pauline epistles the fulness of the apostle's thought struggles with the expression, and causes peculiar difficulties in exposition. The thoughts slide into one another, and are so intertwined in many forms that not seldom the new thought begins before a correct expression has been given to the thought that preceded. Of this confusion there is no example in the Pastoral Epistles" (Huther, *Introduction*, Eng. tr., p. 10). A complete account of the linguistic peculiarities of these epistles will be found in Holtmann, pp. 84-117.

3. *Historical Difficulties.*—The historical difficulties to which these epistles give rise are of two kinds:—(1) that of finding a place for them in any period of the recorded life of St Paul, and (2) that of determining the state of theological opinion to which they are relative.

(1) In regard to the first kind of difficulties, each of the three epistles has its own problems.

The data of the historical position of 1 Timothy appear to be (a) that St Paul had gone into Macedonia, (b) that he had left Timothy at Ephesus (i. 3). The chief hypotheses which have been framed to satisfy the conditions which these data imply are the following. (1) The majority of older writers suppose that St Paul left Timothy at Ephesus when he went into Macedonia after the émeute in the theatre (Acts xx. 1). The difficulties in the way of this hypothesis are that Timothy had been sent into Macedonia (Acts xix. 22), and probably at the same time to Corinth (1 Cor. iv. 17), that he had not returned when St Paul himself reached Macedonia, inasmuch as St Paul waited for him there (1 Cor. xvi. 11), that the two were together in Macedonia when 2 Corinthians was written (2 Cor. i. 1), and that they returned together to Asia Minor (Acts xx. 4). Some of these difficulties have been met by the conjecture that Timothy never reached Corinth, but returned to St Paul at Ephesus and rejoined him in Macedonia; but the conjecture implies that Timothy disobeyed the apostle's exhortation to tarry at Ephesus almost as soon as he had received it, and that the apostle, so far from "hoping to come unto him shortly" (1 Tim. iii. 14), was in reality intending to go to Jerusalem and to Rome (Acts xix. 21), not even calling at Ephesus on his way (Acts xx. 17). (2) It has been supposed that there was an unrecorded journey of St Paul into Macedonia during his long stay in Ephesus (Acts xix. 1-20; so Mosheim, Schrader, Wieseler, and Reus, the last of whom makes the journey extend to Crete and Illyricum). There is little difficulty in the supposition of such a journey into Macedonia, but there is great difficulty in supposing that the epistle was written in the course of it,—first, because its language is not compatible with the idea that Timothy was merely left in temporary charge during a short absence of the apostle, and, secondly, because the epistle implies the existence of an organized community which had existed long enough to have had errors growing up in it (whereas in Acts xx. 29-30 the coming of heretical teachers is regarded as still future), and in which it was possible that a bishop should be "not a novice" (1 Tim. iii. 6). (3) It has been supposed that St Paul wrote the epistle during his imprisonment at Caesarea or at Jerusalem; but this does not

avoid the difficulty which is fatal to the two preceding hypotheses, that Timothy had been left at Ephesus when the apostle was "going into Macedonia." (4) In order to avoid this fatal difficulty some writers (especially Otto, *Die geschichtlichen Verhältnisse der Pastoralbriefe*, Leipzig, 1860, and Kölling, *Der erste Brief Pauli an Timotheus*, Berlin, 1882) have attempted a new but impossible translation of 1 Tim. i. 3, so as to make it appear that it was Timothy and not Paul that was going into Macedonia (for criticisms of this attempt see Huther's edition of Meyer's commentary *ad loc.*, and Weiss in the *Studien u. Kritiken* for 1861, p. 577).

The data of the historical position of 2 Timothy appear to be (a) that St Paul either was or had been in Rome (i. 17), (b) that he was in prison (i. 16; ii. 9), (c) that he had already had a trial (iv. 16), (d) that he believed himself to be near the end of his life (iv. 6), (e) that he was expecting shortly to see Timothy (i. 4; iv. 9, 21), (f) that he had been, apparently not long before, at Troas, Corinth, and Miletus (iv. 13, 20). Upon these data two hypotheses have been framed. (1) It has been supposed that the required historical position is to be found at the beginning of the "two whole years" of Acts xxviii. 30, and that consequently the epistle was written before those to the Philippians and Colossians (so, among others, Schrader, Otto, and Reuss). The difficulties in the way of this hypothesis are chiefly two,—first, that of accounting for the complete change of tone between the close anticipation of death of 2 Tim. iv. 6 and the hopefulness of Philippians ii. 23, 24, Philemon 22, and, secondly, that of accounting for the "first defence" of 2 Tim. iii. 16; this Otto does by supposing it to be the process before Festus at Cæsarea, a supposition which implies the very improbable further supposition that the process before Felix was not what was technically known as an "actio," and that the term "make my defence" (Acts xxiv. 10) was wrongly applied by St Paul himself to his own speech. (2) It has been supposed that the required position is to be found in the period immediately succeeding the "two whole years" of Acts xxviii. 30, and that the epistle was written after those to the Philippians and Colossians (so, among others, Wieseler). One of the main difficulties in the way of this hypothesis is that it implies an interval of at least four years since the journey referred to in chap. iv., and that it is incredible that St Paul should have written to a disciple in Asia Minor to mention the casual incidents of a voyage—such as the leaving a cloak at Troas and a companion sick at Miletus—which had occurred several years before; the difficulty would not be much lessened even if the ingenious conjectures were adopted by which Wieseler endeavours to identify this voyage with that of Acts xxvii.

The data of the historical position of the epistle to Titus are (a) that Paul and Titus had been in Crete together, and that Titus had been left there, (b) that Paul was intending to winter at Nicopolis (wherever that may be, places of that name being found in several Roman provinces). Upon these data many conjectures have been built. It has been supposed that St Paul visited Crete either (1) at the commencement of this second missionary journey (Acts xv. 41), or (2) during his residence at Corinth (Acts xviii. 1, 8; so Michaelis and Thiersch). Each of these conjectures is met, in addition to other difficulties, by the fact, which seems fatal to it, that Apollos, who is mentioned in Titus iii. 13, was not known to Paul and his company until after the second missionary journey (Acts xviii. 24). (3) The same fact is also fatal to the supposition of Hug and others that the visit to Crete took place during the journey from Corinth to Ephesus (Acts xviii. 18, 19), a supposition which is also inconsistent with the apostle's apparent desire to reach Syria without much

delay, and which requires for its support the further supposition that, although on his way to Antioch and Cæsarea, he had selected the almost unknown town of Nicopolis in Cilicia to winter in. (4) It has been supposed (Credner) that the visit to Crete was made as a detour in the course of the journey from Antioch to Ephesus (Acts xviii. 22, 23; xix. 1); this is not only improbable in itself but also inconsistent with the summary of that journey: "Paul, having passed through the upper," i.e., the inland, "country, came to Ephesus." (5) It has been supposed that St Paul called at Crete in the course of a journey which he probably made to Corinth during his long sojourn at Ephesus (so Wieseler, who thinks that he went first to Macedonia, 1 Tim. i. 3, and thence to Corinth, Crete, and back to Ephesus; and Reuss, who thinks that the route was Ephesus, Crete, Corinth, Illyricum, Macedonia, Ephesus); but this supposition seems to be excluded by the inconsistency between the expressed intention to winter in Nicopolis (Tit. iii. 12) and the similar intention to pass the same winter at Corinth (1 Cor. xvi. 6), unless the ingenious hypothesis of Wieseler be adopted that he intended to spend part of the winter in one place and the rest in the other. (6) It has been supposed that he made his journey from Macedonia to Greece (Acts xx. 1-3) by way of Crete (so Matthies); but this supposition seems to be excluded by the fact that in 2 Cor. viii. 6, 17 (which was written from Macedonia), Titus who had been with Paul in Macedonia had gone forward on his own account not to Crete but to Corinth. And all these endeavours to find a place for the epistle in St Paul's life before his voyage to Rome are met by the improbability that, if Crete had been already so far Christianized as to have communities in several cities (which is implied in Tit. i. 5), there should be no hint of the fact in Acts xxvii. 7-13.

The difficulties of all endeavours to find a place for these epistles in the recorded history of St Paul have been so strongly felt by most of these modern writers who support their authenticity that such writers have generally transferred them to an unrecorded period of his life, subsequent to the close of the Acts of the Apostles. The external authorities for the belief that there was such a period, and that in the course of it St Paul underwent a second imprisonment, are chiefly the statement of Clement of Rome that he went to "the goal of the West," and that of the Muratorian fragment that he went to Spain (see PAUL, *infra*, p. 422). Both these statements admit of much dispute, the one as to its meaning, the other as to its authority; and their value as evidence is weakened by the fact that Irenæus, Tertullian, and Origen, though they mention the death of the apostle at Rome, say nothing of any journeys subsequent to his arrival there. In the 4th century Eusebius, for the first time, mentions a second imprisonment, but prefixes to his statement the ambiguous words λόγος ἔχει, "there is a story" or "tradition holds." Several fathers subsequent to his time repeat and amplify his statement; but that statement, if accepted, involves the further difficulties on the one hand of finding room for St Paul's journeys before the great Neronian persecution of 64 A.D., and on the other hand of accounting for the fact that, supposing the apostle to have survived that persecution, he makes no mention of it. For all these difficulties more or less plausible answers have been framed, and many narratives of St Paul's unrecorded travels have been written; but, although it may be admitted that such narratives are conceivably true, yet it must be conceded on the other hand that they rest rather upon conjecture than upon evidence. It may be added that the hypothesis of a second imprisonment is rejected not only by writers like Baur and Hilgenfeld, who deny the authenticity of

both the Pastoral Epistles and the other "Epistles of the Captivity," but also by conservative writers, such as Meyer, Ebrard, Otto, Wieseler, Thiersch, and De Pressensé.

(2) The second kind of historical difficulties, that of determining the state of theological opinion to which these epistles are relative, arises partly from the incidental nature of the references to false teachers in the epistles themselves and partly from the fragmentary character of our knowledge of contemporary teaching. The characteristics of the false teachers are mainly the following. (i.) They once held "sound doctrine" but have now fallen away from it (1 Tim. i. 6, 19; vi. 5, 21; 2 Tim. ii. 18); and, puffed up with self-conceit (1 Tim. vi. 4) and claiming to have a special "knowledge" (*γνώσις*, vi. 20; implied also in Tit. i. 16), they oppose the truth (Tit. i. 9; 2 Tim. ii. 25; iii. 8) and teach a different doctrine (1 Tim. i. 3); yet they remain within the church and cause factions within it (Tit. iii. 10). (ii.) They profess asceticism, "forbidding to marry and commanding to abstain from meats," apparently on the ground that some "creatures of God" are evil (1 Tim. iv. 3), and at the same time their moral practice is perverted, they are "unto every good work reprobate" (1 Tim. vi. 5; 2 Tim. iii. 13; Tit. i. 16), and they make their teaching of religion a means of gain (1 Tim. vi. 5; Tit. i. 11). (iii.) Their teaching is concerned with "fables and endless genealogies" (1 Tim. i. 4; Tit. i. 14), with questionings and disputes of words (1 Tim. vi. 4), with empty sounds and contradictions (1 Tim. vi. 20), with "profane and old wives' fables" (1 Tim. iv. 7), with "foolish questionings and genealogies, and strifes and fightings about the law" (Tit. iii. 9), and they held that the "resurrection is past already" (2 Tim. ii. 18). It has been sometimes held that these statements refer rather to errors of practice than errors of doctrine, and rather to tendencies than to matured systems (Reuss); and it has also been sometimes held that different forms of opinion are referred to in either different epistles or different parts of the same epistle (Credner, Thiersch, Hilgenfeld); but the majority of writers think that the reference is to a single definite form of error. The main question upon which opinions are divided is whether the basis of this false teaching was Judaistic or Gnostic, i.e., whether that teaching was a rationalizing form of Judaism or a Judaizing form of Gnosticism. (1) The former of these views branches out into many forms, and is held on various grounds. It is sometimes held that the reference is to the allegorizing and rationalizing school of which Philo is the chief representative, and which was endeavouring to take root in Christian soil, the "fables" being the allegorical interpretations of historical facts, the "genealogies" those of the Pentateuch, or possibly the Pentateuch itself, which served as the basis of philosophical speculations (Wiesinger, Hofmann). It is sometimes held that the reference is to what in later times was known as the Kabbalah, the assumption being made that the Kabbalah must be dated many centuries earlier than other testimony warrants us in believing (so Vitringa, Grotius, Schöttgen, and more recently Olshausen and Baumgarten). It is sometimes held that the false teachers were not so much theosophic as thaumaturgic, allied to the Judeo-Samaritan school of which Simon Magus is the typical representative, and that this is the point of the reference to Jannes and Jambres and to "jugglers . . . deceiving and being deceived" (2 Tim. iii. 8, 13). It is sometimes supposed that they combined Essenism with a form of Ebionism, and this view (the ablest supporter of which is Mangold, *Die Irrlehrer der Pastoralbriefe*, 1856) is that which now prevails among those who contend for the early date of the epistles, if not for their authenticity. (2) It is contended on the other hand that none of these theories quite

cover the facts. It is maintained that genealogies did not take the place in the Jewish speculative schools which they evidently had in the false teaching to which these epistles refer; that even if they had done so it is difficult to account for the epithet "endless" which is applied to them; that there is no sufficient proof that the Essenes held a dualistic theory of the relation of spirit to matter, or that they denied the resurrection (the testimony of Hippolytus on this point being more probable than that of Josephus), or that they taught for gain, or that they prosecuted a propaganda among women (2 Tim. iii. 6). It is further contended that all these points are generally characteristic of Gnosticism. The use of the epithet "falsely so called," it is urged, shows that "knowledge" (*γνώσις*) is used in a technical sense; in the "endless genealogies" writers so early as Irenæus and Tertullian recognized Gnostic systems of æons, to which the phrase seems exactly to apply; the abstinence from meats and from marriage belongs not to any form of Judaism but to Gnostic theories of the nature of matter; the description of the teachers as making a gain of their teaching and as "taking captive silly women laden with sins" suits no one so well as the half-converted rhetoricians who brought into Christian communities the practices as well as the beliefs of the degenerate philosophical schools of the empire. It is probable that this view is substantially correct; at the same time it may be granted that the evidence is too scanty to allow of the identification of the Gnostics to which reference is made with any particular Gnostic sect, and that the several attempts which have been made so to identify them have failed.

The result of this combination of difficulties—the differences between the pastoral epistles and the other Pauline epistles in respect of the character of their contents, their philological peculiarities, the difficulty of reconciling the historical references with what is known from other sources of the life of St Paul, the difficulty of finding any known form of belief which precisely answers to the opinions which they attack, and the further difficulty of believing that so elaborate a debasement of Christianity had grown up in the brief interval between St Paul's first contact with Hellenism and his death—has been to make the majority of modern critics question or deny their authenticity. The first important attacks were that of Schleiermacher, who, however, only rejected 1 Timothy, and a few years afterwards that of Eichhorn, who rejected all three; but the modern criticism of them practically begins with Baur's treatise *Die sogenannten Pastoralbriefe des Apostels Paulus* in 1835. Since then the controversy has been keenly waged on both sides; the history of it will be found in Holtmann, *Die Pastoralbriefe* (Leipzig, 1880), which is by far the ablest work on the negative side of the controversy, and which, whether its conclusions be accepted or not, is more full of accurate information than any other. The most available works on the conservative side, for English readers, are the translation of Huther's edition of Meyer's *Commentary* (Edinburgh, 1881); Dr Wace's introduction to the Pastoral Epistles in the *Speaker's Commentary* (London, 1881); and Archdeacon Farrar's excursus on "The Genuineness of the Pastoral Epistles" in his *St Paul* (vol. ii. p. 607). (Z. H.A.)

PASTORAL LETTER, a letter addressed, in his pastoral capacity, by a bishop to his clergy, or the laity of his diocese, or both. In the Church of Rome it is usual for every bishop to issue at least one pastoral annually, the Lenten Mandates or Instructions, containing exhortations relating to that fast, and enumerating the dispensations granted and devotions prescribed. Others are issued in connexion with the principal solemnities of the church, or as occasion arises.

† PATAGONIA, in the widest application of the name, is that portion of South America which, to the east of the Andes, lies south of Rio Negro (mouth in 41° 5' S. lat.), and, to the west of the Andes, south of the Chilian province of Chiloe,<sup>1</sup> with a total area of 322,550 square miles (306,475 continental, 16,075 insular) according to Dr E. Wisotzki's measurement (Behm and Wagner, *Bevölkerung der Erde*, 1880). By the treaty of 22d October 1881 this vast region was divided between Chili and the Argentine Republic, the boundary being the unexplored watershed of the Andes down to 52° S. lat., and then continuing along the parallel to 70° W. long., thence to Point Dungeness, and so southwards (through Tierra del Fuego) along the meridian of 68° 34' W. long.<sup>2</sup> In this way about 62,930 of the 322,550 square miles fall to Chili and 259,620 to the Argentine Republic.<sup>3</sup>

The Chilian portion, the main bulk of which is comprised under the title of Magellan Territory (*Territorio Magallanes*), is chiefly remarkable for the way in which the combined action of glacier and sea has cut up the country into a multitude of rugged and irregular islands and peninsulas, separated by intricate channels and fjords. South of Chiloe, the first great island of the Chilian coast, the islands are grouped under the name of the Chonos Archipelago, which is bounded on the south by the spacious Gulf of Peñas. The Chonos Islands (upwards of 1000 in number, without counting mere islets and rocks) are without exception mountainous, and in some cases the summits remain white throughout the year, though in the lowlands snow lies only a few days. The general temperature is remarkably even. A thick covering of vegetation (low and stunted on the seaward parts) is spread over nearly all the surface, but the layer of vegetable soil is very thin. Potatoes grow wild, and cabbage, onions, radish, &c. are cultivated. The sea-elephant appears to be exterminated; seals still abound. On Taytao peninsula is found the pudu, the smallest known deer. The old Indian inhabitants—Chonos—are practically extinct, though their sitting mummies give name to Momias Bay, and they still occupy some of the islands far south near Magellan's Strait. There are only one or two permanent settlements in the whole archipelago—on the Guaitecas Islands (43° 52' S. lat.) and at Puerto Americano or Tangbac (45° S. lat.). Woodcutters, however, visit the islands in considerable numbers for the sake of their valuable timber, mainly ciprés (*Libocedrus tetragona*). Besides Magdalena—which is by far the largest of the whole group and contains the extinct volcano of Motalat, 5400 feet high—it is enough to mention Chaffers, Forsyth, Johnson, Tahuenahuec, Narborough (named after the old English explorer), Stokes, Benjamin, James, Melchor, Victoria, Luz, and Rivero Islands. The broad Moraleda Channel, from 75 to 175 fathoms deep, which may be said to separate the rest of the archipelago from Magdalena and the mainland, is continued south by the Costa and Elefantas Channels, and would have proved of great service to navigation had it not been that the southern exit is barred by the narrow isthmus of Ofqui, which alone prevents the strangely formed Taytao peninsula from being an island. The glacier of San Rafael, which discharges into the lagoon of the same name on the north side of the isthmus, is nearer the equator than any other coast-glacier in the world.<sup>4</sup>

South of the Gulf of Peñas a navigable channel exists between the mainland and the long succession of islands which, under the names of Wellington Island (150 miles long), Madre de Dios Archipelago, Hanover Island, and Queen Adelaide Archipelago, extend for about 400 miles to the mouth of Magellan's Strait; and it is now regularly used by steamers, which are thus protected from the terrible western storms that make the deep-sea passage along this coast so dangerous. At one or two points only is the navigation difficult—at the English Narrows in Messier Channel (as the northern division is called), and at the Guia Narrows farther south. The scenery throughout is of the most beautiful and picturesque description. Among the serviceable inlets are Connor Cove, Port Grappler, Puerto Bueno (pointed out by Sarmiento), and Isthmus Harbour.<sup>5</sup>

The southern coast of Patagonia is bounded for 365 miles by Magellan's Strait,<sup>6</sup> which separates the mainland from the countless islands of the Tierra del Fuego archipelago and breaks it up into a number of very irregular peninsulas. Of these the largest are King William IV. Land and Brunswick Peninsula, and between them lies the extensive inlet of Otway Water, which is further connected westward by Fitzroy Channel with Skyring Water. On the east coast of Brunswick Peninsula, opposite the Broad Reach of the strait, and in the finest part of the straitward district, lies the Chilian military post and penal settlement of Punta Arenas or Sandy Point. It was founded in 1851 as a substitute for the unfortunate Port Famine settlement, which lay farther south on the same coast. In spite of convict mutinies (as in 1878) and the questionable character of many of the settlers (chiefly Chilotes), Punta Arenas begins to flourish; in 1875 its population was 915, and since that date a series of "factories" or cattle-stations have been established along the coast to north and south. The country behind the settlement, unlike the districts at either end of the strait, is well wooded, mainly with Chilian beech (*Fagus antarctica*) and Winter's bark (*Drimys Winteri*, so called after Captain Winter, Drake's companion), and considerable quantities of timber are exported. Coal also, though of inferior quality, is worked in the neighbourhood.<sup>7</sup>

Patagonia east of the Andes is for the most part a region of vast steppe-like plains. Unlike the pampas of the Argentine Republic, with which it is conterminous on the north, it rises in a succession of abrupt steps or terraces about 300 feet at a time, and is covered, not with soft stoneless soil, but with an enormous bed of shingle, which instead of luxuriant grass supports, where it is not absolutely bare, only a thin clothing of coarse and often thorny brushwood and herbage. So peculiar is this, the largest tract of shingle in the world, that from D'Orbigny downwards geologists have generally characterized it simply as the Patagonian formation. It is of Tertiary marine origin; but, whilst Bove makes it correspond to the Miocene subdivision, Doering (Roca's expedition) assigns it to the somewhat older Oligocene. Beneath the shingle, which is sometimes at least 200 feet thick, and has its pebbles whitewashed and cemented together by an aluminous substance, there stretches a vast deposit, sometimes more than 800 feet thick, of a soft infusorial stone resembling chalk. In the hollows of the plain as far south as

<sup>1</sup> Chiloe is sometimes considered part of Patagonia.

<sup>2</sup> Of the Tierra del Fuego archipelago 20,341 square miles are Chilian and 7890 Argentine.

<sup>3</sup> Documents in regard to the disputed possession will be found in Quesada, *La Patagonia y las Tierras Australes*, Buenos Ayres, 1875. By a treaty in 1856 the *uti possidetis* of 1810 was accepted.

<sup>4</sup> The Chonos Archipelago was explored by H. Simpson of the Chilian navy in 1871-72. See map and text in *Petermann's Mittheil.*, 1878.

<sup>5</sup> See Lieut. Eardley-Wilmot, *Our Journal in the Pacific*, 1873, especially the appendix; and *The Voyages of the "Adventure" and the "Beagle."*

<sup>6</sup> Magellan's Strait was first named, probably by its discoverer, *Canal de Todos los Santos*, and in older writers often appears as *Estracho Patagonico* and *Estracho de la nave Victoria* (Magellan's ship).

<sup>7</sup> Punta Arenas was a German station for the observation of the transit of Venus in 1882.



Santa Cruz there are frequently lakes or ponds; they are generally impregnated with common salt, Epsom salts, or some other mineral ingredient, the substance varying from lake to lake without any regularity of distribution (see Burmeister, *La República Argentina*, vol. ii. (1876) appendix). Certain limited tracts with finer soil and richer vegetation occur, especially in the river-valleys, but the general aspect of the plains is one of sterility and desolation.

The most ordinary bushes are the jume (*Salicornia*) and the calafate (*Berberis buxifolia*); the ashes of the former contain 41 per cent. of soda, and the latter makes excellent fuel and bears a pleasant bluish-purple berry known to the older English explorers as Magellan's grape. Among the perennial herbs may be named *Strongyloma struthium*, Chuquiragua, Adesmia, Azorella. The palm-tree mentioned by many travellers as growing on the south coast is really a kind of fern, *Lomaria boryana*.<sup>1</sup>

The guanaco, the puma, the zorro or *Canis Azara* (a kind of fox), the zorrino or *Mephitis patagonica* (a kind of skunk), and the tucú-tucú or *Ctenomys magellanicus* (a kind of rodent) are the most characteristic mammals of the Patagonian plains. Vast herds of the guanaco roam over the country, and form with the ostrich (*Rhea americana*, and more rarely *Rhea Darwinii*) the chief means of subsistence for the native tribes, who hunt them on horseback with dogs and bolas.

Bird-life is often wonderfully abundant. The carrancha or carrion-bawk (*Polyborus Thorus*) is one of the characteristic objects of a Patagonian landscape; the presence of long-tailed green parrots (*Cyaneris cyanolytus*) as far south as the shores of the strait attracted the attention of the earlier navigators; and humming-birds may be seen flying amidst the falling snow. Of the many kinds of water-fowl it is enough to mention the flamingo, the upland goose, and in the strait the remarkable steamer duck.

As the Andes are approached, a great change is observed in the whole condition of the country. The shingle is replaced by porphyry and granite and vast masses of basalt and lava; vegetation becomes luxuriant, majestic trees—evergreen beeches, alerces, ciprés, araucarias, &c.—combined with jungle-like underwood clothing the ravines and hillsides; and, with the richer plant life, animal life grows more abundant and varied, deer, peccaries, wild cattle, and wild horses<sup>2</sup> finding fitting pasture. The fruit trees planted by the Jesuits in the neighbourhood of Lake Nahuel-Huapi have spread into vast natural orchards, which furnish the local tribes of Araucanians with food and wine, and have given rise to the designation Manzaneros or apple-folk by which they are distinguished.

Eastern Patagonia is traversed from west to east by a considerable number of rivers, but few if any can ever be of much use as highways. In their passage seawards they are joined by comparatively few tributaries from the low country; rain falls seldom, and the water sinks away among the shingle and sand. The Rio Negro, which separates the pampas from Patagonia proper, is formed by the junction of the Neuquen and the Limay. The former collects by numerous channels the drainage of the Andes between 36° 25' and 38° 40'; the latter has its main source in the great Nahuel-Huapi Lake, which was discovered in 1690 by Mascardi the Jesuit (whose station on the lake was maintained till 1723), and is reached from Chili by the Bariloche pass, rediscovered by Jorge Robbs in 1852. For some distance the Rio Negro is navigable for steamers drawing 12 feet, but only vessels with powerful engines can make head against the current. South of this river there stretches north and south a chain of hills—the Valchita and Ustak range—which, lying from 50 to 100 miles from the coast, forms a secondary watershed, draining westward into the plain as well as eastward to the Atlantic. The next great Andean river is the Chubut (Chubut or Chuba, &c., erosion), which gives its name of

Chubut Territory to the northern division of Argentine Patagonia, and is well known from the Welsh colonies established in its valley in 1865 by Mr. Lewis Jones. Its northmost affluent rises probably a little south of Nahuel-Huapi, about 41° 25', and its southmost between 46° and 47°. The latter stream, the Sengel or Senguer (explored by Durnford 1877, Moyano 1880), has this peculiarity, that, before entering the shallow basin of Lake Colguape (Huapi), Colhue; or, as Thomas and Moreno call it, Dillon, the volume of water is so much larger than when it issues again that the Welsh settlers distinguish the lower course of the stream as Sengellen or the Little Sengel.<sup>3</sup> Rio Desado, which disembogues at Port Desire (Puerto Desado), well known in the early history of the coast, has its source about 46° 43', in the vicinity of a large lake, Buenos Ayres (20 miles long by 14 broad), which lies, however, 600 feet below the level of the river, and consequently has no connexion with it. Of the rivers which unite in the Santa Cruz estuary the Rio Chico (explored by Musters, Moyano, and Lista) and the Chatta or Sheuen (explored by Moyano and Moreno) have little that calls for notice; but the Santa Cruz is connected with the most remarkable cluster of mountain-lakes in the country. The largest of these is Capar or Viedma Lake (discovered by Viedma in 1782); northward it communicates by a narrow channel with what may be distinguished as Moreno Lake, which again opens into San Martin, and southward it discharges into the very irregular Lago Argentino or Fitzroy Lake (discovered, according to Musters, by an adventurer called Holstein in 1868, and next visited by Fallberg, which in its turn probably has extensive ramifications. From the east end of Lago Argentino issues the rapid current of the Santa Cruz. Round these lakes the mountains rise with glaciers and snow-fields from 3000 to 3500 feet, and at the north-west end of Viedma stands the active volcano of Chaiten. At the time of Moreno's visit in March (the latter part of summer) gigantic icebergs rising 70 feet above the water continued to float about Lago Argentino. With the melting of the snows the river rose rapidly, and by 17th March was 63 feet above its ordinary level. So swift was its current that the explorers sped down the whole length of its course in twenty-four hours, though they had taken a month to ascend. In some parts the rate was at least 15 miles per hour. The Rio Gallegos, the last of the rivers of Patagonia which flow west and east, is comparatively insignificant except during thaw-floods, when it completely interrupts communication by its wide and raging torrent (see Beerbohm's exciting narrative). The eastern coast of Patagonia contrasts strikingly with the western; hardly an island of any considerable size exists on all the 2000 miles of its development, and it is scooped out into spacious and open gulfs. The peninsula of San José or Valdes to the south of the Gulf of San Matias is quite exceptional. But the whole seaboard offers only one or two safe harbours; and submerged reefs, strong tides, currents, and overfalls combine to render it highly perilous. Besides El Carmen or Patagones, near the mouth of the Rio Negro, a place of 1690 inhabitants in 1869, there is hardly a permanent settlement of any size from the river to the strait; but, since the partition between Chili and the Argentine Republic, beginnings of colonization have been made at the more promising points. A notice of the native Patagonians is given in the article INDIANS (AMERICAN), vol. xii. p. 829; and the history of the Araucanian tribes of the Chilian side has been sketched under AMERICA, vol. i. pp. 701-702.

*History.*—Patagonia was discovered in 1520 by Magellan, who called the country Tierra de Patagones from the large footsteps observed near his winter quarters at San Julian, and on his passage along the coast named many of the more striking features—Bay of San Matias, Bay of Santa Cruz, Cape of 11,000 Virgins (now simply Cape Virgin or De la Virgen), &c. By 1611 the Patagonian god Setebos (Settboth in Pigaletta) was familiar to the hearers of the *Tempest*. Rodrigo de Iala, despatched inland in 1535 from San Matias by Alcazava Sotomayor (on whom western Patagonia had been conferred by the king of Spain), was the first to traverse the great Patagonian plain, and, but for the mutiny of his men, he would have struck across the Andes to the Chilian side. Pedro de Mendoza, on whom the country was next bestowed, lived to found Buenos Ayres, but not to carry his explorations to the south. Camargo (1589), Ladrilleros (1587), Hurtado de Mendoza, and Erilla (1588) helped to make known the western coasts, and Drake's voyage in 1577 down the eastern coast through the strait and northward by Chili and Peru was memorable for several reasons; but the geography of Patagonia owes more to Pedro Sarmiento de Gamboa, who, devoting himself especially to the south-west region, made such careful and accurate surveys that from twenty to thirty of the names which he affixed still appear in maps (Kohl). The settlements which he founded at Nombre de Dios and San Felipe were neglected by the Spanish Government, and the latter was in such a miserable state when Thomas Cavendish visited it in 1587 that he called it Port Famine. The district in the neighbourhood of Port Desire, explored by John Davis about

<sup>1</sup> See Dr. Karl Berg, "Eine Naturhist. Reise nach Patagonien," in *Petersmann's Mittheilungen*, 1875; and the botanical part of the report of Bosc's expedition (resumé in *Nature*, 1864).

<sup>2</sup> Hence the name Cordillera de Baguales applied to the southern extremity of the Andes.

<sup>3</sup> See Durnford's account in *The Field* 23d and 30th Dec. 1882, and *Proc. Roy. Geogr. Soc.*, 1883.

the same period, was taken possession of by Sir John Narborough in the name of King Charles II. in 1669. In the latter half of the 18th century our knowledge about Patagonia was considerably augmented by Byron (1764-65), Wallis (1766), Bougainville (1766); Thomas Falkner, a Jesuit who "resided near forty years in those parts," published his *Description of Patagonia* (Hereford, 1774); Francisco Viedma founded El Carmen, and Antonio advanced inland to the Andes (1782); and Villarin ascended the Rio Negro (1782). The "Beagle" and "Adventure" expeditions under King (1826-30) and Fitzroy (1832-36) were of first-rate importance, the latter especially from the participation of Charles Darwin; but of the interior of the country nothing was observed except 200 miles of the course of the Santa Cruz. Captain Musters wandered in company with a band of natives through the whole length of the country from the strait to the Manzaneros in the north-west, and collected a great deal of information about the people and their mode of life. Since that date explorations of a more scientific character have been carried on by Moreno (1873-80), Rogers (1877), Lista (1878-80), and Moyano (1880, &c.), a convenient survey of which will be found in *Petermann's Mittheilungen*, 1882.

Bibliographical lists for Patagonia are given in Wapptus, *Handbuch der Geogr. u. Stat. des obern, mittl. und Sud-Amerika* (Leips., 1868-70); in Quenada's work already quoted; and in Coan, *Adventures in Patagonia* (New York, 1880). It is enough to mention Darwin's *Journal of Researches* (1845) and *Geological Observations on South America* (1846); Snow, *A Two Years' Cruise of the "Patagonia"* (1857); Munster, *At Home with the Patagonians* (1871); Camargo, *Not. Hist. of the Strait of Magellan* (1871); Moreno, *Viaje a la Patagonia central* (1879); Lady Florence Dixie, *Across Patagonia* (1880); Lista, *Mis exploraciones . . . en la Patagonia* (Buenos Ayres, 1880); Beerboom, *Wanderings in Patagonia* (1878); *Informe Oficial . . . de la Exp. al Rio Negro* (under General Roca, 1879, Buenos Ayres, 1883); Glasco, *Boya, Patagonia, Terra del Fuoco* (Genoa, 1885).

PATARENES, a name apparently first used in Milan about the middle of the 11th century to denote the party most extremely opposed to the marriage of priests; besides Patarani, the forms Paterini, Patarelli, Patarami occur among others. Various etymologies, more or less far-fetched, have been offered; it seems, however, pretty well established that the party was so called because, under the leadership of Ariadus, a deacon of Milan, its members used to assemble in the Pataria, or ragmen's quarter of that city (*pates* being a provincial word for a rag). The name ultimately came to be applied to the dualistic sect of the Cathari, who were opposed to marriage altogether, and indeed was one of their most common designations in Italy, France, and Bosnia.

PATENTS. Patents for inventions, instruments which formerly bore the great seal of the United Kingdom, are now issued at the Patent Office in London under the seal of that office. By their means inventors obtain a monopoly in their inventions for fourteen years, a term which, if insufficient to remunerate the inventor, can be extended. This monopoly is founded on exactly the same principle as the copyright enjoyed by authors and artists. There are persons who argue that no such privilege should be permitted; there are others who think that the most trifling exertions of the inventive faculties should be protected. The right course lies between these extremes. All civilized nations have in modern times considered it desirable to give inventors an exclusive right to their inventions for a limited period, not only as a matter of justice to individuals but as a piece of sound policy tending to the advantage of the whole community. The monopoly is granted in the expectation that the inventor will derive some profit from it; and the hope of profit is known to be a great stimulus to invention. When an author writes a book, or an artist designs a picture, the law allows a right of property to those persons in their productions, and accompanies the recognition of this right with the power to repress infringements. If this were not so, probably very few persons would employ their time in writing books or creating works of art; and hardly any one will be bold enough to assert that the extinction of the race of authors and artists is to be desired. The same principle applies to inventors, who ought to have the works of their brain protected from piracy fully as much as the other classes of mental producers. By holding out to them the prospect of gain they are induced, at a present loss of time

and money, to attempt to discover improvements in the useful arts, in machinery, in manufacturing processes, &c.; and thus the interests of the community are advanced more rapidly than if such exertions had not been brought into play. Just as the rule of rewarding inventors is in theory attended with some difficulty, so is the practical application of it. To grant a very long term of exclusive possession would be detrimental to the public, since it would tend to stop the progress of improvement. A limited property must therefore be allowed,—large enough to give the inventor an opportunity of reaping a fair reward, but not barring the way for an unreasonable period. And, when this compromise has been decided on, it will be seen how difficult it may be to determine beforehand what is the real merit of an invention, and apportion the time to that merit. Hence it has been found necessary to allot one fixed period for all kinds of inventions falling within the purview of the patent laws. This regulation appears to be open to the complaint that the least valuable and the most meritorious inventions are placed on the same footing. But it may be replied that in the result this is of little consequence, since meritorious inventions alone obtain the patronage of the public, those which are destitute of value being neglected. Besides, if the complaint were well founded, there is here no sound argument against the policy of privileges of this nature, seeing that it is impossible to weigh beforehand one invention against another in the scale of merit, or to obtain a true standard of comparison.

Leaving the discussion of general considerations, we will now give an outline of the law affecting patent privileges in the United Kingdom. Formerly the reigning prince considered himself entitled, as part of his prerogative, to grant privileges of the nature of monopolies to any one who had gained his favour. These grants became so numerous that they were oppressive and unjust to various classes of the commonwealth; and hence, in the reign of James I., a statute was wrung from that king which declared all monopolies that were grievous and inconvenient to the subjects of the realm to be void. (See MONOPOLY.) There was, however, a special exception from this enactment of all letters patent and grants of privilege of the "sole working or making of any manner of new manufacture within the realm to the true and first inventor of such manufacture, which others at the time of making such letters patent and grants should not use, so they be not contrary to law, nor mischievous to the state by raising of the prices of commodities at home or hurt of trade or generally inconvenient." Upon these words hangs the whole law of letters patent for inventions. Many statutes were afterwards passed, but these were all repealed by the Patent Act of 1883 (46 and 47 Vict. c. 57), which, besides introducing a new procedure, modified the law in several particulars. When the law remains unaltered, it has to be gathered from the numerous decisions of the courts, for patent law is for the most part "judge-made law." Of the law as it now stands we proceed to give an outline.

The inventions for which patents are obtained are chiefly either vendible articles formed by chemical or mechanical operations, such as cloth, alloys, vulcanized india-rubber, &c., or machinery and apparatus, or processes. It may be remarked here that a scientific principle cannot form the subject of a valid patent unless its application to a practical and useful end and object is shown. An abstract notion, a philosophical idea, may be extremely valuable in the realm of science, but before it is allowed to form a sound basis for a patent the world must be shown how to apply it so as to gain therefrom some immediate material advantage. With regard to processes, the language of the statute of James has been strained to bring them within

the words "any manner of new manufacture," and judges on the bench have admitted that the exposition of the Act has gone much beyond the letter. However, it is undoubted law that a process is patentable; and patents are accordingly obtained for processes every day.

The principal classes of patentable inventions seem to be these:—(1) new contrivances applied to new ends, (2) new contrivances applied to old ends, (3) new combinations of old parts, whether relating to material objects or processes, (4) new methods of applying a well-known object.

With regard to a patent for the new application of a well-known object it may be remarked that there must be some display of ingenuity in making the application, otherwise the patent will be invalid on the ground that the subject-matter is destitute of novelty. For example, a machine already in use as an excavator on land cannot be separately patented as an excavator under water; nor can a machine employed in the finishing of cotton goods be afterwards patented without alteration as applied to the finishing of woollen fabrics. A small amount of invention is indeed sufficient to support a patent where the utility to be derived from the result is great. A small step in advance, a slight deviation from known processes, may have been apparently brought about by the exercise of little ingenuity; but, if the improvement be manifest, either as saving time or labour, a patent in respect of it will stand. The mere omission of a step from some commonly practised process has been held sufficient to support a patent for a new method of manufacture; and how often do we see what appears to be a very trifling degree of novelty attended with very advantageous consequences, sometimes resulting in the entire revolution of a manufacture, or in a lowering of price appreciable in every pound of an article extensively used by the public!

Whatever be the nature of the invention, it must possess the incidents of utility and novelty, else any patent obtained in respect of it will be invalid. The degree of utility need not, however, be great. As to novelty, this is the rock upon which most patents split; for, if it can be shown that other persons have used or published the invention before the date of the patent, it will fall to the ground, although the patentee was an independent inventor deriving his ideas from no one else. The difficulty of steering clear of this rock will be apparent at once. Suppose A in London patents an invention the result of his own ingenuity and patient study, and it afterwards appears that B, in some distant part of the kingdom, had been previously openly using the same thing in his workshop, A's patent is good for nothing. Thus, in one of the cases which arose out of Heath's carburet of manganese patent—a patent celebrated in the law-courts—it appeared that three firms had used a process in the manufacture of steel which was substantially the same as that forming the subject of the patent. They had used the process openly in the way of their trade previous to the date of the patent, although it had not become generally known. This prior use of the invention was held to deprive the patent of validity. It is therefore a very frequent subject of inquiry, whether an invention has been previously used to such an extent as to have been publicly used in the sense attached by the courts to this phrase. The inventor himself is not allowed to use his invention, either in public or secretly, with a view to profit, before the date of the patent. Thus, if he manufactures an article by some new process, keeping the process an entire secret, but selling the produce, he cannot afterwards obtain a patent in respect of it. If he were allowed to do this he might in many cases easily obtain a monopoly in his invention for a much longer period than that allowed by law. The rule that an inventor's use of the invention

invalidates a subsequent patent does not, however, apply to cases where the use was only by way of experiment with a view to improve or test the invention. And it has been repeatedly decided that the previous experiments of other persons, if incomplete or abandoned before the realization of the discovery, will not have the effect of vitiating a patent. Even the prior discovery of an invention will not prevent another independent discoverer from obtaining a valid patent if the earlier inventor kept the secret to himself, the law holding that he is the "true and first inventor" who first obtains a patent.

When an invention is the joint production of more persons than one, they must all apply for and obtain a joint patent, for a patent is rendered invalid on showing that a material part of the invention was due to some one not named therein. The mere suggestion of a workman employed by an inventor to carry out his ideas will not, however, require that he should be joined, provided that the former adds nothing substantial to the invention, but merely works out in detail the principle discovered by his employer. In certain cases in which patents taken out by the celebrated Sir Richard Arkwright came to be inquired into, it was proved that the inventions were really made by persons in Arkwright's employment. Their value being perceived by him, he adopted them, and obtained the patents in question, but under these circumstances they were adjudged invalid.

If it can be shown that the invention in respect of which a patent has been obtained was previously described in a printed book in circulation in Great Britain, whether such book be in the English or a foreign language, the patent is also invalid, because a man has no right to obtain a monopoly in that which is already a part of the stock of public information; and it is not necessary to prove that the patentee was acquainted with the book, and derived his ideas from that source. The most usual prior publication fatal to a patent is a prior specification of a similar invention. But persons are allowed to obtain patents for inventions imported from abroad, if such inventions are new within the realm, and if they acknowledge, on the face of their applications, that the inventions are imported, not original. Such patents are now common.

The attributes of novelty and utility being possessed in due degree by an invention, the chief remaining difficulty with which a patent has to contend resides in the complete specification, the instrument by which the inventor describes the nature of the invention and the means by which it may be carried into effect. An inventor is bound, in return for the monopoly conceded to him, to instruct the public how to work the invention when the monopoly shall have expired, and to inform them in the meantime what it is they are shut out from using; and now the patent is not granted till the complete specification is filed. The patentee is bound to make by this instrument a full disclosure of his secret; he must not keep anything back either wilfully or accidentally; he must render everything plain and clear, showing no attempt to mislead, and leaving nothing ambiguous; he must distinguish what is old from what is new; he must point out distinctly what it is that he claims as his own exclusive property, and he must take care that he claims no more than he is entitled to. Very many patents have been invalidated by a disregard of the requirements of the law, the most common fault being that the specification claims too much; in other words, it claims something that is already public property, or another man's patented invention. And here we are brought back to the question of novelty. If a patentee discovers that his specification claims more than he is entitled to, he may put the matter right by filing an amendment, and excising the superfluous parts; but he will not be allowed to extend

his claims in any degree. He may cut out anything, but he can insert nothing, except matter which is of the nature of correction or explanation.

The term for which a patent is originally granted is fourteen years, but the crown has been empowered by parliament and through the intervention of the judicial committee of the privy council, before which the proceedings take place, to extend the time of a patent from its expiration for any additional time not longer than fourteen years. But an extension will only be granted on the patentee showing that the invention is meritorious, and that he has not been adequately rewarded in spite of his best efforts directed to that end. What is adequate reward depends on the special circumstances of each case. The crown has hitherto had a right to the free use of a patented invention, but this right has been abolished by the new Act.

Patent privileges, like most other rights, can be made the subject of sale. Partial interests can also be carved out of them by means of licences, instruments which empower other persons to exercise the invention, either universally and for the full time of the patent (when they are tantamount to an assignment of the patentee's entire rights), or for a limited time, or within a limited district. By an exclusive licence is meant one that restrains the patentee from granting other licences to any one else. By means of a licence a patentee may derive benefit from his patent without entering into trade and without running the risks of a partnership.

One of the regulations of the recent Act is that a patentee can be compelled by the Board of Trade to grant licences to persons who are able to show that the patent is not being worked in the United Kingdom, or that the reasonable requirements of the public with respect to the invention cannot be supplied, or that any person is prevented from working or using to the best advantage an invention of which he is possessed.

A patentee's remedy for an infringement of his rights is by civil suit, there being no criminal proceedings in such a case. In prosecuting such suit he subjects those rights to a searching examination, for the alleged infringer is at liberty to show that the invention is not new, that the patentee is not the true and first inventor, &c., as well as to prove that the alleged infringement is not really an infringement. But it may here be remarked that a patentee is not bound down (unless he chooses so to be) to the precise mode of carrying the invention into effect described in the specification. If the principle is new, it is not to be expected that he can describe every mode of working it; he will sufficiently secure the principle by giving some illustrations of it; and no person will be permitted to adopt some mode of carrying the same principle into effect on the ground that such mode has not been described by the patentee. On the other hand, when the principle is not new, a patentee can only secure the particular method which he has invented, and other persons may safely use other methods of effecting the same object. Instances of this occur every day; and it is well known that scores of patents have been taken out for screw-propellers, steam-hammers, water-meters, &c., each of which is limited to the particular construction described, and cannot be extended further. Again, where the invention patented consists of a combination of parts, some old and some new, the whole constituting a new machine or a new process, it is not open to the world to copy the new part and reject the rest. A man is not permitted to allege that the patent is for a combination, and that, the identical combination not having been used, there has been no infringement. If he has borrowed the substance of the invention, it will be held that he has infringed the patent.

A patent may be revoked by a court of law on any one taking proceedings for that purpose, and showing good ground for a revocation, such as want of novelty or utility in the invention, the fact of the patentee not being the inventor, insufficiency of the specification, fraud, or the like.

Patents are not now extended to the colonies, and such of the English colonies as possess a legislature are gradually acquiring patent laws for themselves (see *infra*).

The new Act enables the crown to make arrangements with foreign states for the mutual protection of inventions, under which a person who has applied for protection for any invention in a foreign state will be entitled to apply for a patent in England within a limited time in priority to other applicants (see p. 358).

The patent business of the United Kingdom is transacted at the Patent Office in London under the superintendence of the comptroller, an officer appointed by the Board of Trade, under whose direction he performs his duties. At this office is kept a register of all patents issued, of assignments of patents, licences granted under them, &c. An illustrated journal of patent inventions is published at the same office, where printed copies of all specifications can also be obtained. The proceedings taken with a view to obtain a patent commence with an application drawn up in a special form and accompanied by a description of the invention and a declaration as to its originality. Any person, whether a British subject or not, may apply for a patent. The actual inventor must always be a party to the application, but he may join other persons with himself, and the patent when issued will be granted to them all jointly. The fees payable to Government on patents have been considerably reduced by the new Act, and they may now be paid by convenient annual instalments.

During the ten years ending with 1882 the average annual number of patents issued was 3506. There has been a large increase under the new law, the number of patents applied for in the first three months of 1884 being 5748.

Patents are frequently obtained through the intervention of persons termed patent agents, who devote themselves to this branch of business.

*United States.*—Under an Act passed in 1874 a patent must in all cases be applied for in the name of the original inventor, although he may contemporaneously execute an assignment of the invention, and the patent will thereupon be issued to the assignee. Every application is referred to an official examiner. The patent will be refused if any part of the invention is wanting in novelty, or if the application is not in proper form. The applicant may, however, make a re-application, and if the inventor is dissatisfied with the report of the examiner he can appeal. Patents are issued for the term of seventeen years, but expire with any earlier foreign patents for the same invention. A foreign inventor may obtain a patent if his invention has not been in public use or on sale in the United States for more than two years prior to his application.

#### *Patent Laws in India and the British Colonies.*

Prior to 1852 British letters patent extended to all Her Majesty's colonies, but the Patent Act of 1852 restricted the rights granted to Great Britain and Ireland, the Channel Islands, and the Isle of Man. Soon after the date of this Act the legislatures of the colonies began to pass Acts of their own for the protection of inventions, and at the present time most English colonies have patent laws. As a rule, the application in the colony must be made by petition accompanied with a specification and drawings of similar nature to those used in the British application; and in most cases the application must be made by the inventor himself or by his assignee, or by some person holding his power of attorney. The patents are in all cases assignable and the deeds of assignment must be registered in the respective colonies. The patents are usually granted for a term of fourteen years, and the inventions must not have been publicly used in the colony prior to the date

of the application. Inventions may be protected in most if not all the other British colonies by special Acts of the colonial legislatures.

**Australian Colonies.**—The colonial Act for New South Wales is dated 14th September 1852. Applications are referred to a board consisting of two scientific men, and upon their report and the payment of £20 the governor will grant letters patent of registration, which have the effect of letters patent. These letters of registration are granted for the term of fourteen years. The New South Wales Act of 1852 still continues in force in Queensland. By an order in council of 6th November 1859 patents similar in terms to those granted in New South Wales can be obtained, and at the same cost. By an Act passed in 1867 inventions can be provisionally protected, but the provisional protection only appears to be useful to residents in the colony. In South Australia the law of patents is governed by the Acts of 1877 and 1881. The application is submitted to an official examination. The patent is granted for a term of fourteen years, and is subject to taxes of £2 10s. to be paid before the end of the third year and £2 10s. before the end of the seventh year. The invention must be worked in the colony within three years from the date of the grant. In Victoria power is given to the governor to issue letters patent by Act No. 240, 1865. The sum of £15 must be paid before the expiration of the third year, and £20 before the expiration of the seventh year. For Western Australia the colonial Act is dated 15th August 1872, under which *bona fide* holders of letters patent in any other country can obtain letters of registration having the force of patents and expiring with the original patent. The government fee is £25. The governor has also power to grant original patents, but these are seldom applied for except by residents in the colony. The government fee on these is £50. The application for a patent must be made before the application is made in any other colony or country.

**British Guiana.**—The law of patents is governed by an ordinance dated 12th July 1861. Patents are granted very much in the same form and on the same conditions as British letters patent. A duty of \$100 is payable before the end of the seventh year. The governor has power to prolong the term for a period not exceeding seven years.

**British Honduras.**—The Act for amending the law for granting patents for inventions dated 10th September 1862 rules here. This Act has provisions very similar to the British Patent Law Amendment Act 1852. The government fee on sealing is \$30, and the further government duties payable are \$50 at the end of the third year and \$100 at the end of the seventh year. Prolongations of the original term of fourteen years may be obtained for an additional term not exceeding seven years.

**Canada.**—The Acts in force are those of 1872, 1875, and 1883. Inventors or their assignees may obtain patents for fifteen years for all inventions not having been in public use or on sale in Canada for more than a year prior to the application. When a period of more than twelve months has elapsed since the date of any other patent for the same invention the application will be refused. A government duty of \$20 must be paid for the first five years, \$40 for the second five years, and \$60 for the last five years. These duties can be paid either altogether on application or by three instalments. The invention must be worked in Canada within two years from the date of the patent. The patent is void if after the expiration of twelve months from the grant the patentee imports into Canada the objects of the invention manufactured elsewhere.

**Cape of Good Hope.**—The Act of 1860 prescribes a system very similar to that laid down by the English Patent Act of 1852. A stamp duty of £10 is payable at the expiration of the third year and £20 at the expiration of the seventh year of the grant. The patent will expire with the expiration of any earlier patent in any other country for the same invention.

**Ceylon.**—The inventive ordinance of 1859 governs the law of patents here. Patents are granted for a term of fourteen years from the time of filing the specification, and the governor has power to grant prolongations not exceeding fourteen years. The fee on filing the specification is £10.

**Hong-Kong.**—By the law of 2d July 1862 the governor in council may grant patents for inventions which have already been patented in England to the inventor or to the owner by assignment of the British patent. The patent will extend over the same term as the British patent. Subjects of foreign states not having British patents cannot obtain patents in Hong-Kong.

**India.**—The law of patents is governed by an Act dated 17th May 1859. Where there is no prior English patent the invention must not have been used or published before filing the application. Where an English patent has already been obtained, the application must be made within twelve months from the date of the English patent. The exclusive privilege is acquired by merely filing a specification of the invention upon leave obtained from the governor-general for that purpose, and no patent is issued. The governor-general has power to extend the original term for another term not exceeding fourteen years. The government fees on application amount to £10; no further duties are payable.

**Jamaica.**—Chap. 30, 21 Vict. 1857, governs the law of patents here. The invention must be brought into operation in the island within two years from the date of the patent. A patent bears a stamp duty of £6 10s., and there is a reference to the attorney-general, upon which he is paid a fee of £5. The duration of the patent is limited to that of any previous foreign patent. Improvements on the original invention may be protected by certificates of addition. Patents may be extended for a further period of seven years beyond the original term of fourteen years.

**Leeward Islands.**—The law is regulated by the Acts of 1870 and 1878, the provisions being similar to those of the English Patent Act of 1852. The patent expires with the termination of any earlier patent elsewhere for the same invention. The payments amount to £28 on every application which is not opposed, and a duty of £10 is payable at the termination of the third year and £20 at the termination of the seventh year.

**Mauritius.**—The law is regulated by an ordinance dated 22d May 1875. The governor has power to extend patents for any period not exceeding fourteen years beyond the original term of fourteen years. A patent may be applied for by the executors or administrators of a deceased inventor. Payments of £12 are required to be made upon application for the patent and upon sealing.

**Natal.**—The provisions of the colonial Act of 1870 are similar to those of the English Patent Act of 1852. The fees on sealing are £1 10s., and there is a third year's duty of £5, and a seventh year's duty of £10. The patent expires with the termination of any British or foreign patent of earlier date. The Lieutenant-governor can grant a prolongation of the original term for a fresh term not exceeding fourteen years.

**Newfoundland.**—Under an Act passed in 1856 patents are granted for fourteen years, but may be extended upon application for a further period of seven years. The patent expires with the expiration of any previous foreign patent for the same invention. Improvements may be protected by certificates of addition. The invention must be worked in the colony within two years from the date of the patent.

**New Zealand.**—Under the New Zealand Patent Act of 1853 inventors can obtain either letters patent or letters of registration as they think fit. The fee for letters of registration is £10, and for letters patent £2 10s., with a further duty of £10 at the end of five years. Letters of registration are granted as of course upon proof of the applicant being the actual owner of the foreign patent. The invention patented must be worked in the colony within two years from the date of the patent.

**Tasmania.**—The colonial Act for Tasmania is dated 5th November 1853. The proceedings prescribed are very similar to those in England. The government fees are £7 10s. on application, £15 at the end of the third year, and £20 at the end of the seventh year.

Patents may also be obtained in St Helena, the Straits Settlements, and Trinidad.

*Foreign Patent Laws.*

**Argentine Republic.**—Patents are granted under a law dated 11th October 1864, for five, ten, or fifteen years, to the inventor or to his assignee. The applications are subjected to an official examination, and the patent when granted is liable to government fees and stamp duties, which vary from about £20 to £60, according to the term of the patent. The invention must not have been published either at home or abroad prior to the application, and must be worked in the republic within two years from the date of the issue of the patent.

**Austria-Hungary.**—By an imperial decree of the 15th August 1852, although separate patents are issued, they are made upon one application. The protection extends to Bosnia and Herzegovina. Where the applicant for a patent is a foreigner he must have obtained a patent in his own country for the same invention, and patents are only granted to the original inventor or his assignee. Inventions are considered new when at the time of the applications for patents they have not been put into operation or made public in the empire. The government taxes commence at the rate of 26 florins per annum for the first five years, and gradually increase until in the fifteenth year the duty is 123 florins. If the patent is originally granted for less than fifteen years it may at any time be prolonged for that term. The invention must be worked in the empire within a year from the date of the patent, and the working must not be suspended for more than two years; during its continuance there is no objection to the patented articles being imported from a foreign country.

**Belgium.**—Patents are granted to the inventor or to his assignee, or to any one holding the authority of the inventor for that purpose. The term is fixed at twenty years, except in the case of inventions previously patented elsewhere, when the Belgium patent expires with the previous foreign patent of the greatest length. Patents are subject to an annual tax beginning at 10 francs for the first year, and increasing annually at the rate of 10 francs. Patents of addition expiring with the original patent may be obtained. The invention must be worked in Belgium within one year from its

being worked abroad, but patented articles manufactured abroad may be introduced into Belgium.

**Brazil.**—By a statute passed in 1882 patents are granted alike to natives and to foreigners. In the case of a foreigner the application must be made in Brazil within seven months from the date of his foreign patent. The specification must be in the Portuguese language. Patents are granted for a term of fifteen years, subject to the payment of a duty of £1 for the first year, and increasing £1 yearly. The patent must be put into operation in Brazil within a year from the date of the grant, and the working must not be interrupted for more than a year. The Brazilian patent expires on the expiration of any earlier foreign patent for the same invention. The foreign patentee must appoint an accredited agent to represent him in Brazil.

**Chili.**—Patents are granted for a term of ten years, subject to a tax of £10 to be paid on application. An extension of a patent may be obtained when the importance of the invention is considered sufficient to warrant it. The invention must be worked in Chili within a term fixed in the patent, and the working must not be discontinued as long as the patent is valid.

**Denmark.**—Native inventors may obtain patents for fifteen years, but patents granted to foreigners are limited to five years. A tax of 80 francs is payable on every patent. The invention must be worked in the country during the first year of the patent, and must be continued without interruption, but the patentee can import the patented article into the country from abroad.

**France.**—Grants of patents (*brevets d'invention*) are regulated in France by the law of 5th July 1844. Patents are granted to inventors or their assignees, whether natives or foreigners, and the French patent expires with any foreign patent of earlier date. Applications for French patents must be made prior to the filing of the complete specification in any foreign country. Patents are granted for a term of fifteen years upon payment of an annual duty of £4. All the duties must be paid up prior to an assignment of the patent being registered. Alterations, additions, or improvements may be protected by patents of addition which expire with the original grant. The subject of the patent must be manufactured entirely in France, and cannot be imported from a foreign country without invalidating the patent. The invention must be put into execution within two years from the date of the grant, and the working must not then cease for any period of two consecutive years. The patent extends to all the French colonies.

**Germany.**—By a law dated 25th May 1877 patents are granted for fifteen years to natives and foreigners. The invention must not have been previously described in a printed publication in any way. The patentee may obtain supplementary tests for improvements expiring with the original patent. A government duty of £1 10s. is paid on the issue of the patent, together with an annuity commencing at £2 10s. and increasing by £2 10s. each year for the whole term. The Government may revoke the patent if the invention has not been carried out in Germany within three years from the date of the patent.

**Italy.**—Patents are granted only to inventors or their assignees for terms varying from one to fifteen years. The publication of a previous foreign patent does not invalidate the grant provided the application is made during the continuance of the foreign patent, but the Italian patent will expire with the previous foreign patent. Patents of addition are granted expiring with the original patent. Patents are liable to taxes amounting to about 50 francs for each of the first three years of the patent, and increasing gradually. The invention must be worked in Italy within two years from the date of the grant. The description of the invention may be either in the Italian or the French language.

**Norway.**—By laws of 15th July 1839 and 9th May 1842 patents are granted for a term not exceeding ten years to inventors only. The invention must not have been published in Norway prior to the application, which is subject to an official examination, not usually of a stringent character. A payment of 10 specie dollars must be made in respect of each application. The invention must be put in practice in the country within two years from the date of the grant.

**Paraguay.**—Under a law of 20th May 1845 citizens or foreigners are alike entitled to protection, and the term of the grant varies from two to ten years. Where there is a previous foreign patent for the same invention the patent is not valid for more than six months beyond the termination of the foreign patent. The invention patented must be worked within two years from the date of the grant.

**Portugal.**—By a royal decree of 31st December 1852 inventors, whether natives or foreigners, may obtain patents for terms varying from one to fifteen years. Certificates of addition are also granted, but expire with the original patent. A patent will not be granted to an inventor for a longer term than that of his original patent. The government taxes amount to about £1 8s. per annum, in addition to which certain official fees are payable. The patent becomes void if the invention is not carried into practice within two years from the date of its grant.

**Russia.**—The law is set forth in several imperial decrees, under which patents are granted to natives and foreigners alike for the term of three, five, or ten years, and upon payment of government duties of 90 roubles for three years, 150 roubles for five years, and 450 roubles for ten years. The patent also covers the kingdom of Poland. There is great delay in obtaining patents. A period of from one to two years usually elapses between the application and the date of the grant. The specification must be written in the Russian language. The invention must be worked in Russia within one quarter of the time for which the patent is granted. Separate patents are issued for Finland.

**Spain.**—The law is dated 1st August 1878. Patents are granted to foreigners as well as to natives for terms varying from five to twenty years. The application must be made prior to the publication of the specification of the invention in another country. The annual taxes begin with 10 francs for the first year, and increase at the rate of 10 francs a year. The patent covers the Spanish colonies of Cuba, Porto-Rico, and the Philippine Islands. The specification must be made in the Spanish language. Certificates of addition are granted for improvements, expiring with the original patent. The invention must be put into operation within two years from the date of the grant.

**Sweden.**—Patents are granted to natives and foreigners for terms varying from three to fifteen years, but the patent of a foreigner expires with the expiration of the foreign patent. The invention must be put into operation within the country before the expiration of two years from the date of the grant.

**Turkey.**—Under a law dated 2d March 1880 patents are granted to natives or foreigners for five, ten, or fifteen years, subject to an annual payment of two Turkish pounds. A patent expires with the termination of any earlier foreign patent for the same invention. Certificates of alteration, addition, or improvement are granted, and expire with the termination of the original grant. The invention must be worked within two years from the date of the patent, and the working must not be discontinued for two consecutive years subsequently. Patented articles manufactured abroad cannot be imported into Turkey without invalidating the patent.

In addition to the above-mentioned countries the following also have laws for the protection of inventions under which foreigners may obtain patents:—United States of Colombia, Guatemala, Grand Duchy of Luxemburg, Mexico, Nicaragua, and San Salvador.

#### International Patents.

The Governments of Belgium, Brazil, France, Guatemala, Holland, Italy, Portugal, San Salvador, Servia, Spain, and Switzerland have recently signed, and Great Britain is about to sign, an international convention relating to patents, the salient points of which are:—

(1) that the subjects of each of the above states shall in all the other states, as regards patents, enjoy the advantages that their respective laws grant to their own subjects; (2) that any person who has duly registered an application for a patent in any one of the states shall enjoy a right of priority protecting the first patentee against any acts accomplished in the interval for a term of six months—a month longer being allowed for countries beyond the sea; (3) that the introduction by the patentee into the country where the patent has been granted of objects manufactured in any of the other states shall not entail forfeiture; but the patentee remains bound to work his patent in conformity with the laws of the country into which he introduces the patented objects; (4) that the states agree to grant temporary protection to patentable inventions for articles appearing at officially recognized international exhibitions.

It is understood that Holland and Switzerland, where there are at present no patent laws, will shortly adopt measures in pursuance of the terms of the above convention whereby inventions may be protected.<sup>1</sup>

(J. H. J.)

**PATERCULUS, MARCUS<sup>2</sup> VELLEIUS**, a Roman historian, was probably born about 19 B.C. His father, a cavalry officer, belonged to a good Capuan family, several members of which had risen to some military or magisterial distinction. The historian himself served as military tribune in Thrace, Macedonia, Greece, and the East, and in 2 A.D. was present at the interview on the Euphrates between C. Cæsar (grandson of Augustus) and the Parthian king. Afterwards as prefect of cavalry and legatus he served for eight years (from 4 A.D. onward) in Germany and Pannonia under Tiberius, in whose triumph (13 A.D.) he and his brother bore a conspicuous part. For his services

<sup>1</sup> For further information on the subject the reader is referred to Johnson's *Patentee's Manual*, fifth edition, 1884.

<sup>2</sup> Marcus is the name given by Prician; but Renier identifies the historian with the "C. Velleio Paterculo" of a North-African milestone (*Acad. des Inscriptions*, Dec. 1875; *Rev. Archéol.*, 1875), the date of which he places (on inconclusive grounds) in 96 A.D.



he was rewarded with the quaestorship in 7, and, along with his brother, with the praetorship in 15. He was still alive in 30, for his history contains many references to the consulship of M. Vinicius in that year. The date and manner of his death are unknown. It has been conjectured that he was put to death in 31 as a friend of Sejanus, whose praises he celebrates.

He wrote a compendium of Roman history in two books dedicated to M. Vinicius, from the dispersion of the Greeks after the siege of Troy down to the death of Livia in 29 A.D. The first book brings the history down to the destruction of Carthage, 146 B.C.; portions of it are wanting, including the beginning. The later history, especially the period from the death of Caesar, 44 B.C., to the death of Augustus, 14 A.D., is treated in much greater detail. Brief notices are given of Greek and Roman literature, but, strange to say, no mention is made of Plautus, Horace, and Propertius. The author is a vain and shallow courtier; "full of wise saws," he is nevertheless entirely destitute of true historical insight. His knowledge is superficial, his blunders numerous, his chronology inconsistent. He labours at portrait-painting, but his portraits are daubs. On Caesar, Augustus, and above all on his patron Tiberius, he lavishes praise or flattery. The repetitions, redundancies, and slovenliness of expression which disfigure the work may be partly due to the haste with which (as the author frequently reminds us) it was written. Some blemishes of style, particularly the clumsy and involved structure of his sentences, may perhaps be ascribed to insufficient literary training. The inflated rhetoric, the straining after effect by means of hyperbole, antithesis, and epigram, mark the degenerate taste of the Silver Age, of which Paternulus is the earliest example. He purposed to write a fuller history of the later period, which should include the civil war between Caesar and Pompey and the wars of Tiberius; but there is no evidence that he carried out this intention.

Paternulus was little known in antiquity. He seems to have been read by Lucan and imitated by Sulpicius Severus, but he is mentioned only by the scholiast on Lucan, and once by Priscian. All we know of his life is derived from his own statements. The text of his work, preserved in a single badly-written MS. (now lost), is very corrupt, and its restoration has tasked the ingenuity of many learned men. The editio princeps appeared at Basel in 1520; subsequent editors have been J. Lipsius, Leyden, 1591; J. Gruter, Frankfurt, 1607; N. Heinsius, Amsterdam, 1678; P. Burmann, Leyden (2d ed.), 1744; D. Ruhnkens, Leyden, 1779; J. C. Orelli, Leipzig, 1825; F. Kritz, Leipzig, 1840 and 1843; F. Haase, Leipzig (3d ed.) 1858; C. Helm, Leipzig, 1876.

Besides the literary histories of Bernhardt and Teuffel, see the preface to Kritz's edition; H. Sauppe, in *Schœne's Museum*, t. p. 123; A. Ferraro, *De Valde sibi Historiae*, Leipzig, 1823; contributions to the criticism of the text by J. C. M. Laurent, *Les Velleiens*, Altona, 1826; J. Jeap, *Emendationes Velleianae*, Wolfenbüttel, 1829; N. Madvig, *Adversaria*, s. p. 297 sq.; English translations by Newcomb, Paterson, and Watson; German by Jacobs, Walther, and Byssenhart; French by Desprez and Girard; Italian by Manz, Bocconeri, and Spicriano Petretini.

**PATERINES.** See **PATERNES**.

**PATERNÓ**, a town of Sicily, in the province of Catania, stands at the south-west foot of Mount Ætna, 10 miles north-west of Catania near the railway from that city to Leonforte. It is a long straggling place with a mediæval castle (1073) and several churches and suppressed convents. The surrounding country is fertile, producing corn, oil, wine, flax, hemp, and timber, in which articles an active trade is carried on. Paternó gives the title of "prince" to a Sicilian family. In the neighbourhood the remains of ancient baths, tombs, and aqueduct, and a bridge across the Simeto have been discovered. The town is supposed to occupy the site of the ancient Hybla Major. Population 15,230.

**PATERSON**, the "Lyons of America," a city of the United States, capital of Passaic county, New Jersey, is situated on the Passaic river and the Morris Canal, 17 miles north-west of New York by the Erie and the Dela-

ware, Lackawanna, and Western Railroads. As the river, which forms the boundary of the city for a distance of 9 miles, has at one place a sheer fall of 50 feet, it is an unfailing source of abundant water power; and Paterson ranks second among the manufacturing cities of the State. Silk, iron, and cotton are the great industrial staples; silk-dyeing is also practised. One of the chief industries is the making of locomotives. Further, fire-engines, "Whitney" sewing-machines, iron bridges, brass wares, flax, hemp, and jute goods, calico-prints, paper, and chemicals are all manufactured. The population was 11,334 in 1850, 19,586 in 1860, 33,579 in 1870, and 51,031 in 1880. Founded in 1792 by a cotton company under the patronage of Alexander Hamilton and named after Governor William Paterson, who signed its town charter, Paterson obtained the rank of a city in 1851.

**PATERSON, WILLIAM** (1658-1719), founder of the Bank of England, projector of the Darien scheme, and a voluminous writer on subjects connected with finance, was born in April 1658 at the farmhouse of Skipmyre, parish of Tinwald, Dumfriesshire. His parents occupied the farm there, and with them he resided till he was about seventeen. A desire to escape the religious persecution then raging in Scotland, and a wish to find a wider field for his energies than a poor district of a poor country afforded, led him southward. He went through England with a pedlar's pack ("whereof the print may be seen, if he be alive," says a pamphleteer in 1700), settled for some time in Bristol, and then proceeded to America. There he lived chiefly in the Bahamas, and is said by some to have been a predicant or preacher, and by others to have been a buccaneer. The truth is that his intellectual and moral superiority to the majority of the British settlers naturally caused his selection as their spiritual guide, whilst his intense eagerness for information led to intercourse with the buccaneers, from whom alone much of the information he wanted could be had. It was here he formed that vast design which is known in history as the Darien scheme. On his return to England he was unable to induce the Government of James II. to engage in his plan. He went to the Continent and pressed it in Hamburg, Amsterdam, and Berlin, but unsuccessfully. A countryman of his own talks of him as a well-known figure "in the coffee-houses of Amsterdam" in 1687, and gives us some idea of the strange impression that this thoughtful-looking foreigner produced, as with fluent speech he unfolded to his astonished hearers a scheme which seemed wild and dazzling as a dream of Eastern romance. On his return to London he engaged in trade and rapidly amassed a considerable fortune. His activity was not confined to private business. About 1690 he was occupied in the formation of the Hampstead Water Company, and in 1694 he founded the Bank of England. The Government of the day required money, and the country, rapidly increasing in wealth, required a bank. The subscribers lent their money to the nation, and this debt became the bank stock. The credit of having formulated the scheme and persuaded the Government to adopt it is certainly due to Paterson. He was one of the original directors, but in less than a year, in consequence of some dispute with his colleagues, he withdrew from the management. He had already propounded a new plan for an orphan bank (so called because the debt due to the city orphans by the corporation of London was to form the stock). This, they feared, might prove a dangerous rival to their own undertaking, and besides they looked with considerable suspicion and dislike on this Scotsman whose brain teemed with new plans in constant succession.

At that time the people of the northern kingdom were engaged in considering how they might share in the bene-

fits of that trade which was so rapidly enriching their southern neighbours. Paterson embraced the opportunity thus offered. He removed to Edinburgh, unfolded his Darien scheme, and soon had the whole nation in favour of it. He, it is supposed, drew up the Act of 1695 which formed the "Company of Scotland trading to Africa and the Indies." This company, he arranged, should establish a settlement on the isthmus of Darien, and "thus hold the key of the commerce of the world." There was to be free trade, the ships of all nations were to find shelter in this harbour not yet erected, differences of race or religion were to be made nothing of; but a small tribute was to be paid to the company, and this and other advantages would so act that, at one supreme stroke, Scotland was to be changed from one of the poorest to one of the richest of nations.

On the 26th of July 1698 the first ships of the expedition set sail "amidst the tears and prayers and praises of relatives and friends and countrymen." Some financial transactions in which Paterson was concerned, and in which, though he had acted with perfect honesty, the company had lost, prevented his nomination to a post of importance. He accompanied the expedition as a private individual, and was obliged to look idly on whilst what his enemies called his "golden dream" faded away indeed like the "baseless fabric of a vision" before his eyes. His wife died, and he was seized with a dangerous illness, "of which, as I afterwards found," he says, "trouble of mind was not the least cause thereof." One who knew him in this evil time tells us "he hath been so mightily concerned in this sad disaster, so that he looks now more like a skeleton than a man." Still weak and helpless, and yet protesting to the last against the abandonment of Darien, he was carried on board ship, and, after a stormy and terrible voyage, he and the remnant of the ill-fated band reached home in December 1699.

In his native air Paterson soon recovered some of his strength, and immediately his fertile and eager mind was at work on new schemes. First he did all he could to prevent the Darien scheme already engaged in from being finally abandoned, then he prepared an elaborate plan for developing Scottish resources by means of a council of trade, and then he tried to induce King William to enter on a new Darien expedition. About the beginning of the century he removed to London, and here by conferences with statesmen, by writing, and by personal persuasion helped on the Union, of which his far-reaching mind enabled him, perhaps better than any other man then living, to see the advantages. At the Union one of the last acts of the Scottish parliament was to recommend him to the consideration of Her Majesty Queen Anne for all he had done and suffered. The united parliament, to which he was returned as a member for the Dumfries burghs, though he never took his seat, decided that his claim should be attended to, but it was not till 1715 that an indemnity of £18,241 was ordered to be paid him. Even then he found considerable difficulty in obtaining his due. His last years were spent in Queen Square, Westminster, but he removed from his house, though probably to some other part of London, shortly before his death, which happened 22d January 1719.

As many as twenty-two works, all of them anonymous, are attributed to Paterson. These are classified by Bannister under six heads, as dealing with (1) finance, (2) legislative union, (3) colonial enterprise, (4) trade, (5) administration, (6) various social and political questions. Of these the following deserve special notice. (1) *Proposals and reasons for constituting a Council of Trade* (Edinburgh, 1701).<sup>1</sup> This was a plan to develop the resources of his country. A council, consisting of a president and twelve

members, was to be appointed. It was to have a revenue collected from a duty on sales, lawsuits, successions, &c. With these funds the council was to set the Darien scheme going again, to build workhouses, to employ, relieve, and maintain the poor, and to encourage manufactures and fisheries. It was to give loans without interest to companies and shippers, it was to remove monopolies, it was to construct all sorts of vast public works. Encouragement was to be given to foreign Protestants and Jews to settle in the kingdom, gold and silver were to be coined free of charge, and money was to be kept up to its nominal standard. All export duties were to be abolished and import regulated on a new plan. By means like these Paterson believed the disasters lately undergone would be more than retrieved. (2) *A proposal to plant a colony in Darien to protect the Indians against Spain, and to open the trade of South America to all nations* (1701). This was a proposal to King William to establish the Darien scheme on a new and broader basis. It points out in detail the advantages to be gained: free trade would be advanced over all the world, and Great Britain would derive great profits. (3) *Wednesday Club dialogues upon the Union* (London, 1708). These were imaginary conversations in a club in the city of London about the union with Scotland. Paterson's real opinions were put into the mouth of a speaker called May. The result of the discussion is that till the Darien business all Scots were for the Union, and that they were so still if reasonable terms were offered. Such terms ought to include an incorporating union with equal taxes, freedom of trade, and a proportionate representation in parliament. A union with Ireland "as likewise with other dominions the queen either hath or shall have" is proposed. (4) Along with this another discussion of the same imaginary body, *An inquiry into the state of the Union of Great Britain and the trade thereof* (1717), may be taken. This was a consideration of the consequences of the Union, which, nor "that its honeymoon was past," was not giving satisfaction in some quarters, and also a discussion as to the best means of paying off the national debt,—a subject which occupied a great deal of Paterson's attention during the later years of his life.

Paterson's plans were vast and magnificent, but it is a great mistake to suppose that he was a mere dreamer. Every one of his designs was worked out into minute detail,<sup>2</sup> and every one was possible and practical. The Bank of England was a stupendous success. The Darien expedition failed from hostile attacks and bad arrangements. But the original design was that the English and Dutch should be partakers in it, and, if this had occurred, and the arrangements, against many of which Paterson in letter after letter in vain protested, had been different, Darien might have been to Britain another India, whose history was shadowed by the memory of no wrong.<sup>3</sup> Paterson was a zealous almost a fanatic free-trader long before Adam Smith was born, and his remarks on finance and his argument against an inconvertible paper-currency, though then novel, now hold the place of economic axioms. In his description of the "merchants in an extended sense" Paterson has drawn his own character for us. They are those "whose education, genius, general scope of knowledge of the laws, governments, polity, and management of the several countries of the world allow them sufficient room and opportunity not only to understand trade as abstractly taken but in its greatest extent, and who accordingly are zealous promoters of free and open trade, and consequently of liberty of conscience, general naturalisation, unions, and annexations."

Paterson's works are well written, and the form as well as the matter are excellent. As already noticed, they are all anonymous, and they are quite impersonal, for few men who have written so much ever said so little about themselves. There is no reference to the scurrilous attacks made on him. They are the true products of a noble and disinterested as well as vigorous mind. Paterson was not rewarded for his labours. The Bank of England was a great success, but he lost rather than gained by it. In the Darien scheme he was ruined, and this ruin he never quite retrieved. The credit of his other schemes has been usually ascribed to other and inferior men. There is thus singular fitness in the motto "*sic vos non vobis*" inscribed under the only portrait of him that we possess. See *Life of W. Paterson*, by E. Bannister (Edinburgh, 1868); *Paterson's Works*, 2 vols., by E. Bannister (London, 1869); *The Struggle and Prevalence of W. Paterson*, by W. Fagan (Edinburgh, 1866). The brilliant account in the fifth volume of Macaulay's *History* is incorrect and misleading. That in Burton's *Hist. of Scotland* (vol. viii. ch. 64) is much truer. A list of a number of fugitive writings on Paterson will be found in Foch's *Mag. Indec.* (F. W.)

<sup>1</sup> The books of the Darien company were kept after a new and very much improved plan, which it is believed was an invention of Paterson's (Burton's *Hist. Scot.*, vol. viii. p. 26, note).

<sup>2</sup> The revival of the Darien scheme in our own day is a signal proof of Paterson's foresight. Of a canal he says: "From Venta Crucis to Panama upon the South Sea there is by land about eight short French leagues, six whereof is so level that a canal might easily be cut through, and the other two leagues are not so very high and impracticable ground, but that a cut might likewise be made were it in these places of the world, but considering the present circumstances of things in those it would not be so easy" (*Works*, Bannister's ed., vol. i. p. 140).

<sup>1</sup> This work was attributed to John Law (see Law, vol. xiv. p. 267, note), who certainly borrowed some of his ideas from it. To Law's "system" Paterson was strongly opposed, and it was chiefly due to his influence that it made no way in Scotland.

## P A T H O L O G Y

**P**ATHOLOGY (*πάθος, λόγος*, the doctrine of disease or (lit.) of that which is suffered) holds a peculiar place among the natural sciences. Although it is laid down, in the opening sentences of the Hippocratic treatise *De praxi medicina*, that the medical art, on which all men are dependent, should not be made subject to the influence of any hypothesis (such as that of the four cardinal qualities, hot, cold, moist, and dry), that the care and cure of the sick should not be subordinated to pathological theory, but should be guided by experience; yet the practitioners of medicine have at no time been able to dispense with theory, not even those avowed followers of the Hippocratic tradition who, while they professed a kind of quietism amidst the rise and fall of systems, have none the less been profoundly influenced by theory at every step of their practice. The position of Cullen is the only rational one: "You will not find it possible to separate practice from theory altogether; and, therefore, if you have a mind to begin with theory, I have no objection. . . . To render it safe, it is necessary to cultivate theory to its full extent."

## § 1.—PROGRESS AND SCOPE.

The progress of pathology hitherto has been exactly parallel with the progress of philosophy itself, system succeeding system in genetic order. No other department of biological science has shown itself so little able to shake off the philosophical character, or to run in the career of positivism or pure phenomenalism. This unique position of pathology among the natural sciences is doubtless owing to the fact that it is a theory of practice, a body of truth and guess-work existing for the benefit of a working profession which is daily brought face to face with emergencies and is constantly reminded of the need of a reasoned rule of conduct. It is idle to attribute the philosophizing habit in medicine, or the habit of system-making, to an unscientific method in past times. The extremely various points of view from which the problems of diseased life are approached in the very latest, and most authoritative writings are an evidence that the difficulty is really inherent in the subject-matter.

The positive progress of the biological sciences does not essentially depend on the philosophical conception of life as action and reaction; but the notion of action and reaction comes to the front in every page of a pathological treatise, and at every step of practice. In considering the forms of diseased life, if not in the study of living things themselves, we are constantly driven back to that ultimate analysis. The influences from without, which make up ætiology or the doctrine of causes of disease, assume a position in medicine the urgency or immediate interest of which far exceeds that of the biological problem, "the correspondence between life and its circumstances." The standing difficulty in pathology has been its relation to ætiology, or the relation of the *ens morbi* to the *agens morbi*. One of the most singular ways of meeting the difficulty is that of Paracelsus, who boldly perpetrated the paradox: "*Ens ist ein Ursprung, welches Gewalt hat, den Leib zu regiren.*" The five classes of *entia* of Paracelsus are a composite catalogue, of which (1), (2), and (5) stand for influences from without, and (3) and (4) for spontaneities, dispositions, or liabilities within. From time to time the centre of interest has been shifted to within the body, as in the "animism" of Stahl, in the "vitalism" of the school of Montpellier (end of 18th century), and in the "cellular pathology" of Virchow. A discussion of the inherent difficulty of

holding the balance fair between that which is "exopathic" in disease and that which is "endopathic" may be read in Virchow's article, "*Krankheitwesen und Krankheitsursachen*," written in reply to objections that the cellular pathology was inadequate. "What I wished to treat of in the *Cellular Pathology*," he says, "was the behaviour of the elements of the living body in the usual kinds of illness, or, to put it more briefly, the history of the elementary processes of disease. Upon that basis, it seemed to me, the doctrine of the nature of disease should be built. The respective causes I adverted to only now and then; thus I spoke of poisons, and even fungi had a place in the cellular pathology, although a very modest one. If the *Cellular Pathology* had ever pretended to be a general pathology it would have contained also the whole of ætiology." Thus far Professor Virchow writing in 1880. If we now turn to a text-book of the same date, which does bear the title of *General Pathology*, that of Professor Cohnheim, we find pathology defined as "an explanatory science which seeks (1) to discover the causes of disease, and (2) to ascertain the esoteric connexion subsisting among disease-manifestations." It is only (2) that forms the subject of Professor Cohnheim's two volumes; ætiology, he remarks, is absolutely without limits. It "comes into relation with" cosmical physics, meteorology, geology, sociology, chemistry, botany, and zoology; from these sciences it gets its subject-matter. In the general pathology of Cohnheim, accordingly, ætiology is omitted; and with it are omitted many of the problems underlying the philosophical systems of the past, which have "only an historical interest," as well as much of the natural history of disease. General pathology, he says, knows no other direction and no other order than physiology, "and accordingly we shall take up successively, and in the same order as physiology would take them, the pathology of the circulation, digestion, respiration, tissue-nutrition, and the like" (the pathology of the nervous system is not included in the two volumes). Without adducing other instances of eclecticisms in the contents of modern pathological text-books, it will be convenient to give a brief notice of the latest attempt at a philosophical scheme of diseases,—the *Elemente der Pathologie* of Rindfleisch, 1883.

There are certain groups of symptoms, says Rindfleisch, which recur with the uniformity of a type in the most various diseases, depending as they do upon one constant factor,—the human body and its structural and functional tendencies. The larger number of maladies do not arise autochthonously or "under a whole skin," they are generated by certain morbid causes; and it is the variety of causes that corresponds to the variety of disease-species, or to those ever-changing sequences and coexistences of symptoms in which the experienced eye of the practitioner learns to distinguish one disease from another. The morbid cause is an invasion upon the normal course of our life, usually a strong and forcible interference with the physical and chemical constitution of a particular part of the body. The disease as a whole stands for the effects of this interference, and these effects flow in part from the nature of the morbid cause and in part from the nature of the body which suffers. That which is uniform in these effects flows from the nature of the sick body; that which is various flows from the variety of morbid causes. It is above all the seat of the disease, its duration, the sequence and combinations of the type-groups of symptoms which are determined by the morbid cause. Only this varying element can be used to distinguish one disease from another. Therefore there is only one truly natural prin-

principle of subdividing diseases and only one point of view in special pathology from which the construction of a natural system may be approached,—namely, the ætiological principle of classification and the ætiological system. In each group of diseases, and in each individual disease, the causation has to be inquired into as closely as possible and described after the natural-history manner; we have to ask how and where the cause acts upon the organism, and finally to show how, from this action and from the reaction of the organism towards the same, we may explain those special features of disease and that special morbid process which are peculiar to each group of maladies or to each malady individually. In a word, the *species morbi* are made by the morbid causes; all that separates one disease from another is contained in the cause; only the causal differences, and no other, furnish those units of disease-life which can be brought under genera and species.

If we now inquire into the categories of causation, according to Rindfleisch, we find that they are five in number, as were the categories of Paracelsus. They are (1) injury from without, (2) parasitism, (3) deficient rudiments and defective growth, (4) over-exertion, and (5) premature involution or obsolescence. It is impossible not to discover heterogeneous elements in this enumeration; it is a composite catalogue like that of Paracelsus, and we shall find it hard to say in the case of (3) and (5) whether we are dealing with the *ens morbi* or with the *agens morbi*.

A statement of the definition and scope of pathology similar to that of Rindfleisch had been given by John Simon in his *Lectures on General Pathology*. Diseases were for the most part the normal phenomena of life under abnormal circumstances. "When you know the whole case you are obliged to admit that, according to the normal constitution of the body, the symptoms in question ought to have followed the operation of those several causes." The doctrine of disease, accordingly, is mostly an "exopathic" one, although a small residue of it may be "autopathic." It is impossible, says Simon, absolutely to exclude autopathic diseased states; there may be some such, mostly developmental, which "are actual caprices and spontaneities of life, without any exterior causation whatsoever."

The exopathic point of view may be said to be the dominant one at present; more particularly, it is from the ætiological side that the enormous aggregate of contagious and infective sickness is mostly studied. Thus in the nosology of Rindfleisch the whole of the specific fevers and infections (including even climatic fevers) are placed (tentatively) under the head of "Parasitism," the parasites being minute living organisms having their independent place in the scale of being. The numerous researches of the parasitic school may be regarded as the most formal attempt as yet made to separate the study of the *agens morbi* from that of the *ens morbi*.<sup>1</sup>

## § 2.—INTRODUCTION.

The plan of this article will be to take diseases as they occur in the concrete, and to apply an analytical method to them. In a given disease, or in an individual case of the same, the object would be to find the point of divergence from the beaten path of health, or, failing that, to seek out the nearest analogies in the physiological life for the unaccustomed and even grotesque things of disease. The effects of disease in man's body may be likened, in a too pleasing figure, to the effects of a magician's wand: there is

"nothing of him but is changed into something rich and strange." This fascinating region of science is well outlined by Buckle in his remarks on the genius of Hunter:—

"In nature, nothing is really irregular or disorderly; if we are apt to fancy that the chain is broken, it is only because we cannot see every link in it. . . . Being satisfied that everything which happens in the material world is so connected and bound up with its antecedents as to be the inevitable result of what had previously occurred, Hunter looked with a true philosophical eye at the strangest and most capricious shapes. To him they were neither strange nor capricious. They were deviations from the natural course; but it was a fundamental tenet of his philosophy that nature, even in the midst of her deviations, still retains her regularity."

Hunter's own words are: "Nature is always uniform in her operations, and, when she deviates, is still regular in her deviations. . . . It certainly may be laid down as one of the principles or laws of nature to deviate under certain circumstances." The interest of this science, says Buckle, "depends simply on the fact that, when it is completed, it will explain the aberrations of the whole organic world." The same science of deviations was provided for by Bacon in his classification of the sciences; and, after him, by D'Alembert, under the head of "Prodigies, or deviations from the usual course of nature," in his classification for the *Encyclopédie*.

The science of deviations begins, in the writings of Hunter and of Paget, with the erratic forms of crystals, and with the indwelling power of crystals to repair injuries on the lines of their growth if they be placed in the proper mother-liquor. In the hands of each of these two pathologists this science next proceeds to elemental aberrations in the life of plants, where there is neither heart nor nervous system to complicate matters; and, so advancing from the simpler to the more complex, we should have a science of the abnormal coextensive with life itself. Without attempting to treat of pathology in that evolutionary order, which proceeds from elemental pathology upwards, we may still adopt, for the narrower subject of human pathology, a somewhat analogous order, that is to say, a method based upon the facts of embryonic development. Confining our attention, then, to the processes of disease within the human body, and seeking out from among these the broadest of the facts, we shall find evidence, as we proceed, that the life of the body retains vividly the memories of its past. Nothing marks so generally the disease-incidents of life as crudity or recrudescence in the activities of cells, tissues, organs, and mechanisms. In other words, we shall find much in pathology to show that, when the organism goes wrong, it retreats to broader ground, or reverts to modes of life which it had come through. But, even in the normal functional and structural processes of the mature body, we find occasional evidences of the same reversion to embryonic modes of life. These are practically limited, in health, to the reproductive system, or to that part of life which goes to the maintenance of the species. Here we find *periodicity* still in full force, the same periodicity, primarily following the seasons, which underlies the life of plants and of most animals. The greatest example in the human body is the building up anew, from time to time, of an entire organ, the placenta, for the intra-uterine nourishment of the child; in this periodical formation we have a reversion, in the midst of mature life, to vessel-making and blood-making such as the body goes through otherwise only during its development. The provision for the nourishment of the child after it is born is a somewhat modified instance of the same kind. The full structure and function of the breast also develop periodically (although the framework is permanent), and each of these periodical developments is a repetition of the incidents in the original embryonic development of structure and function.

<sup>1</sup> *Literature*.—Häser, *Lehrbuch der Geschichte der Medicin und der epidemischen Krankheiten*, 3d ed., 3 vols., Jena, 1876-82; Virchow, "Krankheitswesen und Krankheitsursachen," in *Virchow's Archiv*, vol. Ixix., 1880; Cohnheim, *Vorlesungen über Allgemeine Pathologie*, 2 vols., Berlin, 1877-80; Rindfleisch, *Die Elemente der Pathologie, ein natürlicher Grundriss der wissenschaftlichen Medicin*, Leipzig, 1888; Simon, *Lectures on General Pathology*, London, 1860.

It is when we come to the several tissues that we meet with the most striking reminders of persisting developmental characters, the most universal fact of the kind being the indwelling embryonic character of the common binding tissue. In that tissue, indeed, we have a constant reminder that in the midst of the very highest or most perfected modes of cellular life we are but a step removed from the most rudimentary. Thus in the brain and in the retina the elaborate nervous mechanism is supported on a framework of connective tissue; there is a morbid condition of these organs, called glioma, in which the connective tissue, or neuroglia, absolutely usurps the place of the nervous mechanism of which it is ordinarily the mechanical support; and this it may so completely do, as in disease of the pons Varolii, that even the outward form and markings of the part are not interfered with. An equally striking instance of a return to embryonic characters and predominance may sometimes be observed in the primitive nuclei of muscle; the muscle-fibres will be found to have surrendered their high function, to have retraced the steps of their development, and to have sunk their identity in a rudimentary form of cell-life.

Thus the body nowhere loses altogether the memory of the past, even when the periods of development and growth are, strictly speaking, ended. Among the normal processes of mature life there are such as amount to a recrudescence of structure and function; and an analogous recrudescence in the tissues is one of the most fundamental facts in the processes of disease. There are several advantages in proceeding in an exposition of pathological principles from this evolutionary or developmental basis. It enables us to take up, in an order not unsuited to their importance, the sections relating to repair, to new growth of tumours, to errors of growth, such as rickets, to errors of blood-making, and the like. At the outset comes the process of repair, for which Paget has formulated the embryological principle as follows: "The powers for development from the embryo are identical with those exercised for the restoration from injuries; in other words, the powers are the same by which perfection is first achieved, and by which, when lost, it is recovered."

### § 3.—THE PROCESS OF REPAIR.

The spontaneity of certain polyps under injury is a good example of the indwelling power of all the cells and tissues to return to the established order, to the order and harmony which had been slowly acquired, and of which the memory is, vividly retained. Trembley cut a hydra longitudinally, and "in an hour or less," says Paget, "each half had rolled itself and seamed up its cut edges so as to be a perfect hydra. He split them into four; he quartered them; he cut them into as many pieces as he could; and nearly every piece became a perfect hydra. He slit one into seven pieces, leaving them all connected by the tail, and the hydra became seven-headed, and he saw all the heads eating at the same time. He cut off the seven heads and, hydra-like, they sprang forth again." The recovery of perfection may be more gradual. Thus, Sir J. G. Dalyell (as quoted by the same writer) cut a specimen of *Hydra tuba* in halves; each half regained the perfect form, but only very slowly, and, as it were, by a gradual improvement of parts that were at first ill formed. In *Tubularia indivisa*, after the natural fall of its head, the stem was slit for a short distance down; an imperfect head was first produced, at right angles to the stem, from one portion of the cleft; "after its fall another and more nearly perfect one was regenerated, and, as it grew, improved yet more. A third appeared, and then a fourth, which was yet more nearly perfect, though the stem was thick and the tentacles imperfect. The cleft was almost

healed, and now a fifth head was formed, quite perfect; and after it, as perfectly, a sixth and a seventh head. All these were produced in fifteen months." This spontaneity resides in every living thing, and its efforts are directed by the memory of what the species had come through in reaching its place in the scale of organization; it is able, indeed, to make perfect reparation for injuries or losses only where the cells are little differentiated into tissues, or where the tissues are little specialized for diverse functions. In all animals, and most notably in the higher, this spontaneity is most effective for repair in the periods of development and growth. With reference to the degree of reparative power possessed, Paget formulates the rule as follows: "The amount of reparative power is in an inverse ratio to that of the development, or change of structure and mode of life, through which the animal has passed in its attainment of perfection, or on its way thitherward."

*Healing by Granulations.*—It will now be convenient to advance *in medias res*, and to give some account of the process of repair in man, where there is a breach of continuity in the course of the blood-carrying and lymph-carrying vessels, of the nerves, sinews, binding tissue, bone, fat, and skin. What is the effort that they each and all make to adapt themselves to the circumstances, in the case, let us say, of a stump after amputation? (The repair between the two ends of a broken bone will be discussed separately.) Disregarding the cases where the most perfect coaptation of parts is secured by the surgeon, and selecting the extreme case where the wound is "left to granulate," the following is the order of events. The divided vessels being sealed up either by ligature or by clots of blood (which are in the end absorbed), there oozes from the raw surface a blood-tinged serous-looking fluid. Becoming paler by degrees, it sets on the surface as a greyish-white film or glazing, especially on the exposed surface of muscle. The film of surface-glazing will be found to contain numerous corpuscles embedded in it resembling the colourless corpuscles of the blood. They have probably the same formative or reparative value as the granulation-cells proper, but it will appear from the facts about to be given that they are practically superseded by the latter in all cases where a wound is "left to granulate." After an interval of two or three days of apparent rest reddish points are seen on the edges of skin, on the muscular substance, and on the marrow of the bone; these are the beginnings of the granulation-tissue, which in the end covers the whole surface and grows until it fills up the gap somewhat beyond the level of the edges of skin. When the growth of granulations projects considerably beyond the skin it is known as "proud flesh." Usually the surface begins to skin over when the defect of substance has been sufficiently made good, the new skin showing as a delicate bluish border or frill to the old skin. This frill becomes broader and broader until the growing points meet in the centre, and the continuity of the skin is restored. Meanwhile the granulation-tissue beneath has been changing into more characteristic forms of mature tissue, although the *status quo antea* is never quite restored.

Notwithstanding the regularity of this process, and its daily occurrence in surgical practice, there is an almost incredible amount of conflicting opinion as to its details,—radical differences as to the sources or sources of the reparative material, and as to the mode of development of the new blood-vessels and of the new skin; and these differences of opinion must be the measure of the difficulty of analysis where the interference takes place in the highly complex and subtly integrated life of man. Direct observation of the reparative process does not of itself suffice to discover the law of it; it is necessary to seek elucidation from the nearest analogies, both among the regular processes of life and growth and among the deviations therefrom. Among the former there is in particular one rich source of analogous detail to be found in the periodical new formation on the surface of the uterus for the purposes of the embryo—in the placentas; among the latter are certain kinds of tumours and cysts. Hunter sought for a parallel to the new vessels of granulation-tissue in the first formation of vessels in the embryo; but these arise in the continuity of development, and not as a somewhat abrupt incident in the mature life. On the other hand, the formative process of the placenta is an example—and a unique example—of an extensive new growth of vascular tissue occurring periodically in the adult, and as somewhat of an interruption on the ordinary course of life. It matters little for this parallelism whether we accept the extreme position of Ercolani, that a total destruction of the uterine mucosa precedes the placental new growth, or whether we adopt the more likely view that the new formation takes place under an intact surface. In either case we have to do with a remarkable spontaneity of the body, a spontaneity which



reveals the indwelling power of the tissues, and especially the vessel-making power.

**Analogy of Placental new Formations.**—The first adaptations for the placenta are not in the pre-existing vessels, but in the pre-existing tissues around. The elongated and almost fibre-like cells become more plump, they join to form cylinders of nucleated protoplasm, the adjoining cylinders open out to form meshes between them, and all this takes place in the intervals between the vessels and their capillaries (fig. 1). The cells of the tissue return to that embryonic state which preceded the formation of blood-vessels, supplying their own juices, as it were, and opening out so as to form plasmatic canals in their midst. In the placental rudiment it is a mucus-like albuminous fluid that they mostly yield, but there is some evidence that they also yield blood-corpuscles. Meanwhile, the same process of enlargement has been taking place in the cells immediately surrounding the blood-vessels; and at a later stage it is the perivascular cells that keep up this activity (fig. 2). The phase of development in which the cells supply their own juices, retaining them in meshes of the tissue, is succeeded by a new formation of vessels, a more permanent provision. Certain tracts of cells are told off to form the walls of blood-vessels, the channel of the vessel being the space between two such adjoining tracts (fig. 3). These selected cylinders of cells become the new and enlarged system of blood-vessels, adequate to the requirements of the part. In this placental process the original capillaries play a



FIG. 1.—a, uterine tissue at early stage of decidua; b, c, the same at later stages.

very subordinate part; the thin cell-plates that form their walls are far outrun in the hyperplastic race by the cells of the tissues around, and it is the latter which furnish the materials for the new vessels. That which distinguishes the placental new formation is the enormous thickness of the walls of the new vessels and their terminal capillary loops. It remains to consider whether this placental new formation of vascular tissue—the only instance of the kind in the ordinary course of adult life—offers any help to the understanding of granulation-tissue.

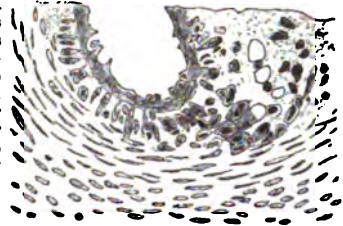

FIG. 2.—From deeper part of placenta (guinea-pig), showing active cell-growth in and around the wall of a vessel.

**Tendon in a Granulating Stump.**—It is at once evident that the tissues of a stump after amputation have a very unequal value for formative purposes, and probably all of them a lower value than the uterine tissue, which is at no time far removed from embryonic characters. This inequality is seen in the order in which granulations appear—first on the vascular layer of the skin, on the ends of muscle, and on the marrow of bone, and last on the ends of tendon. The attempt of a severed tendon to cover itself with a cap of granulations is somewhat feeble, and its slowness gives us an opportunity of marking points of detail. Tendon consists of wavy bundles of fibres in close order, and in full-grown animals its cellular elements are reduced to small dimensions. They are thin plates folded round the bundles, presenting in the face view the appearance in a, fig. 4, and in the side view the appearance in b, fig. 4. In the granulating end of a tendon the appearance is that of c, fig. 4; the thin plates have become solid or cubical, and where



FIG. 3.—New formation of vessels in placenta (guinea-pig).

they have increased in number at the free end of the tendon they have lost their orderly arrangement; they have, in fact, become granulation-cells. The tendon has drawn upon its reserve of cells and placed them at the disposal of the reparative process. All the

other tissues of the part have already done the same, some much earlier and more extensively than others. Wherever capillaries are most numerous there the cellular activity is greatest, the cells nearest to the wall of the capillary becoming more plump or more embryonic. The cellular material for the purposes of repair is supplied first around the severed vessels (according to some it is even supplied from within the vessels in the form of colourless blood-corpuscles) of the highly vascular muscle, of the marrow of bone, and of the subcutaneous tissue, and ultimately even by the ends of the tendons. In the placental process the formative materials had been furnished much more evenly over the whole area.

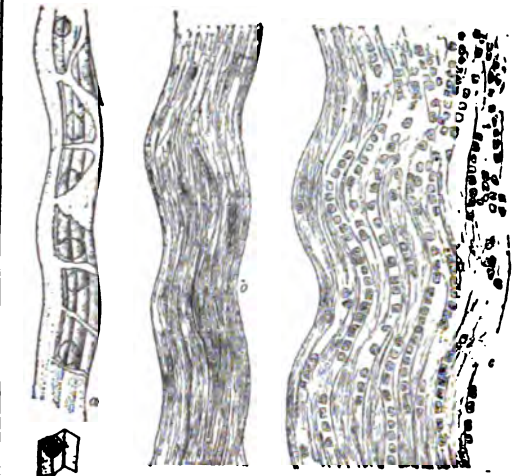

FIG. 4.—a, tendon-bundle covered by cell-plates, detached plate beneath (highly magnified, after Ranvier); b, ordinary appearance of normal tendon in section, the plates being seen in profile as linear thickenings; c, tendon from a granulating stump of the leg—the cell-plates have become cubical.

**Blood-vessels of Repair.**—The next step is towards the nutrition of the formative cells. Whether their nutrition is for a time plasmatic (as in fig. 1, from the placental growth) does not appear; about the third day the formative tissue begins to be furnished with numerous blood-vessels. Their formation is very difficult to observe in young granulations; in older granulation-tissue they have the appearance drawn in fig. 5, a series of parallel tubes making straight for the surface, ramifying on the same, joining by numerous loops near the surface, and of unequal calibre throughout their course, being widest on or near the surface. These vessels are different in several respects from the vessels in a vascular area of the normal organism of corresponding extent, unless it be in the decidua uterina. They are not branching arterioles ending in a fine capillary network, but they are of somewhat uniform and exceedingly simple structure throughout, and their calibre is often greater at the distal than at the proximal end. We have next to consider how these vessels have originated.

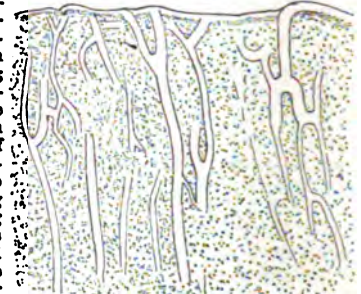

FIG. 5.—Blood-vessels in the surface-layer of chronic granulations.

The youngest granulations that can be prepared for examination consist of a uniform mass of cells, mostly round, and of somewhat wide vascular channels separated from the mass of cells by thin walls of more elongated cells (fig. 6). The most probable analogy for these new and wide vessels is not the embryo nor the tadpole's tail, but the placenta; that is to say, certain of the cells along predetermined lines agminate to form the opposite sides of a tube, becoming adapted in shape to that end (fig. 3). According to Ellroth, there is hardly ever in granulations an extension of the pre-existing capillaries by outgrowth of branching cells from their walls such

very subordinate part; the thin cell-plates that form their walls are far outrun in the hyperplastic race by the cells of the tissues around, and it is the latter which furnish the materials for the new vessels. That which distinguishes the placental new formation is the enormous thickness of the walls of the new vessels and their terminal capillary loops. It remains to consider whether this placental new formation of vascular tissue—the only instance of the kind in the ordinary course of adult life—offers any help to the understanding of granulation-tissue.



as may be observed in the tadpole's tail (*Untersuchungen über die Entwicklung der Blutgefäße*, Berlin, 1856, p. 30); and the circumstances are so little analogous in the two cases that this statement may be readily credited. How the new vessels join on to the old is not easily made out, whether in the placenta or in granulations.

As the granulations get older, the vessels acquire a considerable longitudinal coat of spindle-cells.

The individual granulation-points on the surface cells are spaces bounded by rows of flattened cells. (After Billroth.)

As the granulations get older, the lower layers contract as the cells approximate to fibrous tissue, and skin begins to form on the surface. If a healed surface be examined long after, in microscopic sections through the skin and subjacent tissue, the parallel vessels will still be observed running at intervals towards the surface, only more obliquely than in the granulation-tissue. They are invested by a certain quantity of fibrous tissue arranged parallel to their course, while all the rest of the space between two of them is occupied by horizontal lines of fibrous tissue, with spindle-shaped cells lying regularly among the bunules. This change has been, first of spherical granulation-cells into spindle-shaped cells, with development of intercellular or perinuclear substance (fig. 7), and then fibrillation of the latter. It is worthy of note that a development into elastic fibres goes on in the scar for months or even years after healing is complete. Hairs, hair-follicles, and sebaceous glands are not reproduced in the skin of scars, nor are sweat-glands. On the other hand, fat develops readily in the usual situations.

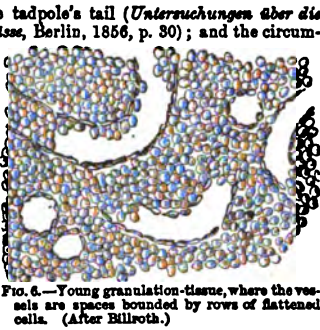

FIG. 6.—Young granulation-tissue, where the vessel-points on the surface cells are spaces bounded by rows of flattened cells. (After Billroth.)

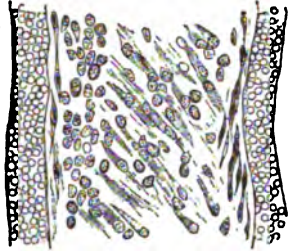

FIG. 7.—Vessels of granulation-tissue, their walls invested by longitudinal spindle-cells; the interval occupied by round cells or transverse spindle-cells.

**Suppuration & Repair.**—Meanwhile there has been a remarkable concomitant of the growth and adaptation of the reparative material, namely, a flow of pus or matter from the surface. Matter or pus varies in its physical characters somewhat; it may be creamy and yellowish-white (*pus laudabilis*) or greenish-white, or it may be thin and watery or more viscid. It has an alkaline reaction and a faintly sweetish odour. Standing in a vessel, it separates into two parts,—a supernatant fluid or serosity, clear, and of a yellowish tint, and a sediment of pus-cells. The serum coagulates when boiled, and it may even happen that a fibrinous clot forms in pus after death, just as in drawn blood. The serum of pus contains from 1 to 4 per cent. of albumen, and very much the same salts as blood-serum. The cells of pus are spherical elements of somewhat uniform size, of the greyish colour of protoplasm, granular on the surface, and disclosing the presence of two, three, or four nuclei when treated with acetic acid (fig. 8). They are capable of amoeboid movements, and they may be seen to take into their substance such particles as charcoal with which the wound may be dressed.

**Physiological Analogy of Pus.**—Pus is a very remarkable adjunct of the reparative process—to go no farther into the inflammatory processes for the present. The pus-cells are evidently a condition or product of the granulation-cells on the extremities and sides of the vascular out-growths, and they are detached from these situations, carrying with them a certain amount of fluid. Is there anything analogous to this in other formative processes of the body? The following analogy is very close in some at least of the circumstances. The interior of a cyst removed by operation from the neck region is found to be covered with vascular tufts, which have precisely the character of granulations as regards the blood-vessels. Each vascular tuft is covered by a cap of cells like a granulation, and the same investment of cells can be followed as a cylindrical column down the vessel into the depth of the cyst-wall. These cells are somewhat peculiar. They are cubical or polyhedral elements, with a



FIG. 8.—Pus-corpuscles. a, fresh; b, under acetic acid—the nuclei visible; c, blood-disks, to compare in size.

nucleus and a broad zone of protoplasm (fig. 9, a). On the summit and sides of a vascular tuft they are found becoming detached and disintegrated, the nucleus being cleft into fragments, which afterwards coalesce, while the cell-substance flows off in the form of spherical or oval or pear-shaped vesicles of a reddish tint (fig. 9, b). The cyst is a blood-cyst,—its contents, a clear brownish fluid with many red blood-disks floating in it, having been produced by the disintegration of the cells covering the vascular tufts. The cells are hematoblasts; their cell-substance is disengaged in drops which afterwards become red blood-disks, and their nucleus, after being cleft into several fragments of unequal size, is remade and survives as a cell of the size of a pus-cell, and containing several nuclei like a pus-cell (fig. 9, c). This



is a curious instance of blood-making from connective-tissue cells late in life, and it is not so much inexplicable in its characters as it is rare in its occurrence. The formation of pus on the granulations of repair is one of the commonest of incidents, but it is open to elucidation even by a rare analogy. In the one case a blood-like fluid is formed, and in the other pus; the fluid part of pus corresponds to the plasma together with the red blood-disks in the cyst, and the cellular part of pus, the pus-corpuscles, corresponds to the surviving but broken-up nucleus of the hematoblast. The granulation-cell is comparable to the perivascular cell of this blood-making process, and in passing into the condition of a pus-cell with several small nuclei it disengages merely a fluid plasma and no red blood-disks. The cells of the injured part having returned to an embryonic state, their first activity is a revival of early embryonic activity; if they do not make blood, they yield that which may be regarded as its substitute, namely, pus.

This analogy will appear all the closer from a consideration of another cyst. In this new growth, which occurred under the skin of the back, and was removed, like the former, by operation, the wall is lined by a certain thickness of tissue which is practically the same as the granulation-tissue of repair; there are the same parallel vessels ending in loops, the same cells, and the same deliquescence of the surface. The fluid in the cyst is indeed the result of this liquefaction—a somewhat turbid brownish fluid. In a small recess of the cyst there is a formation of a considerable layer of epidermal-like scales on the surface. One important point of difference is that the deeper layers of cells show no tendency to become spindle-shaped, to take a transverse order in the intervals between the parallel vessels, and so to become fibrous tissue. On the contrary, one finds in the depths of the tissue the stems of vessels surrounded by zones of young cells, perivascular sources of the new growth by which the loss of substance around the terminal loops of the vessels is constantly made good. On these terminal loops the process is not one of pus-formation, nor is it altogether one of blood-formation as in the former cyst; but it is an intermediate process which helps us still further to understand the significance of the pus in repair. The new formation is comparable to that of the blood-cyst in the obvious perivascular grouping of its cells, and it is comparable to the granulations of repair in the forms of its cells; and it thus supplies the link between the blood-yielding tufts of the former and the pus-yielding vascular points of the latter. What, then, is the nature of the deliquescence in the interior of this cyst? It is partly blood; and there may be seen also the large cells from whose protoplasm the blood-disks have been derived. There are also seen the remarkable cells with nucleus cleft into three or four, so like the cells of pus (fig. 10, b); the latter are the surviving nucleus of the hematoblast, the peculiar form of which is best explained by watching the more perfect process of blood-formation on the wall of the blood-cyst. Fewer of the cells in the second cyst undergo this transformation; fewer of them ever attain the perfect form of hematoblasts so as to be able to undergo it. For the most part they pursue a devious development, and it is in this that they resemble granulation-cells. The difference is only one of degree; the type or law of the process is the hematoblastic type, which may be more or less perfectly attained. We are accordingly confirmed in the impression that pus-cells are the surviving nuclei of embryonic cells whose perfect law is blood-making, and that the fluid which accompanies them is the cell-protoplasm which has failed to disengage itself in the form of individual buds that easily pass into red blood-disks, but has become a veritable albuminous fluid. Pus, then, may be said to be blood absolutely



FIG. 10.—a, large blood-yielding cells from the wall of a cyst; b, their nuclei surviving after the detachment of c, the red blood-disks.

wanting in red blood-disks, and with the colourless corpuscles in enormously disproportionate numbers. We shall afterwards see that there is a kind of blood—leucocythamic blood—which approximates to pus in these its essential characters.

That which distinguishes the process of repair from the formative process in the two cysts, and in all tumours whatsoever, is that the former is self-limited; after a time skin forms on the surface of the granulations, and the lower layers of cells pass into the resting condition of fibrous tissue. Each of these adaptations has now to be described.

**Formation of Skin on a Granulating Surface.**—The new skin appears as a delicate bluish frill extending gradually over the raw surface from the margin of the old skin. Nothing is more natural, therefore, than to suppose that it is a continuous growth from the cells of the rete mucosum of the old skin; and, according to the embryological dogma of an impassable gulf between the epiblast, mesoblast, and hypoblast for histogenetic purposes, the new epidermis can have no other source than proliferation from corresponding cells of the old. But, dogma apart, there is a radical difference of opinion as to the origin of the epidermic or epithelial cells on the surface of granulations. Notwithstanding the fact that the new epithelium springs up alongside the old, it has appeared to many observers with the microscope that it was derived, not from subdivision of the latter, but from the granulation-cells becoming flat and otherwise adapted to surface purposes. In considering these difficulties let us, as before, seek analogies among other formative incidents of mature life. In the first place it should be mentioned that the new skin may be peculiar. The accompanying figure (fig. 11) is drawn from a section through the



FIG. 11.—Loop-like arrangement of rete mucosum in the skin of a scar.

scar of an ulcer of the leg which had broken out and healed repeatedly. The peculiarity is that the epithelial cells are everywhere a narrow belt which bends down and encloses the terminal vessels as in a loop; in other words, the surface vessels are driven through the midst of the rete mucosum of the new skin. For an analogy to this epitheliation of granulation-tissue we may take the case of the cyst already referred to; it was covered in part with a thick layer of epidermic scales. The origin of these in the cyst is not difficult to trace; they are the granulation-cells enlarged, with two, three, or four nuclei, and with a more homogeneous protoplasm. The surface-layer is in fact largely made up of multinuclear blocks, some of which become excavated in their interior, while their nucleated periphery forms a narrow belt of surface-cells with a descending loop enclosing a space, in which collections of blood-corpuscles may sometimes be seen (fig. 12). If we imagine the plexus of vessels ramifying on the granulating surface to form communications with these excavations in the multinuclear blocks, we should be able to understand how it is that they are driven through the rete mucosum of a scar, as in fig. 11.



FIG. 12.—From surface of a cyst lined with epidermis; above, a continuous piece of the cyst-wall; below, individual multinuclear cells excavated.

**Giant-cells in Repair.**—These multinuclear blocks are the so-called *giant-cells*. Their occurrence in fungous granulations was described by Billroth (*op. cit.*, p. 32) in 1856, he having previously seen them in the granulations of bone and taken them to be elements "necessary for the new formation of vessels in osteophytes or in calua." The accompanying figure (fig. 13) shows several examples of them from the granulations of a slow-healing stump. Precisely the same forms occur in the wall of the cyst whose structure has been already referred to in order to illustrate the granulations of repair. But for these multinuclear blocks of tissue we have a clear physiological parallel in that unfeeling source of analogies for the formative processes of mature life, namely, the placenta. The accompanying

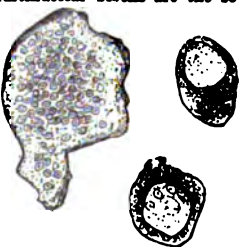

FIG. 13.—Giant-cells from chronic granulations.

examples (fig. 14) are drawn from the deepest layer of a discoid placenta (the guinea-pig's). Here it is evident that they result from the subdivision of a



FIG. 14.—Vaso-formative giant-cells from deeper layers of placenta (guinea-pig).

single nucleus within a growing cell of the inner muscular coat; and their place in the placental process is as clear as their histogenesis. They enter into the formation of the blood-sinuses of the deeper parts of the organ, sometimes forming a considerable part of the wall of a vessel by being excavated in their interior (the nuclei being driven to the side), at other times forming one side of a blood-channel, a corresponding multinuclear block forming the other, and the lumen of the vessel being the space between them. They represent a somewhat feebler continuation of those vaso-formative processes in the placenta which we have already used as the analogy for the production of the new vessels of granulations. That their function and significance in granulations is not wholly vaso-formative will appear from the fact of their co-operating to build up the surface epithelium.

**Conversion of Granulation-tissue into Scar-tissue.**—The skin of a scar is never perfect; it is always thin, wanting the descending processes and papillae of the natural skin, and wanting also the hair-follicles, hairs, sebaceous glands, and sweat-glands. Its blood-vessels never become the orderly capillary loops of the original type; they remain for a time as an extensive plexus of large vessels close to the surface, giving a recent scar its livid appearance; afterwards the channels of the vessels become narrower, and many of them quite occluded; and the scar has in the end a somewhat blanched appearance, which continues even when the surrounding skin is thrown into a state of ruddy glow. The underlying tissue, however, gradually acquires more of the natural type. If a section be made through an old scar it will be seen that the subcutaneous tissue is fibrillar and fibrous, with more or less of fat-cells. In the figure (fig. 15), drawn from a section

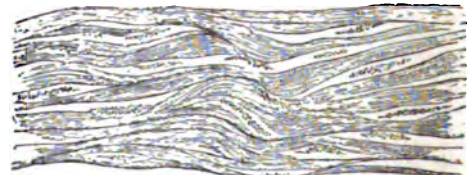

FIG. 15.—Scar-tissue of an ulcer of the leg which had broken out and healed repeatedly; spindle-cells with brown pigment in the interfibrillar spaces.

through the scar of an ulcer of the leg which had broken out and healed more than once, the tissue is composed of parallel wavy fibres, with spindle-cells between them at regular intervals, the cells having (as a characteristic of scar-tissue after repeated healing) brown pigment-grains in their substance. The successive changes which have led up to this horizontal fibrillation are not difficult to follow. While the ascending vessels acquire more and more of elongated cells on their walls, the granulation-cells in the intervals between them become extended horizontally or obliquely (see fig. 7), the spindle-cells among the fibrillar bundles in the figure being the surviving representatives of them. The change of the spherical cells into spindle-cells, which precedes the fibrillation, takes place first in the deepest or oldest stratum of the granulation-tissue, and it appears to be accompanied by a certain dragging down or obliquity of the vessels running to the surface. There is always a considerable thickness of spindle-cells parallel to the vessels, so that these, together with the horizontal tracts between the vessels, make up a kind of warp and woof. But as the scar-tissue matures the horizontal bands come to overshadow the vertical or oblique. The fibrillation takes place, as it does in ordinary growth, in an intercellular or perinuclear homogeneous protoplasm, which becomes more extensive as the embryonic or purely cellular character of the granulation-tissue fades. One of the most striking facts in this development of embryonic tissue into mature tissue in the adult is its shrinkage, corresponding to the well-known contraction of the area of a healing surface.

**Repair of a Broken Bone.**—The reparative process in bone is much simpler and it may be said to be much easier than in the healing of a stump. The bones retain even to old age the materials out of which new bone may be produced; these are the somewhat



embryonic membrane covering the bone, or the periosteum, and the marrow. During the growing period these two tissues retain pronounced embryonic characters, and at all times they take on a formative action readily. However unlikely an object, then, a bone may seem for repair, it has within and around it the materials for a tolerably direct renewal of osseous substance. The most orderly or intelligible form of the reparative process is that seen in animals. A long bone, such as the tibia or shin-bone, after having been broken and carefully set, presents an appearance such as is drawn in the figure (fig. 16, a). Opposite the line of fracture there is a fusiform thickening all round the bone, which is bulky and cartilaginous for a time, and afterwards becomes greatly reduced in extent, and, at the same time, osseous in its structure. It is called the callus. It will be convenient to describe the details of this process of repair from actual specimens of the tibia of a young frog which was found undergoing repair after fracture. The tibia, when cleared of the muscles, was found to have a spindle-like enlargement about its middle of the size and shape of an oat (fig. 16, b) and of a whitish colour. It was easily cut up into sections passing through its whole length as well as through the projecting ends of the spindle representing the normal shaft of the bone (fig. 17). The bulk of this fusiform enlargement is made up of cartilage developed between the upraised periosteum and the dense substance of the bone. But there is another and independent new-formed mass projecting from the canal of the bone, and clearly marked off from the wide extent of cartilage around it,—this is the direct osseous formation from the marrow. The cartilage has been produced from the periosteum, each spindle-cell of the latter altering its form and developing a disproportionate amount of cell-substance, which becomes the hyaline matrix of the cartilage, while the nucleus of the original cell, generally excavated or reduced to a crescentic shape, remains as the cartilage-cell. From this cartilage, again, bone is formed very much as it is formed from the central rod of cartilage in the fetal bone, and it also resembles the latter in being formed only to be reabsorbed. In these preparations from the frog, narrow spicules of bone may be seen starting from the thin end of the spindle and spreading over the surface of the cartilaginous callus. In the deeper strata of the latter, and still at the thin end of the spindle, the cartilage-cells group themselves round the walls of alveolar spaces, as in the ossification of epiphyseal cartilage, and that is doubtless the process which extends throughout the whole mass of cartilage. Meanwhile there has arisen a fungus-like protrusion of new bone from the medullary canal of the bone; it lines the inner walls of the medullary cavity for a short distance up from the line of



FIG. 16.—a, broken tibia of a dog undergoing repair, ensheathing ring of cartilage-callus opposite the fracture (from Paget); b, tibia of a young frog with fusiform thickening of cartilage covering a fracture.

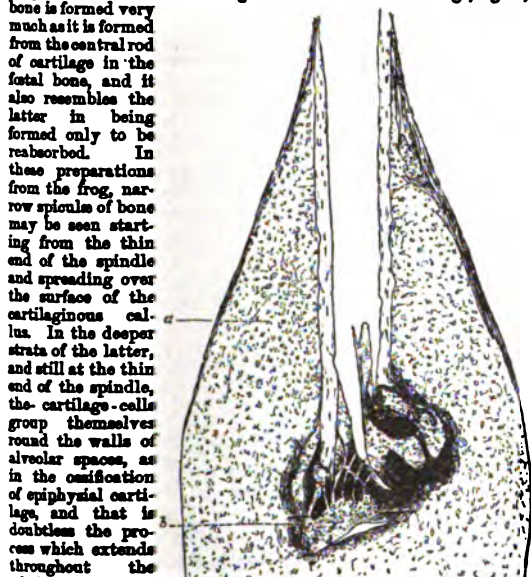

FIG. 17.—Section through broken tibia of a young frog,—upper fragment, a, ensheathing callus (cartilage) between periosteum and shaft; b, intermediate callus (bone), growing from the callus and vessels of the marrow.

from the medullary canal of the bone; it lines the inner walls of the medullary cavity for a short distance up from the line of

fracture, and projects for a greater distance into the midst of the cartilaginous callus. This centre of ossification is intimately connected with the blood-vessels of the marrow; they form the framework of the osseous growth, the embryonic marrow-cells (themselves the lineal descendants of cartilage-cells) becoming the osteoblasts or future bone-corpuscles. The whole of the new growth of bone is ultimately moulded into a more compact form; but the seat of an old fracture will always retain a certain roughness of exterior, and a certain want of regularity in its Haversian system.

The repair of bone in man is not altogether the same as in animals; the ensheathing cartilage is not usually found except in broken ribs, and the uniting osseous substance corresponds mostly to that part of the new bone (in the preparation from the frog) which issues from the medullary cavity in association with the blood-vessels of the marrow. The callus in man is accordingly said to be chiefly "intermediate", or between the broken ends, and partly also "interior", or extending into the medullary canal; and it is naturally permanent and not subject to removal like the "ensheathing" callus developed from cartilage. But the sources of new bone in man depend upon the amount of displacement of the broken ends; if the displacement be very considerable, the connective tissues around may be drawn upon for bone-forming materials, their cells becoming embryonic in form and ultimately osteoblasts. Comparing the repair of a bone with the repair of soft parts, the former is much more direct; the osteoblastic tendency or memory is strong in the tissues within and around a bone, above all in the periosteum and in the young or red marrow; and true osseous union is readily effected except in such fractures as the neck of the thigh-bone and the knee-cap, where the union is often merely ligamentous or fibrous. In the "greenstick" fractures of children the periosteum is still a succulent layer engaged in the natural growth of the bones, and there is reason to suppose that it is the chief source of whatever reparative materials may be needed.

**Repair of Nerves and Muscles.**—When a nerve, such as the ulnar, is divided by a cut near the wrist, sensibility is lost over the area of skin to which the nerve is distributed, and, under ordinary circumstances, it is restored in about three weeks. The severed ends of the nerve are joined by a band of tissue, which has been proved by examination of it at various stages of the reparative process in animals to be at first composed of embryonic spindle-cells arranged in the line of the nerve-bundles (fig. 18); these cells are derived from the nuclei of the neurolemma, they pass through the original embryonic phases, and ultimately become more or less perfect nerve-tubes filling the gap in the divided nerve,—a gap which may be a quarter or half an inch in length. In muscle, also, a corresponding process is described; but the repair of a ruptured muscle such as the rectus extensor of the thigh is commonly fibrous only, and the gap can be felt even through the skin.<sup>1</sup>



FIG. 18.—R, paired nerve (frog) ten weeks after section; spindle-celled tissue replacing nerve-tubes. (From Billroth, after Hjelt.)

§ 4.—ERRORS OF EMBRYOLOGICAL GROWTH IN CERTAIN TISSUES—MESOBLASTIC TUMOURS.

No chapter or section treating of tumours as a whole can be homogeneous; and, in order to preserve the developmental or evolutionary order already sketched, it will be convenient to consider here only a part of the morbid processes which result in tumours, leaving the rest to be introduced at appropriate points in the sequel. The disadvantage of applying the developmental or embryological idea to all tumours whatsoever comes out in the tumour-hypothesis of Cohnheim. According to that hypothesis, the tumours of the body are due to the awakened growth of small centres or foci of embryonic tissue which had

<sup>1</sup> Literature.—Paget, *Lectures on Surgical Pathology*, 4th ed., Lond., 1876; Darwin, *Animals and Plants under Domestication*, vol. II, chap. xxvii., new ed., Lond., 1882; Billroth, *Ueber die Entwicklung der Blutgefäße*, &c., Berlin, 1856; id., in *Beiträge zur pathol. Histol.*, Berlin, 1858, and in his *Allgem. Chirurg. Pathol.* (Engl. transl.); Ziegler, *Untersuch. über pathol. Bindegewebe und Gefässenbildung*, Würzburg, 1876, and in his *Pathol. Anat. und Pathogenese*, Jena, 1880-84 (Engl. transl.); Rindfleisch, *Lehrbuch der pathol. Geradenlehre* (Engl. transl., 1872-73); Golding Bird, "Constructive Inflammation and Ulcers," in *Guy's Hosp. Reports*, vol. xiv., 1879, p. 525.

remained over from the foetal development, persisting in their embryonic characters while all else around them had assumed the characters of maturity. For the arguments and illustrations of this hypothesis the reader may refer to the section beginning at p. 622, vol. i., of Cohnheim's *Vorlesungen über allgemeine Pathologie*. It must suffice to say here that groups of resting embryonic cells in the various organs and parts of the body, or embryonic rudiments in the sense of Cohnheim, are not known to exist at all generally. That which we are well assured of is an indwelling power of all the mesoblastic tissues to revert to embryonic characters,—the spontaneity of the tissues never quite worn out, or the memory of development more or less deeply rooted in them to the end of life. From this point of view we have traced the process of repair, finding a developmental analogy even for pus. From the same point of view we have now to consider certain kinds of new formation as arising, not to make good defects, but under an erratic impulse, or in the course of an erratic spontaneity. Congenital tumours have always been regarded as errors of development, and it will be convenient to select a simple congenital tumour to begin with.

**Fibroma.**—The texture drawn in the figure (fig. 19) occurred in a tumour of the back of the neck in a young child having been there since birth. It is a *fibroma*, and consists essentially of bundles of wavy fibres crossing or decussating in direction, sometimes thick bundles, sometimes only a few strands, the whole forming a dense warp-and-woof texture, with embryonic nuclei; bundles of fibres seen also in cross-section. The peculiarity is that such a tissue should have formed under the skin as a tumour or lump the size of a hen's egg; spread out in thin layers, the same warp-and-woof texture of fibres occurs naturally in the aponeuroses and the sheaths of muscles, and in other fibrous membranes, such as the dura mater; and the large number of nuclei among the fibres, as shown in the figure, would be appropriate to the fibrous tissue at the early period of life to which the tumour belonged. At various centres these embryonic cells had developed into fat-cells, so that the tumour may be called a fibro-lipoma. The tissue has increased in three dimensions, and so has resulted in a palpably distinct object in the body, which could be dissected out from among the surrounding structures as an individual thing. The overgrowth had taken place probably in one of the aponeuroses of the trapezius muscle, and the noteworthy point is that it has faithfully adhered to the warp-and-woof texture proper to the tissue on which it is based. The new formation possesses length, breadth, and thickness, and its fibres are interwoven in the three dimensions as if it had been constructed at some unusual kind of loom. The same interlacing of bundles of wavy fibres is found very commonly in the fibromata,—their favourite seats, besides the flat fibrous sheaths, aponeuroses, and membranes, being the uterus and its appendages, where the tumours may be stalked or sessile. Sometimes the fibres are concentrically arranged round a number of centres, or the bundles may pursue a sinuous course.

One variety may be specially mentioned as exemplifying a modification of fibrous structure which is often met with in various normal and pathological processes. In this modification the fibres become as if fused into broader homogeneous bundles, the nuclei being left lying as if in spaces or holes in a structureless

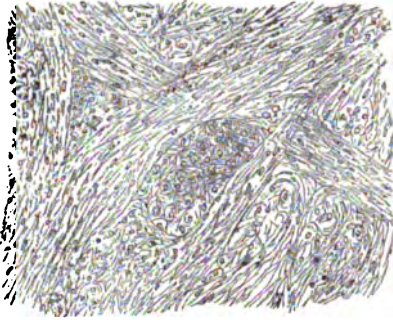

FIG. 19.—Congenital fibroma from a child's back; warp-and-woof texture, with embryonic nuclei; bundles of fibres seen also in cross-section.

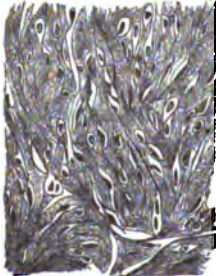

FIG. 20.—Recurrent ossifying fibroma of lower jaw.

ground-substance. This variety of fibroma is generally found in the bones of the jaws; it may be ossified at some points, the nuclei becoming the bone-corpuscles, and the homogeneous ground-substance becoming impregnated with the earthy substance of bone. The accompanying figure (fig. 20) is drawn from a preparation of a fibrous tumour, ossified in part, within the medullary space of the lower jaw in an adult. It had been removed once, and grew again (recurrent fibroma or fibroid).

Where the modification takes the direction of an increase of the cells at the expense of the fibres, we have a *fibro-cellular* tumour. The tumour is composed of elongated elements, which are virtually nucleated cells with very long bodies, amounting almost to fibres. The figure (fig. 21) is made from an extensive tumour deeply seated in the carotid region of the neck in a woman aged twenty-two.

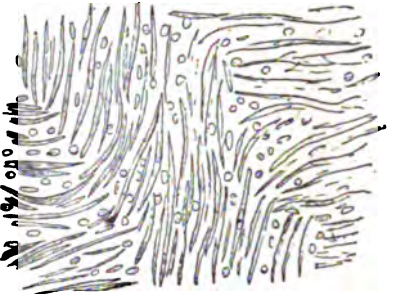

FIG. 21.—Fibro-cellular tumour; decussating bundles.

There is nothing more remarkable in all these varieties of tumour than the constancy of the warp-and-woof texture, and we shall find that the same is an important characteristic of the class of tumours where the fibrous structure is wanting and everything becomes cellular.

Tumours of the latter kind form the group of *sarcomata* or flesh-like tumours. Proceeding from the fibro-cellular tumour last mentioned and sketched, we come to the variety of *spindle-celled sarcoma*, in which the cells differ from the fibro-cellular elements of the former, chiefly in the greater prominence of the nucleus and the greater delicacy of the tapering prolongation of cell-substance. It is sometimes called a small spindle-celled sarcoma. The figure (fig. 22) shows the structure to be purely cellular, without any fibrous supporting tissue. In the cross-section the spindle-cell appears as a small round cell.

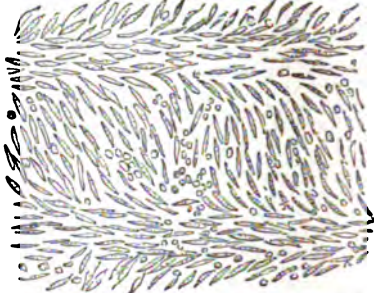

FIG. 22.—Tumour composed of small spindle-cells in decussating bundles.

In the *sarcoma with large spindle-cells* we have a form of tumour not uncommon in certain regions of the body, often associated with brown pigmentation, and very generally malignant in its course.

One common seat of it is the choroid coat of the eye, where large pigmented cells, both spindle-shaped and branched, exist naturally. Another common seat is the subcutaneous tissue, where pigmentation is not a normal occurrence. The illustration (fig. 23) is taken from a case where there was, however, brown pigmentation of the skin for a considerable distance round the tumour. The situation was the shin, the common seat of chronic ulcers, and the tumour seemed to have begun in the scar-tissue of an ulcer of that kind. The cells are very large spindle-like elements grouped in decussating bundles, the distribution of pigment being partial (omitted entirely in the cut), and not uncommonly confined to the narrow bands of cells separating two broader or thicker bundles. The developmental or embryonic character of these cells is sufficiently obvious; but the occasion for their reappearance in mature life is not so clear. For the particular case of tumour over the shin

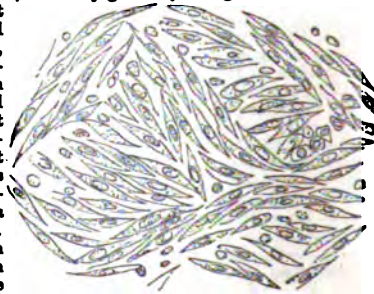

FIG. 23.—Tumour composed of large spindle-cells in decussating bundles.

The situation was the shin, the common seat of chronic ulcers, and the tumour seemed to have begun in the scar-tissue of an ulcer of that kind. The cells are very large spindle-like elements grouped in decussating bundles, the distribution of pigment being partial (omitted entirely in the cut), and not uncommonly confined to the narrow bands of cells separating two broader or thicker bundles. The developmental or embryonic character of these cells is sufficiently obvious; but the occasion for their reappearance in mature life is not so clear. For the particular case of tumour over the shin



the following may be conjectured. In the pigmented scar of an old ulcer of the same region the subcutaneous fibrillar tissue is found to be thickly occupied with large spindle-cells full of brown pigment granules (see fig. 15). Now, the skin for some distance round the tumour in question had precisely the brown pigmentation of a scar that had re-formed repeatedly, and the brown colour resided presumably in the same embryonic elements as are drawn in fig. 15. It cannot be supposed, however, that that explanation applies to all spindle-celled sarcomas with pigment, even if we do not include those of the choroid tunic of the eye. A more general explanation must be sought for the pigmentation, which will apply also to the pigment in scar-tissue itself.

**Cystic Sarcoma.**—The activity of tumours, even of those classes that we have hitherto considered, is not purely structural or formative; it may be obviously functional, involving an instability of the structure. Even the fibrous tumours may become cystic in their interior, as notably in the case of fibroids of the uterus; and it may be stated generally that all such traces of cyst-formation in solid masses of embryonic tissue are so many traces of the deeply-rooted embryonic function of those tissues. This important principle of tumour pathology may be conveniently introduced through a particular case of spindle-celled sarcoma, which grew to a great size on the outer side of the thigh of a boy aged fifteen, having its root deep down in the interval between the tensor fasciæ muscle and the vastus externus. In no part of this tumour were traces wanting of an embryonic function residing in its component cells. Although the section of the tumour was close and firm, yet one found under the microscope the appearance drawn in the figure (fig. 24). The tracts of spindle-celled tissue are interrupted by spaces lined by cubical cells, which are the surface-modification of the spindle-cells. These are the blood-spaces of the tumour, and blood is to be seen in them here and there. Where



FIG. 24.—Sarcomatous tumour growing from the inter-muscular septum of the thigh; spaces lined by cubical epithelial-like cells.

tensive the spaces have formed communications, and left the spindle-celled tissue projecting into them as free cylinders or columns, with rounded ends covered with the same cubical epithelial-like elements. A central area of the tumour was more spongy in consistence; and that character is found to depend upon the greater development of the spaces, approaching remotely to a cystic development. It is here that one sees the true physiological or embryological significance of the interstitial spaces, of their contents, and of the cubical cells round their walls. The surface-row of cubical cells loosen from their attachment, fall into the space, and are succeeded by another row, which are detached in turn; and so the excavation proceeds at many centres. The detached cells do not remain free solid elements; they may sometimes change *in toto* into a mucous fluid, but their full physiological activity is the hematoblastic or blood-making. The spaces contain the hematoblastic cells and their derivatives in various forms. One may see the cubical cells on the margin of the space (fig. 24) acquiring a yellowish tint, then the same cells disengaged and lying free in the space and probably increased in size (fig. 25), then red blood-disks of the same colour as the protoplasm of the hematoblasts, and cells with several nuclei corresponding to those already described as the surviving nuclei of the disintegrated hematoblast, the whole lying in the midst of a mucus-like coagulum. This is neither more nor less than the early blood-making function of the mesoblast revived. The result is not by any means always or altogether blood, and in cysts it is indeed for the most part a mucous or serous fluid.

In one direction this process goes on to the ultimate destination of a *thin-walled cyst*; and the following case of spindle-celled sarcomatous tumour may be regarded as an interesting intermediate phase. The tumour is the size of an orange, from the neck region of a dog; the peculiarity of it is that it is excavated completely on the side next the skin, while the deeper half of the sphere is made up partly of a firm texture with alveoli or spaces lined by cubical cells, as already described, and partly of a beautiful interlacing system

of polished cylinders crossing the cavity from side to side, or hanging free into it. The process of excavation has merely been an extension of that drawn in fig. 24; it may be compared to the excavation of the heart in the embryo,—the columns carnesæ and muscûli papillares and pectinati of the latter corresponding to the columns and free projecting cylinders of the cyst. It is noteworthy that a trabeculated interior is characteristic of many cysts.

**Myxoma or Mucous Sarcoma.**—In another direction the hematoblastic softening process goes on to the variety of tumour called *myxoma* or *mucous sarcoma*; and this change may be actually observed in parts of the above-mentioned extensive spindle-celled sarcoma from the outer side of the thigh. A myxoma is that particular modification of embryonic mesoblast in which the softening or fluid disintegration takes place, not along definite or selected tracts, but uniformly over a particular area. The cells become excavated somewhat as in fat formation, the nucleus remaining at one side, and their thin membranous walls appearing as branching processes, which join with those of the next cell. Hence the nuclei often lie as if at nodal points of a meshwork of fibres, and they are often triangular or lozenge-shaped. This is one common form of myxomatous tissue. But the mucous transformation taking place in each individual cell may result in a tumour presenting a very different appearance. The figure (fig. 26) is taken from a soft gelatinous tumour of the subcutaneous tissue. Nothing could be more orderly than the grouping of its large mucus-yielding cells in rows following the wavy course of the bundles of fibres or fibrils; they are as regular as the cell-plates of tendon. Their origin can be traced to the fixed connective-tissue cells of the part, which have emerged from their inconspicuous state, and have acquired breadth and thickness, a cubical form, and mucus-yielding protoplasm. Precisely the same process may end in a cystic excavation. The relation of this change to the indwelling tendency of the mesoblastic cells towards blood-making is revealed in the actual hematoblastic character of the cells here and there, and in the blood-disks and cells with cleft nucleus lying around. Another intermediate or occasional form of the cells in this tumour reveals also the true affinities of spindle-cells filled with yellow or brown or black pigment. Such pigmented spindle-cells replace the mucous cells here and there; we must consider them to be also a somewhat devious development in the hematoblastic process, their pigment being practically the same as blood-pigment.

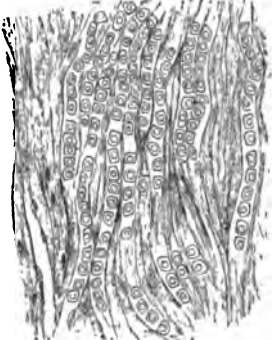

FIG. 26.—Mucous sarcoma of subcutaneous tissue (dog).

**Alveolar Sarcoma.**—In this connexion also we must take the kind of tumour that is often called *alveolar sarcoma*. The epithelial-like form of cell, which lines the spaces among the spindle-cells in the case already mentioned, now comes to predominate. The following is an instance, with figure (fig. 27).

A tumour the size of a large walnut, deeply pigmented, with the skin drawn tightly over it as if it had grown in the position of a mole or congenital mark, was removed from a man's leg. Although the tumour is somewhat black throughout, the pigment is found to reside only in certain narrow tracts or clusters of cells. The structure is divided into oblong or alveolar spaces by narrow bands of fibres, the cells within the spaces being all of the epithelial type. Some of the cells are much larger than others, and these largest elements are tinted bright yellow or brown. It is no great step from this singular structure to the embryonic structure and function of former cases. Instead of a few cells at a time forming an epithelial-like surface to an alveolar space (the great bulk of the tissue remaining as tracts and columns of spindle-cells), here the alveolation has been general through the whole area, and all the cells have become as if surface-cells. Furthermore, they have been fixed in that condition, proceeding to no further development, whether mucus-forming or blood-forming,—only certain groups of them, and these by far the largest and most epithelial-like, acquiring the yellow colour of hematoblasts, or a brown colour. The pigment is otherwise contained in spindle-cells which occupy the intervalveolar septa, and in them it is in a more granular form.



FIG. 27.—Melanotic alveolar sarcoma of subcutaneous tissue.

**Cavernous Blood-tumours.**—The pigmented alveolar sarcoma is sufficiently common in the situation of congenital mother-marks of the skin to be one of their characteristic developments. Another of their developments or equivalents is the *nevus* or *angioma* or *cavernous tumour*, whose structure may be said to consist, in general terms, of a spongy meshwork of alveolar spaces, bounded by coarse and elastic trabeculae and filled with blood. Arteries open into such tumours and veins pass out from them, the cavernous territory being intermediate; but, according to several authorities, this connexion with the circulation is not primary to the cavernous tumour but acquired. Without entering upon a discussion of details, the analogy of the alveolar sarcoma growing on the same basis of a congenital pigment-spot may be kept in view. The alveolation is the same in both cases, although the trabeculae in the cavernous tumour are somewhat stouter, the grand difference being in the contents. If, however, we suppose the epithelial-like cells of the alveolar sarcoma all to become large and filled with a yellowish colouring matter, as indeed many of them do, and if we suppose that these hematoblasts (for such they are) go on to fulfil their destiny, then we should have a cavernous *blood-tumour*, that is to say, the alveoli would be filled with red blood-corpuscles. It will not be possible to offer evidence of this process except for the cavernous blood-tumour of the liver, an organ in which such tumours are comparatively frequent, and mostly in later life. The cylinders of liver-cells appear to become narrower and narrower, as if from pressure of the capillaries, and ultimately to disappear. From the supporting tissue a new growth of cells takes place (fig. 28). These are hematoblasts; their protoplasm becomes red blood-disks, and their nucleus survives with the remarkable trefoil arrangement of cleavage which has been described for several other instances of the hematoblastic process. There can be no mistaking the identity of this process with that of the blood-cyst of the neck already mentioned; it is essentially a manifestation of hematoblastic function late in life, differing from that of the blood-cyst in the fact that the centres of blood-formation are separated from one another within alveolar boundaries. These cases illustrate another striking property of cavernous blood-tumours, namely, to heal spontaneously in parts or to develop embryonic scar-tissue through more or less of their extent (fig. 29, a). The ordinary cavernous texture of an angioma is produced by the formative process stopping short of embryonic connective tissue or scar-tissue. The accompanying figure (fig. 29, b) is from an enormous anglomeration



FIG. 28.—Hematoblastic process in cavernous growths of liver (dog). a, the supporting tissue producing hematoblasts b; c, nuclear remains of hematoblasts and red blood-disks side by side.



FIG. 29.—a, cicatricial tissue from cavernous tumour of liver (dog); b, meshwork occupied by red blood-disks, from cavernous tumour of head (ox).

tumour on the side of an ox's head; the structure is very like that of the young connective tissue of the former figure, except that the meshes are densely packed with red blood-corpuscles. There are, however, other parts of the tumour where the fibres are broader, the meshes narrower, and with embryonic cells lying in them, instead of or along with blood-corpuscles.

There is no definite limit between such cavernous blood-tumours and true blood-cysts; in the latter the numerous hematoblastic centres open communications, and the further process takes place in the cellular tissue forming the cyst-wall.

The blood-making office of the mesoblast is the earliest and greatest of the functions of embryonic cells, and it is not surprising that it should come out more or less obviously in those formative processes in the common binding tissue of the body where there is a persistence or revival of embryonic activity. We seem to find traces of it in the pigmentation, in the cystic excavation, in the alveolation, in the mucous or myxomatous transformation, and in the cavernous structure of mesoblastic new growths. The embryonic spontaneity in the middle layer is, of course, wider than mere blood-making; but the hematoblastic function or tendency is certainly the most fundamental, and the traces of it in the foregoing tumours are our best help towards a rational interpretation of them. Persisting or

revived embryonic activity in subcutaneous and other homologous tissues cannot but bring to light more or less of this all-important mesoblastic function; the memory of it is too strong to be ignored. We come next to a function of embryonic cells which is only second to the hematoblastic, namely, the osteoblastic or bone-making function; and even with the bone-making process the earlier blood-making process is deeply interwoven, for in the marrow of the bones the hematoblastic activity of cells persists long after it has ceased elsewhere.

The bone-making function of embryonic tissue—if function it may be called—comes into a large number of tumours; or, in other words, a large proportion of all mesoblastic tumours are *tumours of the bones*. In all of these the embryonic law of development and growth is clearly present. The results, however, are frequently more complex than in the tumours hitherto considered; or, in other words, tumours of the bones are exceedingly liable to have a structure so mixed as almost to baffle systematic description. One reason of this is that the osteoblastic and hematoblastic functions of embryonic cells go hand in hand in their production; and the complexity of structure is, accordingly, greatest in those which grow from that part of the bone where the blood-making resides, namely, the marrow. The other great formative tissue of bone is the periosteum, a tissue which retains its embryonic structural features long after the mesoblastic tissues elsewhere in the body have lost theirs. The marrow and the periosteum are frequently involved in the same tumour; or an essentially similar morbid product may be derived from either. That is notably the case with the tumours of the bones which we come to first, the cartilaginous tumours or enchondromata.

**Enchondrosis.**—It is only rarely that a cartilaginous tumour grows from cartilage, the observed instances having occurred at the cartilaginous lines of union of the base of the skull, at the epiphyseal lines in long bones, and in such permanent cartilages as those of the larynx and trachea. To these direct outgrowths of cartilage-cells Virchow has given the distinctive name of *enchondroses*. Usually the cartilaginous tumours do not grow from pre-existing cartilage; they grow either from the periosteum or the marrow of the bones, or they form in certain glandular organs, especially the salivary glands (parotid, labial, &c.), the mammary gland (oftenest in the dog), the lacrimal gland, the testis, &c. These latter enchondromata are a class apart, involving considerations of disordered everyday secretion rather than of the revival of embryonic activity (see "Errors of Secretion," p. 379 below). The enchondromata that fall to be considered here are those which grow within or upon the metacarpal bones and the finger-bones, more rarely in the corresponding bones of the foot, not frequently in the bones of the face, and, it may be, in the leg-bones and arm-bones, or in bone anywhere.

**Enchondroma.**—The simplest cases (but the least frequent) are those that form between the periosteum and the hard bone from the growth and transformation of the cells of the periosteum, being directly homologous to the ensheathing cartilage-callus of repair. They differ from the cartilage of repair in precisely the same way that a granulation-like sarcoma differs from the granulation-tissue of repair,—that is to say, the existence of the tissue is not self-limited, or it has no tendency, or only a feeble tendency, to cicatricial modification, shrinkage, or absorption. These purely subperiosteal enchondromata are said by Paget to be nearly characteristic of the ends of long bones, although they do not encroach on the articular cartilage. When a cartilaginous tumour occurs in the shaft of the bone it is partly subperiosteal and partly in the marrow; and in the most characteristic seat of enchondromata, the bones of the fingers, the growth is entirely in the marrow if the tumours are multiple; but, curiously enough, it is subperiosteal if there is only a single tumour (Paget). There are also cases where islands of cartilage form in the compact substance of the bones, corresponding to Haversian systems.

The tissue-affinities of a cartilaginous tumour growing between the periosteum and the hard bone are not difficult; the homologous, as we have said, is the callus-cartilage of repair. The histogenesis and physiological analogies of an enchondroma of the medullary canal of a bone are less easy. We know that the marrow was preceded, in the development, by a bluish rod of fetal cartilage, of which all characteristic traces had disappeared before birth. As the blood-vessels entered it, it had changed into a spongy kind of bone, in whose spaces lay many spherical nucleated cells retaining a hematoblastic or blood-making function; all the spongy bone is gradually absorbed in the shaft, the last traces of it being a few spicules on the hard inner wall of the medullary canal, and the cavity is occupied by a highly vascular substance, the red marrow characteristic of young bones. The spherical cells of the red marrow become excavated into fat-cells, and the red colour changes to yellow. It is probably in this final phase of the development inside the shaft of a bone that we must look for the opportunity of the central enchondromata forming. The secret of the return to cartilage in some cases, and at certain spots, probably lies in the change of red marrow into yellow; instead of becoming fat, it



becomes a kind of cartilage. The tumours in question are most common, at least, just at the time of life when that change in the character of the marrow takes place. Again, at the spongy ends of bones, where the marrow remains red, the internal enchondromata rarely occur (a case is quoted by Paget at the lower end of the fibula), but chiefly the subperiosteal. If the enchondromata were composed of a definite type of cartilage, and, above all, if they were stable in their structural characters, the relation of them to the marrow of bones, which these facts point to, would not be a very intelligible one. But the enchondromata are rather a kind of new growth in which there is a good deal of glisty substance of one kind or another, associated with a good deal of mucous or myxomatous tissue, with cystic spaces containing mucous or honey-like fluid, and even with blood-spaces. Besides the myxomatous tissue, there may also be tracts and areas of other soft tissue made up of spindle-cells, multinuclear cells, and various

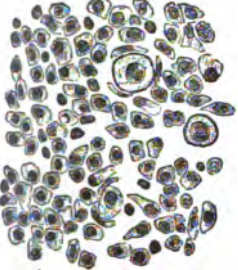

Fig. 30.

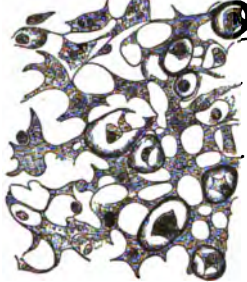

Fig. 31.

FIG. 30.—Fetal or parenchymatous cartilage from enchondroma of upper jaw (horse). (The hyaline intercellular substance is left out.)  
FIG. 31.—From enchondroma of upper jaw of woman; a few large cartilage-cells in a tissue consisting mostly of branched cells.

non-descript forms; and, most significant of all, there may be much of the cartilaginous substance quite fetal in its characters,—that is to say, consisting almost entirely of cells, with a small amount of more or less tough hyaline intercellular substance. Fig. 30 shows a highly cellular kind of cartilage from a tumour of the upper jaw of a horse. The next cut (fig. 31) is from a cartilaginous tumour of the upper jaw of a woman; it shows cartilage-cells with definite capsules, and surrounded by a kind of tissue which would be called myxomatous. The shades of difference among the tissues of enchondromata are indeed endless. They may be said to be all possibilities open to the red marrow (haematoblasts) on the way to become fat; sometimes one devious route is taken, sometimes another, and the result may be soft mucous tissue, various forms of cartilage, or true bone as an ulterior development of the cartilage.

**Osteoma.**—Next to the enchondromata among the tumours of bone we may take the *osteomas*, or outgrowths from the bone which have themselves the structure of true bone. Their most common form is the exostosis, an osseous node or spine, or rounded tumour generally, on the outer surface of a bone. Sometimes an exostosis is found covered by a considerable cap of cartilage; and, whether it be or had been partly cartilaginous, or whether it be entirely osseous, it is a product of the periosteum, and it illustrates the ordinary osteoblastic function of that tissue. Sometimes the exostosis is spongy, at other times it is hard as ivory, the flat bones of the head being the favourite seat of the latter variety.

**Osteoid Tumours (Subperiosteal Malignant Tumours).**—By far the most important of the tumours of bone are those which are composed of a crude kind of bone, or of various kinds of soft tissue which show a more or less feeble tendency to osseous transformation. These tumours of the bones are apt to occur during the growing period, or shortly after growth. Has ceased; they are by no means rare, and are often fatal. Like the enchondromata, they are divided into those which grow under the periosteum, or the external tumours of bone, and those which begin in the medullary canal, or the internal. The former are much the least complex; and, like the subperiosteal enchondromata, they are mostly found at the ends of long bones, especially at the end of

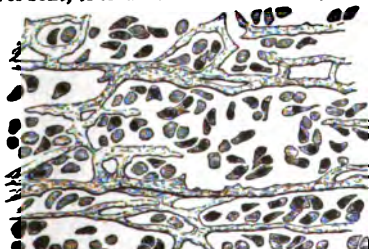

FIG. 32.—Structure of osteoid tumour.

the femur. The growth is clearly subperiosteal; the outlines of the compact bone of the shaft can often be seen running through it. The structure of this kind of tumour is tolerably uniform; it is not bone, but an irregular product of the periosteum to which the name of "osteoid" has been given. The structure is that shown in fig. 32. There is a network of slender trabeculae, mostly forming long parallel meshes, and with numerous but less conspicuous cross subdivisions; these are impregnated with osseous salts; but it can hardly be said that bone-corpuscles are embedded in them, as in the normal growth



FIG. 33.—Spicules from ossifying periosteal bone (kitten); osteoblasts becoming included as bone-corpuscles.

of bone from periosteum (fig. 33). The cells which correspond to the osteoblasts are ranged along the sides of these trabeculae and in the spaces between them; but they fall short of the true osteoblastic grouping, and they seldom become bone-corpuscles embedded in an osseous ground-substance. This is a peculiar error of the osteoblastic process, but a not unintelligible one. It may be further illustrated by another form of periosteal tumour in which there was no deposition of the hardening matter at all. This tumour (fig. 34) grew around the metatarsal bone of the little toe, and, like the osteoid kind of tumour last described, it had a power of infecting the neighbouring tissues and even distant organs, which need not be dwelt upon at present. The structure is a strange reminder of the inherent osteoblastic function of the periosteum from which it grew. There is not a particle

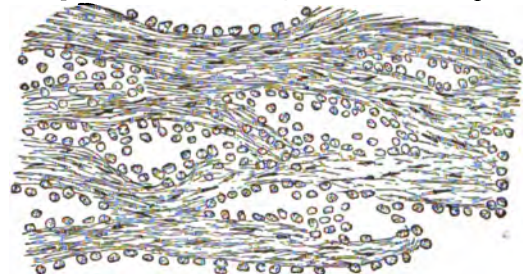

FIG. 34.—Periosteal tumour of fifth metatarsal bone.

of osseous or earthy matter in its substance; but it has the trabecular type of osteoid tissue, and the cells have the surface-grouping of osteoblasts. They are the elongated or spindle-shaped cells of the periosteal tissue, which have become more cubical and angular, and have formed rows of free cells round the walls of the interstitial slits or alveolar spaces. The difference between this and an osteoid tumour is that a certain attempt has been made in the latter towards true bone in the deposition of earthy or bone salts in the trabeculae. In the case of the soft tumour of the periosteum there were clear traces of rickets in infancy, and the essential thing in rickets is the tardy or inadequate deposition of earthy matter in the growing bone. In both tumours the formative activity of the periosteal cells outruns their osteoblastic and ossifying functional activity, so that the latter is always behind, and the perfect result of hard bone is never attained. How this error makes a malignant tumour is another and more difficult question.

**Myeloid and other Internal Tumours of Bone.**—The foregoing are representative instances of external or subperiosteal tumours of bone in addition to the enchondromata and osteomata. There remains an important group of internal tumours, or tumours of the bone-marrow; and these, with the corresponding group of internal enchondromata, exhaust the morbid new formations incidental to the growth of the skeleton. There is, indeed, no hard-and-fast line between the enchondromata and the internal tumours of bone; the latter have almost the same mixture and confusion of structure in various parts that the cartilaginous tumours have. The principal seat of the soft tumours of the bone-marrow is the lower end of the thigh-bone, the ends of the other long bones being the next most favourite seats. A certain tumour of the jaws, the *myeloid epulis*, is also classed with them. The tumour often grows quickly, and may attain an enormous size; it causes the absorption or transformation of the hard walls of the bone, and there may be nothing between it and the skin, muscles, and tendons but a more or less continuous thin shell of bone. The interior has a most diversified aspect. Many patches are friable and yellowish; other areas are a livid purple and gelatinous, and there are often blood-clots and cystic spaces filled with a tenacious brownish mucous or colloid fluid. Amidst these softer parts there run tracts of more spindle-celled or fibrous tissue, and there are often islands of cartilage, or fragments of osteoid substance. The only clue to this puzzling diversity of texture is the inherent range of possibilities in the function of the bone-marrow. Derived from embryonic mesoblast,

it began as a temporary fetal cartilage; it then became spongy bone filled with red marrow, in which state it remains in the ends of long bones, in the diploe of flat bones, and in the interior of bones like the vertebrae. In the shafts of long bones the trabeculae of bone are all removed and only red marrow remains, with a pronounced hematoblastic function; but, when growth is well advanced, the cells of the red marrow become excavated to fat-cells, their blood-forming function ceasing therewith. We have also seen that, in the process of repair, the marrow and its blood-vessels together are able to produce new bone between the broken ends. There are here memories enough to produce very fantastic results if anything should arise to recall the developmental activity. Disregarding the livid or blood-like patches, the mucous areas (whether myxomatous tissue or colloid fluid), and the fragments of cartilage and of osteoid tissue, some of which have been spoken of above, let us consider the tissue that is most characteristic of this group of internal bone-tumours. It is the yellowish or sand-coloured areas of friable texture, corresponding to the tissue named by Paget "myeloid," or marrow-like. Its name is due to the fact that it always contains a number of multinuclear cells, giant-cells or myeloplaxes, such as are found in the marrow of young bones. Its yellowish colour is almost sufficient of itself to indicate the presence of these elements. The cut (fig. 35) shows several of these

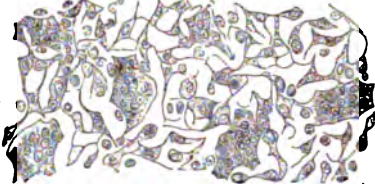

FIG. 35.—Myeloid tissue of tumour of thigh.

myeloplaxes lying among cells of various shapes with a single nucleus. In one direction it is no great step from this to myxomatous tissue or other hematoblastic modifications; and in another direction it is no great step back to cartilage. We shall probably not go very wide of the mark if we take the common starting-point of the various tissues to be fetal cartilage, as drawn in fig. 30 from an enchondroma of the upper jaw; and, given fetal cartilage, it is not difficult to follow it along the various lines of its historical development in the shaft of a bone, to imagine the development taking a devious turn at one point or another, and so to account for the heterogeneous structure of the tumour,—some of the structure, indeed, being strange to the normal types of growth.

**Dermoid Cysts.**—Having now illustrated two great instances of embryonic function revived in after life to the production of tumours—namely, the blood-making and the bone-making functions—and having therewith disposed of a considerable number of all the tumours that have a mesoblastic homology, it will be convenient to advert to a remarkable kind of tumour which shows to the fullest extent what the embryonic mesoblast can do in the way of fantastic new productions, namely, *dermoid cysts*. Not only blood and bone, but teeth, skin, hair, glands, muscle, and nerve are produced as the tumour-constituents in these remarkable new growths. Their usual seat, and the invariable seat of the most perfect of them, is the ovary; and the ovarian is just that mesoblastic tissue upon which the memories of development are as if concentrated; for it is from an ovarian cell that the embryo grows in the perfect likeness of the parent. These selected cells of the ovary, or, in other words, the ova, are specially charged with the recollections of the past history of evolution and growth; and the rest of the ovary appears to possess the same lively memory, if not to the same extent, yet to a much greater extent than mesoblastic tissue elsewhere. The stroma of the ovary is the best example in the body of embryonic spindle-celled mesoblast; only in some animals does it become normally fibrous, and in any animal it may revert to embryonic characters with the greatest ease at the generative periods or at other times, and even in extreme old age. But for the fact that the tissue keeps within normal limits of form and extent it might pass muster for spindle-celled sarcoma, in all respects, including the warp-and-woof arrangement of the tracts of cells. From this tissue cysts are developed interstitially, and they are not the less interstitial in their development that their homologue is often, if not always, a Graafian follicle. That, however, is a region of controversy, and it will be more convenient to take an unambiguous case first. Such would be a dermoid cyst under the skin, say in the neighbourhood of the orbit. It is true that even these cases are sometimes explained by assuming that the skin has somehow become involuted at the particular spot during development; but no observed facts warrant this assumption, and the histogenetic facts of the new growth itself are entirely against it. Fig. 36 shows a portion of new-formed skin on the wall of a small congenital dermoid cyst over the external angular process of the frontal bone; adjoining the actual skin there may be seen the interstitial cells of the connective tissue becoming adapted in form and arrangement to continue the layer of rete mucosum over the cyst-wall beyond. The adaptation is very

much the same which has already been mentioned with reference to the new skin of a granulating surface; the connective-tissue cells become large and cubical, often multinuclear, and elongated towards

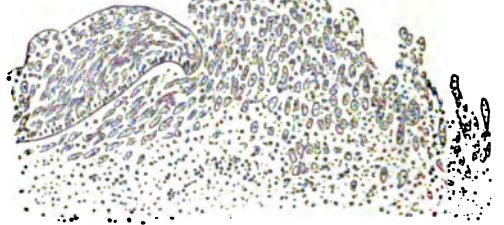

FIG. 36.—Wall of dermoid cyst, showing how the surface-epithelium is produced from interstitial connective-tissue cells.

the surface. The supply of these formative cells comes from the connective-tissue elements lying among the parallel fibrous bundles of the cyst-wall.

For a dermoid of the ovary it is impossible in a brief space to give any idea of the marvellous textures that are being woven side by side in various parts of the cyst-wall,—the areas of fetal cartilage, the interlacing bundles of plain muscular fibres, the long rows of pigment-cells, and, not far off, the rows of mucous cells developed interstitially, and maturing so as to be fused into the fluid of subordinate cysts. At one place there is a piece of skin, underneath which will be found an enormous development of sebaceous glands; where the skin ends a brownish velvety patch begins, with no sebaceous glands, although there are rudimentary hairs at various depths. This under the microscope will be found to approximate to granulation-like tissue, with many variously-shaped pigment-cells, and corresponding probably to the congenital mother-marks of the skin proper. It must suffice to give a single illustration of the strange formative activity of this mesoblastic tissue, namely, the *formation of hairs*. Hairs in dermoid cysts are formed in a very peculiar manner. It is usual in subcutaneous dermoids to find them embedded parallel to the surface at various depths in the midst of multinuclear or giant-cells. Some of these multinuclear masses may be seen undergoing a vitreous transformation down the middle, as in fig. 37, *a*; elsewhere may be seen the same peculiar central rod extending through a succession of giant-cells; and, most remarkable of all, there is the appearance drawn in *c*. In this last case the vitreous rod is capped at each end by a giant-cell, and the characteristic imbrication of scales has developed on it over the intervening length. The cross section of such a hair is seen in *d*. The section of hair is evidently a part of the multinuclear cylinder; it is in this instance well to one side, but it is still enclosed by the marginal nuclei of the cell, which are flattened into plates upon it; in other instances it is found lying outside the largest of a cluster of giant-cells and surrounded by the smaller ones. The nature of the transformation in the heart of these multinuclear blocks is not easy to determine; the most striking circumstance is that other giant-cells, which appear to be advancing in the same direction, or to have diverged from the same kind of development, have an area of deep-brown or orange pigment in their centre instead of the vitreous or horny transformation,—the marginal belt being free from pigment. This is a peculiar formative use of giant-cells. We have already seen that they are used in the vessel-making processes of the placenta and of repair; we have seen also that they may be the media through which a granulation-surface acquires a covering of epidermis; and here we find them playing the part of hair-follicle.



FIG. 37.—*a*, vitreous transformation along a central line in interior of giant-cell; *b*, hairs lying among giant-cells in wall of dermoid cyst; *c*, hair in dermoid cyst, capped by giant-cells; *d*, cross-section of a hair in substance of a giant-cell (dermoid cyst).

A dermoid cyst reveals the surprising spontaneities of a collection of embryonic cells of the mesoblast,—the inherited traditions of their life,—manifested in diverse ways side by side, and manifested often feebly and grotesquely. There is no reason to seek for the source of these various products beyond the stroma of the ovary itself; and the variety of the products must be a measure of what that kind of tissue can do in the way of new formation. When various kinds of structure are thus brought together in their development we have an evidence, not only of the indwelling power of mesoblastic tissue to revert to embryonic modes of life, but also

of a common starting-point for structures that come to be very unlike. We may note, among other things, how small a step there is from the production of blood and blood-pigment on the one hand to that of hair on the other.<sup>1</sup>

§ 5.—ERRORS OF DEVELOPMENT AND GROWTH IN GENERAL.

The more usual departures from the normal type in the embryological rudiments or in the growth of particular organs and parts of the body have been already described in the article MONSTER. The present section will be devoted to those errors of development and growth which amount practically to constitutional diseases.

**Rickets.**—We have hitherto considered the indwelling spontaneities of the cells and tissues as manifested in the process of repair, and manifested capriciously in some tumour-processes; in these it has seemed as if the blood-making function of the embryo were the most fundamental of all its primitive tendencies, traces of it being found in the reparative process and in the new growth of tumours. Next to it, and even bound up with it, is the bone-making function; and we now come to a general or universal disorder of the bone-making function in which these developmental doctrines will be found to have a useful application. This disorder is rickets, a common malady of infancy and childhood. Attention was first drawn to it in 1650 by Glisson, who spoke of it as a disease of children that had been known to be endemic for thirty years in Somersetshire, and had been brought from the country to London. It is very common in all great cities; in Vienna it is still known as "die Englische Krankheit." A child developing this error of growth becomes profoundly affected in its health generally. It is tender all over, dislikes to be touched or handled, throws off the bedclothes even in cold weather, perspires profusely about the head, moves its head restlessly in sleep, so as even to wear the hair off, and in its waking hours sits perfectly still and subdued under a kind of suffering which can be but half-realized by its consciousness. Such children give little trouble, seldom crying even when left alone. They are very sensitive to cold, and proportionately liable to catarrh; their nervous impressibility also is heightened, making a peculiar liability to convulsions and to laryngismus stridulus. They are "backward children," and, in particular, late in getting their teeth.

The conspicuous error in such subjects is in the growth of the bones everywhere throughout the body. The rickety condition often begins in children who are plump and apparently well nourished; and, if the nutritive and other processes are involved at length, it is the osteoblastic process that is primarily at fault. The details are somewhat different for the two kinds of ossification—in membrane or periosteum, and in cartilage. Regarding the former, the error will be readily understood by reference to the accompanying cut (fig. 38) of normal ossification of the

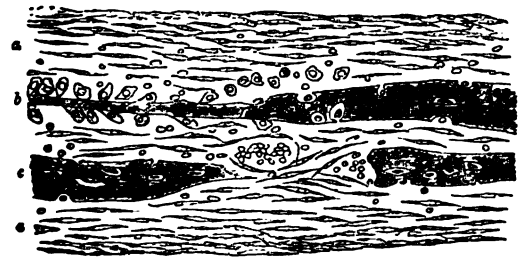

FIG. 38.—Ossifying parietal bone of fetal kitten. a, a, spindle-celled membrane, corresponding to pericranium; b, spicule of calcified ground-substance, with five osteoblasts at one end and imprisoned bone-corpuscles at the other; c, broader bars of bone.

parietal bone. The spindle-cells of the membrane are becoming cubical along a line a little below the surface, and a few of them are half-included or imprisoned in the thin bar of bone; most of them are free on the surface of the calcified bar, as osteoblasts, the included ones being bone-corpuscles. Increase of the osseous tissue takes place through other osteoblasts becoming surrounded by calcifying ground-substance; and, in the broader bars of bone below, the bone-corpuscles may be seen to be two or three rows deep. This process goes on until the whole of the osteoblasts (derived from spindle-cells) have been included one by one within the calcifying matrix; once included, these cells are incapable of growth; the multiplication is always in the spindle-shaped cells of the membrane, or on the surface of the bony bars or trabeculae; and the inclusion

is of that gradual and co-ordinated kind that there is always a set of free cells left on the surface to keep up the succession of formative elements. It is not until growth is completed that osteoblasts cease. The error in rickets is that the multiplication of spindle-shaped cells and osteoblasts far outruns the calcifying process. Instead of these elements being produced only as fast as they are wanted for inclusion as bone-corpuscles, they are produced regardless of the forwardness of the calcifying process, upon whose exact co-operation with the cellular formative process all true periosteal bone-making depends. The error, or part of the error, of rickets is that the calcifying process is behindhand. A large quantity of soft bone-making material accumulates, which would, under ordinary circumstances, have become hard bone as soon as it was formed; sooner or later it becomes bone, even in rickets, but the deposition of earthy salts is slow, and in the meantime the bones have become bent. Not only is there a relative slowness in the calcifying process, but there is an absolute excess of the cellular elements or of the osteoblasts; and, in the flat bones of the skull, this is shown in the thickness of the bones ultimately, especially along their growing edges. The same excess of formative material beyond what can be used up for bone is seen in the ossification from cartilage at the epiphysal line. The cartilage-cells divide and multiply at an excessive rate, and the columns of them, instead of keeping in the line of the axis of the bone, radiate to the sides, so that there is often a bulbous enlargement where the epiphysal joins the shaft. The want of harmony in the calcifying and osteoblastic parts of the process is shown by the irregularity of the epiphysal line (fig. 39); it is a straight line normally, but in rickety growth it runs out and in, cutting off islands of cartilage in the midst of spongy bone; and this irregularity is due to the fact that the blood-channels in the cartilage are formed sooner at some points than at others, the calcification following close on them. In the shaft of a long bone the process is the same as in a flat membrane-bone of the skull; the periosteum is thick and its inner layers are blood-red, and in extreme cases there is what looks like a stratum of blood between it and the bone. Bone is at length formed from this layer, but it is of the spongy kind, so that the shaft is softer and more porous on the outside than on the inside. In the flat bones of the head, also, the structure is apt to be of the spongy kind throughout, so that they consist as if of diploe entirely, and not of a layer of diploe between two hard plates. Sooner or later, under favourable circumstances, the spongy bone is replaced by compact bone, and in the end the bones of a rickety subject are harder and thicker than usual. In the worst cases deformities remain, notably the bent spine, the pigeon-breast, and the deformed pelvis. In the very worst cases the stature is dwarfed and the long bones are bent and twisted.

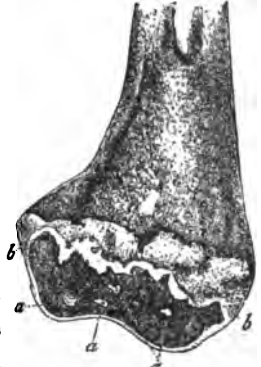

FIG. 39.—Lower end of femur of baboon with rickets, showing the broad and irregular epiphysal line of growing cartilage (white) with spongoid tissue above it and islets of cartilage in the spongy bone beneath. a, a, c; b, b, irregular epiphysal line of cartilage. (From J. B. Sutton, in *Path. Trans.*, xxxiv.)

Analysing these phenomena and filling in details, we come in the last resort to an indwelling disposition, probably acquired in most cases, or in largest measure, before birth. These tendencies come to an issue in the skeleton, because the growth of the bones is of a nature to tax the organism. The growth of the bones is the great instance of metaplasia; it is a succession of tissue-changes long kept up, and it requires a peculiar co-ordination or orderliness at each step, owing to the fact that stiffness has to be combined with plasticity. The requisite stiffness can only be got step by step through the sacrifice of that plasticity which goes with growth, and hence the special adaptation of a free row of osteoblasts on the surface of bone-trabeculae to ensure the apposition of new layers. Cartilage gives the stiffness for a time in all the bones except the clavicle and those of the vault of the skull; having served its purpose, it becomes spongy bone, blood, and marrow, the spongy bone being finally removed in the shafts of long bones, the marrow remaining, and the blood continuing to be added to the general blood of the body. In these adaptations the early importance of blood-making among the embryonic cells is duly asserted. When the fetal cartilages have served their turn the hematoblastic function becomes prominent in the cells, and a large part of all that was cartilage literally becomes blood. According to numerous observers, it even becomes blood without the accompanying formation of blood-vessels with definite walls. Some of it becomes bone; but the bone is in thin plates only, and much of it is ultimately removed. In the periosteal process, also, where the cartilage-stage of the formative tissue is never gone

<sup>1</sup> See Virchow, *Die krankhaften Geschwülste*, 3 vols., 1858-67; Paget, *Surg. Path.*; Cohnheim, *Vorles. über allg. Pathol.*, vol. 1, p. 622; Rud. Meier, *Lehrb. der allg. pathol. Anatomie*, Leipzig, 1871.



through, there are not wanting indications that the same hæmatoblastic function is present concurrently with the osteoblastic.

Coming, then, to the actual facts of rickets, we shall find that those features of the process on which the greatest stress has been laid in the recent elaborate researches of Kassowitz are of the nature of over-vascularization or hyperæmia. In the ossification from cartilage he finds that the vessels from the perichondrium extend inwards to a greater extent and with less orderliness than usual; then there is a development in the cartilage of colossal vessels, and finally of blood-spaces, packed full of red blood-disks, and with no very definite walls, so that it looks, at the first glance, as if hæmorrhage had taken place into the bone-marrow. In many cases there is no sharp line of separation of the embryonic marrow from the contents of these blood-spaces; it is probable that the gelatinous tissue of the former had "passed direct into hæmatoblastic substance and so into blood-corpuses." In the periosteum also there is much more blood than usual, and the same large blood-spaces are sometimes found. These errors of vascularization Kassowitz places at the foundation of the rickety process. Deposition of calcareous salts, he points out, cannot take place where there is so much blood; the calcification follows in an orderly way only where the movements of the blood and juices are restrained or distant, the best example of this law being the gradual reduction of the wide central space of an Haversian system to a narrow channel containing a single twig of blood-vessel.

The excess of vascularity in rickets is, by Kassowitz, put down to "inflammation," or to the hyperæmia of the same; but we have seen that he also invokes, as a detail in the process, an excessive hæmatoblastic activity in the embryonic marrow-cells. The latter is a more fundamental and intelligible fact than "inflammation" (which begs all the fundamental questions), and we shall do well to give it prominence accordingly. We should then interpret the observations of Kassowitz as follows.

The due regulation of the blood-supply, the restriction of it to definite and ever-narrowing channels, is necessary for the proper deposition of the earthy matter and for the building up of bone in Haversian systems. The embryonic cells surrender their individual hæmatoblastic function, while certain tracts of them become definite vessels for the supply of all the rest; and in proportion as they give up individually their primitive function of blood-making they are in a position to take on individually the function of bone-making. In compact bone this change of direction is carried out most completely; the cells become osteoblasts in successive rows, a ground-substance impregnated with earthy matter closes in around them, and they are imprisoned for ever as bone-corpuses. In spongy bone, however, there is still a reserve of hæmatoblastic force; only thin laminae of bone are formed out of some of the cells, while many of them continue to be hæmatoblasts and to form the familiar red marrow. Adopting, then, the figure of a struggle between the hæmatoblastic and osteoblastic tendencies in embryonic cells, or the perception of a divided duty, we shall conclude that rickets is the undue preponderance of the former. It means spongy bone where there should be hard bone, and much wider spaces than usual, with much more blood in them in the proper seats of spongy bone itself; and it means in general a retardation of the hardening process.

All this enormous hæmatoblastic energy or local blood-formation is unfortunately wasted; the child is no better for it, and is more likely than not to be anæmic. The formative powers are diverted from bone-making, and spent upon blood-making; and the lime-salts in the organism that should have gone to make bone are actually thrown out with the urine, which has been known to have as much as four or even six times its due amount of phosphates. The organism, when rickets overtakes it, is in this fix, that it makes blood which it can no longer profit by, and has meanwhile to part with bone-salts which it will want again. The disease is, in fact, an unfortunate contretemps.

Many of the facts of rickets are thus secondary to an initial error in the embryonic functions of the tissues, and the evidence seems to show that the error must have begun in most cases before birth. Although it is well known that the obvious phenomena of rickets are not usually remarked until the child is a few months old, yet, as Kassowitz has ascertained, the condition "begins much more frequently than has hitherto been assumed in the later months of intra-uterine development." The facts point very clearly to the health of the mother as being primarily at fault. "The health of the mother," says Sir William Jenner, "has a decided influence on the development of rickets in the child. Whatever renders her delicate, whatever depresses her powers of forming good blood, that tends to produce rickets in an offspring. . . . The child of an ill-nourished mother is disposed to become rickety when placed under unfavourable circumstances after birth, or even under favourable circumstances in some cases." The disposition must be in most cases, and in the worst cases, congenital in the child's tissues. We should therefore seek in the intra-uterine connexion between mother and child for some defect on the maternal side which would induce that which would appear to be essential

to rickets in the child, namely, a preponderance of the hæmatoblastic function of embryonic cells over the osteoblastic, a reversion in the cell-life of the growing frame towards independent blood-making. In seeking for this source of error, it will be necessary to recall for a moment the nature of the intra-uterine connexion between mother and child, or the part played by the placenta.

*Placental Function in Congenital Disorders.*—The embryo makes its own blood and establishes the connexion with the mother by its own blood-vessels. Its blood is carried to the placenta to be aerated, as the phrase goes; but it is much more than aerated. The placenta is a glandular or secreting organ of the mother, inasmuch as the maternal blood, flowing slowly through the sponge-like tissue of thick-walled vessels, receives additions of mucus-like drops from the deliquescent of the large nuclei in the protoplasmic vessel-walls (fig. 40). This mucus-like addition is clearly

an adaptation for the foetus; and the surfaces of the placenta, where the fetal vessels touch it, are further adapted, through a thick-set cap of nuclei, for exuding it where it can be taken up by the plasmatic tissue of the chorion. This placental contribution is the "uterine milk" furnished by the mother for the use of the foetus, so that, although the latter makes its own blood (and blood-vessels), it receives material additions to its blood from the mother. It is obvious, therefore, that

the secretion of the placenta is very essential to the foetus,

and the due endowment of the latter must depend greatly upon the structural and functional sufficiency of that organ. It supplies the foetus with much of the fluid that circulates in the latter's vessels; it may be said to spare the foetus to that extent the need of producing such fluid itself, or to dispense with the hæmatoblastic activity of its tissues, so that they may take other formative directions, such as bone-making. Or it may be contended that there are ingredients in the normal placental secretion which are specially adapted to bone-making. Now, if there should be any interference with these placental contributions, we are left to suppose that there must then be a reversion on the part of the fetal cells to self-helping tendencies, and especially to local blood-making. The excessive blood-making of rickets, and the retardation of bone-making consequent thereon, would thus be traced to failure in the placental function.

But, if there be such a change in the direction of the formative processes of the foetus as an adaptation to its special intra-uterine conditions, why should rickets not become declared until several months after birth? In the first place, we have the evidence collected by Kassowitz that there are plain indications of the rickety process to be observed where death of the child has occurred before the full term; and, further, there are analogies to show that it requires all the extra-uterine functions to have been in action for some little time before a congenitally-acquired tendency manifests itself. Although the intra-uterine life comes to an end, and the child ceases to be dependent on the placental function of the mother, yet the acquired tendency, or the adaptation to a deficient performance of that function, remains for a certain time longer. It comes to an end, however, from the second to the fourth year; the bone-forming tissues cease to follow the devious direction, the bone-salts present in the organism are put to their proper use, ossification resumes its normal course, and, as the soft formative material of bone had accumulated in excess, the bones of the once rickety child are in the end harder and thicker than those of normal growth.

There is an assumption in the foregoing which calls for remark, the assumption, namely, that the placental function has been inadequate on the mother's side or that the requisite additions to the blood have not been made. Our almost complete ignorance of the pathology of the placenta is the reason why the above-mentioned facts and principles have to be eked out by an assumption. We do, indeed, know that the placenta suffers in syphilis of the parent; and we know that in congenital syphilis of the child the growth of the bones is affected in many ways analogous to the shortcomings of rickets, and that, as in rickets, the error of growth may not show

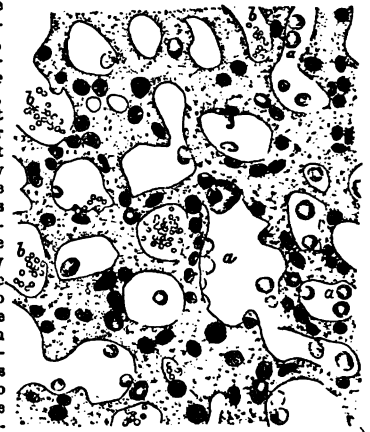

FIG. 40.—Secreting structure of placenta (guinea-pig); the walls of the maternal blood-channels are themselves the secreting structure, their substance yielding drops of mucus *a*, which mix with the blood *b*.

itself for some time after birth. It is highly probable that the placental structure and function suffer under many less special conditions of ill-health and mal-nutrition of the mother. The placenta is, in fact, a great formative effort, and the formative power cannot always be adequate. There are in particular two conditions in the mother favourable to rickets in the child, in each of which an absence of structural and functional perfection in the new-formed organ of intra-uterine nutrition is *a priori* probable. The one is the extreme youth or immaturity of the mother, assigned by Schönlein as the chief cause of rickets; the other is child-bearing up to a comparatively late period, the latest of a succession of pregnancies being often found to be those which yield the rickety members of a family. But amongst the poor there must be many other causes of general ill-health in the mother operating from time to time. Whatever makes the mother's milk poor cannot but have told at an earlier stage upon the placental structure and function; and that earlier stage is a vastly more critical time for the endowments of the child,—for all its formative, nutritive, and functional tendencies.

**Osteomalacia.**—A sort of counterpart to rickets occurs in the disease known as osteomalacia or mollities ossium; and, curiously enough, this is a disease (as distinguished from senile softening) almost exclusively of women during mature life, apt to occur in the gravid state, and especially if there have been repeated pregnancies. It is mostly a disease of poor and hard-worked women, just as rickets is a disease of the children of poor and hard-worked women; it is not very common, although it is said to be endemic in some localities. The bones become soft or friable, owing to the encroachment of the medullary cavity upon the compact substance and the further absorption of spongy bone; the encroachment may be so extensive that only a thin shell of bone or parchment-like membrane remains. This enormous medullary space is filled with marrow, but not the marrow of adult life. The marrow is of the fetal kind, red, and often containing areas of blood, abounding in nucleated marrow-cells, and with a decreasing number of fat-cells. Ultimately the marrow becomes gelatinous. The process consists essentially of a reduction of the bone to red marrow, as in the first formation of the medullary cavities of long bones; the earthy salts are removed, and all the cells of the tissue acquire an embryonic character. Although there are some facts to show that this process takes place sometimes in the young, especially in young animals under confinement, yet its characteristic occurrence is in women during one of their later pregnancies. It is generally admitted that there is some intimate connexion between the outbreak of mollities ossium and the gravid state. We have found reason to conclude that there is an equally intimate connexion between rickets and the gravid state, only that the rickets is in the child. If, in rickets, the child is deprived of something maternal which it should have received, then in osteomalacia the mother parts with something for the child which she ought to have kept. In both cases the organism of the mother is overtaxed; but in the more general case, where the child becomes rickety, the tax has not been met. In the rarer case, the welfare of the child *in utero* takes precedence of the welfare of the parent; one may conceive that the formative effort for the placenta had been so great that the organism in general was impoverished. As a matter of fact, the bones of the mother are robbed of their earthy matter, and the commencement, at least, of that diversion of substance is somehow connected with the gravid state. It is noteworthy, in this connexion, that a fractured bone in a pregnant woman repairs badly, owing to the deficient production of bony callus. Having once begun, the disease progresses, and the patient dies bedridden; only in rare instances do the bones become hard again. The loss of osseous matter in mollities is accompanied by a return to embryonic characters and function on the part of all the cells that now form the very extensive marrow; the hæmatoblastic function is conspicuous in the process, and there are also numerous myeloplaxæ. Both the unmaking of bone in the parent and the diversion of embryonic tissue from bone-making in the child would appear to be correlated with the hæmatoblastic function of the cells. In both diseases phosphates are discharged in excess in the urine, and in neither is there any advantage from the excessive formation of blood. In osteomalacia the embryonic state of the marrow changes after a time to a more gelatinous state; sometimes a wall forms round the red pulpy fluid, producing a cyst of the bone with brownish contents, and in these cases the disease is said not to progress farther.

**Cretenism.**—A much more profound error or defect of all the developmental powers of the body than that of rickets is found in cretenism. Certain aspects of this subject have already been treated of in the articles **CRETINISM** and **INSANITY**; and another aspect of it is referred to in the section of this article dealing with the thyroid gland (see p. 385). It remains to mention here a few of the anatomical and external characters of the disease. With the low mental development there usually go a large tongue, a broad and flat nose, loose and thick skin, and stunted limbs. The error of growth in the bones, which is only a part of a very extensive range of erroneous development, is somewhat different from that of

rickets. In the bones of the skull there is usually found *synostosis*, or premature union at one suture or another, not infrequently at the sphenobasilar, giving the base of the skull an up-and-down direction. The premature union along one line or other leads to compensating expansion elsewhere, so that the skull is misshapen; the forehead usually retreats, the top of the head is flat, and the occiput small, the type of skull being markedly brachycephalic or broad. One distinctive point in the bone-lesions of cretenism relates to the stunted limbs, which are not at all characteristic of rickets. The stunted growth depends upon a complete departure from the ordinary relation of the epiphysis to the shaft. A bone such as the thigh-bone grows normally to the length, chiefly by the activity of the cartilage of the epiphysis along the epiphysial line: the cartilage-cells multiply on the surface of the epiphysis next to the shaft; they become grouped in long perpendicular columns; and, as ossification proceeds, the new bone becomes an integral part of the shaft. Meanwhile the epiphysis itself is becoming ossified radially from the centre outwards. In the cretin the activity along the epiphysial line is somehow checked, and it has been found that a fibrous band extending inwards from the periosteum forms a kind of barrier in the position of the proliferating epiphysial line, cutting off the shaft from the epiphysis; thus the shaft is deprived of those accretions at each end upon which its elongation mainly depends. At the same time the cartilaginous epiphysis spends its proliferative force within itself; it expands in all directions, becoming a large knob, and part of its ossification may be effected by a sort of inverted activity of the epiphysial line, which proliferates towards the interior of the epiphysis, instead of growing towards the contiguous shaft. No analysis of these peculiarities of bone-growth in cretins need be attempted, but some remarks are offered on p. 385 with reference to the mother's share in this congenital condition.

**Chlorosis.**—Contrasting with rickets, in which the tendency born with the child produces symptoms of ill-health in children of both sexes within the first year, and seldom later than the second, chlorosis is a congenital condition of which there are symptoms first at the age of puberty, and almost exclusively in the female sex. The congenital nature of this condition has been made probable by the anatomical observations of Virchow, which go to show that in chlorotic subjects there is very uniformly found a narrow or inadequate aorta, much more elastic than usual, with its inner coat irregular in thickness and disposed to degenerative changes, and with its intercostal branches coming off in a more than ordinarily irregular manner. These anatomical peculiarities are naturally part of the congenital endowment of the individual. The full force of the chlorotic state is not felt until the time of puberty, and in the male sex it is hardly felt at all. It is, indeed, associated in the most intimate way with the remarkable periodicity of ovulation to which the female sex is subject; it manifests itself in the years when that function begins, and chiefly at each successive period of the function. After a few years the indications of it become feebler and tend to disappear. Want of sunlight in the daily life of the individual is the chief aggravating circumstance of the anemia of chlorosis. The vascular system is on a small scale, to begin with, and there is too much blood in the body for the size of the vessels; the blood is not quite normally constituted, having too few corpuscles in proportion to the plasma, and in the red disks there is too little hæmoglobin or colouring matter. While the blood and blood-vessels are poor, the fat of the body, and especially the subcutaneous, is abundant.

**Hæmophilia.**—This is another general state of the vascular system, which is always congenital, and often runs in families, one or more of whose members are "bleeders." It is a disorder of the boys of a family just as distinctively as chlorosis is a disorder of the girls. A remarkable disposition to bleed, with or without the provocation of an injury, is the whole disease; neither structural change of the blood-vessels nor peculiar composition of the blood has been made out, and there is nothing remarkable in the ordinary appearance of a bleeder. When the bleeding is spontaneous it comes from the mucous membranes, especially from the nose, but also from the mouth, bowel, and bronchial tubes; one of the most common and fatal traumatic occasions of bleeding is the extraction of a tooth. Even slight bruises are very apt to be followed by extravasations of blood into the tissues; the swollen joints (knee especially) of a bleeder are probably due, in the first instance, to the escape of blood into the joint-cavity or into the synovial membrane. It is always from the very smallest vessels that the blood escapes, and from these it may escape in such quantities as to cause death within a few hours. It appears that the same extensive capillary hæmorrhage may occur anywhere in the body provided the opportunity is furnished, by a slight injury or otherwise, for the blood to escape.<sup>1</sup>

<sup>1</sup> *Literature.*—Of rickets.—W. Jenner, *Med. Times and Gaz.*, 1860, vol. i; Virchow, *Cellular-Pathologie*, 4th ed., 1871, chap. xx. (also in his *Archiv.* vol. v., 1861); Kasowitz, *Die normale Ossification und die Erkrankungen des Knochenystems bei Rachitis und hereditärer Syphilis*, Vienna, 1883; *Id.*, in summary, in *Trans. Internat. Med. Congress.* vol. iv. p. 45. Lond., 1881; J. Guérin, *Mémoires sur les*

## § 6.—ERRORS OF BLOOD-MAKING IN MATURE LIFE.

The words quoted above from Sir William Jenner—"Whatever depresses the mother's powers of forming good blood tends to produce rickets in an offspring"—are a special application of a general doctrine of blood-making which has been held empirically by the medical profession at all times. It is not easy to discover with scientific precision the facts of blood-making in mature life upon which this doctrine, otherwise amply justified, is based. It is remarked by Sir Thomas Watson: "Although we cannot doubt that any considerable modification or defect of the fluids that feed and renovate the blood, and particularly of the chyle, must have a direct influence upon its composition and quality, we really know but little about them except in their effects. We seldom have any means of procuring these the first products of nutrition so as to examine them, or to test their qualities, yet we can perceive causes that are likely to deteriorate or deprave those fluids (unfit aliment, impure air), and we know that, under the continued operation of such causes, the blood, replenished by these fluids, is actually and sensibly modified." The more recent development of the physiology of metabolism has been followed by an extension of our knowledge of the state of the blood in disease; thus the text-books speak of such conditions as glycæmia (glucose in the blood), acetonæmia, cholæmia (jaundice), lipæmia (fat in the blood), uræmia, &c., some of which fall to be spoken of in sections following. In the present section it is rather the corpuscular part of the blood that has to be considered with reference to its renewals in mature life. It is now known that red blood-disks are continually being added to the blood, continually perishing in a like ratio; the red marrow of bone is unquestionably a source of the red disks, and so probably is the pulp of the spleen; again, the liver plays some part, not yet precisely determined, in the cycle of changes that the solid elements of the blood undergo. Confining the attention, then, to the corpuscular elements of the blood, we shall best approach the question from the side of the colourless or white blood-corpuscles, the undue proportion of which is the most obvious fact in the important disease called leukæmia.

*Leukæmia, or Leucocythæmia.*—The relation of the colourless corpuscles of the blood to the red disks is variously explained; all that we know, however, from such occasional cases as blood-cysts points to the red blood-disks being the detached protoplasm of the hematoblast,—the nucleus surviving. Appearances in the subcutaneous tissue of the fetus, in the thymus, in the spleen, and in bone-marrow point in the same direction. The colourless corpuscles of the blood would thus be the surviving nuclei of the original hematoblasts, the red disks being detached portions of the protoplasm of the same. There would be in any case several red disks for one surviving nucleus; but in actual blood the proportion of cells of the latter kind is very much smaller than that. The proportion varies in health from time to time, and it is usually increased during pregnancy, making a physiological leucocytosis. Ordinarily the colourless corpuscles are in the proportion of from 1 in 800 red (after a meal) to 1 in 1000 red (in the fasting state). If the colourless cells are the surviving nuclei of hematoblasts, we must suppose that the protoplasm continues to be renewed around the old nucleus, so that the same hematoblast gives off successive generations of red disks. The cells of red marrow, of the thymus (while it lasts), and of the splenic pulp would thus be standing sources of new red corpuscles. Evidences that they are so are not wanting in fine sections of these tissues, although the process of budding of the hemoglobin-

tinted fragments of protoplasm is not so marked in all its stages as in those abnormal instances of hematoblastic activity to which reference has been made (blood-cysts, angiomas of liver). In the normal process there seems to be less cleavage of the nucleus, although the nucleus is not unfrequently seen to be constricted or half-divided; the marginal protoplasm detaches itself from one side as if with little trouble, new protoplasm gathers around the nucleus, and so the supply is kept up just as if it were secretion from the cells of a gland. If the cell which had discharged its residual protoplasm in the form of one or more disks or globules were thereupon to continue in its nuclear state, and to acquire no further investment of cell-substance, it would practically amount to a colourless corpuscle of the blood. There are, as we have seen, always a few such cells in the blood—one in several hundred red disks—and the real difficulty about them is to understand why they should be present in the circulating fluid at all. In the disease of leucocythæmia they increase enormously, so as to be in the ratio of twenty, fifty, or even one hundred to the hundred red disks, which are themselves absolutely fewer; and, if we interpret that phenomenon according to the view that they are residual nuclei of hematoblasts, we shall conclude that the hematoblasts have very generally ceased to produce new generations of red disks, have stood still at the lower grade, and have passed bodily from their blood-forming habitat into the blood-stream. There would be, in short, an arrest of function, manifesting itself not only in the great falling off in the number of red disks but also in the presence within the vessels of these sluggish or crippled elements of the blood-making organs and tissues, as if in lieu of the red disks themselves. What, then, is the actual condition of the proper seats of blood-making in the leucocythæmic disease?

The interest centres in the state of the spleen and of the bone-marrow; according to modern views the so-called lymphatic leucocythæmia belongs to another class of processes and may be here disregarded. The spleen is in all cases enlarged, from twice up to fifty times its normal size; it retains its form, but its structure is firmer, less sanguinous, streaked with pale or yellowish lines, or mottled with yellowish patches. The marrow in the bones is often changed in appearance: it has become grey or reddish grey and diffident; and this change may be observed even in the marrow-fat of long bones. These changes are essentially in the hematoblastic tissue,—in the splenic pulp and in the bone-marrow; the cells of that tissue have to a great extent ceased to form blood, their activity has taken another and formative direction, from which no functional product results (red blood-disks), but mere overgrowth of tissue and of cellular nuclei. The hematoblasts have, in fact, become constructive when they should have continued functional. The enormous number of colourless corpuscles thrown into the blood has to be traced to the same diversion of the hematoblastic forces which has in the spleen led to textural overgrowth; instead of remaining in the seats of blood-making, and continually reclothing themselves with hemoglobin-tinted protoplasm, the hematoblasts have passed bodily into the blood-current in their naked nuclear condition. The colourless cells of leukæmia may be said to have the same relation to the hematoblastic process that was claimed, in a former section (see p. 865), for the pus-cells of granulations. The peculiar state of the bone-marrow characteristic of leukæmia has often been compared to granulation-tissue; in some cases it has even the appearance of puriform infiltration. Again, the first cases of leucocythæmia were described by Hughes Bennett as cases of "suppuration of the blood"; and, if the pus of granulations is an analogy for the cells of leukæmic blood, the textural developments of granulations may be held to be an analogy for those formative changes in the spleen which are found in its enlarged state.

*Pseudo-leukæmia.*—Leucocythæmia is a definite and generally fatal disease wherein the increase of colourless corpuscles of the blood and the decrease of the red disks are referable, in the last resort, to disordered hematoblastic function in the spleen or bone-marrow, or in both. There may be a state of *leucocytosis* without this profound and fatal hematoblastic disorder, wherein the increase of colourless corpuscles is referable to organs and tissues which have no blood-making function. Affections of the lymphatic glands are the principal occasion of this leucocytosis or pseudo-leukæmia, and such affections may occur in the course of morbid processes so various as scrofula, cancer, and typhoid fever. A considerable degree of leucocytosis occurs also in the later months of pregnancy as a perfectly normal incident. The lymphatic glands and the lymphatic follicles of the mucous membranes are collections of lymphoid cells which have no true blood-making function, however closely their cells may resemble those of the bone-marrow, of the splenic-pulp, and of the thymus; they are rather related to the cellular by-products, or the solid waste of secretion (see section 7). From them, or through them, the colourless cells in the blood may receive considerable additions from time to time; but these have a significance quite different from the profound disturbance of blood-making which constitutes leucocythæmia, and they are better classed under the heading of

*Différences du Système osseux*, Paris, 1839-43; Humphry, *The Human Skeleton*, Camb., 1858; various authors in *Trans. Path. Soc.*, vol. xxxii, Lond., 1881. Of osteomalacia:—Kassowitz, *op. cit.*, chap. vi.; Cohnheim, *Vierteljahrsschrift für Pathologie*, vol. i. p. 518; Ribbert, in *Virchow's Archiv*, vol. lxxx. Of cretinism (morbid anatomy):—Virehow, several papers reprinted in his *Gen. Abhandl.*, p. 891 sq., Frankfurt, 1856; Eberth, *Die foetale Rachitis und ihre Beziehungen zum Oretinismus*, Leipzig, 1875; Barlow and others in *Trans. Path. Soc.*, Lond., 1881-84. Of chlorosis:—Virehow, *Ueber die Chlorosis*, &c., Berlin, 1872; Leache, *Die Anatomie*, Christiania, 1883. Of hæmophilia:—J. Wickham Legg, *Treatise on Hæmophilia*, Lond., 1872.



*leucocytosis* or pseudo-leucocythæmia. The difference is even discoverable, according to Virchow, in the morphological character of the colourless corpuscles in the two cases. In true leukaemia (splenic) the corpuscles in the blood are somewhat large, with multiple nuclei, and more rarely with a single nucleus; in the pseudo-leukaemia (lymphatic) the cells are small, the nucleus single and large for the cell, the cell-substance being often so narrow a zone as to be hardly appreciable around the nucleus. These are practically the differences between the cells of lymph-glands or follicles and the residual nuclei of hæmatoblasts (or pus-cells).

This pseudo-leukaemia connects, on the one hand, with *Hodgkin's disease*, a general condition of lymph-gland overgrowth, and, on the other hand, with solitary *lymphomatous tumours*, such as grow, mostly perhaps, in children in the kidney, or in the follicular tissue of the intestine, or elsewhere.

*Pernicious Anæmia.*—This is another serious and generally fatal error of blood-making which presents both an instructive parallel to leucocythæmia and an instructive contrast. The onset of this disease is often sudden, it may be with symptoms of chills and heats and other febrile manifestations. It occurs at all periods of life, and in both sexes. The body seems to become strangely bloodless, so that even the point of the finger will not bleed if cut. There is much listlessness, often giddiness, tendency to hæmorrhages, especially into the retina, and pains in the bones. Recoveries, temporary or permanent, are more usual than in leucocythæmia, especially under the administration of arsenic. The blood is profoundly altered, and the state of it may vary much within a space of weeks or even of days. The red disks are enormously reduced in number, and many of those that are left have departed from the usual type; they may be either very large or very small, two or three times larger than usual, or two or three times smaller. Some of them are oval and flat, and some of them pear-shaped vesicles (fig. 41). They may have also an increased colouring power, which means an undue concentration of hæmoglobin. When the two chief blood-making tissues are investigated in such cases after death they do not always furnish a rational explanation of the state of the blood. It is, in fact, somewhat rare to find anything elucidative in the state of the spleen, and the interest is thrown mostly upon the bone-

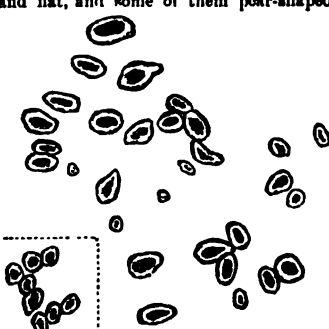

FIG. 41.—Red blood-disks from a case of pernicious anæmia; in the left lower corner is a group of normal red blood-disks for comparison. (After Laache.)

marrow. Not always, but very often, this tissue is profoundly altered; even the yellow marrow of the long bones is red or jelly-like, few or no fat-cells are visible, red blood-disks are everywhere, along with granulation-like marrow-cells, in a fine reticulum, and traversed by blood-sinuses which have been compared to the sinuses of the spleen. Sometimes the nuclear cells of the marrow are found with a zone of reddish protoplasm round them or in the state of perfect hæmatoblasts. In this peculiar disorder of the blood-making process the salient facts appear to be the following. Red disks are formed from hæmatoblasts with difficulty; they are mostly either much too large or much too small; the hæmoglobin is too concentrated in them; the bone-marrow makes quite unusual hæmatoblastic efforts; but the vessels at large remain ill supplied with blood, while the marrow itself is everywhere full of blood, and sometimes even tends to organize itself into a structure like the spleen. Degeneration follows in the muscular structure of the heart and in the walls of blood-vessels; to the former are owing some prominent symptoms, and probably to the latter the hæmorrhages. One of the most singular things in this remarkable disease is the power of recovery, either temporary or permanent, that the organism may acquire, chiefly under the stimulus of arsenic. As compared with leucocythæmia the striking fact is that the part played by the colourless corpuscles is from first to last a subordinate and even unrecognizable one.

*Scurvy.*—In scurvy we have a blood-disease of a kind somewhat different from leucocythæmia and pernicious anæmia, inasmuch as it depends, not upon unaccountable and seemingly capricious errors in the blood-making tissues, but upon errors in the ingesta, upon well-understood defects of diet. (See SCURVY.)

*Irregularities of Blood-distribution.*—While the facts of blood-making are among the most fundamental in pathology, the facts of blood-distribution come more visibly into the every-day manifestations of disease. The speed and force with which the blood is driven round its whole circuit vary much; as measured by the pulse at the wrist these conditions of the circulation have at all

times been held by practitioners to be of the first importance in diagnostics and prognostics. The local distribution of blood, or the amount of it within and the rate of its passage through particular organs and parts, is a more recently investigated subject bound up with the doctrine of vaso-motor nerves. One of the most striking facts in this chapter of physiology is the varying amount of blood within the "splanchnic area" from time to time. In pathology the question of the varying distribution of blood comes largely into the doctrine of fever and of inflammation; the further discussion of it is reserved for a later part of the article.<sup>1</sup>

§ 7.—ERRORS OF SECRETION.

The pathology of secreting structures is concerned, not only with deviations from their normal activities as described in physiological treatises, but also with an additional series of phenomena recalling the more elementary or embryonic kinds of cellular activity. Besides those great disorders of glandular structure and function which fall to be considered in the next section as errors of metabolism, there is a large part of the sum-total of disease which is merely an affair of elementary cellular irregularities in the mucous surfaces and glandular organs of the respiratory, digestive, and reproductive systems. In the foregoing illustrations of pathological processes it has often occurred to notice the obstruction, as it were, of earlier phases of cellular activity into later life, or the revival of embryonic characteristics, both structural and functional. The illustrations already given have related chiefly to blood-making and bone-making; we now come to a corresponding class of illustrations from the epitheliated parts of the body. In the latter also there is a liability to revert to rudimentary forms of cell-life, wherein the epithelial cells reveal their inherent power to act as independent units, or their spontaneity and their self-governing properties. Thus, among the morbid conditions of the respiratory apparatus there are only a few, such as asphyxia, the Cheyne-and-Stokes breathing, and the like, which are directly in contact with the physiology of the respiratory mechanisms. On the other hand, pulmonary catarrhs and their structural after-effects (together with laryngeal and tracheal inflammations) enter largely into the pathology of the respiratory organs, although they are hardly deviations from those respiratory functions that have the engrossing interest for physiology. There is the same class of elementary cellular deviations among the morbid states of the digestive organs, and, most of all, in the pathology of the genito-urinary system,—of the uterus, bladder, and prostate,—and of the breasts. The most universal error that epitheliated surfaces or organs are liable to is catarrh; and closely related to their liability to catarrh is their liability to polypous and simple-glandular tumours, and, under special circumstances, to cancer.

*Catarrh in general.*—The term catarrh (*card, down; ides, flow*) was originally applied to a running from the nose; the mucus was called "pituita," and in the Hippocratic doctrine of the humours it was exalted to a place side by side with the blood and the bile. The vague importance assigned to this humour in the medical philosophy of the Greeks is further shown in the curious fiction which made it to issue from the *hypophysis cerebri* or "pituitary" body. The mucus of the nose may stand for the mucus of the air-passages generally, and it differs only in degree from that which is expectorated when there is considerable bronchial catarrh. It is now usual, and the usage is scientifically justified, to include all other mucous or muco-purulent or purulent discharges from epitheliated surfaces as the result of a "catarrhal" process.

Those mucous surfaces that are most liable to catarrh are ordinarily kept moist by an exhalation or secretion; in the mucous

<sup>1</sup> See Virchow, *Cellular-Pathology*, chaps. ix., x.; Wilks, articles on leukaemia in *Guy's Hosp. Reports*, and in Wilks and Moxon, *Path. Anat.*, 2d ed., London, 1875; Mosler, *Die Pathologie und Therapie der Leukæmie*, Berlin, 1872; Gowers, art. "Leucocythæmia," in *Reynolds's System of Med.*; Malassez, in *Arch. de Physiol.*, 1877 sq.; Pye-Smith, "Idiopathic Anæmia of Addison," in *Guy's Hosp. Reports*, xxvi.; Eichorst, *Progressive pernitiöse Anæmie*, Leipzig, 1878; Laache, *Die Anæmie*, Christiania, 1888; Blozzer, Rindfleisch, and others on the hæmatoblastic function.

membrane of the stomach and intestine the surface-moisture amounts to a definite layer of glairy or tenacious mucus. In some of the mucous membranes, such as those of the pharynx and oesophagus, trachea and bronchi, there are distinct racemose glands which appear to subservise solely the purpose of lubricating or keeping moist. In every case the normal mucus of an epithelial surface may be taken to be a product of the epithelial cells; it is as if it were a common and rudimentary function of surface-epithelium anterior to the specific secretions of organs. It is in this common and rudimentary function that the catarrhal process has its roots, a process which not only exceeds the physiological limits of surface-moisture, but may even throw into the shade the specific secretion of the part or organ. The catarrhal secretion is always characterized by the large preponderance of cells, and the proportion of cellular elements increases as the mucous substance becomes muco-purulent and purulent. It is important to observe that there is no definite line where the limits of normal moistness end and "inflammation" begins; and, as it is desirable to put off as long as possible the introduction of that entity into pathology, we shall best proceed in the study of catarrh by advancing from the physiological activities of cells.

**Nature of the Catarrhal Process.**—The catarrhal process, like all the so-called inflammatory processes, has been rendered ambiguous by the undoubted share in it that is taken by hyperæmia or afflux of blood to the particular epithelial region. By some the hyperæmia has been taken to be the primary fact, the increased rush of blood to the part and the local stagnation of the same being traced to an upset of the controlling and equalising nervous mechanism of the vessels and to alteration of their walls; by others the local cellular process has been regarded as determining the afflux of blood, as if by a kind of attraction. Whether the afflux of blood precedes the unusual activity of the epithelial cells, and whether some of the catarrhal cells may not be emigrated colourless corpuscles, are questions that may be considered open; but there can be no question that catarrh is essentially a hypersecretion of the epithelium, or the secretory activity so modified that it becomes to a great extent formative, or its product to a great extent cellular. The difficulty of proving this is owing to the fact that the normal production of mucus from epithelium is a very subtle and rapid process, the morphological phases of which are hardly to be detected; in this respect it must be considered analogous to the formation of red blood-disks from hematoblasts. And, as the details of the hematoblastic process are best seen in certain abnormal manifestations of it, and even in those cases where the morbid condition is one of anemia, so the complete physiological paradigm of mucus-production is best seen where there has been some interference with the perfection of function. We shall perhaps not go wide of the mark if we describe the catarrhal process as a reversion to a more embryonic or more elementary type of cellular activity. The higher the type of secretion, the less obvious are the morphological changes in the secreting cell; in an organ like the liver, which had been early acquired in the evolution of the animal body, the secretion has become so elaborated in the higher animals that the steps of it present hardly any morphological features at all; on the other hand, in an organ like the breast, which is a late (mammalian) acquisition, the changes in the secreting cell can be followed at leisure. Catarrh in any mucous surface is the same primitive kind of secretion, and it may be said, in a word, to consist of a fluid product and of an additional by-product of cells. The original epithelial cell is detached bodily, nucleus and all; the protoplasm becomes the more or less viscid or semi-fluid part of the mucus; and the nucleus goes with it as the catarrhal cell. The more the cellular elements predominate, the farther does the secretion deviate from the normal, until we reach the limit of pus, where we invoke the entity of "inflammation."

**Succulence and Thickening of the Catarrhal Mucous Membrane.**—A mucous membrane which has been the subject of catarrh for some considerable time becomes thicker and more succulent. If it be examined in microscopic sections it will be found that the underlying connective tissue has become involved; the tissue is "infiltrated" with round nuclear cells (fig. 42); the fibres are becoming



FIG. 42.—Epithelial surface and submucous tissue in a state of catarrh (tubular gland of the dog's skin). a, a', collections of catarrhal cells in the epithelial layer; b, the same in the underlying connective tissue.

thicker; and the fineness, delicacy, and translucency of the tissue are disappearing. At certain spots where the "infiltration" and associated changes are greatest the surface breaks or ulcerates, and a

"catarrhal ulcer" remains. The central fact in this process is the infiltration of the round nuclear cells beneath the epithelial surface. The facile way of accounting for them is to assume that the colourless corpuscles of the blood had escaped through the walls of the small veins; but it is more in accordance with observed facts and with unambiguous analogies to regard them as catarrhal cells which have found their way into the depths of the tissue instead of flowing off by the surface. The presence of these cells in the spaces of the connective tissue is not without effect on that tissue itself; they rouse it to a formative activity which conducts to the succulence and thickening of the mucous membrane, and, it may be, to ulceration at particular spots. To enter on this subject at present would be to open up the question of the infective action of one kind of cell upon cells of another kind (see pp. 382, 383).

**Physiological Analogies of Catarrhal Infiltration.**—The infiltration of catarrhal cells beneath the mucous surface has close analogies in the normal processes of the body. It is exactly paralleled in one of those crude forms of secretion to which the catarrhal process has been compared, namely, the kind of secretion, gradually rising in intensity, which goes on in the breast during the period of gestation. This process can be most conveniently observed in the mamma of the cat or dog, where the crude secretory products are for a time cells of considerable size filled with yellow or brown pigment; the pigmented cells can be followed from the secreting structure into the spaces of the surrounding connective tissue, and thence into lymphatic glands. It would not be carrying this analogy too far to regard the *lymphatic follicles* of the mucous membranes as collections of or receptacles for the cellular by-products of the mucous secretion; such are the tonsils, the follicles on the back of the tongue and pharynx, the lymphatic follicles of the stomach of some animals (but not of man, unless it be in infancy), the extensive stratum of lymphoid cells in the villi of the small intestine and the more definite collections of the same (Peyer's patches), and the lymphatic follicles of the great intestine.

Certain it is that all these collections of round nuclear cells are subject to very considerable increase when there is catarrh in the corresponding mucous surface. Not only so, but in catarrh they will show themselves prominently even where they are hardly known to exist normally; thus, in the intestinal catarrh (summer diarrhoea) of young children, even the thin folds of the mucous membrane (valvule conniventes) will be found studded with round nodular or somewhat flattened lymphatic follicles. In intense catarrh these follicles are the favourite seats of ulceration, their substance changing into a "follicular ulcer." In other cases the catarrhal process makes its influence felt in the nearest lymphatic glands, which may be regarded as the second line of receptacles for the by-products of secretion (as well as for the matters of absorption), the submucous follicles being the first line; and, under these circumstances, the lymphatic glands may even suppurate (as in the axillary lymph-glands of the breast after weaning).

**Tumour-diseases of Mucous Membranes and of Secreting Structures generally.**—If catarrh of mucous membranes enters, as Rindfleisch says, into the larger half of all the morbid conditions to which mankind is subject, the tumour-diseases of the epithelial surfaces and organs may be said to rank among the most formidable of all maladies, inasmuch as they include cancer. Cancers are diseases primarily of mucous membranes and other secreting structures, most commonly of the stomach, next to it of the uterus, of the female breast, and of the intestine; another variety of cancer (epithelioma) is diseases of modified epithelial surfaces, namely, the skin in general, and the lip and tongue. There are, however, much simpler tumour-disorders of epithelial surfaces which it will be convenient to take first.

**Warts (Papillomata).**—Papillomata of the moist epithelial surfaces are found almost exclusively in those situations where there is a transition from skin to mucous membrane. The rule may not be universal, but there are many instances in which these wart-like growths have an undoubted relation to a catarrhal process of the surface, where the removal of the catarrhal products has been interfered with. One of the most striking illustrations of this law occurs in veterinary practice; in the horse, especially when he is overworked and ill cared for, the natural smegma of the prepuce gets retained, owing to the fixity of the sheath; the accumulation has more than a mechanical effect, for it appears to induce a papillomatous condition sometimes of the whole mucous surface. The papillomata are new growths, either in a broad layer of the uniform thickness of a quarter of an inch or more, or they are large dendriform masses arising at various points and each attached by a narrow stem. It is hardly a catarrhal process that we have here to deal with, but it is none the less a disorder of secretion. The natural secretion not finding an outlet, the secreting surface adapts itself gradually to the unusual conditions. The surface becomes ridged or thrown into folds, or papillae arise at isolated points; blood-vessels run in the central parts of all these reduplications of the membrane; and the epithelium, instead of disengaging itself in successive generations of cells after the manner of the natural smegma, takes on a formative activity and builds up as

adventitious tissue on the surface, the pattern of which is determined by the looping or dendriform branching of the blood-vessels (fig. 43). These formative aberrations of secretion are apt to return after removal, even although the conditions which gave rise to them are obviated; the new development and persistence of the blood-vessels entering their stems appear to be the occasion of recur-



FIG. 43.—Portion of a dendriform papilloma or wart (horse); rance in these cases.

**Mucous Polyypi.**—In many cases mucous polyypi have an undoubted connexion with those states of the mucous membranes which are included under catarrh. An approximation to a multiple polyipous condition may be found in the stomach subject to long-standing catarrh, where the ridges and furrows of the mucous membrane amount to an actual *polyiposis ventriculi*. Multiple polyypi are sometimes met with also in the intestine. The commonest seats of the isolated and stalked mucous polyyps are the nasal passages and the cervix uteri. Their structure is after the same plan as the more

epidermic papilloma, everywhere tubular mucous glands, the epithelium of which is wonderfully perfect (fig. 44); these may branch or communicate more than do the normal gland-tubes of the part, and they are separated by tracts of connective tissue which appear to the naked eye as dendriform white lines. In these morbid products the line is definitely crossed from functional to formative, but we cannot assume any other force than the indwelling secretory activity of the part; the unique fact that presents itself here is that a perversion of that force gives rise to an organ-like new formation whose plan of structure is plainly determined by the blood-vessels. It is worthy of note that the bronchial mucous membrane, which is the most liable to catarrh, has practically no liability to mucous polyypi; and the bronchial mucosa is distinguished, not only by its investment of cartilaginous rings and plates, but by the density of its elastic and muscular coats.

**Simple Glandular Tumour (Adenoma).**—As the mucous polyypus is characteristic of the wide expanse of mucous membrane, so the simple glandular tumour or adenoma is the formative result of functional disorder in the definitely bounded epithelial organs with mucous systems of ducts. The glands that are most liable to this condition are the breast, the salivary glands (including the buccal and labial), the lacrymal glands, and the skin-glands in certain regions. Whenever the more uniform expanses of glandular structure, such as those of the stomach and the intestine, take on a formative activity to the depth (instead of to the surface, in the form of polyypi), the result is a cancer, involving other considerations besides those primary or direct deviations from the secreting activity which we are now considering.

**Intra-canalicular Papilloma.**—The simple or non-cancerous tumour-disease of glands may be represented in most cases in the light of deviations from the normal secretory activity,—deviations which take a formative direction. They connect not remotely with catarrhal states of the secreting structure; but, speaking generally, they stand for irregularities of the apparatus and process of secretion which transcend the notion of catarrh. It will be convenient, however, to proceed in the analysis of them from that familiar basis. The nearest approach to the effects of catarrh is shown in the folded or uneven state of the wall of the terminal secreting recesses or acini of a gland; this condition may be observed in certain skin-glands and in the breast. The cut (fig. 45) is taken from a tumour of the skin-glands of the dog. The lining of columnar or cubical epithelial cells, which is ordinarily a perfectly even surface, is raised into distinct papillary eminences. These may even meet across the space, changing its interior into a nearly solid or at least trabecular tissue. The next cut (fig. 46) shows precisely the same process in the breast, this time not in an acinus but in a

duct; the result is what is called an "intra-canalicular papilloma,"



FIG. 45.—Papillary outgrowths of epithelial lining in a tubular gland.



FIG. 46.—Intra-canalicular papilloma of breast.

and it is not different in its origin and nature from the papilloma of expanded mucous surfaces which we have already considered.

**Cartilaginous Tumours of Glands.**—Another formative result of disordered function, which takes us quite beyond the limits of catarrhal effects, is the occupation of the walls and interior of the acinus, not with papillae of the lining epithelium nor with the epithelial cells shed into the free space as solid by-products of the secretion, but with a new tissue foreign to the gland. This occurs in the mamma (more often in the dog than in man), in the salivary glands (parotid, submaxillary, and labial), in the lacrymal gland, and in skin-glands (e.g., of the scalp); the new tissue may be of the mucous or myxomatous kind, and it is not rarely cartilaginous, or even osseous, at a few points in the midst of the cartilage. The occurrence of myxomatous and cartilaginous areas is common in the parotid tumours of man and in the mammary tumours of the dog, and it is usually explained as an arbitrary and unaccountable overgrowth and transformation of the supporting connective tissue of those organs. It remains to inquire whether it may not be brought into a rational connexion with disorder

of the proper secretory function. The cut (fig. 47) is taken from a case of extensive tumour-disease in the mamma of the bitch, in which much cartilage had formed. It represents several acini of the gland, having their interior occupied with large spherical or oval vesiculated cells with firm hyaline contents. These



FIG. 47.—Group of acini of mamma (dog) occupied in part with large vesiculated hyaline cells which are practically cartilaginous.

can be no question that these are epithelial cells strangely changed; but the change will not seem so strange if we keep in mind the range of transformation which the secreting cells of the breast are normally liable to. There is a stage in the unfolding of this gland from its periodical state of rest in which the cells become vesicles filled with mucus, just as there is a more mature period when they are still vesicles but filled with a more fatty or milk-like fluid. The change in the tumour is, after all, only from the mucus-filled vesicles to vesicles occupied by a firm hyaline substance; and, if it were connective-tissue cells that we were dealing with, the explanation would be at once accepted, according to the well-known correlation between fat, myxomatous tissue, and cartilage. The facts seem to require that the same formative possibilities be granted to epithelial cells; so that the myxomatous and cartilaginous formations in secreting structures would be traced to their active elements. The supporting tissue of the glands is *a priori* passive, and, as a matter of fact, it has not been proved by any detailed observations to be the source of those myxomatous and cartilaginous new formations. The occurrence of vesiculated epithelial cells with firm hyaline contents is not the only piece of positive evidence. It is much more common to find the columnar epithelial cells elongating into fibre-like elements, straight or crescentic, and developing mucous or hyaline intervals of intercellular substance; in this way there results the myxomatous and fibro-cartilaginous tissue that is so often found in the tumour-disorders of the salivary glands and more rarely in the labial mucous glands. The glandular plan of the structure in these cases very soon becomes obliterated, and the limits between supporting tissue and secreting apparatus removed; in a considerable area of hyaline cartilage or fibro-cartilage there are naturally few or no traces left of the apparatus and process of secretion; and there may some-

times be seen (as in the mamma of the bitch) the most remarkable development of all, the change of the cartilage into bone, with perfect medullary spaces lined by perfect osteoblasts. There are, indeed, no limits, other than the fundamental embryological limits, to the formative possibilities of cells which have reverted to primitive embryological function. We have already seen that the standing example of an embryonic tissue, the spindle-celled tissue of the ovary, contains within itself the whole range of development which is expressed in the grotesque variety of a dermoid cyst.

Another common effect of disordered glandular function is the excessive formation of solid by-products of the secretion, which are either retained in the recesses of the gland or are infiltrated into the spaces of the underlying and supporting connective tissue. Where the products are retained within the gland-space we have the familiar and simple result of *cysts from retention*, of which the sebaceous cysts or "wens" of the scalp are good examples. But a far more momentous occurrence is the infiltration of these crude products or by-products of secretion into the depth. We have already found reason to believe that the same kind of infiltration below the surface takes place in catarrhs, that the nuclear cells found in the deeper layers of a thickened mucous membrane are of the same origin as the catarrhal cells of the surface-discharge, and that their presence in the spaces of the connective tissue had been the exciting cause of the fibres becoming thick and coarse, or, in other words, of the "inflammatory" changes in that tissue. The infiltration which comes under our notice in tumours of secreting structures is different from this as regards the characters and properties of the cells: as regards their characters, the cells retain more of the epithelial type, that is to say, they are not naked nuclei, but they have a considerable investment of cell-substance; as regards their properties, these epithelial cells infiltrated below the mucosa do not excite "inflammation," but they excite cancer. What remains to be said of the infiltration of by-products of glandular secretion will be included in the section on cancer immediately following.

§ 8.—CANCER.

The popular estimate of the nature of cancer is so well founded that a definition is superfluous. Cancer in pathological anatomy differs from cancer as commonly understood in being restricted to the malignant tumour-diseases of secreting structures and epithelial surfaces generally, to the exclusion of a certain number of equally malignant tumours which grow from the periosteum or the marrow of bone, or from other mesoblastic tissues. The great majority of all the cases which have the fatal progressiveness of cancer are diseases of the stomach, the uterus, the breast, the intestine, and the skin; this group makes so large an element in the sum-total of tumour-disease, and is so homogeneous within itself, that it may justly appropriate the name of cancer, leaving the other cases of tumour-malignancy to be described by more technical names. At the same time it should be clearly understood that the smaller detached group does contain cases where the particular manner of fatal progression is not different from the progressiveness of the epithelial tumour-disorder, such, for example, as the cases of periosteal tumours becoming parosteal.

*Chief Seats of Cancer.*—The absolute and relative frequency of cancer in the various seats of secretion has been ascertained by D'Espine, from the mortality returns of the canton of Geneva, for both hospital patients and the well-to-do treated at home, to be as follows over the period from 1388 to 1855—

Stomach .....	390 cases, or	45 per cent.
Uterus .....	129 "	15 "
Liver .....	98 "	10.5 "
Breast .....	76 "	8.5 "
Small and large intestine .....	30 "	3.5 "
Rectum .....	25 "	3 "

being 76.2 or 85.3 per cent in a total of 899 cases of malignant tumours of all sorts. Most cases of cancer of the liver are really secondary to cancers in the stomach or elsewhere, so that the leading position of the stomach, and after it of the uterus, the breast, and the intestine, becomes more marked. According to the facts collected by Virchow from the mortality returns of the town of Wurzburg from 1852 to 1855, the deaths from malignant tumours were 5.3 per cent. of the total mortality, and the percentages among malignant tumours were as follows:—

Stomach .....	34.9 per cent.
Uterus, &c. ....	18.5 "
Intestine .....	8.1 "
Liver, &c. ....	7.6 "
Face and lips ..	4.9 "
Breast .....	4.7 "

78.2 per cent. of all malignant tumours.

It may be accepted, then, that the digestive tract is the seat in about one-half of the cases of malignant tumour-disease, and the female sexual organs (excluding the ovaries, but including the breasts) in about one-fourth, while the remaining fourth has to be apportioned among other epithelial organs or parts and the bones and other mesoblastic tissues. It must not be supposed that these ratios hold good equally for all localities; the breast sometimes appears to usurp a larger share, and sometimes the rectum. Again it is a noteworthy fact that cancer is a comparatively rare disease among the vast populations within the tropics.

The beginnings of cancer have to be sought for in disturbances of the apparatus and process of secretion. Even in the cases where hereditary or congenital predisposition plays a part there must have been local irregularities of structure and function to determine the seat of the disease; thus, of four sisters of whom three were married and had families, one died of cancer of the breast, another of cancer of the stomach, a third of cancer of the rectum, and the fourth of cancer of the uterus,—the incidence of the disease in them all happening about the age of fifty to sixty. Cancer in secreting structures is essentially one process; but each of the favourite seats of cancer has its own special liability, as well as points of structure special to itself. The liability of the female breast is an entirely different thing from the liability of the stomach; and the liability of the uterus is more closely allied to that of the stomach than to that of the breast, although the breast and the uterus have a closer systemic relationship. There is, however, something in the cellular law of secretion common to them all, and it is that common feature of the secretory process which first engages the attention.

*Relation of Cancer to Secretory Process.*—The product of secretion is not, under all circumstances, a fluid; in the simpler forms of animal life, and in more recent or less elaborated glands of the higher forms, it may be thrown off in cellular shape, just as it is always cellular in its origin. We have already seen that in the catarrhal state the cellular admixture is considerable, and there can be hardly any question that the cells of a catarrhal discharge are derivatives of the epithelial cells, being indeed little other than their nuclei. We have also seen reason to believe that the infiltration of nuclear cells in the thickened mucous membrane of chronic catarrh had been a real infiltration of the catarrhal cells beneath the surface. Now the favourite seats of chronic catarrh, the stomach and the uterus, are also the favourite seats of cancer. What, then, is the relation between these two very different diseases, both of them primarily disorders of the apparatus and process of secretion?

A particular case will bring out the points of resemblance and the points of difference. In a fatal case of cancer of the stomach the whole organ is found to be uniformly thickened, the mucous membrane being much ridged and furrowed; but its epithelium is unbroken. The interval of submucous tissue, ordinarily a loose layer between the mucosa and the muscular coats, is occupied throughout the whole extent of the organ by a nearly uniform stratum of firm whitish tissue. This is an exceptional case of cancer of the stomach, but it is a very instructive one; the morbid condition is as

uniformly diffused over the organ as if it had been the thickening of chronic catarrh, and it wants the usual tumour-character of cancer. The microscopic examination proves, what the whiteness and almost gristly firmness of the submucous interval had suggested, that the disease is hard cancer.



FIG. 48.—Infiltration of scirrhous cancer uniformly diffused throughout the whole sub-mucosa of the stomach.

The white stratum under the mucosa has the structure shown in the cut (fig. 48), and it is an average example of the infiltration of scirrhous cancer. Epithelial-like cells, with a disproportionately large nucleus, are as if packed in rows in the spaces of a very dense fibrous tissue, which contains a large number of elastic fibres. Besides the linear processions of cells, there are elsewhere groups of them arranged round the walls of spaces like the epithelium of a gland. Throughout the whole thickness of the coats of the stomach in this case such collections of cells are found; in the muscular coats they are met with chiefly where there are fibrous septa; and it is noteworthy that the gland-like collections are by far the most numerous in the tissue most

remote from the physiological glandular surface, namely, the connective tissue of the serous or external coat (fig. 49). It is impossible to trace a continuous growth of these subserous gland-like groups of cells from the actual glands of the mucous surface; they are separated from the latter by nearly a quarter of an inch of muscular and other tissue, in which the "infiltration" occurs only here and there. The wide extension of the cancerous process is not mere overgrowth or protrusion of the secreting structure, nor is it even an infiltration, in the literal sense, of the cast-off secreting cells; it is an infection of the cells of the sub-



FIG. 49.—Diffused cancer of stomach; tubular-gland grouping of cells in sub-peritoneal tissue.

adjacent tissue to become epithelial cells and gland-like cell-groups. And therein lies the essence of cancer. Extension of Cancer from the Surface to the Depth.—Whereas, under commoner circumstances, the catarrhal by-products of the process of secretion find their way to the underlying textures and there give occasion to an "inflammatory" reaction, to hardness and coarseness of the connective tissue, under other circumstances the less nuclear or more epithelial by-products of the glandular activity have the power to induce the remarkable formative process in the neighbouring tissues which we know as cancer. The cancerous process implies, accordingly, such a condition of the secreting structure and function, or of its individual cells, as can excite this formative reaction, and it involves also the changing of the surrounding tissue (or of its cells) into epithelial forms of cells, either in rows or groups or in gland-like systems. As regards the former, there is no lack of evidence that cellular by-products of secretion are often the antecedent or concomitant of cancer in an epithelial organ or part; they may be seen sometimes in the stomach heaped up between the glandular tubules, or in the mammary gland (especially of the bitch) infiltrated into the surrounding stroma. The cut (fig. 50) is an illustration from the mamma; the rows of cells which lie in the spaces of the connective tissue are the cellular products of the secretory function characteristic of an immature or low-powered intensity of secretion, and they are easily identified in all phases of the mammary secretion in the dog, whether regular or irregular, by their yellowish-brown pigmentation. It is not to be expected that such an infiltration of by-products of secretion can be proved for every case of cancer, nor is there reason to suppose that there is always such an infiltration. The elements of the secreting structure may serve *in situ* to excite or infect the neighbour-

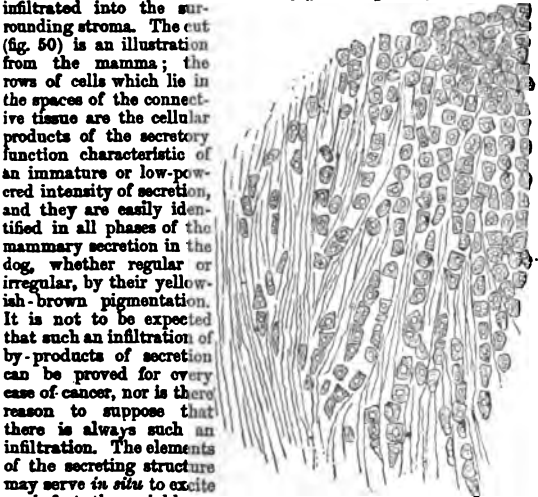

FIG. 50.—Infiltration of pigmented epithelial cells into the stroma of the mamma in a usually do for the case of tumour (dog).

nective tissue on which they immediately rest. But we have to take due account of the much more important fact that the infection also manifests itself at a number of remote and isolated centres, within each of which the new growth arranges itself as if implicitly according to a design, the pattern being the more or less regular epithelial type proper to the organ or part. Thus in fig. 49, from a diffuse cancer of the whole stomach, the glandular tube-like structures have arisen at a number of points in the connective tissue of the outer coat. The pattern of tubular glands is often more complex than in that figure, both in other stomach cases and in cancers of the great intestine and rectum. This remarkable breaking out, as it were, of very perfect epithelial tubules, disconnected from the physiological tubules and often in the midst of dense tracts of plain muscular fibre, appeared to Johannes Müller to be so extraordinary that he ascribed them to an invisible *seminum* dispersed through the tissues; according to him, the *seminum* was a literal seed whose particles themselves grew to be the new epithelial cells. We do not now admit the possibility of cells so arising by *generatio equevoca*; every cell must be the descendant of some pre-existing cell. And, although it is neces-

sary to retain the doctrine of the *seminum*, the part played by that hypothetical element is not formative within its own particles; but it is a fertilizing or infecting influence upon the pre-existing cells of the neighbourhood. In most cases the cells so fertilized are the corpuscular elements of the common binding-tissue of the body, or the connective-tissue cells.

Cancerous Infection of the Connective-tissue Cells.—The cut (fig. 51) is an exact drawing of a piece of cancerous tumour where the connective-tissue cells can be seen in the act of transforming into epithelial cells, or in various stages of that transformation-process. The process carries us once more back to that embryonic activity



FIG. 51.—Cancerous infection of connective tissue in a case of tumour of skin-glands of the dog.

of cells in mature life which we have had frequently occasion to discover in other elementary processes of disease. The cells of the connective tissue are ordinarily quiescent in the form of plates more or less compressed laterally, the cell-plates of tendon being extreme examples. Just as, in the process of repair, they become plump and granular, developing in the third dimension as well, and ultimately becoming granulation-cells, so in cancerous infection they start from their obscurity among the bundles of fibres, passing by rapid transitions into the form and semblance of the epithelial cells proper to the occasion; and they may even go on to assume a glandular grouping round the wall of a space, acting as if harmoniously or according to *an* implicit design. There is no fact in pathology more noteworthy than this; if it has any analogy among the facts of normal biological processes, we shall probably have to go to the very lowest groups of animals or to the earliest stages of evolution to find it. Whatever the infective influence may have been, it touches all the quiescent cells over a certain area simultaneously; a "territory" of tissue, larger or smaller as the case may be, but always involving a number of cells, assumes the embryonic life throughout its whole extent, and goes through all the steps of the transformation towards the epithelial type and grouping, as if its cells had received one common impact.

States of the Connective Tissue predisposing to Infection.—There are, indeed, reasons for thinking that the special factor in the production of cancer, and of the production of it at particular spots in a large area of choice, is not so much the presence of cellular by-products of the secretion as a particular disposition of the connective tissue of the particular spot to be easily acted on by them. Catarrhal products are often present without any infection following; but the two favourite seats of repeated or chronic catarrh, namely the stomach and the uterus, may at length become the seats of cancer. Cancer is hardly ever a disease of the first half of life; it is very distinctively a disease apt to occur after the meridian is passed. In those who are liable to uterine and gastric catarrhs the mucosa and the submucosa at length become thick and succulent. This happens at particular spots, notably just within the pylorus of the stomach; the epithelial surface may not be appreciably different from the surface elsewhere, but the underlying tissues are thickened and, it may be, contracted to a stricture. It is in such dense new formations of connective tissue that cancer is most apt to form; what is called cicatricial tissue is proverbially liable to cancer, and a tissue may be to all intents and purposes "cicatricial" (and apt to shrink) even if it underlie an unbroken surface. Some cancers of the stomach form entirely below-the-surface, in the thickened floor of a healed ulcer, or even in the not unfrequent dense adhesions between the serous membrane of the back of the stomach and the piece of peritoneum which is drawn over the anterior surface of the pancreas. A cancerous stricture of the intestine or rectum is not unlikely to have been to some extent a stricture before it became a cancer. The condition of the connective tissue in all such circumstances is not easy to define; it is often spoken of as young connective tissue or "embryonic," and there is probably in it a smaller preponderance of the fibrous element over the cellular than is usual in mature life. A general change in the connective tissue of the body has been asserted to take place as age advances, a senile change which has been described by Thiersch, for the corium, as a relaxed state. The epithelial localities subject to persistent functional disturbance do at least seem to undergo a change in their underlying or surrounding connective tissue, whereby that tissue becomes predisposed to cancerous infection. The infection emanates from the secreting structure proper for it carries with it the likeness of such structure (in its more or less irregular or morbid state). The cellular waste or by-products of the secretion would appear to acquire something of the property of sperm-cells; and, inasmuch as the infected or impregnated connective tissue produces not merely individual epithelial



cells of the appropriate type but also the appropriate grouping of such cells, the sperm-cells must be held to carry more than the influence of cell-units, and in fact to be representative of the whole structural and functional process in which they had played a part.

*Varieties of Cancer.*—The two main varieties of cancerous texture are the hard and the soft, or the scirrhous and the medullary. *Scirrhous cancer* is very often the "infiltrating" kind, with the epithelial cells lying in scattered groups or in single file within the spaces of a peculiarly dense and elastic connective tissue. It is common in the breast and not rare in the stomach. The *medullary cancer* consists of very much larger and closer groups of cells, which may be in nondescript heaps or in the more regular arrangement of glandular structure. When the glandular type is very distinct the tumour is sometimes called a "destructive adenoma."

*Colloid cancer* is a very peculiar variety, apt to occur in the stomach but not unknown in the breast; most of the structure is changed into a brownish jelly-like substance which forms more or less definite spherical or alveolar masses separated by narrow bands of stroma. Under the microscope (fig. 52) little of cellular structure of any kind is found remaining, but in place of it there are an immense number of spherical pearl-like bodies, each of which consists of several delicate concentric laminae arranged round a more dense nuclear point.

*Cancer of the skin*, and of the lips and tongue, is generally termed *epithelioma*; it is not a disorder of secretion in the same sense as other cancers are, but it is a disorder incidental to the constant waste and repair of the epithelium of the skin. It is characterized by the encroachment of processes of the rete mucosum upon the corium and subcutaneous tissues, or, in the lips, tongue, upper part of the oesophagus, &c., of epithelial columns of cells upon the subepithelial region. The type of this encroachment is the papillary arrangement of the normal rete mucosum, where the appearance of regular columns of epithelium reaching down into the corium is equally due to the reciprocal protrusion of loops of blood-vessels upwards.

The interlocking of epithelial columns and connective-tissue tracts in epithelioma is much more extensive and irregular than in the normal skin, and it is always difficult to decide, from the superficial microscopic appearances, whether the encroachment of the epithelium is merely a displacing or a transforming encroachment (fig. 53). In some cases, such as destructive epitheliomas of the tongue, or of chimney-sweep's cancer, it is possible to find reliable evidence in the microscopic sections that the progressiveness of the disease is really an infection, like that of cancer elsewhere—

that is to say, the neighbouring tissues, and more especially the connective-tissue cells, are infected so that they assume the epithelial type proper to the locality—and that infection tends to spread without limit. But the doctrine of continuous growth from the rete mucosum downwards, by mere subdivision of pre-existing epithelium, appears to be justified as a part, at least, of the pathology of cancer of the skin. As in cancers of the stomach and uterus, the regions liable to skin-cancer are especially those subject to repeated irritation or to prolonged functional disturbance. One of the most striking instances of this law used to be the cancer of the skin of the scrotum and groins in chimney-sweeps, a form of disease which has become much less common of late. Again, it is nearly always the lower of the two lips that suffers, and the rare cases of epithelioma of the lip that occur in women are among those of the sex who smoke pipes. Like other cancers, the cancer of the skin, lips, and tongue, &c., is a disease of later life; according to



FIG. 52.—Colloid cancer of the breast.

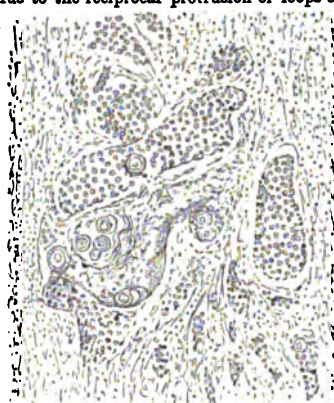

FIG. 53.—Epithelial cancer of skin deeply involving the side of the neck. The cylinders of epithelial cells, resembling those of the rete mucosum, are surrounded by fibrous tissue infiltrated with small nuclear cells.

Thiersch, it is due to a "disturbance of the histogenetic equilibrium between epithelium and stroma, to the disadvantage of the stroma." The perfect balance of tissues would be exemplified by that regular interlocking of vascular papilla from below and epithelial processes from above which the skin ordinarily shows; as age advances the downward force of the epithelial growth prevails, owing to a certain decreased "turgor vitalis," or to loss of resistance on the part of the tissue carrying the blood-vessels, so that, when long-standing irritation of a particular spot is added, we should have the two great determining causes of cancer of the skin. But the question will always remain, whether the essence of the disease is not really an infective transformation of the quiescent cells of the connective tissue into the type and pattern of the irritated epithelial structure.

The female breast is peculiar among the glands of the body in its great liability to cancer; the disease is of essentially the same nature as that which we find in the stomach and other epithelial organs, but the occasion of it is quite different. It will therefore be convenient to reserve further remarks on cancer of the female breast until the next section—that on the "liabilities of obsolescence."

*Extension of Cancer to Lymphatic Glands and other Discontinuous Parts.*—If the beginnings of cancer are to be sought for in some disorder of the apparatus and process of secretion, the disease very soon passes the limits of the primarily disordered organ or part. The cancerous property of a tumour, as we have concluded, is from the first an affair of infection of the neighbouring tissues by epithelial products; the infected neighbourhood is the seat of the primary tumour, the progressiveness or infiltrating character of which may soon cause a large area to be involved and a large growth to result. Sooner or later there is *discontinuous infection*, or the infection of more or less remote centres, whereby *secondary tumours* arise.

This phase of cancerous infectiveness is by no means dependent on the extent of the primary infection or the infection of the original neighbourhood. That which distinguishes secondary cancerous nodules, wherever they are found, is the very close mimicry of the pattern of structure in the indigenous seat of disease, a pattern which is itself determined by the structural and functional characters of the secreting organ or part concerned. In the majority of cases the nearest lymphatic glands become the subject of this mimetic process first; the liver also is very liable to discontinuous infection, not only in cancers of the stomach and intestine, but even in cases of cancer of the breast, submaxillary glands, &c. There is always an interval of time before this secondary infection is set up; and, although the cellular process is not different in kind from the infection of the neighbourhood of the indigenous disease, it is necessary to regard the latter as, in a sense, the parent of the former. This parental relationship is made all the more probable by the fact that sarcomatous tumours, which depend in many cases upon a reversion to or survival of embryonic characters in the mesoblastic cells of a particular locality, are also apt to be followed by tumours in distant parts, particularly in the lungs. In cancers, accordingly, we should distinguish three factors, and in sarcomas only two: in the former we have first the accumulation of cellular by-products of the secretion, next the infection of the predisposed connective tissue by these epithelial products, and lastly the parental influence of the whole primary seat of infection; in the latter we have the embryonic reversion of cells over a particular region, together with their increase or growth, and then the parental influence of the tumour which had so arisen. In both cases the primary tumour acquires a kind of individuality and a power to reproduce itself; but it is only in some cases of sarcoma, especially those soft tumours of perosteal origin which become parosteal, that there is infection of the neighbourhood, whereas a cancer is not a cancer at all until the tissues adjoining or supporting the epithelial secreting structure are epithelially infected. This difference between sarcoma and cancer corresponds to the familiar fact that the former are only occasionally "infiltrating" tumours, being in most cases marked off from the neighbouring tissues by a definite capsule.

The simplest case of discontinuous cancerous infection is in the *lymphatic glands* near the original seat of disease. It is only exceptionally that the lymphatic glands are infected in sarcomatous tumours, and those cases appear to be mostly the infiltrating sarcomas which have the distinctively cancerous property of infecting the neighbourhood. Infection of the axillary lymphatic glands is the common sequel of cancer of the breast, while the epigastric, portal, mesenteric, and other abdominal lymph-glands receive the infection in cancer of the stomach and intestine. In epitheliomas of the lip and tongue the infection of lymph-glands is much slower, and is often so slight as to be undetected during life; it specially affects the lymph-glands under the chin. In all cases the tendency is to reproduce the exact pattern of the primary tumour. In some, including those sarcomatous cases where this kind of infection does take place, the lymph-gland seems to have been transformed *en masse*, very rapidly and directly, so that steps in the process are hardly to be detected. But in other cases it is possible to find, either within the same gland or among the various glands of a cluster, a certain amount of instructive histogenetic detail as to the



mode of infection. The lymphoid cells become affected, not certainly in the way of atrophy, but in the way of transformation. There is indeed nothing more wonderful in the whole range of biological phenomena than to observe the adaptation of the cells and tissues of a lymph-gland to assume the cancerous structure already established in the organ to which they are related, an adaptation always close in its mimicry, involving the co-operation of large groups of cells and fibres, and directed as if by a presiding intelligence. In many instances the infecting substance may even want the perfect cellular character; it may be no more than the detritus or the juices of cells and tissues. The most obvious form of infection, although probably the rarest, is where the new growth extends continuously along the sides or in the interior of lymphatic vessels from the secreting structure to the lymph-gland; but even this continuous extension has been shown to be, not a protrusion of the primary tumour by increase or subdivision of its elements, but a succession of infective transformations along the line of cells constituting the lymph-vessel or investing it. Under all circumstances the lymph-gland becomes changed ultimately into a texture which reproduces with astonishing fidelity the particular pattern of the primary cancer, a pattern which is never quite the same. In any two cases of tumour-disease even of the same organ. In some cases it is not always uniform throughout the same tumour; thus preparations might be described from a cluster of infected lymph-glands under the cancerous mamma of the bitch wherein two kinds of structure in the extensive strip of primary disease are severally reproduced in different lymph-glands.

The infection of the liver is a very common sequel of cancer of the digestive tract, as well as of other cancers, and even of sarcomas (especially the melanotic) and lymphomas. Opinions differ as to the share which the liver-cells take in the building up of the new texture; but there is hardly any room for doubting that it is from the pre-existing cells of each infected area, even if it be exclusively from the cells of the supporting tissue and the capillary walls, that the elements of the secondary tumours are derived by infective transformation. The infection breaks out and proceeds *pari passu* at a number of areas throughout the liver-substance, affecting the whole of an area as if at one blow; there is an absolute lack of evidence in favour of the assertion often made, that the secondary tumours are due to the mere increase, by division, of cells detached from the primary mass and lodged here and there in the liver. There is a certain amount of evidence in favour of some such embolic theory for the secondary tumours of the lungs, which are usually a sequel of sarcomatous growth in some bone or in other mesoblastic tissue. Sarcomatous tumours are apt to grow through the walls of neighbouring veins, and pieces of them doubtless get detached and carried into the pulmonary circulation; but it is more than doubtful whether even these emboli give rise to the secondary tumours of the lungs merely by continuous proliferation of their cells, and not rather by the infective action of their presence.

Another seat of secondary tumour-formation, both epithelial and melanotic sarcomatous, is the serous membranes. The accompanying figure (fig. 54), from a nodule on the diaphragm in a case of cancer of the colon in the horse, may be set beside fig. 51 as showing the substantial identity of the infective process in the secondary and primary seats of disease; in both cases the cells of the connective tissue are seen in the stages of transformation towards the epithelial form and grouping. The infection of the neighbourhood is the essence of the cancerous process. But the discontinuous infection of distant parts is not different from it in kind. It is merely "Wirkung in der Ferne," and it is more mysterious only because it is more remote.

The disorder of secretion thus eventually assumes a cancerous character in which traces of its origin may be hard to find. As the disease persists or extends the patient's colour becomes sallow or dull grey, the colourless cells are increased in the blood, the bones may become fragile, and general wasting (curiously associated sometimes with local production of fat at the seat of disease) puts an end to a life of suffering. In abdominal cancers death may be hastened by dropsy of the peritoneum; in various forms of the disease there may be fatal bleeding from an eroded vessel. It has often been remarked that an appearance of exceptionally blooming health goes with the liability to cancer; and the blooming appearance of the face and plump condition of the tissues will sometimes

persist when the local ravages of the disease have made considerable progress.<sup>1</sup>

§ 9.—THE LIABILITIES OF OBSOLESCENCE.

We have seen in the foregoing sections that various liabilities to error underlie the embryological tissue-developments, the process of blood-making, the process of bone-making, and the process of secretion. But there are functions of the body, of its tissues and organs, in which the morbid liability is something special. The most striking instance of this is in the reproductive organs, particularly those of the female; the obsolescence of the function, and in part of the structure, in the ovaries, uterus, and breasts of women long before the natural term of life creates a peculiar liability to disease. There are two other organs, the thyroid and the suprarenal, which hold a somewhat special position; it cannot be doubted that each of these organs plays an important part in the economy, but there are suggestions in their morphology of survivalship from a former state of things, and their diseased conditions are not only peculiar in their occasion but also peculiarly important in their consequences. Lastly, there are two minute bodies situated at the bifurcation of great arterial trunks, the coccygeal gland and the intercarotid body, which are clearly marked as survivals; and the former, at least, of these carries a peculiar liability to tumour-disease during the period of intra-uterine life. These instances do not include the so-called "involution-diseases" or the liabilities of old age. The self-limitation of life may be said to be too large a problem for the present purpose; but sexual involution is a part of this problem which comes directly into pathology.

*Cancer of the Breast in connexion with Obsolescence of Structure and Function.*—The diseases of the climacteric period in women make an important chapter in the special pathology of the sex; together with the disorders incidental to maturation, they stand for the larger part of the special ill health of women. It will not be possible in this article to give more than a single illustration of the morbid effects of this peculiar periodicity, namely, the obsolescence of the mammary function. The statistics collected by Paget clearly show that cancer of the breast in women is peculiarly a disease of the climacteric and post-climacteric period; throughout the whole period from the age of about fifteen to about forty-five, during which the breast is capable of lactation, the cancerous disorder is rare in it, the tumour-disorders to which the organ is then liable being comparatively tractable. A few words about the physiology will serve to indicate the pathology of the simpler as well as of the more formidable malady.

The reproductive functions in the female are not only peculiar among other functions of the organism in their maturation and obsolescence, but they are further remarkable for their periodicity within the period of vigour itself. In the lower species of the vegetable and animal kingdoms seasonal periodicity is in every thing, in the higher it is only in the sexual and secondary sexual characters, and in the human species it is practically confined to the reproductive system. The consequences, as regards the breast, are that its structure and function unfold during the term of gestation, continue in full vigour for a longer or shorter period (which may be arbitrarily limited), and then go through definite stages of subsidence and upfolding to the resting state. This periodical reduction of structure in an orderly way is a peculiar and unique thing; it is "as though a rose should shut and be a bud again." The upfolding and unfolding of structure have corresponding functional aspects; there are crude secretory products formed and discharged, and hence it is that the breast is a peculiarly suitable organ in which to investigate the question of cellular by-products or waste of secretion, and their disposal by the lymphatic system. Compared with other secreting organs and parts the breast is not peculiarly liable to catarrh, but it has a physiological liability of its own which puts it on the same footing, as regards tumour-disease, with the great seats of catarrhal disorder, the stomach and the cervix uteri. Like these organs, it is not generally subject to cancer until after middle life; but, whereas in them the predisposition appears to depend on long-continued functional irregularities, the liability of the breast arises out of its

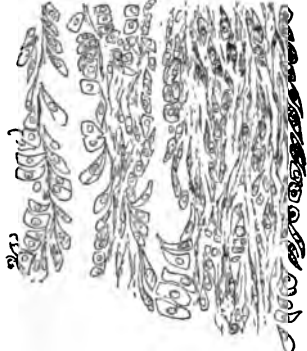

FIG. 54.—Cancerous nodule on the peritoneal surface of diaphragm, secondary to cancer of the colon (horse).

<sup>1</sup> See Paget, *Lectures on Surgical Pathology*; Rindfleisch, *Die Entstehung der Carcinome, dargestellt als eine Folge ihrer frühchen destructivität*, Leipzig, 1877; various contributors in *Pathol. Trans.*, xxv., 1874; C. H. Moore, *The Antecedents of Cancer*, Lond., 1865; K. Thiersch, *Der Epithelialkrebs, namentlich der Haut*, Leipzig, 1865;

normal obsolescence. Its secreting mechanism becomes finally broken up, so that one may find little left besides traces of the larger ducts in the midst of wide areas of fibrillar tissue and fat. Traces of the glandular structure persist to a very various extent in different women, and even in different parts of the same breast. It is obvious that the process is one which offers numerous opportunities for a devious course; it may be retarded, or advance unequally, or be in the end incomplete. That which in all cases must be held to create the peculiar liability to ганкерous infection is the readiness of the preponderant connective tissue to be acted on by epithelial cells dispersed throughout it or otherwise in direct contact with its corpuscles.

#### § 10.—SPECIAL LIABILITIES OF THE SUPRARENAL AND THYROID.

(1) *Of the Suprarenal—Addison's Disease.*—The peculiar condition of ill health—always fatal—which Addison discovered to be associated with caseous degeneration of both suprarenal bodies was described by himself as "anæmia, general languor and debility, remarkable feebleness of the heart's action, irritability of the stomach, and a peculiar change of colour in the skin." Some of these symptoms appear to be due to interference with the function of the sympathetic nervous system; the disease, as a whole, however, is almost certainly the direct effect of withdrawal from the general life of the body of those services which the suprarenals are adapted to render. Where there is no caseous degeneration (and consequent non-circulation of blood) in each of the suprarenals the peculiar group of symptoms constituting Addison's disease does not occur; there may be hyperplasia (*struma suprarenalis*) of one or both suprarenals, or even true cancer of one or both, but these morbid conditions do not seem to be able to produce the same effect on the organism which is produced by caseous degeneration. On the other hand, Addison's disease has resulted in a few cases where the suprarenals had not been destroyed by caseous degeneration, but had undergone extreme atrophy. We shall best approach this somewhat intricate disease by considering it from the point of view of suprarenal function, and of the peculiar relation of the present probable function of the organ to its past morphological history.

*Evidence of Suprarenal Function.*—A simple experiment will show that the blood passing through the suprarenal receives important additions. If the organ taken quite warm from a recently-killed animal, such as the horse, be cut into pieces and placed in a solution of potassium bichromate the central region assumes a rich brown colour. Under the microscope the brown colour will be found to reside in the coagulated plasma filling the numerous lacunar spaces and large veins of the central region and in the cells adhering outside their walls. At the same time it will be seen that the groups of red blood-disks, wherever they occur in the coagulated plasma, form areas of bright green colour. These colour-reactions with chromium are not known to occur anywhere else in the tissues and fluids of the body; there is that in the outgoing blood of the suprarenal which reduces the orange-red chromium-salt to a brown oxide, and (in the case of the red blood-disks with more oxygen) to a green oxide. It will hardly prove an easy task to isolate the substance whose existence is thus indicated, but it is not difficult to follow in the suprarenal structure the adaptations for supplying some such substance to the blood. It is precisely analogous to the adaptation of the placenta, as described above (p. 374), for supplying its metabolic product to the blood destined for the fetus. Several arteries reach the suprarenal all round its circumference; they break up into capillaries which radiate to the centre, carrying the suprarenal cells closely adherent to their walls; towards the centre certain lacunar spaces form, and from these the central outcarrying vessel receives its blood, being provided with contractile muscular walls (in man, the horse, &c.). Whatever is added to the blood passing through the suprarenal must come from the suprarenal cells. There is reason to suppose that this addition is an actual exuded plasma, just as it is in the placenta. In the latter case the added fluid drops from the protoplasmic wall of the vessel into the circulating blood; in the suprarenal a membrane is interposed between the lumen of the vessel and the cylinders of secreting cells, namely, the wall of the vessel itself. In this respect the suprarenal cells are as well placed for contributing to the blood flowing past them as are the liver-cells for exercising their glycogenic function. We shall conclude, at least, that the suprarenal blood has received additions whilst in the organ, and that these

additions have been a material exudation (plasma) from the suprarenal cells.

The caseous or putty-like or cretaceous change which overtakes the suprarenals in Addison's disease involves the complete suppression of this function, for it practically amounts to the arrest of circulation through the organ; blood neither enters the organ nor passes out of it, and there can be therefore no metabolism. Whatever be the nature of the services that this remarkable organ is adapted to render to the general life, Addison's disease is the evidence that such services cannot permanently be withdrawn with impunity. The most striking effect is the formation of brown pigment, often so abundant as to appear almost black, in the lower cells of the rete mucosum in certain regions of predilection of the skin, and here and there in the mucous membranes. Doubtless a large part of the symptoms of Addison's disease might be traced vaguely to disorder of the sympathetic nervous system; but, while it is difficult to prove the existence of such disorder of the solar plexus, except as an inference from the symptoms, we have the patent fact that the full train of symptoms in Addison's disease is associated with loss of suprarenal structure and function, including naturally so much of the structure and function of the sympathetic nerve as properly belongs to the organ.

The causes of the molecular decay of the suprarenals and consequent cessation of their function are various. It may be the mere contiguity to a lumbar abscess, or it may be a part of general tuberculous disease in the body, or it may be associated with no extrinsic morbid condition whatsoever. Enlargement seems usually to have preceded the final molecular break-down. The liability of the suprarenals (with or without preceding enlargement) to caseous degeneration must be considered to be somewhat special to the pair of organs, just as the suppression of their function is of special significance for the life of the body. The caseation soon overtakes the whole structure on both sides, so that a relatively small amount of that not very rare degeneration is of fatal import if the suprarenals be the seat of it. There is a good deal of morphological and developmental evidence that the suprarenals are in one sense obsolete, their structure being, however, adapted or utilized for new functions; associated with this adaptation of the organs we have the peculiar instability of their protoplasm, the absence of any power of recovery, and the very marked and fatal effects that follow the withholding of their contributions to the metabolism of the body.

(2) *Special Liabilities of the Thyroid Gland.*—The thyroid is in some respects parallel with the suprarenals. Its cells furnish a mucus-like plasma which is, in the first instance, poured into the closed vesicles of the organ, but is taken up again and carried into the circulation (as Baber's observations tend to prove, *Phil. Trans.*, 1876, 1881) by the lymphatic vessels in their walls. We have not to consider those not unimportant or infrequent morbid conditions which are associated with the peculiar functional position of this organ.

*Goitre.*—The grand disease in which the functional activity of the thyroid is implicated is goitre. Under certain conditions of locality a large part of the population becomes goitrous, that is to say, their thyroids undergo enlargement. (See GOITRE.) There have also been epidemics of temporary enlargement of the thyroid in garrisons. The simple enlargement undergoes a considerable variety of subsequent changes in the different cases; it may be general or partial at the outset, it may become cystic or "aneurismal," gelatinous or hæmorrhagic, it may become fibrous, very generally it becomes petrified at various centres, sometimes there is a kind of caseous framework developed through its substance, and there may be amyloid concretions. These transformations are too many and complex to be entered upon, although they are full of interest for the elucidation of indwelling embryonic tendencies. The primary fact is enlargement of the thyroid among populations whose food, water, air, or environment generally has something defective or unsuitable. The enlargement of the thyroid means that the organ has greater calls upon its ordinary function, that it makes an effort to meet the circumstances of the case. And there can be no doubt that in most cases the effort is successful; for goitre, apart from the inconvenient size of the thyroid and the mechanical consequences of pressure, is a harmless condition. The subsequent changes in the enlarged organ are the inevitable consequences of hyperplasia; but the primary enlargement is conservative and adaptive. The adaptation has the effect of elaborating from the blood brought to the thyroid more of the mucous substance which it is the office of the thyroid to elaborate, the same being probably returned to the blood more or less directly. There is that in the water, food, or air of these populations, and in the nutrition of men and animals in isolated cases elsewhere, which calls for more of this peculiar metabolism.

*Myxædema.*—Surgeons have in some places practised removal of the enlarged thyroid; and attention has lately been called in Switzerland to the after-effects of such removals. The connective tissue in all parts of the body has become occupied with a mucus-like substance or has shown evidence of unwonted functional and

plastic activity in its cells and fibres. Of eighteen cases of complete removal of the enlarged thyroid at the hospital of Bern this condition followed in sixteen, and in the two which escaped it an "accessory" thyroid had arisen. The condition is that which had been described by Ord as *myxodema* (from the mucous dropsy of the skin), a progressive disease; with hebetude and other symptoms of impaired higher functions, and tending to a fatal result in a few years. The interesting fact is that in such cases of idiopathic myxodema the thyroid has very generally been observed to be small or wanting; where the diminished organ has been examined after death it has been found practically reduced to a mass of connective tissue infiltrated with mucus, like the connective tissue elsewhere. The relation then between the cases of myxodema following operative removal of a goitre and the idiopathic cases would seem to be that, in the one, a mucous condition of the whole connective tissue of the body follows when the thyroid, enlarged to meet the metabolic needs of the body, has been removed by the surgeon, while, in the other, the same condition has followed where the thyroid has either proved too small for the ordinary metabolic ends that it is adapted to serve, or has degenerated under an unusual call upon its metabolism. Of the nature of this metabolism we are ignorant; we know only that a material fluid is elaborated, and that the fluid is of the mucous kind.

*Cretinism.*—If reference be made to fig. 40, showing the more spongy tissue of the placenta, it will be seen that there also a fluid is elaborated and added to the blood from the richly protoplasmic walls of the vessels; and that fluid is also of the mucous kind. It is the "uterine milk" of earlier authors, and it would appear to exude through the densely nucleated marginal tracts of the placenta where the fetal vessels and their plasmatic supporting tissue touch it. It is this great metabolic function, so essential to the vigorous development of the child, that is probably at fault in the poor and over-worked or otherwise over-taxed mothers whose offspring become rickety; and the fault may be said more particularly to be deficient quantity or quality of the placental mucous secretion. The similarity of the thyroid and placental metabolisms cannot but come into account in considering the very peculiar condition of cretinism, proper to the offspring of goitrous mothers, or of mothers who had resided during their pregnancy in a goitrous district.

Under the same endemic circumstances which cause the compensatory enlargement of the thyroid in the parents we meet with cretinism in the offspring. Although the defects of development and growth in cretinism are on the whole different from and much more universal than those of rickets, yet there is a certain parallelism between the two conditions. The cretin, like the child who becomes rickety, must have been born with the disposition. The condition is not inherited, but it is congenital,—that is to say, it is derived from the mother in respect of her pregnancy only, and that means that it is derived most of all from the placenta. *Cretinism is to goitrous districts what rickets is to other localities.* And, although there is no positive evidence as to the placental function either in the one case or in the other, yet the placenta is clearly pointed to in both cases; and we may conjecture that cretins are the offspring of those mothers whose maternal nutriment is impaired, not by the general hardships of those who bear rickety children, but by the special endemic conditions which serve also to tax that other mucus-producing organ, the thyroid gland. The endemic conditions may not have caused goitre in the mother, although, as a matter of fact, they generally do; but, under a special concurrence of circumstances, as common in goitrous districts as are the determining causes of rickets elsewhere, they have caused a cretinous habit of body in the child, and to do so they must have affected the placental efficiency in some manner as yet unknown.

This mode of associating goitre and cretinism assumes an error in the placental function which has not been shown by direct observation of the placenta to have existed. It has probably not been looked for; and, even if it had been, there would have been some difficulty in making out its morphological characters. Under the circumstances of the case the evidence can hardly be other than deductive.

*Graves's Disease, or Exophthalmic Goitre.*—In certain cases of anemia in women there is enlargement of the thyroid, fluctuating in amount or permanent, but not liable to the common developments or degenerations of endemic goitre. Associated with the anemia and the enlarged thyroid there are disturbances of the functions of the sympathetic nervous system and a remarkable prominence of the eyeballs. It is probable that another aspect of the thyroid function than the mucus-making is involved here. It is an old contention of Kohlrausch that the droplets of hyaline substance, often with a yellowish or pale reddish tint, that are found in the thyroid mixed with the ordinary mucus of its alveoli were an embryonic form of blood-globules. In the thyroid of the dog these droplets may be often seen of a more uniform size, and so like blood-corpuscles (allowing for irregularities of form and size) that they have been actually regarded as such, and put down, when in considerable quantities, to "hemorrhage" from the vessels that run on the other side of the epithelial wall of cells. There is not the slightest reason to sup-

pose that these droplets have escaped from the blood-vessels; they are produced from the epithelium of the organ along with the other mucus-like fluid. They point, indeed, to a hematoblastic function of the cells, somehow correlated to their ordinary mucus-yielding function. There are analogies among the connective tissues, at least, for this correlation between mucous and hematoblastic production, in new growths, and there is an analogy in the early stage of embryonic fat-formation, in the production of red blood-disks from the same mesoblastic cells at one stage of their existence and of mucus-like fluid within them at the next. Now, although there is no evidence that the enlargement and increased functional activity of the thyroid in these peculiar cases of anemia has a more special relation to the hematoblastic side of the function than to the mucous, yet the coexistence of an enlarged thyroid with certain cases of anemia becomes intelligible in the light of these indications of hematoblastic function. The enlargement of the thyroid may be considered a special effort, comparable to the effort of the bone-marrow in pernicious anemia. The profound disturbance of the vascular system which goes with this condition must stand as an empirical fact, but it may be classed with the analogous sympathetic disturbances in Addison's disease; both the suprarenal and the thyroid are to be considered as organs in which disorder of function has a special relation to the sympathetic,—the abdominal sympathetic in the one case and the cervical in the other. It is to be observed that in common goitre, where there is not so much an alteration, diversion, or disorder of function as a compensating increase of the ordinary function, there are no symptoms referable to the sympathetic; so that the relation in the enlarged thyroid of anemia cannot be a mere mechanical one.

*Secondary Tumours of the Thyroid.*—The last special liability of the thyroid to be mentioned is a very peculiar one; there is a number of well-authenticated cases in which a simple enlargement or hyperplasia of the organ has been associated with the new formation of masses of the proper thyroid-texture, with the proper mucous secretion, in the lungs and at various points of the subcutaneous tissue. In these cases the hyperplastic thyroid exhibits the property of an infective tumour, the new growth of thyroid-tissue at remote points being the secondary products of infection. Is there anything in the normal overgrowth of the thyroid to account for its infectiveness as manifested on rare occasions? One of the unsettled questions of thyroid physiology is the mode of development of the new alveoli when the organ enlarges. It is apt to be too readily assumed that the new structure is formed by continuous extension from the pre-existing, by expansion or germination; but the point has been raised by observers whether the new alveoli are not formed interstitially at numerous independent centres throughout the stroma or supporting tissue of the organ, at first as small groups of cells which come to develop a space in their midst, and to group themselves as epithelium round the periphery. This is the ordinary mode of interstitial development in cancerous infection; and, if that mode be substantiated for the physiological increase of the thyroid (and the facts in the dog's thyroid point that way), it would enable us to understand how it is that sometimes, as if in a freak, the simple hyperplastic thyroid plays the part of an infective tumour, reproducing its own likeness at discontinuous and even distant centres.<sup>1</sup>

#### § 11.—ERRORS OF METABOLISM.

In the foregoing sections metabolic functions have been claimed for the placenta, for the suprarenal, and for the thyroid. Connected with these obscure and hitherto almost unregarded metabolic functions are several important morbid conditions, which are mostly of the so-called constitutional sort; with errors of the placental metabolism we connect such defective intra-uterine endowments of the fœtus as gave rise to rickets and cretinism in the child (and, it may be added, to some of the manifestations of congenital syphilis); with loss of the suprarenal metabolism we connect Addison's disease; and with a compensating or conservative increase of the thyroid metabolism we connect goitre, a condition which is harmless but for its mechanical effects. It will now be convenient to pass to those greater but hardly better understood metabolic

<sup>1</sup> See Thomas Addison, *On the Constitutional and Local Effects of Diseases of the Suprarenal Capsules*, Lond., 1855; Greenhow, *On Addison's Disease*, Lond., 1875; Id., in *Trans. Internat. Med. Congress*, Lond., 1881, vol. ii.; Wilks, "Addison's Disease," in *Reynolds's System of Med.*, vol. v., Lond., 1879. Goitre, Cretinism, &c.—Hirsch, *Historisch-geographische Pathologie*, 2d ed., vol. ii., Stuttgart, 1883 (Engl. trans.); Virchow, *Ges. Abhandl. zur wis. Med.*, Frankfurt, 1856, p. 891; Ord, "On Myxodema," in *Med. Chir. Trans.*, 1876; and various authors in *Clin. Trans.*, 1882-84.

functions with whose disorders are associated some of the severe diseases of common occurrence, taking them according to the organs, and taking the liver first.

The liver-structure is very much that of a blood-gland; its system of bile-ducts is subordinate to its blood-system, just as its biliary function, though the amount of its product be great, is in modern physiology subordinate to its glyco-genic. Except in connexion with JAUNDICE (*q.v.*), the biliary function does not concern us; we come at once to the not uncommon and very serious malady which may be regarded as an error of the glyco-genic function, namely, diabetes.

*Diabetes.*—Like the errors of metabolism treated of in previous sections, diabetes is a "constitutional" or general disease. It depends essentially upon the circumstance that the blood passing to the kidney is overcharged with sugar; the kidney drains off the sugar along with an immense quantity of water, so that the prominent symptom is copious urine loaded with sugar. Diabetes can hardly be called a disease of the kidneys; these organs are but the ministers of disordered metabolism whose seat is elsewhere, and their structure is not even materially altered in the disease. In pronounced diabetes sugar is everywhere. There may be half a per cent. of it in the blood, it is in all the tissue-juices and in all secretions, and it may enter into the composition of the urine to as much as 10 per cent. The diabetic patient drinks enormously (the thirst being due, it is conjectured, to the more concentrated state of the sugary blood), and eats or desires to eat two or three times more than in health; the amount of urine voided is proportionately great, and it contains a total of urea in the twenty-four hours which corresponds approximately to the high feeding. All the while there is no proper nutrition; the body wastes, the skin becomes dry, the hair falls out, the muscles become flabby, the heart's action is weak, and the secreting organs become reduced in bulk and enfeebled in function. Wounds tend to become gangrenous, boils and carbuncles are apt to form, and pulmonary consumption is a frequent complication. The saccharine state of the fluids is favourable to the lodgment of fungi (moulds), and these are found in the centres of disease in the lungs. The disease is an example of those paradoxes that we frequently come to in the last resort in the analysis of constitutional disturbances; in spite of the enormous supplies that the organism demands (and receives), the tissues and organs are not nourished. It is only in some cases that the disease is checked by a pure nitrogenous diet. There is some maladaptation in the economy whereby there is an enormous quantity of sugar produced which is not wanted, and a great lack of that which is wanted. Where does the divergence occur from the physiological track?

The blood ordinarily contains a trace of sugar, and traces of it may be discovered in the urine. It may be permitted to regard these traces as no more than the slight margin of non-perfect adaptation which is discoverable in many structural and functional effects. But the antecedent of this sugar, namely glycogen, exists in considerable quantity in animals the moment after death, and is assumed to exist in them during life. Although this assumption must be granted, it is not so justifiable to admit, with some authors, that the glycogen of the body is normally changed into sugar, the latter being at once disposed of in the further course of combustion.

Glycogen is now known to exist in various tissues, more particularly in inactive muscle; but it is impossible to conclude, on the evidence, that the liver is still the organ of its choice; and Bernard's original position, that diabetes is a disorder of the glyco-genic function of the liver, may be regarded as the reasonable one. The structure of the liver is in great part an adaptation to some such metabolic function, an adaptation to take somewhat from the blood and to add somewhat to the blood again. The intermediate state of this metabolism is glycogen, a starchy substance which changes to sugar under the action of a ferment out of the body, and changes to sugar sometimes in the body. Various kinds of interference cause glycogen to change to sugar within the body—puncturing the medulla oblongata at a particular spot with a fine spear-like point; the administration of curare, whose chief action is to paralyse the muscles through their nerves; the administration of nitrite of amyl, whose more obvious effect is vaso-motor paralysis of the surface-vessels, causing dilatation of them. These interferences produce a passing diabetes. It has been objected that the diabetes so produced is too transitory to be counted as analogous to the grave human malady; but it is well known that the same transitory effects are not uncommonly met with in medical practice. The true and serious diabetes is merely the established and confirmed habit of turning everything to sugar, and it cannot be doubted that Bernard's original experimental analogies are still the best clue to the nature of the disease.

These experimental interferences point to some profound upset of the nervous control. The spot in the medulla where puncture causes temporary diabetes is otherwise known to be the vaso-motor centre; the effects of nitrite of amyl are otherwise such nerve-effects as

blushing; the several effects of curare are identical with the muscular limpness of fear. The observations of clinical medicine point in the same direction; a large proportion of all the cases of diabetes where the antecedents have been ascertained with any degree of relevancy are cases of profound emotional and intellectual strain, of shocks and jars and worries to the mind, and especially to the primary instincts and affections. Along with these we have a few significant cases of tumour in, or upon, or in the neighbourhood of the medulla. These clinical facts point clearly enough to some upset of the nervous control, although there are certainly few or none of the usual concomitants of nervous disturbance. The nerve-paths that are implicated are the same as the vaso-motor; but the effects themselves are not vaso-motorial. Nitrite of amyl causes artificial blushing, and it also causes diabetes; in like manner those subjective states of the mind (or mechanical states of the brain) which ordinarily take such outward directions as blushing and pallor, or the vaso-motorial direction, sometimes spend themselves otherwise, causing an upset of the glyco-genic adaptation. It is certainly not a simple affair of vaso-motor paralysis, even if the path of influence be the same. Some nervous mechanism allied to the vaso-motor, or using the same path of influence, is probably concerned, the same kind of unknown nervous mechanism which would appear to be concerned in Addison's disease (of the suprarenal) and in Graves's disease (of the thyroid). The upset of this controlling nerve-force is followed by the production of a substance from the liver-cells which is directly added to the blood as sugar, and is removed as sugar in the urine. This substitution of sugar in the blood for some other substance is fatal to nutrition; it is so wasteful an expenditure that the physiological bankruptcy cannot be averted even when the patient receives the enormous amount of food and drink for which he craves.

For the pathology of diabetes the obvious desiderata are to know the normal sources and normal ways of disposal of the glycogen of the liver. It seems to be premature to infer that, because glycogen, as its name implies, may easily become sugar, therefore it ordinarily does become sugar as a transition-stage towards some other product. If the regular conversion of glycogen into sugar be assumed, the cause of diabetes would be referred to the inadequate disposal of the sugar (*e.g.*, its inadequate combustion in the lungs). Cohnheim, after summing up the evidence from all sources, concludes that such inadequate disposal of sugar, properly present in the body, does occur in diabetes; and he would seek for the reason of the failure in the want of some "ferment" which, in health, brings about the further breaking up of the sugar. The question, however, is a sufficiently open one for us to contend that the initial error lies in the making of sugar at all; or, in other words, that the failure of the ferment (or of the nerve-control of metabolism) has to be assigned to an earlier stage of the metabolic process.

It is probably more than an accidental coincidence that the pancreas has often been found shrunken and indurated in diabetes, the shrinkage having followed apparently on an earlier hyperplasia. According to analogy it would mean that the error of the hepatic function had thrown more work upon the pancreas. Apart from the state of the pancreas there is nothing distinctive in the structural conditions associated with diabetes.

*Acute Yellow Atrophy of the Liver.*—Here we have another severe constitutional disorder, but much rarer than diabetes, in which the hepatic functions are chiefly, and perhaps primarily, concerned. It arises under a variety of circumstances, the chief of which are respectively poisoning by phosphorus, profound emotional troubles, and the state of pregnancy. The early implication of the hepatic functions is shown by the existence of a degree of common jaundice for some time before the distinctive and fatal onset. The disease may be said to consist in a complete disorganization of the whole hepatic activity,—in the arrest of its biliary secretion and of its other metabolism. The liver-cells fall into a state of molecular disintegration, and the organ shrinks bodily, sometimes to a mere fraction of its original volume. The ducts contain no bile, but a colourless plasma in place of it; the cells, where they keep their outlines, are full of albuminous granules; large quantities of leucine and tyrosin are found in the organ after death. What is there common to phosphorus-poisoning, profound emotional troubles, and the state of pregnancy which can be brought into relation with this remarkable upset of function and rapid disintegration of structure?

As regards the effects of phosphorus, they belong to a remarkable class of effects, counterfeiting idiopathic diseased states, which it is the property of certain of the chemical elements, including arsenic, antimony, and lead, to induce. The action of this element may be said to be an arrest of metabolism, falling with special stress upon the great seat of such functional activity (and on the secreting cells of the stomach and kidney as well). As regards the acute yellow atrophy of the liver which follows profound emotional troubles, we have many lighter analogous instances of nervous inhibition of visceral function due to more transitory states of emotion; the disorganization of the liver-function would be the proportionate effect of a more profound and more lasting mental

trouble. As to the acute yellow atrophy of the pregnant state the circumstances are doubly complex. In all the incidents of pregnancy we must take into account the placental function, a metabolism almost as great for the time as that of the liver itself; and, if we are to find any link of connexion between the seemingly diverse conditions here in question, we should have to resort to the somewhat vague generality that, in a rare concurrence of circumstances, the placental function makes demands upon the maternal blood and tissues, or upon the ordinary metabolisms of the mother, which are of an upsetting kind, the incidence falling sometimes on the metabolic functions of the liver.

*Albuminuria.*—The waste of albumen in the course of the urinary excretion is a much more frequent and hardly less serious factor in disease than the sugar-waste; but albuminuria differs from diabetes in two important respects: firstly, the albumen which escapes is, in great part at least, the proper albumen of the blood (serum-albumin and globulin); and secondly, there goes hand in hand with the error of function a series of progressive structural changes fatal to the general efficiency of the kidney itself. Albuminuria is the functional error that corresponds on the whole closely to *Bright's disease*; but it would be a mistake to suppose that Bright's disease can be measured by the amount of albumen lost. A consideration of these complex forms of constitutional disturbance may proceed, however, from the side of albuminous leakage, and from the point of view of the adaptations in the kidney whereby the leakage is ordinarily prevented or reduced to a minimum.

The problem, as it may be called, of the renal excretion is how to discharge from the blood and from the body absolutely the washings of the tissues, or the waste-matters of metabolism, without allowing other dissolved substances of the blood to be discharged at the same time. In adaptation hereto, the kidney is in part a secreting organ and in part a mechanical filter. Those parts or regions of its structure where its epithelium is in the form of very large and richly protoplasmic cells have a true secretory function, so that nothing passes from the blood to be cast out from the body except through the interior of a very considerable cell, and in all probability through a metabolic selective process therein. This is known to be the urea-region of the kidney; and the separation of urea from the blood may be said to be the greatest of the renal functions. But by far the largest part of the urine, namely the water of it, is strained off from the blood by another kind of kidney-structure, which is more truly a mechanism; not all the water of the urine, but the greater part of it, is filtered from the blood as it passes through the remarkable coils or glomeruli of small vessels which are placed at the farther end of the tubular system. In these the structural adaptations all point to mechanical filtration and not to selective secretion. The circulation in the vascular coils of the kidney is unique as regards the balance of driving force and resisting force; the lateral pressure in these spherical coils of small vessels is greater than in any other capillary region of the body. It is indeed great enough to cause a transudation of water; but is it so nicely balanced as not to allow an escape of albumen? There can be no question that albumen does often find its way into the urine without amounting to a serious functional error or to a clinical condition of disease; and it is equally certain that the leakage takes place at the glomeruli. Albumen is found so often in the urine when it is looked for systematically from day to day that we may admit, with Senator, that any one may be more or less albuminuric from time to time. In 119 healthy soldiers, 19, or 16 per cent., had albumen in the urine; in 200 seemingly healthy persons examined for life insurance there were 24 with albumen, or 12 per cent.; in 61 healthy children, 7, or 11.5 per cent.; in 82 hospital attendants in good health, 14, or 44 per cent. Add to these experiences the difficulty of detecting small quantities of albumen in ordinarily dilute urine and the impossibility of detecting certain varieties of albumen (known to occur in the urine) except by special tests, and we may safely conclude that the filtration of water from the blood in the renal capillaries is very apt to be attended with a slight leakage of albumen also. The adaptation that water should drain off, but not albumen, is a very nicely balanced one, and therefore very easily upset. As a matter of fact it is frequently upset; the physiological albuminuria, like the physiological glycosuria, and like the small admixture of colourless cells among the multitude of blood-disks proper, is the narrow margin of non-perfect adaptation which meets us frequently in the economy of living organisms. The nicely-adjusted balance of driving force and resisting force in the vascular tufts is constantly exposed to disturbing influences, so that one may reckon to find a certain small average of albuminous leakage.

The great occasion of this leakage is sluggish circulation through the glomeruli, whether from over-distension of the veins beyond or from other cause. The faster the blood passes through these capillaries the greater the quantity of water drained off, and the more minimal the quantity of albumen that escapes; but when the blood travels slower there is absolutely less water filtered off in a given time, and the proportion of albumen that passes with it is increased from a minimal quantity to something considerable. Thus a con-

gested state of the kidney, whether the embarrassment be traced to the side of influx or of efflux, to the arterial or the venous side, is favourable to the leakage of albumen, and a large part of all the albuminuria of medical practice is of that nature. The congested state has been often experimentally induced in animals by various devices, and the laws of albuminous leakage have thus been determined with an exactitude which is very considerable. In these experiments the embarrassment of the circulation has been induced in various ways—by clamping the renal vein so as to dam up the blood in the kidney, by clamping the renal artery, by interfering with the nervous mechanisms, either at the spot or more centrally, and by introducing toxic substances into the circulating blood. Probably all of these forms of experimental interference have their analogies in disease, although the gross mechanical impediments are a rare type. The albuminuria of the pregnant state—not certainly an invariable occurrence, but rather a liability of that condition—may be referred in great part, if not altogether, to embarrassed venous reflux, for there are analogous cases of temporary albuminuria in which the cause is not the gravid uterus, but a uterine or ovarian tumour. In pregnancy it is specially apt to occur in primipare and in cases of twins, and in the later months. Again, the albuminuria of some forms of heart-disease, of emphysema, and of chronic bronchitis is an affair of difficult venous reflux. It is on the arterial side that we have to place the determining forces of a considerable number of albuminuric cases, and these the most insidious. In all those cases where the congestion of the kidney is "inflammatory" there are the irregularities of circulation usual in inflammation, the parenchymatous cellular changes of inflammation, and the somewhat difficult correlation between these two factors in the process. These cases may be said to exhaust the instances of albuminuria due to heightened blood-pressure. The albuminuria of cachectic subjects is known to be dependent mostly on the impaired integrity of the glomerular vessel-walls,—on an amyloid change in them which permits the transudation of albumen under the ordinary conditions of pressure. But there is still a third determining cause of albuminuria, namely, a changed state of the blood when both the pressure and the state of the vessel-walls are constants.

It has been mentioned that there are two instructive points of contrast between the drain of sugar and the drain of albumen; the sugar is not ordinarily present in the blood, and its discharge by the kidney is unattended with structural changes in that organ. The albumen of albuminuria is to a great extent the ordinary albumen of the blood (serum-albumin and globulin); but in the urine there are other albumins found which are not ordinarily present in the blood, such as the variety identical with pepton, and another variety, hemialbumose, or "propepton." The latter is found in cases of osteomalacia, and it may be detected under other circumstances as well. Even when there are no new and specially diffusible albumins in the blood, it is probable that some alteration in the relative composition of the blood—in the proportion of its salts and the like—will make its albumen more liable to transude in the renal glomeruli.

The albuminuria of phosphorus-poisoning and of acute yellow atrophy of the liver raises another possibility,—the possibility, namely, that the albumen is produced in the course of the metabolic process in the proper secreting epithelium of the kidney-tubules. Certainly the large epithelial cells of the kidney in these two conditions are filled with peculiar granules of "albuminous" matter. The question has to be at least entertained, whether certain cases of albuminuria may not be due to a primary disorder of the renal metabolism, to some interference with its "ferment."

Four factors, then, are concerned in the waste of albumen, and they may act either singly or in combination. In the order of their importance they are:—(1) disorder of the vascular pressure, whereby the nicely-adjusted filtering mechanism in the glomeruli is deranged; (2) states of the blood exceptionally favourable to the diffusion of its albumen, or even the presence in the blood of peculiar forms of albumen with high diffusibility; (3) a more permeable condition of the vessel-wall (as in amyloid disease); and (4) an error in the proper metabolism of the secreting epithelium whereby an albuminous by-product is formed from it. It now remains to consider briefly the other distinctive point in the acquired habit of albuminous waste, namely, the associated structural changes.

*Structural Changes in the Kidney.*—If the kidneys be examined from a case in which the symptoms, sometimes lasting for years, had been albumen in the urine (with cylindrical casts of the kidney-tubules), a more or less scanty amount of urine, and a small proportion of urea, together with dropsy and marked anæmia, they will most likely be found to be enormously enlarged, and of a pale fawn colour, compared by Watson to the cut surface of a parnipp. This is the "*large white kidney*" of chronic Bright's disease, the enlargement being in the outer zone of the organ, in the region of the glomeruli and secreting tubules. "The incised surface gives one the notion of some deposit whereby the original texture of the part is obscured." How comes it that an attack of congestion at some more or less remote period, or repeated congested states of the

organ, have led to so remarkable a result? It does not help us, for the purpose of rational analysis, to turn to "inflammation" as a last resource; what the analysis really conducts us to is the correlation between the disordered function and the structural changes.

It is impossible not to connect the remarkable form of hyperplasia in the large white kidney (or where there is also the amyloid complication) with the albuminous character of the exudation in which the organ, and more especially its cortex, is bathed. Sugar, as we have seen, has no such effect on structure, nor has uric acid, as we shall see in speaking of the kidney in gout; the albumen has a special influence on the local centres of nutrition, on the cells and tissues of the organ. Again, the excess of nutrition does not conduct to increase on the normal lines. There are such cases of normal increase in the kidney's bulk, as when one kidney has to do the work of two, owing to removal or congenital absence of the other. But in the large white kidney of albuminuria the increase is of an unprofitable kind; it is a hyperplasia that not only does not add to the efficiency of the organ but even seriously impairs it. The large epithelial cells of the secreting region are clouded with albuminous deposit, and their nuclei show a fainter reaction to the colouring agents; or they fall into an unstable granular condition and into molecular detritus; or they are shed bodily into the lumen of the tubule. The flattened cells of the Bowman's capsule are less apt to degenerate; they are more likely to multiply *in situ*, and to build up an unnaturally thick wall around the capsule. Further, the interstices of the tubules and the margins of the glomeruli are occupied by collections of round nuclear cells, like the collections underlying a catarrhal mucous membrane. All this activity is misdirected; it does not help the function, but overwhelms it. The urine is scanty and the proportion of urea small; and these consequences may be traced, firstly to the sluggish circulation within the organ, and secondly to the complete obliteration of some glomeruli and the cumbersome thickening of others, and to the degeneration of the secreting epithelium interfering with its proper metabolism. There is hardly any tendency to *restitutio ad integrum* in the large white kidney, the unprofitable overfeeding of its elements continuing to the end.

Contrasting with the large white kidney is the *contracted kidney* in another variety of chronic Bright's disease. For the present purpose it is necessary to follow the broader lines of distinction, and to avoid the transitions and finer shades in the pathology; and it may be stated as a general truth that the large white kidney goes with scanty urine and much waste of albumen (the waxy modification having only the latter), while the small granular contracted kidney is associated with even copious urine and a waste of albumen which is often small, and in any case variable. The error in these latter cases appears to lie with the arterial side of the circulation; the left heart is hypertrophied, and so is the muscular coat of the arteries in the kidney, if not also elsewhere. It is essentially an interstitial disease of the kidney, leading to enormous development of its supporting tissue; whole tubules become obliterated, but in those that remain the epithelium is not degenerated. Obliteration also overtakes the glomeruli, but there must be a compensating increase in the work done by those that survive to account for the copious urine; it often happens, also, that numerous small cysts are produced.

Shrinkage of the connective tissue after a period of revived embryonic activity is the cause of all these changes; it is the ordinary shrinkage of cicatricial tissue, and it has the effect of compressing the proper urinary apparatus—the filtering and the secreting—to its destruction. The kidneys may be reduced even to one-fourth of their natural size, and their uneven surface shows that there has been mechanical dragging along certain lines. In the end the urea-waste accumulates in the blood to such an extent that death results, usually from uramic coma and convulsions. In some cases cerebral hemorrhage anticipates the fatal effect of uremia.

The small granular contracted kidney is usually of a reddish-brown colour, but it may be whitish, in which case the lobulation of its surface is larger. It is one of the standing difficulties of renal pathology to decide whether the small contracted kidney is not often a later stage of the large white. But there can be hardly any doubt that it is oftentimes the structural manifestation of an entirely different disease, an arterial disease. That which has been emphasized by some pathologists as the distinctive process in this affection is the overgrowth of cells on the inner wall of the arteries, the so-called endo-arteritis or arterio-capillary sclerosis, whereby the lumen of the vessel tends to be occluded. But it may be made a question whether this is not really a part of the revived embryonic activity in the connective tissue, whose shrinkage gives the organ its granular contracted character. The interest would thus come to centre in the error of nutrition whereby so much activity is diverted to the connective tissue, an activity that takes the embryonic formative direction. We have a close analogy in cirrhosis of the liver, a disease associated with the drinking of raw spirits; and it is noteworthy that the insidious form of Bright's disease, whose morbid anatomy is summed up in the small contracted and puckered kidney, occurs most frequently in those who sustain

themselves more by ardent spirits than by ordinary food, and next most frequently in the subjects of gout and of lead-poisoning, although there are a good many cases of the disease remaining to be accounted for by less obvious causes.

The *dropsy* of Bright's disease is difficult in its pathology. The watery state of the blood, or the hydremia, consequent on the loss of much of its albumen does not suffice by itself. A subsidiary hypothesis, adopted by Cohnheim, is that the blood-vessels of the skin become unusually permeable. Sometimes the dropsy appears first round the ankles, at other times it shows itself in puffiness of the eyelids and a somewhat bloated pallor of the face.

*Gout and the Uric Diathesis.*—Many other states of the system besides podagra—the disease which usually begins in the night with pain and redness of the great-toe joint—are now reckoned as belonging to gout. The disease, in the extended use of the name, is indeed a widespread error of metabolism which may manifest itself in very various ways. The particular liabilities to error arise during the metabolism of proteids, from the first stage of digestion in the stomach to the last stage of excretion in the kidney. Hence it is that gout, in its widest meaning, has been taken to be a form of "dyspepsia." The opportunity for going wrong may be said to depend on the fact that there are two chief forms of nitrogenous waste remaining to be got rid of in the end, which are somehow correlated to one another,—the highly soluble substance urea, and the highly insoluble substance uric acid. There are remarkable differences in the proportions of these two waste-products throughout the animal kingdom; in most reptiles and in birds the form of nitrogenous waste is mostly uric acid, whereas in man (and other mammals) it is mostly urea. But in man the waste is still to a small extent in the form of uric acid. In normal human urine the proportions are:—to 1500 grammes (52·91 ounces) of water in the urine of twenty-four hours the total of solids is 72 grammes (2·54 ounces), of which 33·18 (1·17 ounces) are urea, and only ·565 (·019 ounce) uric acid, or not more than one-sixtieth of the quantity of urea. Whether or not we are to regard this small margin of uric acid as another of those instances of non-perfect adaptation of which we have previously found instances in the physiological traces of sugar and of albumen in the urine, and of colourless corpuscles in the blood, there can be no doubt that the adaptation, such as it is, whereby the nitrogenous waste is mostly the highly soluble urea, but to a very small amount also the less soluble uric acid, is the occasion of many and serious morbid conditions. The liability to these gouty and calculous disorders depends partly on the increase of uric acid at the expense of the urea, together with the low solubility of the former, but it seems to depend also on an abnormally low power of the animal fluids to dissolve uric acid, or of the kidney to eliminate it when its quantity is not excessive.

The peculiar liability from uric acid is sometimes called the uric-acid or uratic diathesis or constitution; some persons have it much more than others, and it is exceedingly apt to be handed down from parent to offspring, so that the stock, in countries and among classes where gout is common, may be said to be widely inoculated with it. Where the acquisition of it can be traced at first hand it is often found that the associated circumstances are high-feeding and a life of physical inaction and feeble intellectual exert. These are among the best-known conditions of gout, admitted equally by the ancients and the moderns. It is now known, however, that practically the same gouty constitution may be and often is induced by conditions which have hardly anything in common with luxury. Thus gout is a common liability of workers in lead, being one of the various manifestations of lead-poisoning; it is also common among those classes of labourers, such as dock-labourers on the Thames, whose habitual drink is porter; and it is said to have become common among the working-class in Dublin, where it was rare twenty or thirty years ago, according as they have taken to drinking porter instead of ardent spirits. There are still other cases of gouty constitution for which neither heredity, nor luxury, nor lead-poisoning, nor porter-drinking can be invoked as an explanation; and these are the cases which justify the somewhat wide definition of gout as a form of dyspepsia.

In order to have the gouty effect there need be no great increase in the amount of uric acid formed in the course of the metabolism of proteids. During an acute attack of gout, and previous to it, the amount of uric acid in the urine will probably be much below the average; it is the kidney that has failed in its function, so that the uric acid is retained in the blood to be deposited elsewhere. The presence of uric acid (urate of soda) in the blood in gout is the well-known discovery of Garrod, who has also pointed out that its proportion in the urine is at the same time reduced. But there need not even be failure of the kidney's function, although, as a matter of fact, there often is; the error may lie in the heightened insolubility of the uric acid. It is observed that the uric acid of urine is apt to be deposited in the form of urates, as a brick-red sediment, even when there is no excess of it; a more acid state of the urine seems to favour the precipitation of the uric acid; and it has been conjectured (from the success of the



alkaline treatment) that there may be some analogous acidity introduced into the blood and lymph in the form of organic acids (produced in the course of faulty digestion), which would cause the uric acid to be deposited from the blood as it circulates generally. It is in the cartilages of the joints that the deposition usually takes place, the great-toe joint (metatarsophalangeal) having a quite remarkable and inexplicable liability. The surface of the cartilage is crusted with patches of a whitish opaque substance, which proves to be needle-shaped crystals of urate of soda; the deposition extends deeper and affects the fibrous structures of the joint; it may be so extensive in other fibrous structures as to amount to tophi or chalk-stones. In some rare cases of gout such organs as the parotid glands may be completely disorganized by the chalky deposit, or there may be numerous centres of its deposition in the membranes of the spinal cord.

**Albuminuria and Eczema of Gout.**—Two morbid conditions are so frequently associated with gout as to be part of its natural history, namely, eczema of some regions of the skin (eyelids, back of neck, &c.) and albuminuria. We have absolutely no clue to the connexion between the skin-disease and the uratic diathesis; for the albuminuria a connexion may be suggested. The albumen will at first be absent in the intervals of gouty attacks, showing itself during the attack, or for a few days previously; its appearance in the urine thus coincides, so far as it goes, with the decrease of uric acid in the urine. It is impossible to exclude the possibility that the albumen is here an error of the renal metabolism. All the facts of the gouty constitution point to a far-reaching disturbance of the metabolic functions, which may be induced by causes so different as lead-poisoning and a luxurious life; uric acid is not the only metabolic product concerned, although it is the chief, for there is even an occasional implication of the glyco-genic metabolism, as shown by the presence of sugar in the urine, and there is the much more common albuminuria. It is impossible to believe that there are structural changes in the kidney to account for the earliest occurrences of albumen in the urine in gout, for the urinary secretion may be normal for long intervals; and it is by no means certain that the albumen is a leakage from the glomeruli owing to the altered pressure of congestion.

The kidney in chronic gout may be affected in obvious characters; it will show, on section, streaks of white opaque substance within or between the tubules,—that which is between them being composed of crystals of urate of soda often in fan-shaped bundles, while that which is within them is an amorphous mixture of urates of ammonia and soda and uric acid. The so-called gouty kidney may and often does assume the progressive structural changes which lead to the state of contraction and puckering. (There are other renal deposits of uric acid, as in new-born children, which are transitory.)

The uric-acid diathesis may manifest itself, not in gout, but in *gravel*. In this case the excess of uric acid is thrown into the tubules of the kidney, where it forms concretions; these may either be washed out by the urine as fine grains, or may remain for a time to increase by accretion, forming renal and vesical calculi.

**Obesity, Local Formations of Fat.**—The significance of fat under all circumstances in the animal body is by no means well understood, but it may be conveniently approached from the side of metabolism. Adipose tissue is a somewhat special development of mesoblastic tissue, and most usually of the common binding tissue. The embryonic cell transforms the greater part of its protoplasm into an oily fluid which contains no nitrogen, the nucleus being retained on one side along with a narrow fringe of cell-substance; a fat-cell in its early stage thus resembles a signet-ring, and in its later development it becomes a thin-walled vesicle which may be distended by its oily contents much beyond the limits of even the largest cells of other tissues. This transformation may happen to the cells of the connective tissue in almost any part of the body; but in the ordinary course of development it has certain seats of election, such as the stratum of gelatinous tissue underlying the kidney and the subcutaneous tissue. All synovial and serous membranes, except those of the liver and lungs, are favourite seats of fat-formation. In the subcutaneous tissue the first formation of fat appears to be associated with local formation of blood, the same mesoblastic elements being at one stage hematoblasts and afterwards, in their vesiculated state, fat-cells. It cannot be doubted that there is a close adaptation to the needs of the economy in the vicissitudes of the fat-tissue; but it must be admitted at the same time that the adaptation is often singularly obscure. In many cases the changes in the fat-tissue seem rather to be a correlated necessity.

One of the earliest facts that we meet with in this connexion is the gradual replacement of the thymus gland by fat, the fluid being absorbed in its turn, and the mass of tissue shrinking. A other fact of the same kind is the change into fat-cells of the "yellow" cells elsewhere, as the change of red marrow into yellow marrow in the central canals of the long bones. Both of these changes have a prototype or an analogy in the transition that one sees in groups of the subcutaneous spindle-shaped cells from a hematoblastic activity to a fat-making activity. The season of

puberty is a time of active fat-formation, more especially in women, and notably in the breast-region. A still more remarkable development of fat occurs in many cases of sterility, and in many women after the child-bearing period has ceased in ordinary. Such instances of a greater or less degree of obesity are so clearly associated with the obsolescence of an important function that they may be called physiological. Other instances of obesity have no such obvious or uniform association. Thus, an obese habit may follow one or more attacks of malarial fever; it sometimes occurs as one of the lifelong changes induced by an attack of typhoid fever. There is often a great degree of plumpness along with the extreme ill health of chlorosis. Idleness and some forms of insanity are apt to be associated with fatness; in the pseudo-hypertrophic muscular paralysis of boys the connective-tissue cells between the muscular bundles become so active in fat-making that they usurp the place of the muscle. As an effect of dietetic errors obesity usually follows the inordinate consumption of starchy and saccharine substances, and especially the drinking of much beer, stout, and even other forms of alcohol. As a racial character obesity is found among the negro populations in some parts of Africa (South Africa and the Upper Nile).

Among the most extraordinary developments of true fat are those cases where it develops locally in association with cancers or other malignant tumours. Thus, in a boy who had suffered amputation of the leg for a malignant tumour of the tibia there was a recurrence of the disease in the stump and in the ilium; he died in a state of extreme emaciation of all the body except the thigh of the affected side, which was enveloped in a layer of ordinary subcutaneous fat half an inch thick all round, contrasting strangely with the wasted limb of the other side. To take another unambiguous case, an extensive development of fat through all its embryonic phases can actually be traced in the serous covering of the rectum in a case of cancerous stricture of the part. There is usually much local development of fat round the sac of an old hernia. In certain glandular organs, such as the pancreas, the supporting connective tissue sometimes takes on an extensive fat-forming activity, so that the organ is half transformed into adipose tissue; the same may be found around the pelvis of the kidney in old age.

**Lipomatous Tumours.**—It is not always possible to say whether a local development of fat should be called a lipoma or not; thus, the fat around an old hernia may be so circumscribed as practically to amount to a fatty tumour, and that may be the case also with the fat around the breast or behind the eyeball. On the intestine, notably the transverse colon, the masses of fat do become pendulous fatty tumours (much more often in the domestic quadrupeds than in man) of a uniform or lobulated structure, which may hang by a long and slender vascular stem, like an apple or a cherry on its stalk; when the vascular supply is kept up with difficulty these pendulous masses of fat tend to become calcified or otherwise sclerosed, and to fall off into the abdominal cavity as "loose bodies." The loose bodies of the joints originate sometimes in the same manner from the pendulous masses of subsynovial fat. On the peritoneal surface the pendulous growth of fat may have a short stem and abundant blood-vessels, and go on to form a large lobulated tumour; but more usually in that situation the tumour-habit is established at a number of points, leading to the condition of multiple lipomata. The lipomata of the subcutaneous tissue may be single or multiple; if they are not congenital they are most often associated with a general obese habit; and they may grow to an enormous size. The submucous tissue of the stomach or intestine is a comparatively rare seat of fatty tumour. The most inexplicable lipomata are those which form, under very rare circumstances, as circumscribed nodular masses in the interstitial connective tissue of the cortex of the kidney, and in the subarachnoid tissue of the brain and spinal cord.

It is convenient to place these occurrences of obesity, of local overgrowths of fat, and of lipomatous tumours under the head of errors of metabolism, but it is difficult to find one physiological rationale for them all. Where obesity is due to dietetic errors we may say that the carbohydrates supplied to the body have been more than the combustion could overtake, and that the residue is "stored up" as fat. Where there is a degree of *emboypsis* in such a malady as chlorosis we may say that the feeble oxygen-carrying capacity of the red-blood corpuscles has led to an inadequate combustion of the carbohydrates supplied in due quantity, and that the residue has been stored up in that case also. In the unhealthy fattening that sometimes follows malarial or typhoid fever it does not appear why there should be the residue requiring to be stored up. Again, there are persons of an obese habit (probably congenital) who avoid a diet of carbohydrates, but turn even their meat diet to fat, just as there are confirmed diabetics who turn everything to sugar. Still further, we have the very remarkable tendency to make fat when the reproductive functions have ceased either prematurely or in the ordinary course; and that is a frequently occurring case which can hardly be brought into the doctrine of inadequate combustion of carbohydrates. The peculiar liability of the connective tissue between or upon the bundles of

muscle to become fat-tissue may point to some defective combustion in the work done by muscles. In the cases of pseudo-hypertrophic paralysis of the leg-muscles in children we are confronted with an enormous development of the same process. Other cases of local fat-formation, as in the interstitial tissue of the pancreas or around the kidney, are still more inexplicable. Lipomatous tumours, where they are congenital, may be referred to an early error of tissue-growth; where they are acquired, we have usually a coexisting or previous obesity (local or general) to resort to, and the only difficulty is to understand how the lobules of fat came to acquire the delimitation or individuality of a tumour.

**Degenerations.**—In a nosological outline there is perhaps no more convenient place for some remarks on the general subject of degenerative changes than at the end of sections dealing with the liabilities of obsolescence, the special liabilities of the suprarenal and thyroid, and the larger errors of metabolism.

The usual healthy appearance of the most elementary kind of protoplasm is a soft translucent grey; under the microscope this greyish protoplasm is uniformly and finely granular. From that standard of health there are various deviations, representing various kinds or degrees of degeneration. The chief degenerations are the mucous, the albuminous, the fatty, the calcareous, the caseous, and the amyloid.

The mucous change proceeds on more obvious physiological lines than most of the others; it is, as we have seen, the proper destiny of surface-epithelium in many situations; and we have found also, in treating of myxomatous tumours, that even in these it has not very remote affinities to the hæmatoblastic function. A somewhat obscure form of it, the *colloid* change, has been mentioned in connexion with cancer of the stomach and breast.

The **albuminous** change is that which is often found in the large glandular cells of the liver, kidney, &c., in disorders accompanied by a rise of temperature. The cells are somewhat swollen, and their substance is clouded so as to obscure the central nucleus.

Merging imperceptibly with the albuminous degeneration is the **fatty**, in which numerous small droplets appear in the cell-substance, which is no longer uniform but diversified with highly-refracting granules; these droplets are of the nature of fat. In the liver-cells the droplets may run together, so that the liver-cell has the ordinary appearance of a physiological fat-cell. But there is in general a broad line of distinction between the transformation of protoplasmic substance into fat (usually in the connective-tissue cells) and fatty degeneration as above described. The latter occurs under many circumstances. It is an accompaniment of phosphorus-poisoning and of those idiopathic states which run parallel with the former, such as acute yellow atrophy of the liver. It is apt to occur in the inner coat of arteries in chlorotic subjects, producing yellowish opaque patches, which sometimes give rise to erosions. The arteries of the brain are liable to a similar degeneration more universally and under other circumstances than chlorosis. The very common condition of **atheroma** of the large arteries (especially aorta) is a more extensive degeneration of a fatty kind, on the basis of antecedent swelling or increase of tissue in the deeper part of the inner coat, or in the interval between the inner and the middle coats. This variety of fatty change is often associated with the production of cholesterol scales, and with a subsequent calcareous transformation. Although it is most common after middle life, it is not a senile change proper, inasmuch as the most long-lived persons have none of it.

The **calcareous** degeneration is most often found in the cartilages of the ribs after middle life; but, like the atheromatous change, it is not properly senile, as the very aged sometimes have their costal cartilages quite soft. The deposition of lime-salts (carbonate of lime) is in the capsules of the cartilage-cells; on applying a drop of hydrochloric acid to a thin slice of such cartilage an effervescence of carbonic-acid gas will occur. Lime is often deposited in the enlarged thyroid of goats, and it is sometimes found in degenerated areas of the placenta. In the suprarenal it is much rarer than the cheesy degeneration. Fatty tumours in the lower animals, especially in the bovines, are liable to become calcareous; and the presence of granules of lime is a very common feature (along with the cheesy degeneration to be next mentioned) of the peculiar form of tuberculous growths of the serous membranes, or tuberculous nodules and infiltrations of the viscera and lymphatic glands, in those animals. In other tumours, of man or of animals, it is much less common. Lastly, foreign bodies lodged in the tissues, and the encysted trichina-parasite in the muscles, acquire a deposit of lime in the thickening of tissue which forms their capsule.

The **caseous** or cheesy form of degeneration is the characteristic disintegration that the cells and tissues undergo in tuberculous and scrofulous disease. Collections of pus, as in chronic abscess of the liver or in chronic empyema (pus in the pleural cavity), are liable to the same process of drying up and molecular disintegration. In the central parts of hard cancers also it is not unusual to find cheesy areas. A form of degeneration not very unlike the caseous may be observed as a perfectly normal incident in the deeper parts of the placenta. It is by far the most common degen-

eration of the suprarenal cells, whether in association with general tuberculous disease or not. Under all these circumstances the caseous change follows upon a certain amount of hyperplasia of the tissue, for the maintenance of which there has been no adequate provision in the way of new blood-vessels.

The **gummatous** degeneration of the products of syphilitic infection is not always easily distinguished from the caseous; but, for the most part, the substance is firmer and more cohesive, as the name implies, less dry and friable in the section, and of a brown colour rather than of the yellowish or fawn colour of cheesy degeneration.

A **vitreous, hyaline, or waxy** degeneration of muscular fibre occurs in the course of some fevers, as well as in progressive muscular atrophy.

The **amyloid** degeneration is the most peculiar of them all. The degenerate substance was thought to be allied to starch (whence the name) on account of the reaction with iodine (mahogany-red), but it is now known to be a nitrogenous principle. When it is present in large quantity, as in the amyloid liver, it gives the cut surface a peculiar gloss, like that of fat bacon, and hence it has been called lardaceous or waxy degeneration. Its proper seat is the walls of the smaller arteries and the capillaries; these undergo a kind of hyaline swelling, like the swelling of boiled sago, so that the aggregate effect in such an organ as the liver is to make it very much larger, firmer, and more rigid in its outline. This alteration in the vessel-wall facilitates the escape of the fluid part of the blood; hence the amyloid change in the kidney is a cause of albuminuria and in the intestine of diarrhoea. In the wall of the intestine the course of the amyloid vessel may be tracked by the mahogany-red line left by iodine. This remarkable form of degeneration of the vessels is associated with long-standing suppuration (especially in diseases of bone), with chronic dysentery, syphilis, and other of the constitutional states called cachectic.<sup>1</sup>

## § 12.—ERRORS OF THE NERVOUS CONTROL.

Reference has already been made to the obscure implication of nerve-control in such disorders as Addison's disease, Graves's disease, diabetes, and acute yellow atrophy of the liver;—the integrity of the controlling nerve-force may be said to be necessary to the perfect carrying out of the give-and-take of metabolism, or to the full effect of the "ferment" in each of the breaking-up processes. In a subsequent section (p. 393 *sq.*) reference is made to another controlling nervous mechanism, whose paralysis or disorder is immediately accountable for a very large part of the sum-total of sickness in the world, namely, the mechanism which regulates the animal heat. The present section will be devoted to a few morbid conditions of the cerebro-spinal system, selected to illustrate pathological principles.

**Neuralgia and Tetanus.**—One or two instances of neuralgia and of tetanus will serve to illustrate a peculiarity of the disorders of the nervous system among morbid processes of the body. A person in getting up from a stooping posture before the fire hits the right eyebrow hard against the edge of the mantelpiece; the blow has touched the filaments of the supra-orbital nerve, and there is more or less of pain for a time over the limited area to which these small sensory twigs are distributed. Several weeks afterwards, when the accident had been forgotten, there is an attack of severe neuralgia over the whole of that side of the face; the pain shoots along all the nerve-branches above the eyebrow, along all the branches below the eye-socket (infra-orbital), and along the branches going to the skin of the lower-jaw region or chin. The sequence of events means that the injury to the branch of the trigeminus above the eyebrow has touched the trunk of the nerve in such a manner that, after a considerable interval, intermittent attacks of pain are felt along all three sets of branches covering the whole of one side of the face. In other words, a molecular condition of nerve, originally peripheral and limited, has become central and diffusive. Another instance is as follows. A person seated at a high desk day after day exposes the outer side of the ankle and region of the Achilles-tendon to currents of cold air from the opening and shut-

<sup>1</sup> See Cl. Bernard, *Nouvelle fonction du Foie, comme Organe producteur de Matière morte*, Paris, 1858, and *Leçons sur le Diabète et la Glycémie animale*, Paris, 1877; Favv, *Recherches on the Nature and Treatment of Diabetes*, Lond., 1862; Senator, *Die Albuminurie*, Berlin, 1882; Cohnheim, *Allg. Pathol.*, vol. II., Berlin, 1881; Grating Stewart, *Practical Treatise on Bright's Disease of the Kidneys*, Edin., 1868, and in *Trans. Internat. Med. Congr.*, Lond., 1881, vol. II.; S. Rosenstein, *Die Pathologie und Therapie der Nierenkrankheiten*, Berlin, 1868, and in *Trans. Internat. Med. Congr.*, Lond., 1881, vol. II.; Garrod, *Treatise on Gout*, &c., 3d ed., Lond., 1870, and "Essays and Albuminuria in relation to Gout," in *Trans. Internat. Med. Congr.*, Lond., 1881, vol. II.; Virchow, "Lipoma," in *Kronika's Gesichtsblätter*, vol. I.

ting of a door, some occasional pains being felt where the external saphenous nerve runs behind the outer ankle and over the outside of the heel. After a lapse of time there is an attack of sciatica, the first of a series continuing for years, in which the course of the diffusive pain can be tracked, as if it had had an anatomical knowledge of the nerves of the limb, along all the branches of the great sciatic nerve to the thigh, leg, and foot. In this case the sequence of events is the same as in the former: the original excitant had touched the terminal twigs of the external saphenous branch of the great sciatic nerve; after an interval intense neuralgic pain begins to be felt far up the great nerve-trunk itself; and the pain diffuses itself not only to the filaments belonging to the external saphenous branch but along all the branches. A limited peripheral disturbance has, after an interval, become central and diffusive, and the pain apt to recur intermittently for years after.

Let us now take a case of *tetanus* involving the very same peripheral nerve as the last case. A boy engaged on a farm chafes the outer side of one heel by wearing boots too large for his feet; the abrasion, which is exactly over the course of the external saphenous nerve, is disregarded, and the irritation of the boot permitted to continue. In a few days he is admitted into hospital with tetanus, that is to say, with the neck-muscles rigid, the jaw locked, the features drawn; the recumbent body bent forwards from time to time like a bow, its whole weight resting on the head and heels, occasional wild jerking of the limbs, and the muscles everywhere as hard as boards. This horrible and painful state of the muscular system usually ends in the patient dying after a week or ten days or less, exhausted by hunger and thirst and want of sleep, or by inability to breathe under the vice-like grip in which the chest is held by the muscles of respiration. The sequence of events is here closely parallel with that in the cases of neuralgia: an irritated condition of a small outlying nerve-twig, which is not a motor nerve, has, after a short interval, touched the *spinal cord* in such a manner that motor force is freely and continuously let loose over the whole muscular system, with occasional discharges of a more intense kind. Spasm commencing in the muscles near the injury has been spoken to by the patients or attendants sometimes; but the observation has been recorded, on the whole, seldom. Strangely enough, it is in the muscles of the face, neck, and throat that the tetanic rigidity shows itself first, in whatever part of the body the injured nerve may be. There probably always is an injured nerve somewhere, although it is necessary to admit a few cases of "idiopathic" tetanus in which the nerve-injury is unknown. Gunshot-wounds of nerves are most likely to be followed by tetanus, as well as lacerated, contused, and punctured wounds generally, including the bites inflicted by canine teeth. The tetanic onset may follow the wound immediately, or it may come on while the wound is "cleaning" or suppurating, or during the stage of scarring, or some time after the cicatrix has formed. A wound which has been neglected in the healing, in which foreign particles have been left, or in which the nerve has been involved in the tightening of the scar is most apt to be followed by tetanus. A certain temperament, or state of the mind and body, predisposes to it; the frequency of tetanus in war may be due to more than one cause, but it seems necessary to include among the predisposing factors the excitement or preoccupation of the battlefield. Certain states of climate predispose to it; in the dry Australian air it is not uncommon for wounds to be followed by tetanus, and the disease is equally common within the tropics, especially under the circumstances which ordinarily cause chill. Among animals the horse is particularly liable to it, especially as a sequel of castration. The rise of temperature in tetanus is probably the effect of the excessive muscular metabolism.

*Explosive Discharges of Nerve-force on slight Provocation.*—Instances of neuralgia and of tetanus as the sequel of a peripheral injury, or series of scarcely observed excitations, are illustrations of that remarkable property of the nervous system which Rindfleisch speaks of as involving a "disproportion between cause and effect." The central nervous system, he says, "has a capacity for absorbing enormous quantities of centripetal or ingoing excitations as if they left no trace; but in reality it stores them up in the form of potential energy. It is this that enables an impression which may hardly exceed the limits of physiological excitation, but is aided in various ways by circumstances, such as inherited feebleness, lowered nutrition, or blood-poisoning, suddenly to let loose the whole store of these accumulated forces and to give rise to an outbreak of the most acute feelings and the most powerful movements." The want of outlet at the time is an error that underlies much of nervous disease, both purely psychical and other. The brooding upon wrongs, real or imagined, the unsatisfied hunger for sympathy, pent-up or unexpressed emotion under many circumstances, even the solitude of shepherds on the Australian and New Zealand downs, are among the causes tending to a total unwhinging of the mind. Such illustrations of the general principle are beyond the scope of this article; the illustrations that concern us most at present are found rather in the province of reflex nervous activity, where the response is automatic; not always recorded by

the consciousness, and little if at all controlled by the will. Some disorders in this group are purely functional, that is to say, there are no concurrent structural changes. In others, the functional disorder is attended or closely followed by degeneration; and these are mostly diseases of the spinal cord. Representative instances from each of these two classes will now be adverted to briefly.

*Convulsions (Eclampsia).*—Apart from the convulsions of uræmic poisoning, there are two prominent divisions of eclampsia—the convulsions of infancy and childhood and the convulsions of the pregnant or puerperal state. In infancy the reflex movements and uncontrolled spontaneities are predominant, just as the impressions from the outer world are but little discriminated or retained. It takes little to throw some infants into a fit; the irritation of teething, of ill-digested food, of worms, and the like will suffice. Whether in these cases the excitations have been accumulating or not, the discharge of outgoing energy is always explosive. The muscles that straighten the back are contracted to the utmost, and the air is forcibly expelled from the chest with a prolonged cry; the head is thrown back, and the arms and legs kept rigid. The state of rigid spasm (tonic contraction) is succeeded by rapid contractions and relaxations (clonic) of the muscles of the face and limbs and whole body, which gradually become more comprehensive in sweep and slower in rhythm until they cease. Consciousness has meanwhile been suspended, and does not return until some ten or twenty minutes after the convulsive movements have ceased; with the return of consciousness the patient "comes out of the fit." The liability to such attacks diminishes very strikingly as the intelligence and the will develop and the body hardens. It is not until the circumstances of pregnancy and childbed arise that any liability to convulsions at all comparable to that of infancy is again met with. No analysis of the circumstances of puerperal convulsions can be attempted here; if they are in some cases of "uræmic" origin, in association with the albuminuria of pregnancy, there are other cases that are primarily disorders of reflex innervation.

*Epilepsy.*—An epileptic fit does not differ materially in its phenomena from a fit of convulsions as above described; the tongue is more apt to be caught between the teeth in the rapid movements of the lower-jaw muscles, and the spectacle of a grown person in a fit is more distressing in every way. That which really distinguishes epilepsy from eclampsia is that it is a *habit* of the nervous system, with a good deal of regularity in its recurrence. Fits of convulsions in infancy will cease when the cause is removed, when teething is over, or worms expelled, or after the probationary state of the nervous system has been outgrown. The convulsions of childbed also, if the patient happily survive the attack, come to an end when the critical state of the system has passed. But it is the distinctive mark of epilepsy that it tends to become an ingrained habit, that the fit is there *in posse*, as if detached from its exciting cause, established, permanent, and self-existent on the paths of ingoing and outgoing nerve-influence. This tendency of a disordered reflex action to repeat itself is the same "memory" that has been claimed by Hering for the cells and mechanisms of the body generally. That which is implied in the original use of the word, namely, retentiveness or the resurrection of past impressions, and the contagion of associated ideas, is a mystery large enough to cover the minor mystery of morbid habit. Epilepsy is, as it were, the self-existent memory of a disordered reflex; and this is what we may understand by the term "neurosis." It is true that a primary disorder of reflex action due to an adequate cause, such as infantile or puerperal convulsions are, cannot be always shown to have occurred at one time or another in epileptics. In a certain proportion of cases there has been an injury to the skull, or there are evidences of tumour or other new formation within the skull, or there is a tumour of a peripheral nerve, or a nerve involved in the scar of a wound or sore; but there are many more epileptics in whom such antecedents cannot be made out. The habit, in fact, is one which tends to be ingrained not only in the individual who has begun it but also in his or her family. Epilepsy is one of the clearest instances of a liability transmissible from parent to offspring. The heredity of epilepsy has even been proved by Brown-Séquard for the guinea-pig; when an epileptic habit was induced in guinea-pigs by injuring the spinal cord or the medulla oblongata, or by cutting the sciatic nerves, the litters of such epileptic guinea-pigs were apt to have epileptic seizures, attributable to nothing but inherited liability. According to Hasse's figures, epilepsy has begun before the age of twenty in by far the larger number of cases, and that fact is doubtless an index of the extent of hereditary influence. If we do not assign all such cases to heredity, the advent of puberty in girls may be held to be itself a cause of epilepsy; that time of life is distinguished by the somewhat abrupt acquisition of a much wider emotional and intellectual range, and presumably by some special liability to explosions of reflex nerve-force upon slight provocation.

*Chorea (St Vitus's Dance).*—This is another variety of uncontrolled movement which is also a habit, like epilepsy, and is practically confined to girlhood and boyhood. It may occur in pregnant

women, but it disappears with delivery. The movements are intermittent, beginning from a state of repose with a certain fidgety restlessness, and going on to the most irrelevant and un-rhythmical jerkings, hitchings, and twistings of the limbs, head, and body, or of one limb only, or one shoulder, or of the head only, or of the tongue. The muscles do not cease to be the ministers of the will, but voluntary movements are performed with some want of aim and certainty; and the gait in walking may be seriously affected. The choreic movements themselves cannot be restrained by the will; excitement and self-consciousness intensify them; and they cease during sleep. One of the most singular facts in this strange nervous habit is its association with rheumatic fever; a significant proportion of those subject to it are found to have had rheumatic fever, but there are others, curiously enough, who afford indications only of that state of the endocardium (or lining membrane of the heart and its valves) which often goes with rheumatic fever. This fact of endocarditis has suggested a theory that the disease is due to the minute arteries of the corpus striatum being blocked with small fibrinous plugs washed off from the inflamed interior of the left ventricle, or from the surface of its valves. It is more accordant, however, with all the phenomena to regard the disease as a functional habit of muscle and nerve, with the usual intermissions of a nervous habit and the usual exacerbations, in which the implication of the heart-muscle creates a peculiar liability to endocarditis. A further analysis is offered at the end of the remarks on rheumatic fever (p. 398).

*Mimetic and Epidemic Chorea.*—The choreic habit has, like hysteria, a singular power of becoming a fixed idea in others; there is no doubt that choreic movements are involuntarily mimicked by young persons who witness them in orphanages or other institutions where a number of girls are living under the same circumstances of work and leisure. Chorea may thus be said to be contagious, while epilepsy is hereditary. It is no great step from these cases, which depend solely upon the fantastic trick being caught under the influence of the *idée fixe*, to the remarkable epidemics of dancing frenzy of which some are historical, and of which there are still instances occurring from time to time under some general excitement, particularly the vivid prepossession of a large number of persons at once by the same religious hopes and fears.

In this connexion come certain other diseases—*scotary, catalepsy, and hysteria*—of which the details are given in the respective articles, ECSTASY, &c.

*Diseases of the Spinal Cord.*—In the foregoing group of errors of the nervous control we have had to consider a mere functional condition,—a molecular state, no doubt, but one which cannot be seen any more than can the electricity in a wire. Structural changes, when they occur at all, are a very late effect, as in some cases of epilepsy. But there is a very large and important part of the functional errors in the controlling nervous mechanisms which are associated with textural changes or degenerations. The most obvious of these are disorders of the reflex functions of the spinal cord. In respect of these structural changes accompanying functional irregularities, the spinal cord approximates to the organs and parts of the body which we have already considered. But there is one character in the textural changes of the spinal cord (and of the brain) which is in a sense unique, namely, their tendency to spread up and down in the particular tracts of fibres. Hence the ascending and descending degeneration and sclerosis of the cord, the extensions of bulbar paralysis, and the like.

*Locomotor Ataxia, or Tabes Dorsalis.*—The muscles of the body act ordinarily in groups, so that complex movements, such as carrying a spoonful of soup to the mouth, are performed by a number of independent voluntary muscles as if by a mechanism or automaton. The highest point attained by the muscles in this direction is the precision of military drill. In the disease called locomotor ataxia the muscles that are ordinarily grouped together in their action become slow to act in concert, the want of co-ordination being most obvious in the legs and hips in walking. Progression is not of the usual well-considered kind, but the leg is thrown outwards as well as forwards, and the foot is brought down as if the intention were to strike the ground with it, the knee having been previously straightened. With so little ease are these muscular combinations initiated that the patient requires to look at his feet as if the sense of effect were failing and had to be aided by the sight. Later on the muscles of the upper extremity are in like manner unable to act consentaneously, so that the patient cannot fasten a button, pick up a pin, or the like. Still later there is not only loss of the nicely-adjusted harmonious action among the muscles, but there is a loss of all moderation or gradation in the movements instituted. Whether or not this also be due to loss of the sense of effect, the movement is not adapted to the effect required; it is quick and of short range even when it should be slow and sweeping, and the time and range of the movement of the given limb are practically the same under all circumstances. These errors of the locomotor control are so conspicuous as to have given the disease one of its names: to them we have to add other symptoms varying in the different cases, such as flying pains in the limbs,

numbness, squinting and double vision, and functional disorders of the abdominal and pelvic organs. A certain painless structural alteration of the joints (especially the knee), first described by Charcot, is now and then met with, and the remarkable condition known as perforating ulcer of the foot is sometimes found (but not every case of it) to be associated with locomotor ataxia.

The structural changes in the spinal cord begin in the lumbar region and spread upwards; they are in the posterior columns, and especially on their outer limits. Grey degeneration is the name given to the structural condition, and it depends essentially upon the loss of the opaque white substance that invests the axis-cylinder of each nerve like an insulating stratum; this layer gives the colour to the white tracts of the cord, and the loss of it reduces these tracts to the grey condition of the central columns of cord where the nerves are normally without the white insulating layer.

The degenerations of the spinal cord, however caused, have little variety; the loss of the white substance may be followed by hardening of the tract of tissue (sclerosis), or there may be a development of the cells of the supporting tissue or neuroglia, keeping pace with the decay of the nerves themselves, whereby the tract acquires a gelatinous appearance. Sometimes the degeneration is not perfectly continuous, but occurs at many isolated spots (multiple disseminated sclerosis).

The causes of the degeneration in locomotor ataxia are various. According to the statistics of Erb, it is nearly always associated with constitutional syphilis; other causes are probably always peripheral somewhere within the region supplied with nerves from the lumbar part of the cord.

The causes of degeneration other than that of tabes dorsalis are also various, and associated with various groups of symptoms, which need not further be considered. Mechanical injury to the cord is followed by degeneration, and the pressure of a tumour may have the same effect. It is found that the solution of continuity of a nerve causes the same loss of the white substance in its peripheral portion as in these degenerations of the cord, and the degeneration of the nerve is set down to its being cut off from its "trophic centre." The same "trophic" hypothesis is applied to the spinal decay. If the structural degeneration in the cord differs from the degenerations that elsewhere go with disordered function, in its remarkable tendency to spread up or down, that is a difference which may be itself associated with the distinctive conducting function of the nerves and nerve-centres.

In so-called *bulbar paralysis*, associated with inarticulateness of speech, there is described a certain decay of the ganglion-cells in the nucleus of the hypoglossal nerve, situated in the "bulb" or medulla oblongata, together with general shrinkage of the nucleus; this condition progresses both structurally and functionally towards a more general paralysis.

In *infantile paralysis* the structural degeneration is found pervading the anterior horns of grey matter of the cord (anterior poliomyelitis), and it includes the ganglion-cells.

*Pseudo-hypertrophic Paralysis, Progressive Muscular Atrophy.*—These are two closely allied conditions, the one in young children and the other mostly in male adults, which afford the most instructive contrasts. There is gradual loss of muscular power in both, in the case of the children's malady chiefly in the coarse or static muscles that keep the body erect, and in the nimble and richly innervated muscles of the hand, forearm, and tongue in the progressive muscular atrophy of male adults. In both the loss of muscular power goes hand in hand with a loss of muscular structure; but in the coarse and sluggish groups of muscles which are mostly affected in growing children the loss of muscular structure is more than made up for, in mere bulk, by the development of interstitial connective tissue and fat, while in the nimble muscles of the hand and tongue, chiefly and primarily implicated in the characteristic disease of maturity, there is visible shrinkage of the part. It is only in the limbs, when the affection extends to them, that the bulk and outline are preserved in adults. Hence the affection in children is called pseudo-hypertrophic paralysis, and in adults progressive muscular atrophy. A few cases of great interest have been recorded in which adults have had the two conditions in combination. Children so affected walk as if on tiptoes, with a waddling gait, balancing the body for a perceptible interval on one foot; when they are stripped the dorsal contour is peculiar, the shoulders being thrown back and the belly forward, the calves and hips standing out prominent and hard. In the muscular atrophy of adults the ball of the right thumb is nearly always wasted, and if the other muscles of the hand are equally attenuated there is produced the characteristic appearance of a bird's claw; the tongue also is often shrivelled.

In contrast to locomotor ataxia, and to paralysis from injury to or pressure on the brain and spinal cord, these two diseases are illustrations of the peripheral relationship of muscle and nerve, of a loss of integrity in that executive relationship, which brings with it both loss of power in the muscle and concomitant failure of its nutrition. They may be quoted as instances of tropho-neuroses,

so long as it is clearly understood that the term really explains nothing. There are, indeed, changes described for them in the anterior cornua of the grey matter of the cord, with wasting of the anterior roots of the spinal nerves.

"*Dissolution*" *Principle of Nervous Diseases*.—It is known from physiological experiment that a muscle is capable of excitation when the nerve-force is withdrawn from it; muscular substance is not only a contractile form of protoplasm under the control of nerves, but it has proper irritability when the nervous influence is paralysed (as by the action of the curare poison). The condition of the motor nerves in pseudo-hypertrophic muscular paralysis and in progressive muscular atrophy is such that the muscles are left to their indigenous contractility, being deprived of their innervating force. We shall find these two diseases a convenient opportunity of stating a principle in nervous diseases which has been expounded by Hughlings Jackson under the name of the "*dissolution*" principle. Morbid states of the nervous system (or many of them) are said to be of the nature of a breaking up of the acquisitions of evolution, with loss of the more finished acquisitions, and a falling back to a simpler type, whose unsuitability to the individual in his then general circumstances amounts to a disease. The illustrations already given (§ 4, 5) of "memories" of development inherent in the cellular life of the body belong to the same class of facts or the same order of ideas.

In applying this principle to the diseases in question we have to consider both the electrical reaction of the muscles and the retrograde changes in their structure. The "reaction of degeneration" is a peculiar one, and it is the diagnostic mark of paralysis of peripheral origin. The degenerated muscle shows a considerable increase of irritability for a time under the galvanic current; the contraction is sluggish and sustained; the anodal closure gives a stronger contraction than the kathodal, while, conversely, the kathodal opening has the advantage. These peculiarities of the electrical reaction in "degenerated" muscles are analogous to the physiological reaction when the nerve-influence has been abrogated. We may take it that a "degenerating" muscle falls back upon its proper irritability, that the contractility becomes "ideo-muscular" as contrasted with "neuro-muscular." The muscle, so to speak, takes lower ground by way of adapting itself to circumstances.

In the disease in question, as it affects children, the groups of muscles that suffer are precisely those in which the contractility is already of the sluggish, sustained, and ideo-muscular kind,—such muscles as the erector spinae, glutaei, and others, which have an extremely limited nerve-supply in proportion to their bulk. Side by side with this fact we have the other fact of an increase of bulk, as shown in the seemingly strong and hard back, hips, and calves. The paralysis of the muscles has brought with it extreme dilatation of their small arteries, and consequent venous hyperæmia; and this presence of the blood in increased quantity has given an enormous impetus to the growth of the interstitial tissue, in the form of young connective tissue and more particularly in the form of fat-tissue. On the other hand, in the muscular atrophy as it affects adults (mostly of the male sex), it is the very nimblest of all the muscles of the body that are picked out first—the muscles of the right hand,—in which the ideo-muscular contractility is naturally small and the neuro-muscular contractility naturally great; and these muscles, with those of the tongue, undergo a remarkable atrophy with little or no spurious compensation from the interstitial tissue. When the disease progresses to other muscles, however, there may be so much new-formed interstitial tissue (fibrous and adipose) that there may be no actual loss of volume in the limb. The precise significance of these differences in the two diseases is not easy to state; in both the males are very much more often affected than the females, being in the one mostly very young boys beginning to walk, and in the other men whose manual dexterity is a formed habit.

The structural changes in the muscular fibre itself are very much the same in both; as the striation of the fibres disappears the quiescent muscle-nuclei become numerous and prominent. The muscle may be said to fall back upon the more embryonic condition, upon the individual life of the cell-units which had been fused in the fibre; it retreats to earlier ground, and, as the proper texture of muscle finally goes, the life of the part takes the still more elementary direction of the common binding-tissue and fat. In this sequence of functional and structural events we may discover an illustration of the dissolution principle. The muscles, having lost, or beginning to lose, their innervation, fall back upon the more primitive kind of irritability; as the downward course of failure proceeds, they retreat still farther to an embryonic structural condition; when the muscle itself is practically lost the commoner forms of mesoblastic tissue take up the retrograde succession; and, last stage of all, even the fat and the fibrous tissue waste.<sup>1</sup>

### § 13.—ERRORS IN THE REGULATION OF THE BODILY HEAT.

The constancy of the bodily temperature under all circumstances of external heat and cold—of torrid and arctic zones, of summer and winter, of sunshine and darkness—is not the least remarkable instance in nature of a self-adapting mechanism. The average internal heat of the human body or of the blood is from 98° to 99° Fahr., and the healthy range in different individuals, or in the same individual at various periods of life, or in various circumstances of exercise and repose, sleeping and waking, is not more than a degree or two below or above the mean. It will be at once apparent that the sensations of heat and cold are no measure of the bodily temperature. The mechanism by which the body's heat is kept uniform is a co-operation of a number of agencies. It is an equation, of which the two sides are the amount of heat produced in the organism and the amount of heat dissipated. In hibernating mammals the former of these is the side to which adaptation is most directed, in such wise that the whole fires of the animal burn lower while the winter cold lasts. But in man the work and waste go on always, and therefore the heat of combustion is practically uniform at all times, so that the adaptation to seasonal and climatic changes of temperature is mainly on the other side of the equation, the regulation of the amount of heat given off from the body. In cold weather the amount of bodily heat parted with is limited by warm clothing (or clothing which conducts heat with difficulty), by keeping up the temperature of the air artificially by fires, and by the contraction of the surface-vessels and other muscular structures in the skin, which has the effect of diminishing the insensible perspiration and makes the familiar sensation of cold. While these adaptations to external cold are decidedly the greatest, it is not to be supposed that there are no adaptations on the other side of the account. There is, in fact, an increased production of animal heat also, so that more can be parted with, and the constant temperature of 98°·5 be still unaffected. The increased production is often in the way of increased muscular exercise, which every one is prone to in cold weather; it is to some extent also through the more active circulation in all the internal organs, especially brain and liver, their greater functional activity being attended with a larger amount of the heat of metabolic combustion. A heat-forming diet of carbohydrates (chiefly fats), and the physical benefit of the subcutaneous fat resulting therefrom, are well-known elements of the adaptation in colder latitudes.

When it comes to be an adaptation to great solar heat, the adaptation is again mostly in the way of regulating the heat lost. The vessels of the skin are dilated, and its other muscular elements (in the sweat-glands, &c.) relaxed (making the familiar sensation of heat), so that perspiration flows freely; the evaporation of the sweat on the surface of the body is constantly consuming heat, and the clothing is worn light, and of such colour and texture as will readily conduct heat (both of radiation and of evaporation). There is now as much effort to part with the body's heat as in winter there was effort to retain it. At the same time the heat of combustion in the body is kept down as much as possible; muscular exertion is avoided, the brain and the digestive functions are less active, and fatty substances are partaken of more sparingly.

The various parts of this conservative adaptation are somehow co-ordinated through the central nervous system. The vascular system is obviously a chief means by which the body's heat is kept constant, not only by the quick transit of the blood to all parts and the free mixture and

<sup>1</sup> See Wilks, *Lectures on Diseases of the Nervous System*, Lond., 1878; James Ross, *Treatise on the Diseases of the Nervous System*, 2 vols., 2d ed., Lond., 1883; Buzzard, *Clin. Lect. on Dis. of Nervous Syst.*, Lond., 1883; Gowers, *Epilepsy and other Chronic Convulsive*

*Diseases*, Lond., 1881, and *Morbid Conditions of the Spinal Cord*, 3d ed., Lond., 1884; J. Hughlings Jackson, "Evolution and Dissolution of the Nervous System," in *Brit. Med. Journ.*, i., 1884.

interchange of its particles, but also by the control of the amount of blood sent to the skin on the one hand (say, in warm weather) and to the muscles and viscera on the other (say, in cold weather). The vaso-motor nervous mechanism, therefore, is an integral part of the nervous control of the bodily temperature. But there is reason to think that the regulation of the bodily heat is committed to the charge of a still higher and more commanding centre in the nervous system than the vaso-motor. It is a remarkable fact, observed from time to time in clinical practice, that certain cases of injury to the brain, from fracture of the skull or internal hemorrhage, are attended with a quite phenomenal rise of the body-temperature—a rise to 107° or 108° Fahr.,—and that, too, when there is nothing strikingly unusual in the vaso-motor effects, as revealed in the skin or elsewhere. In such cases it is the surface-region of the pons Varolii, the great cerebellar commissure, that has been injured or compressed by the effusion and coagulation of blood. The evidence of specially-devised experiments confirms and amplifies the clinical evidence; and it is considered in physiology to be a well-grounded fact that there are thermic or heat-regulating centres in the brain, one, at least, being in the region of the pons Varolii. Bernard would further assume the existence of "calorific" and "frigorific" nerves side by side with vaso-dilator and vaso-constrictor.

**Thermic Fever and Heat-Stroke.**—Such, then, being the nicely-balanced and carefully safeguarded mechanism for keeping man's internal heat about 98° Fahr. under all circumstances, the question arises whether we may trace any considerable part of the sickness and mortality of the globe to a marked and conspicuous failure or break-down of this mechanism of adaptation:—

"But ere not Nature from this gracious end,  
From burning suns when livid deaths descend?"

Undoubtedly the *ardent* or *thermic fever* of Indian practice, the heat-apoplexy, heat-stroke, or sunstroke, is the direct result of an upset or disintegration of the heat-regulating nerve-centre. Either the disorder of innervation is shown in sudden syncope or depression of the heart's action, as among labourers working or soldiers marching in the sun; or the effect of atmospheric heat, direct solar or other, is a universal state of venous engorgement, indicating profound vaso-motor paralysis, and ending in death from asphyxia. Literally the "livid death" alluded to in the couplet; or the heat-stroke leads to an attack of thermic or "ardent" fever, coming on perhaps in the night within a few hours of exposure, or after a longer interval, having a prodromal stage of malaise, a rise of the body-heat to as much as 108° or 110° Fahr., embarrassments of the lungs and heart, profound brain-troubles, and probably a fatal termination in general venous engorgement and asphyxia. These various forms of heat-stroke all point to a profound disorganization of the nervous centres by the more or less direct action of solar heat,—to cardiac depression in the syncopeal form, to more general vaso-motor paralysis in the asphyxial form, and to disorganization of the thermic nerve-mechanism in the hyperpyrexial form. When recovery takes place, as it does in a large proportion of cases, there are often lasting traces of injury to the nervous system in other functions than the vaso-motor or thermogenic.

These cases of heat-stroke or thermic fever are the most obvious illustrations of a break-down of the heat-regulating mechanism, but they are by no means the most usual illustrations of it. It is in a vastly more common form of sickness, in malarial fevers of all kinds, that we discover the typical failure of the heat-regulating centre under circumstances that tax the self-adapting powers of the body. The enormous prevalence of malarial or climatic fever may be said to be the greatest indication of failure or imperfection in the adaptation of man to his surroundings. In some few spots, which even the instinct of the brutes leads them to desert for a season, the effects of heat and moisture are such as to induce an endemic diseased habit of body, so universal in its incidence and so insidious in its development as practically to amount to an ethnological distinction (see Heber's description of villagers in the *Terai, Indian Journal*, vol. 1, p. 251). Throughout the whole intertropical zone, and for 5° beyond it in the southern hemisphere and 30° beyond it in the northern, the climatic fever, in its various forms, stands for almost as much sickness and mortality as all other diseases put together. So stupendous a power has it always been that its pathology has with difficulty emerged from the stage of gross materialism and superstition. But malarial or climatic fever is the true "essential" or "primary" fever of the older writers; its paroxysm is the abstract fever of pathological treatises, which is

discussed without reference to communicability from person to person; and, if it has a periodicity which seems to give it specific characters of its own, a little analysis serves to show that its periods of waxing and waning are no other than the cosmical periods of the earth itself.

**Cullen's Theory of Fever.**—According to Cullen's theory of fever (which was a modification of Hoffmann's), "the first incident in the chain of sequences constituting fever is a depressed state of the brain and nervous system; spasm of the extreme capillaries results from this depression; and reaction of the circulation, with its accompanying phenomena, is an effort of the system to overcome the spasm. The Cullenian theory, in a modified form, continues still to be the prevailing creed of those who adhere to the tenets of solidism, and who believe at the same time in the existence of primary or essential fever." This is the language of Christian in 1840 (*Tweddle's Library of Medicine*, vol. 1, p. 116); and he adds that the chief force to this doctrine is one which "denies the existence of any primary or essential fevers, and holds them all to be merely symptomatic of some local disorder." Cullen did not ignore the differences among fevers in respect of the local condition, exanthematous or other; but his desire for a broad generalization led him to find something common in the antecedents of them all. This was "diminished energy of the brain," and the nervous depression was caused by "human and marsh effluvia." When the disentanglements of the century following are credited to Cullen's doctrine the latter will be seen to be still radically sound. The collocation of "human and marsh effluvia" is nothing but a verbal one; there is no uniformity of effect among human "effluvia" themselves, but rather specific differences; in marsh effluvia nothing has ever been found but common watery vapour; and the characteristic effects of "marsh effluvia" are by no means rare on barren uplands where there is no standing water or decaying vegetation for miles around. The modern disentanglement has put into a class by themselves all the communicable infective diseases which bring more or less of febrile disturbance, and has fixed the attention on the specific features and evolutionary antecedents of each. Hence the existence of "primary or essential fever" has come to be denied, except as the abstract febrile state. But it had been forgotten that, for malarial or climatic fevers, there is no communicability, and no specific virus bred in the body or in the body's discharges; and to them therefore belongs the heritage of "primary or essential fever." The common aguish intermittent is the source of all the concepts that enter into the doctrine of fever,—the initial malaise, the cold fit and the hot fit, the crisis and the desferescence. It is to it that the classical description of a febrile paroxysm applies, in paragraphs 16 to 23 of Cullen's *First Lines*, just as the fever pathology of Hippocrates and Sydenham applies to it; and the first incident in the chain of sequences, according to Cullen, was an "enfeebled energy of the brain." It will be found that this doctrine of primary or essential fever, understanding climatic or malarial fever therein, is fundamentally in agreement with modern physiological teaching as to the animal heat and the errors in its regulation.

**Malarial or Climatic Fever.**—Turning, then, to the analysis of a paroxysm of ague, we find that there is a preceding sense of languor and unfitness for a few hours; all at once the patient begins to feel cold, he shivers, his teeth chatter, his skin becomes "goose-skin" from the powerful contraction of all the muscular elements in it. If this occurred in the orderly course of regulating the body-heat it would mean that the internal temperature was falling below the mean; the vigorous contraction of the blood-vessels on the surface of the body is by way of preventing the escape of heat. But the truth is that the body-heat is rising much beyond the normal all the while that the skin is acting so as to keep in the heat. This procedure at cross purposes goes on for a few hours, during which the internal heat may rise to 104° or 105° Fahr. The cold fit passes into the hot, and then the crisis is reached; there is a violent rebound, the muscular elements of the skin and its vessels relax, perspiration flows freely, the kidneys begin to remove all the products of excessive and uncalled-for combustion, and in the morning the patient awakes with probably no very serious effects after his feverish night. Assuming the case to be a common quartan, the individual goes to his work next day feeling tolerably well; on the day after he has probably forgotten all about his feverish paroxysm, if it be his first ague; and it is not until the afternoon of the third day that he is again reminded of it. Let us say that he is returning from work towards the end of an ordinarily active day; suddenly he has the same uncontrollable feeling of chills, he shivers, and seeks warmth by crouching over the fire or by wrapping himself in warm clothes. The drama of three days before is repeated, he awakes again from a feverish night, the morning urine being again full of brick-red urates; he now knows that he is the subject of quartan ague, and that another paroxysm is due three days later, which he is fortunately able to prevent or at least to mitigate by taking quinine in the meantime. Whatever may have induced the first paroxysm, the second is a mere imitation of it, an affair of habit, just as a return of an epileptic con-



vision is. It can hardly be doubted that in the repetition of a simple ague-paroxysm we are concerned, not with the nervous system as co-ordinating the two sides of the account in the production and discharge of animal heat, but with an acquired habit of the nervous system, with a usurpation of the power committed to it for the purposes of control only. This acquired faculty of the heat-regulating centre to act quasi-autocratically is often exemplified in those persons who, having suffered from malarial fever under its usual exciting circumstances, experience a return of it under widely different circumstances. Thus, a pronounced ague-shake has occurred to a person crossing an ice-slope 10,000 feet above the sea-level, the original ague having been contracted several years before in a malarious locality.

We come next to the circumstances under which the heat-regulating centre suffers this disorganization, the memory of which may remain with it for long after. The circumstances of intermittent and remittent fevers have been already discussed in the article MALARIA, and it remains to give here only a brief epitome. Wherever and whenever malarial fevers occur there are considerable degrees of solar heat and of moisture in the lowest stratum of the air, and a considerable drop of the temperature after sunset. So far as the individual is concerned, he incurs risk by working in the sun and resting or sleeping in the chill of the evening, by letting a wind such as the monsoon blow upon his fatigued body, by passing suddenly from the relaxing conditions of heat to the constricting conditions of cold, by arriving from cooler latitudes in the hot season, and by doing one or all of these things when his nervous power, as Cullen said, is enfeebled by such causes as anxiety, intemperance in drinking, "and other circumstances which evidently weaken the system." A high degree of moisture in the lowest stratum of the air is the most universal of the external factors within the malarious latitudes, and it may be produced either by the extreme dampness of the soil or by the extremely rapid cooling of a dry soil (even bare rocks) by radiation of heat after sunset, whereby a moderate degree of atmospheric moisture gives a fall of dew. On the other hand, wherever the atmosphere is exceptionally dry, as on the southern littoral of Australia, there is no malaria notwithstanding the great solar heat; and wherever there are only a few degrees of difference between the day and night temperature and a very slight range throughout the year, as at sea within the tropics, or at such localities as Singapore and the Amazon valley under the line, malaria is far less active than the great solar heat and moisture might lead one to expect. Whatever in the telluric and atmospheric surroundings taxes the nervous mechanism which keeps the heat of the body always about 98° or 99° Fahr. is a cause of malarial fever.

*The Cold Fit of Fever.*—The central point of interest in a paroxysm of fever, the grand paradox of fever-pathology, is the rise of the heat of combustion, as shown by the clinical thermometer, and the simultaneous closing of the natural outlets of excessive heat, as shown by the shivering and the feeling of "goose-skin." The value of any pathological doctrine of intermittent and remittent fever may be estimated by its success in dealing with this paradox. We may conveniently approach this subject through the following concrete instance, as given by Oldham. "At Jhansi, in June 1860, a young officer of the battery of artillery to which I belonged was exposed for some time to the sun at mid-day; he then, in a profuse perspiration, came into the house, through which a hot wind was blowing, as all the woodwork had been burned by the rebels, and the tatties, which served for doors and windows, were almost dry; in a few minutes he complained of being chilly, and in a few more he was in the cold stage of a sharp attack of intermittent. This officer had never previously suffered from fever; when he went out a short time before he was in perfect health, and he had not, whilst away, been into any malarious locality; in fact, at that season, the whole country round was parched and dry." This case illustrates an important point,—antecedent exposure to great solar heat. Exercise in the sun means active internal combustion in the muscles, liver, &c., and the body warmed at the same time by the sun's rays; the equalizing of the heat made and the heat lost is accordingly a difficult task, which falls mostly on the skin (and lungs) to execute, and the heat-regulating centre to order and control. We may take it that both the regulating function of the nerve-centre and the executive function of the skin are strained to the utmost. In the case quoted, where there was no interval between the cause and the effect the body in its glowing state is suddenly exposed to a slight abstraction of heat through the draught in the house; the sudden loss of heat, however slight the amount, is the signal for the skin to close its pores so as to lose no more heat, and hence the passing feeling of chill. But the passing feeling of chill is in this case succeeded, at only a few minutes' interval, by the prolonged state of contraction of the cutaneous vessels, sweat-glands, and other muscular structures which corresponds to the rigors and the cold fit of ague; and, all the while that the skin is thus vigorously adapting itself to prevent the escape of heat, the heat of the body is rising several degrees. The skin and the nervous centre,

the executive and the central authority, are at cross purposes so far as the object is to keep the temperature at the level of 98° or 99° Fahr. Now, the rise of temperature in this case can have had no other source than internal combustion (in the liver, muscles, brain, &c.); but the combustion is an unnatural one, inasmuch as no proper physiological work has been got as its equivalent out of the muscles, brain, or liver, although there has been the due physiological waste (carbonic acid and urea). A slight chill, or the sudden abstraction of a not very large amount of heat from the surface of the body, has excited the heat-regulating centre in such a way that it lets loose an extravagant amount of its "thermogenic" force.<sup>1</sup> The nervous centre has been called upon to equalize the slight abstraction of heat at a moment when it is still in the state of strain from its previous and well-sustained efforts to keep the balance, and it is upset by the sudden call. It answers by an altogether disproportionate discharge of its force, which is both ill adapted to the momentary needs of the body and continues in operation much beyond the occasion for it.

Under ordinary circumstances of taking the ague there is usually an interval between the exposure to heat and the exposure to chill. Usually, also, the exposure to heat is more or less prolonged or habitual; the heat-regulating centre is taxed over and over again, and it is taxed so much the more if there is moisture in the air along with solar heat, the dissipation of the body's heat by the insensible perspiration and by radiation being much more difficult in a damp atmosphere than in a dry. Whenever the chill comes, it finds the heat-regulating centre without that tone which would enable it to act according to the emergency, so that the abstraction of heat, even if it be slight, is the signal for an enormous stirring up of all the internal fires and a rapid combustion to meet a loss of heat which is not greater than the body endures under other circumstances with impunity. This phenomenal burst of heat-making is, so to speak, misunderstood by the motor nerves of the skin; whenever, under the same circumstances of repose, there is the same thermogenic activity, it means that the heat is wanted to keep up the level of 98° or 99° Fahr., and all the muscular elements in the skin and in its vessels contract to keep the heat in, producing the feeling of external cold, or of shivering if the contraction be extreme. The same thing happens under the incoherent and extravagant action of the heat-regulating centre; and hence the paradox of the body shivering all the while that its internal heat is rising to 5° or 6° Fahr. above the average of health.

Another way of expressing the paradox is to employ Bernard's language of "thermic nerves"; we should then say that stimulation of "calorific nerves" goes with a stimulation of "vaso-constrictor" nerves in the skin, so that a violent discharge of force along the one path is associated with a violent discharge along the other. Whether, as Traube has suggested, the extravagant action of the heat-regulating centre might be altogether counteracted by the usual heat-discharging mechanism but for the inopportune constriction in the cutaneous vessels and the surface of the body generally, is a curious question, but hardly a practical one. In that degree of shock to or disorganization of the nerve-centre which occurs in ordinary tertian or quartan intermittent the duration and degree of the shivering fit are the index of the mildness of the attack; the more pronounced the cold stage, the more prompt is the crisis and the more certain the deservescence. But in the much more severe shock which brings a quotidian or a remittent, the cold stage is short and feeble, and the crisis and deservescence are proportionately undecided and uncertain. The remittent degree of climatic fever approximates, indeed, to the forms of continued fever in which the rigor is a mere survival of the great cold fit of intermittent; the initial rigors even of pneumonia are little more than formal, and the hot stage of the process is practically the whole. It would thus appear that the vaso-motor constriction, upon which the phenomena of the cold fit depend, is the due accompaniment of a certain moderate degree of upset in the thermogenic nerve-mechanism; the paradox of the body shivering while its internal heat is rising is after all a paradox, and not an antagonism. The severer types of climatic fever are those in which the primary shock has been most severe or least well sustained. "Degrees of fever," says Ferguson, "might be almost measured by degrees of solar heat, from the agues of Lincolnshire to the malignant remittents of the West Indies."

The periodicity of agues is a reflex of the normal periodicities of the bodily heat; in health the temperature rises to its highest point in the course of the afternoon and falls to its lowest a little after midnight, and in a typical intermittent these are usually the

<sup>1</sup> "There is no *a priori* reason," says Foster (*Text-book of Physiology*, p. 577), "positively contradicting the hypothesis (that the metabolism of even muscular tissue might be influenced by nervous or by other agency in such a way that a large decomposition of the muscular substance, productive of much heat, might take place without any contraction being necessarily caused. If we were to permit ourselves to suppose that the contractile material whose metabolism when resulting in a contraction gives rise to so much heat, could undergo the same amount of metabolism, in so far a different fashion that all the energy thereby set free took on the form of heat, variations in the temperature of the body, at present difficult to understand, would become readily intelligible."

hours when a paroxysm begins and ends respectively. These normal maxima and minima of the body's heat within a diurnal revolution are probably in their origin an adaptation to the periods of labour and rest, both muscular and digestive; but the habit is an ingrained one, and it obtains when the ordinary round of work and repose, of waking and sleeping, is departed from. In short, it follows the sun and not the vicissitudes of human occupation. Again, the periodical recurrences of the febrile paroxysm appear to follow the lunar intervals. In the United States an ague is observed which has only a weekly paroxysm; the quartan of northern latitudes is the bi-weekly interval. Tertian and quotidian agues would not of themselves suggest lunar periodicity, but they are related to the types with obvious lunar intervals. The "critical days" of continued fevers, which were closely observed in former times, have been brought with much ingenuity under a law of cosmical periodicity. It is observed in climatic fevers that, if there be an interval of one or more weeks in which the paroxysms are in abeyance, the next succeeding paroxysm will occur at its due time, and that various minor indications of constitutional disturbance in the interval (perhaps neuralgias) will have marked the periods when the full paroxysm should have developed.

It is necessary to pass over the changes in the blood and in the secretions which accompany the febrile paroxysm. In ague there is a remarkable production of free pigment traced to the red blood-disks, which accumulates in the spleen, the bone-marrow, and elsewhere. The spleen undergoes also an enlargement, and so does the liver; these are permanent where the malarial cachexia exists. The malarial cachexia, marked by hydræmia and lassitude, occurs most frequently in those who reside on a waterlogged soil, and are permanently subject to the difficulties of heat-regulation during their work which an atmosphere saturated with watery vapour entails. In such cases there may be no febrile paroxysms from first to last, but a state of adaptation of the body which is at once a disease and almost an ethnological character.

**Dysentery.**—It is universally admitted that the causes which produce intermittent in one man of an exposed party may produce remittent in another, dysentery in a third, and abscess of the liver in a fourth. The incidence in the form of dysentery is apparently capricious; we have simply the fact that, in a certain proportion of cases, the shock resolves itself into a profound disorganization of the function of the great intestine, which may pass off in a few days or become chronic. The dysenteric seizure is most frequent where there is extreme atmospheric moisture as well as extreme heat, and where the surface of the body is most directly exposed. The region of the loins is somehow a region of great liability, just as the head is, the turban or pith helmet and the loin-cloth of hot countries being the indications of these liabilities. One important point of difference between dysentery and intermittent and remittent is that the former disease runs its course in one attack, whereas in the latter there is the remarkable habit of repetition. The return of the ague paroxysm is an evidence that the disorder is fundamentally one of the nerve-centres; it is an instance of the "memory" or "habit" which disordered nerve-mechanisms are peculiarly apt to fall into and to retain. In dysentery the disorder is localized; it is not so much central as peripheral. Whoever has had dysentery once is apt to have it again, and it may become chronic from the first seizure. But it has obvious points of difference from climatic fever, and these differences are associated with the localized incidence of the primary disturbance.

Dysentery may arise under other circumstances than exposure to tropical heat and moisture and to tropical chill, as in wars and famines, in cold, and amidst privations and overcrowding. In such cases it is correlated rather to typhus fever than to malarial, but it is probable that there is the same kind of primary effect produced through the nervous mechanisms as when the vicissitudes of a tropical climate are the cause. Again, the dysentery of slave-ships (formerly) and of coolie-ships (at present), in tropical waters, would appear to be a mixed effect.

The effluvia from dysenteric dejecta (or water contaminated by the dejecta) appear to have the power of exciting, in persons who have not been directly exposed to the causes of dysentery, either dysentery itself or some vicarious infection, such as typhus fever or yellow fever, according to the source of the dejecta, or the kind and degree of putrefaction which they had undergone, or according to racial differences in the exposed persons. This question belongs to another part of the subject.

**Tropical Abscess of the Liver.**—This is intimately associated with dysentery in its causation; it may be either a primary effect, as it were, instead of dysentery, or it may be an after-effect of one or more attacks of the latter. The primary effect has been dwelt upon by some, and the after-effect by others (notably W. Budd), but there is really no antagonism between them. As a primary effect tropical abscess of the liver is closely parallel with tropical dysentery and with malarial fever. It is not the effect of heat by itself, but of chill as the sequel of great exposure to heat. Solar heat is trying to the hepatic function, there being an increase of bile; when the organ has been thus overtaxed it is sensitive to the vicissitudes of

heat and cold. It is pointed out by Dr James Johnson (*The Influence of Tropical Climates*, p. 177) that genuine hepatitis is even more frequent in the Carnatic, with uniform but high temperature, than in Bengal with a more variable and damp climate. "The casual visitor may well wonder how cold can be often applied on the burning coast of Coromandel, where the temperature is high and steady by day, where the nights are, for months together, hot, and seldom raw or damp as at Bombay or Bengal. . . . The European soldier or sailor, exhausted by exercise in the heat of the day and by profuse perspiration, strips himself the moment his duty is over, and throws himself down opposite a window or port to inhale the refreshing sea-breeze, his shirt in all probability dripping with sweat," and the consequences are likely to be an attack of hepatitis or abscess of the liver. A slight abstraction of heat completely upsets the organ which had been most taxed under the particular climate; the incidence is not so much upon the heat-regulating central government as upon a most important member of its executive. As the sudden abstraction of a small amount of heat from a fatigued and perspiring body can produce an extravagant discharge of heat-producing force, or a paroxysm of fever, by touching the nerve-centre, so it can produce a peripheral effect in the most important of the heat-forming organs, which had under the special circumstances been overtaxed in its function. But the effect on this peripheral part of the heat-producing mechanism is not, for the most part, an increased production of heat as in fever; it is, in fact, local congestion of blood and suppuration. When the strain falls on the central government the effect is fever; when the strain falls on an important member of the executive the effect is inflammation.

**Pneumonia.**—Congestion of the lungs and pneumonia are not unfrequent accompaniments of remittent fever in India, especially in those whose health had been previously enfeebled, and among the more ill-clad natives. Pneumonia is liable to occur in those who had been acclimatized to heat, on their exposure to unusual degrees of cold, as among the negroes in the United States. It has been also observed to become widely prevalent, and in a form which amounted almost to pneumonia pure and simple, among the troops from India employed in Afghanistan in 1838-39, and again in 1878, when they were exposed to the winter cold.

Pneumonia is indeed an effect of chill proper to higher latitudes, just as intermittents and remittents, dysentery, and hepatic abscess are most characteristically the effects of disorder, either central or peripheral, in the heat-regulating mechanism as adapted to tropical and sub-tropical conditions. That pneumonia is nearly always caused by chill is generally believed (the pneumonias of contagious origin being excepted); but it may not be so readily admitted that we have here to deal with a disorder of the heat-regulating mechanism. Pneumonia is, at all events, a fever; it has an initial period of rigors, more pronounced than in most continued fevers, although far behind the cold fit of intermittent; the pyrexia is sometimes present for some hours before the other symptoms become marked; it usually comes to an end abruptly some time before the consolidation of the lung is all cleared up; and that crisis in the disease is apt to fall within a week of the onset, and is seldom delayed more than a day or two over the week. The stress of this disease falls upon the lung, usually upon one lung, and more particularly upon the lower half of the lung. Leaving, for the present, the question why the lung is in this case the organ of metabolism upon which the stress falls, let us consider the nature of the pulmonary condition.

First, there is engorgement of blood, a condition which is due, according to all analogies, to paralysis of the vaso-motor nerves. The abundant capillary vessels round the air-cells are greatly distended with blood, and the mucous membrane of all the bronchial tubes is also much injected. Accompanying this state of the pulmonary circulation there is more or less obvious distress of breathing, or dyspnoea, together with a strong, full, and quickened action of the heart. If the action of the heart be weak and the distress of breathing great it is a sign that the shock has been more severe than the patient, as he is then circumstanced, can stand, and death may result merely from congestion of the lung. Usually the extreme congestion of the vessels is relieved by exudation from them into the air-cells which they surround; if the patient should die at this, the second stage of pneumonia, the lung, or lobe of the lung, is found to be solid enough to sink in water; it is still red, as in the stage of engorgement, but the cut surface is firm, and under a lens looks to be finely granulated. Each little granule corresponds to an air-cell,

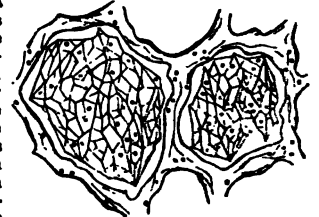

FIG. 55.—Pneumonic lung, stage of red hepatization; alveoli occupied by fibrous threads and a few cells.

the air-cell no longer containing air, but a solid coagulum consisting of numerous threads of fibrin, with a homogeneous plasma as the basis, and a few red blood-disks and white blood-corpuscles (fig. 55). The whole of this is an escape from the overloaded blood-capillaries. The lung is just one of those organs where such an escape from the blood is possible; the engorged vessels are distributed as a plexus over the thin walls of air-filled spaces, and the fluid part of the blood, together with a certain proportion of its solid particles, passes through the walls of the vessels into the air-space. If the lung be examined from a case of pneumonia fatal a day or two later, or in the third stage, it is still solid, but the redness is mottled with grey, or has become uniformly grey, and has become uniformly grey. The number of round nuclei cells in the air-vesicles has increased enormously, usurping the place of the fibrin and plasma (fig. 56). There is no good reason to suppose that this enormous accumulation of cells is due to successive additions of colourless corpuscles from the blood; they are now, many of them, much larger than the blood-cells, and we may take it that they are the product either of subdivision of the few original blood-cells or of the epithelium of the air-vesicles. The solidity now begins to give way, the contents of the air-vesicles undergoing a mucoid or other disintegration, and they are gradually removed for the most part by expectoration. In ten days from the onset the lung may have returned to its normal condition.

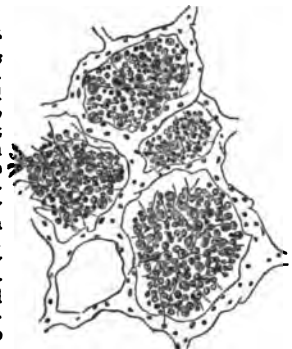

FIG. 56.—Pneumonic lung, stage of grey hepatization; alveoli filled with cells.

We have now to consider briefly this disease as an error in the heat-regulating mechanism, in which the strain falls upon an important peripheral or executive part. Hepatitis may be taken to be this kind of effect where the chill is a slight abstraction of the body's heat under tropical conditions; pneumonia is this kind of effect where the chill is caught under the vicissitudes of the weather in spring, or in changeable weather generally, within the temperate zone. Why should the liver be the organ of choice in the one case and the lung in the other? It may be said at least that each organ, in the respective circumstances, is the *locus minoris resistentis*. A sudden abstraction of heat is a strain or shock to the heat-regulating centre, and, if the incidence is to be on the executive, it will fall on that member of the executive whose function had been, under the circumstances, most taxed. It is to be remarked that such cases of so-called peripheral incidence are associated with individual predisposition; hence these diseases are generally sporadic. Something in the antecedents of the individual has determined the local character of the effects of chill, whereas the great climatic fevers more uniformly befall those who expose themselves.

**Rheumatic Fever.**—Rheumatic fever is universally admitted to be an effect of chill. "I know of no other exciting cause of acute rheumatism," says Watson, "than exposure to cold, and especially cold combined with moisture." The conditions, both external and predisposing in the individual, which constitute the peculiar liability to rheumatic fever are nowhere found more distinctively than in the variable climate of the British Islands, and in the habit of body of the people. It is especially a disease of early manhood and womanhood, and of the working class; when it occurs before puberty it is associated in a remarkable way with the liability to chorea.

The onset of the fever is preceded for a few days by general ill health, chilliness, furred tongue, "break-bone" pains, aching pains in the joints, some quinsy, and disturbed sleep. If these symptoms proceed no farther, the patient would be judged to have had a chill, a catarrhal attack, a quinsy, or the like. When the initial upset has been more considerable the pains "settle" in one or more of the larger joints, often the ankles at first, the knees subsequently, or the wrists, elbows, and shoulders. The patient lies flat on his back, not daring to move, and following the objects around with his eyes only. Profuse sweats break out from time to time, having a peculiar acrid smell, by which rheumatic fever can even be diagnosed. The joints where the acute pain is seated for the time being are swollen, tender, and often red and hot, the swelling being either in the fibrous structures around the joint or in its synovial cavity. The *locus* both of pain and swelling shifts from joint to joint; the disease often "sies to the heart" (pericardium and endocardium), more rarely it "sies to the brain" (meninges). The urine is scanty, high-coloured, depositing brick-red urates, and with an excess of urea on analysis; it is, in fact, the urine of disordered heat-regulation. The temperature is 100° or 101° up

to 104° or 105°, and in some exceptional cases (of "hyperpyrexia") rising to 109° Fahr. There is an afternoon rise of 1° or more, and a corresponding fall in the night. The severity of the case—apart from its danger, which really depends on the pericardial or endocardial part of the disease, or on complications with pneumonia and the like—is measured by the height of the temperature, with which, again, the intensity of the pain in the joints goes hand in hand. The outbreaks of sweat do not follow any obvious law, and they are not "critical," as in intermittents; but they seem to give the patient relief for the time, even if they leave weakness behind. Nine days is considered an average time for such an attack to run its course if the patient be well cared for; but deservescence is gradual, and complete restoration to health is often slow, much weakness and anæmia remaining to be made good. Warren, a physician of a former generation, when asked what was the best remedy for rheumatic fever, answered "Six weeks." Relapse is not uncommon, a very slight chill or sudden abstraction of heat sufficing to bring the fever back.

Now if we assume that the occasion of an attack of rheumatic fever is chill—that is to say, a sudden shock or injury to, or disorganization of, the nervous centre which presides over the uniform body-temperature—we enter upon a profoundly interesting problem in following out the constitutional manifestations. Everything points to the mechanisms of locomotion, to the structures and surfaces where muscular work is applied; even the heart, as Watson remarks, is in its perpetual to-and-fro movement comparable to "one of the large joints." There is heat of combustion from some source or another to account for the rise of temperature, which is sometimes enormous; but it is not the heat of work done. We are again confronted with that most fundamental of all the questions relating to fever, the question, as stated by Foeter, whether the "metabolism of even muscular tissue might be influenced by nervous or by other agency in such a way that a large decomposition of the muscular substance, productive of much heat, might take place without any contraction being necessarily caused. . . . in such a way that all the energy set free would take on the form of heat." Is rheumatic fever one of those cases where disorder of the heat-regulating mechanism falls on an important member of the executive, namely, the muscular system, just as it falls on the liver in tropical abscess, and on the lungs in pneumonia?

Certainly we know of no muscle but the heart itself which shows appreciable structural changes in rheumatic fever; the heart is liable to "myocarditis," as well as to endocarditis and pericarditis, but, for all other muscles, the changes are in the tendons, ligaments, and synovial membranes only, or, in fact, in those structures by which the work of muscles is applied. These structures have nerves, some of them large enough to be looked for in the dissecting-room, although less is made of them in physiology. The function of the nerves of the joints is not sensory in the ordinary use of the term, but it may be said to be to convey to the centres the *sense of effect* of the work done by muscles. When there is intense metabolism of the muscular substance, but no work done, the same nerves, having no sense of effect to convey, convey an acute *sense of pain*. The pain of rheumatic fever is altogether more acute than in inflammations. In tropical abscess pain is subordinate, and its place is taken by a vague feeling of trouble, or tightness, or weight, or heat in the hypochondrium, and the same substitution is sometimes made for the pain in pneumonia; but in rheumatic fever pain may be said always to be the grand symptom, and a measure of the very remarkable power of recovery. Reversing the maxim which applies to tropical abscess and to the worst cases of pneumonia, we may say of rheumatic fever: "Affert plus doloris quam periculi."

Sweating is the other grand symptom of rheumatic fever. It can hardly be said to be critical for the disease as a whole, because the temperature does not fall; but the joints affected for the time being are relieved by it, and it is critical to that extent. We may, indeed, say that the temperature does not fall because the heat goes on being generated in some other group or groups of muscles in whose joint or joints the pain is next felt.

We may regard, then, the sequence of events in rheumatic fever somewhat as follows. There is an upset of the heat-regulating centre by chill, owing to which an extravagant amount of heat-generating nerve-influence is sent out; this falls, for some reason of the body's habit (inherited or proper to the individual's occupation, or otherwise special), upon the muscular system, whose metabolism produces heat without work; the articular nerves which are ordinarily employed to convey the sense of effect of work done, from the surfaces where the movement is applied, convey, under the changed circumstances of the muscles' activity, a sense of pain. One set of muscles after another generates heat without work, so that one joint becomes painful after another; and, although there are perspirations by which the heat of the body is parted with, other sets of muscles take up the work of combustion in their turn, so that the excessive temperature is maintained. Among other muscles the heart is affected; and, just as in the voluntary muscles the structural effects are in the synovial membranes, ligaments,

tendons, and aponeuroses, so in the heart they are in the pericardium and in the more fibrous parts of the endocardium. But they are sometimes in the cardiac muscular tissue itself, the muscular substance of the heart being peculiar.

The association with chorea may now be noticed. Choreia is not a disorder of heat-regulation, and it is not due to chill; it is a disorderly habit of some nervous centro or centres whereby the ordinary work of muscles is made irregular, and it is due to some feebleness in, rather than to injury of, the nervous mechanism. The considerable liability of choreic subjects to rheumatic fever, the actual endocarditis that they suffer from even if they have never had rheumatic fever, the occasionally observed choreic movements of the muscles in the course of true rheumatic fever in adults, the occurrence of chorea as a sequel of rheumatic fever—all these associated things go to show that the disordered nerve-centre is the same in both diseases, and that the discharge of its force may pass readily from one path to another. It may either set free muscular heat without muscular work, excessive in degree and attended by unique pain in the joints; or it may spend itself in those gratuitous displays of muscular work which amount to chorea.

The foregoing diseases have been regarded as errors of the heat-regulating nervous mechanism. In rheumatic fever we have seen that there is a singular relationship to a truly nervous disorder, namely, chorea. It remains to mention another implication of the nervous system which several of them have in common, namely, an herpetic eruption about the corners of the mouth. Herpes is now accepted as an affair of certain cutaneous nerve-areas; and in malarial fever, pneumonia, and acute attacks of quinsy due to chill there are very apt to be eruptions of herpes labialis. Why the labial region should be involved is not obvious.<sup>1</sup>

#### § 14.—INFLAMMATION.

The inflammations may be regarded as an empirically made-up group of disordered states which have somewhat in common. Although inflammation is certainly a provisional category, there has always been a tendency to overcrowd it with newly-described morbid conditions, rather than to empty it of its temporary occupants. Whenever pathologists have become impatient to say the last word about the endless perplexities of disease the class of inflammations has become unusually full; this happened in the period of Broussais, when even the specific infections were placed therein, as gastro-enteritis and the like; and the frequent resort to the termination *itis* in more recent pathology may be taken as an evidence of a corresponding habit of mind. Thus there is much fairness in the bold criticism of Andral: "Reçu dans le langage, sans qu'aucune idée précise lui ait jamais été attachée, sous le triple rapport des symptômes qui l'annoncent, des lésions qui la caractérisent, et de sa nature intime, l'expression *inflammation* est devenue une expression tellement vague, son interprétation est tellement arbitraire, qu'elle a réellement perdu toute valeur; elle est comme une vieille monnaie sans empreinte, qui doit être mise hors de cours, car elle ne causerait qu'erreur et confusion." It is at least the duty of pathology to reduce the congeries of inflammations to as small a bulk as possible, to follow up the analysis of the inflammations one after another until they are reduced to the scientific position of errors of the respective structures and functions. Inflammations, indeed, are best regarded as an ever-diminishing residue; there is always the residue, because the correlated structural and functional aspects of the life of the tissues cannot be stated with equal clearness for all of them. It is the great binding tissue of the body that gives occasion for this nomenclological residue; the connective tissue is the one tissue about whose dual life of structure and function there is a difficulty. We shall appreciate its unique position best by comparing it with so direct a modification of

itself as fat-tissue. But even these phlegmasias are capable of some further analysis in the direction of disordered structure and function if we have regard to the functions of the embryonic mesoblast, and to the "memories" of the same that the common binding tissue never quite loses.

The earliest and most fundamental notions about inflammation, and those which pertain to the residue above spoken of, were derived from the external parts of the body when injured by blows, wounds, scalds, the lodgment of foreign bodies, and such-like palpable irritations. Along with simple inflamed wounds were taken cases of erysipelas, a disease which has now become the sole heir of the original Greek name for inflammation, namely, phlegmon. It will be convenient to begin with a brief reference to erysipelas.

*Erysipelas*.—Besides phlegmonous erysipelas, or diffuse inflammation and suppuration of the cutaneous and subcutaneous connective tissues, there is a common form consisting of redness, swelling, pain, and heat of the surface only, and stopping short of suppuration.

This condition often follows a wound, especially in the region of the scalp or face; it may occur also when there is no obvious wound, although there will probably have been a catarrhal state of the nearest mucous membrane. Fever or constitutional disturbance usually precedes the inflammation twenty-four hours or less, and in this respect erysipelas is comparable to the effects of chill already treated of. Wounds received in a drunken brawl are especially apt to become erysipelatos; also the wounds of those suffering from kidney-disease or liver-disease. Erysipelas is most apt to occur in cold weather with east winds, or in cold and damp weather. One attack predisposes to others. It often arises spontaneously or autochthonously, but it is perhaps equally often induced by contagion and inoculation from pre-existing cases. Of its origin *de novo* from time to time there need be no question; thus, it has been observed in a single individual of a ship's company at sea off Cape Horn. The redness and swelling advance with a well-marked border from the wound or other starting-point until they have invaded, it may be, a large cutaneous area. There is exuded plasma in the spaces of the connective tissue, and there are also nuclear cells (leucocytes) in the lymphatic spaces and vessels, and in the tissue generally. An increase of the colourless cells in the blood is also described. Since attention has been called to the presence of minute living organisms in disease there have not been wanting authentic descriptions of micrococci in the lymphatic spaces of the advancing margin in erysipelas, although they are said to be absent in the older areas of the inflammation, and during the stage of subsidence generally.

In *phlegmonous erysipelas* the connective tissues to a considerable depth beneath the skin are soaked in serous fluid, which becomes turbid, like thin pus; at a later stage the lines of pus extend in all directions along the tracts of binding tissue, fragments of the latter being found as detached shreds in the larger purulent centres. The skin, usually of a limb, may thus become involved over a large area and to a great depth, considerable pieces of tissue falling at once into a state of slough. The temperature is often as high as 105°, and delirium, with other symptoms of nervous disorganization, is common. Death from failure of the heart is probable. This disease is the most extreme form of phlegmon, by far the most formidable inflammation that exists. It is usually the sequel of a wound, but not invariably. Chilliness and all the other symptoms of commencing fever precede the local phlegmon, so that the condition is comparable to those errors in the regulation of the animal heat, previously mentioned, in which the incidence falls upon a peripheral part. That it is itself a local effect of general temperature disorder cannot be maintained, inasmuch as there is usually nothing in the antecedent circumstances to implicate directly the heat-regulating centre. However, it is not the extent of the local injury that serves to account for the inflammation, but the habit of body of the patient, especially the drinking habit. It is not an overtaxed heat-regulating centre that is implicated, but a nervous system overtaxed in more general respects. A peripheral injury, not necessarily a severe one, tells in an unusual way upon the unstable centres, just as in tetanus; and the outgoing response falls in a peculiar way or with a peculiar force upon the wounded part, producing phlegmon there and fever generally. Whether the rise of the body-temperature is mainly due to over-combustion within the injured area is open to discussion. The connective tissue as a source of heat has not hitherto come into our consideration; if it is to be regarded as a member of the heat-producing executive, under the central nervous control, its membership is at least not important except when the redness, swelling, heat, and pain of inflammation are present.

<sup>1</sup> See Sénator, *Untersuch. über den feberhaften Process*, Berlin, 1873 (abstract and criticism by Sanderson, in *Rep. Med. Off. Privy Council*, 1875); C. F. Oldham, *What is Malaria, and why is it most intense in Hot Climates?* Lond., 1871; Cl. Bernard, *Leçons sur la Chaleur animale*, Paris, 1876; Morehead, *Clinical Researches on Diseases in India*, 2 vols., Lond., 1856; Jas. Johnson, *Influence of Tropical Climates*, 4th ed., Lond., 1827.

The same state of the tissues as in phlegmonous erysipelas is brought about, all but the redness of the surface, by a very different cause—the introduction of a minute quantity of venom, either the cadaveric venom introduced in a dissection-wound or the venom of the rattlesnake and adder. The bites or stings of many other animals produce more transitory inflammatory effects.

In common inflammation, such as follows the lodgment of a splinter of broken glass under the skin of the hand or arm (to borrow Watson's illustration), there is first pain; soon there is redness around the point of entrance, with swelling and heat; the skin becomes of a bright-red colour; the swelling increases, becoming hard and firm at the centre of the inflamed area, and exquisitely tender, or painful to the touch. If these local effects are at all considerable (according to the nature and extent of the injury, and to the susceptibility or habit of body of the individual) there is *inflammatory fever* some hours later. At first there is usually chilliness and feebleness, then there is a general feeling of heat and dryness, with a quick, full, and hard pulse, headache, wandering pains in the limbs, restlessness, some mental confusion, disturbed sleep, a white tongue, thirst, and loss of appetite. If the piece of glass be removed all these symptoms, local and general, may subside quickly. If the source of irritation remain, or even, notwithstanding its removal, if the primary shock has been severe, the symptoms continue and intensify. Relief to the constitutional disturbance comes with the further developments in the injured area—with suppuration or, at the latest, with the bursting or letting out of the matter. Healing then proceeds as described under "repair."

This is the usual sequence of events in common inflammation, in the inflammation of moderate degree in a healthy person. It differs from erysipelas or phlegmon in the important respect that the fever follows the local effects at an interval of several hours. Where the injury is of the most violent kind, as in some machinery accidents, neither the local effects nor the fever are pronounced; the "reaction" is said to be in abeyance, and death is apt to occur from shock. In these cases the face is blanched, the action of the heart and lungs feeble, and the mental faculties profoundly oppressed; the presiding control has been so upset by the injury to even a limb that the forces of the body do not rally.

The heat of an inflamed part is not merely in the feelings of the patient; it is actually several degrees (cp to 6° or 7° Fahr.) higher than the temperature of the part in health or of the corresponding part on the opposite side, although it is never above the central blood-heat of health. It is not solely dependent, therefore, on the general state of fever. Neither can it be said that the general state of fever is solely dependent on the increased local combustion. In erysipelas, as we have seen, the general fever usually precedes the local, and must depend upon some general error of heat-making. Again, in a common inflamed wound, the general fever may, and usually does, subside some time before the cellular changes in the part, degenerative or formative or both, have passed their climax.

*Implication of the Nervous Control in Inflammation.*—From slight inflammations, with little more than redness and pain at the seat of injury, to the most shattering strokes there is a succession of steps. The nervous system is implicated in them all, for the reason that the nerves are everywhere, and everywhere ready to transmit impressions to the centre. It is not surprising, then, that in every doctrine of inflammation since the time of Cullen the events have been largely traced to the direct action of the nerves and nerve-centres. Amidst all the conflicting views taken of the nature of inflammation in current writings, there is agreement on this point at least, that the nervous control has much to do with it,—if not always the central control, yet some local control whose existence would hardly be suspected but for the phenomena of inflammation. The differences of opinion begin when we come to the details of the nervous control. Does the nervous system preside over the action of the vessels only, or does it preside over the whole cellular life or the nutrition of the part? Opinions have had a tendency to range themselves on two sides, corresponding in the main to the more mechanical or to the more "vitalist" conception of life as a whole. The afflux of blood, which every one recognizes as the first conspicuous event in an inflamed part, has been attributed in the latter view to an attraction exercised by the cells of the part, to a hunger for blood comparable to that which causes a determination of blood in an organ that is going to be physiologically active. "The facts," says Alison, "afford a strong presumption that the impressions made on the capillaries, and on the blood contained in them, solicit the flow through them on the principle of a vital attraction of the blood rather than of relaxation of the vessels." This is the "solicitation of fluids," the "movement of turgescence" or the "vital erection of vessels" of the older authors. If the needs of nutrition are the ordinary attraction, they may be simulated by such incidents as wounds, scalds, and the like; and it is the peculiarity of inflammation that the incidence of these is on a tissue whose physiological interest is ordinarily of little or no account, namely, the common binding tissue. It is with justice that Rindfleisch emphasizes the intimate connexion between the common binding

tissue and the peripheral nerves and nerve-plexuses. "They run exclusively in the connective tissue; in it they divide and form plexuses, which ultimately join, without any definite demarcation, with the network of connective-tissue corpuscles. Their distribution in the connective tissue designates these nerves for some definite function; they are admirably adapted to play a part in the general physical and chemical changes of the organs, to give information of the same to the central nervous system through their corresponding states of excitation. With the connective tissue they participate in the most intimate structure of organs, with the connective tissue they are stretched and pressed upon, with it also they suffer those obnoxious excitations which any considerable accumulation of waste matters brings with it." Now, it is known from numerous experiments that, if a nerve of common sensation be stimulated, the outgoing response from the centre is by way of removing the tonicity of the arteries of the part, so that they dilate and transmit much more blood. This outgoing influence is assumed to travel by a special set of fibres called, for convenience, "depressor fibres," because the effect has been to take off the tonic contraction of the arteries. The same effect is strikingly seen (although it is there accompanied by a conscious mental state) in the rising wattles of a cock, for which class of erectile effects the nerves are called "nervi erigentes."

But if this kind of turgescence is the best physiological analogy for the redness of inflammation it goes but a little way with us into the morbid condition. The tonic contraction of the arteries is no doubt taken off, and the vessels become distended with blood passing through them; but the next event is peculiar to inflammation,—the current of blood becomes slower, slow even to a stop in some of the numerous cross-channels of the capillaries. There is nothing in the mechanics of the circulation to account for this dallying of the blood at the seat of injury. The further discussion of the subject will be made easier by a reference to slight degrees of inflammation set up experimentally in transparent and delicate parts where the process can be watched through the microscope,—in a piece of frog's mesentery drawn out through an aperture of the abdomen, or in the everted membrane-like tongue of the same animal. When the microscope was first applied to the study of inflammation these same effects were often observed by Paget and Wharton Jones in the wing of the bat, an animal which has the advantage of being comparatively warm-blooded.

*Experimental Study of Inflammation.*—The frog having been paralyzed by curare, a loop of the intestine is pulled out through a slit in the abdomen, and its mesentery stretched over a ring of cork, so that the light may be reflected to it from the mirror of the microscope. It hardly wants an irritant, such as a drop of weak acid, to produce the inflammatory effects on this thin membrane; mere exposure to the air suffices. In ten or fifteen minutes the arteries begin to dilate and then the veins, and the vessels go on dilating for the next two hours, when they will have reached about twice their ordinary calibre. They remain so dilated, and in an hour or two the current of the blood becomes slower in them. In the older observations on the bat's wing acceleration of the current through the dilated vessels was first noted; then came the transition to the peculiar inflammatory action, namely, slowing of the current, the vessels still remaining dilated. This slowing of the stream is most obvious close to the injured point, where there may be complete stagnation in the capillaries, the crowded corpuscles giving the central area a brilliant carmine appearance. Farther away from this area the streams are more rapid; and at the farthest limits there is the unusually full and rapid flow of normal hyperæmia. The fulness of these dilated vessels exhausts their elasticity, so that the pulse-wave of the blood, which should be felt only in larger vessels, becomes perceptible also in the smallest.

In the area of retardation in the frog the blood-disks and the white corpuscles cling to the sides of the capillaries and small veins, instead of forming, as usual, a procession in the central line of the tube. Most of all do the colourless corpuscles adhere to the walls, in the experiment on the frog, until they form a kind of outlined mosaic on the side of the vessel. Then, if a particular spot be watched for several hours continuously, it will be found that some of these cells have actually worked their way slowly through the wall of the small vein. This is the important phenomenon of emigration of the cells of the blood, known to Gendrin and W. Addison, accurately followed by Waller, and rediscovered by Cohnheim.

*Incontinence of the Vessel-walls.*—The incontinence of the vascular walls in inflammation is proved, not only by this emigration of cells from the small veins, but also by the escape of red blood-disks from the capillaries, and by the familiar and old-established fact of exudation of the fluid part of the blood,—the plasma or serosity. In the words of Alison: "First, the surrounding textures are loaded with a serous fluid; but gradually changes take place in this fluid, which indicate that other constituents of the blood have exuded from the vessels; or part of the fluid effused assumes a gelatinous consistence, and forms flakes or layers which gradually become solid. In the semi-fluid matter first effused, according to Gendrin and others, decolorized globules of the blood may often be per-

ceived; and in many cases globules of pus, known by their larger size and freer motion on one another (and, when observed in mass, by their yellow colour), soon appear in this effused matter; and it assumes more or less rapidly, and more or less generally, the form of purulent matter. . . . Along with the semi-fluid lymph effused in the earlier stage of inflammation there is often extravasation of the colouring matter of the blood, and sometimes of entire blood." This, then, is the central fact of inflammation,—the incontinence of the vessels and the exudation from them.

Addison adopted the theory that the pus of inflammation was nothing but the colourless cells of the blood that had been washed out with the plasma; and that doctrine has been revived by Cohnheim with little or no reserve. There have been serious objections to this doctrine of the origin of pus; practical surgeons have always failed to understand how all the pus could come from the blood, which has not only a mere trace of colourless cells in it, but, moreover, contains neither more nor less of these cells during suppuration than at other times. Again, in cases of leukaemia, where the number of them is enormously increased, the course of inflammation does not appear to be affected thereby. Lastly, it is pointed out that we cannot infer altogether fully from the extremely susceptible transparent membranes of the frog to the subcutaneous and other connective tissues which are the usual seats of the inflammations met with in practice. So far, then, we are justified in admitting only the incontinence of the vessel-walls, the escape of some colourless cells, and of plasma, the latter yielding fibrin under some circumstances, in combination with the paralogin and the ferment known to reside in the white corpuscles.

The cause of the incontinence of the vessel-walls naturally engrosses attention. In an experiment of Cohnheim's a similar condition was produced in the vessels of the frog's tongue by ligaturing the tongue bodily at the root, so as to stop the circulation in it altogether. If the ligature were kept on for six days the tongue began to mortify, and the circulation showed no power to re-establish itself; if it were removed after forty-eight hours the current slowly resumed its flow, the arteries returned from their dilated condition, but not the veins, and the colourless cells began to escape from the latter; or removing it after twenty-four hours only, the circulation quickly resumed its normal course without any transient emigration of cells. The conclusion was that the walls of the vessels suffered a certain loss of "integrity" if the circulation through them were stopped beyond a certain limit of time, and this loss of integrity seemed to be analogous to the alteration of the vessel-walls under the blow of an inflammation. On the other hand, it has been pointed out that not the vessel-walls only, but the cells in closest proximity to and in intimate nutritive relation with them, are affected by the stroke of inflammation; where such cells have processes, and can be seen, they are found to draw in their processes under an irritant. In the exposition of Cohnheim, however, these changes in the cells of an inflamed part are not admitted to be other than regressive or passive; according to him, the walls of the vessels only are affected, and affected in their molecular constitution.

*Suppuration.*—We have seen that there still remains the difficulty of accounting for the large quantity of pus; and it will probably be found that to account for the pus we shall have to ascribe a more than passive attitude to the connective-tissue corpuscles of the inflamed area. Where the suppuration is diffuse, as in phlegmon, and still more where it is discontinuous, as in secondarily inflamed lymphatic glands, it is not to be supposed that the pus is a mere aggregate of blood-cells brought thither. Something from the primary seat of inflammation has caused the more distant parts, whether they be continuous or discontinuous, to take on the inflammatory and suppurative action; but it is quite clear, if we examine a lymphatic gland beginning to suppurate, that its own cells yield the pus. There has been an *action of presence* on the parenchyma of the lymphatic gland; and it will be difficult to account for the production of pus in acute primary inflammation without assuming the same action of presence. In inquiring after the catalytic agent suspicion falls on the substances exuded from the vessels, and mostly upon the emigrated colourless cells. Suppuration, when it occurs, is subsequent to and secondary to the exudation. When no suppuration occurs, as in what is called *adhesive inflammation*, which is the commonest kind on free surfaces, the exuded blood-plasma simply coagulates, forming a fibrinous layer, in the meshes of which are a larger or smaller number of colourless blood-corpuscles. In the further development these blood-cells are probably themselves the active elements; they produce the tissue of adhesions, which is a form of the tissue of repair. In situations which are not free surfaces—that is to say, in the subcutaneous tissue, or more generally in the tracts or planes of the common binding tissue—the exuded substances are less apt to coagulate or to take the adhesive fibrinous course. It is in these deeper situations that we ordinarily get suppuration, an event subsequent to exudation and undoubtedly dependent thereon. It is true that "inflammation" may be excited on the surface of articular cartilages and in the cornea, where there are no blood-

vessels to yield an exudation; but the inflammation is not of the ordinary kind, and in particular there is no true suppuration until the nearest blood-vessels have projected their system as far as, or close up to, the irritated area. Artificial keratitis has been the chosen ground of controversy to determine whether it is the vessels, or not rather the cells, of the part that are primarily and actively concerned in the inflammatory process; but it will probably be found that the two sides of the controversy correspond to two different sets of facts. The transparent superficial ulcer of the cornea has hardly anything to do with inflammation; it does not suppurate, although there is some formative action in the cells of the part to enable it to heal. Whenever there is true inflammation of the cornea it is accompanied by or preceded by extension of the nearest vessels to the transparent and non-vascular surface.

*Changes in the Connective Tissue.*—In the events of true inflammation, therefore, exudation from the vessels precedes suppuration; and it can hardly be doubted that they are cause and effect, to the extent, at least, that exudation is a necessary antecedent. At the same time the connective-tissue cells of the part can hardly have escaped that molecular injury, or injury to their nutrition, which the elements of the vascular wall would appear themselves to have suffered; they are, as Rindfleisch points out, intimately bound up with the plasmatic circulation or the ultimate diffusion of the juices; they are in closest relation with the terminal nerve-plaxuses; and, histogenetically, they are the remains of that "parablastic" embryonic tissue from which the blood-channels themselves were made. It would be surprising, indeed, if they escaped the shock which had deeply affected the integrity of the cells in the vascular wall. A concurrent alteration, at least, must be postulated for them; but that can hardly account for more than a preparedness in them to form pus. According to Stricker, the elements of the connective tissue revert to an embryonic character before pus is formed from them. If the hardness of the central core of an inflammation under the skin be analysed, it will be found to depend, says Stricker, upon the following things: the tissue is thickened, the network of cells in it is swollen, the intercellular substance is reduced, the network of cells has broken up into independent pieces of nucleated protoplasm. This is the swelling of the tissues which precedes abscess-softening; it is essentially a return to a more protoplasmic and less fibrillar state, and accordingly to a more embryonic state. Of this power of reversion to an embryonic state, which the common binding tissue of the body retains as a memory of development, we have already had illustrations in the processes of repair, of tumour formation, and of cancerous infection. In all these cases the tissue falls back upon a more elementary condition, or we may say that it retreats to broader ground, where, however, it cannot stand still. Its special destiny is settled for it in each case by the circumstances, and, for the particular case of inflammation (as distinguished from the process of repair), its special destiny is to form pus. If the analogy adduced in the section on "repair" has any value, pus is the by-product of a kind of blood-making from the embryonic cells, a hemato-blastic activity in which no red disks are formed, but only pus-corpuscles and a fluid, the corpuscles standing for the residual nucleus of the hematoblast (with evidence of cleavage in it) and the *liquor puris* for both the red disks and the plasma. This hemato-blastic doctrine of pus would correspond, in form at least, to Hunter's conjecture that "the new-formed matter peculiar to suppuration is a remove further from the nature of the blood." So long as the intensity of the process lasts, the connective tissue uses its reacquired embryonic powers only to make pus; when the effects of the blow have subsided (or if they have been from the first slight) as in the reparative process the formative powers of the tissue make granulation-cells and new blood-vessels (including even now blood within the vessels), and so the incident ends in repair. The pus of a granulating surface would thus differ from the pus of acute inflammation only in degree. In like manner, common inflammation with a moderate degree of fever differs only in degree from phlegmon, or diffuse suppuration, with its peculiar fever. The diffuse suppuration of phlegmon is the case where the infection or action of presence extends by continuity along the tracts of connective tissue; the implication of lymphatic glands (it may be at the outset) is the case where the infection is carried to a distance by the lymph-drainage of the tissues. Contrasting with such cases, the area of suppuration in a healthy subject (where there has been no extrinsic poison introduced) is a limited one; but, however limited the focus, it seems necessary to resort to infection of the connective tissue for an explanation if the exuded fluid turn to pus or the inflammatory swelling turn to abscess. It is in this sense that every inflammation may be said to be infective.

Assuming, then, that pus-formation is due to an infective influence impressed upon the protoplasmic connective tissue, and knowing, as we do, that the exudation from the blood-vessels is an invariable antecedent, the rôle of infecting cells would precisely suit those elements of the exudation about whose share in the inflammatory process there has been much controversy, namely, the emigrated colourless cells of the blood. As a material contribution to the pus all the cells that escape from the blood would go but a little



way; as insecting cells they might be the agents of much suppuration, and, through their wandering propensities, of suppuration at discontinuous points. They would thus have a power in inflammation analogous to that which has been claimed in a former section for catarrhal and other epithelial cells of a mucous membrane (or of a gland) which had found their way into the supporting connective tissue.

Among the things that determine the degree and course of an inflammation, besides the kind and extent of the injury, may be mentioned the florid or anæmic habit of body, the gouty habit, the alcoholic dyscrasia, the diabetic cachexia, the scrofulous inherited constitution, and the syphilitic taint. There are even cases where the predisposing cause is, as it were, strong enough to dispense with all but the slightest exciting cause; where, accordingly, the inflammation would be called idiopathic. But, however much the "crasis" of the blood or influence of the nerve-force may determine the degree and kind of inflammation, it is clear that the stagnation of the blood, the incontinence of the vessel-walls, the exudation, and the suppuration may all follow an injury where the crasis and the general nervous control are perfectly normal. The significance of micro-organisms in the inflamed area must be judged from the same point of view; all the events of inflammation may happen without them, but they may help to determine the kind and extent of the inflammatory effects.<sup>1</sup>

§ 15.—INFECTIVENESS.

One of the most dreaded results of a wound, or an inflammation from other causes, happily rarer in modern surgical practice than in former times, is pyæmia, septicæmia, or purulent infection. About a week, more or less, after the injury, the patient has a shivering fit followed by a perspiration; he may feel comparatively comfortable for a time, but there soon begin to be grave symptoms of constitutional disturbance. He becomes uneasy, has pains in the limbs, a weak and quick pulse, fever, loss of appetite and thirst, a dry and brown tongue, a somewhat jaundiced skin, and sometimes diarrhoea. The shivering fit returns at intervals followed by the sweating, the temperature rising to a great height and falling rapidly to a corresponding degree. Death usually ensues, sometimes not for two, three, or four weeks, being preceded by muttering delirium and unconsciousness. A curious symptom accompanying these phenomena is the sweetish odour of the breath. Meanwhile the wound, where there is one, will have ceased to discharge pus freely, becoming dry and brownish and yielding only a thin ichor; at a distance from the wound one or more joints may become swollen and painful, or an abscess may form at one or more points under the skin, or there may be pustules and discoloured patches on the skin.

In the examination after death the secondary abscesses may be very various in their seat, oftenest perhaps in the lungs, under certain circumstances in the liver, or in one or more joints, or in the substance of the heart, or at the back of one or both wrists. The parotid glands are peculiarly liable to diffuse secondary inflammation. In a class of cases called septicæmic for distinction, no secondary inflammations or products of inflammation can be discovered anywhere; in these cases the periodical shivering fits are not marked, although there may be profuse sweatings from time to time. In another class of cases, to which Paget has called special attention, the course of the disease is very protracted, being marked by relapses from time to time; and the chances of recovery are found to be in proportion to the chronicity.

In the pathology of these cases attention has always been fixed on the state of the veins leading from the wounded part, and of the blood in them. The old doctrine was that the veins secreted pus from their walls, which was carried into the blood-stream. This pre-microscopic opinion has given way to the modern doctrine of thrombosis and infective embolisms elaborated by Virchow. Not only the veins leading from an external wound, but the veins of the uterus after delivery, and other internal veins under various circumstances, may become lined by a layer of coagulum, or even blocked in their entire lumen; the coagulum undergoes puriform (although not purulent) degeneration; pieces of it, or molecular

particles of it, get washed off, carried into the blood-stream, and lodged as emboli in the small vessels of a terminal vascular area of the lungs or other organ or part, where an unhealthy form of inflammation arises secondarily. These events will become more intelligible by reference to a particular case.

A woman undergoes an operation for internal piles—sacculus dilatations of the inferior hemorrhoidal veins. The hemorrhoids had been ligatured, and for some reason there ensues an altogether unusual course of events. In a few days the patient has symptoms of pyæmia, and death follows in a fortnight. At the examination the inferior mesenteric vein, all the way up from its ligatured inferior hemorrhoidal branch to where it joins the splenic on its way to the liver, is found much dilated, lying along the left side of the lumbar vertebrae as thick as the little finger, of a greyish appearance externally, and filled with greyish puriform detritus. In the liver, to which this vein conducts, there are a number of inflammatory centres, some of them merely dark-red or livid circular areas, others of them purulent centres or true pyæmic abscesses.

In this case the wall of the ligatured vein had taken on some action which had affected the clot formed naturally within it; instead of the clot organizing, it had become a semi-fluid mass of puriform detritus; it had extended by continuity far up the main trunk of the inferior mesenteric vein, the puriform softening following it; particles or larger pieces of this unnatural clot had passed into the portal vein, and had become impacted in certain capillary territories of the liver, where they had infected the elements of the part (probably the connective tissue exclusively) to take on an inflammatory and suppurative action.

It is questioned by some whether there may not be a class of pyæmic and septicæmic cases in which no thrombosis (with puriform softening of the thrombus) of peripheral veins occurs; but it cannot be doubted that this kind of thrombosis, and the discharge of particles or pieces of the thrombus into the general circulation, are very general accompaniments of pyæmia and septicæmia, puerperal and other. The interest centres in the state of the vein-wall, which causes the blood to clot within it, where it would not otherwise have clotted, and causes the clot to undergo a puriform degeneration, or to acquire an infective power. The state of the primary wound must be held answerable in general for all the secondary events, from the thrombosis onwards. In the wound the ordinary products of inflammation cease to be formed, and, instead of them, there is an ichorous foul-smelling discharge, or a dry and semi-gangrenous condition of the parts; whatever this action may be, it communicates itself to the walls of the vessels, and the thrombosis (with detachment of the puriform particles) follows.

There are certain well-understood circumstances in which wounds take on such an action: the crowding of a number of cases of suppurating wounds in a limited space without adequate attention to the removal of the putrid discharges from the wounds, great nervous prostration of the subjects of wounds, the coexistence of kidney-disease, and such-like constitutional states personal to the case. The situation of the wound or exposed surface comes also into account; thus injuries of the bones (as in compound fractures), and especially injuries of the cranial bones, are more liable to take the pyæmic direction. Above all, the surface of the uterus after delivery, or contused wounds of the labia, or other lacerations, will take on an unhealthy action, either from the circumstances of the patient, or owing to a very minute quantity of infective substance (cadaveric or other) having reached it from without, or from the putrescence of portions of retained placenta. The liabilities of child-bed are increased by the circumstance that the blood in the puerperal condition is unusually liable to clot in the veins, even when their walls are in good condition, and also by the fact that the venous sinuses of the uterus after delivery are such as to afford opportunities for stagnation of the blood in them (unless the vigorous contraction of the organ have practically obliterated them), in which respect they resemble the venous sinuses of the dura mater.

*Experimental Septicæmia.*—The injection of small quantities of putrid substance into the circulation in animals, such as the dog, produces symptoms of septic poisoning corresponding somewhat to the symptoms as observed in practice. In this experimental septicæmia, as well as in the septic processes of man, there are many facts to show that bacteria are concerned. How these micro-organisms are concerned is another and much more difficult question. According to one view the lowered vitality of the tissues in a certain class of injuries, or in the injuries of a certain class of subjects, gives these ubiquitous organisms their opportunity. In this view the organisms initiate nothing; they are incidental to the morbid state of the tissues, and their presence in large numbers is rather the index of the liability to septic infection than the cause of any septic infection that may occur. The most extreme claim made for these organisms in purulent and septicæmic infection (as well as in erysipelas, ulcerative endocarditis, and diphtheria) is that their physiological activity (if not even their mechanical presence) determines the nature of the morbid process, including the tissue-changes, the type of constitutional disturbance, and, in general, the development, course, and termination of the infection. In judging

<sup>1</sup> See Paget, *Surg. Path.*; Simon, "Inflammation," in Holmes's *Syst. of Surg.*, vol. 1., 2d ed.; Sanderson, *ib.*, vol. 7.; Cohnheim, *Neu. Untersuchungen über die Entzündung*, Berlin, 1873; Stricker, *Virchow's Arch. allg. und exper. Pathologie*, Vienna, 1878-83, and in Ashurst's *Internat. Encycl. of Surg.*, vol. 1., Philad. and Lond., 1883; Van Buren, *ib.*

between the two extreme positions it should be remembered that there is nothing morphologically distinctive in these organisms found in diseased or injured tissues, that their so-called physiological activity in disease is merely begging the question, and that their mechanical presence, even if they were always present in sufficient numbers, has not yet been brought into any intelligible relation with the symptoms and the morbid anatomy. On the other hand, there cannot be the slightest doubt that one of the greatest desiderata of surgical practice is to keep them out of wounds (see SURGERY).

*Tumour-infection.*—This subject has already been treated of in the section on "cancer," but it will be convenient to add a few remarks on the parallelism between tumour-infection and purulent infection. In both cases we have a primary seat of morbid action and a secondary infection, and in each case the seats of secondary infection correspond on the whole closely. The closest correspondence is perhaps with sarcomatous tumours, which have the same relation to veins that primary infective inflammations have, and the same predilection for the lungs. Again, where the liver becomes the seat of secondary tumours, the first steps of the process of infection are on the whole parallel with those that may be observed in multiple abscesses of that organ, that is to say, the liver-tissues at a number of points undergo changes which are practically simultaneous within a certain radius, leading to a circumscribed abscess in the one case and to a circumscribed tumour-nodule in the other. Both the abscess-area and the tumour-area may be found at half-way stages of their development, the former being often recognizable in the section of a pyemic liver as a somewhat livid circular spot. In the tumour-process the morphological characters are always very definite, and the exciting agent has plainly come from the primary disease, carrying the structural marks of the primary disease in it. The primary inflammatory process wants the definite structural characters of the primary tumour-process, and still more does it want the endless variety of the latter; but it is still a textural process of the body, and its secondary processes are like it. The tumour-analogy, therefore, is strongly in favour of the idea that purulent infection, and inflammatory infection in general, has an autochthonous origin in the life of the cells and tissues.

*Melanosis.*—The term "melanosis" is used in pathology in at least two distinct senses. It is applied, in the first place, to the generalization or secondary extension of a primary tumour (usually sarcomatous), containing black or brown pigment; and, in the second place, it has reference to a remarkable generalization or widespread deposition of black pigment in the bone-marrow and elsewhere in the horse, particularly in those horses which are apt to lose whatever hair-pigment they may have had. Each of these two very different cases has its interest for general pathology.

The generalization of a melanotic tumour, even a very small one, is one of the most remarkable facts of infection. It is not unfrequently seen in the case of the spindle-celled sarcomatous tumours which grow from the pigmented connective-tissue cells of the choroid tunic of the eye (not the choroidal epithelium of the retina). In such cases the primary tumour is serious enough from its pressure effects, but it is infinitely more serious from its infectiveness. The liver may be full of large tumour-masses, black throughout or in part, and there may be other secondary growths elsewhere. Even more striking is the generalization which is apt to ensue from a subcutaneous melanotic sarcoma, or from a small spot of pigmented new growth on the basis of an old pigimentary mole, or nevus, or mother-mark (melanotic alveolar sarcoma). The secondary tumours occur at other points under the skin, often widely remote from the primary, and in the axilla, in the membranes of the spinal cord, in the liver, in the lungs, and even on the serous membranes. We have here to do with the ordinary considerations of tumour-infection, as already spoken of; but the presence of pigment in the cells and partitions of the new growth raises a further consideration. If we collect all the secondary tumours from a case where infection has been extensive, and express from them all the pigment, we should get a very considerable quantity, perhaps half a pint, of a thick black fluid not unlike printers' ink. The source of all this pigment has been perhaps a small speck of melanotic tumour-tissue in the skin, or, to mention a particular case, in the granulation-like tumour-tissue in the bed of the thumb-nail after an injury. How is it that from so small a source so much of this black substance has been produced?

The pigment is, of course, contained within the individual cells of the secondary tumours; these cells are a mimicry of the primary tumour-elements, and, as they reproduce the form and size of these, so also they reproduce their pigment-granules. So stated, there is nothing remarkable in the quantity of black fluid that may be collected from a case of generalized melanotic sarcoma. The primary tumour impresses the type of its own life upon a number of distant centres of cellular activity, so that these grow to be tumours, their cells at the same time becoming each a laboratory for the manufacture of pigment, extracting it from the blood for their erratic purpose. The true suggestiveness of these events is really in the way of analogy for another class of infections. It is often

said that, in an infection like smallpox, the virus must be an independent living organism, because it multiplies within the body during the evolution of the disease, the body which had received a most minute quantity of virus becoming in its turn a centre from which a thousandfold of the virus may issue. But, if a small speck of melanosis may yield half a pint of inky fluid by so impressing the cells of the body that they become so many laboratories of black pigment, then we can understand how, in smallpox, the cells of the skin at many points become laboratories in like manner, not indeed yielding black pigment, but supplying that which has to the primary contagion of a case of smallpox the same relation that the generalized pigment of melanosis has to the primary speck or nodule of pigmented spindle-celled or alveolar sarcoma. It is not necessary *a priori* to go so far afield as the ferment-action of living organisms for an analogy of this thousandfold multiplication; there is an analogy nearer home in the marvellous metabolic capabilities of the body's own protoplasm.

*Melanosis of the Horse.*—It sometimes happens that we find, in the carcass of an aged grey or white horse which had been originally brown or black or other shade of colour, that the marrow of all the bones in its body is changed into a uniform black inky pulp or fluid, that the clusters of lymphatic glands are full of the same in a drier form, and that there are black patches on the more exposed parts of the mucous membrane. This remarkable malady is not found except in horses whose coat had lost its originally abundant hair-pigment. Troussseau and Leblanc, who investigated the facts on a large scale at the Paris horse-knackers', were of opinion that in every horse which had turned white, more particularly if it had been originally black or brown or roan, the inguinal lymphatic glands were full of black pigment; and they concluded that the pigment there deposited was the equivalent of the colouring matter that the hair had lost, and that the blood being, as it were, overcharged with colouring matter, had deposited pigment in unusual places.

It is difficult to suppose that the melanosis in these cases is a mere quantitative equivalent of the pigment lost from the hair. The pigment of melanosis is more probably a true metabolic product of cells; and it is significant that it is most abundant, in the horse, in the old seats of hæmoglobin-formation, namely, the red bone-marrow. The bone-marrow (with other tissues as well) takes on a pigment-making activity, coincidentally with the bleaching of the horse's coat, and vicariously thereto. The melanosis of the horse is a striking instance of a constitutional malady, that is to say, it illustrates the very important pathological doctrine that an error in one part or function of the organism entails vital consequences elsewhere.<sup>1</sup>

#### § 16.—SPECIFIC INFECTIONS.

Infective disease of one kind or another stands for a very large part of the total sickness and mortality of mankind. It is entitled, therefore, to a larger space in a nosological outline than a single section at the end of an article. Each infective disease has to be considered by itself, from the natural-history point of view, and the salient facts of its history, geography, and ethnology, and its other particular circumstances to be taken along with its morbid anatomy and clinical history. It will be necessary, for the present purpose, to adopt a much more restricted programme, and to indicate little more than the place of the specific infections in the general scheme of disease.

Of diseases that have the property of infectiveness we have already dealt with cancers and other malignant tumours, and with the common infective inflammations. Reference has also been made to erysipelas, which is sometimes not merely infective as regards the individual body in which it arises, but a source of infection (or contagion) also for other bodies through conveyance of a virus. In the communicable class of infections we have to include so ordinary and simple a malady as a common cold, which is notoriously apt to go through a whole household, having been acquired in the usual way by some one member of it. The great historical epidemics of influenza which have overrun whole continents from time to time are held by some to be little else than colossal

<sup>1</sup> See Virchow, *Gesammelte Abhandl. aus dem Gebiete der wissenschaftl. Med.*, Frankfurt, 1858, *Cellular-pathologie*, chaps. x. and xl., and *Krankheiten Geschwülste*, vol. i. chap. 8, and vol. ii. ("Melanosis"); Billroth, *Allgemeine chirurgische Pathologie*, 8th ed., Berlin, 1876 (Engl. transl., New Syd. Soc., 2 vols., 1877); R. Koch, *Actiologie der Wundinfections-Krankheiten*, Leipzig, 1878 (Engl. transl., New Syd. Soc., 1880).

developments of those catarrhal epidemics which we meet with on a homely scale within single households. Another example of the same kind of communicability of a simple catarrhal affection of a mucous membrane is the Egyptian form of "cold in the eye" or ophthalmia, which was brought to England by a few of the troops returning from the expedition of 1801, and which spread by contagion for several years through the home-garrisons with a virulence quite unknown in the Egyptian climate, so that more than two thousand soldiers had to be pensioned for total blindness due to it.

In such instances a common and, it may be, trivial malady becomes a *species of disease*; it acquires the remarkable power of reproducing itself in persons who had not been exposed to the primary exciting causes. Not one in a hundred of the soldiers who were blinded by ophthalmia during the first ten years of the century had ever been in Egypt, just as, in a household where catarrh has become prevalent, perhaps not more than one member of it had sat in a draught, or been caught in the rain, or otherwise been subject to the conditions that ordinarily bring on a common cold. It is the acquired catarrhal condition that spreads from person to person, being faithfully reproduced in each new victim. The morbid condition becomes a kind of individual thing, of which the seminal particles are scattered abroad and induce the same morbid condition where they find a favouring soil or a favourable lodgment.

If all the instances of infection could be reduced to the same category as these, we should simply have to regard the specific infective diseases as the spreading or communicable forms of morbid conditions of the body otherwise accounted for—as states of disease leading a kind of independent life, but traceable in the last resort each to its origin in certain structural and functional errors of the body. The great problem of the species of disease would thus become an evolutionary problem. While this evolutionary problem would always have underlying it the unique difficulty of conceiving how a morbid state of the body could be integrated to become a semi-independent existence, with the power of reproducing itself by its germs as in the generation of living things, the interest for each specific disease would be to follow up, historically, geographically, ethnologically, sociologically, and otherwise, the conditions of body out of which the complex natural history of the disease-species had grown.

Proceeding, then, in the natural-history manner, and attempting, in the first instance, a grouping of the species of disease, the broad lines of division are into the chronic and the acute, and, among the acute themselves, into exogenous and endogenous.

*Acute Infective Diseases—Exogenous and Endogenous.*—The endogenous species of disease are those in which the infecting particles pass directly from the sick body to the sound, giving rise in the latter to a morbid state which follows the same order of unfolding and attains the same type as in the former. The exogenous species of disease are those in which the infecting or germinal particles have an intermediate state of ripening in the soil, or in water, or amidst other favouring conditions, producing a definite set of morbid phenomena in the exposed body, but a set of phenomena which may be, and often are, different in important respects from those of the primarily-acting subject. These contrasts between the endogenous and the exogenous infections may be illustrated by a reference to smallpox on the one hand and to cholera on the other. Any person whose skin is covered with the drying crusts of smallpox pustules may give off infecting particles which will set up the same disease if they find a lodgment in a susceptible person, the contagiousness of such a case of smallpox being somewhat heightened, no doubt, by a close atmosphere and the hirs. But for cholera, speaking generally, much more than this is wanted for the development of the communicated disease; the infecting particles have in most cases to undergo an intermediate stage of ripening in the soil or in other outside media. Yellow fever is even more than an exogenous infection; it is also vicarious, inas-

much as, over and over again, it has been from the emanations of dysenteric defects of the negro (who can hardly take yellow fever), and not necessarily from the effluvia of pre-existing yellow fever cases, that the infective power has proceeded. The vicariousness of yellow fever brings it into close relation with *typhus fever*, which is not otherwise counted as an infection of the exogenous group. No attempt to trace all cases of typhus to pre-existing cases of the same fever can possibly succeed; the succession has been broken repeatedly, and repeatedly started anew, amidst well-known circumstances of cold, hunger, filth, and general misery. In the larger proportion of typhus cases it is the miserable themselves who have suffered from the disease in addition to their other miseries; but there are numerous classical instances in which the more wretched of mankind have imparted typhus to their more comfortable fellows without themselves exhibiting the symptoms of the disease. The best-known historical cases are the Black Azazias, when prisoners who were brought into court from filthy dungeons so tainted the air of the court-house that the judges, the members of the bar, the jurymen, and the public were seized with a virulent typhus infection. If, in such cases, it should be contended that the prisoners carried the specific effluvia of typhus about their persons, although they themselves did not suffer with the specific symptoms of the fever, there are other cases where such a contention is entirely inadmissible. Perhaps the most remarkable of these is the case of the Egyptian ship-of-war which brought an epidemic of typhus to Liverpool in 1861. (*Epidem. Trans.*, i. p. 246, 1862.) More usually, however, it is the miserable themselves who first develop this *morbus miseris*, afterwards communicating it to the physicians and others who enter their dwellings or otherwise come near them. The *de novo* development of the symptoms of typhus, and subsequently of the independent contagion of typhus, has been abundantly illustrated in the naval and military history down to the close of the Napoleonic wars. The writings of Huxham, Lind, Pringle, D. Monro, Blane, and others, who served in the great typhus period, are full of evidence of that kind; the doctrine of the continuous reproduction of the typhus virus always from pre-existing cases is a purely academical affair, which dates from the ingenious dialectic of Bancroft's *Essay on the Yellow Fever*, &c., 1811. The rational doctrine of this kind of infective disease, based upon the practical experience of all times, is that which is stated by Pliny: "*Primo, temporis ac loci vitio, et acri erant et moriebantur; postea, curatio ipsa et contactus agrorum vulgabat morbos*" (xxv. 26).

*Relapsing Fever.*—Closely related to typhus in the circumstances of its origin is *relapsing fever*, which has extremely slight power of spreading among the well-to-do. Its synonym of *Jamies fever* is on the whole a sufficiently accurate designation of its circumstances of origin. Its more recently-acquired synonym, *spirillum fever*, is derived from the presence in the blood of a minute spiral living organism, as to which the standing question arises whether it is there because the particular state of fever is favourable to it, or whether the fever is there because the organism has, for some reason, invaded the body. Here, again, the conflict arises between academical dialectic and the more tangible facts of experience. It is maintained that relapsing fever can be given to the monkey by injecting the spirilla; but that circumstance by no means serves to show that the pre-existing cases of relapsing fever had occurred because spirilla had invaded the bodies of a certain number of persons. Relapsing fever is sometimes, though rarely, conveyed by infection to those who had not been living in a state of overcrowding and of semi-starvation; and such an incidence of the disease is so entirely arbitrary that even the spirilla, if they came from other cases, might be accepted as the active agents. The spirilla would have a real interest if it could be shown that they could initiate relapsing fever *proprio motu*. As the case stands, the predisposing causes of relapsing fever completely overshadow all other elements in the causation. The disease is always and everywhere *morbus pauperum*, and very often it is *typhus famelicus*.

*Typhoid fever.*—This fever holds a peculiar place in the history of specific diseases. It is unquestionably a far more common disease at present than it was fifty years ago, and it is certain that it was prevalent in Paris for some time before it began to occur, except as a rarity, in London and Edinburgh. The evidence of Christison and of other highly observant pathologists may be implicitly accepted that, while Louis and others in Paris were finding ulceration of the small intestine in fatal cases of typhus-like fever, no such lesion was ordinarily found in the Edinburgh practice. More generally, it may be said that typhoid fever has been a prominent factor in the mortality during the periods when typhus has been an insignificant one. The coincidence of decided typhoid years with the cholera years is perhaps irrelevant. But there can be little doubt that there is a close connexion between the rise of typhoid and the more or less considerable diminution of intermittent fever; there is indeed much evidence in a certain number of localities in favour of the opinion of Boudin, that malarial fever and typhoid fever are mutually exclusive in a given place.

Typhoid fever is undoubtedly a disease associated with the manner of disposal of human excrement. Whether the typho-

malaria; fever of the American Civil War, and of Rome, Naples, and other localities, is also an excrementitious infection is not so clear. The ordinary typhoid is peculiarly bound up with the modern system of water-closets and sewers, and with the faulty construction of the same; it was a familiar observation in Edinburgh that the Old Town, with its closes and huge tenement-houses, without the water-closet system, remained practically free from typhoid for many years after the disease began to be common in the New Town. The association with faulty sewerage is, however, not an invariable one. The disease occurs among remote and primitive communities, such as Norfolk Island in the Pacific, in Fiji, in Greenland, and elsewhere.

According to the contention of Murchison, and of many other living authorities, typhoid fever may, and often does, develop *de novo* in an individual who has received, either by the breath or in his food or drink, some peculiar or not altogether ordinary product of faecal decomposition. It is not alleged by this school that faecal decomposition under ordinary circumstances (especially under the free access of air) is attended with the risk of typhoid fever; but that a virulent property may, and often does, develop under some peculiar concurrence of circumstances, especially when faecal matters percolate and accumulate where little air reaches. If the process of typhoid fever be so induced in an isolated case, the dejects of the patient are specifically virulent; and from one such case many may be poisoned by means of specifically tainted water or milk distributed in common. The possibility of a *de novo* origin of typhoid fever now and then is vehemently objected to by the more doctrinaire school of pathologists; according to them there is always a pre-existing case, the virus of typhoid having been continuously reproduced *ad infinitum*.

*The Exanthemata.*—Another class of acute infections is those which are virtually independent of external circumstances, which affect all classes equally, and which pass by direct contact from the sick to the sound. The chief diseases of this class are small-pox, measles, and scarlet fever. As to small-pox, it has been contended, on the historical and geographical evidence, that it is primarily an African and Indian skin-disease which has acquired spreading power; and there is really no rival hypothesis of its origin. For *measles* the evolutionary clue would appear to be entirely lost. The old notion about it, expressed in the name "morbilli," was that it corresponded to a lesser kind of small-pox. There can be no doubt, however, of its present absolute nosological distinctness. It is as universal in its distribution as small-pox; sparing no race, and, like small-pox, committing its greatest ravages among virgin communities and among the dark-skinned. The natural history of *scarlet fever* is altogether different. It is peculiarly a disease of northern Europe; it is practically unknown as an epidemic throughout the whole continent of Asia (except Asia Minor), and the whole of Africa (except Algiers); and in North and South America and Australasia it seems to have followed the European immigration. One of the most remarkable facts concerning it is that it may occur in quite sporadic or isolated cases in extra-European countries. Some favourable concurrence of circumstances had given it a permanent hold in Europe, or had enabled an occasional erythema of the skin, with fever, to develop into a species of disease, in which the almost diphtheritic affection of the throat, the brawny swelling of the neck (with tendency to sloughing), and the acute affection of the kidneys may be so pronounced in certain individuals, and in all the cases of certain epidemics, or of the epidemics of certain localities, that the simple type of disease is obscured and the line of evolution lost. Perhaps one clue to the development of scarlatina from non-specific states of the body may be found in the cases of scarlet rash in children, in the surgical wards of hospitals. The evidence seems to show that in such cases there is something different from a merely heightened predisposition to the specific scarlatinal poison, on the supposition that the latter is ubiquitous; that there is, in fact, an inherent liability in some children to develop a scarlet rash, with fever, near a wound or sore, the condition so developed becoming communicable to others, as in the analogous case of erysipelas.

*Chronic Infective Diseases.*—The greatest of the chronic infections is *sypthilia*, unless, indeed, we admit tubercle unreservedly into the same class. Its enormous prevalence in modern times dates, without doubt, from the European libertinism of the latter part of the 15th century. It is almost certain that the same disease, with symptoms of constitutional infection, had developed in various parts of the ancient world under similar circumstances; but it is not less certain that a great redevelopment came in about the year 1490 in France, Italy, and Spain, so that we do not even require to assume a continuity of the virus from earlier times. The historical evidence may be read, in a convenient abridgment, in the third volume of Hissler's *Geschichte der Medicin und der epidemischen Krankheiten*.

Two forms of sore are described concurrently in all writings upon sypthilia, and, although it has been usual during the last thirty years to regard only one of these as truly sypthilitic, there has always been a certain inability in the profession at large to apprehend the reason

for making a radical distinction. One of the forms is a considerable and quickly-developed ulceration, sometimes multiple and with a marked tendency to extend its borders; it heals under treatment, like any other ulcer, and in many cases there are no after-effects throughout the body generally. The same person may develop such sores repeatedly. For a considerable time after the establishment of the doctrine of "true" or indurated infective sore it was taught that these simple ulcers were never followed by constitutional infection; but it is now very generally admitted that such teaching is too rigid or dogmatic, not according with the facts of experience. A recent writer on the subject in Berlin, who has kept records of his private practice, estimates that no fewer than 40 per cent. of all the cases which developed constitutional symptoms were consequent on primary ulcerations that would not have been included in the definition of "true" or Hunterian sores. It is not seriously disputed that these simpler ulcerations may arise independently of conveyance, as the direct results of gross personal negligence. It is at the same time admitted that they may become inveterate, that the process of healing may become irregular, and that they may gradually acquire that character of "induration" which is distinctive of the "true" sore. The various circumstances under which this change of type or development of characters may take place have, for obvious reasons, escaped being recorded with scientific accuracy; but of the fact of some such evolution there can be hardly any doubt.

The "true" or Hunterian sore is usually at first a small indurated papule, which breaks after a time, but causes little trouble in healing. The after-effects are, in their severity and long-continuance, in striking contrast to the disease at the outset. This form of the disease is an affair of infection from beginning to end, from the primary papule to the "gummatous" internal nodules years after; there is no evolution in the individual of an infective virus out of a common and unclean ulceration. The simple sore, the result of common inflammation under circumstances of gross personal negligence is not without a degree of infectiveness of its own. It has a tendency to spread, to enlarge its borders by including the margin of sound tissue in the ulcerative process, and it has also a tendency to infect the nearest packet of lymphatic glands with a suppurative action. Further, it is highly communicable to the persons of others by contact, reproducing one or more sores very like itself, and such communication is accountable for its wide distribution. But that degree of infectiveness is a very different thing from the true and full sypthilitic infection. The latter is often an affair of years, and, if may be, of a lifetime, and it passes directly to the offspring. Its earlier constitutional manifestations are in the throat, the skin, and the hair; its later in the bones, some muscular structures and some of the viscera, and more particularly in their blood-vessels, or in the blood-vessels of their coverings. It infects the lymphatic glands with an inductive rather than a suppurative process, and not only the nearest packet of them but also the lymph-glands in the neck and elsewhere.

In seeking for the beginnings of this profound constitutional taint, for the first steps in the evolution of the infection out of a common morbid state of the body, we naturally arrive at that irregular process of healing, or the inveterate soreness which the granulations of a simple ulcer (due to personal uncleanness or contact with the same) sometimes assume. The tissue of sypthilitic formations, wherever occurring, has been named by Virchow "granuloma," being a persistent state of granulation-like tissue, not proceeding to ordinary cicatrization, but to indurative and degenerative changes. In true sypthilia, as we have said, this kind of formation is from first to last the product of an infective virus, equally the primary hard papule, the indurated lymph-glands, the thickening and destruction of mucous surfaces, the nodes and inflammatory products in the periosteum, and the gummata in and upon the viscera. But the type of all this mimetic formative action must have been somewhere acquired or evolved; and we shall probably not err if we seek for the acquisition of the granulomatous type in the inveterate and irregular healing of the granulations of an ordinary foul sore under the peculiar circumstances of its own degree of local infectiveness, and in the continuous reproduction of such sores. In this way we should have granulations becoming specifically infective towards the body, or its distant parts, just as the products of simple acute inflammation may be infective to a distance, or as melanotic and other slight primary tumours are apt to propagate their texture and characters far and wide, or even as a common granulating sore under certain circumstances of irritation may develop the characters of tumour-tissue and a high degree of tumour-infectiveness. The products of sypthilia have a near affinity to new growths of the tumour kind; and it is with justice that Virchow includes them among tumours as one of the granulomata, and Klebs makes provision for them, along with tubercle, glanders, lupus, &c., in a class of "infective tumours." If we take the primary type to be the granulation-tissue of repair we shall assign it an intermediate position, and, at the same time, do justice to the circumstances in which this infective granulation-like new growth

probably had its origin, namely, the reparative process in inveterate or neglected ulcers of common and every-day origin, but with a contagiousness of their own, and with a certain infectiveness of their own towards the adjoining tissues and the nearest packet of lymphatic glands.

The most characteristic form of the generalized syphilitic infection, which may not manifest itself for several years after the reception of the virus, is a nodular or infiltrating new growth in various organs—in the liver, in the testes, or upon the brain, in the muscles (tongue and jaw-muscles especially), in the pericæum, and in the lungs. These nodules are called gummata from the somewhat tenacious, firm, opaque brownish appearance of the fresh-cut surface. The structure, where its vascularity is perfect, consists of small round cells lying mostly in rows among thin fibres, and it closely resembles granulation-tissue, only that the cells are smaller and the intercellular substance (fibres) harder or denser. Molecular death, or necrosis, overtakes this new formation at various central points, owing to the inadequacy or suppression of the blood-supply. One of the most remarkable features of the process is the enormous overgrowth of cells in the inner coat of the arteries within the affected area, leading to an accumulation of elongated cells and intercellular substance, which may even obliterate the channel of the vessel altogether.

Over the later products of syphilitic infection, both the nodular and the infiltrated, there are two drugs, mercury and iodide of potassium, which have a remarkable power, causing their absorption and conducting the infective process to a safe issue. Syphilis has been compared by Hutchinson to a very prolonged fever, with its stages separated by intervals of months; like a fever, it burns itself out, so that a time comes in the course of years, if the patient have not succumbed to the effects, when the system is practically free of the virus, just as it is free of the virus of smallpox in three weeks. In a certain proportion of cases only the secondary symptoms occur, and not the tertiary, the virus having presumably exhausted itself in the earlier manifestations.

In the *syphilis of the offspring* it is necessary to distinguish two classes of effects. On the one hand, there are the effects of general intra-uterine mal-nutrition, due to the placental syphilis of the mother; and, on the other hand, there are the true specific effects acquired by inheritance from either parent and conveyed, along with all other inherited qualities and tendencies, in the sperm-elements or in the ovum. These two classes of effects are commingled in such a way as not to be readily distinguished; but it is probable that the erroneous growth of bone, at the epiphyseal line in the long bones (sometimes amounting to suppuration), and on the surfaces of the membrane-bones of the skull, is a result of general placental mal-nutrition, like the corresponding errors of growth in rickets. The rashes and fissures of the skin, the snuffles, and such-like well-known symptoms in the offspring of syphilitic parents are to be counted among the true mimetic effects of the specific taint; so also the peculiar nuclear overgrowth in the supporting tissue of the liver, the interstitial pneumonia alba of the lungs, and the like. As in rickets, it is in many cases some months after birth before the congenital syphilitic effects show themselves, while other effects, such as interstitial keratitis, the mal-formations of the permanent teeth, and the rarer occurrence of laryngitis, come to light during childhood and youth. Injury to a syphilitic child is apt to have unusual consequences; thus a blow on the arm may be followed by a gummatous growth in one of the muscles.

*Tubercle and Scrofula.*—Tubercle and scrofula are among the commonest and most fatal diseases of mankind. No chapter in pathology has a more pressing interest; none is surrounded by so much theoretical difficulty, or concluded by so much practical failure. It is not only in Europe, but in America and the British colonies, as well as throughout the whole inter-tropical zone, that this remarkable wasting disease is found. The most considerable degree of immunity is said to be in Iceland and on the Asiatic steppes. While the mortality from this disease is very great, in some European countries amounting to one-seventh of the death-rate, and that, too, among the youth and flower of the people, there is everywhere evidence that a very much larger proportion had incurred a slight degree of the malady and had survived it. Nothing is more common in the course of post-mortem examinations than to find traces of "obsolete tubercle" in the lungs and lymphatic glands. Cohnheim recalls with some approval a saying that used to be current at Greifswald, that almost every one proved to have been "a little bit tuberculous"; and Rindfleisch bases his pathology of the disease on the assumption that a tuberculous disposition has become practically universal throughout the human stock, so that inflammations, under certain aggravated circumstances, may light up the disease in almost any one. It is peculiarly common in prisons, barracks, and workhouses; and, in the last-mentioned, tubercle and scrofula are not rare among the aged. There are instances within the knowledge of most people where the marriage of first cousins, and still more certainly of double cousins, has been followed by a very pronounced consumptive tendency in

the offspring, even if there had been no very clear history of consumption on either side before. No disease runs more in families than tubercle. While there are all these evidences of a widespread constitutional liability to tubercle, it is at the same time clear that the victims of the hereditary taint are only here and there,—perhaps one out of a large family, or one member of a family in childhood and another in the second half of life, according as they had been exposed to sufficient exciting causes. In the most extreme cases of heredity, which are not so rare but that one or more are familiar to every circle, the members of a family fall into consumption one after another as they grow up, as if by an inevitable fate.

The *relation of scrofula to tubercle* is a subject of much intricacy. The familiar instances of scrofula are the enlarged clusters of lymphatic glands of the neck in boys and girls, who are either of the fair and delicate type or of the dark and coarse type. Another large class of scrofulous cases are subject to white swellings or other chronic diseases of joints, usually the knee, hip, or elbow. But many lighter conditions, such as eczema of the head and face in children, are set down to scrofula. Again, serious visceral disease leading to a fatal result, especially in the kidneys, testes, ovaries, and bladder, is for some reason reckoned scrofulous rather than tubercular. But this latter class of cases is certainly tubercular, as much as anything can be said to be tubercular. A great part of all that is reckoned scrofulous may be said to be inherited tubercle, affecting the lymphatic glands of the neck most conspicuously, running a very chronic course, often disappearing at puberty, and associated with a delicate skin, fair hair, large eyes, and other features of a well-known type. Of the cases of scrofulous disease in the genito-urinary system and in the joints there may be some in which the disease had been inherited, but there are others in which it had been acquired. The senile scrofula of workhouses and the like is almost certainly an acquired condition. Whether as an inherited disease or as an acquired, scrofula can be separated from tubercle by no very definite line.

Tubercle, as the name implies, is a small tuber or round nodule; the nodules are often "miliary" or the size of millet-seed. For the variety of diffuse or "infiltrated" tubercle, which is often found in the lungs, it has been made a question whether it should be reckoned as tubercle at all, by reason of its wanting from first to last the character of distinct small nodules. Tubercles are sometimes large, especially the tubercles of the genito-urinary organs and of the brain; and these are generally made up of a number of smaller nodules fused together, and surrounded by a common capsule. The larger tubercular masses, or conglomerates of tubercles, are those that have been claimed as in a peculiar sense scrofulous. The fusion of numerous small tubercular centres into one large area can often be seen in lymphatic glands in all its stages under the microscope. The prevalent modern opinion is that all these various manifestations are due to the infective action of a virus, just as in syphilis; and, as the effects of the syphilitic virus include not only gummatous nodules but also "inflammations" of the skin, mucous membranes, pericæum, and other textures, so the effects of the tubercular virus include not only "tubercles," properly so called, but also a variety of diffuse "inflammatory" conditions.

The most common seat of the *tuberculous process* is the lungs, so that tubercle and phthisis pulmonalis have almost come to be synonymous. In a certain proportion of cases the tubercles and tuberculous "infiltrations" are found in the lungs only; but in many cases the pulmonary tuberculosis is only a part of a general infection which includes the serous membranes and lymphatic glands, the intestine, the liver, the spleen, the kidneys, the brain-membranes, the choroid coat of the eye, the bones, and the joints. Cases have been described also of tuberculous ulcers of the tongue and stomach, and of tubercles in and around the thoracic duct. On the assumption that tubercle is due to an introduced virus, it has been attempted to classify the cases according to the probable way of ingress of the virus; those with the pulmonary condition most prominent would have received the infection with the breath, while another class, including the numerous cases where miliary tubercles are found in the liver when carefully looked for with the microscope, would have absorbed the virus along with the food from one part or another of the digestive mucous membrane; the tuberculous kidney (with ureters and bladder), again, would be explained on the hypothesis of that organ attempting to eliminate the virus from the system. But even among the pulmonary cases there are some in which the tubercles had arisen from infection brought by the venous blood, just as in the dissemination of sarcomatous tumours; it has been shown by the very elaborate dissections of Weigert that tubercles may grow into the walls of veins, the tuberculous substance so getting carried into the blood-current, wherein the first resting-place would be the pulmonary capillaries, except when the vein was tributary to the portal system.

It is difficult to say what is the most characteristic structure of a tubercle. In the class of small grey translucent tubercles, all the same (miliary) size, the cells are practically granulation-cells; these are not uncommon in childhood and youth, where the attack is sudden and the progress rapid. In another kind, which Rind-

*Asiatic* would regard as distinctively "scrofulous," the substance is opaque and yellowish-white; there are many epithelial-like cells, or cells with a considerable zone of protoplasm round the nucleus, and, mixed with these, giant-cells or cells with many nuclei, usually marginal. Except in the most acute cases of miliary tuberculosis, the new formation, whether in the shape of isolated nodules or continuous tracts of "infiltration," undergoes changes. Sometimes it becomes a fibrous substance, but by far the most common change is into a yellow cheesy matter. This degeneration is comparable to the gummatous change in syphilitic formations, but in tubercle the degenerate tissue is much less cohesive, more friable, drier, more apt to fall into a molecular detritus. The caseous change is the distinctive degeneration of tubercle, the more occasional fibrous and calcareous changes being either its associates or its modifications. The reason of this change is the insufficient blood-supply of the new formation. Nothing so clearly accounts for the structural as well as the degenerative characters of tubercle as growth of tissue without adequate provision for admitting the blood into it.

*Bovine Tubercle.*—In the corresponding disease of the domesticated bovines—a very common disease of cows in town dairies—the characters of the new formations are equally determined by the kind and degree of blood-supply. In this form of tubercle the nodules are, in the first instance, on the serous membranes of the thorax and abdomen; they often attain a considerable size, and sometimes the size of quite large tumours; the vascularity of their surface is very considerable, and it is around their periphery that they grow, as in the case of sarcomatous tumours; but the blood-vessels do not go all through the nodules, their central parts being either calcareous, or caseous, or reduced to a thick mortar-like substance. The chief differences between this form of tubercle and the varieties ordinarily met with in man are that it is a more vascular structure, more like a sarcomatous or fibromatous tumour, with a power of growth from its surface (where the vessels are numerous), and sometimes attaining a great size, often suspended from the serous membrane by a vascular stalk or pedicle, and, in the interior of organs such as the lung, surrounded by a translucent capsule of vascular tissue, or excavated into a smooth-walled cavity, the thick translucent capsule being all that remains of the original nodule.

The origin of these peculiar multiple new formations in the domesticated bovines is a more likely subject of inquiry than the origin of human tubercle. The bovine disease is generally admitted to have its nodules referable to two distinct classes—primary and secondary: the primary are the multiple nodular tumour-like growths of the serous membranes, and the secondary are the infective descendants of these in the lymphatic glands, the lungs, the liver, spleen, kidneys, Fallopian tubes, bones, and joints. The secondary infectiveness of primary new growths is otherwise intelligible, according to analogies, and the interest therefore centres in the conditions of origin of the primary, parent, or infecting growths on the serous membranes. They occur by far most frequently in the cows of town dairies, that is to say, in animals closely confined for long periods, deprived of pure air and sunlight, forced in their feeding and milking, and altogether placed under such conditions of nutrition as commend themselves, not to an intelligent acquaintance with ruminant requirements, but to the short-sighted maxims of profit and loss which govern the policy of the cowkeeper. The vicissitudes of nutrition are pretty clearly indicated as the starting-point of tubercle in the cow.

In human tubercle we have no such indications of a division into primary new formations arising out of errors or vicissitudes of nutrition in some tissue, and into secondary new formations due to the infectiveness of the primary. On the other hand, the various new formations in a case of tubercle in man would appear to be co-ordinate, or all of them due to a common cause. Human tubercle is not by any means a multiple nodular eruption on the serous membranes first and in the lymphatic glands and lungs afterwards; if the disease occur in these three localities it is necessary to assume the same infective cause for it in them all. Most usually the first indications of human tubercle are at the apex of one or both lungs, and, in a considerable proportion of cases, the disease never goes beyond the lungs. But it is not on that account a purely pulmonary disease. For some reason the lungs are most apt to become the seat of the infection; but there are many cases in which the infection locates itself elsewhere as well, and there are some cases in which it avoids the lungs altogether. An infective virus has to be assumed, and yet we are unable, as in bovine tubercle, to discover any primary source of it in the physiological aberrations of the human body itself. The problem of human tubercle, therefore, may be said to be: Does the infection reach the body from without? and, if so, whence are its structural or morphologically mimetic characters originally derived? While some such question as that has to be stated for human tubercle in the last resort, it has to be kept in mind that a very large part of the sum-total of human tuberculous disease is an affair of strong hereditary predisposition, and even of direct inheritance. In bovine tubercle itself, which is often acquired *de novo* by cows subjected to grossly artificial con-

ditions of life, inheritance is credibly estimated to be answerable for more than one-half of its present very considerable total.

The pathology of tubercle (bovine and other) has had much light thrown on it by experiments to produce it artificially in animals by inoculation of minute quantities of tuberculous matter under the skin, or by mixing considerable quantities of tuberculous matter with the food for a length of time, or by feeding with the milk of tuberculous cows. A very suggestive proportion of all such experiments have succeeded. It has been boldly alleged by Koch that the active agent in the inoculative production of tubercle is not the tuberculous matter from a previous case, but a minute rod-like living parasite belonging to the order of schizomycetes (see SCHIZOMYCETES). According to this view tubercle is from first to last an affair of a parasite, equally the human tubercle and the bovine, although these two forms of tubercular disease are widely different in their anatomy. The weak point in the experimental evidence of Koch is that we are not sufficiently assured of the absolute separation of the tuberculous matter from the parasites. There is not reason enough to suppose, from the published details of these experiments, that the original tuberculous matter had all been got rid of; and there is therefore not reason enough to suppose that the induced tuberculous infection is due to anything but that matter itself, whose infective power, although not initiated by the organisms present, would probably be multiplied by their cultivation.

In the same class with syphilis and tubercle should be taken glanders, primarily a disease of the horse, but now and then communicated to man. There are various tropical and sub-tropical granulomatous infections of great scientific interest which can only be mentioned, such as *yaws*, *verruca Peruviana*, *Aleppo boil*, *Delhi boil*. There is also the *bullus scrovyi* of Ireland, now probably extinct. *Lepus* holds a peculiar place in this class of diseases. The position of leprosy also is an intermediate one, and its pathology the most difficult of all the constitutional endemic infective diseases. It was with reference to leprosy, and with particular reference to its enormous mediæval prevalence and subsequent extinction in most parts of Europe, that Sir James Y. Simpson wrote as follows in 1841 ("Antiquarian Notices of Leprosy and Leper Hospitals in Scotland and England," *Edin. Med. and Surg. Journ.*, vol. lvi):—"The *generatio de novo* of a really new species of disease," says Dr Mason Good (*Study of Med.*, i. pref. p. xxiii), "is perhaps as much a phenomenon as a really new species of plant or of animal." Dr Good's remark is probably too sweeping in its principle; for, if necessary, it might be easy to show that, if the particular diseases of particular animal species are liable to alteration at all, they must necessarily alter more frequently than those animal species themselves. In pursuing such an inquiry the pathologist labours under comparative disadvantages. The physiologist can, by the aid of geological research, prove that the individual species of plants and animals inhabiting this and other regions of the earth have again and again been changed. The pathologist has no such demonstrative data to show that, in the course of time, the forms and species of morbid action have undergone great mutations, like the forms and species of normal life. But still we have strong grounds for believing that, in regard to our own individual species alone, the diseases to which mankind are subject have already undergone, in some respects, marked changes within the historic era of medicine."<sup>1</sup>

## § 17.—TOXIC DISEASES.

In various parts of the world and at various periods there have been widespread outbreaks of sickness due to

<sup>1</sup> See Hirsch, *Handbuch der historisch-geographischen Pathologie*, vols. I. and II., 2d ed., Berlin, 1831-33 (Engl. transl., vol. I., New Syd. Soc., Lond., 1838); Häser, *Lehrbuch der Geschichte der Medicin und der epidemischen Krankheiten*, vol. III., 3d ed., Jena, 1832; Robert Williams, *On Morbid Poisons*, 2 vols., Lond., 1836-41; Murchison, *The Continued Fevers of Great Britain*, 2d ed., Lond., 1873; G. Gregory, *Lectures on the Eruptive Fevers*, Lond., 1843; Christian on "Fever" and "Continued Fever," in *Tweedie's Library of Medicine*, vol. I., Lond., 1840; La Roche, *Yellow Fever*, 2 vols., Philadelphia, 1855; Audouard, *Recueil de Mémoires sur le Typhus asiatique, ou Fièvre jaune*, Paris, 1825; John Simon, "On Filth Diseases," *Report of the Med. Officer of the Privy Council for 1874*; J. Hutchinson, *Clinical Memoirs . . . on inherited Syphilis, &c.*, Lond., 1863, and "Constitutional Syphilis," in Reynolds's *System of Medicine*, vol. I., 1866; Virchow, *Ueber die Natur der constitutionell-syphilitischen Affectionen*, Berlin, 1859, and in his *Krankhaften Geschwülste*, vol. II., chapter on "Granuloma"; Klebs, "U. ber die Entstehung der Tuberculose und ihre Verbreitung im Körper," *Virchow's Archiv*, vol. XLV., 1868; Cohnhelm, *Die Tuberculose voll Standpunkte der Infektionslehre*, Leipzig, 1880; Walley, *The Fever Disease Stomachs*, chapter on "Bovine Tuberculosis," Edin., 1879; Lydlin, "Die Ferussucht," in *Archiv für wissenschaft. und pract. Thierheilkunde for 1884* (Engl. ed. by Fleming); R. Koch, "Die Aetiologie der Tuberculose," *Berl. Klin. Wochenschrift*, April 1882.



certain toxic or poisonous substances mixed with the staple food of the people. Perhaps the best known of these is *gangrene caused by ergot of rye*. One form of the disease is characterized by acute pain and gangrenous destruction of the skin, the gangrene sometimes spreading to the deeper structures and to the bones, and leading to loss of the limbs. At times the mortality from this disease has been great. Numerous epidemics of it have occurred in France (rarely during the present century); in other parts of the continent of Europe (Sweden, Norway, Russia) the effects of ergotism have taken the form of a nervous (convulsive) disease called "Kriebelkrankheit." The effects are those due to ergot, the compact mycelium of *Claviceps purpurea*, produced within the paleæ of the common rye. This substance, well known in medicine, is accidentally ground with the rye, and produces gangrene by contracting the muscular coats of the arteries of the skin so as to seriously diminish the amount of blood sent to it, or it affects the nervous system. (See ERGOT.)

Another toxic effect closely allied to ergotism is the *pellagra* of Lombardy. (See PELLAĞRA.)

A third disease of the same kind is *acrodynia*, having a resemblance to ergotism on the one hand and to pellagra on the other. It appears to be somehow connected with bad grain, but the actual poison has not been traced, as in the case of ergot. The observations relating to it have been mostly made in France, and in the French army in Syria, in Algiers, and in Mexico. The succession of symptoms is somewhat complex, including disorders of the stomach and intestine, conjunctivitis, œdema of the face, disorders of sensibility and locomotion, and erythematous rashes, mostly on the hands and feet.

In Colombia (South America) a peculiar disease, characterized by the hair coming out (*pelade*), is traced to the ergot-parasite of maize.

In the prairie States of the American Union there is a disease of cattle (and sheep) called "*the trembles*," supposed to be due to some toxic substance in the pasturage. In the human subject in those localities there is a corresponding malady called "*the milk-sickness*," and suspected of being caused by partaking of the milk or flesh of cows which had been primarily affected.

Among toxic diseases we have to include also *lead colic*, or "dry belly-ache," to which workers in the various compounds of lead are liable, as well as communities here and there whose food or drink, in the course of its preparation or storage, has been contaminated by lead. Workers with *phosphorus*, also, are liable to necrosis of the lower jaw. More occasional effects are produced by some other chemical elements used in manufacture.

By far the most important toxic agent is *alcohol*, which is often sold in public-houses when it has all the powerfully injurious properties of new spirit in it. The enormous excise duty of 10s. per gallon is apt to make us forget the coarse and cheap nature of the alcohol often sold as whisky; this product of distillation may be purchased new from distilleries at as low a rate

as 1s. 6d. per gallon. The retelling of such new whisky is answerable for an amount of disease—to say nothing of violence and crime—which an equal quantity of mellowed spirit would by no means produce. There are some not uncommon forms of kidney-disease and of liver-disease which are, in the great majority of cases, the direct results of raw spirits. Both in the liver and the kidney the effect of such spirits is to cause an active growth of the supporting tissue of the organ at the expense of its proper metabolic or glandular tissue. In the case of the liver it causes cirrhosis or hobnailed liver, which is accompanied by abdominal dropsy; in the case of the kidney it causes a contracted condition, to which the name of cirrhosis is also applied, being one of the forms of Bright's disease. Besides these organs the stomach is apt to become affected by coarse spirits taken frequently; it falls into a state of chronic catarrh, on the basis of which cancer is apt to plant itself.

§ 18.—PARASITIC DISEASES.

Reference has been made to the occurrence of a spiral micro-organism in the blood in cases of relapsing fever, to the so-called "bacillus of tubercle," and to the occurrence of micrococci in erysipelas and infective inflammations. For the splenic fever and other anthracous diseases of the domestic animals, very conclusive experimental evidence has been brought forward by Pasteur and others that the virus somehow goes with or resides in the bacilli which are apt to swarm in the blood. These bacilli also occur in the malignant pustule and wool-sorters' disease of man,—forms of anthrax which are produced by handling the hides and fleeces of animals. In diphtheria and ulcerative endocarditis micrococci are abundant in the tissues of the affected localities. They are also described for malignant osteomyelitis, and a peculiar double form (*diplococcus*) has been discovered in pneumonia. The doctrine of infective parasitism is applied by some pathologists to the whole of the specific infective diseases, acute and chronic, as well as to malarial fevers, which are non-communicable. There can be no doubt of the occurrence of very various forms of micro-organisms in the tissues after death from diseases, specific and other, and in the blood and tissues during the course of some diseases, and even in states of fair health. It is premature to call all these bacteria "pathogenic." Their significance in morbid states of the body will be considered, along with their natural history, in the article SCHIZOMYCETES.

The animal parasites infesting the human body and the fungi concerned in some skin-diseases and in actinomycosis are treated of in the articles PARASITISM, NEMATODIDA, and TAPEWORM. (c. c.)

INDEX

Addison's disease, 384.  
Adenoma, 379.  
Ætiology, 361.  
Age paroxysm, 304.  
Agnes, periodicity of, 305.  
Albuminuria, 357.  
Alcoholism, 407.  
Angioma, 379.  
Atrophy, acute yellow, 386.  
Bacillus, 407.  
Bacteria, 401.  
Blood-making, 378.  
Bright's disease, 387.  
Calm, 307.  
Cancer, 383.  
Cancer, colloid, 383.  
Catarrh, 377.  
Chloroma, 375.  
Chorea, 361, 366.  
Cicatrix, 366.  
Convulsions, 361.  
Crelinism, 375, 365.  
Degenerations, 360.  
Dermoid cysts, 372.  
Diabetes, 368.  
"Dissolution principle" in nervous diseases, 363.  
Dropsy, 353.  
Dysentery, 366.  
Emigration of blood-corpuscles, 366.

Encephaloma, 370.  
Epilepsy, 361.  
Erythema, 368.  
Erytheloma, 382.  
Erysipelas, 368.  
Erythrasma, contagious, 404.  
Fever, 364.  
" malarial, 364.  
" relapsing, 408.  
" rheumatic, 367.  
" spirillum, 403.  
" thermic, 364.  
Fibroma, 368.  
" ossifying, 368.  
Giant-cells, 366, 372.  
Gout, 364.  
Gout, 363.  
Granulations, 368.  
Graves's disease, 385.  
Hamatoblasta, 365.  
Hemorrhilia, 375.  
Hairs in dermoids, 372.  
Herpes in fertile stacks, 366.  
Infections, endogenous, 403.  
" exogenous, 403.  
" ricarcous, 403.  
Infectiveness, 401.  
Inflammation, 368.  
Leucocytosis, 376.  
Leukæmia, 376.  
Lipoma, 366.

Locomotor ataxia, 369.  
Melanosis, 402.  
" of horns, 402.  
Myxodema, 364.  
Myxoma, 366.  
Nerve-repair, 367.  
Neuralgia, 366.  
Obesity, 380.  
Obsolescence, 383.  
Osteomalacia, 375.  
Pain in rheumatic fever, 367.  
Parasitic diseases, 407.  
Pernicious anemia, 377.  
Phlegmon, 366.  
Phosphorus poisoning, 366.  
Placental function in congenital diseases, 374.  
Pneumonia, 366.  
Polypt (mucous), 370.  
Progressive muscular atrophy, 362.  
Pseudo-hypertrophic paralysis, 362.  
Pus, 365.  
Pyæmia, 401.  
Repair, 363.  
Rickets, 373.  
Rigors, 365.  
Sarcoma, 368.  
" cystic, 369.  
Scar, 366.  
Schizomyces, 406, 407.

Scrofula, 406.  
Septicæmia, 401.  
Skin in dermoid cyst, 371.  
" of nose, 366.  
Species of disease, 403.  
Simpson on, 403.  
Spiral cord, degenerations of, 362.  
Suppuration, 366, 400.  
Syphilis, 404.  
Tendon-repair, 364.  
Tetanus, 361.  
Thrombosis, 401.  
Thyroid, secondary tumours of, 388.  
Toxic diseases, 404.  
Tropical abscess, 366.  
Tubercle, 405.  
" bovine, 406.  
Tumour-infection, 402.  
Tumours, 367.  
" cavernous, 370.  
" embryological principle in, 367.  
" fibro-cellular, 368.  
" glandular, 371.  
" myeloid, 373.  
" osteoid, 371.  
Typhoid, 408.  
Typhus fever, de novo origin of, 408.  
Uratic diathesis, 383.  
Warts, 378.

**PATIALA**, one of the cis-Sutlej states, Punjab, India, lying between 29° 23' 15" and 30° 54' N. lat., and between 74° 40' 30" and 76° 59' 15" E. long., has an area of 5887 square miles, and a population (1881) of 1,467,433. The estimated gross revenue is £471,624. The larger portion of the state is situated in the plain south of the Sutlej, while the other is hill country stretching up to Simla, which formerly belonged to Patiala. The usual cereals form the principal agricultural products. The ruling family are Sikhs of the Sidhu Ját tribe.

**PATMOS** (now pronounced by the natives "Patino"), an island in the east of the Ægean Sea, one of the group of the Sporades, about 28 miles south-south-west of Samos. It lies in 37° 20' N. lat and 26° 35' E. long. Its greatest length from north to south is about 10 miles, its greatest breadth 6, its circumference, owing to the winding nature of the coast, about 37. The island, which is volcanic, is bare and rocky throughout; the hills, of which the highest rises to about 950 feet, command magnificent views of the neighbouring sea and islands. The woods which once covered the island have disappeared; of the palms, from which it formerly received its Italian name of Palmessa, not more than one is left. Some poor olive trees and a few specimens of the mulberry, the fig, the orange, the lemon, the carob, the cypress, the oak, and the pine here and there refresh by their verdure an eye wearied by the prospect of barren mountains, only relieved in places by scrubby bushes or clumps of thyme. The skill of the natives as seamen is proverbial in the archipelago. The deeply-indented coast, here falling in huge cliffs sheer into the sea, there retiring to form a beach and a harbour, is favourable to commerce, as in former times it was to piracy. Of the numerous bays and harbours the chief is that of La Scala, which, running far into the land on the eastern side, divides the island into two nearly equal portions, a northern and a southern. A narrow isthmus separates La Scala from the Bay of Merika on the west coast. On the belt of land between the two bays, at the junction between the northern and southern half of the island, stood the ancient town. To judge from its traces, it may have contained 12,000 to 13,000 inhabitants. On the hill above are still to be seen the massive remains of the citadel, built partly in the polygonal style known as Cyclopean. The modern town stands on a hill-top in the southern half of the island. A steep paved road leads to it in about twenty minutes from the port of La Scala. The town clusters at the foot of the monastery of St John, which, crowning the hill with its towers and battlements, resembles a fortress rather than a monastery. Of the 600 MSS. once possessed by the library of the monastery only 240 are left, badly preserved, and none of them of value. The houses of the town are better built than those of the neighbouring islands, but the streets are narrow and winding. The population is about 4000. The port of La Scala contains about 140 houses, besides some old well-built magazines and some potteries. Scattered over the island are about 300 chapels.

Patmos is mentioned first by Thucydides (iii. 83) and afterwards by Strabo and Pliny. From an inscription it has been inferred that the name was originally Patmos. There are some grounds for the conjecture that the island was first colonized by Carians. Another ancient inscription seems to show that the Ionians also settled there at an early date. The chief, indeed the only, title of the island to fame is that it was the place of banishment of St John the Evangelist, who according to Jerome (*De Scr. Ill.*, c. 9) and others, was exiled thither under Domitian in 95 A.D., and released about eighteen months afterwards under Nerva. Here he is said to have written the Apocalypse; to the left of the road from La Scala to the town, about half-way up the hill, a grotto is still shown (τὸ σπηλαίον τῆς Ἀποκαλύψεως) in which the apostle is said to have received the heavenly vision. It is reached through a small chapel dedicated to St Anne. In the library of the monastery there is a Greek MS. containing a curious history of St John, purporting to be by Pro-

chorus, one of his disciples but apparently composed in the 4th century. It narrates the miracles wrought by the apostle during his stay on the island, but, strangely enough, while describing how the Gospel was revealed to him in Patmos, it does not so much as mention the Apocalypse. During the Dark Ages Patmos seems to have been entirely deserted, probably on account of the pirates. In 1088 the emperor Alexis Comnenus, by a golden bull, which is still preserved, granted the island to St Christodulus for the purpose of founding a monastery. This was the origin of the monastery of St John, which now owns the greater part of the southern half of Patmos, as well as farms in Crete, Samos, and other neighbouring islands. The embalmed body of the saintly founder is to be seen to this day in a side chapel of the church. The number of the monks, which amounted to over a hundred at the beginning of last century, is now much reduced. The abbot (*ἡγούμενος*) has the rank of a bishop, and is subject only to the patriarch of Constantinople. There is a school in connexion with the monastery which formerly enjoyed a high reputation in the Levant. The lay population was originally confined by St Christodulus to the northern part of the island, but at the beginning of the 13th century the people received permission to build their houses near the monastery for protection against the pirates. Hence arose the modern town. It was recruited by refugees from Constantinople in 1453, and from Crete in 1669, when these places fell into the hands of the Turks. The trade of the island seems to have been considerable. It was in intercourse with Genoa and Venice that the port received its modern name of La Scala; its ancient name seems to have been Phora. The island is subject to Turkey; the governor is the pasha of Rhodes. The population is Greek. The women, who are handsome, are chiefly engaged in knitting cotton stockings, which, along with some pottery, form the chief exports of the island.

See Tournefort, *Relation d'un Voyage en Levant*, Lyons, 1717; Walpole, *Memoirs* (relating to Turkey), London, 1830; Ross, *Reisen auf den griechischen Inseln*, Stuttgart and Halle, 1840-52; and especially Guérin, *Description de l'île de Patmos*, Paris, 1855.

**PATNA**, a district in the lieutenant-governorship of Bengal, and in the division or commissionerahip of Patna,<sup>1</sup> lying between 24° 58' and 25° 42' N. lat., and between 84° 44' and 86° 5' E. long., is bounded on the N. by the river Ganges, which separates it from Saran, Muzaffarpur, and Darbhanga, on the E. by Monghyr, on the S. by Gaya, and on the W. by the Son, which separates it from Sháhábád. Patna district, with an area (1881) of 2079 square miles, is, throughout the greater part of its extent, a level plain; but towards the south the ground rises into hills. The soil is for the most part alluvial, and the country along the bank of the Ganges is peculiarly fertile. The general line of drainage is from west to east; and high ground along the south of the Ganges forces back the rivers flowing from the district of Gaya. The result is that, during the rains, nearly the whole interior of the district south of a line drawn parallel to the Ganges, and 4 or 5 miles from its bank, is flooded. There are no forests or jungles of any extent, but fine groups of trees are found in many places. In the south-east are the Rájágrhá Hills, consisting of two parallel ridges running south-west, with a narrow valley between, intersected by ravines and passes. These hills, which seldom exceed 1000 feet in height, are rocky and clothed with thick low jungle, and contain some of the earliest memorials of Indian Buddhism. Hot springs are common on the Rájágrhá Hills. The chief rivers are the Ganges and the Son. The total length of the former along the boundary of Patna is 93 miles. The Son first touches the district near Mahábalipur village, and flows in a northerly direction for 41 miles, till it joins the Ganges. The only other river of any consequence is the Púnpún, which is chiefly remarkable for the number of petty irrigation canals which it supplies. So much of the river is thus diverted that only a small portion of its water ever reaches the Ganges at Patná. Great changes have from time to time taken place in the course of the Ganges, and the point at which the Son

<sup>1</sup> The division of Patna lies between 24° 17' 15" and 27° 29' 45" N. lat., and between 83° 23' and 86° 46' E. long., and comprises the districts of Patna, Gaya, Sháhábád, Darbhanga, Muzaffarpur, Saran, and Champaran. The area (1881) was 23,647 square miles, and the population 16,068,944, viz., Hindus 13,827,723, Mohammedans 1,730,093, Christians 5875, and "others" 248.

joined this river was once several miles east of its present position. Large game is not abundant except on the Rājāgrhā Hills, where bears, wolves, and jackals are common, and hyenas are sometimes seen. Of smaller game, duck, quail, and ortolan are abundant, and partridges and wild geese are also found.

The census of 1881 returned the population at 1,756,856 persons (males 858,783, and females 898,073). Hindus numbered 1,541,061, Mohammedans 213,141, Christians 2588, and "others" 66. Of high-caste Hindus there are 47,041 Brāhmins and 64,332 Rājputs. Ranking next to these two castes are the Bābhans, a class who number 121,381 in Patna district, and whose origin is much disputed. They assert themselves to be Sarwariā Brāhmins, but, although they are held in high respect, this rank is not generally accorded to them. Among the Sūdras the most numerous are the Goḍiās or Ahīrs, the great herdsmen class, of whom there are 217,845; and the Kurmiā, an agricultural caste, who number 194,222. Among the semi-Hinduized aboriginal tribes the Dośādhā, the ordinary labouring class of Behar, number 99,976. The Wahābīs form the most interesting section of the Mohammedan community. They are a numerous body, and include several wealthy traders, though the majority belong to the lower classes. The following towns in the district contained a population in 1881 exceeding 10,000—Patna city (170,654); Behar (48,968); Dināpur, including the cantonment (37,893); Bārḥ (14,689); Khagaul (14,075); Mukāma (13,052); Patwā (10,919).

Rice, which forms the staple of the district, is divided into two great crops—the *karrīk* or early rice, sown in June or July and reaped in October or November; and the *aghānt* or winter rice, sown after the commencement of the rains and cut in November or December. The *toro* or spring rice is also cultivated to a limited extent, being sown in November or December and reaped in April or May. By far the most important of these is the *aghānt* crop, of which forty-six varieties are named. Among the other principal crops are wheat and barley, *khedārt*, gram, pease, cotton, tobacco, sugar-cane, a little indigo and mustard, several other oil-producing plants, and poppy. All the poppy grown in the province of Behar is manufactured at Patna city.

Patna is subject to blights, floods, and drought, but seldom to such an extent as to seriously interfere with the general harvest. There are abundant facilities for importations of grain in case of distress. The trade of the district centres in Patna city, which, next to Calcutta, is the largest river-mart in Bengal. The total length of district and provincial roads is 454 miles. The East Indian Railway traverses the entire length of the district for 86 miles. Several newspapers are published at Patna, the most important being the *Behar Herald*, published weekly and conducted by the native pleaders of the Patna bar.

Patna is one of the two places in British India where opium is manufactured. The poppy cultivated is exclusively the white variety (*Papaver somniferum album*), and the crop requires great attention. The amount of produce from various lands differs considerably. Under favourable circumstances of soil and season, the out-turn per acre may be as high as 41 lb of standard opium (*i.e.*, containing 70 per cent of pure opium and 30 per cent of water), paid for by the Government at the rate of 5s. per lb; but the average is from 21 to 27 lb per acre. The opium is made up into cakes weighing about 4 lb, and containing about 3 lb of standard opium. These cakes are packed in chests (forty in each), and sent to Calcutta for exportation to China. The price which they fetch varies every year; the average rate per chest in 1880-81 was about £185 and the cost £39.

The net revenue of Patna in 1882-83 amounted to £278,550, of which £147,205 was derived from the land-tax. In 1874-75 there were, exclusive of the Patna college, 809 Government and aided schools with 9003 pupils; by 1877-78 the number had risen to 816, and the pupils to 16,596. The Patna college was founded in 1862, and is the only institution for superior instruction in Behar; the total number of pupils in 1881-82 was 166. The climate of Patna is considered remarkably healthy. The average annual rainfall is 35-66 inches.

PATNA, chief city of the above district, is situated in 25° 37' 15" N. lat. and 85° 12' 31" E. long., on the right or south bank of the Ganges, and adjoining Bānkīpur, the civil station and administrative headquarters of the district. Its central position at the junction of three great rivers, the Son, the Gandak, and the Ganges, where the traffic of the North-Western Provinces meets that of Bengal, gives it great natural advantages. The city proper comprises the large business quarters of Mārūganj, Mānsūrganj, the Kilā or fort, the Chauk, with Mirchaiganj, Mahārāiganj, Sādīkpur, Alābakhpur, Gulzārbāgh, Colonel-

ganj, and other petty bazaars extending westwards as far as Bānkīpur civil station. According to the census of 1881 its population was 170,654—Hindus 127,076, Mohammedans 43,086, "others" 492.

*History.*—Patna city has been identified with Pātaliputra (the Palibothra of Megasthenes, who came as ambassador from Seleucus Nicator to Chandragupta about 300 a.c.). Megasthenes describes Palibothra as being the capital city of India. He adds that its length was 80 stadia, and breadth 15, that it was surrounded by a ditch 30 cubits deep, and that the walls were adorned with 570 towers and 64 gates. According to this account the circumference of the city would be 190 stadia or 25½ miles. When Hwen Tsang visited the place in 637 A.D. the kingdom of Magadha was subject to the rule of Kanauj. The old city had then been deserted for a long time, and was in ruins, although a new Pātaliputra had sprung up close to it. In the south-east of Patna district, in the Rājāgrhā Hills, are found some of the earliest remains of Indian Buddhism. During the early years of Mohammedan rule the governor of the province resided at Behar town in the south-east of the district. During Sher Shah's revolt against the Mughals, Patna became the capital of an independent state, which was afterwards reduced to subjection by Akbar. The two events in the modern history of the district are the massacre of Patna (1763) and the Sepoy Mutiny in 1857. The former occurrence, which may be said to have settled the fate of Mohammedan rule in Bengal, was the result of a quarrel between the nawāb, Mīr Kāsim, and the English authorities regarding transit duties, which ultimately led to open hostilities. The company's sepoys, who had occupied Patna city by the orders of the company's factor, were driven out by the nawāb's troops and nearly all killed. The remainder afterwards surrendered, and were put into confinement, together with the European officers and the entire staff of the Kāsimbāzār factory, who had also been arrested on the first outbreak of hostilities. Mīr Kāsim was defeated in two pitched battles at Gheriā and Udhanāsi (Oodleynullah) in August and September 1763, and in revenge ordered the massacre of the whole of his prisoners, which was carried out with the help of a Swiss renegade in his employment, named Walter Reinhardt (afterwards the husband of the famous Begam Samru). About sixty English prisoners were murdered on this occasion, the bodies being thrown into a well belonging to the house in which they were confined.

At the outbreak of the mutiny in May 1857 the three sepoy regiments stationed at Dināpur (the military cantonment of Patna, adjoining the city) were allowed to retain their arms till July, when, on an attempt being made to disarm them, they broke into open revolt. Although many who attempted to cross the Ganges in boats were fired into and run down by a pursuing steamer, the majority crossed by the Son river into Shāhābād, where they joined the rebels under Kuar Sinh, who were then besieging a small European community at Arrah.

PATNA, a native state in the Central Provinces of India, lying between 20° 5' and 21° N. lat., and between 82° 45' and 83° 40' E. long., has an estimated area of 2399 square miles, of which 550 are under cultivation, and other 950 are returned as cultivable. The country is an undulating plain, rugged and isolated, with ridges of hills crossing it here and there, and shut in on the north by a lofty irregular range. Rice forms the staple produce, but pulses, oil-seeds, sugar-cane, and cotton are also grown. A vast forest extends for 30 miles around Pātna village containing valuable large timber, but infested by tigers, leopards, and other wild animals. Iron ore exists in many parts of the state, but no mines are regularly worked. The only means of communication are a few bullock or pony tracks. The estimated population in 1881 was 257,959, nearly all of whom were Hindus. Patna was formerly the most important of the cluster of chiefships known as the *Athāra Garhāt* (The Eighteen Forts), but under its later rulers it greatly declined. Since 1871, however, when it was taken under direct British management, it has gradually been regaining prosperity.

PATRAS, or PATRÆ (Ital. *Patrasso*, Turkish *Balia-badra*), a fortified city of Greece, the principal port of the Morea, and the chief town of the nomos of Achaia and Elis, lies on the north coast of the Morea on the east side of the Gulf of Patras, which opens into the Gulf of Corinth by the Little Dardanelles, marked by forts Kastro Moreas and Kastro Rumelias. Since the War of Independence Patras has been one of the most prosperous cities in the

kingdom; the quarters of the new town are well laid out; its old harbour being considered hardly safe in winter, a new harbour defended by a breakwater was commenced in 1880; new roads (to Kalavryta; for example) are opening up communication with the interior; a railway to connect the city with Corinth and Athens is in process of construction (1884); and the proposed cutting of the canal across the isthmus of Corinth would add new elements to its commerce. The population, which had sunk to 8000 at the time of the war, was 16,641 in 1870, and 24,993 in 1879. Patras is the seat of one of the four courts of appeal in the kingdom, and the residence of the archbishop of Patras and Elis. The custom-house is the most important in all Greece. Like the ancient city, the modern Patras previous to the revolution occupied the high ground of *Scotovani* (a hill connected with Mount *Voidia* or *Panachalium*, the dominant summit in this region), but since then it has spread out over the plain towards the sea. The two most interesting buildings are the castle, a mediæval structure on the site of the ancient acropolis, and the cathedral of St Andrew, which is highly popular as the reputed burial-place of the saint, and has been rebuilt since the revolution. The commerce of Patras consists mainly in the export of currants, valonia, olive-oil, wine, and sheepskins (value in 1881, 19,369,270 francs, of which 18,104,046 francs were for currants alone), and the import of cotton and woollen goods, grain, flour, and colonial wares (value in 1881, 16,560,600 francs). Great Britain and Austria almost divide the foreign shipping trade, with a preponderance in favour of the former country, which takes more than half of the currants. August and September are the months when the port is at its busiest with British vessels. Famous even in antiquity for its flask manufactures (whence the number of females in the city was double that of the males), Patras at present contains several steam factories with about 4000 spindles producing coarse cotton twist from cotton grown in northern Greece; and there are also sulphur-crushing mills, flour and macaroni mills, and an iron-foundry. Gas-works and water-works were constructed about 1874.

The foundation of Patras goes back to prehistoric times, the legendary account being that *Eumelus*, having been taught by *Tripolemus* how to grow grain in the rich soil of the *Glaucus* valley, established three townships, *Aroe* (i.e., ploughland), *Anthelia* (the bowery), and *Mesatis* (the middle settlement), which were united by the common worship of *Artemis Triclaris* at her shrine on the river *Melichus*. The Achæans having strengthened and enlarged *Aroe* called it Patras as the exclusive residence of the ruling families. In 419 B.C. the town was, by the advice of *Alcibiades*, connected with its harbour by long walls in imitation of those at Athens. The whole armed force of Patras was destroyed by *Metellus* after the defeat of the Achæans at *Scarpheia*, and many of the remaining inhabitants forsook the city; but after the battle of *Actium* *Augustus* restored the ancient name *Aroe*, introduced a military colony of veterans from the 10th and 12th legions (not, as is usually said, the 23d), and bestowed the rights of coloni on the inhabitants of *Rhynus* and *Dyme*, and all the *Loeri Ooalis* except those of *Amphissa*. *Colonia Augusta Aroe Patrensis* became one of the most populous of all the towns of Greece; its colonial cognage extends from *Augustus* to *Gordian III.* That it was the scene of the martyrdom of St Andrew is purely apocryphal, but, like Corinth, it was an early and effective centre of Christianity; its archbishop is mentioned in the lists of the council of *Sardica* in 347. In 551 Patras was laid in ruins by an earthquake. In 807 it was able without external assistance to defeat the Slavonians (*Avars*), though most of the credit of the victory was assigned to St Andrew, whose church was enriched by the imperial share of the spoils, and whose archbishop was made superior of the bishops of *Methone*, *Laodæmon*, and *Corona*. Captured in 1506 by *William of Champlitte* and *Villaherdonia*, the city became the capital and its archbishop the primate of the principality of Achæia. In 1587 *De Heredia*, grand-master of the order of the Hospital at *Rhodes*, endeavoured to make himself master of Achæia, and took Patras by storm. At the close of the 15th century the city was governed by the archbishop in name of the pope; but in 1428 *Constantine*, son of *John VI.*, managed to get possession of it for a time. Taken by a Spanish fleet under *Andrea Doria* in 1588, sacked by another

Spanish fleet in 1596, and again sacked by the knights of Malta in 1603, Patras was at length in 1687 surrendered to the Turks to the Venetians, who made it the seat of one of the seven fiscal boards into which they divided the Morea. It was at Patras that the Greek revolution began in 1821; but the Turks, confined to the citadel, held out till 1828, when the French troops took possession of the Morea.

See *C. I. L.*, vol. III. 1; *Bursian*, *Geogr. von Griechenland* and *Finlay's Hist. of Greece*.

**PATRIARCH** (*πατριάρχης*, lit. the head or ruler of a *πατριά*, tribe, family, or clan) occurs four times in the New Testament, being applied to Abraham, the twelve sons of Jacob collectively, and David, and several times in the LXX., where the word is used to denote the officials called by the chronicler "princes of the tribes of Israel," "princes of hundreds," "chiefs of the fathers." Under the late Roman empire the title was officially applied down to the 5th century to the chief rabbi in Palestine (see *Cod. Theod.*, xvi. 8, 1; and comp. *ISRAEL*, vol. xiii. p. 428); the head of the synagogue at Babylon appears also to have been known as patriarch until 1038. The title at an early date passed over into the Christian church as an honorific though not official designation of all bishops; thus *Gregory of Nyssa* (*Or. Fm. in Mel.*) alludes to the fathers assembled in council at Constantinople as "these patriarchs." Afterwards the Easterns showed a tendency to limit the appellation to the occupants of the more important sees, just as in the West the so-called "metropolitans" began to receive more definite recognition. At the present day the heads of the various extant churches and sects in the East are very commonly called patriarchs (see vol. xi. p. 151 sq.), and in the West the Roman Church gives the honorary title to several dignitaries, such as the archbishops of Lisbon and Venice. In a strictly technical sense, however, that church recognizes only five patriarchates, those of Constantinople, Alexandria, Jerusalem, Antioch, and Rome. This peculiar restriction of the word, which may be said to date from the council of Chalcedon in 451, can be traced downwards from the time of Constantine when the altered political circumstances and the civil division of the empire into four prefectures (*Oriens*, *Illyrici Orientalis*, *Italia*, *Galliarum*), each containing a number of "dioceses," gave a new importance to questions of ecclesiastical jurisdiction. Thus the council of Nice (can. 6) adjusted the jurisdiction of the "bishop" of Alexandria so as to include *Libya* and *Pentapolis* as well as Egypt, the ancient rights of Rome, Antioch, and the other "eparchies" being at the same time conserved. The third canon of the council of Constantinople assigned precedence to the "bishop" of Constantinople immediately after the "bishop" of Rome; and by the 28th of Chalcedon the "metropolitans" of Thrace, Pontus, and Asia were appointed to receive their consecration at his hands. The same council invested the bishop of Jerusalem, formerly under the jurisdiction of the metropolitan of Antioch, with supremacy over the whole of Palestine. Thenceforward a certain co-ordinate primacy was thus accorded to Rome, Constantinople, Antioch, Alexandria, and Jerusalem; but it is to be observed that in no official document belonging to this period is the title "patriarch" given to the bishop of any one of these sees, though the word "eparch" or "exarch" is occasionally employed. We find *Theodosius*, however, so designating the bishop of Rome, and not only is it given to the bishop of Constantinople in the *Nosellæ* of *Justinian*, but we find *Menas* in 526 claiming to be called *ὁ ἐκκοινωνησάντων πατριάρχης*, not, of course, without violent protest in the West. After the fall of Jerusalem (637), Antioch (638), and Alexandria (640) into the hands of the Saracens, the importance of these sees became of course nominal merely, and it grew easier for Rome, at the head of the unbroken Western church, to give practical expression to its claims of super-

erity over its sole surviving Eastern rival. Finding it difficult, however, to avoid the appearance of equality that was involved in the name of "patriarch," now conventionally bestowed on the occupants of other ancient and apostolic sees, the bishops of Rome rather avoided the title, preferring the more colourless designation of papa or pope (see POPK).

**PATRICIAN.** The history, in the Roman state, of the hereditary patrician order (*patricii, patres*, house-fathers, goodmen) who originally constituted the entire *populus Romanus* has been traced in the article **NOBILITY** (vol. xvii. pp. 525-6). With the transference of the imperial capital to Byzantium under Constantine, the title *patricius* became a personal and not an hereditary distinction; the name was held to denote a fatherly relation to the emperor, and those who bore it stood first among the *illustres*, receiving such appellations as "magnificentia," "celsitudo," "eminentia," "magnitudo." High civil and military offices was usually conferred on them, and they were frequently sent into the provinces as viceroys. After the overthrow of Romulus Augustulus in the West, Odoacer claimed and, practically at least, received from the emperor Zeno the title of "patricius," in virtue of which he governed Italy. It was similarly assumed by other barbarian conquerors. In 754 it was conferred by Pope Stephen on Pippin the Short, and it was afterwards borne by Charlemagne. It was as patrician of Rome that the emperor Henry IV. claimed the right to depose Pope Gregory VII. The title was abolished by Pope Eugenius III. in 1145.

**PATRICK, St.** In one of the incursions of the Scots and Picts upon the neighbouring Roman province south of the wall of Severus, probably that of 411 A.D., the year after Honorius had refused aid to the Britons, a youth of about fifteen was carried off with many others from the district in the neighbourhood of the wall at the head of the Solway, and sold as a slave on the opposite coast of Ireland in the territory of the Irish Picts called Dal Araide.<sup>1</sup> This youth was the future apostle of the Irish. As his name implies, he was of noble birth, and he tells us so himself. He was the son of the deacon Calpurnius, who was the son of Potitus, a priest. His father was a decurio or magistrate, and, as Patrick according to tradition was born at Nemthur,<sup>2</sup> he must have exercised his functions of magistrate at that place, but on the withdrawal of the Roman garrisons from Britain probably

<sup>1</sup> The province of Valentia, reorganized by Theodosius I., was comprised between the wall of Antoninus, which extended from the Clyde to the Firth of Forth, and the wall of Severus, which extended from the Solway to Tynemouth. Although the destruction of the pagan temples was decreed in 381, and the pagan religion prohibited in 390, that is, a few years after the restoration of Roman power in Britain and the reorganization of this province by Theodosius, the greater part of the Romanized population of Britain seems to have been pagan at the end of the 4th century, and especially in Valentia, where Patrick was born about 396. Amidst the many evidences of Roman occupation that have been found there not a relic of Roman Christianity has, so far as we know, been yet discovered. In the south-west part of Valentia, along the north shore of the Solway Firth from the Nith to the Irish Channel, Ptolemy placed the tribe of the Novantes, its principal dan or oppidum being on the west side of Wigtown Bay, and called by him *Leukopibia*, a name still preserved in Whithorn. During the great displacements of tribes consequent upon the Roman conquests and the incursions of the Scots and Picts, the British Novantes disappear, and in their place we find at the end of the 4th century Goidelic Cruithni or Picts. Their position in the midst of a British population, and their contiguity to the part of Ulster occupied by the Irish Cruithni or Picts, clearly indicate that the Picts of Galloway were part of the Ullidian or Irish Picts pressed out of Ireland by the intrusion of the Scots. This settlement of the Irish Picts in Galloway afforded an excellent vantage-ground for such attacks as that spoken of in the text.

<sup>2</sup> There can be no doubt that Nemthur was situated at the Clyde end of the wall of Antoninus, where Dumbarton now is. It is called *Nevtur* in the Old Welsh MS. known as the "Black Book of Carmarthen."

retired for safety south of the wall of Severus, where, as Patrick tells us, he had a small country place (*villula*) near the town (*vicus*) of Bannavem Tabernia, whence Patrick was carried off. The country along the south of the wall, especially near the Solway, was a region of camps or military posts to which the designation Tabernia would be appropriate. Bannavem seems to be a Romanized form of a British name signifying "river foot," and most probably was the Banna of the *Chorography* of Ravenna, and of the inscription on an altar said to have been found at Birdoswald (the Romano-British Amboglanna), and now at Lanercost Priory. The name also occurs on the well-known bronze cup found about two hundred years ago at Rudge in Wiltshire, which dates from about 350. Banna must have been near Petriana, the former being probably the vicus or town, and the latter the military station proper. Towards the end of the 4th century, before the withdrawal of the Roman garrisons, there were along the wall 10,300 foot and 1500 horse according to the *Notitia Imperii*, so that Bannavem Tabernia, or Bannavem of the military posts or encampments, was descriptive of the district, and the office of decurio in such a place one of considerable dignity.

The youth Succat or Patrick remained in hard slavery for six years, tending cattle, probably on Slemiah Mountain in the county Antrim. He seems to have been of an enthusiastic temperament, and much given to prayer and meditation. Learning of a means of escape, it so filled his mind as to give rise to visions. The bays and creeks of the west and north-west of Ireland, especially Killala Bay, were much frequented in ancient times, for they afforded secure retreats to sea-rovers when they crept round the coast of Ireland and swooped down on that of Roman Britain. Ptolemy's town of Nagnata was probably on the bay just named; it is celebrated in the stories of Fomorians, Norsemen, and other sea-rovers. The kindred of the Ard Ri or paramount king of Ireland of the time, Dathi or rather Athi, one of the greatest leaders among the invading Scots, dwelt there; it was consequently a place which offered facilities for going to Britain, and from that place most probably Patrick succeeded in escaping. After his escape he appears to have conceived the noble idea of devoting himself to the conversion of the Irish, and to have gone somewhere for a few years to prepare himself for the priesthood. His biographers take him to Tours to St Martin, who was then dead several years, afterwards to the island of Lerins in the Mediterranean, and lastly to Rome, where he received a mission from Pope Celestine. For all this there is no evidence whatever, the whole story being the result of the confusion of Palladius with the real Patrick. The tradition of some connexion between the Irish apostle and St Martin of Tours, the monastic type of the earliest Irish Church, the doubts as to Patrick's fitness for the work which led to his writing his *Confession*, and indeed all the difficulties that beset the question of the origin of the Irish Church, receive a simple and satisfactory explanation upon the hypothesis of Patrick having prepared himself for the priesthood at *Candida Casa*, the monastic institution founded by St NINIAN (*q.v.*).

Patrick tells us that after a few years (*i.e.*, after his escape) he was among the Britons with his kindred, who received him as a son. He was evidently bent upon his mission, for they besought him after such tribulations not to part from them again. Full of it, he dreams that a man whose name was Victorius came to him bearing innumerable epistles, one of which he received and read; the beginning of it contained the words, "The voice of the Irish"; whilst repeating these words he says, "I imagined that I heard in my mind (in mente) the voice of those who were near the wood of Fochlad, which is near

the western sea, and thus they cried: We pray thee, holy youth, to come and henceforward walk amongst us." The word here referred to, which was in the neighbourhood of Killala Bay, was most probably the place where he remained concealed when waiting for a boat to make his escape from slavery. This dream was followed by others, which shows how completely his mission occupied his mind. Patrick was about twenty-two years of age when he escaped from slavery, and, if we allow seven or eight years for the "few years'" preparation, he probably was not more than thirty years of age when he entered on his mission about 425. There is a passage in his *Confession* which shows that he was still a young man when he commenced his work: "You know and God knows how I have lived among you from my youth up." Probus, the author of the fifth life published by Colgan, who has many claims upon our confidence, supports this view that Patrick began his mission while still a priest. We see in Patrick's own authentic acts that he must have sought among his friends in Britain to be made a bishop, for he complains in his *Confession* that a friend to whom he had communicated some fault he had committed when about fifteen years old had urged this thirty years after as a reason against his being consecrated to the higher office. This proves that he was only about forty-five years old when made bishop. If we assume that 411 was the year he was carried off as a slave, his consecration as bishop would fall in about 441, the fifteenth year of his mission, a date which corresponds with the results of Dr Todd's speculations based on a close analysis of all available chronological data. Compare in general on the conversion of Ireland what has been said in vol. xiii. p. 247 *sq.*

The date of St Patrick's death is as uncertain as that of every other event connected with him. The *Annals of the Four Masters* give 493, with which Ussher agrees; Tirechan's *Annations*, on the other hand, state that Loegaire, son of Niall, king of Ireland, lived from two to five years after St Patrick. According to this account the death of St Patrick took place in 469, and that of Loegaire in 471 or 474, after a reign of thirty-six years, so that Loegaire's reign began either in 435 or 438. The *Annals of the Four Masters* record the death in 457 of Senn Patraic, or Old Patrick, and of Loegaire in the following year, 458. The Patrick who died in 493 is a fiction due to the fusion of the acts of the two real Patricks, Palladius Patrick and Senn Patraic, doubtless so called because he was the Patrick known as a priest before the arrival of the Roman bishop. Assuming Tirechan's statement as correct, and that St Patrick died in 469, his mission as priest and bishop lasted about forty-four years.

The materials for a life of the apostle of Ireland are very scanty; they consist indeed of only two Latin pieces—one the so-called *Confession* and the other an *Epistle*—about a certain Coroticus. Some persons, apparently in Britain or Gaul, seem to have accused Patrick of presumption in having undertaken so great a work as the Christianizing of Ireland, and of incapacity for the task; the *Confession* is a defence of himself against these charges, and is a kind of autobiographical sketch. The *Epistle* is a denunciation of a British chief called Coroticus, supposed to be Caredig or Ceredig, son of Cynedda, conqueror of North Wales, who had ravaged the coast of Ireland, killed a number of Christian neophytes on the very day of their baptism while still clad in white garments, carried off others into slavery, and scoffed at a deputation of clergy Patrick had sent to ask their release. There is a copy of the *Confession* in the MS. called the "Book of Armagh," written about the year 807, and apparently made from Patrick's autograph, which the scribe several times complains of being then obscure. There are copies in other MSS. which contain nearly as much additional matter not in the "Book of Armagh" as would, if put together, be nearly equal to the text of the MS. just named. Are these additions part of the original work of Patrick omitted by the scribe because they were illegible, or for some other reason, or are they interpolations? Judging by many examples in other Irish MSS., the former appears to be the better interpretation, for they are written in the same

rude and archaic style, exhibit the same peculiarity of grammatical construction somewhat like Irish, and are not inconsistent with the rest. He modestly tells us himself that he is unlearned (indoctus), and very rustic (rusticissimus). The *Epistle* is not in the "Book of Armagh," but both pieces possess all the characteristics of the time and place, and may be regarded as genuine documents, and have been so regarded by nearly all scholars who have written on the subject.

There are also several old lives of the saint, seven of which have been published by Colgan in his *Trias Thaumaturga*, the last of which, known as the Tripartite life, is the most copious. These lives are based upon the two genuine documents above mentioned, and are a tissue of legends and miracles, and, though no doubt containing a few genuine traditions, are only of value for manners and customs, and even for this purpose require much care in their use.

The place, time, and circumstances of Patrick's labours have largely contributed to the obscurity which surrounds him. His very name has helped to increase it. Patricius, like Augustus, seems to have been commonly used, even down to the 7th century, in the sense of nobleman or gentleman; thus Dynamius, who lived in the beginning of the century just referred to, is described as "Vir illustris ac patricius Galliarum." Patrick's real name, according to tradition, was Succat, but in his own writings he calls himself Patrick. There was, however, another Patrick who under the name of Palladius was unquestionably sent as bishop to Ireland by Pope Celestine in the year 431, that is, the year before the other Patrick commenced his mission according to the generally received accounts. Irish writers also mention a third Patrick, Senn Patraic, or Old Patrick, the head of St Patrick's community (capit sapientum seniorum ejus) according to one account, and his tutor according to another. The three Patricks have sorely puzzled hagiologists, and created so much confusion and conjecture in the history of the early church that some have doubted the existence of such a personage as St Patrick at all. The absence of any contemporary reference to him, or of any mention of him by Columbanus, Bede, and indeed with very few exceptions by any writers outside of Ireland before the 9th century, adds very much to the uncertainty and obscurity of the subject. (W. K. S.)

PATRICK, ST, ORDER OF. See KNIGHTHOOD, vol. xiv. pp. 123-24.

PATRICK, SIMON (1626-1707), bishop of Chichester, and afterwards of Ely, author of a number of works in practical divinity, was born at Gainsborough, Lincolnshire, on 8th September 1626, entered Queens' College, Cambridge, in 1644, and, after taking orders in 1651, became successively chaplain to Sir Walter St John, and vicar of Battersea, Surrey. He was afterwards (1662) preferred to the rectory of St Paul's, Covent Garden, London, where he continued to labour during the year of the plague. Dean of Peterborough from 1678, he became bishop of Chichester in 1689, in which year he was employed, along with others of the new bishops, to settle the affairs of the church in Ireland. In 1691 he received the bishopric of Ely, which he held until his death, 31st May 1707.

His sermons and devotional writings, which are very numerous, were held in high estimation in last century, and his edifying *Commentary on the Historical and Poetical Books of the Old Testament*, in 10 vols., brought down as far as to the Song of Solomon, has been reprinted comparatively recently (1853). His *Friendly Debate between a Conformist and a Nonconformist* was a controversial tract which excited considerable feeling at the time of its publication in 1668, but he lived long enough to soothe by his moderation and candour the exasperation it had caused. The first collected edition of his works appeared at Oxford in 1859 (9 vols., 8vo); a small *Autobiography* was published also at Oxford in 1839.

PATRON AND CLIENT. Clientage appears to have been an institution of most of the Græco-Italian peoples in early stages of their history; but it is in Rome that we can most easily trace its origin, progress, and decay. Until the reforms of Servius Tullius, the only citizens proper were the members of the patrician or gentile houses; they alone could participate in the solemnities of the national religion, take part in the government and defence of the state, contract quiritarian marriage, hold property, and enjoy the protection of the laws. But alongside of them was a gradually increasing non-citizen population composed of slaves and clients. Some historians class amongst the latter, as clients of the state, those vanquished com-



munities which, having made an unconditional submission, were allowed to retain a quasi-corporate existence under the protection of Rome. But the name (derived from *clere*, κλέρη, to obey) was common before Rome had made any conquests, and was usually applied to individuals who had attached themselves in a condition of dependence to the heads of patrician houses as their patrons, in order thereby to secure a *de facto* freedom. The relationship was ordinarily created by what, from the client's point of view, was called *adplicatio ad patronum*, from that of the patron, *susceptio clientis*,—the client being either a person who had come to Rome as an exile, who had passed through the asylum, or who had belonged to a state which Rome had overthrown. According to Dionysius and Plutarch, it was one of the early cares of Romulus to regulate the relationship, which, by their account of it, was esteemed a very intimate one, imposing upon the patron duties only less sacred than those he owed to his children and his ward, more urgent than any he could be called upon to perform towards his kinsmen, and whose neglect entailed the penalty of death (*Tellumon's sacer esto*). He was bound to provide his client with the necessaries of life; and it was a common practice to make him a grant during pleasure of a small plot of land to cultivate on his own account. Further, he had to advise him in all his affairs; to represent him in any transactions with third parties in which, as a non-citizen, he could not act with effect; and, above all things, to stand by him, or rather be his substitute, in any litigation in which he might become involved. The client in return had not only generally to render his patron the respect and obedience due by a dependant, but, when he was in a position to do so and the circumstances of the patron required it, to render him pecuniary assistance. As time advanced and clients amassed wealth, we find this duty insisted upon in a great variety of forms, as in contributions towards the dowries of a patron's daughters, towards the ransom of a patron or any of his family who had been taken captive, towards the payment of penalties or fines imposed upon a patron, even towards his maintenance when he had become reduced to poverty. Neither might give evidence against the other,—a rule we find still in observance well on in the 7th century of the city, when C. Herennius declined to be a witness against C. Marius on the ground that the family of the latter had for generations been clients of the Herennii (Plut., *Mar.* 5). The client was regarded as a minor member (*gentilivicius*) of his patron's *gens*; he was entitled to assist in its religious services, and bound to contribute to the cost of them; he had to follow his patron to battle on the order of the *gens*; he was subject to its jurisdiction and discipline, and was entitled to burial in its common sepulchre. And this was the condition, not only of the client who personally had attached himself to a patron, but that also of his descendants; the patronage and the clientage were alike hereditary. In much the same position as the clients, in the earlier centuries of Rome at least, were the freedmen; for originally a slave did not on enfranchisement become a citizen; it was a *de facto* freedom merely that he enjoyed; his old owner was always called his patron, while he and his descendants were substantially in the position of clients, and often so designated. In the two hundred years that elapsed before the Servian constitutional reforms, the numerical strength of the clients, whether in that condition by *adplicatio*, enfranchisement, or descent, must have become considerable; and it was from time to time augmented by the retainers of distinguished immigrants admitted into the ranks of the patriciate. That all these, concurrently with the unattached plebeians, must have been admitted by Servius to nominal citizenship can hardly be doubted. They

probably were included in the four urban tribes; but, being incapable as yet of owning land, they could have no admission to the higher centuries, paid no census-tribute, were not qualified to serve in the legion, and most likely ranked no higher than *accensi*. With the institution of the assemblies of the plebeians of the tribes they must, thanks to their numbers, have gained in influence politically. But it was only with the enactment of the XII Tables that their relations to their patrons were sensibly affected. For, while that code still denied them, in common with the plebeians generally, the right of intermarriage with the patrician families, it conferred upon them most of the other private rights of citizens; in particular, it entitled them to hold and acquire property, to enter into contracts on their own responsibility, and to litigate in person on their own behalf. The relation of patron and client, it is true, still remained; the patron could still exact from his client respect, obedience, and service, and he and his *gens* had still an eventual right of succession to a deceased client's estate. But the fiduciary duties of the patron were greatly relaxed, and practically little more was expected of him than that he should continue to give his client his advice, and prevent him falling into a condition of indigence; *sacer esto* ceased to be the penalty of protection denied or withheld, its application being limited to *fraus facta*, which, in the language of the Tables, meant positive injury inflicted or damage done. So matters remained during the 4th and 5th centuries. In the 6th a variety of events, social and political, contributed still further to modify the relationship. The rapacity of patrons was checked by the Cincian law, which prohibited their taking actual gifts of money from their clients; marriages between patron and client gradually ceased to be regarded as unlawful, or as ineffectual to secure to the issue the status of the patron father; political changes opened to the clients the rural tribes and the higher centuries, and qualified them for the legion, the magistracy, and the senate; hereditary clientage ceased when a client attained to a curule dignity; and, in the case of the descendants of freedmen enfranchised in solemn form, it came to be limited to the first generation. Gradually but steadily one feature after another of the old institution disappeared, till by the end of the 7th century it had resolved itself into the limited relationship between patron and freedman on the one hand, and the unlimited honorary relationship between the patron who gave gratuitous advice on questions of law and those who came to consult him on the other. To have a large following of clients of this class was a matter of ambition to every man of mark in the end of the republic; it increased his importance, and ensured him a band of zealous agents in his political schemes. But amid the rivalries of parties and with the venality of the lower orders, baser methods had to be resorted to in order to maintain a patron's influence; the favour and support of his clients had to be purchased with something more substantial than mere advice. And so arose that wretched and degrading clientage of the early empire, of which Martial, who was not ashamed to confess himself a first-rate specimen of the breed, has given us such graphic descriptions; gatherings of miserable idlers, sycophants, and spendthrifts, at the levees and public appearances of those whom, in their fawning servility, they addressed as lords and masters, but whom they abused behind their backs as close-fisted upstarts,—and all for the sake of the *sportula*, the daily dole of a dinner, or of a few pence wherewith to procure one. With the middle empire this disappeared; and, when a reference to patron and client occurs in later times, it is in the sense of counsel and client, the words patron and advocate being used almost synonymously. It was not so in the days of the great forensic orators. The word advocate, it is said,

occurs only once in the singular in the pages of Cicero ; and by *advocati* was generally understood at that time the body of friends who stood by a litigant in a great cause to give him in any shape their countenance and support. The orator who then appeared in the comitia or before a judge was almost invariably called patron, though the name of client was not so commonly given to the litigant he represented. But at a later period, when the bar had become a profession, and the qualifications, admission, numbers, and fees of counsel had become a matter of state regulation, *advocati* was the word usually employed to designate the pleaders as a class of professional men, each individual advocate, however, being still spoken of as patron in reference to the litigant with whose interest he was entrusted. It is in this limited connexion that patron and client come under our notice in the latest monuments of Roman law.

*Literature.*—On the clientage of early Rome, see Mommsen, "Die Römische Clientel," *Röm. Forschungen*, vol. i. p. 355 (Berlin, 1864); Voigt, "Ueber die Clientel und Libertinität," in *Ber. d. phil. histor. Classe d. Königl. Sächs. Gesellsch. d. Wissenschaften* (1878, pp. 147-219); Marquardt, *Privatrecht d. Römer*, pp. 196-200 (Leipzig, 1879); Voigt, *Die XII. Tafeln*, vol. ii. pp. 667-679 (Leipzig, 1883). Earlier literature is noted in Willems, *Le Droit Public Romain*, 4th ed., p. 26 (Louvain, 1880). On the clientage of the early empire, see Becker, *Gallus*, vol. ii., Excursus 4; Friedländer, *Sitten-Geschichte Roms*, vol. i. pp. 207-219 (Leipzig, 1862); Marquardt, *op. cit.*, pp. 200-208. On the latest clientage, see Graillet-Dumazeau, *Le Barreau Romain* (Paris, 1851). (J. M\*.)

PATTESON, JOHN COLERIDGE (1827-1871), bishop of Melanesia, was the eldest son of Justice Patteson and Frances Duke Coleridge, a near relation of Samuel Taylor Coleridge, and was born in Gower Street, Bedford Square, 2d April 1827. He was educated at Ottery St Mary, and at Eton, where he greatly distinguished himself on the cricket-field. He entered Balliol College, Oxford, in 1845, and graduated B.A. in 1848. After spending some time on the Continent in the capacity of tutor, he in 1852 became a fellow of Merton College. In 1853 he became curate of Alington, Devon, and in the following year he was ordained priest and joined the mission to the Melanesian islands in the South Pacific. There he laboured with great success, visiting the different islands of the group in the mission ship the "Southern Cross," and by his good sense and unselfish devotion winning the esteem and affection of the natives. In 1861 he was consecrated bishop of Melanesia, and in this capacity did much to promote the Christianization of the islands until his premature death by the hand of a native, 20th September 1871.

See *Life* by Charlotte M. Yonge, which first appeared in 1873, and has gone through several editions.

PAU, a city of France, formerly the capital of Béarn, and now the chief town of the department of Basses Pyrénées, and the seat of a court of appeal, is situated in 43° 17' N. lat. and 0° 23' W. long., on the edge of a plateau 130 feet above the right bank of the Gave de Pau (a left-hand affluent of the Adour), at a height of about 620 feet above the sea. It thus enjoys an admirable view of the Pyrenees, which rise about 25 miles to the south. A small stream, the Hédas, flowing in a deep ravine and crossed by several bridges, divides the city into two parts. The older and larger is enclosed between the Hédas, the Gave, and its other tributary the Ousse, and ends with the castle in the west, while the new districts stretch northward in the direction of the *landes* of Pont-long. The modern importance of Pau

is due to its climate, which makes it a great winter health resort. The most striking characteristic is the stillness of the air, resulting from the peculiarly sheltered situation: The town is built on a sandy soil, and the line of the streets running east and west is favourable to ventilation. The average rainfall is about 40 inches, and the mean winter temperature is 44°, the mean for the year being 62°.

Apart from an export flour-trade and some manufactures of chocolate and Béarn linen, the inhabitants of Pau depend entirely on their four thousand winter-visitors. Place Royale (in the centre of which, instead of the older statue of Louis XIV., now stands Raggi's statue of Henry IV., with bas-reliefs by Etex) is admired for the view which it affords over the valley of the Gave and the Pyrenees; it is connected by a fine boulevard with the castle gardens. Beyond the castle a park of thirty acres planted with beech trees stretches along the high bank of the Gave. The castle is bounded on the north and west by the Hédas, on the south by a canal drawn from the Gave, and on the east by a moat 30 feet deep; access is obtained by three bridges, that across the Hédas being of ancient construction. The castle is flanked by six square towers: south-east is that of Gaston Phœbus (113 feet high); north-east is the tower of Montauset or Montoiseau, so called because reached by removable ladders; east, the new tower; north-west, that of Billères; and on the west are those of Mazères. Another to the south is named after the mint in which Calvin used to preach.

In the gardens to the west of the castle stand a statue of Gaston Phœbus by Triquet and two porphyry vases presented by Bernadotte king of Sweden, who was born at Pau. In the castle court is a well 223 feet deep, with 100 feet of water; but it has been closed since 1855. On the ground-floor is the old hall of the estates of Béarn, 85 feet long and 36 feet wide, adorned with a white marble statue of Henry IV., and magnificent Flemish tapestries ordered by Francis I. Several of the upper chambers are adorned with Flemish, Brussels, or Gobelin tapestry, with tables in Swedish porphyry, Sévres vases, fine coffers (notably a Gothic coffer from Jerusalem), arm-chairs of the 16th century, Venetian and St Gobain glass, &c.; but the

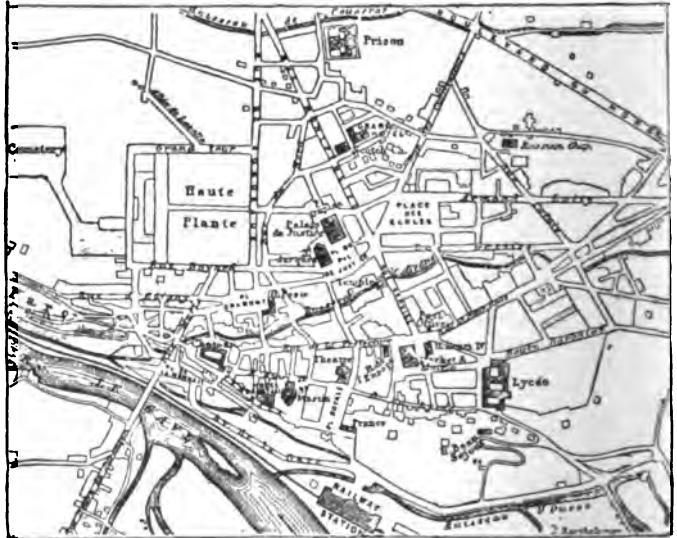

Plan of Pau.

most interesting room is that in which Henry IV. was born, still containing his mother's bed (from the castle of

Richelieu) and his own cradle made of a tortoise-shell. In the keep is a library of 6000 volumes, mainly of works relating to Henry IV. The two Gothic churches of St Jacques and St Martin are both modern; but the latter is of note for the height and elegance of its tower, its stained glass, and the fine Pyrenean marbles used in the high altar, the baldachin, and the sanctuary. Besides the state Protestant church (Église Française Réformée) there are Presbyterian, Anglican, and Russian places of worship. The population of Pau (about 6000 at the close of the 18th century) was 27,300 in 1871, and 29,971 in 1881..

Pau derives its name from the "pale" (in Langue d'Oc "pau") or palisade surrounding the old castle mentioned in the *fors* of Osmou in 1221. By the erection (1363) of the present castle Gaston Phœbus made the town a place of importance, but the viccounts

of Béarn continued to reside at Orthes till the reign of Gaston XI., when the states of Béarn were united at Pau. Gaston's grandson and successor Francis Phœbus, became king of Navarre in 1479. Margaret of Valois, who married Henry d'Albret, embellished the castle and gardens, and made her court one of the most brilliant of the time. In the religious disturbances under her daughter, Jeanne d'Albret, several Catholic nobles were put to death in the castle as rebels. In 1579, while a prisoner, Henry (afterwards IV. of France) restored the Catholic religion in Béarn, but the provincial estates met at Pau and rejected the decree, which Henry himself cancelled when he obtained his freedom. Pau continued to be the capital till 1620, though in 1614 the states of France demanded the union of Béarn and Basse Navarre with the French crown. When Louis XIII. entered the town in 1620 he restored the Catholic clergy to their privileges and possessions, disbanded the forces of Béarn, and caused the parliament of Pau to register the edict of union. The castle was occupied by Abd-el-Kader during part of his captivity.

P A U L .

"SAUL, who is also (called) Paul," was a "Hebrew of the Hebrews," i.e., of pure Jewish descent mixed with Gentile blood, of the tribe of Benjamin (Rom. xi. 1; 2 Cor. xi. 22; Phil. iii. 5). In the Acts of the Apostles it is stated that he was born at Tarsus in Cilicia (ix. 11, xxi. 39, xxii. 3); but in the 4th century there still lingered a tradition that his birthplace was Giscala, the last of the fortress-towns of Galilee which held out against Rome (Jerome, *De vir. illustr.* c. 5; *Ad Philœm.* v. 23).<sup>1</sup> The fact that he was called by two names has been accounted for in various ways. Saul (the Aramaic form, used only as a vocative, and in the narratives of his conversion, Acts ix. 4, 17, xxii. 7, 13, xxvi. 14; elsewhere the Hellenized form, Σαῦλος) was a natural name for a Benjamite to give to his son, in memory of the first of Jewish kings; Paul is more difficult of explanation. It is first found in the narrative of the conversion of Sergius Paulus, the proconsul of Cyprus (Acts xiii. 9), and it has sometimes been supposed either that Paul himself adopted the name in compliment to his first Gentile convert of distinction (Jerome, Olshausen, Meyer, Ewald), or that the writer of the Acts intended to imply that it was so adopted (Baur, Zeller, Hausrath). Others have thought that it was assumed by Paul himself after the beginning of his ministry, and that it is derived from the Latin *paulus* in the sense either of "least among the apostles" (St Augustine) or "little of stature" (Mangold, with reference to 2 Cor. x. 10; Gal. iv. 13). But these and many similar conjectures may probably be set aside in favour of the supposition that he had a double name from the first, one Aramaic or Hebrew and the other Latin or Greek, like Simon Peter, John Mark, Simeon Niger, Joseph Justus; this supposition is confirmed by the fact that Paul was not an uncommon name in Syria and the eastern parts of Asia Minor (instances will be found in the *Index Nominum* to Boeckh's *Corp. Inscr. Græc.*). Whatever be its origin, Paul is the only name which he himself uses of himself, or which is used of him by others when once he had entered into the Roman world outside Palestine. The Acts speak of his having been a Roman citizen by birth (xxii. 28; cf. xvi. 17, xxiii. 27), a statement which also has given rise to several conjectures, because there is no clue to the ground upon which his claim to citizenship was based. Some modern writers question the fact, considering the statement to be part of the general colouring which the writer of the Acts is supposed to give to his narrative; and some also question the fact, which is generally considered to support it, of the appeal to the emperor. That he received part of his education at Tarsus, which was a

great seat of learning, is a possible inference from his use of some of the technical terms which were current in the Greek schools of rhetoric and philosophy; but, since the cultivation of a correct grammatical and rhetorical style was one of the chief studies of those schools, Paul's imperfect command of Greek syntax seems to show that this education did not go very far. That he received the main part of his education from Jewish sources is not only probable from the fact that his family were Pharisees, but certain from the whole tone and character of his writings. According to the Acts, his teacher was Gamaliel, who as the grandson of Hillel took a natural place as the head of the moderate school of Jewish theologians; nor, in spite of the objection that the fanaticism of the disciple was at variance with the moderation of the master, does the statement seem in itself improbable. A more important difficulty in the way of accepting the statement that Jerusalem was the place of his education is the fact that in that case his education must have been going on at the time of the preaching and death of Jesus Christ. That he had not seen Jesus Christ during His ministry seems to be clear, for a comparison of 1 Cor. ix. 1 with xv. 8 appears to limit his sight of Christ to that which he had at his conversion, and the "knowing Christ after the flesh" of 2 Cor. v. 16 is used not of personal acquaintance but of "carnal" as opposed to "spiritual" understanding; nor does the difficulty seem to be altogether adequately explained away by the hypothesis which some writers (e.g., Neander, Wieseler, Beyschlag) have adopted, that he was temporarily absent from Jerusalem at the times when Jesus Christ was there. Like all Jewish boys, he learnt a trade, that of tent-making; this was a natural employment for one of Cilician origin, since the hair of the Cilician goat was used to make a canvas (*cilicia*) which was specially adapted for the tents used by travellers on the great routes of commerce or by soldiers on their campaigns (cf. Philo, *De anim. sacrif. idon.*, i. vol. ii. p. 238, ed. Mang.). Whether he was married or not is a question which has been disputed from very early times; his expressions in 1 Cor. vii. 8, ix. 5, were taken by Tertullian to imply that he was not, and by Clement of Alexandria and Origen to imply that he had once been, but that he had become a widower.

The beginning of his active life was doubtless like its maturity; it was charged with emotion. He himself gives a graphic sketch of its inner history. His conversion to Christianity was not the first great change that he had undergone. "I was alive without the law once" (Rom. vii. 9). He had lived in his youth a pure and guileless life. He had felt that which is at once the charm and the force of such a life, the unconsciousness of wrong. But,

<sup>1</sup> It was an Ebionite slander that he was not a Jew at all, but a Greek (Epiphanius, *Hæres.*, xxx. 16).

while his fellow-disciples in the rabbinical schools had been content to dissect the text of the sacred code with a minute anatomy, the vision of a law of God which transcended both text and comment had loomed upon him like a new revelation. And with the sense of law had come the sense of sin. It was like the first dawn of conscience. He awoke as from a dream. "The commandment came." It was intended to be "unto life," but he found it to be "unto death"; for it opened up to him infinite possibilities of sinning: "I had not known lust except the law had said, Thou shalt not lust." And the possibilities of sinning became lures which drew him on to forbidden and hated ground: "sin, finding occasion through the commandment, beguiled me and through it slew me" (Rom. vii. 7-11). This was his inner life, and no man has ever analysed it with a more penetrating and graphic power. In his outward life this sense of the law of God became to him an overpowering stimulus. The stronger the consciousness of his personal failure the greater the impulse of his zeal. The vindication of the honour of God by persecuting heretics, which was an obligation upon all pious Jews, was for him a supreme duty. He became not only a persecutor but a leader among persecutors (Gal. i. 14). What he felt was a very frenzy of hate; he "breathed threatening and slaughter," like the snorting of a war-horse before a battle, against the renegade Jews who believed in a false Messiah (Acts ix. 1, xxvi. 11). His enthusiasm had been known before the popular outbreak which led to Stephen's death, for the witnesses to the martyr's stoning "laid down their clothes" at his feet (Acts vii. 58), and he took a prominent place in the persecution which followed. He himself speaks of having "made havoc" of the community at Jerusalem, spoiling it like a captured city (Gal. i. 13, 23); in the more detailed account of the Acts he went from house to house to search out and drag forth to punishment the adherents of the new heresy (viii. 3). When his victims came before the Jewish courts he tried, probably by scourging, to force them to apostatize (xxvi. 11); in some cases he voted for their death (xxii. 4, xxvi. 10). The persecution spread from Jerusalem to Judæa and Galilee (ix. 31); but Paul, with the same spirit of enterprise which afterwards showed itself in his missionary journeys, was not content with the limits of Palestine. He sought and obtained from the ecclesiastical authorities at Jerusalem letters similar to those which, in the 13th century, the popes gave to the "militia Jesu Christi contra hæreticos." The ordinary jurisdiction of the synagogues was for the time set aside; the special commissioner was empowered to take as prisoners to Jerusalem any whom he found to belong to the sect known as "The Way" (Acts ix. 2, xxii. 4, xxiv. 14; it is possible that the phrase was used of Christians by themselves, like the phrase "The Cause" among some of the nonconforming churches of England). Of the great cities which lay near Palestine Damascus was the most promising, if not the only field for such a commission. At Antioch and at Alexandria, though the Jews, who were very numerous, enjoyed a large amount of independence and had their own governor, the Roman authorities would probably have interfered to prevent the extreme measures which Paul demanded. At Damascus, where also the Jews were numerous and possibly had their own civil governor (2 Cor. xi. 32), the Arabian prince Aretas (Haritha), who then held the city, might naturally be disposed to let an influential section of the population deal as they pleased with their refractory members.

On Paul's way thither an event occurred which has proved to be of transcendent importance for the religious history of mankind. He became a Christian by what he believed to be the personal revelation of Jesus Christ.

His own accounts of the event are brief, but they are at the same time emphatic and uniform. "It pleased God . . . to reveal His Son in me" (Gal. i. 16); "have I not seen Jesus Christ our Lord" (1 Cor. ix. 1); "last of all He was seen of me also as of one born out of due time" (1 Cor. xv. 8, where *ἄφθρη κάμοι* must be read in the sense of the parallel expressions *ἄφθρη Κηφῶν*, &c.; in other words, Paul puts the appearance to himself on a level with the appearances to the apostles after the resurrection). These accounts give no details of the circumstances. St Paul's estimate of the importance of such details was probably different from that which has been attached to them in later times. The accounts in the Acts of the Apostles are more elaborate; they are three in number, one in the continuous narrative, ix. 3-19, a second in the address on the temple stairs, xxii. 6-21, a third in the speech to Agrippa, xxvi. 12-18; they all differ from each other in details, they all agree in substance; the differences are fatal to the stricter theories of verbal inspiration, but they do not constitute a valid argument against the general truth of the narrative.<sup>1</sup>

It is natural to find that the accounts of an event which lies so far outside the ordinary experience of men have been the object of much hostile criticism. The earliest denial of its reality is found in the Judæo-Christian writings known as the *Clementine Homilies*, where Simon Magus, who is made to be a caricature of Paul, is told that visions and dreams may come from demons as well as from God (*Clem. Hom.*, xvii. 13-19). The most important of later denials are those of the Tübingen school, which explain the narratives in the Acts either as a translation into the language of historical fact of the figurative expressions of the manifestation of Christ to the soul, and the consequent change from spiritual darkness to light (e.g., Baur, *Paul*, E.T., vol. i. p. 76; Zeller, *Acts*, E.T., vol. i. p. 289), or as an ecstatic vision (Holsten, *Das Evangelium des Paulus*, p. 65). But against all the difficulties and apparent incredibilities of the narratives there stand out the clear and indisputable facts that the persecutor was suddenly transformed into a believer, and that to his dying day he never ceased to believe and to preach that he had "seen Jesus Christ."

Nor was it only that he had seen Him; the gospel which he preached, as well as the call to preach it, was due to this revelation. It had "pleased God to reveal His Son in him" that he "might preach Him among the Gentiles" (Gal. i. 12, 16). He had received the special mark of God's favour, which consisted in his apostleship, that all nations might obey and believe the gospel (Rom. i. 5, cf. xii. 3, xv. 15, 16). He had been entrusted with a secret (*μυστήριον*) which had "been kept in silence through times eternal," but which it was now his special office to make known (Rom. xi. 25, xvi. 25, 26; and even more prominently in the later epistles, Eph. i. 9, iii. 2-9, vi. 19; Col. i. 26, 27, iv. 3). This secret was that "the Gentiles are fellow-heirs, and fellow-members of the body, and fellow-partakers of the promise in Christ Jesus through the gospel." This is the key to all his subsequent history. He was the "apostle of the Gentiles," and that "not from men, neither through man" (Gal. i. 1); and so thoroughly was the conviction of his special mission wrought into the fibres of his nature that it is difficult to give full credence to statements which appear to be at variance with it.

Of his life immediately after his conversion he himself

<sup>1</sup> For a clear and concise summary of the points of agreement and difference between the three accounts, reference may be made to an article by F. Zimmer, "Die drei Berichte der Apostelgeschichte über die Bekehrung des Paulus," in Hilgenfeld's *Zeitschr. wissenschaftl. Theol.*, 1882, p. 465 sq.

gives a clear account: "I conferred not with flesh and blood, neither went I up to Jerusalem to them which were apostles before me; but I went away into Arabia" (Gal. i. 16, 17). The reason of his retirement, whether it was to the Haurán (Renan) or to the Sinaitic peninsula (Holsten), is not far to seek. A great mental no less than a great bodily convulsion naturally calls for a period of rest; and the consequences of his new position had to be drawn out and realized before he could properly enter upon the mission-work which lay before him. From Arabia he returned to Damascus (Gal. i. 17), and there began not only his preaching of the gospel but also the long series of "perils from his own countrymen," which constitute so large a part of the circumstances of his subsequent history (Acts ix. 23-25; 2 Cor. xi. 32, 33).

It was not until "after three years," though it is uncertain whether the reckoning begins from his conversion or from his return to Damascus, that he went up to Jerusalem; his purpose in going was to become acquainted with Peter, and he stayed with him fifteen days (Gal. i. 18). Of his life at Jerusalem on this occasion there appear to have been erroneous accounts current even in his own lifetime, for he adds the emphatic attestation, as of a witness on his oath, that the account which he gives is true (Gal. i. 20). The point on which he seems to lay emphasis is that, in pursuance of his policy not to "confer with flesh and blood," he saw none of the apostles except Peter and James, and that even some years afterwards he was still unknown by face to the churches of Judæa which were in Christ.<sup>1</sup>

From Jerusalem he went "into the regions of Syria and Cilicia," preaching the gospel (Gal. i. 21, 23). How much that brief expression covers is uncertain; it may refer only to the first few months after his departure from Jerusalem, or it may be a summary of many travels, of which that which is commonly known as his "first missionary journey" is a type. The form of expression in Gal. ii. 1 makes it probable that he purposely leaves an interval between the events which immediately succeeded his conversion and the conference at Jerusalem. For this interval, assuming it to exist, or in any case for the detail of its history, we have to depend on the accounts in Acts xi. 20-30, xii. 25 to xiv. 28. These accounts possibly cover only a small part of the whole period, and they are so limited to Paul's relations with Barnabas as to make it probable that they were derived from a lost "Acts of Barnabas." This supposition would probably account for the fact that in them the conversion of the Gentiles is to a great extent in the background.

The chief features of these accounts are the formation of a new centre of Christian life at Antioch, and a journey which Paul, Barnabas, and for part of the way John Mark took through Cyprus and Asia Minor.

The first of these facts has a significance which has sometimes been overlooked for the history not only of Paul himself but of Christianity in general. It is that the mingling together, in that splendid capital of the civilized East, of Jews and Syrians on the one hand with Greeks and Romans on the other furnished the conditions which made a Gentile Christianity possible. The religion of Jesus Christ emerged from its obscurity into the full glare of contemporary life. Its adherents attracted enough attention to receive in the common talk and intercourse of men a distinctive name. They were treated, not as a Jewish sect, but as a political party. To the Greek equivalent for the Hebrew "Messiah," which was probably considered to be not a title but a proper name, was added the

termination which had been employed for the followers of Sulla, of Pompey, and of Cæsar. It is improbable that this would have been the case unless the Christian community at Antioch had had a large Gentile element; and it is an even more certain and more important fact that in this first great mixed community the first and greatest of all the problems of early Christian communities had been solved, and that Jews and Gentiles lived a common life (Gal. ii. 12). What place Paul himself had in the formation of this community can only be conjectured. In the Acts he is less prominent than Barnabas; and, although it must be gathered from the Epistle to the Galatians that he took a leading part in the controversies which arose, still it is to be noted that he never elsewhere mentions Antioch in his epistles, and that he never visited it except casually in his travels. It may be supposed that from an early period he sought and found a wider field for his activity. The spirit of the Pharisees who "compassed sea and land to make one proselyte" was still strong within him. The zeal for God which had made him a persecutor had changed its direction but not its force. His conversion was but an overpowering call to a new sphere of work. It is consequently difficult to believe that he was content to take his place as merely one of a band of teachers elected by the community or appointed by the Twelve. The sense of a special mission never passed away from him. "Necessity was laid upon him" (1 Cor. ix. 16). Inferior to the Twelve in regard to the fact that he had once "persecuted the church of God," he was "not a whit behind the very chiefest apostles" (2 Cor. i. 5) in regard both to the reality and the privileges of his commission, and to the truth of what he preached (1 Cor. ix. 3-6; 2 Cor. iii. 1-6; Gal. i. 12). It is also difficult to believe that he went out with Barnabas simply as the delegate of the Antiochian community; whatever significance the laying on of hands may have had for him (Acts xiii. 3), it would be contrary to the tenor of all his writings to suppose that he regarded it as giving him his commission to preach the gospel.

The narrative of the incidents of the single journey which is recorded in detail, and which possibly did not occupy more than one summer, has given rise to much controversy. Its general credibility is supported by the probability that in the first instance Paul would follow an ordinary commercial route, on which Jewish missionaries as well as Jewish merchants had been his pioneers. For his letters to his Gentile converts all presuppose their acquaintance with the elements of Judaism. They do not prove monotheism, but assume it.

According to the narrative, Paul and his companions went first to Cyprus, the native country of Barnabas, and travelled through the island from its eastern port, Salamis, to its capital, Paphos. At Paphos a Jewish sorcerer, Bar Jesus, was struck with blindness, and the proconsul, Sergius Paulus, was converted. From Cyprus, still following a common route of trade, they went into the south-east districts of Asia Minor, through Pamphylia to Antioch in Pisidia. At Antioch, on two successive Sabbaths, Paul spoke in the synagogue; the genuineness of the addresses which are recorded in the Acts has been disputed, chiefly because the second of them seems to imply that "turned to the Gentiles," not as a primary and unconditional obligation, but owing to the rejection of the gospel by the Jews. Expelled from Antioch, they went on to Iconium (where the apocryphal "Acts of Paul and Thekla" place the scene of that improbable but not ungraceful romance), and thence to Lystra, where the healing of a cripple caused the simple and superstitious Lycaonians to take them for gods. Their farthest point was the neighbouring town of Derbe, from whence they returned by the route

<sup>1</sup> A different account of this visit to Jerusalem is given in Acts ix. 26-30, xxvi. 20; the account of the trance in the temple, Acts xxi. 17-21, is in entire harmony with Paul's own words.

by which they had come to the sea-coast and thence to Antioch in Syria.

But, although the general features of the narrative may be accepted as true, especially if, as suggested above, its basis is a memoir or itinerary not of Paul but of Barnabas, yet it must be conceded that this portion of the Acts has large omissions. It is difficult to believe that the passionate zeal of an apostle who was urged by the stimulus of a special call of Jesus Christ was satisfied, for the long period of at least eleven years, with one short missionary journey, and that, with the exception of a brief visit to Jerusalem (Acts xi. 30), he remained quietly at Tarsus or at Antioch (xi. 25, xiii. 1, xiv. 28). In this period must fall at least a portion of the experiences which he records in 2 Cor. xi. 24-27, and for which no place can be found in the interval between the conference at Jerusalem and the writing of that epistle. The scourging in the synagogues, the beating with the licitor's rods in the Roman courts, the shipwrecks, the "night and day in the deep," the "perils of robbers," and "perils in the wilderness" belong no doubt to some of the unrecorded journeys of these first years of his apostolic life. A more important omission is that of some of the more distinctive features of his preaching. It is impossible to account for his attitude towards the original apostles in his interview with them at Jerusalem (Gal. ii. 1-10) except on the supposition that before that interview, no less than after it, he was that which he had been specially called to be, the "apostle of the Gentiles" and the preacher of the "gospel of the uncircumcision."

At the end of fourteen years, either from his conversion or from his visit to Peter at Jerusalem, the question of the relation of the communities which he had formed, and of the gospel which he preached, to the original Christian communities, and to the gospel of the Twelve, came to a crisis. His position was unique. He owed neither his knowledge of the gospel nor his commission to preach it to any human authority (Gal. i. 1, 11, 12). As Jesus Christ had taught and sent forth the Twelve, so had He taught and sent forth Paul. He was on equal terms with the Twelve. Until a revelation came to him he was apparently at no pains to co-operate with them. But between their respective disciples there was evidently a sharp contention. The Jewish party, the original disciples and first converts, maintained the continued obligation of the Mosaic law and the limitation of the promises to those who observed it; the Pauline party asserted the abrogation of the law and the free justification of all who believed in Jesus Christ. The controversy narrowed itself to the one point of circumcision. If the Gentiles were without circumcision members of the kingdom of God, why was the law obligatory on the Jews? If, on the other hand, the Gentiles had to be circumcised, the gospel had but a secondary importance. It seemed for a time as though Christianity would be broken up into two sharply-divided sects, and that between the Jewish Christianity, which had its seat at Jerusalem, and which insisted on circumcision, and the Gentile Christianity, which had its seat at Antioch, and which rejected circumcision, there would be an irreconcilable antagonism. It was consequently "by revelation" (Gal. ii. 2) that Paul and Barnabas, with the Gentile convert Titus as their "minister" or secretary, went to confer with the leaders among the original disciples, the "pillars" or "them who were of repute," "James, and Cephas, and John." He put the question to them: Was it possible that he was spending or had spent his labour in vain? (*μὴ ἄνωγος . . . ἔσθραμον* in Gal. ii. 2 form a direct question depending on *ἀνεθέμην*). He laid before them the "gospel of the uncircumcision." They made no addition to it (Paul says of himself *ἀνεθέμην*, and of "them who were of re-

pute" *οὐδὲν προσέθετο*, Gal. ii. 2, 6), but accepted it as Paul preached it, recognizing it as being a special work of God, and as being on the same level of authority with their own (Gal. ii. 7-9). The opposition was no doubt strong; there were "false brethren" who refused to emancipate the Gentile world from the bondage of the law; and there was also apparently a party of compromise which, admitting Paul's general contention, maintained the necessity of circumcision in certain cases, of which the case of Titus, for reasons which are no longer apparent, was typical. But Paul would have no compromise. From his point of view compromise was impossible. "Justification" was either "of faith" or "by the works of the law"; it was inconceivable that it could be partly by the one and partly by the other. And he succeeded in maintaining his position at all points. He received "the right hand of fellowship," and went back to Antioch the recognized head and preacher of the "gospel of the uncircumcision." Within his own sphere he had perfect freedom of action; the only tie between his converts and the original community at Jerusalem was the tie of benevolence. Jew and Gentile were so far "one body in Christ" that the wealthier Gentile communities should "remember the poor."<sup>1</sup>

When Paul returned to Antioch Peter followed him, and for a time the two apostles worked in harmony. Peter "did eat with the Gentiles." He shared the common table

<sup>1</sup> Few passages of the New Testament have been more keenly debated of late years than the accounts of this conference at Jerusalem in Acts xv. 4-29 and Gal. ii. 1-10. The only writers of eminence in recent times who think that the two accounts refer to separate events are Caspari, who identifies the visit to Jerusalem mentioned in Gal. ii. 1-10 with that of Acts xi. 30, xii. 25, and Wieseler, who identifies it with that of Acts xviii. 21, 22; and both theories are chronologically impossible. Almost all writers agree in thinking that the two accounts refer to the same event, but no two writers precisely agree as to the extent to which they can be reconciled. (1) The differences between them were first insisted on by Schweigger, *Das nachapostolische Zeitalter*, 1845, vol. i. 116; then by Zeller, *Die Apostelgeschichte*, E.T., vol. ii. 8; Baur, *Paulus*, E.T., vol. i. 109; Hilgenfeld, *Der Galaterbrief*, 1852, p. 52, and in his *Einführung in das Neue Testament*, 1875, p. 227, &c.; Krenkel, *Paulus*, 1869, p. 62; Lipsius, s.v. "Apostelkonvent," in Schenkel's *Bibel-Lexikon*, 1868, vol. i. 194; Overbeck, in his edition of De Wette's *Apostelgeschichte*, 1870, p. 216; Pfleiderer, *Paulinismus*, 1873, E.T., vol. ii. 5 and 284, and also in his "Paulinische Studien," in the *Jahrb. f. prot. Theol.*, 1883, No. 2; Weizsäcker, in the *Jahrb. f. deutsche Theol.*, 1873, p. 191; Hausrath, *Neuzeitliche Zeitgeschichte*, 2d ed., vol. iii. 151, vol. iv. 249; Holsten, *zum Evangelium des Paulus und Petrus*, pp. 241, 292, *Das Evangelium des Paulus*, p. 145; Holtzmann, "Der Apostelkonvent," in Hilgenfeld's *Zeitschr. f. wissenschaftl. Theol.*, 1882, p. 436, 1883, p. 129 (to which articles the writer is indebted for several of the references here given). (2) The harmony of the two accounts is maintained, mostly in opposition to the above-named writers, by Neander, *Gesch. d. Pflanzung*, 5th ed., 1862, p. 158; Ewald, *Gesch. d. Volkes Israel*, 3d ed., 1868, vol. vi. 470; Ritseh, *Ent. d. altkath. Kirche*, 2d ed., 1857, p. 128; Lechler, *Das apostol. u. nachapostol. Zeitalter*, 2d ed., 1857, p. 397; Baumgarten, *Die Apostelgeschichte*, 2d ed., 1859, l. 461; Pressensé, *Hist. des trois premiers siècles*, 2d ed., 1868, vol. i. 457; Weiss, *Lehrb. d. bibl. Theol.* (des N.T.), 2d ed., 1878, p. 141; Schenkel, *Das Christusbild der Apostel*, 1879, p. 38; K. Schmidt, s.v. "Apostel-Konvent," in Herzog's *Real-Encyclopädie*, 2d ed., vol. i. 575; Lightfoot, *Galatians*, p. 123; Wendt, in his edition of Meyer's *Apostelgesch.*, 1880, p. 311; Siefert, in Meyer's *Brief an die Galater*, 1880, p. 84, &c.; Zimmer, *Galaterbrief und Apostelgeschichte*, 1882; Niesgen, *Comm. über die Apostelgeschichte*, 1882, p. 287. (3) A compromise between the two accounts is attempted by Renan, *St Paul*, 1869, p. 81; Reuss, *Die Gesch. d. heil. Schr.*, N.T., 5th ed., 1874, p. 57; Keim, "Der Apostelkonvent," in his *Aus dem Urchristenthum*, 1878, p. 64; Grimm, "Der Apostelkonvent," in *Studien u. Kritiken* for 1880, p. 405.

The main points of difficulty in the two accounts are these. (1) The Acts say that Paul went up by appointment of the brethren at Antioch; Paul himself says that he went up "by revelation." (2) In the Acts Paul has a subordinate position; in his own account he treats with "the three" on equal terms. (3) In the Acts Peter and James are on Paul's side from the first; in Galatians they are so only at the end of the conference, and after a discussion. (4) The Acts make the conference result in a decree, in which certain observances are imposed upon the Gentiles; Paul himself expressly declares that the only injunction was that they "should remember the poor."



at which the Jewish distinctions of meats were disregarded. He thereby accepted Paul's position. But when "certain came from James" he drew back. The position of James was probably that, even if the law had ceased to be valid as a means of justification, it was still valid as a rule of life. For reasons which are not apparent, possibly the wish not to break with the community at Jerusalem, not only Peter but Barnabas and the whole of the Jewish party at Antioch accepted that position, with its consequent obligation of separation from the Gentile brethren, not only in social life, but probably also in the partaking of the Lord's Supper. Paul showed that the position of Peter was illogical, and that he was self-convicted (*κατηγορούμενος ἑρ*, Gal. ii. 11). His argument was that the freedom from the law was complete, and that to attach merit to obedience to the law was to make disobedience to the law a sin, and, by causing those who sought to be justified by faith only to be transgressors, to make Christ a "minister of sin." Obedience to any part of the law involved recognition of the whole of it as obligatory (Gal. v. 3), and consequently "made void the grace of God."

The schism in the community at Antioch was probably never healed. It is not probable that Paul's contention was there victorious; for, while Paul never again speaks of that city, Peter seems to have remained there, and he was looked upon in later times as the founder of its church.

But this failure at Antioch served to Paul as the occasion for carrying out a bolder conception. The horizon of his mission widened before him. The "fulness of the Gentiles" had to be brought in. His diocese was no longer Antioch, but the whole of the Roman empire. The years that followed were almost wholly spent among its great cities, "preaching among the Gentiles the unsearchable riches of Christ" (Eph. iii. 8). He became the spiritual father of many communities, and he watched over them with a father's constant care. He gathered round him a company of faithful disciples, who shared with him his missionary work, and whom he sent sometimes to break new ground, sometimes to arrange disputes, sometimes to gather contributions, sometimes to examine and report. Of his travels, whether with them or alone, no complete record has been preserved; some of them are minutely described in the Acts, others within the same period are known only or chiefly from his epistles. In giving an account of them it is necessary to change to some extent the historical perspective which is presented in the Acts; for, in working up fragments of itineraries of Paul's companions into a consecutive narrative, many things are made to come into the foreground which Paul himself would probably have disregarded, and many things are omitted or thrown into the shade to which, from his letters, he appears to have attached a primary importance.<sup>1</sup>

The first scene of his new activity, if indeed it be allowable to consider the conference at Jerusalem and the subsequent dispute at Antioch as having given occasion for a new departure, was probably the eastern part of Asia Minor, and more particularly Galatia. Some of it he had visited before; and from the fact that the Galatians, though they had been heathens (Gal. iv. 8), were evidently acquainted with the law, it may be inferred that he still went on the track of Jewish missionaries, and that here, as elsewhere, Judaism had prepared the way for Christianity. Of his preaching he himself gives a brief summary; it was the vivid setting forth before their eyes of Jesus as the crucified

Messiah, and it was confirmed by evident signs of the working of the Spirit (Gal. iii. 1, 5). The new converts received it with enthusiasm; he felt for them as a father; and an illness (some have thought, from the form of expression in Gal. iv. 15, that it was an acute ophthalmia) which came upon him (assuming this to have been his first visit) intensified their mutual affection. What we learn specially of the Galatians is probably true also of the other Gentiles who received him; some of them were baptized (Gal. iii. 27), they were formed into communities (Gal. i. 2), and they were so far organized as to have a distinction between teachers and taught (Gal. vi. 6).

But an imperative call summoned him to Europe. The western part of Asia Minor, in which afterwards were formed the important churches of Ephesus, Colosse, Hierapolia, and Laodicea, was for the present left alone. He passed on into Macedonia. The change was more than a passage from Asia to Europe. Hitherto, if Antioch be excepted, he had preached only in small provincial towns. Henceforward he preached chiefly, and at last exclusively, in the great centres of population. He began with Philippi, which was at once a great military post and the wealthy entrepôt of the gold and silver mines of the neighbouring Mount Pangæus. The testimony of the eye-witness whose account is incorporated in Acts xvi. 12-18 tells us that his first convert was a Jewish proselyte, named Lydia; and Paul himself mentions other women converts (Phil. iv. 2). There is the special interest about the community which soon grew up that it was organized after the manner of the guilds, of which there were many both at Philippi and in other towns of Macedonia, and that its administrative officers were entitled, probably from the analogy of those guilds, "bishops" and "deacons."

In Europe, as in Asia, persecution attended him. He was "shamefully entreated" at Philippi (1 Thess. ii. 2), and according to the Acts the ill-treatment came not from the Jews but from the Gentile employers of a frenzied prophetess, who saw in Paul's preaching an element of danger to their craft. Consequently he left that city, and passing over Amphipolis, the political capital of the province, but the seat rather of the official classes than of trade, he went on to the great seaport and commercial city of Thessalonica. His converts there seem to have been chiefly among the Gentile workmen (1 Thess. iv. 11; 2 Thess. iii. 10-12), and he himself became one of them. Knowing as he did the scanty wages of their toil, he "worked night and day that he might not burden any of them" (1 Thess. ii. 9; 2 Thess. iii. 8). But for all his working he does not seem to have earned enough to support his little company; he was constrained both once and again to accept help from Philippi (Phil. iv. 16). He was determined that, whatever he might have to endure, no sordid thought should enter into his relations with the Thessalonians; he would be to them only what a father is to his children, behaving himself "holy and righteously and unblameably," and exhorting them to walk worthily of God who had called them (1 Thess. ii. 10-12). But there, as elsewhere, his preaching was "in much conflict." The Jews were actively hostile. According to the account in the Acts (xvii. 5-9), they at last hounded on the lazzaroni of the city, who were doubtless moved as easily as a Moslem crowd in modern times by any cry of treason or infidelity, to attack the house of Jason (possibly one of Paul's kinsmen, Rom. xvi. 21), either because Paul himself was lodging there, or because it was the meeting-place of the community. Paul and Silas were not there, and so escaped; but it was thought prudent that they should go at once and secretly to the neighbouring small town of Berea. Thither, however, the fanatical Jews of Thessalonica pursued them; and Paul, leaving his companions Silas and Timothy at Berea, gave

<sup>1</sup> The most important instance of this is probably the almost entire omission of an account of his relations with the community at Corinth; one of his visits is entirely omitted, another is also omitted, though it may be inferred from the general expression "he came into Greece" (xx. 2); and of the disputes in the community, and Paul's relations to them, there is not a single word.

up his preaching in Macedonia for a time and went southwards to Athens.

The narrative which the Acts give of his stay at Athens is one of the most striking, and at the same time one of the most difficult, episodes in the book. What is the meaning of the inscription on the altar? What is the Areopagus? How far does the reported speech give Paul's actual words? What did the Athenians understand by the Resurrection? These are examples of questions on which it is easy to argue, but which, with our present knowledge, it is impossible to decide. One point seems to be clear, both from the absence of any further mention of the city in Paul's writings and from the absence of any permanent results of his visit, that his visit was a comparative failure. It was almost inevitable that it should be so. Athens was the educational centre of Greece. It was a great university city. For its students and professors the Christianity which Paul preached had only an intellectual interest. They were not conscious of the need, which Christianity presupposes, of a great moral reformation; nor indeed was it until many years afterwards, when Christianity had added to itself certain philosophical elements and become not only a religion but a theology, that the educated Greek mind, whether at Athens or elsewhere, took serious hold of it. Of Paul's own inner life at Athens we learn, not from the Acts, but from one of his epistles. His thoughts were not with the philosophers but with the communities of Macedonia and the converts among whom he had preached with such different success. He cared far less for the world of mocking critics and procrastinating idlers in the chief seat of culture than he did for the enthusiastic artisans of Thessalonica, to whom it was a burning question of dispute how soon the Second Advent would come, and what would be the relation of the living members of the church to those who had fallen asleep. He would fain have gone back to them, but "Satan hindered him" (1 Thess. ii. 17, 18); and he sent Timothy in his stead "to comfort them as concerning their faith," and to prevent their relapsing, as probably other converts did, under the pressure of persecution (1 Thess. iii. 2, 3).

From Athens he went to Corinth, the capital of the Roman province of Achaia, and the real centre of the busy life of Greece. It was not the ancient Greek city with Greek inhabitants, but a new city which had grown up in Roman times, with a vast population of mingled races, who had added to the traditional worship of Aphrodite the still more sensuous cults of the East. Never before had Paul had so vast or so promising a field for his preaching; for alike the filthy sensuality of its wealthy classes and the intense wretchedness of its half-million of paupers and slaves (*τὴν βδελυρίαν τῶν ἐκεῖσε πλουσίων καὶ τῶν πενήτων ἀβλύγητα*, Alciph. iii. 60) were prepared ground upon which his preaching could sow the seed, in the one case of moral reaction, and in the other of hope. At first the greatness of his task appalled him: "I was with you in weakness, and in fear, and in much trembling" (1 Cor. ii. 3). But he laid down for himself from the first the fixed principle that he would preach nothing but "Jesus Christ, and him crucified" (1 Cor. ii. 2), compromising with neither the Jews, to whom "the word of the cross," i.e., the doctrine of a crucified Messiah, was "a stumbling-block," nor with the Gentile philosophers, to whom it was "foolishness" (1 Cor. i. 18, 23). It is probable that there were other preachers of the gospel at Corinth, especially among the Jews, since soon afterwards there was a Judaizing party; Paul's own converts seem to have been chiefly among the Gentiles (1 Cor. xii. 2). Some of them apparently belonged to the luxurious classes (1 Cor. vi. 11), a few of them to the influential and literary classes (1 Cor. i. 26); but the majority were from the lowest classes, the "foolish,"

the "weak," the "base," and the "despised" (1 Cor. i. 27, 28). And among the poor he lived a poor man's life. It was his special "glorying" (1 Cor. ix. 15; 2 Cor. xi. 10) that he would not be burdensome to any of them (1 Cor. ix. 12; 2 Cor. xi. 9, xii. 13). He worked at his trade of tent-making; but it was a hard sad life. His trade was precarious, and did not suffice for even his scanty needs (2 Cor. xi. 9). Beneath the enthusiasm of the preacher was the physical distress of hunger and cold and ill-usage (1 Cor. iv. 11). But in "all his distress and affliction" he was comforted by the good news which Timothy brought him of the steadfastness of the Thessalonian converts; the sense of depression which preceded it is indicated by the graphic phrase, "Now we live, if ye stand fast in the Lord" (1 Thess. iii. 6-8). With Timothy came Silas, both of them bringing help for his material needs from the communities of Macedonia (2 Cor. xi. 9; Acts xviii. 5; perhaps only from Philippi, Phil. iv. 15), and it was apparently after their coming that the active preaching began (2 Cor. i. 19) which roused the Jews to a more open hostility.

Of that hostility an interesting incident is recorded in the Acts (xviii. 12-16); but a more important fact in Paul's life was the sending of a letter, the earliest of all his letters which have come down to us, to the community which he had founded at Thessalonica. Its genuineness, though perhaps not beyond dispute, is almost certain. Part of it is a renewed exhortation to steadfastness in face of persecutions, to purity of life, and to brotherly love; part of it is apparently an answer to a question which had arisen among the converts when some of their number had died before the Parousia; and part of it is a general summary of their duties as members of a Christian community. It was probably followed, some months afterwards, by a second letter; but the genuineness of the Second Epistle to the Thessalonians has been much disputed. It proceeds upon the same general lines as the first, but appears to correct the misapprehensions which the first had caused as to the nearness of the Parousia.

After having lived probably about two years at Corinth Paul resolved, for reasons to which he himself gives no clue, to change the centre of his activity from Corinth to Ephesus. Like Corinth, Ephesus was a great commercial city with a vast mixed population; it afforded a similar field for preaching, and it probably gave him increased facilities for communicating with the communities to which he was a spiritual father. It is clear from his epistles that his activity at Ephesus was on a much larger scale than the Acts of the Apostles indicate. Probably the author of the memoirs from which this part of the narrative in the Acts was compiled was not at this time with him; consequently there remain only fragmentary and for the most part unimportant anecdotes. His real life at this time is vividly pictured in the Epistles to the Corinthians. It was a life of hardship and danger and anxiety: "Even unto this present hour we both hunger and thirst, and are naked, and are buffeted, and have no certain dwelling-place; and we toil, working with our own hands; being reviled, we bless; being persecuted, we endure; being defamed, we intreat; we are made as the filth of the world, the offscouring of all things even until now" (1 Cor. iv. 11-13). It was almost more than he could bear: "We were weighed down exceedingly, beyond our power, inasmuch that we despaired even of life" (2 Cor. i. 8). He went about like one condemned to die, upon whom the sentence might at any moment be carried out (2 Cor. i. 9). Once, at least, it seemed as though the end had actually come, for he had to fight with beasts in the arena (1 Cor. xv. 32); and once, if not on the same occasion, he was only saved by Prisca and Aquila, "who for his life laid down their own necks" (Rom. xvi. 4). But that which

filled a larger place in his thoughts than the "perils" of either the past or the present was the "care of all the churches." He was the centre round which a system of communities revolved; and partly by letters, partly by sending his companions, and partly by personal visits, he kept himself informed of their varied concerns, and endeavoured to give a direction to their life.

His most important relations were those with the communities of Asia Minor and of Corinth.

(A) It is probable that from Ephesus he went to the churches of Galatia. Before writing to the Galatians he had paid them at least two visits (Gal. i. 9, iv. 13), and, although it is conceivable that both visits may belong to his earlier journeys, yet the tone of his letter implies that no great interval had elapsed since his last visit (Gal. i. 6). The Acts mention that soon after his arrival at Ephesus he went to Syria, and returned "through the region of Phrygia and Galatia in order, establishing all the disciples" (xviii. 23); and, although the motive which is assigned for that journey has been called in question, the journey itself is not inconsistent with the statements of his epistles.<sup>1</sup> He appears to have been followed by vigorous opponents, who denied his authority as a Christian teacher, and who taught "another gospel" (Gal. i. 6, 7). He consequently wrote a letter, the Epistle to the Galatians, which, from its marked antithetical character, throws greater light upon the essential points of his preaching than any other which has come down to us. It is mainly directed to three points: first, to assert that what he preached had its origin in a direct revelation to himself, and was consequently of divine authority; secondly, to show that the blessings of the gospel were not limited to the seed of Abraham, but were given to all that believe; thirdly, to maintain that submission to the requirements of the law was not merely unnecessary, but an abandonment of the gospel. To this he adds the practical exhortation that they should not "use their freedom for an occasion to the flesh," but "walk by the Spirit," from whom their new life came.

It is also probable that during his stay at Ephesus several communities were formed in the western corner of Phrygia, in the valley of the Lycus, at Laodicea, Colosse, and Hierapolis. If the testimony of the Epistle to the Colossians be accepted, they were formed, not by Paul himself, but by Epaphroditus (Col. i. 7, ii. 1, iv. 12, 13).

(B) His relations at this time with the community at Corinth may for the most part be clearly inferred from his epistles, but, since they are ignored in the Acts and since the words of the epistles are in some cases ambiguous, there are some points of comparative uncertainty. The following is the most probable account of them. (1) Corinth, soon after Paul left it, was visited by Apollos, who is described in the Acts as an Alexandrian Jew, "a learned man" and "mighty in the Scriptures" (xviii. 24). Paul had "planted," and Apollos "watered" (1 Cor. iii. 6); to the unorthodox and unphilosophical gospel of the one was added the rhetorical and philosophical preaching of the other; they both preached in effect the same gospel, but between their followers there soon came to be a rivalry; and it is probably in contrast to Apollos that Paul subsequently protests that his own preaching was "not in persuasive words of wisdom, but in demonstration of the Spirit and of power" (1 Cor. ii. 4). (2) It is probable that Paul then went to Corinth a second time; since his next visit was his third (2 Cor. xiii. 1, which, however, has sometimes been understood of an unfulfilled intention). (3) The Corinthians afterwards wrote to ask his advice on several points, viz., on marriage, on virgins, on things sacrificed to idols, on spiritual gifts, on the collection for the poor, and on his relations with Apollos (it is probable that the sections of Paul's letter which begin with the preposition *κατά*, "concerning," are the direct answers to the letter of the Corinthians). He also received news of the state of affairs at Corinth from the slaves of Chloe, who told him of the divisions in the community (1 Cor. i. 11), and from Stephanas, Fortunatus, and Achaicus, who not only gave him better news, but probably also brought him material help (1 Cor. xvi. 17). He probably also learnt something from Apollos, who

had come to him (1 Cor. xvi. 13). (4) He then sent Timothy to them (1 Cor. iv. 17, xvi. 10, 11), possibly by way of Macedonia, and with Erastus (Acts xix. 22). It has been thought that Timothy never reached Corinth (Neander, De Wette, Hausrath, partly on the ground that he would have been mentioned in 2 Cor. xii. 17); but, on the other hand, since his intended visit was mentioned in the first letter, his non-arrival would probably have been expressly accounted for in the second (Heinrich, Holtzmann). (5) Before Timothy reached Corinth Paul addressed to the Corinthians the first of the two letters which have come down to us. (6) Afterwards, possibly in consequence of the news which Timothy brought to him at Ephesus, he sent a second letter, which has not been preserved; this is an inference from 2 Cor. ii. 3, 4, vii. 8-12, where the description of a letter written "with many tears," which made the Corinthians "sorry," does not seem applicable to the existing 1 Cor. (Hausrath thinks that this intermediate letter is to be recognized in 2 Cor. x. xiii.; but his hypothesis is rejected by Hilgenfeld, Beyschlag, Klöpfer, Weizsäcker, Holtzmann, and others). (7) Then he sent Titus, probably with a view to the collection of alms for the poor Christians in Palestine (2 Cor. viii. 6, xii. 17, 18; 1 Cor. xvi. 1-3). (8) After this, without waiting for the return of Titus, he resolved to carry out the intention which he had for some time entertained, but which he had abandoned or postponed, of going again himself (1 Cor. xvi. 5, 6; 2 Cor. i. 15, 23; it may be noted that, while in the first epistle his intention was that which he actually carried out, viz., to go first to Macedonia and then to Corinth, in the second epistle the order of his intended route is altered).

An émeute which took place at Ephesus was, according to the Acts, the occasion if not the cause of his leaving that city; "a great door and effectual had been opened unto him" there (1 Cor. xvi. 9), and the growth of the new religion had caused an appreciable diminution in the trade of those who profited by the zeal of the worshippers at the temple (Acts xix. 23 to xx. 1). He went overland to Troas, where, as at Ephesus, "a door was opened unto him in the Lord" (2 Cor. ii. 12); but the thought of Corinth was stronger than the wish to make a new community. He was eager to meet Titus, and to hear of the effect of his now lost letter; and he went on into Macedonia. It is at this point of his life more than at any other that he reveals to us his inner history. At Ephesus he had been hunted almost to death; he had carried his life in his hand; and, "even when we were come into Macedonia, our flesh had no relief, but we were afflicted on every side; without were fightings, within were fears" (2 Cor. vii. 5). But, though the "outward man" was decaying, yet the inward man was renewed day by day; and the climax of splendid paradoxes which he wrote soon afterwards to the Corinthians (2 Cor. vi. 3-10) was not a rhetorical ideal, but the story of his actual life. But after a time Titus came with news which gladdened Paul's heart (2 Cor. vii. 7). He had been well received at Corinth. The letter had made a deep impression. The admonitions had been listened to. The Corinthians had repented of their conduct. They had rid themselves of "him that did the wrong," and Paul was "of good courage concerning them" (2 Cor. vii. 8-16). He then wrote the second of his extant letters to them, which was sent by Titus and the unknown "brother whose praise in the gospel is spread through all the churches," and who had been elected by the churches to travel with Paul and his company (2 Cor. viii. 18, 19). It was probably in the course of this journey that he went beyond the borders of Macedonia into the neighbouring province of Illyricum (Rom. xv. 19); but his real goal was Corinth. For the third time he went there, and, overcoming the scruples of his earlier visits, he was the guest of Gaius, in whose house the meetings of the community took place (Rom. xvi. 23).

Of the incidents of his visit no record remains; the Acts do not even mention it. But it was the culminating point of his intellectual activity; for in the course of it he wrote the greatest of all his letters, the Epistle to the Romans. And, as the body of that epistle throws an invaluable light upon the tenor of his preaching at this

<sup>1</sup> It has been customary to give this visit to Syria a factitious importance by representing it as constituting the point of division between the second and the third missionary journeys. But the arrangement of Paul's active life into "missionary journeys" is artificial and unsatisfactory. The so-called "first missionary journey" is, as has been pointed out above, only a single episode in at least eleven years of work; and, even if it be allowed that the conference at Jerusalem constitutes a sufficiently important epoch in his life to warrant a break in his biography, there is no solid reason whatever for fixing upon this particular visit to Syria as constituting such an epoch. If the latter part of his biography be broken up into chapters at all, it would be much more useful to divide it according to the centres at which he settled from time to time, and from which his activity radiated, Corinth, Ephesus, Caesarea (probably), and Rome.

time to the communities, among which that of Rome can hardly have been singular, so the salutations at the end, whether they be assumed to be an integral part of the whole or not, are a wonderful revelation of the breadth and intimacy of his relations with the individual members of those communities. But that which was as much in his mind as either the great question of the relation of faith to the law or the needs of individual converts in the Christian communities was the collection of alms "for the poor among the saints that were at Jerusalem" (Rom. xv. 26). The communities of Palestine had probably never ceased to be what the first disciples were, communities of paupers in a pauperized country, and consequently dependent upon external help. And all through his missionary journeys Paul had remembered the injunction which had sealed his compact with "the three" (Gal. ii. 10). In Galatia (1 Cor. xvi. 1), among the poor and persecuted churches of Macedonia (Rom. xv. 26; 2 Cor. viii. 1-4), at Corinth, and in Achaia (1 Cor. xvi. 1-3; 2 Cor. viii. and ix.), the Gentiles who had been made partakers with the Jews in spiritual things had been successfully told that "they owed to them also to minister unto them in carnal things" (Rom. xv. 27). The contributions were evidently on a large scale; and Paul, to prevent the charges of malversation which were sometimes made against him, associated with himself "in the matter of this grace" a person chosen by the churches themselves (2 Cor. viii. 19-21, xii. 17, 18); some have thought that all the persons whose names are mentioned in Acts xx. 4 were delegates of their respective churches for this purpose.

He resolved to go to Jerusalem himself with this material testimony of the brotherly feeling of the Gentile communities, and then, "having no more any place" in Greece, to go to the new mission fields of Rome and the still farther West (Rom. xv. 23-25). He was not certain that his peace-offering would be acceptable to the Jewish Christians, and he had reason to apprehend violence from the unbelieving Jews. His departure from Corinth, like that from Ephesus, was probably hastened by danger to his life; and, instead of going direct to Jerusalem (an intention which seems to be implied in Rom. xv. 25), he and his companions took a circuitous route round the coasts of the Ægean Sea. His course lay through Philippi, Troas, Mitylene, Chios, and Miletus, where he took farewell of the elders of the community at Ephesus in an address of which some reminiscences are probably preserved in Acts xx. 18-34. Thence he went, by what was probably an ordinary route of commerce, to the Syrian coast, and at last he reached the Holy City.

The narrative which the Acts give of the incidents of his life there is full of grave difficulties. It leaves altogether in the background that which Paul himself mentions as his chief reason for making the visit; and it relates that he accepted the advice which was given him to avail himself of the custom of vicarious vows, in order to show, by his conformity to prevalent usages, that "there was no truth" in the reports that he had told the Gentiles "not to circumcise their children, neither to walk after the customs" (Acts xxi. 20-26). If this narrative be judged by the principles which Paul proclaims in the Epistle to the Galatians, it seems hardly credible. He had broken with Judaism, and his whole preaching was a preaching of the "righteousness which is of faith," as an antithesis to, and as superseding, the "righteousness which is of the law." But now he is represented as resting his defence on his conformity to the law, on his being "a Pharisee and the son of Pharisees," who was called in question for the one point only that he believed, as other Pharisees believed, in the resurrection of the dead.

What colouring of a later time, derived from later controversies, has been spread over the original outline of the history cannot now be told. While on the one hand the difficulties of the narrative as it stands cannot be overlooked, yet on the other hand no faithful historian will undertake, in the absence of all collateral evidence, the task of discriminating that which belongs to a contemporary testimony and that which belongs to a subsequent recension. From this uncertainty the general concurrence of even adverse critics excepts the "we" section (Acts xvii. 1, xviii. 16); whoever may have been the author of those "we" sections, and whatever may be the amount of revision to which they have been subjected, they seem to have for their basis the diary or itinerary of a companion of Paul, and the account of the voyage contains at least the indisputable fact that Paul went to Rome.

But his life at Rome and all the rest of his history are enveloped in mists from which no single gleam of certain light emerges. Almost every writer, whether apologetic or sceptical, has some new hypothesis respecting it; and the number and variety of the hypotheses which have been already framed is a warning, until new evidence appears, against adding to their number. The preliminary questions which have to be solved before any hypothesis can be said to have a foundation in fact are themselves extremely intricate; and their solution depends upon considerations to which, in the absence of positive and determining evidence, different minds tend inevitably to give different interpretations. The chief of these preliminary questions is the genuineness of the epistles bearing Paul's name, which, if they be his, must be assigned to the later period of his life, viz., those to the Philippian, Ephesian, and Colossians, to Philemon, to Timothy, and to Titus. As these epistles do not stand or fall together, but give rise in each case to separate discussion, the theories vary according as they are severally thought to be genuine or false. The least disputed is the Epistle to Philemon; but it is also the least fruitful in either doctrine or biographical details. Next to it in the order of general acceptance is the Epistle to the Philippians. The Epistles to the Ephesians and to the Colossians have given rise to disputes which cannot easily be settled in the absence of collateral evidence, since they mainly turn partly on the historical probability of the rapid growth in those communities of certain forms of theological speculation, and partly on the psychological probability of the almost sudden development in Paul's own mind of new methods of conceiving and presenting Christian doctrine. The pastoral epistles, viz., those to Timothy and to Titus, have given rise to still graver questions, and are probably even less defensible.

But, even if this preliminary question of the genuineness of the several epistles be decided in each instance in the affirmative, there remains the further question whether they or any of them belong to the period of Paul's imprisonment at Rome, and, if so, what they imply as to his history. It is held by many writers that they all belong to an earlier period of his life, especially to his stay at Caesarea (Acts xxiv. 23, 27). It is held by other writers that they were all sent from Rome, and with some such writers it has become almost an article of faith that he was imprisoned there not once but twice. It is sometimes further supposed that in the interval between the first and second imprisonments he made his intended journey to Spain (Rom. xv. 24, which is apparently regarded as an accomplished fact by the author of the Muratorian fragment); and that either before or after his journey to Spain he visited again the communities of the Ægean seaboard which are mentioned in the pastoral epistles.

The place and manner and occasion of his death are not less uncertain than the facts of his later life. The

only fragment of approximately contemporary evidence is a vague and rhetorical passage in the letter of Clement of Rome (c. 5): "Paul . . . having taught the whole world righteousness, and having come to the goal of the West (ἐπὶ τὸ ῥήμα τῆς δύσεως), and having borne witness (μαρτυρίαν) before the rulers, so was released from the world and went to the Holy Place, having become the greatest example of patience." The two material points in this passage, (1) "the limit of the West," (2) "having borne witness," are fruitful sources of controversy. The one may mean either Rome or Spain, the other may mean either "having testified" or "having suffered martyrdom." It is not until towards the end of the 2d century, after many causes had operated both to create and to crush traditions, that mention is made of Paul as having suffered about the same time as Peter at Rome; but the credibility of the assertion is weakened by its connexion in the same sentence with the erroneous statement that Peter and Paul went to Italy together after having founded the church at Corinth (Dionysius of Corinth, quoted by Eusebius, *H. E.*, ii. 25). A Roman presbyter named Gaius speaks, a few years later, of the martyr-tombs of the two apostles being visible at Rome (quoted by Eusebius, *l. c.*); but neither this testimony nor that of Tertullian (*De præscr.* 36, *Scorp.* 15, *Adv. Marc.* iv. 5) is sufficient to establish more than the general probability that Paul suffered martyrdom. But there is no warrant for going beyond this, as almost all Paul's biographers have done, and finding an actual date for his martyrdom in the so-called Neronian persecution of 64 A.D.<sup>1</sup>

The chronology of the rest of his life is as uncertain as the date of his death. We have no means of knowing when he was born, or how long he lived, or at what dates the several events of his life took place. The nearest approach to a fixed point from which the dates of some events may be calculated is that of the death of Festus, which may probably, though by no means certainly, be placed in 62 A.D.; even if this date were certainly known, new evidence would be required to determine the length of time during which he held office; all that can or could be said is that Paul was sent to Rome some time before the death of Festus in 62 A.D. How widely opinions differ as to the rest of the chronology may be seen by a reference to the chronological table which is given by Meyer in the introduction to his *Commentary on the Acts*, and after him by Farrar, *St Paul*, vol. ii. p. 624.<sup>2</sup>

Of his personality he himself tells us as much as need be known when he quotes the adverse remarks of his opponents at Corinth: "his letters, they say, are weighty and strong; but his bodily presence is weak, and his speech of no account" (2 Cor. x. 10). The Christian romance-writer elaborated the picture, of which some traits may have come to him from tradition: "a man small in stature, bald-headed, bow-legged, stout, close-browed, with a slightly prominent nose, full of grace; for at one time he seemed like a man, at another time he had the face of an angel" (*Acta Pauli et Theclæ*, c. 3, ap. Tischendorf, *Acta Apostolorum Apocrypha*, p. 41); and the pagan caricaturist speaks of him in similar terms, as "bald in front, with a slightly prominent nose, who had taken an aerial journey

into the third heaven" (pseudo-Lucian, *Philopatris*, c. 12). Some early representations of him on gilded glasses and sarcophagi still remain; accounts of them will be found in Smith and Cheetham, *Dict. Chr. Ant.*, vol. ii. p. 1621; Schultz, *Die Katakomben*, Leipzig, 1882, p. 149. That he was sometimes stricken down by illness is clear from Gal. iv. 13 (some have thought also from 2 Cor. ii. 4); and at his moments of greatest exaltation "there was given to him a stake in the flesh . . . that he should not be exalted overmuch" (2 Cor. xii. 7). The nature of this special weakness has given rise to many conjectures; the most probable is that it was one of those obscure nervous disorders which are allied to epilepsy and sometimes mistaken for it.<sup>3</sup>

Of the writings which are ascribed to him in the current lists of the canonical books of the New Testament, and also of the Epistle to the Hebrews, accounts will be found in separate articles under their respective titles. The writings which are ascribed to him outside the canon, and which are all unquestionably pseudonymous, are the following. (1) *The Epistle to the Laodiceans*. This is supposed to be the letter mentioned in Col. iv. 16; it has been recognized as apocryphal from early times (Jer., *Catal. script. eccl.*, c. 5; Theodoret on Coloss. iv. 16, &c.), but it is found in many Latin MSS. of the New Testament. The text, which is a cento from genuine Pauline epistles, will be found, e.g., in Anger, *Ueber den Laodiceerbrief*, Leipzig, 1843; Lightfoot, *Colossians*, p. 274, who also gives a convenient summary of the views which have been held respecting the letter which is actually mentioned. (2) *A Third Epistle to the Corinthians*, i.e., the letter mentioned in 1 Cor. v. 9. This is found in an Armenian version, together with an equally apocryphal letter of the Corinthians to Paul; it has been several times printed, the best edition of it being that of Aucher, *Armenian and English Grammar*, Venice, 1819, p. 188. An English translation will be found in Stanley, *Epistles of St Paul to the Corinthians*, p. 598. (3) *Letters between Paul and Seneca*. These are first mentioned by Jerome, *Catal. script. eccl.*, c. 12, and Augustine, *Epist.* 54 (153), *ad Nov. Julianum*, and have given rise to interesting discussions as to the possibility of personal relations having actually existed between the two men. The letters will be found in most editions of Seneca, e.g., ed. Hassé, vol. iii. 476; for the questions which have been raised concerning them reference may conveniently be made to Funk, "Der Briefwechsel des Paulus mit Seneca," in the *Theol. Quartalschr.*, Tübingen, 1867, p. 602, and Lightfoot, *Philippians*, p. 327. Besides these apocryphal letters there are several apocryphal works which profess to add to our information respecting his life; the most important of these are (1) *The Acts of Peter and Paul*, (2) *The Acts of Paul and Thecla*, (3) *The Apocalypses of Paul*; the first two are printed in Tischendorf's *Acta Apostolorum Apocrypha*, pp. 1, 40, the third in his *Apocalypses Moysi, Esau, Pauli*, p. 34; all three will be found in an English version in *The Apocryphal Gospels, Acts, and Revelations*, translated by A. Walker, Edinburgh, 1870; an elaborate and trustworthy account of them will appear in the not yet completed work of R. A. Lipsius, *Die apokryphen Apostelgeschichten und Apostellegenden*.

*Pauline Theology.*

The consideration of Paul's theology is rendered difficult by several circumstances. Some of these circumstances attach to the theology itself. (1) It has two elements, the logical and the mystical, which are seldom altogether separable from each other; it cannot be stated in a consecutive series of syllogisms, nor can any adequate view of it leave out of sight elements which belong to another order of thought than that within which the modern world ordinarily moves. (2) He belonged to an age in which abstract conceptions had a greater power over men's minds than they have now; the extreme tendency of that feature of his age is seen in Gnosticism, which not only gave abstract ideas an independent existence but endowed them with personality; and, although he was not a Gnostic, yet he lived at a time at which Gnosticism was conceivable, and some of his own expressions are not out of harmony with it. (3) Since he was in some instances attaching new meanings to words which were already in use, and since in such a case it is difficult for even the most rigidly logical writer to keep the new meaning entirely distinct from the old, it is natural to find that a writer of Paul's temperament, especially when writing as he did under different circumstances and to different classes of people, should sometimes use the same word in different senses. Other circumstances arise from the manner in which his theology

<sup>1</sup> The *Martyrium Pauli* in Zacagni, *Coll. mon. vet. eccl.*, Roma, 1698, p. 535, gives not only details but an exact date, viz., 29th June 66 A.D.; the day has been adopted by the Latin Church as the common anniversary of St Peter and St Paul. All the early evidence which bears upon the point has been collected by Kunze, *Præcipua patrum ecclesiasticorum testimonia quæ ad mortem Pauli apostoli spectant*, Göttingen, 1848.

<sup>2</sup> The literature of the subject is extensive; the most convenient summary of the discussions, for English readers, will be found in the introduction to Meyer's *Commentary*, which is mentioned above, and of which there is an English translation.

<sup>3</sup> See Krenkel, "Das körperliche Leiden des Paulus," in the *Zeitschr. f. wissenschaftl. Theol.*, 1878, p. 238; and for various views, Lightfoot, *Galatians*, p. 186; Farrar, *St Paul*, vol. i., Excura. x. p. 652.

has been treated. (4) It has proved to be difficult for most writers to avoid attaching to some of the words which he uses, and ideas are also used by writers of other parts of the New Testament, which may be true in themselves, and which were probably in the minds of those other writers, but which do not appear to have entered into Paul's own system of thought. (5) It has proved to be difficult for most writers to keep Paul's own ideas clear from their later accretions. Those ideas form the basis alike of Augustinianism, of Thomism, and of Lutheranism; and, since one or other of these systems of theology, or some modification of it, forms part of the education of most theological students, and is embodied in the catechism or confession with whose words, if not always with their meaning, every member of a Christian community is more or less familiar, it is not unnatural to find that almost all writers have approached the subject with a certain amount of prepossession in favour of some particular interpretation or combination of Paul's phrases. (6) Another kind of difficulty arises from the very limited extent to which it is possible to apply to his theology the method of comparison. If it were possible to recover a sufficient amount of current Palestinian theology for the purpose, any exposition of Paul's theology would begin by setting forth the main points of the system of ideas in which he was educated, and would proceed to show how far they were affected by the new elements which were introduced into that system by his conversion. Much light is thrown upon some points by the large knowledge of current Alexandrian theology which may be obtained from Philo; but, although Palestinian and Alexandrian theology had many elements in common, they seem to have differed most of all in those respects in which a knowledge of the former would have thrown light upon Paul. It becomes necessary, in the absence of most of the materials which would have been valuable for comparison, to content ourselves with putting together the predicates which he attaches to the several terms which he employs, with disentangling the winding threads of his arguments, and with endeavouring to ascertain what conceptions will best account for the several groups of his varying metaphors. The danger of stating the results of these processes in a systematic form is partly that, without the checks and side-lights which are afforded by a knowledge of their antecedents and surroundings, any such statement is liable to have a false perspective, by making prominent that which was subordinate and giving to unimportant phrases a disproportionate value; and partly that Paul's own variety and complexity of expression reflect the variety and complexity of the spiritual truths with which he deals, and for which any single form of statement is inadequate.

The most fundamental conception, both historically in the development of Paul's own thought, and logically as the ground from which the rest of his theology may be deduced, is that of sin. The word is used sometimes to denote the actual doing of a wrong action, or the consciousness of having done it, and sometimes to denote the tendency to do such actions, or the quality of such actions in the abstract. This tendency or quality is conceived as a quasi-personal being, which dwells in men (Rom. vii. 20), which exercises dominion over them (Rom. v. 21, vi. 12, 14), to which they are slaves (Rom. vi. 13, 17 sq., vii. 14), which pays them wages (Rom. vi. 23), which imposes its law upon them (Rom. vii. 23, 25, viii. 2), which keeps them shut up in prison (Gal. iii. 22), or which, in less metaphorical language, causes evil desires (Rom. vii. 8). It is not precisely defined, but, since it is the opposite of obedience (Rom. vi. 16), its essence may be regarded as disobedience. No such definition was at the time necessary, for neither in his belief in the existence of sin nor in his conception of its nature did he differ from the great mass of his countrymen. His peculiarity was that he both believed in its universality and made that fact of its universality the basis of his teaching. In the early chapters of the Epistle to the Romans he rests the proof of the fact on an appeal to common experience. But the proof is rather of rhetorical than of logical validity. It was easy in addressing a congregation of Gentiles to point to the general and deep depravity of the society which surrounded them, and in addressing Jews not only to show that they fell short of their own standard, but also to denounce the argument by an appeal to Scripture, which declared that "there is none righteous, no one not" (Ps. xiv. 1; Rom. iii. 10; cf. Gal. iii. 22). But the general prevalence of depravity did not show its universality, and the appeal to Scripture was not convincing to a Gentile. These arguments are not further insisted on, and a more cogent proof is found in the fact of the universality of death; for it was a fixed Jewish belief that "God created man to be immortal" (Wisd. ii. 28), and the fact that all men died showed that all men sinned (Rom. v. 12). Nor was even this proof sufficient. What had to be shown, for the purposes of his further arguments, was not merely that sin was universal but that it was so inevitably. This is done by showing that sin is inseparable from human nature on two grounds, the relation of which to each other is neither clear in itself nor clearly explained by Paul. (1) The one is that mankind as a race were involved in the sin of Adam (Rom. v. 12-19; 1 Cor. xv. 21, 22). "Through the one man's disobedience the many were made sinners" (Rom. v. 19) is

an alternative expression with "through the trespass of the one the many died" (Rom. v. 15). But as to the mode in which the "disobedience" or "trespass" of Adam affected the whole human race no information is given, and the question has been one of the chief puzzles of Christian theology in all ages. It is a point upon which, more than perhaps upon any other, light would be thrown by a fuller knowledge of contemporary Jewish theology (cf. Ecclesiasticus, xxv. 24, "of the woman came the beginning of sin and through her we all die"; the question is complicated by the mention of Adam in 1 Cor. xv. 47 as "of the earth, earthy," and apparently corruptible by virtue of his earthy nature, without reference to his transgression). (2) The second ground is at once more prominent and more intelligible to a modern mind. It is that human nature consists of two elements, and that one of them, as Paul gathered from his own experience, which he took to be identical in this respect with the universal experience of mankind, is constantly suggesting sinful actions. Whether it does so because it is in itself essentially sinful, or because sin has effected a permanent lodgment in it, is a question which has been vigorously debated, and which is the more difficult of solution because some of Paul's expressions appear to favour the former view and some the latter. To this element of human nature he gives the name "flesh," apparently including under it not only the material body but also, and more especially, the affections and desires which spring out of the body, such as love and hate, jealousy and anger; its tendency or "mind" (*φρόνημα*) is always in antagonism at once to the higher element or "spirit" (Gal. v. 17) and to the law of God, so that "they that are in the flesh cannot please God" (Rom. viii. 7, 8).

So far, in his conception of the dualism of human nature, of the inevitable tendency of the lower part to prevail over the higher, and of the consequent universality of wrongdoing, Paul did not differ from the majority of those who have at any time reflected either upon themselves or upon mankind. The idea of sin was common to him with the Stoics. But it was impossible for him to stop where the Stoics stopped, at the exhortation to men to live by the rule of what was highest in them, and so to "follow God." For he was not a philosopher but a theologian; he was not a "citizen of the world" but a "Hebrew of the Hebrews." God had stood to his race in an especially close relation; He had given it a code of laws, and that code of laws was to a Jewish theologian the measure not only of duty but of truth. How was the conception of the universality of sin consistent with the existence of "statutes" and "judgments, which if a man do he shall live in them" (Lev. xviii. 5, quoted in Rom. x. 5; Gal. iii. 12)? That statement of Scripture clearly implied, and most of his countrymen believed, that the perfect observance of the law was possible, and that so a man might be "righteous before God."

It was at this point that he broke off, not only from the majority of his countrymen, but from his own early beliefs. The thought came to him with the overwhelming power of a direct revelation, that the law not only had not been, but could not be, perfectly observed. In one sense he seems to have held even to the end of his life that there was "a righteousness that is in the law" (Phil. iii. 6). But in another and truer sense such a righteousness was impossible. "By the works of the law shall no flesh be justified" (Gal. ii. 16), and that not only in fact but of necessity. For the law went deeper than was commonly supposed.<sup>1</sup> It touched not only the outer but also the inner life, and in doing so it inevitably failed from the very constitution of human nature. The existence in that nature of the "fleshy" element was of itself a constant breach of the law. The "mind," the "inner man," might delight in the law of God, but the "flesh," even if it were not inherently sinful, was in perpetual "captivity to the law of sin." And for this state of things the law had no remedy. On the one hand, it was external to men; it could not give them the force of a new life (*ζωοποιεῖν*, Gal. iii. 21). On the other hand, the flesh was too strong for it (Rom. viii. 3). Its failure had been foreseen and provided for. The blessing of which, before the law, God had spoken to Abraham was to come, not by observance of the law, but as the result of a "promise" on the part of God, and of "faith" on the part of men (Rom. iv. 13-14; Gal. iii. 11-18). And when the question naturally presented itself, Why, if the law was an inevitable and predestined failure, it had been given at all? two answers suggested themselves; the one was that "it was added because of transgressions," i.e., probably to make men's sins and their failure to avoid them more apparent (Gal. iii. 19), since "through the law came the knowledge of sin" (Rom. iii. 20); the other was that the law came in "that the trespass might abound" (Rom. v. 20), and that so "through the commandment sin might

<sup>1</sup> It must be noted that there appears to be a constant interchange in his mind between the conception of the Mosaic law and the ideal conception of law in the abstract; but it is difficult to maintain that the two conceptions may always be distinguished by the presence or absence of the Greek article. 1 Cor. ix. 20, Phil. iii. 5, seem of themselves sufficient to make such a distinction untenable, but the contrary view is maintained in an excellent discussion of the point by Dr. Gifford, "Introduction to the Epistle to the Romans," p. 41 sq., in the *Speaker's Commentary on the New Testament*.



become exceeding sinful" (Rom. vii. 13; so 1 Cor. xv. 56, "the strength of sin is the law"). It was consequently a jailer and "tutor," keeping men under restraint and discipline, until they were ready for that which God had purposed to give them in due time (Gal. iii. 23, 24).

For "in due season, when the fulness of the time was come, God sent forth His Son," "in the likeness of sinful flesh and for sin," to do that which "the law could not do" (Rom. v. 6, viii. 3; Gal. iv. 4). This was a "free gift" of God (Rom. iii. 24, v. 15). The constant expression for it, and for the sun of the blessings which flow from it, is "grace" or "favour" (*χάρις*), a term which was already becoming specialized in an analogous sense in Hellenistic Greek (e.g., Wisd. iii. 9, iv. 15, "grace and mercy is to His saints"; Philo, vol. i. p. 102, ed. Mang., "the beginning of creation . . . is the goodness and grace of God"). Two corollaries followed from it; in the first place, the law, having failed, was superseded, and, so far from the performance of its requirements being necessary to ensure peace with God, "if ye receive circumcision, Christ will profit you nothing" (Gal. v. 2); in the second place, the distinction between Jew and Gentile was abolished "for ye are all one in Christ Jesus" (Gal. iii. 28).

This was "the gospel of the grace of God" (Acts xx. 24), which it was his special mission to preach; he speaks of it sometimes as "my gospel" (Rom. ii. 16, xvi. 25), or the "gospel of the uncircumcision" (Gal. ii. 7), as well as in a special sense "the gospel of God" (Rom. i. 1, xv. 16; 2 Cor. xi. 7; 1 Thess. ii. 2, 8, 9), or "the gospel of Christ" (Rom. i. 9, xv. 19; 1 Cor. ix. 12, 18; 2 Cor. ii. 12, ix. 13, x. 14; Gal. i. 7; Phil. i. 27; 1 Thess. iii. 2; 2 Thess. i. 8), or "the gospel of the glory of Christ" (2 Cor. iv. 4); and elsewhere he speaks of it as his special "secret" or "mystery" (Rom. xvi. 25; 1 Cor. ii. 1 [Codd. M, A, C], and more emphatically in the later epistles, Eph. i. 9, iii. 3-9, vi. 19, Col. i. 26, 27; iv. 3).

Of this gospel Christ is the beginning and the end: theology and Christology are blended into one. Sometimes He is represented as having been "sent forth" (Rom. viii. 3), or "set forth" (Rom. iii. 25), or "given up" (Rom. viii. 32), by God; sometimes, on the other hand, it is said that He "gave Himself" (Gal. i. 4), or "gave Himself up" (Gal. ii. 20; Eph. v. 2), or "made Himself poor" (2 Cor. viii. 9), or "emptied Himself" (Phil. ii. 7-8). The act by which He accomplished what He designed or was designed to do was His death on the cross (Rom. v. 6, 8, vi. 10, viii. 34, xiv. 15; 1 Cor. viii. 11, xv. 8; 2 Cor. v. 14, 15; Gal. ii. 21; 1 Thess. v. 10). The "blood" of Christ (Rom. iii. 25, v. 9; 1 Cor. xi. 25; Eph. i. 7, ii. 13; Col. i. [14], 20), the "cross" of Christ (1 Cor. i. 17; Gal. v. 11, vi. 12, 14; Phil. ii. 8, iii. 18; Eph. ii. 16; Col. i. 20, ii. 14), "Christ crucified" (1 Cor. i. 23, ii. 2; Gal. iii. 1), are therefore used as concise symbolical expressions for His entire work.<sup>1</sup> The act by which the completion of that work was ratified and made manifest was His resurrection from the dead (Rom. i. 4; cf. Acts xiii. 33, 34, xvii. 31); hence "He was delivered up for our offences and raised again for our justification" (Rom. iv. 25). The resurrection is thus the guarantee of the truth of the gospel; without it there is no certainty that God has forgiven us; "if Christ be not risen then is our preaching vain, and your faith is also vain" (1 Cor. xv. 14). What quality there was in the death of Christ which gave it efficacy is probably indicated in Rom. v. 19, Phil. ii. 8, where it is spoken of as an act of "obedience." The precise force of the expressions, "being made a curse for us" (Gal. iii. 13), "He made Him to be sin for us" (2 Cor. v. 21), which probably also refer to the efficacious quality of the death of Christ, is less obvious.

The death of Christ was a death on our behalf (*ὄντις ἡμῶν*, Rom. v. 6, 8, viii. 32, xiv. 15; 1 Cor. i. 13 [Codd. M, A, C] [v. 7], xi. 24; 2 Cor. v. 15; Gal. ii. 20, iii. 13; 1 Thess. v. 10 [Codd. M, B]; cf. Eph. v. 25), or on behalf of our sins (1 Cor. xv. 8; Gal. i. 4 [Cod. B]), or on our account (*ὑπὲρ ἡμῶν*, 1 Cor. i. 13 [Codd. B, D]; 1 Thess. v. 10 [Codd. A, D]), or on account of our sins (Gal. i. 4 [Codd. M, A, D]), or of sin in general (Rom. viii. 3), or because of us or our transgressions (*διὰ τὰ ἁμαρτήματα, δι' ἡμῶν*, Rom. iv. 25; 1 Cor. viii. 11; cf. 2 Cor. viii. 9). These general expressions are expanded into more explicit statements in various ways; for the nature of the work which the death of Christ effected was capable of being regarded from several points of view, nor was any one metaphor or form of words adequate to express all its relations either to God or to mankind.

(1) The nature of Christ's work is sometimes expressed in language which is relative to the idea of sacrifice; and it is conceivable that, if the contemporary conception of sacrifice were better known to us, most of the other expressions would be found to be relative to the ideas which were connected by that of sacrifice (1 Cor. v. 7, "Christ our passover is sacrificed" [some MSS. add "for us"]; the uncertain expression *θυσία*, Rom. iii. 25, probably belongs to

the same group of ideas; the expressions with *ὄντις* and *ὑπὲρ*, which have been quoted above, are sometimes regarded as being in all cases primarily sacrificial).

(2) It is sometimes expressed in language which is relative to the conception of sin as rebellion or enmity against God; what God effected through Christ was a reconciliation (*καταλλαγή*, Rom. v. 10, 11; 2 Cor. v. 18, 19), or peace (Rom. v. 1; Eph. ii. 14; hence the special force of the salutation "Grace to you and peace from God," which is prefixed to every epistle).

(3) It is sometimes expressed in language which is relative to the idea of deliverance or "salvation" (*σῶσθαι, σωτηρία*, Rom. i. 16, v. 9, and in all the epistles; *ἰσχυρότης*, Rom. iii. 24; 1 Cor. i. 30; Eph. i. 7; Col. i. 14). The idea was originally Messianic, and referred to national deliverance from foreign oppression; but it had been raised into a higher sphere of thought, that from which men are saved being conceived to be the "wrath" of God, i.e., His punishment of sin (Rom. v. 9).

(4) It is sometimes expressed in language which is relative to the idea of purchasing a slave (1 Cor. vi. 20, vii. 23, and probably Rom. xiv. 8, 9). That to which men were in bondage was the law (Gal. iv. 5), which cursed those who did not fully obey it (Gal. iii. 10, 13), or the "elements of the universe" (Gal. iv. 3, 9), i.e., the sun and stars and other material things (cf. Wisd. xiii. 2), which are spoken of in a later epistle as "principalities and powers" over which Christ "triumphed" by rising from the dead (Col. ii. 15). Hence, probably, Paul's own description of himself as the "slave of Jesus Christ" (Rom. i. 1).

(5) It is sometimes expressed in language which is relative to the conception of God as the supreme lawgiver and judge. Sin is regarded as affording ground for a charge (*ἐγκλημα*, cf. Rom. viii. 33) against the sinner, and, sin being universal, all the world was liable to the judgment of God (Rom. iii. 19). But it was possible for the Judge, for certain reasons which He considered valid, i.e., on account of the sufficient exhibition or declaration of His righteousness in the death of Christ, not to take account of the offences charged, but to acquit (*δικαιῶν*) instead of pronouncing sentence of condemnation; by this acquittal the person acquitted was placed in the position of one against whom no charge existed (*δικαίως κατασθῆναι*, Rom. v. 19); and, since the acquittal might be regarded in its different relations as a consequence of either the favour of God, or the death of Christ, or the trust in God which made it valid for the individual, men are said in various passages to be acquitted by God's favour (Rom. iii. 24), or by the blood of Christ (Rom. v. 9; cf. Gal. ii. 17), or by faith (Rom. iii. 28, v. 1; Gal. iii. 8, 24).

(6) It is sometimes expressed in language which is relative to the conception of a mystical union between Christ and the human race, or part of it, of such a kind that when He died men also died, and that when He rose again they also rose with Him (Rom. vi. 3-10; Gal. ii. 20; and also in the later epistles, Eph. ii. 5, 6; Col. ii. 12, iii. 8).

Some of these expressions are occasionally combined; for example, the ideas of acquittal and reconciliation (Rom. v. 1; 2 Cor. v. 19), those of acquittal and deliverance (Rom. v. 9), and those of sacrifice, in which Christ is conceived as dying on men's behalf, and of mystical union in which they die with Him (2 Cor. v. 14). The facts both of their variety and of their combination afford a strong argument against treating any one mode of expression as though it stood alone and gathered up into a single metaphor the whole of the new relations of God to men.

The effect of Christ's work upon mankind is also expressed in various ways. Sometimes it is expressed under the form of an imparted attribute, sometimes under that of a new condition of life or a new relation to God. It is most frequently spoken of as (1) righteousness, or (2) life, or (3) sonship. (1) When spoken of as righteousness, it is sometimes said to have been given to men (Rom. v. 17); sometimes it is reckoned to them or placed to their account (Rom. iv. 6, 11; Gal. iii. 6); sometimes it is a power to which they have become, or ought to become, subject (Rom. vi. 13, x. 3); sometimes it is regarded as a quality which men already possess by virtue of Christ's death (Rom. v. 17); sometimes it is still to be attained (Rom. iv. 24, vi. 16; Gal. v. 5). (2) When spoken of as life, the conception also seems to vary between that of a life which men have already received, or into which they have already entered (Rom. vi. 4, viii. 10), and that of a life which is future (Rom. v. 17; Gal. vi. 8; cf. Col. iii. 3, 4), where it is conceived as being now

<sup>1</sup> This word seems to have lost its etymological sense of "ransoming" and to have connoted only "deliverance," e.g., in the LXX., Dan. iv. 20 (31). Nebuchadnezzar speaks of *ὁ χάρις τῆς ἀπολυτρώσεως μου*, "the time of my deliverance"; in Irenæus, i. 9, 5, it is used of the dismissal of the spectators in a theatre.

<sup>2</sup> It is difficult to estimate the mischief which has been caused by the notion that justification was adopted from early times as the translation of *δικαιῶν*, and the consequent fact that a large part of Western theology has been based upon the etymological signification of justification rather than upon the meaning of its Greek original. One of the earliest instances of the meaning of *δικαιῶν* in Biblical Greek is LXX. Exod. xxiii. 7, *ὅτι δικαιοῦσαι τὸν ἀσεβῆ ἕνεκεν θύρου*, "thou shalt not acquit the wicked man for bribes."

<sup>1</sup> This view of the place of the death of Christ in the economy of redemption is so constant and integral a part of Paul's teaching as to outweigh and set aside the inferences which some writers have drawn from Rom. viii. 3, that the "sending" Christ—i.e., His incarnation—was itself sufficient for the end in view.

"hid with Christ in God," to be manifested at His coming; and similarly sometimes men are regarded as having already died with Christ (Rom. vi. 6-11), and sometimes the Christian's life is regarded as a prolonged act of dying in the "mortification" of the "deeds of the body" (Rom. viii. 13; cf. Col. iii. 5). (3) When spoken of as sonship, the conception also varies between that of a perfected and that of a still future "adoption"; on the one hand "we have received a spirit of adoption" (Rom. viii. 15), so that we are "all sons of God through faith in Christ Jesus" (Gal. iii. 26), and on the other hand we are still "waiting for the adoption, the deliverance of our body" (Rom. viii. 23).

For, although Christ died for all men (Rom. v. 18; 2 Cor. v. 14, 15; so in the pastoral epistles, 1 Tim. ii. 4, 6; Tit. ii. 11), it does not therefore follow that all men are at once in full possession of the benefits which His death made possible to them. Their righteousness or life or sonship is rather potential than actual. It becomes actual by the co-operation of their own mind and will, that is, by the continuous existence in them of the state of mind called trust or "faith."<sup>1</sup> For this view of the place of trust or "faith" St Paul finds support, and may perhaps have found the original suggestion, in the Old Testament. Abraham had believed that God both could and would perform His promises, and this belief "was counted to him as righteousness" (Gen. xv. 6; Rom. iv. 3; Gal. iii. 6); Habakkuk had proclaimed that "the just shall live as a consequence of his faith" (Hab. ii. 4; Rom. i. 17; Gal. iii. 11); and another prophet had said, "whosoever believeth in Him shall not be put to shame" (Rom. ix. 33, x. 11). The object of this trust or faith is variously stated to be "Him that raised Jesus our Lord from the dead" (Rom. iv. 24; x. 9), "Him that justifieth the ungodly" (Rom. iv. 5), or "Jesus Christ" (Rom. iii. 22; Gal. ii. 16, etc.), or His "blood" (Rom. iii. 25 probably). Hence the statement, that the gospel is "the power of God unto salvation," is limited by the condition "to every one that believeth" (Rom. i. 16). Hence, also, since this state of mind is that by which the death of Christ becomes of value to the individual, while he is said on the one hand to be acquitted or justified by Christ's blood (Rom. v. 9), he is said on the other hand to be acquitted or justified as a result of his faith (Rom. v. 1). Hence, also, the new relation of "righteousness" in which men stand to God,—while on the one hand it is "God's righteousness," as being a relation which is established by His favour and not by their merit (Rom. i. 17, iii. 21, 22, v. 17), it is on the other hand a "righteousness which results from faith" (*ἐκ πίστεως δικαιοσύνη*, Rom. x. 6). From another point of view it is an act of obedience or state of submission (Rom. i. 5, vi. 16, 17, x. 16, xvi. 19, 26; 2 Cor. x. 5, 6), being the acceptance by men of God's free gift as distinguished from "seeking to establish their own righteousness," i. e., to attain to a freedom from sin which their fleshly nature renders impossible (Rom. x. 3).

It is obvious that such a doctrine as that of acquittal from the guilt of wrongdoing by virtue of an act or state of mind, instead of by virtue of a course of conduct, is "antinomian," not merely in the sense that it supersedes the law of Moses, but also because it appears to supersede the natural law of morality. It was no wonder that some men should infer, and even attribute to Paul himself the inference, "Let us do evil that good may come" (Rom. iii. 8). The objection was no doubt felt to be real, inasmuch as it is more than once stated and receives more than one answer. (1) One of the answers which Paul gives to it (Rom. vi. 15 sq.) is due to his conception of both sin and righteousness as external forces. He had regarded sinful acts as the effects of the dominion of a real power residing within men and compelling them to do its will. He now points out that, to those who believe, this dominion is at an end. The believer is not only acquitted from the guilt of sin, but also emancipated from its slavery. He has become a slave to righteousness or to God (Rom. vi. 18, 22). This is stated partly as a fact and partly as a ground of obligation (Rom. vi. 18, 19); and the disregard of the obligation, or "building up again those things which I destroyed," brings a man again under the cognizance of God's law as a transgressor (Gal. ii. 18). (2) Another answer is due to the conception which has been mentioned above of the mystical union between Christ and mankind. This also is stated partly as a fact and partly as a ground of obligation. In one sense the believer has already died with Christ and risen with Him: "our old man was crucified with Him" (Rom. vi. 6), "they that are Christ's have crucified the flesh" (Gal. v. 24), "the life which I now live in the flesh I live in faith, the faith in the Son of God, who loved me and gave Himself for me" (Gal. ii. 20); so that on the one hand Christ is said to be in the believer (2 Cor. xiii. 5), and on the other hand the believer is said to be "in Christ." Whoever mode of conceiving the Christian life be adopted, a life of sin is impossible to it: "if any man be in Christ, he is a new creature" (2 Cor. v. 17), and the "new man" which thus comes

into being "is created after God in righteousness and true holiness" (Eph. iv. 24). In another sense this mystical dying with Christ and living with Him is rather an ideal towards which the believer must be continually striving; it affords a motive for his resisting the tendency to sin: "reckon ye also yourselves to be dead indeed unto sin, but alive unto God in Christ Jesus our Lord; let not sin therefore reign in your mortal body" (Rom. vi. 11, 12). (3) A third answer, which, though less directly given, is even more constantly implied, is that faith is followed by, if it be not coincident with, an immediate operation of God upon the soul which becomes for it a new moral power. For, although in the "natural man" there is an element, "the flesh," over which sin has such an especial dominion as to be said to dwell in it, there is also another element, the "mind" (*νοῦς*), or "spirit" (*πνεῦμα*), or "inner man" (*ὁ ἐνὶ καρδίᾳ*), which is the slave, not of the "law of sin," but of the "law of God."<sup>2</sup> Against this the flesh wages a successful war and "brings it into captivity to the law of sin" (Rom. vii. 22-25). The result is that the mind may become "reprobate" (*ἀδόκιμος*, Rom. i. 28; cf. Col. ii. 18, where the "mind" is so completely under the dominion of the flesh as to be called "the mind of the flesh"), or it may become defiled and ultimately lost (2 Cor. vii. 1; 1 Cor. v. 5). It is upon this part of man's nature that God works. By means of faith (Gal. iii. 14), or as a result of faith (Gal. iii. 2, v. 5), God gives and men receive His own Spirit (1 Thes. iv. 8) or the Spirit of Christ (Rom. vii. 10; Gal. iv. 6; Phil. i. 19). Sometimes the Spirit of God is said to "dwell in" them (Rom. viii. 9; 1 Cor. iii. 16), and once the closeness of the union is expressed by the still stronger metaphor of a marriage: "he that is joined to the Lord is one spirit" (1 Cor. vi. 17). This indwelling of, or union with, the Spirit is for the believer a new life; Christ has become for him "a life-giving spirit" (1 Cor. xv. 45); this is a fact of his spiritual nature which will in due time be manifest even in the quickening of his mortal body (Rom. viii. 11), but in the meantime it becomes, like the facts of emancipation from sin and of union with Christ, a ground of moral obligation. "If we live by the Spirit, by the Spirit also let us walk" (Gal. v. 25); and the freedom from spiritual death is conditional on the "mortifying of the deeds of the body" (Rom. viii. 13).

It will be evident that, although Paul nowhere defines his conception of faith, he did not conceive it as a mere intellectual assent; it was a complete self-surrender to God (Gal. ii. 20), and on its human side it showed its activity in the great ethical principle of "love," which is the sum of a man's duties to his fellow-men (Gal. v. 6, 14).

But, as his conception of the effects of Christ's death, and of the nature of faith by which these effects are appropriated by the individual, has, so far as the present life is concerned, chiefly a moral aspect, and connects itself with practical duties, so, on the other hand, it comprehends the whole physical and spiritual being of man, and connects itself with his eschatology. The resurrection of Christ is not merely the type of moral resurrection from sin to holiness, but at once the type and the cause and the pledge of the actual resurrection of the body. "If we believe that Jesus died and rose again, even so them also that are fallen asleep in Jesus will God bring with Him" (1 Thes. iv. 14); "He which raised up the Lord Jesus shall raise up us also with Jesus" (2 Cor. iv. 14); "if we died with Christ, we believe that we shall also live with Him" (Rom. vi. 8). Sometimes the new life of the body is viewed in relation to the mystical union of the believer with Christ: "we which live are always delivered unto death for Jesus' sake, that the life also of Jesus may be manifested in our mortal flesh" (2 Cor. iv. 11); and it follows from the conception of the "last Adam" as a "life-giving spirit" that, "as we have borne the image of the earthy, we shall also bear the image of the heavenly" (1 Cor. xv. 49; this will follow from the context, even if with most uncial MSS. we read "let us also bear"). Sometimes this new life is viewed as a result of the present indwelling of the Spirit: "if the Spirit of Him that raised up Jesus from the dead dwelleth in you, He that raised up Christ Jesus from the dead shall also quicken your mortal bodies through" (or "because of") "His Spirit that dwelleth in you" (Rom. viii. 11). This redemption or deliverance of the body from the "bondage of corruption" is the completion of the "adoption," "the liberty of the glory of the children of God" (Rom. viii. 21, 23); but the nature of the new body is not clearly explained. Sometimes the language seems to imply that this mortal body will be "quickened" or "transformed" (Rom. viii. 11; Phil. iii. 21), and the analogy afforded is that of a seed which after being buried reappears in a new form (1 Cor. xv. 36, 37); sometimes, on the

<sup>2</sup> The relation of *νοῦς* to *πνεῦμα* has been much discussed; among contemporary theologians Holsten and Weiss deny the existence of a *πνεῦμα* in the natural man, Lidemann and Pfeiderer allow it. It is certain that the two words are used in the same sense by Philo; and it is most probable that they are also so used by Paul. One of many proofs is that in quoting Isa. xl. 14 in 1 Cor. ii. 15 he adopts *νοῦς* from the LXX. as the translation of [N] (whereas *πνεῦμα* is the more usual translation), and proceeds to use the phrase *νοῦς Χριστοῦ* for *πνεῦμα Χριστοῦ*, which the argument requires, and with which it must be identical.

<sup>1</sup> "Faith" is not defined by Paul, but his use of the term so nearly resembles Philo's as to be explicable by it. With Philo it is the highest form of intellectual conviction, being more certain than either that which comes from the senses or that which comes from reasoning; cf., e.g., *De promissis et poenitentia*, §. 8, vol. ii. p. 412, ed. Manz.

other hand, it seems to be implied that the earthly body will be dissolved, and that what awaits us is a new body, "a building of God, a house not made with hands, eternal in the heavens" (2 Cor. v. 1).

This change will come to all believers at the "advent" (*παρουσία*, 1 Cor. [i. 9, Cod. D.] xv. 23; 1 Thes. ii. 19, &c.), or "revelation" (*ἀποκάλυψις*, 1 Cor. i. 7; 2 Thes. i. 7), or "manifestation" (*ἐπιφάνεια*, 2 Thes. i. 8, and afterwards in the pastoral epistles) of Jesus Christ. Some of them will have "fallen asleep in Christ," in which state he seems to conceive that they are "at home with the Lord" (2 Cor. v. 8); and others, among whom, in the language of confident hope, he includes himself, will be still alive (1 Thes. iv. 15-17). For "the day of our Lord Jesus Christ" (1 Cor. i. 8, v. 5; 2 Cor. i. 14, &c.) was conceived to be not far distant: "the night is far spent, the day is at hand" (Rom. xiii. 12), and "the mystery of lawlessness," which was to be revealed before that day could come, was already at work (2 Thes. ii. 8-7). But the "day" itself is variously conceived; sometimes the eternal life of believers in and with Christ appears to begin at the very moment of the Advent (1 Thes. iv. 17), and hence the day is spoken of as "the day of deliverance" (Eph. iv. 30); but more frequently "the day of the Lord" is also the day of judgment (Rom. ii. 5, 16), according to the eschatological ideas which had for some time been current among the Jews; in it all men, believers and unbelievers alike, are represented as standing before the judgment-seat of God (Rom. xiv. 10) or of Christ (2 Cor. v. 10) to give account of themselves to God, and to receive the reward of the things done in the body, whether good or evil. There is a similar variety of view in regard to what will happen after the Advent. The language which is used sometimes leads to the inference that the destruction of the enemies of the cross will be immediately effected (2 Thes. i. 9, ii. 8), and sometimes to the inference, which was also in accordance with current eschatological ideas, that there will be a Messianic reign, during which Christ will "put all enemies under His feet" (1 Cor. xv. 25). And, while in some passages unbelievers or evildoers are said to be punished with "eternal destruction from the face of the Lord" (2 Thes. i. 9; cf. Rom. ii. 8, 9), the view elsewhere seems to be that "in Christ shall all be made alive," the universality of the life in Christ being coextensive with the universality of the death in Adam (1 Cor. xv. 22).

It is difficult to reconcile these conceptions with one another, and still more so to reconcile some of them with other parts of Paul's doctrine of salvation, except perhaps on the hypothesis that even after his conversion many of the apocalyptic ideas which were current among his countrymen remained in his mind; this hypothesis is made the more probable by the fact that in the later and the probably post-Pauline epistles the apocalyptic elements are rare, and that the most definite eschatological statement which they contain is in full harmony with the conception of the believer's mystical union with Christ, "when Christ, who is our life, shall appear, then shall ye also appear with Him in glory" (Col. iii. 4).

Such are the main elements of Paul's soteriology. To most of the philosophical questions which have since been raised in connexion with it he neither gives nor implies an answer. It is possible that many of such questions did not even suggest themselves to him. The chief of all of them, that of the necessity of sacrifice, was probably axiomatic to a Jewish mind, and its place in Paul's system must be accepted with all the difficulties which such an acceptance involves. But there is one such philosophical question which even in Paul's time had begun to have a fascination for Oriental thinkers. What is the relation of free will to God? or in other words, Is what men do the result of their own choice, or is it determined for them; and, if it is determined for them, how can God punish them as though they had been free (Rom. iii. 5, ix. 19)? The answer is given in the form of an antinomy, of which the thesis is the sovereignty of God and the antithesis the responsibility of men. The sovereignty of God is absolute. Instead of entertaining the objection which has since been raised, that God, having created rational and moral agents, has placed Himself under an obligation to deal with them as such, he makes the dependence of men upon God to be unconditional, and the alleged rights of men as against God to be as non-existent as those of an earthenware vessel against the potter who has given it shape (Rom. ix. 20-21). Some men are "vessels of wrath fitted unto destruction," some are "vessels of mercy . . . prepared unto glory" (Rom. ix. 22, 23); and God's dealings with them are as little conditioned by necessity as His original creation of them: "He hath mercy on whom He will, and whom He will He hardeneth" (Rom. ix. 18). But, over against this view of God's sovereignty, and without any endeavour to reconcile the difficulties which suggest themselves, he places the fact of human responsibility. The purpose of God worked itself out in history, but not without men's co-operation. He had first "called" the Jews; and though, on the one hand, "God gave them a spirit of stupor, eyes that they should not see, and ears that they should not hear" (Rom. xi. 8), yet, on the other hand, they were "a disobedient and gainsaying people" (Rom. x. 21), "seeking to establish their own righteousness," and not subjecting themselves

"to the righteousness of God" (Rom. x. 3). God had now carried out another part of His purpose. He had "called" the Gentiles. In the earlier epistles Paul spoke of this calling as having been not only part of God's purpose, but also expressly announced from time to time by the prophets (Rom. ix. 25, 26, x. 20); but in the doubtful later epistles it is spoken of as a "mystery which hath been hidden from all ages and generations" (Col. i. 26), but now had been "made known through the church" "unto the principalities and the powers in the heavenly places" (Eph. iii. 9, 10). But as with the Jews so with the Gentiles, the divine call was not only a fact but also a ground of obligation. While, on the one hand, "we are His workmanship, created in Christ Jesus for good works, which God afore prepared that we should walk in them" (Eph. ii. 10), yet, on the other hand, the Ephesians are entreated to "walk worthily of the calling wherewith ye were called" (Eph. iv. 1). In the Epistle to the Romans a still further part of God's purpose is indicated. The salvation which had come to the Gentiles by the fall of the Jews was "to provoke them to jealousy" (xi. 11); as in time past the Gentiles "were disobedient to God but now have obtained mercy" by the disobedience of the Jews, "even so have these also now been disobedient, that by the mercy shown to you they also may now obtain mercy" (xi. 30, 31). And so not only would "the fulness of the Gentiles come in," but also "all Israel shall be saved" (xi. 25, 26); "for God hath shut up all unto disobedience that He might have mercy upon all" (xi. 32).

But, just as the apparent fatalism of the theory of absolute predestination without reference to works stands side by side with the obligation of men to "work out their own salvation with fear and trembling" (Phil. ii. 12), so this apparent universalism stands side by side with the fact that all men do not receive the gospel. Out of the mass of men some, whether Jews or Gentiles, are "called." They constitute a separate class. As from one point of view they are the "called according to God's purpose" (Rom. viii. 28), or "called to be saints" (Rom. i. 7; 1 Cor. i. 2), or simply "called" (1 Cor. i. 24; it is to be noted that the expression does not occur in the later epistles), or "chosen" (Rom. viii. 33; Col. iii. 12), so, on the other hand, they are "they that believe" (Rom. iii. 23; 1 Cor. i. 21, xiv. 22; Gal. iii. 22; Eph. i. 19; 1 Thes. i. 7, ii. 10, 13; 2 Thes. i. 10); the call and the belief are complementary of each other, and therefore the terms are used as convertible (1 Cor. i. 21, 24). But the more frequent terms are those which came to Paul from his earlier associations. The Jews had known one another, and had spoken of themselves, in contrast to the rest of the world, as "brethren" (*εἰς*, Deut. xv. 12, xvii. 15; Philo, ii. 285, ed. Mang.) or "saints" (*εἰς*, Deut. xxiii. 8; Dan. vii. 21). Paul applies these terms to the new "people of God"; they are "brethren" (*εἰς*, Rom. i. 13, most commonly as a term of address), and "the saints" (*εἰς*, Rom. xii. 13, xv. 25; 1 Cor. vi. 1). As such they are regarded as forming collectively a unity or society, which Paul, adopting a current Latinism, calls a "body" (*σῶμα* is frequently used in this sense; *σῶμα* is its Hellenistic translation in, *εἰς*, the letter of Mark Antony in Joseph, *Ant. Jud.*, iv. 12, 3, *τὸ σῶμα τῆς Ἀσίας σῶμα*). A more important and permanent application of the view that those who believed in Jesus took the place of the Jews, and stood to God in the same special relation in which the Jews had stood, was the use of the term "congregation" or "assembly" (*ἑβρ. קהלה*, which the LXX. renders by both *ἐκκλησία* and *ἐκκλησία*; in the Epistle of James (ii. 2) the former of these words is used of a particular Christian congregation; Paul uses the latter only, and the English translators render it invariably by "church") to designate the mass of believers regarded as a unity. The use of the word *ἐκκλησία* in this sense in the undisputed epistles is rare,—probably only in 1 Cor. xv. 9, Gal. i. 18, in each of which passages it is qualified, as in, *εἰς*, Deut. xxiii. 1, Nehem. xiii. 1, as "God's congregation." But either towards the end of his life, or, according to many modern critics, only among his followers after his death, this conception of Christians as forming a congregation was idealized. The common metaphor of a "body" by which that congregation had been designated, and which had already been elaborated as indicative of the diversity of parts and functions in the several Christian communities (1 Cor. xii. 12-30), is elaborated in the Epistles to the Ephesians and Colossians as indicative of the relation of the aggregate of believers to Christ. They are conceived, not as forming a society which bears Christ's name, but as bearing to Him partly the relation which the several members of an organized body bear to the head (Eph. i. 22, iv. 15, 16; Col. i. 18, 24), and partly the relation of a wife to a husband (Eph. v. 22-33). In a phrase of difficult and doubtful meaning the congregation of Christians, or "church," is spoken of as His "fulness" (*πληροῦμα*, Eph. i. 23), and the progress in Christian virtues is represented partly as the growth of an organism to its full stature (Eph. iv. 14-16; Col. ii. 19), and partly as the filling out or realization of that which is empty or imperfect (Eph. iii. 19; Col. i. 9).

Side by side with this conception of the "called" or "saints" as collectively forming a "body" or "congregation," which was the Christian counterpart and fulfilment of the Jewish "congre-

gation," was the fact that wherever the gospel was preached, especially in the great cities of the empire, the converts tended to form communities. Such communities, whether for religious or non-religious purposes, were among the commonest phenomena of the age. How far Paul himself encouraged the formation of such communities among his converts is uncertain; but many considerations lead to the inference that where they were so formed they were formed rather upon the Gentile than upon the Jewish model. Out of several names which were in current use to designate them, that which Paul used was common to both Gentile and Jewish communities, and it was also that which he continued to use in another sense to designate the whole body of Christians. Hence has arisen the confusion which pervades almost all Christian literature between the use of the word *ἐκκλησία*, or "church," to denote the whole multitude of those who will be saved regarded as an ideal aggregate, and the use of the same word to denote a visible community of professing Christians in any one place or country.

The *raison d'être* of these communities was mutual help in the spiritual, the moral, and the outward life. Every member of a community had received the new life of the Spirit, and the diversities of character and opportunity which exist between man and man were conceived as diversities of manifestation (*φανέρωσις*) of the Spirit who lived within them, or, from another point of view, as diversities of gifts (*χαρίσματα*). "But to each one was given the manifestation of the Spirit to profit withal" (1 Cor. xii. 7). When the community met in assembly some of its members "prophesied," preaching as though with a divine inspiration; some spoke in such ecstasy that their words seemed to be those of an unknown tongue and needed an interpreter; some taught again the lessons which they had learned from Paul; some had "a psalm"; some had "a revelation" (1 Cor. xiv. 26 sq.). Sometimes the aim was rather moral than spiritual "edification." They exhorted one another, and "admonished" one another (Rom. xv. 14). Sometimes on points of practice they carried this "judging" of one another farther than Paul approved. The Christian liberty, which was no less a bond of union than the recognition of the new Christian law, was in danger of being overthrown; and more than once Paul thought it necessary to insist that they should not judge one another any more, but rather strive not to put a stumbling-block in each other's way (Rom. xiv. 10 sq.; 1 Cor. x. 25 sq.). If, however, the offence of any member were gross and open, the assembly became a court of discipline. To the community at Corinth, which had been slow to recognize the necessity of being thus "children of God without blemish in the midst of a crooked and perverse generation," Paul wrote peremptorily "not to keep company, if any man that is called a brother be a fornicator, or covetous, or an idolater, or a reviler, or a drunkard, or an extortioner" (1 Cor. v. 11). In one flagrant case they were bidden to "put away the wicked man from among themselves" (1 Cor. v. 13); but the right of the community to deal with such cases at their discretion was also recognized; for, when the guilty person had on his repentance been forgiven, or punished with a lesser punishment, instead of being expelled, Paul wrote again that the action of the majority was sufficient and had his approval (2 Cor. ii. 6-10). But all such action was subordinated to the general rule, which is repeated in many forms, "let all that ye do be done in love" (1 Cor. xvi. 14). A not less prominent aim of these communities was mutual help in the material and outward life. Some of their members were necessitous or sick; and the duty of helping all such was discharged partly by giving contributions to the common fund and partly by distributing it. Sometimes also the members of other communities came as strangers, travelling as men did, "*quorum copiosius sanumque suspelles*" (Juvenal, iii. 14, of Jews). For such men, who probably brought, as in later times, letters of recommendation from one community to another (2 Cor. iii. 1), there was an ungrudging hospitality; and not long afterwards, if not in Paul's own time, it was a necessary qualification for a widow who wished to be placed as such on the roll of the community that she should not only have "used hospitality" but also herself have "washed the feet" of the tired travellers as they came in (1 Tim. v. 10). In Thessalonica, where the community was probably both poor and small, it seems probable that the members worked together at common trades, making contributions to a common fund and sharing a common table. It was natural that some should presume on the goodness of their brethren, and try to share the latter without making contributions to the former. Paul made a special rule that this should not be the case, and he himself, though he had the right to exemption, yet, for the sake of example, would not "eat bread for nought at any man's hand, but in labour and travail worked night and day" that he might not burden the slender resources of the brethren (2 Thess. iii. 8; 1 Thess. ii. 9).

In such communities, where the "gift" of each member was used for the common good, organization had not the importance which it had in an ordinary secular society. All work which the members of the community did for one another, including that which was done by the apostle himself, was a "ministry" (*διακονία*), and every one who did such work was, so far forth, a "minister" (*διδάσκων*). The

names which ultimately came to be appropriated by special officers, appointed to do delegated work, were at first common to the whole body of members. As is natural in all communities, there were some who devoted themselves to the work with especial zeal; and the most rudimentary form of organization is found at Thessalonica, where certain persons are spoken of as devoting themselves to the special works of "labouring," i. e., probably attending to the material needs of the poorer brethren, "admonishing," i. e., probably bringing back erring brethren to the right way, and "presiding," or more probably (though the word is of uncertain meaning) "acting as protector," like a Roman "patronus," against oppression from without. The community are enjoined to recognize such persons, "and to esteem them very highly in love for their work's sake" (1 Thess. v. 12, 13). In a similar way at Corinth, where the democratic character of the community is even more apparent, Paul beseeches the brethren to "be in subjection" to those who had "set themselves to minister unto the saints" (1 Cor. xvi. 15, 16). But this recognition of the special zeal of certain members was very far from being a recognition or appointment of officers as such. The functions which came in time to be regarded as giving those who discharged them an exceptional status, were only regarded as "gifts," resembling in kind and not surpassing in excellence those of the other members of the community. In the Epistle to the Romans, "he that ruleth" (or "protecteth") is in the same rank as "he that giveth" and "he that exhorteth" (Rom. xii. 8); and in the First Epistle to the Corinthians "helps" and "governments" are not prominent above "miracles," "healings," and "divers kinds of tongues" (1 Cor. xii. 28). It is not until the later period, and probably also the different circumstances, of the Epistle to the Philippians that officers are found with definite titles, and probably also with a distinct status; Paul there writes "to all the saints . . . with the bishops and deacons" (Phil. i. 1). Still later, in the Epistle to the Ephesians, it seems probable that those who are spoken of as "apostles," "prophets," "evangelists," "pastors and teachers," are distinct from the great body of the community (Eph. iv. 11, 12). But it is to be noted that in no certainly authentic epistle does Paul make any mention of "presbyters." The view of Grotius and Vitringe that the "church" took the place of the "synagogue" seems, as far as the Pauline communities are concerned, to have little foundation. Those communities had a much closer resemblance to the Greek and Roman associations in the midst of which they grew; they stood side by side with the Jewish communities, but distinct from them, as "the churches of the Gentiles" (Rom. xvi. 4).

Admission to the community, or at least to full membership of the community, seems to have been effected by the rite of baptism: "in one spirit were we all baptized into one body" (1 Cor. xii. 13). So important was this form of admission conceived to be that when a believer died before baptism another appears to have been baptized vicariously for him (1 Cor. xv. 29). It was a baptism "into Christ Jesus" (Rom. vi. 3; "into Christ," Gal. iii. 27),—a phrase which must probably be interpreted by the analogous expressions in 1 Cor. i. 13, 15, to mean that the name of Jesus Christ alone was used (that the name of the Trinity was not invariably used in early times is clear from St. Ambrose, *De Spiritu Sancto*, i. 3). But in the teaching of the apostle baptism was more than an initiatory rite, and baptism "into Christ Jesus" had for him a special significance. The immersion of the body in water was a "being buried with Christ," and that not only symbolically but in a real, though mystical, sense; the rising out of the water was in a similar sense an actual rising with Christ into a new life, "that, like as Christ was raised from the dead through the glory of the Father, so we also might walk in newness of life" (Rom. vi. 4, where the word *ζωή*, "life," must be taken in its customary sense of actual or physical, not metaphorical or moral, life). It was otherwise expressed as the "putting on" of Christ, i. e., the being endowed with His nature (Gal. iii. 27, where the same word is used as in 1 Cor. xv. 53, "this mortal must put on immortality"). In the later form of Paul's doctrine an analogy was drawn between baptism and circumcision (Col. ii. 11, 12), the point of the analogy apparently being not merely that each was an initiatory rite, but that, as in circumcision there was a "putting off" of a part of the body, so in baptism the whole "body of the flesh" was destroyed and the "new man" put on. There was the further significance in the rite that by baptism "into one body" the distinctions of race were obliterated. The baptized became "one man in Christ Jesus," so that there could no longer be either Jew or Greek, bond or free, male or female (Gal. iii. 28; cf. 1 Cor. xii. 13). The differences between the several members were merely the differences of functions which result from the diversity of parts in an organic whole; and thereby the foundations of a world-wide society were laid.

The most significant act of the community when it met together was the common meal. Like the members of most contemporary associations, the members of the Christian communities dined together. This common meal was a sacred meal; it was "the Lord's Supper"; it continued and commemorated the Paschal supper at which the Lord had bidden His disciples to eat the bread which was

His body, and to drink of the cup which was the "new covenant in His blood," in remembrance of Him; it thereby "proclaimed the Lord's death till He come" (1 Cor. xi. 24-26). Possibly owing to the double sense of the word *κοινωνία*, viz., "partaking," and "sharing in common," two views seem to be mingled together in the significance which Paul attached to the rite. The one is that, as in "Israel after the flesh" "they which eat the sacrifices" had "communion with the altar," and as those who partook of the heathen sacrifices had "communion with demons" (i. e., with the false gods to whom the sacrifices were offered), so to those who "partook of the table of the Lord" the "cup of blessing" was "a participation in the blood of Christ" and the "bread which we break" was "a participation in the body of Christ" (1 Cor. x. 16-21). The other view is that in thus partaking in common of the "body of Christ" the members of the community realized and consolidated their unity; "seeing that it is one bread, we who are many are one body" (1 Cor. x. 17). Both views must be regarded in relation to his conception of the mystical union of Christ with those who were baptized into His name, and of their consequent union with one another.

*Literature.*—The literature which bears upon St Paul is so extensive that a complete account of it would be as much beyond the compass of this article as it would be bewildering to its readers. The books which are here mentioned are the more important modern books which, without being in all cases conclusive or satisfactory, will enable a student to learn the nature of the main questions which have been raised. I. *LITERATURE*.—Neander, *Geschichte der Pflanzung u. Leitung der christlichen Kirche durch die Apostel* (vol. 1, 4th ed., Hamburg, 1847, Eng. tr. in Bohn's Standard Library); Baur, *Paulus der Apostel Jesu Christi* (Leipzig, 1845, Eng. tr. in Theological Translation Fund Library); Bapan, *Les Apôtres* (Paris, 1866), and *Script Paul* (1869); Krenkel, *Paulus der Apostel der Heiden* (Leipzig, 1869); Hausrath, *Der Apostel Paulus* (2d ed., Heidelberg, 1873), and art. "Paulus," in Schenkel's *Bibel-Lexikon*; Straatmann,

*Paulus de Apostol cum Jesus Christus* (Amsterdam, 1874); Beyerslag, in *Blaeken's Handwörterb. des bibl. Alterthums*; W. Schmidt, in *Herrzog's Realencycl.* (3d ed.); and, in English, Conybeare and Howson, *The Life and Epistles of St Paul*; Ferrar, *The Life and Work of St Paul*; Lewin, *The Life and Epistles of St Paul*. Detailed discussions of most of the important points will also be found in books upon the Acts of the Apostles; e. g., in Overbeck's edition of De Wette's *Kurzerhandlung exegetisches Handbuch* (Leipzig, 1870); the Introduction is translated and prefixed to the translation of Zeller's *Die Apostelgeschichte* in the Theological Translation Fund Library; Wendt's edition of Meyer's *Kritisch-exegetisches Handb.* (Göttingen, 1880); and K. Schmidt, *Die Apostelgeschichte* (vol. 1, Erlangen, 1882), the best modern book on the apologetic side. II. *THEOLOGY*.—The books which first opened up the study of St Paul's theology in distinction from that of other writers of the New Testament were Usteri's *Die Entwicklung des paulinischen Lehrbegriffs* (Zurich, 1834, 6th ed., 1851), and Dahne's book with the same title (Halle, 1835). The most important books on the subject which have since appeared (in addition to some of those which have been mentioned above) are Bilschli, *Die Entstehung der altkatholischen Kirche* (3d ed., Bonn, 1837); Reuss, *Histoire de la théologie chrétienne au siècle apostolique* (Strasbourg, 3d ed., 1864); Holsten, *Zum Evangelium des Paulus u. Petrus* (Roostock, 1868), and *Zum Evangelium des Paulus derperzell* (part 1, Berlin, 1880); Pfeiderer, *Der Positivismus* (Leipzig, 1873, Eng. tr. in the Theological Translation Fund Library); Sabatier, *L'apôtre Paul* (2d ed., Paris, 1881); Menegoz, *Le Pêche et la Rédemption d'après S Paul* (Paris, 1883); Ernout, *Die Ethik des Apostels Paulus* (3d ed., Göttingen, 1882). English literature is singularly deficient in works on St Paul's theology, as distinguished from the philological and archaeological questions which arise out of his life and epistles; almost the only important contributions to the subject are contained in the essays appended to Jowett's *Epistles of St Paul to the Thessalonians, Galatians, and Romans* (2d ed., 1859). Further information as to the literature of the subject, and especially as to the numerous monographs and magazine-articles on special points, will be found in the books which deal with New Testament literature in general; especially, for the older literature, Credner, *Einführung in das N. T.* (Halle, 1856), and, for more recent literature, Reuss, *Die Geschichte der heiligen Schriften N. T.* (4th ed., Braunschweig, 1874); Menzies' edition of Bilschli's *Einführung in das N. T.* (Berlin, 1877); Hilgenfeld, *Historisch-kritische Einführung in das N. T.* (Leipzig, 1875); Weiss, *Lehrbuch der biblischen Theologie des N. T.* (3d ed., 1880, Eng. tr. in Clark's Foreign Theological Library). (A. H. A.)

**PAUL THE DEACON.** See PAULUS DEACONUS.

**PAUL OF SAMOSATA**, bishop of Antioch from about 260 A.D., is famous in church history as the author of the last attempt to replace the doctrine of the essential (physical) divinity of Christ by the old view of the human personality of the Redeemer. The effort was not successful even within his own community. At an Oriental general council, held at Antioch as early as the year 264, his teaching was investigated; but no conclusion was come to because it was alleged Paul had been cunning enough to disguise his real opinions. A second synod was equally abortive; but at a third (probably in the year 268), after a discussion between Paul and a presbyter named Malchion—a sophist of Antioch, and head of a scholastic institution—the metropolitan was excommunicated and his successor appointed. Under the protection of Zenobia, however, Paul continued in his office for four years longer; and the church of Antioch was split into two factions. In the year 272 the city was taken by the emperor Aurelian, who decided in person that the church-building belonged to the bishop who was in epistolary communication with the bishops of Rome and Italy. This decision of course proceeded on political considerations; and indeed it is probable that behind the theological controversy there had been all along a political disagreement, the opponents of Paul being enemies of Zenobia and adherents of the Roman party. About the life of Paul we know scarcely anything. His enemies, indeed, describe him as an unspiritual prelate, an empty preacher, an arrogant man of the world, and a crafty sophist; but this portrait must not be too readily accepted. We are told that he preferred the title of *Ducenarius* to that of bishop. This probably implies that he actually was a *procurator ducenarius*, a civil post of considerable dignity, and we may well believe that he was very conscious of his position, maintained its formalities with some pride, and used it to give effect to his peculiar views. As an accomplished theologian he strenuously opposed the old expositors, i. e., the theologians of Alexandria, and prohibited the use in public worship of all those church hymns in which the essential divinity of Christ found expression.

His doctrine was no novelty, but merely a development of primitive Christian belief as represented, e. g., by Hermas, and at a later time by the so-called Allogi in Asia

Minor, and the Theodotians and Artemonites in Rome. Even in Syria it was not extinct at the end of the 3d century (see the *Acta Archelais*); but in the great churches of the empire—especially in the West and in Egypt—the Logos-Christology was already in the ascendant. And, since the previous state of things had passed from memory, it soon came to be regarded as "heresy" and "innovation" to think of Christ as most Christians had thought in the 2d century. It was chiefly Origen and his philosophical disciples, however, who had brought about the victory of the Logos-Christology, and discredited contrary opinions not only as unchurchly but also as unscientific. Thus the undertaking of Paul was no longer in harmony with the times. And yet his much-abused doctrine, as is now more and more clearly perceived, deserves the highest respect, inasmuch as it is an attempt to express the significance of Christ's person without the aid of cosmology or philosophical theories. The leading outlines of his Christology are as follows. God is to be conceived as one person; from Him, however, there proceeds eternally as *foras* a Logos (*σὸφία*), who may be called "Son." This Logos worked in the prophets, and at last, in the highest degree and in a unique manner, in Jesus. Jesus is in His own nature a man, originating in time; He is "from beneath." But, by means of inspiration and indwelling, the divine Logos worked upon Him "from above." A physical union is out of the question, because the Logos Himself is no "φύσις." To this divine endowment of Jesus corresponds His tried moral perfection. Through the unchangeableness of His mind and will He became like God; through love He became one with Him. For, said Paul, "the only kind of unity which can exist between two persons is that of disposition and direction of will, which comes to pass through love; only that which results from love has value, whatever is physical is worthless." Thus during all His life the Redeemer moved steadily onward, the Father enabling Him to perform mighty works, and finally He proved *ἑἷς* indissoluble union in love with God by His death. As the reward of victory for His love and for His work among men He has received from God the name which is above every name; God has invested Him with divine honour, so that now we may call Him "the God born of the virgin." Since Jesus was eternally foreordained by God, we may even speak of a pre-existence of Christ; and Paul goes

so far as to use these words: "By the grace of God, and through progressive development under trial, Christ became God."

Although Paul was excommunicated, his teaching did not remain altogether without effect in the church. It had a marked influence on Lucian, and through him on Arianism. But it is in the Christological statements of Theodore of Mopsuestia, of Diodorus, and of Theodoret that we can most clearly recognize the influence of the teaching of Paul of Samosata.

*Sources.*—Euseb., *H. E.*, vii. 27-30. Compare also the collection in Routh, *Reliq. Sacr.*, iii. pp. 286 sq., 300 sq., 326 sq. *Literature.*—Bernhardt, *Geschichte des röm. Reiches seit dem Tode Valerian's*, pp. 170 sq., 178 sq., 306 sq.; Hefele, *Conciliengesch.*, 2d ed., p. 185; Lipsius, *Chronologie der röm. Bischöfe* (1869); Feurlin, *De heresi Pauli Sam.* (1741); Ehrlich, *De erroribus Pauli Sam.* (1745); Schwab, *Diss. de Pauli Sam. vita atque doctrina* (1838); Harnack, art. "Monarchianismus," in *Realencykl. f. Theol. u. Kirche*, 2d ed., x. p. 178 sq. (A. H.A.).

PAUL, the name of five popes.

PAUL I, pope from 757 to 767, succeeded his brother Stephen III. on 29th May 757. His pontificate was chiefly remarkable for his close alliance with Pippin, king of France, to whom he made a present of books highly significant of the intellectual poverty of the times, and for his unsuccessful endeavours to effect a reconciliation with the iconoclastic emperor of the East, Constantine Copronymus. He died on 28th June 767, and received the honour of canonization, which he seems to have merited by his piety and virtues. His successor was Stephen IV.

PAUL II, Pietro Barbo, pope from 1464 to 1471, was born at Venice, 28th February 1418. He was on the mother's side the great-nephew of Gregory XII. and the nephew of Eugenius IV., to whose favour he owed his elevation to the cardinalate at the early age of twenty-two. He seems, however, to have made no especial figure at the papal court until the death of Calixtus III. in 1458, when we hear of his interfering actively to protect the late pope's nephew, Pietro Luigi Borgia, from the vengeance of the Roman nobility, and escorting him safely to Civita Vecchia. Upon the death of Pius II. he was unanimously and unexpectedly elected his successor, 31st August 1464. Vain of his personal appearance, he wished to take the name of Formosus, and afterwards that of Mark in honour of the patron saint of his native city, but, being dissuaded from both, called himself Paul. He abandoned his predecessor's projects for a crusade, which he saw to be impracticable, and made it his leading objects to preserve peace in Italy and to enhance the dignity of the papal see by a display of outward magnificence. He embellished the costume of the cardinals, collected jewels for his own adornment, entertained the Roman people with shows and banquets, and introduced the sports from which the Corso takes its name to this day. If the spirit of his pontificate was secular, its administration was in general prosperous, and no serious reproach would rest upon his memory but for his violent persecution of the humanists and scholars who adorned his court, the truth respecting which it is exceedingly difficult to discover. Whether actuated by a perception of the incompatibility between Renaissance culture and traditional Christianity, or by a panic fear of imaginary conspiracies against his own person, he appears to have acted with much arbitrary severity, and to have exhibited himself in the unamiable light of a comparatively illiterate man persecuting letters and learning. At the same time, his severities have been without doubt considerably exaggerated by the sufferers, from whom our knowledge of them is almost entirely derived, and his own official acts and documents give a much more favourable view of his character, confirmed by the tranquillity of Italy in his day. He was undoubtedly not a man of quick parts or enlarged

views, but he must have possessed considerable administrative ability, and his lavish ostentation, not in itself wholly impolitic, was frequently accompanied by displays of charity and munificence. He died very suddenly, probably of apoplexy, on 28th July 1471. The inventory of his personal effects, recently published by M. Eugène Müntz, is a valuable document for the history of art. He was succeeded by Sixtus IV.

PAUL III, Alessandro Farnese, pope from 1534 to 1549, was born 28th February 1468, of an ancient and noble Roman family. He received an excellent education, but his youth was dissolute and stormy, and he owed his promotion to the cardinalate (September 1493) to the admiration of Alexander VI. for his beautiful sister Giulia, whence he was derisively nicknamed Cardinal Petticoat. He soon showed himself, however, to be a man of ability and character, and his reputation and influence went on steadily increasing until, upon the death of Clement VII., being at the time senior cardinal of the sacred college, he was unanimously elected pope after a conclave of only two days, having been in a manner nominated by his predecessor (13th October 1534).

Succeeding the most unfortunate of the popes, at the most critical period in the history of the church, the part assigned to Paul III. was one of no common difficulty. But he also possessed no common qualifications,—prudence increased and vigour tempered by age, learning, moderation, and a prolonged experience of affairs. It was his misfortune to be not altogether a man of his own day: deeply penetrated with the ambitious, luxurious, and secular spirit of the Renaissance, he found it difficult to adapt himself personally to the changed circumstances of the times by entering into the Catholic Puritanism which, however disagreeable to a man of taste and refinement, was an indispensable necessity in combating the Reformation. The want was in a manner supplied by the men whom, conscious perhaps of his own deficiencies, he called around him. No pope has made so many distinguished cardinals, and his promotions included both men of evangelical piety inclined to the new doctrines like Contarini, and fanatical devotees of the old system like Caraffa. The latter group, though Paul had probably little personal inclination for them, triumphed in his councils. The bull instituting the order of the Jesuits (1540) marks the commencement of the Roman counter-reformation; two years afterwards the Roman Inquisition was established, Contarini died with strong suspicions of poison, Ochino was hunted from Italy, and a persecution broke out which soon exterminated Protestantism inside the Alps. Another memorable measure extorted from Paul by the necessities of his position was the convocation of the council of Trent in 1545; but he soon found means to suspend its sittings, which were not resumed for many years. His brief condemning slavery (1537) ranks among the most honourable actions of his reign. As a politician Paul continually strove to trim between Charles V. and Francis I., and to preserve the peace of Italy as far as compatible with his darling aim of procuring an establishment for his natural son. All these objects were accomplished. Paul's contemporaries respected and courted him, Italy in general enjoyed tranquillity, and the monster who brought such disgrace upon him acquired the principalities of Parma and Piacenza. After, however, the murder of this unworthy son, the ingratitude of his grandsons broke Paul's heart, and, overcome by a sudden fit of passion, he expired on 10th November 1549,—enjoying the rare distinction of being one of the very few popes who have died lamented by their subjects. His character was in many respects a very fine one, but in every respect the character of a prince and a scholar, not of an ecclesiastic. He was a munificent



patron of learning, was versed in science, and had an especial weakness for judicial astrology. The arts also owed much to him. Michelangelo's Last Judgment and other works of the first rank were completed under his auspices, and he greatly improved and beautified the city of Rome. Julius III was his successor.

PAUL IV., Giovanni Pietro Caraffa, pope from 1555 to 1559, born 28th June 1476, was the nephew of Cardinal Oliviero Caraffa, by whose interest he became at an early age chamberlain to Pope Alexander VI., and subsequently, though contrary to his own inclination, archbishop of Chieti. He was afterwards nuncio in England and Spain, both of which missions he discharged with credit; but in 1524, under the influence of strong religious impressions, he resigned his archbishopric, distributed his goods among the poor, and retired from the world to direct the monastic order of Theatins, founded by himself. In 1536 the fame of his sanctity induced Paul III. to call him to his court and confer the dignity of cardinal upon him, notwithstanding his own reluctance. He now became the head of the reactionary party at Rome, bent on crushing all tendencies to religious innovation, while insisting on reforms in discipline and moral deportment. Such was unquestionably the policy required by the times from the exclusive point of view of the interests of the church, and it was thoroughly incarnate in Caraffa, in whom the spirit of the Dominican exterminators of the Albigenses seemed to revive. Having taken an important part in two conclaves, he was himself unexpectedly elected pope on 23d May 1555, after the death of Marcellus II., notwithstanding his personal unpopularity and the positive veto of Charles V. Raised to the pontifical throne, Paul showed himself a man of extreme counsels in every respect. He endeavoured to efface the prejudice against his former austerity by excessive magnificence. He rushed into politics, and evinced himself as rash in his partisanship as his predecessors had been dexterous and ambiguous. His open espousal of the cause of France brought upon him a Spanish invasion which would have destroyed his temporal sovereignty but for the superstition of Philip II. and his general Alva, who embraced the first opportunity of making peace. He called his nephews to court and trusted them with blind confidence, but unhesitatingly disgraced them when convinced of their unworthiness. He refused to acknowledge Ferdinand as emperor of Germany, maintaining that Charles had no right to abdicate or Ferdinand to succeed without his own permission. Amid all these agitations he never lost sight of the main purpose of his life: he struggled incessantly against heresy, and was the first pope to issue a full official *Index Librorum Prohibitorum* (see vol. xii. p. 730). He died, on 18th August 1559, recommending the Inquisition to the cardinals with his last breath, and leaving the character of a pope of rare energy of body and mind, upright in all his thoughts and actions, but intoxicated with fanaticism and the pride of office, and more perverse, obstinate, and impracticable than any occupant of the papal chair since Urban VI. His memory was so detested by the Roman people that the hawkers of glass and earthenware were compelled for a time to discontinue their usual cry of "carafe" and cry "ampolle." He was succeeded by Pius IV.

PAUL V., Camillo Borghese, pope from 1605 to 1621, was born in Rome, 17th September 1552, of a noble family. He followed the study of canon law, and after having filled various important offices was made a cardinal in 1596. He succeeded Leo XI. on 16th May 1605, after an unusually long and stormy conclave, the vicissitudes of which are dramatically narrated in Mr T. A. Trollope's *Paul the Pope and Paul the Friar*. No one, till the last moment, had thought of Borghese, who owed his election

to his supposed inoffensiveness and the inability of the leaders of the factions to agree upon any other man. Scarcely had he been elected ere he gave convincing proof that his character had been very much mistaken. He showed himself harsh, domineering, impatient of advice, fanatical in his devotion to the secular as well as the spiritual prerogatives of the church, and inflexible in his resolution to uphold them. He began by successfully repressing numerous encroachments of the civil power in various Roman Catholic countries, and thus became tempted to embark in a contention with the republic of Venice, which inflicted a deeper wound on Rome than anything that had taken place since the Reformation. The dispute was occasioned by the claim of the Venetians to try ecclesiastical culprits before the lay tribunals, and by the extension of old laws forbidding the unauthorized formation of religious corporations and the acquisition of property by ecclesiastics to the entire territory of the republic. Paul protested and menaced (October 1605), and, when the Venetians refused to yield, he launched (April 1606) a bull of excommunication against them, and placed the whole republic under an interdict. The Venetians set him at defiance, forbidding their clergy to pay the least attention to the papal censures, and banishing those who disobeyed from their dominions. A vehement literary controversy arose, in which the famous Father Sarpi, the chief counsellor of the Venetian senate, especially distinguished himself. Paul found himself impotent, and, disappointed in his expectations of material aid from Spain, was thankful to escape from the difficulty by the mediation of France, whose representative, Cardinal Joyeuse, negotiated a compromise in April 1607. The Venetians made some nominal concessions, but gained every substantial point at issue; the main result of the contention, however, was to demonstrate the inefficacy of the spiritual weapons on which Rome had so long relied, and the disrepute into which papal pretensions had fallen even among Catholic nations. Throughout the remainder of his long pontificate Paul acted with comparative moderation, maintaining, nevertheless, the character of a zealous pontiff intent on combating heresy, and especially active in his encouragement of foreign missions. He ranks among the popes who have contributed most to the embellishment of Rome; the nave, façade, and portico of St Peter's were completed by him; he also erected the sumptuous Borghese chapel in Santa Maria Maggiore, and greatly benefited the city by improving streets and constructing public fountains. He died on 28th January 1621, and was succeeded by Gregory XV. (R. G.)

PAUL (1754-1801), emperor of Russia, son of Peter III. and of Catherine, was born on the 2d of October 1754. During the early part of his life he was treated with great harshness by his mother, who had usurped the throne and did not allow him to take any part in the government. There is little doubt that she did not intend him to succeed, but her will was burnt by one of Paul's adherents. His days were spent in retirement, with the exception of a tour which he made in the west of Europe in the year 1780. He was twice married, first, in 1773, to Augusta, princess of Hesse Darmstadt, who died three years afterwards, leaving no issue; secondly, in 1776, to Dorothea Sophia, princess of Würtemberg, who was received into the Greek Church as Maria Feodorovna. Paul Petrovich ascended the throne on the death of his mother Catherine, 17th November 1796. One of his first acts was to cause the body of his father to be exhumed from the Nevski monastery and buried with the empress his wife in the Petropavlovski church among the rest of the czars. Orloff and the other persons implicated in Peter's assassination were compelled to follow the coffin,

and afterwards banished the empire for ever. The chief ministers of the new emperor were Rostopchin and Arakchéeff. Paul now gave signs of a benevolent disposition; among other acts of generosity he set at liberty Kosciusko, who had been detained a prisoner at St Petersburg. He, however, revived many obsolete imperial privileges which were offensive to the nobility, and became unpopular by introducing German regulations into the army. He altered the *oukas* (ukases) of Peter the Great which made the succession to the throne dependent upon the will of the reigning sovereign, and declared it inherent in the eldest son. In 1798 he was appointed grand-master of the order of the Knights of Malta. Alarmed at the progress of the French Republic, he joined Turkey, England, Austria, and Naples in a coalition against Bonaparte. To command the Russians, the veteran Suwaroff was summoned from his rural retreat, to which he had been banished in consequence of making some satirical verses on the new regulations which had been introduced by Paul. For the campaigns of the Russian general, the article *Russia* may be consulted. It may suffice to say here that he, triumphant at first, was eventually compelled to retreat, and was recalled by Paul. He died in disgrace in the year 1800. Soon afterwards the capricious emperor completely changed his plans. Having been flattered by Bonaparte, he secretly made overtures to him and quarrelled with England, seizing English vessels and goods which happened to be in the Russian ports. Bonaparte now entered into an agreement with Paul, whereby they should simultaneously invade the English possessions in India. But the coalition was broken up by the assassination of the Russian emperor in the night of 23d to 24th March 1801, which Bonaparte had the meanness to declare in the *Moniteur* had been planned by the English. The story of his death is well known: he was strangled in the Mikhailovski Palace by Zouboff, Pahlen, and other conspirators. Their original object appears to have been only to make him abdicate. An interesting account of the events immediately preceding the emperor's death has been given by General Sabloukoff, who was on duty that evening at the palace. The empress Maria survived till 1828.

The solution of the incongruities of the character of Paul seems to lie in the fact that he was more or less insane. Hence his outbursts of cruelty in such cases as those of the pastor Seidler and Kotzebue, alternating with generosity, as in his treatment of Kosciusko and other Poles. Englishmen are familiar with some of his mad pranks from the highly interesting travels of Edward Clarke, who suffered from the despot's caprice. Among other whimsicalities, Kotzebue tells us that he seriously proposed that the sovereigns of Europe should settle their differences by single combat. He had so imperilled the position of the country by his extravagance and eccentric policy that his death, however unjustifiable the means, seemed almost a necessity. All Russia breathed afresh when Alexander II. ascended the throne.

The only event of the reign of Paul of permanent importance to Russia was the annexation of Georgia in 1799.

PAUL, ST VINCENT OF. See VINCENT OF PAUL, ST.

PAULDING, JAMES KIRKE (1778-1860), in his day a successful politician, and a writer of some distinction, was born in Dutchess county, New York, United States, on 22d August 1778, and, after a brief course of education at the village school, removed to New York city in 1800, to reside with his brother-in-law, William Irving, a brother of Washington Irving. In connexion with the latter Paulding began in 1807 a series of brief lightly humorous articles, which, under the title of "The Salmagundi Papers," soon became popular, and continued

to appear until 25th June 1808, when they terminated with the twentieth number. Six years later he published a political pamphlet, *The United States and England*, which attracted the notice of President Madison, who in 1814 appointed the author secretary to the Board of Navy Commissioners. Subsequently Paulding was for twelve years navy agent in New York city, and from 1827 to 1841 secretary of the navy, under President Van Buren. Although much of his literary work consisted of political contributions to the press, he yet found time to write a large number of essays, poems, and tales. His marriage in 1818, the death of his wife, and his own withdrawal from public life in 1841, with his death on 5th April 1860, comprise the chief remaining facts of his useful, honourable, and uneventful career.

From his father, who was an active revolutionary patriot, Paulding inherited strong anti-British sentiments, which colour much of his satire, but otherwise he was a just and genial critic, and a delicate and kindly humorist. Of a reserved disposition and hasty temper, with many prejudices, and of extreme political views, he was yet an eminently upright man; of an affectionate nature and a forgiving disposition; a hater of debt, lies, and shams; and an absolutely incorruptible official, who, in every relation of life, was inspired by a lofty, if sometimes mistaken, sense of honesty and honour. In literature he merits notice chiefly as a pioneer, and, though his place was never high, and will certainly not be permanent, he was among the first distinctively American as opposed to English writers, and protested more vigorously than any of his contemporaries against intellectual thralldom to the mother-country. As a prose writer he is chaste and elegant, with a fine negligence, which is sometimes the result of art, more frequently of haste; and, while not so elaborate as Irving, so diffuse as Cooper, or so frank as Neal, he is generally just, neat, fanciful, and realistically descriptive. Among his short stories perhaps the best are *Dyseppey* and *The Politician*, among the long *The Dutchman's Fireside*. As a poet he is gracefully commonplace,—a weak reflexion of Thomson, with a dash of the prairie and the backwoods. His longest and most ambitious poem is—or was, for it is now forgotten—*The Backwoodsman*, which is ill-constructed and tedious, and the only lines of Paulding's which survive in popular memory are the familiar—

"Peter Piper picked a peck of pickled peppers;  
Where is the peck of pickled peppers Peter Piper picked?"

which may be found in *Königsmarks*.

The following is a list of his writings:—*The Diserting History of John Bull and Brother Jonathan* (1812); *The Lay of the Scottish Fiddler; a Tale of Ross & Grace*, supposed to be written by Walter Scott Esq. (1815), a good-natured parody on *The Lay of the Last Minstrel* written with the special intention of ridiculing certain American follies and exposing the excesses of the British in the Chesapeake; *The United States and England* (1814); *Letters from the South* (1817); *The Backwoodsman*; a *Poem* (1818); *Salmagundi*, second series (1819-20); *A Sketch of Old England, by a New England Man* (1822); *Königsmarks, the Long Fines* (1823), a quiz on the romantic school of Scott; *John Bull in America; or the New Manchester* (1824), a broad caricature of the early type of British traveller in America; *The Merry Tales of the Three N'um Men of Gotham* (1825); *The New Mirror for Travellers* (1828); *The Tales of the Good Women, by a Doubtful Gentleman*,—otherwise James K. Paulding (1829); *Chronicles of the City of Gotham*, from the papers of a retired Common Councilman (1830); *The Lion of the West; a Comedy* (1831); *The Dutchman's Fireside* (1831); *Westward Ho!* (1832); *A Life of Washington* (1833), ably and gracefully written; *Slavery in the United States* (1836); *The Book of Saint Nicholas*, a series of stories of the old Dutch settlers (1837); *A Gift from Fairyland* (1838); *The Old Constanzai; or the Price of Liberty* (1840); *American Comedies*, the joint production of himself and his son William J. Paulding (1847); and *The Puritan and his Daughter* (1849). The same son also published a posthumous volume by his father, entitled *A Book of Fables*, which is included in an edition of Paulding's *Selected Works* (4 vols., 1867-68), and a most unsatisfactory biography, mostly made up of long extracts from Paulding's writings, called *Literary Life of James K. Paulding* (1867).

PAULI, REINHOLD (1823-1882), historian, was born at Berlin on 25th May 1823. From his mother, who was of Huguenot descent, he derived a vivacious temperament; from his father, a minister of the Reformed Church, sprung of a family of clergymen and theological professors, he inherited strong religious convictions. He spent his boyhood in Bremen, from whose republican citizens he early imbibed a hearty admiration of liberal self-government, moral discipline, and extensive sea-trade. With the exception of two semesters when he heard Dahlmann at Bonn, he studied at the university of Berlin (1842-46), where he acquired a lifelong predilection for the Hohenzollerns and for the civil service and army of Prussia. Ranke was young Pauli's model historian, but he had far too much individuality to bind himself slavishly to any school. After having taken his degree and passed the public schoolmaster's examination, he became in 1847 private tutor in the family

of Mr Bannatyne, a solicitor in Glasgow, and stayed seven years in Great Britain. During 1849-52 he served as private secretary to the Prussian ambassador Bunsen in London, and made the acquaintance of many eminent politicians of the day and of distinguished antiquaries, such as Kemble, Thorpe, and Hardy. Never a mere book-scholar, he saw various parts of England with an observant eye, and followed public questions with warm interest. He now conceived the plan of investigating the history of England in its original sources. In this way he was the first faithfully to copy some of the Anglo-Saxon annals; but, as soon as he learned that Thorpe was going to edit them for the *Master of the Rolls*, he liberally committed his transcripts to him. The roots of Great and Greater Britain appeared to him to lie in Anglo-Saxon, not in Celtic, institutions, and therefore his first book was *König Aelfred* (Berlin, 1851). Though critically destroying many long-cherished legends, he described his hero's character and times in warm colours. The book was twice translated into English, and Lappenberg, the best judge then living, declared its author worthy to continue his own *Geschichte von England*. Not without material privations Pauli continued his stay in England, and between 1853 and 1858 published three large volumes, comprising the period from Henry II. to Henry VII. In 1855 he became privat-docent at Bonn, and he obtained a professorship at Rostock in 1857. Thence he removed in 1859 to Tübingen, where, however, in 1866 he offended the Württemberg Government by vehemently denouncing its Austrian policy in an essay which appeared during the Prussian war in the *Preussische Jahrbücher*. Exiled to a remote country seminary, he preferred to resign. He now returned to his native country and obtained in 1867 a post in the university of Marburg, which he once represented in the Prussian Upper House. In 1870 he found an honourable position at Göttingen, where the former dynastic union of Hanover with Great Britain had left a splendid English library, and where Waitz had brought together a flourishing historical school.

Pauli's later life was chiefly devoted to modern history, and the *Geschichte Englands 1814-52*, in 3 vols. (Leipzig, 1864-75) made his name widely known. He fulfilled his duties as a teacher and examiner and as a fellow of different learned societies with punctual accuracy; he became member of the academies of Göttingen, Munich, and Berlin, and honorary doctor of Oxford and Cambridge. He helped friends and pupils with untiring kindness; in his happy and social home he was often visited by distinguished English scholars. And he was for a whole generation a living link between the historical literature of England and Germany, "those two columns of the Teutonic world, which, for the benefit of human progress he firmly believed in, he fondly hoped would never be torn asunder." When suddenly called away by a stroke of apoplexy on 3d June 1882, he was deeply lamented on both sides of the Channel.

Pauli's *History of England* was remarkable for its research. Never before had the records, then piled up in the Tower without calendars or indexes, been used in so full a way; never before had the chronicles and memoirs been so thoroughly criticized. The short review of these original sources, given in the appendices, formed a guide to the mediæval historiography of England, and was later on, when better editions appeared, supplemented by Pauli's critiques contributed to German periodicals. The main narrative follows the king, but at the end of each reign the literary, religious, social, economical, and especially the commercial features of the period are cleverly grouped together. Though Pauli was no regular jurist, even the development of the constitutional side of his subject was there superior to the general standard. Indeed these parts, and these only, Pauli lived to see without jealousy superseded by Gneist and Stubbs, while in every other respect his work, then an immense advance upon Lingard, still remains the most solid of its kind. It has never been translated, perhaps on account of its almost annihilated form, and its contempt for the popular attractions of moralizing remarks, philosophical speculation, or picturesque style. To gain

new facts, to show the way for further investigation, seemed to Pauli a worthier task than to amuse the public with a brilliant story. The history is remarkable for the completeness with which the author has used all reports, letters, and memoirs he could lay his hands upon. He was also allowed to inspect private papers of Cobden and of the Prussian ambassadors Bülow and Bunsen; and he knew something by personal recollection. Still he openly confessed that this contemporary history could be only preliminary, on account of the wide gaps in our knowledge of the secret policy, and because "he felt, in dealing with the flowing formless mass of living characters, as if he were touching hot lava that could not yet be shaped into constructive material." Nevertheless the carefully-weighed judgment and the profound understanding of the manifold and tangled tendencies of modern strife are simply astonishing, if we consider that the author was a foreigner. Abroad no guide through the English history of the 19th century can rival this work, while the English reader will find at least the chapters on foreign policy to contain much that is new, and will be sure to admire the impartial views of a distant but lofty and noble observer. Pauli had learned to love the organic growth of the English constitution, and could not look without misgivings on the radical destruction of its aristocratic basis.

Besides a great many essays on the Middle Ages, of which only the popular ones have been collected in *Bilder aus Alt-England* (Gotha, 1860; 2d ed. 1876, translated 1861), and in *Aufsätze zur Englischen Geschichte* (Leipzig, 1869; *Neue Folge*, edited by Hartwig, Leipzig, 1883), Pauli published two monographs: "Grosssetze und Marsh," in the *Tübingen Program* for 1864, and *Simon von Montfort* (Tübingen, 1867). From a literary point of view these biographies are the best things Pauli wrote, and in them he was successful in creating figures of impressive character; but his general histories also usually centre round a hero, e.g., Canning and Peel in his history of England in our own times. Well versed in palæography, Pauli discovered several important memorials, and never despised the humbler task of an editor; he edited *Gowar's Confessio Amanita* (1857), *The Libell of Englishische Policie of 1436* (1878), and three tracts on political economy of the time of Henry VIII., *Transactions of the Göttingen Society*, 1878. For the *Monumenta Germaniæ Historica* he furnished a quantity of MS. collations, and extracted conjointly with Liebermann pieces of interest for Germany out of English historians before 1300 A.D., which appeared in part in vol. xiii. (1881), and in part will fill vol. xxvii. For the Berlin Academy he selected and copied a mass of records relating to Germany, mainly of the 14th century, which did excellent service for the *Hanseatic* publications. For the Camden Society he had prepared the account book of the Prussian crusade of Henry Earl of Derby in 1392, which, it is hoped, will be edited by an eminent English historian. He contributed numberless reviews and detailed, often exhaustive, essays on minor subjects of English history to *Bybell's Historische Zeitschrift*, *Preussische Jahrbücher*, *Grenzboten*, *Rundschau*, *Im Neuen Reich*, *Forschungen zur Deutschen Geschichte*, *Archiv für ältere deutsche Geschichtskunde*, *Hansische Geschichtsblätter*, *Zeitschrift für Kirchenrecht*, *Deutsche Literaturzeitung*, *Göttingische Nachrichten*, *Göttingische Anzeigen*. These articles possess in some respects a very high value as material for future scholars. Pauli's last studies on Henry VIII. and the Hanoverian succession, based on the discovery of the papers of Robethon, the elector's agent, are printed in the *Aufsätze, Neue Folge*.

Hartwig prefixed a sketch of Pauli's life to the *Aufsätze, Neue Folge*, and Frensdorf delivered a lecture upon him, printed in the *Transactions of the Göttingen Society* (1882). (F. L.)

**PAULICLANS** (Παυλικῶν), the name of a religious sect which sprang up in Armenia in the latter half of the 7th century. Their founder was Constantina, belonging to a village near Samosata called Mananalis, where a dualistic, perhaps Marcionite, community had long subsisted. About 660 A.D. his attention had been drawn to the New Testament, and especially to the epistles of Paul, whence he derived a set of opinions which, in their combination at least, were quite peculiar to himself, and under their inspiration he forthwith came forward as a reforming preacher. The scene of his first efforts was Cibossa, in the district of Colonia in Armenia Prima, where, in token of his Pauline discipleship, he called himself Sylvanus and his flock Macedonians. He died about the year 684, but had a succession of like-minded followers—Simeon (called Titus), Paul, Gegnesius (Timothy), Joseph (Epaphroditus)—under whom the sect continued to spread into Asia Minor, ultimately taking up its headquarters in Phaneræa in Helenopontus. According to Petrus Siculus, whose *Historia Manicheorum* was written about 870, they held the ordinary dualistic doctrine common to all the

Manichæans, expressly distinguishing the Being to whom the present world owes its creation and government from the maker and ruler of that which is to come; further, besides being quite out of sympathy with the Catholic doctrine as to the Theotokos, they rejected the Old Testament, the sacraments, the symbol of the cross, and the ordained ministry of the church. The morals of the followers of Constantine seem to have been for the most part unexceptionable, tending to severity, but one of his remoter successors, Baanes by name, gave way to such excesses as to earn for himself the surname of *ὁ βυραπός*; and Sergius (Tychicus), about the beginning of the 9th century, found so great scope for a moral reformation and was so successful in his efforts for this end that he is sometimes spoken of, not extravagantly, as the second founder of the sect. Their aversion to images made them specially obnoxious to persecution by both parties during the iconoclastic controversy,—the iconoclasts specially finding it necessary to give practical demonstration of their antipathy to the Paulician heretics. The violence of Leo the Armenian in particular compelled many of their number, and Sergius among them, to seek refuge in the Saracen part of Armenia, where the emir of Melitene assigned them a seat in the little town of Argaum; from this settlement, notwithstanding the remonstrances of their head, they made frequent and damaging inroads on the Byzantine territory. After the death of Sergius in 835 their government became more political and republican, until the violence of Theodora drove new reinforcements to their camp, including an able military leader named Carbeas, who presently placed himself at their head. The sect continued to grow and to found new settlements, among which Tephrica is specially mentioned by the Byzantine historians as a cause of embarrassment. At the head of an army composed of Paulicians and Moslems, Carbeas more than once invaded the territory of the empire and inflicted defeat on the opposing forces. Chrysocheir, his stepson and successor, was still more successful; sweeping all opposition before him, he overran the whole of Asia Minor, pillaging Nice and Nicomedia, Ancyra and Ephesus,—Basil the Macedonian vainly appealing now to arms and now to negotiation. At last, however (871), he was surprised and slain, and his followers were driven back to their mountain fastnesses. In 970 John Zimisceas succeeded in removing a large colony of them, as guardians of the frontier, to the region about Philippopolis in Thrace, where full religious liberty was guaranteed them. Here they continued to flourish in virtual independence for more than a century, until Alexius Comnenus inflicted chastisement on them for having deserted his standard in the course of the Norman war. In 1115 that emperor fixed his winter quarters in Philippopolis to use for their conversion the various powers of persuasion at his command, and the orthodox city of Alexiopolis was founded in the immediate neighbourhood. The sect, however, called "Popelicans" by Villehardouin, continued to subsist in Thrace until at least the beginning of the 13th century, as did also the Euchites, afterwards Bogomili, who had been attracted to the locality by the toleration of Zimisceas. Meanwhile, branch societies of Paulicians had established themselves in Italy and France, and reappear in history there under various names, such as Bulgari, Patareni, Cathari, and Albigenes.

The Paulicians are the subject of a monograph by F. Schmidt (*Historia Paulicianorum Orientalium*, Copenhagen, 1826); and the *Historia* of Petrus Siculus, already referred to, has been edited (Göttingen, 1846) by Gieseler, whose "Untersuchungen über die Geschichte der Paulicianer," in *Stud. u. Krit.* (1829), as well as the relative sections of his *Church History*, deserve special mention. See also vol. iii. of Neander's *Kirchengeschichte*.

PAULINUS, St., of NOLA. Pontius Meropius Anicius Paulinus, who was successively a consul, a monk; and a

bishop, was born at Bordeaux in 353 A.D. His father, prefectus prætorio in Gaul, was a man of great wealth, so that Augustine could speak of Paulinus, who inherited it, as "opulentissimus dives," and Ausonius, himself a man of property, could speak of his estates as "regna." The literary education of the future saint was entrusted to his elder contemporary and townsman Ausonius, and how considerable was the degree of culture to which he attained as a writer both in prose and verse can yet be seen from his extant works, though it is of course impossible for any one in cold blood to concur in all the friendly praises of Ausonius and Jerome, the latter of whom compares him as a letter-writer to Cicero. In 378 he was raised to the rank of consul suffectus, and in the following year he appears to have been sent as consularis into Campania. Here, whether in an official capacity or not, he certainly remained for some time; and, according to his own account, it was at this period, while present at a festival of St Felix of Nola, that he first entered upon his lifelong devotion to the cultus of that saint. Probably before this time he had married a wealthy Spanish lady named Therasia; the union appears to have been a sympathetic and happy one, though not unclouded by domestic sorrow, among which may be mentioned the death in infancy of their only child,—a bereavement which, combined with the many disasters by which the empire was being visited, did much to foster in them that world-weariness to which they afterwards gave such emphatic expression. From Campania Paulinus returned to his native place and came into correspondence or personal intimacy with men like Martin of Tours and Ambrose of Milan, whose example could not fail to keep before him the claims of Christianity as conceived by them; and ultimately (about 389) he was formally received into the church by Bishop Delphinus of Bordeaux, whence shortly afterwards he withdrew with his wife beyond the Pyrenees. This withdrawal from the pursuits and pleasures of the world called forth the playful banter and serious remonstrances with which alternately he was plied by Ausonius; all appeals, however, to the common memories of an old friendship and to the claims of patriotism and of ambition were made in vain. It is impossible, of course, to say what precise amount of truth may underlie the poet's hint at an undue feminine ascendancy over his friend, which is implied in the expression "Tanaquil tua." Therasia was certainly at least not behind her husband in eagerness to have done with the fast-fading friendship and help of "the world"; but Paulinus is unflinching in his reply to every reproach and entreaty: "Negant Camœnia, nec patent Apollini dicata Christo pectora. . . . Nunc alia mentem vis agit, major deus. . . . O beata injuria, displicere cum Christo." The personal asceticism of Paulinus and his liberality towards the poor soon brought him into great repute among all the devout of the region in which he had settled; and while he was spending Christmas at Barcelona the enthusiasm of the people rose to such a pitch that they insisted on his being forthwith ordained to the priesthood. The irregularity of this step, however, was resented by many of the clergy, and the occurrence is still passed lightly over by his Roman Catholic panegyrist. In the following year he went into Italy, and after visiting Ambrose at Milan and Siricius at Rome—the latter of whom, however, jealous probably of the growing monkish spirit and mindful also of the irregular ordination, received him somewhat coldly—he proceeded into Campania, where, in the neighbourhood of Nola, he settled among the rude structures which on his former visit he had caused to be built around the tomb and relic of his "dominedrus" (lord of the edifice) and patron saint. Along with Therasia (now a sister, not a wife), while leading a life of rigid asceticism, he devoted the whole of his vast wealth to the

entertainment of needy pilgrims, to payment of the debts of the insolvent, and to public works of utility or ornament; besides building basilicas at Fondi and Nola, he provided the latter places with a much-needed aqueduct. At the next vacancy, not later than 409, he succeeded to the bishopric of Nola, and this office he held with ever-increasing honour until his death, which occurred shortly after that of Augustine in 431. He is commemorated by the Church of Rome on 22d June.

The extant writings of Paulinus consist of some fifty *Epistolæ*, addressed to Sulpicius Severus, Delphinus, Augustine, Jerome, and others; thirty-two *Carmina* in a great variety of metre, including a series of hexameter "natales," begun about 393 and continued annually in honour of the festival of St Felix, metrical epistles to Ansonius and Gestidius, and paraphrases of three psalms; and a *Passio S. Genesii*. They reveal to us a kindly and cheerful soul, well versed in the literary accomplishments of the period, but without any strength of intellectual grasp and peculiarly prone to superstition. The somewhat conspicuous place in church history occupied by Paulinus is chiefly due to the effect his great influence had in promoting the practice of pilgrimage, relic-hunting, and picture-worship, as well as the uncritical acceptance of every alleged miracle; to the intellectual development of Christianity he contributed nothing and it may well be questioned whether the manner in which he discharged the stewardship of his wealth was as judicious and beneficial as it certainly was generous.

His works were edited by Rowseyde and Fronton le Due in 1623 (Antwerp, 8vo), and their text was reprinted in the *Bibl. max. patr.* (1677). The next editor was Le Brun des Marets (Paris, 1685, 2 vols. 4to), whose text was reproduced in substance by Muratori (Verona, 1786), and reprinted by Migne.

PAULUS, HEINRICH EBERHARD GOTTLÖB (1761-1851), the distinguished representative of the rationalistic school of German theologians of the beginning of this century, was born at Leonberg, near Stuttgart, 1st September 1761. His father, the Lutheran clergyman at Leonberg, was convinced of the immortality of the soul by spiritualism, and was deprived of his living in consequence of his belief in the intercourse of departed spirits with men. He likewise required of his children unconditional obedience, and commanded them to believe the doctrines of religion without asking wherefore. The father's spiritualism and dogmatism drove the son by natural reaction to the rationalism which prevailed at the time, and of which, in its application to Biblical history, Paulus became the most famous representative. He was educated at Tübingen, was three years headmaster of a German school, and then spent two years in travelling through England and the principal countries of the Continent. He subsequently published interesting passages from the journal of his tour. In 1789 he was chosen ordinary professor of Oriental languages at Jena. In addition to the studies of his own department he prosecuted especially mathematics, as the best preparation for clear thinking. At Jena he lived in close intercourse with Schiller, Goethe, Herder, and the most distinguished literary men of the time. In 1793 he succeeded Doederlein as professor of theology. His special work was the exposition of the Old and New Testaments in the light of his great Oriental learning and according to his characteristic principle of "natural explanation." He held that miracles in the strict sense were impossible, that the events recorded in the Bible took place naturally, and that the narratives of the Gospels are the true reports of men who either were eyewitnesses or had obtained information from such as were. From a purely apologetic motive he sought to remove what other interpreters regarded as miracles from the Bible by distinguishing between the *fact* related and the author's *opinion* of it, by seeking a naturalistic exegesis of a narrative, e.g., that *ἐν τῆς θαλάσσης* (Matt. xiv. 25) means *by the shore* and not *on the sea*, by supplying circumstances omitted by the author, by remembering that the author produces as miracles occurrences which can now be explained otherwise, e.g., exorcisms. The chief exegetical works of Paulus are his *Philologisch-kritischer und histor-*

*ischer Commentar über das Neue Testament* (4 vols., 1800-1804), *Clavis über die Psalmen* (1791), and *Clavis über Jesaias* (1793), and particularly his *Exegetisches Handbuch über die drei ersten Evangelien* (3 vols., 1830-33; 2d ed., 1841-42). His *Life of Jesus* (2 vols., 1828) is a synoptical translation of the Gospels, prefaced by an account of the preparation for the Christ and a brief summary of His history, and accompanied by very short explanations interwoven in the translation. The form of the work was fatal to its success, and the subsequent *Exegetisches Handbuch* rendered it quite superfluous. In the latter work Paulus really contributed much to a true interpretation of the Gospel narratives, notwithstanding his entire failure to explain the miracles away. The historical and geographical excursions and dissertations interwoven in his commentaries are of considerable value. He was particularly well acquainted with the conditions of Oriental life. In the year 1803 Paulus left Jena on account of his health, and filled various posts in south Germany until 1811, when he became professor of exegesis and ecclesiastical history at Heidelberg. It was there that he found the freest scope for his great learning and tutorial abilities. He filled this chair until 1844, when he retired on account of his great age. He died, faithful to his first rationalistic position, a staunch friend of intellectual and political freedom and light, 10th August 1851, in his ninetieth year.

The literary labours of Paulus were not confined to exegesis. He edited a collected small edition of Spinoza's works (1802-1803), a collection of the most noted Eastern travels (1792-1803), Schelling's *Vorlesungen über die Offenbarung* (1843), &c. He was also the author of *Skizzen aus meiner Bildungs- und Lebensgeschichte* (1839), and he left behind him the materials for a biography, which was published by Professor Reichlin-Meldegg, under the title *H. E. G. Paulus und seine Zeit* (1853).

PAULUS, JULIUS. See ROMAN LAW.

PAULUS (or PAVLLUS), LUCIUS ÆMILIUS, a distinguished Roman general, of the patrician family of the Æmilii, was born about 229 B.C. He was the son of the consul of the same name who fell at Cannæ. As curule ædile in 192 he gave a proof of his integrity by prosecuting the persons who made an illegal use of the public pastures. His first laurels were won in Further Spain, whither he was sent as prætor in 191. Though at first defeated with loss, he finally overthrew the enemy in a bloody battle (189) and tranquillized Spain. In 182 he was consul, and in the following year subdued the Ingauni, a piratical tribe of Liguria, dismantling their towns and carrying off their ships. For this service he was granted a triumph. After a period of retirement from public life he was elected consul a second time, for 168, and entrusted with the command in the Macedonian war, which the incapacity of previous Roman generals had allowed to drag on without success for three years. Paulus brought the war to a speedy termination by the battle of Pydna, fought on 22d June (Julian calendar) 168. The battle decided the fate of Macedonia, which was henceforward a Roman province. The Macedonian king Perseus surrendered shortly afterwards and met with a courteous reception from the Roman general. Paulus now availed himself of his position to make the tour of Greece, visiting with an intelligent interest the places immortalized in Greek history and legend. Afterwards, assisted by ten Roman commissioners, he arranged the affairs of Macedonia. In obedience to the orders of the senate, on his return through Epirus to Italy he gave up seventy towns to pillage and carried off 150,000 of the inhabitants as slaves. A magnificent triumph, graced by the presence of the captive king Perseus and his three children, rewarded the conqueror of Macedonia (167). But his public glory was closely attended by private misfortune; of the two sons borne him by his second wife one died a few days before,

the other a few days after, his triumph. The veteran was thus left without a son to bear his name; for of his two sons by his first wife Papiria, the elder had been adopted by Quintus Fabius Maximus, Hannibal's great opponent, and the younger by the son of Scipio Africanus. The latter, known as P. Cornelius Scipio Æmilianus, was the conqueror of Carthage and Numantia. Paulus was censor in 164, and died in 160. At the funeral games exhibited in his honour the *Hecyra* of Terence was acted for the second and the *Adelphi* for the first time.

Paulus was a fine specimen of a Roman noble. An aristocrat to the backbone, he was yet beloved by the people, whose favour he never deigned to court by unworthy means. His integrity was perfect; of the vast sums brought by him into the Roman treasury from Spain and Macedonia he kept not a penny to himself. At his death his property with difficulty sufficed to pay his wife's dowry. As a general he was a strict disciplinarian; as an arguer he discharged the religious duties of his office with conscientious care and exactness. His piety passed into superstition, as when before the battle of Pydna he sacrificed to the moon, then under eclipse. His sympathy with Greek learning and art is attested by the Greek masters whom he procured for his sons, as well as by his travels in Greece, the works of art he brought home, and his friendship for the historian Polybius. His nobility of nature won him the affection and esteem of all who knew him, of his enemies no less than of his countrymen. An affecting proof is the fact recorded by Plutarch that his body was carried to the grave by volunteers from all the nations he had conquered, while old men from Spain, Liguria, and Macedonia followed lamenting the man who (according to them) was at once their conqueror and their saviour.

There is a life of him by Plutarch, but his campaigns in Liguria and Macedonia are more fully described by Livy (xl. 23-25; xlv. 17-xiv. 41).

**PAULUS ÆGINETA.** See *ÆGINETA*, vol. i. p. 181, and *MEDICINE*, vol. xv. p. 804.

**PAULUS DIACONUS**, the historian of the Lombard dominion in Italy, flourished in the 8th century (see *LOMBARDS*, vol. xiv. p. 813). An ancestor of his named Leupichis entered Italy in the train of Alboin and received an allotment of lands at or near Forum Julii (Friuli). By an invasion of Avars all the five sons of this warrior were swept off into Illyria, but one, his namesake, returned through many perils and restored the ruined fortunes of his house. His grandson was Warnefrid, who, by his wife Theodelinda, became the father of Paulus. The future historian (born about 720 or 725) received an education unusually good for his times, possibly in part conducted at the court of King Ratchis in Pavia. From a teacher named Flavian he received at least the rudiments of Greek. In middle life, probably, he retired into the great Benedictine monastery of Monte Cassino, which his patron King Ratchis had entered in 749. The ruin which befell the Lombard monarchy in 774 at the hands of Charles the Great may have caused him to take this step. In this ruin was involved his brother Arichis, whose estates were confiscated, himself confined in prison for seven years, and his wife and children reduced to beggary. About 781 Paulus left his monastery and travelled to France, probably in order to intercede for this brother, and after considerable delay his request was granted. Meanwhile, his literary gifts had come to be highly appreciated by the Frankish king. The letters and the verses which passed between Charles (employing the pen of a secretary) and Paulus give a pleasant idea of the relation between the two parties, and remind us of the intercourse between the Italian princes and the scholars of the Renaissance. After some years' residence in France Paulus returned to Italy and to his convent, and died, probably between 790 and 800, at his beloved Monte Cassino. His surname, Diaconus (or Levita), shows that he took orders as a deacon, no doubt during his residence in the monastery.

The chief works of Paulus are his *Continuation of Eutropius* and his *Lombard History*. The former (one of his earliest works) was written at the request of Adelperga, wife of the duke of Benevento. Paulus recommended her to read the Roman history of Eutropius, but, as she complained that this heathen writer said nothing of

church affairs, and stopped short at the death of Jovian, Paulus interwove some extracts from the ecclesiastical historians, and added six books (xl.-xvi.), bringing down the history to 553 A.D. At this point his *Lombard History*, in six books, written in the later years of his life and cut short by his death, takes up the tale, which is told henceforward from the point of view of a Lombard patriot. The sagas of the Langobardic warriors, plentifully interspersed, give to the narrative a wild barbaric interest. The document called the *Origo Gentis Langobardicæ* and the lost history of Secundus of Trient furnished some of his materials. He also makes free use of Gregory of Tours, Bede, Isidore, and others. In some aspects Paulus naturally suggests a comparison with Jordanes, that other historian of a barbarian nation falling into ruin, but in learning and literary honesty the Lombard is greatly the superior of the Goth. His style is, for his age, wonderfully good, though his grammar shows the breaking down of the old Latin inflexions into the *lingua vulgare*.

Paulus wrote also a history of the bishops of Metz, some homilies, and several small poems, some rhythmical, some metrical. His works were frequently copied in the Middle Ages. Of the *Lombard History* there are more than a hundred MSS. extant, those of Assisi, Cividale, and St Gall being the most important. The edition of his histories published as part of the *Monumenta Germanicæ Historica* (1878-79) supercedes all others. For further information, the student may consult G. Waitz's preface to the *Lombard History* in that edition, and F. Dahn's *Langobardische Studien*, an able monograph, but perhaps too negative in its conclusions. The English reader will find an excellent sketch of Paulus's life and writings in Ugo Bazzani's *Early Chronicle of Italy* (London, 1888).

**PAUPERISM.** See *POOR LAWS*.

**PAUSANIAS**, the general who led the Greeks to victory at Plataea, was a Spartan and a member of the Agid branch of the royal house. In 479 A.C. he succeeded his father Cleombrotus as regent and guardian of his cousin the youthful king Plistarchus, and in the same year he was appointed, by virtue of his rank, to lead the army despatched by the Spartans to help the Athenians against the Persians under Mardonius. He commanded the united Greek army at the memorable battle of Plataea (479), which for ever secured the freedom of Greece against the Persians. The credit of that great victory belongs to the soldiers rather than to their general, for Pausanias seems to have acted without any settled plan, and to have given battle only when he was forced to do so by the enemy. Indeed, his attempt to withdraw the Spartan contingent from the post of honour on the right, in order to avoid encountering the native Persian troops under Mardonius, savours of positive cowardice. But, if he feared the living, he respected the dead; a proposal made by a Greek after the battle to avenge the death of Leonidas by mutilating the corpse of the gallant Mardonius received from Pausanias a stern rebuke. After the expulsion of the Persians from Greece Pausanias led a Greek fleet (478 or 477) to Cyprus and thence to Byzantium, which he captured from the Persians. But the successes he had hitherto enjoyed only fed without satisfying his ambition. He conceived the design of making himself master of all Greece, and with this view he opened a correspondence with Xerxes, offering to marry his daughter and reduce Greece to a Persian province. The proposal was hailed with delight by the Persian monarch. Puffed up with these hopes, Pausanias now assumed by anticipation the airs and state of a tyrant, and by his overbearing manners offended the Greeks so deeply that in disgust they transferred the leadership of the allied forces from Sparta to Athens,—a momentous step, from which sprang the maritime empire of Athens. Pausanias was recalled to Sparta and tried, but, though convicted and punished for minor offences, the evidence was insufficient to substantiate the charge of treason, and he was acquitted. Having afterwards the folly to return to Byzantium in a private capacity and reopen communications with Persia, he was again recalled and put on his trial. There was strong suspicion of his treason, but no positive evidence. It was known, too, that he had incited the Helots to revolt,



promising them freedom and citizenship if they would join him; but, with characteristic caution, the authorities declined to accept the evidence of a Helot against a Spartan, and Pausanias might, after all, have been acquitted if it had not been that a messenger to whom he entrusted a letter for Artabazus, the Persian satrap, opened it, and, finding in it a direction to put the bearer to death, carried it to the ephors. But not until they had contrived to overhear a conversation between Pausanias and his messenger were the ephors satisfied of his guilt; and then they proceeded to arrest him. Foreseeing their intention, Pausanias took refuge in the temple of Athens of the Brazen House. The ephors took off the roof, blocked up the doors, and starved him. When on the point of death he was dragged out, that his corpse might not defile the sanctuary. This happened about 467.

The principal authorities for the life of Pausanias are Herodotus (Fr. 10 sq.) and Thucydides (I. 94, 95, 128-134). There is a biography of him by Cornelius Nepos. See also Diodorus, xi. 29-34, 44-46; Pausanias, iii. 4, 7 and v. 17, 7; Plutarch, *Themistocles*, 23; *Id.*, *Aristides*, 11, 14-20, 23; Aristodemus, ii. iv. vi.-viii. (in Müller's *Fragm. Hist. Græc.*, vol. v.); Justin, 2, 14.

PAUSANIAS, a prose-writer (*λογογράφος*) of Greek traditions, mythical and historical, and a critic of Greek art. His important work, in ten books, called 'Ελλάδος Περιήγησις, usually known as *Pausanias Descriptio Græciæ*, has come down to us entire. It is strictly an itinerary through the Peloponnesus, including Attica, Bœotia, and Phocia, with a rather slight mention of the adjacent islands and some of the principal towns on the Asiatic coast. It was evidently compiled by one whose interest was mainly centred in making notes of art-collections as they existed in the Greek temples and public places in the time of the Antonines. In connexion with these he expatiates on the myths and legends locally preserved, and thus he has handed down to us much valuable mythological material which would otherwise have been lost. A large portion of his work, however, is devoted to Greek history, properly so called, though, after the manner of Herodotus and the early logographers, he draws no distinction between legend and history. In a general sense he may be styled an antiquary rather than an art-critic, a man of industry rather than of genius, and one who deserves praise more from the matter of his work than for the manner of it. Of the personal history of Pausanias nothing is recorded. He lived during the prosperous times of the Roman empire under Hadrian, whom he often mentions by name, and his successors Antoninus Pius and Marcus Aurelius, the latter of whom became emperor in 161 A.D. His wars against the German Marcomanni are alluded to,<sup>1</sup> and Antoninus Pius<sup>2</sup> is also named in reference to his successful contest with the Moors. Mention is also made of the "wall" raised between the Forth and the Clyde by the elder Antonine to keep off the assaults of the Brigantes. About himself and his birthplace the author is singularly reticent. Nor has his work any formal introduction or conclusion. He commences abruptly with a description of Attica: "The mainland of Hellas off the Cyclades and opposite the Ægean Sea is called Attica, the jutting headland of which is Sunium. There is a harbour when you have sailed past this foreland, and a temple of Athena the Sunian goddess on the height." He goes on to describe Athens at considerable length, and gives a valuable though too brief account of the Parthenon and the great bronze statue of the goddess on the Acropolis, the work of Phidias,<sup>3</sup> the

spear and helm of which were visible to those sailing into the harbour from Sunium. On the ivory and gold statue of the goddess in the Parthenon (c. 24) he writes very briefly; on the Erechtheum and its antiquities he expatiates more largely. The great temple of Ephesus, the very site of which was lost till Mr Wood's explorations between 1863 and 1874, appears to have been perfect in his time, but he does not describe it; he merely says<sup>4</sup> that "Ionia contains temples such as are not elsewhere to be seen, and first of all that of the Ephesian goddess, remarkable for its size and its wealth in general."

Like Herodotus and Strabo, Pausanias was a traveller and an inquirer. In some respects it is probable that he imitates the manner of Herodotus, as in his credulity<sup>5</sup> and the affectation of reserve in sacred matters. But, while geography and ethnology chiefly engaged the attention of Strabo, art and antiquities generally form the staple of Pausanias's work. The passion of the Romans for securing specimens of Greek art had long been fed by the plunder of temples and the removal of statues from the towns of the Greek provinces, so graphically described in the orations against Verres. Pausanias comments on the great antiquity of this kind of sacrilege. "It is clear," he remarks,<sup>6</sup> "that Augustus was not the first who established the custom of carrying away offerings from the temples of conquered nations, but that he merely followed a very old precedent." And he quotes many examples of statues removed by right of conquest, as from Troy, from Brauron and Branchidæ by Xerxes, from Tiryns by the Argives, &c.

In the age of the Antonines special attention was directed to the works of art still remaining in the Greek cities. The work known as *Antonine's Itinerary*, which is a kind of handbook of the whole Roman empire and its complex system of roads and colonies, may have suggested to Pausanias a "Description of Greece," on the lines laid down by Herodotus and Strabo; but we have no exact date of the composition of either work. Leland compiled his *Itinerary* or tour through Britain on much the same principles, and his record of churches and castles as they remained in the later years of Henry VIII. is a survey of mediæval art which resembles the notes of Pausanias formed from his own inquiry and observation.

The vast wealth of the Greek cities in statuary and sculpture, which had been accumulating from the 5th century B.C. till the capture of Corinth by Mummius, may be judged of by the records of the plunderings of Verres and the costly purchases of Cicero<sup>7</sup> and his successors to the time of Nero, and even of Hadrian, which are matters of history. Nevertheless, after the drain of more than three centuries, "Pausanias," says Mr Westropp,<sup>8</sup> "was able to describe 2827 statues."

Whether Pausanias had any real taste or enthusiasm for or judgment of fine art does not appear from his somewhat matter-of-fact accounts. He reminds us of a catalogue of goods made with the view of a sale, *minus* the auctioneer's "puffing." Nor is his motive much more apparent; he may have written to let connoisseurs know what was yet to be had, or to put on record existing works, with the names of the artists, as a protest against further spoliation, or he may have been commissioned by imperial authority to make a list of the art-treasures still exhibited to travellers in the Roman provinces. In the century from Augustus to Trajan Greek education in art, literature, and philosophy was much affected by the rich and well-born Romans, and collections of Greek bronzes and real or spurious articles of antiquity were keenly competed for, as we know from many of the epigrams of Martial.<sup>9</sup>

Pausanias does not usually say that an object is beautiful; he tells us what it is, where it is, and who executed it; that is generally all. Occasionally he remarks that a statue is "worth

<sup>1</sup> *vii.* (Achaica), 5, 2.

<sup>2</sup> As when he says, as if seriously (*viii.* 2, 4), that it seems to him quite credible that Lycœon was changed into a wolf and Niobe into a stone in the good old times when the gods conversed with men on earth.

<sup>3</sup> *viii.* 46, 2.

<sup>4</sup> Often referred to in his letters to Atticus.

<sup>5</sup> *The Cycle of Development of the Art of Sculpture in Greece and Rome*, lect. v. p. 166.

<sup>6</sup> Propertius has a curious critique on the relative merits of the Greek sculptors and painters: (*iv.* 8, 9-16). In elegy 4 of the same book, ver. 6, he disclaims the character of a wealthy collector, "ne miser æra paro clade, Corinthæ, tua."

<sup>1</sup> *Deor. Gr.*, *viii.* (Arcadica), 43, 6.

<sup>2</sup> *viii.* 43, 5, τούτων Ελευσθῆ τὴν βασιλῆα ἐκίδουσα αἰ Πυρραίου, ἡὲν τῆ ἐν τῷ θεῖον τιμῆ μέλιστα ἰθαίεινον χροῖμας. The epithet is usually attributed to the affection shown to the memory of Hadrian, by whom he had been adopted.

<sup>3</sup> *i.* 28, 2. This statue is referred to by Aristophanes (*Æg.*, 1172) and Euripides (*Herc. Fur.*, 1093).

looking at," *ὅλας ἀξίως*, but criticism, in the true sense of the word, is hardly ever attempted. In ii. 27, 5 he speaks highly of Polyclitus as an architect, and says that none can rival him for beauty or proportion. In vii. 5, 2 he says the temples of Hera in Samos and of Athena at Phocæa "were objects of admiration," though they had been burned and greatly injured by the Persians. Occasionally (as vii. 5, 4; 26, 6) he guesses the name of an unknown artist from the style of a sculpture; in vii. 25, 4 he describes some marble statues of women as showing a good style of art, *ἕκασται εἰς*. His descriptions of a series of designs, like those painted by Polygnotus in the Lesche at Delphi,<sup>1</sup> are dry and without a glimpse of discrimination,—mere lists of names and subjects, like modern "guides" to a gallery or museum of art. At the same time the minuteness of observation and the careful record of all the inscribed names are most commendable, and the value of the account to us from a literary point of view, as showing what subjects were regarded as "Homeric" in the time of Polygnotus, a contemporary of Pericles, cannot be overrated. The same remarks apply to the account of the famous "chest of Cypselus," preserved at Olympia, and claiming a great antiquity from the inscriptions being written *βοιωτῶνδῶς*, alternately from left to right and right to left.<sup>2</sup> He ends his description of scenes chiefly taken from the *Troica* with these words:<sup>3</sup> "Who the maker of this chest was we had no means of forming any conjecture. The inscriptions upon it may perhaps be by another hand; but our general impression was that the designer was Eumelus of Corinth, mainly on account of the processional hymn which he composed for Delos." This Eumelus is believed to have flourished about 750 a.c. The suspicion of Pausanias that the inscriptions were later made it probable that the whole design and workmanship were imitative on an archaic model.

Recent explorations, especially those at Olympia, are largely indebted to the careful and detailed accounts of Pausanias.<sup>4</sup> The temples at Ephesus, Branchida, Claros, Samos, and Phocæa he merely mentions, his researches being limited to the cities of western Greece.<sup>5</sup> His notes on the topography of Athens, though he passes over several of the more important buildings, as the great theatre and the Odeum, with little more than a mere reference, are still the principal authority confirming the allusions in early writers. He seems, indeed, to have admired objects more for their antiquity than for their beauty. He often diverges into long details of history, largely mixed with legend, as in his long account of the Messenian wars in book iv.; indeed, mythology and history proper stand with Pausanias in precisely the same category. He does not show any great advance in this respect from the times of Hecateus or Pherecydes of Byros.

The style of Pausanias is simple and easy, but it is wanting in the quaintness and vivacity of Herodotus, and it has not the florid eloquence of Plato or Lucian. The simple and genuine credulity of Herodotus seems foolish or affected in a writer who lived in a much more advanced period of human knowledge. Thus he gravely tells us<sup>6</sup> that the water of the Styx will break crystal and precious stones and vessels of clay, and cause metals, even gold, to decay, and can only be kept in a horse's hoof.

The titles of the several books are taken from the divisions of the Peloponnesus, together with the three lying immediately north of the isthmus; the first book being devoted to Attica, the ninth to Bœotia, and the tenth to Phocia. The remainder are (ii.) Corinthica, (iii.) Laconica, (iv.) Messeniaca, (v. and vi.) Eliaca, (vii.) Achaica, (viii.) Arcadica. In adopting this nomenclature he probably followed the *Troica*, *Persica*, &c., of Hellenicus. A vast mass of information is contained in these several books, which may be closely compared in their treatment and in the great variety of subjects with English "county histories."

Without the sustained interest and the genial humour which characterize the work of Herodotus, composed as it evidently was for recital and not for private reading, Pausanias is an accurate and diligent recorder of what he saw and knew. He copied inscriptions, and, like Herodotus, he often quotes oracles; in ascertaining the names of artists he is particularly careful. That he had made great research into the history and topography of Greece is abundantly shown; but he is rather chary in his reference to previous authors. Of Herodotus he makes mention in eight or nine places, of Plutarch in one (i. 38, 4), of Plato in four. Thucydides is referred to once (vi. 19, 5), Acusilaus once (ii. 16, 4), Hellenicus

<sup>1</sup> x. (Phocica), 25-31.    <sup>2</sup> v. (Eliaca), 17-19.    <sup>3</sup> 19, 2, p. 427.

<sup>4</sup> Eliaca (ii.), book vi., the later chapters of which give a very full description of Olympia and its buildings and statues.

<sup>5</sup> vii. 5, 4. Here occurs one of the few faint expressions of pleasure or praise that the writer indulges in. "You would be pleased," he says, "also with the temple of Hercules at Erythra, and that of Athena at Priene, the latter on account of the statue, the Heraclæum for its antiquity." These remarks show that he had visited and knew something of the temples in Ionia. The tomb of Mausolus at Hali-car-nassus he mentions in terms approaching to praise, viii. 16, 4.

<sup>6</sup> viii. (Arcadica), 18, 5.

twice, Hecateus four times, Strabo nowhere. Of the poets, epic, lyric, and dramatic, he displays a good knowledge, as well as of Pindar, whom he frequently quotes. It is clear, therefore, that Pausanias was a literary man, and perhaps it is more an idiosyncrasy than a fault that he is cold and prosaic in his descriptions. Of the author's birth, family, or country there are no indications. The name is Doric, but the style is the Attic of Plutarch, Strabo, and Lucian.

The best editions of Pausanias are those of Siebels (6 vols. 8vo, Leipzig, 1822-28), and of Schubart and Welz (8 vols. 8vo, Leipzig, 1838-40). Schubart's text was reprinted in the Trübner series (2 vols. 12mo, Leipzig, 1862), with brief introductory critical notes and a very careful and complete index. This is an excellent and accurate edition, and one which leaves nothing to be desired. (F. A. F.)

PAUSILIPO, or POSILLIPO. See NAPLES, vol. xvii. p. 187.

PAVIA, a city of Italy, the chief town of a province, and a bishop's see, is situated at a height of 270 feet above the sea-level, 22½ miles by rail south of Milan, on the left bank of the Ticino, about 2 miles above its junction with the Po. The railway from Milan to Genoa, which is there joined by lines from Cremona, &c., crosses the river on a fine bridge constructed in 1865; and, farther down, the city is connected with the suburban village of Ticino by a remarkable brick-built covered bridge dating from the 14th century. Though it has lost its importance as a fortified town, and no longer deserves the designation of "City of the Hundred Towers," Pavia is still for the most part surrounded by its ramparts, which in a circuit of about 3¼ miles enclose an area of 400 acres. Several of its buildings are of great architectural interest. The basilica of San Michele is one of the finest specimens extant of the Lombard style (cf. ARCHITECTURE, vol. ii. p. 435), and as it was within its walls that the crown was placed on the head of the "kings of Italy," from whom the house of Savoy claims to be descended, it has received the legal title of Basilica Reale (royal decree of 1863). A careful restoration has since been effected. The cathedral of San Stefano, of which the first stone was laid by Bishop Ascanio Sforza in 1488, is still unfinished, the original design by Cristoforo Rocchi, a pupil of Bramante, consisting of a central octagon from which four arms projected so as to form a cross. In the interior is the tomb of St Augustine, a remarkable specimen of 14th-century sculpture, which presents the saint life-size in pontifical robes, and is surrounded by a profusion of bas-reliefs and minor figures representing saints of his order, liberal arts, and cardinal virtues—in all, 420 heads. The relics which it enshrines are said to have been brought from Hippo to Sardinia by African refugees, purchased in 724 by Liutprand, and deposited in the now ruined church of San Pietro in Ciel d'Oro, and thence transferred to the cathedral subsequent to their rediscovery in 1695. Beneath the high altar is the tomb of Boetius, whose remains were also brought from San Pietro; and from the roof of the building is suspended the lance of Roland (Orlando).<sup>7</sup> Of

<sup>7</sup> The famous Certosa of Pavia, one of the most magnificent monasteries in the world, is not situated within the city, but at a distance of about 5 miles towards the north. Its founder, Gian Galeazzo Visconti (to whom we also owe the Milan cathedral), laid the first stone on 27th August 1396, and the building was nominally finished in 1542. A parallelogram, about 140 yards long by 110 broad, is surrounded on all sides by a lofty cloister formed of 123 arches. The church, whose marble façade is more richly decorated than any other in north Italy, is in the form of a Latin cross, 258 feet long by 177 feet wide, with three naves and a vast octagonal dome. In the south transept stands the mausoleum, in Carrara marble, of Gian Galeazzo Visconti, designed by Galeazzo Pellegrini in 1490; and in the north transept are the marble statues of Lodovico Sforza il Moro and his consort Beatrice by Cristoforo Solari. The Carthusian monks, to whom the monastery was entrusted from the first by its founder, were bound to employ a certain proportion of their annual revenue in prosecuting the work till its completion; and even after 1542 they voluntarily continued to expend large sums on further decoration. The Certosa of Pavia is thus a practical text-book of Italian art for well-nigh three centuries (see Durelli, *La Certosa di Pavia*, Milan, 1823; and Gruner's *Presco-De-oratione*, 1854, and *Terra Cottia Architecture in North Italy*, 1867).

secular edifices in Pavia the most noteworthy is the palace or castle of the Visconti, begun in 1360 for Galeazzo II. It is a vast quadrangle, presenting to the outside heavy fronts of massive masonry, but in the 15th and 16th centuries it was as remarkable for sumptuousness as for strength. Originally there was a square tower at each corner; two were destroyed by the French artillery in 1527.<sup>1</sup> The university of Pavia (formally constituted in 1361 by the emperor Charles IV., but claiming to have its first origin in a school founded by Charlemagne) has faculties of law, medicine, and science. The professors number between forty and fifty, but the students have decreased from 1475 in 1860 to 604 in 1881-82. Among its subsidiary establishments are two colleges—the Borromeo and the Ghislieri—founded respectively by Archbishop Borromeo (1563) and Pope Pius V. (1569) for the gratuitous maintenance of a certain number of poor students; a museum of natural history, instituted in 1772 under Spallanzani; a botanical garden, commenced in 1774; an agricultural garden, bestowed on the university by Napoleon in 1806; and the oldest anatomical cabinet in Italy. The university library was founded by Maria Theresa in 1754; the famous collection of books which Gian Galeazzo brought together by the aid of Petrarch was carried off to Blois by the French in 1500. The civil hospital of San Matteo is a large and flourishing institution, dating from 1449; like the Borromeo and Ghislieri colleges, it has large landed estates in the circondario. Comparatively few manufactures are prosecuted in Pavia, but there is considerable trade by water as well as by rail, barges being able to pass down the Po to the Adriatic and along the canal to Milan. The population of the city was 27,885 in 1871 and 27,792 in 1881, or, including the suburbs Ticino, Calvenzano, and Borgorato, 29,836; that of the commune was 29,618 in 1871 and 29,941 in 1881.

*History.*—Ticinum—it was not till the close of the 7th century that the city was called Pavia or Pavia—was a place of some importance under the Roman empire, having, according to Pliny, been founded by two Gallic tribes at the time of the first Gallic immigration into Italy. It was at Ticinum that Augustus met the funeral procession of Drusus; and Claudius II. was first saluted emperor by the garrison in the city. Ravaged by Attila in 452 and by Odoacer in 476, Ticinum was, after 489, raised to much more than its former position by Theodoric the Goth, who restored its fortifications and made it the seat of a royal palace. From Theodoric's successors it was recovered for the Eastern empire by Narses; but the imperial garrison, after a siege of more than three years, was obliged by famine to surrender to the Lombards in 573, and Ticinum-Pavia became, as the capital of the Lombard kingdom, one of the leading cities of Italy. By the conquest of Pavia and the capture of Desiderius in 774 Charlemagne completely destroyed the Lombard supremacy; but the city continued to be the centre of the Carolingian power in Italy, and a royal residence was built in the neighbourhood (Corteolons on the Olona). It was in San Michele Maggiore in Pavia that Berengar of Friuli and his quasi-regal successors down to Berengar II. and Adalbert II. were crowned "kings of Italy." Under the reign of the first the city was sacked and burned by the Hungarians, and the bishop was among those who perished in the flames. At Pavia was celebrated in 951 the marriage of Otto I. and Adelheid (Adelaide), which exercised so important an influence on the relations of the empire and Italy; but, when the succession to the crown of Italy came to be disputed between the emperor Henry II. and Harduin of Ivrea, the city sided strongly with the latter. Laid in ruins by Henry, who was attacked by the citizens on the night after his coronation in 1004, it was none the less ready to close its gates on Conrad the Salic in 1026. The jealousy which had meanwhile been growing up between Pavia and Milan having in 1056 broken out into open war, Pavia in the long run had recourse to the hated emperors to aid her against her now more hated rival; and for the most part

she remained, through all the broils and revolutions of the time, attached to the Ghibelline party till the latter part of the 14th century. From 1360, when Galeazzo was appointed imperial vicar by Charles IV., Pavia became practically a possession of the Visconti family, and in due course formed part of the duchy of Milan. For the success which attended its insurrection against the French garrison in 1499 it paid a terrible penalty in 1500, being both given over to pillage and forced to furnish a contribution of 50,000 gold crowns. Having been strongly fortified by Charles V., the city was in 1525 able to bid defiance to Francis I., who was so disastrously beaten in the vicinity; but two years later the French under Lautrec subjected it to a sack of seven days. In 1656 Prince Thomas of Savoy invested Pavia with an army of 20,000 Frenchmen, but had to withdraw after fifty-two days' siege. During the 18th century the city had its full share of the war. The Austrians under Prince Eugene occupied it in 1706, the French in 1738, and the French and Spaniards in 1745; and the Austrians were again in possession from 1746 till 1796. In May of that year it was seized for the French republic by Napoleon, who, to punish it for an insurrection, condemned it to three hours' pillage. The revolutionary movement of February 1848 was crushed by the Austrians and the university was closed; and, though the Sardinian forces obtained possession in March, the Austrians soon recovered their ground. It was not till 1859 that Pavia passed with the rest of Lombardy to the Sardinian crown.

At several periods Pavia has been the centre of great intellectual activity. It was in a tower which, previous to 1584, stood near the church of Dell' Annunziata that Boetius wrote his *De Consolationibus Philosophiæ*; the legal school of Pavia was rendered celebrated in the 11th century by Lanfranc (afterwards archbishop of Canterbury); Christopher Columbus studied at the university about 1447; and printing was introduced in 1471. Two of the bishops of Pavia have been raised to the papal throne as John XIV. and Julius III. Lanfranc, Pope John XIV., Porta the anatomist, and Cremona the mathematician were born in the city.

See Breventano, *Istoria di Pavia*, 1570; Maroni, *De ecclesiis et episcopis papiensibus commentarius*, 1757; Caponi, *Mém. stor. di Pavia*, 1783; Carpanelli, *Compendio istorico delle cose pavesi*, 1817; and various monographs by the local antiquarians Magenta and Dell' Aaqua.

**PAYLOGRAD**, a town of European Russia, at the head of a district in the government of Ekaterinoslaff, on the river Voltch'ya, 13 miles from its junction with the Samara (a tributary of the Dnieper), and a short distance to the left of the railway from Kharkoff to Sebastopol. It dates from the latter half of the 18th century, and was originally known as Luganskoe Selo. It was made a district town of Ekaterinoslaff in 1784. Its population increased from 8653 in 1865 to 11,400 in 1870; and it is the seat of three annual fairs, and has a large trade in cattle.

**PAWN BROKING**. See **PLEDGE**; also **USURY** and **USURY LAWS**.

**PAWTUCKET**, a town of the United States, in Providence county, Rhode Island, 4 miles north-east of Providence by the Providence and Worcester Railroad, is situated on both sides of the navigable Pawtucket river (Blackstone river above the falls), which falls about 50 feet at this point, affording abundant water-power. At Pawtucket in 1790 Samuel Slater erected the first water-power cotton-factory in America. In the early part of the present century Pawtucket was the seat of shipbuilding and of considerable commerce. It is now a place with nearly 100 different industries, including the Conart Thread Works (employing over 2000 hands), large manufactories of cotton and woollen cloths, steam-engines, fire-engines, &c. The exports and imports amount to several million dollars annually. In 1862 Pawtucket, originally belonging to Massachusetts, became part of Rhode Island. The population in 1880 was 19,030, and in 1884 (estimated) about 23,000.

**PAXO**, or **PAXOS**, one of the IONIAN ISLANDS (*q.v.*), about 8 miles south of the southern extremity of Corfu, is a hilly mass of limestone 5 miles long by 2 broad, and not more than 600 feet high. Though it has only a single stream and a few springs, and the inhabitants were often obliged, before the Russians and English provided them with cisterns, to bring water from the mainland, Paxo is well clothed with olives, which produce oil of the very highest quality. Gaion (or, less correctly, Gaia), the principal village, lies on the east coast, and has a small har-

<sup>1</sup> See Professor Magenta's monograph, *I Visconti e gli Sforza nel Castello di Pavia*, Milan, 1884, 2 vols., folio.

bour. Towards the centre, on an eminence, stands Papandi, the residence of the bishop of Paxo, and throughout the island are scattered a large number of churches, whose bellfries add greatly to the picturesqueness of the view. On the west and south-west coasts are some extensive and remarkable caverns, of which an account will be found in Davy's *Ionian Islands*, vol. i. pp. 66-71. Ancient writers—Polybius, Pliny, &c.—do not mention Paxos by itself, but apply the plural form Paxi (Παφοί) to Paxos and the smaller island which is now known as Antipaxo (the Propaxos of the *Antonine Itinerary*). Compare PAN, p. 208 above.

PAXTON, SIR JOSEPH (1803-1865), architect and ornamental gardener, was born of humble parents at Milton Bryant, near Woburn, Bedfordshire, and was educated at the grammar-school of that town. Having served his apprenticeship as gardener, he obtained employment at Chiswick, the seat of the duke of Devonshire, and eventually became superintendent of the duke's gardens and grounds at Chatsworth, and manager of his Derbyshire estates. The design according to which he remodelled the gardens and grounds has awakened the general admiration of landscape gardeners; and he also built a grand conservatory, in which he introduced various improvements of great value in construction and arrangements. To this edifice there attaches a peculiar interest from the fact that it formed the model for the Great Exhibition building of 1851. The happy suggestion of Paxton solved a difficulty which threatened to render it impossible to hold the exhibition, and in recognition of his great services he received the honour of knighthood. On the formation of the Crystal Palace Company he was invited to prepare the design for the building at Sydenham, and was also appointed director of the gardens and grounds. Subsequently he received several commissions as an architect, his most important design being that for the mansion of Baron James de Rothschild at Ferrières in France. His versatility of invention was also shown by his organization of the Army Work Corps which served in the Crimea. In 1854 he was chosen M.P. for Coventry, which he continued to represent, till his death, which occurred at his residence near the Crystal Palace, 8th June 1865. Paxton was elected in 1826 a Fellow of the Horticultural Society, in 1833 a Fellow of the Linnean Society, and in 1844 he was made a knight of the order of St. Vladimir by the emperor of Russia. He is the author of several contributions to the literature of horticulture, including a *Practical Treatise on the Culture of the Dahlia* (1838) and a *Pocket Botanical Dictionary* (1st ed., 1840). He also edited the *Cottage Calendar*, the *Horticultural Register*, and the *Botanical Magazine*.

PAYMENT, in English law, is one of the modes of performance of an obligation, and consists in the discharge of a sum due in money or the equivalent of money. In order that payment may extinguish the obligation it is necessary that it should be made at a proper time and place, in a proper manner, and by and to a proper person. If the sum due be not paid at the appointed time, the creditor is entitled to sue the debtor at once, in spite of the readiness of the latter to pay at a later date, subject, in the case of bills and notes, to the allowance of days of grace. In the common case of sale of goods for ready money, a right to the goods vests at once upon sale in the purchaser, a right to the price in the seller; but the seller need not part with the goods till payment of the price.

Payment may be made at any time of the day upon which it falls due, except in the case of mercantile contracts, where the creditor is not bound to wait for payment beyond the usual hours of mercantile business. If no place be fixed for payment, the debtor is bound to find, or to use reasonable means to find, the creditor, unless the latter be

abroad. Payment must be made in money which is a legal tender (see below), unless the creditor waive his right to payment in money by accepting some other mode of payment, as a negotiable instrument or a transfer of credit. If the payment be by negotiable instrument, the instrument may operate either as an absolute or as a conditional discharge. In the ordinary case of payment by cheque the creditor accepts the cheque conditionally upon its being honoured; if it be dishonoured, he is remitted to his original rights. The creditor has a right to payment in full, and is not bound to accept part payment unless by special agreement. Part payment is sufficient to take the debt out of the Statute of Limitations. It is a technical rule of English law that payment of a smaller sum, even though accepted by the creditor in full satisfaction, is no defence to a subsequent action for the debt. The reason of this rule seems to be that there is no consideration for the creditor foregoing his right to full payment. In order that payment of a smaller sum may satisfy the debt, it must be made by a person other than the person originally liable, or at an earlier date, or at another place, or in another manner than the date, place, or manner contracted for. Thus a bill or note may be satisfied by money to a less amount, or a money debt by a bill or note to a less amount; a debt of £100 cannot be discharged by payment of £90 (unless the creditor execute a release under seal), though it may be discharged by payment of £10 before the day appointed, or by a bill for £10. Payment must in general be made by the debtor or his agent, or by a stranger to the contract with the assent of the debtor. If payment be made by a stranger without the assent of the debtor, it seems uncertain how far English law regards such payment as a satisfaction of the debt. If the debtor ratify the payment, it then undoubtedly becomes a satisfaction. Payment must be made to the creditor or his agent. A *bona fide* payment to an apparent agent may be good, though he has in fact no authority to receive it. Such payment will usually be good where the authority of the agent has been countermanded without notice to the debtor. The fact of payment may be presumed, as from lapse of time. Thus payment of a testator's debts is generally presumed after twenty years. A written receipt is only presumptive and not conclusive evidence of payment. If payment be made under a mistake of fact, it may be recovered, but it is otherwise if it be made under a mistake of law, for it is a maxim of law that *ignorantia legis neminem excusat*. Money paid under compulsion of law, even though not due, cannot generally be recovered where there has been no fraud or extortion.

*Appropriation of Payments.*—Where the creditor has two debts due to him from the same debtor on distinct accounts, the general law is that the appropriation of payments made by the debtor is that the debtor is entitled to apply the payments to such account as he thinks fit. *Solvitur in modum solvantis*. In default of appropriation by the debtor the creditor is entitled to determine the application of the sums paid, and may appropriate them even to the discharge of debts barred by the Statute of Limitations. In default of appropriation by either debtor or creditor, the law implies an appropriation of the earlier payments to the earlier debts.

*Payment into and out of Court.*—Money is generally paid into court to abide the result of pending litigation, as in interpleader proceedings, or where litigation has already begun, as security for costs or as a defence or partial defence to a claim. Payment into court does not necessarily (except in actions for libel and slander) operate as an admission of liability. Money may sometimes be paid into court where no litigation is pending, as under the Trustee Relief Act, 1847. Payment of money out of court is obtained by the order of the court upon petition or summons or otherwise, or simply on the request or the written authority of the person entitled to it.

*Payment of Wages.*—By the "Track Act," 1 and 2 Will. IV. c. 87 (which applies to Great Britain), the payment of wages to most kinds of labourers and workmen otherwise than in coin is prohibited. This Act does not apply to domestic or agricultural servants. The provisions of the Act are extended to the hosiery trade by 87

and 38 Vict. c. 48. Payment of wages in public-houses (except in the case of domestic servants) is illegal by the combined effect of 35 and 36 Vict. cc. 76 and 77, and 46 and 47 Vict. c. 31.

**Tender.**—This is payment duly proffered to a creditor, but rendered abortive by the act of the creditor. In order that a tender may be good in law it must as a rule be made under circumstances which would make it a good payment if accepted. The money tendered must be a legal tender, unless the creditor waive his right to a legal tender, as where he objects to the amount and not the mode of tender. Bank of England notes are legal tender for any sum above £5, except by the bank itself, 3 and 4 Will. IV. c. 98, s. 6. Gold is legal tender to any amount, silver up to 40s., bronze up to 1s., 23 and 24 Vict. c. 10. By 29 and 30 Vict. c. 65 the gold coinage of colonial mints may be made legal tender by proclamation. Under the powers of this Act the gold coinage of the Sydney mint has been declared to be legal tender. The effect of tender is not to discharge the debt, but to enable the debtor, when sued for the debt, to pay the money into court and to get judgment for the costs of his defence.

**Scotland.**—The law of Scotland as to payment agrees in most points with that of England. Where a debt is constituted by writ payment cannot be proved by witnesses; where it is not constituted by writ, payment to the amount of £100 Scots may be proved by witnesses; beyond that amount it can only be proved by writ or oath of party. The term tender seems to be strictly applied only to a judicial offer of a sum for damages and expense made by the defendant during litigation, not to an offer made by the debtor before litigation. Bank of England notes are not a legal tender in Scotland, 8 and 9 Vict. c. 38, s. 15, or in Ireland, 8 and 9 Vict. c. 37, s. 6.

**United States.**—In the United States the law as a rule does not materially differ from English law. In some States, however, money may be recovered, even when it has been paid under a mistake of law. The question of legal tender has been an important one. In 1862 Congress passed an Act making treasury notes legal tender. After much litigation, the Supreme Court of the United States finally decided in 1870 in favour of the constitutionality of this Act, both as to contracts made before and after it was passed (see 1 *Kent's Comm.*, p. 252). These notes are legal tender for all purposes except duties on imports and interest on the public debt. All gold coins, silver dollars, and silver coins below the value of a dollar coined before 1854 are legal tender to any amount. Silver coins below the value of a dollar of 1854 and subsequent years are legal tender for sums not exceeding five dollars. Silver three-cent pieces of the dates 1851 to 1853 are legal tender for sums not exceeding thirty cents, those of subsequent years for sums not exceeding five dollars. Coins and foreign coins are not legal tender. Postage currency is not legal tender for private debts (*Bovier's Law Dict.*, "Legal Tender"). It falls exclusively within the jurisdiction of Congress to declare paper or copper money a legal tender. By the constitution of the United States, "no State . . . shall make anything but gold and silver coin a tender in payment of debts" (art. i. s. 10).

**PAYSANDU**, formerly **SAN BENITO**, a port and departmental town of Uruguay, is situated on the left bank of the river Uruguay in 32° 20' S. lat. and 58° 1' W. long., 270 miles by river from Montevideo, and 120 miles by road from Durazno, the present terminus of the railway. The long streets run east and west at right angles to the river, and the slope of the ground makes drainage easy. Paysandu has been a great battle-ground: in 1846, for instance, it was held by Oribo and bombarded by Rivera, and in 1865 it was captured by the Brazilians after a twenty-eight days' siege. But the name is best known in Europe for the ox-tongues, &c., preserved in its extensive *saladeros*. In 1868 the population was about 9000, and it has since considerably increased. Taking Paysandu to mean Father Sandú or Alexander, the inhabitants call themselves Sanduséros.

**PAYTA**, or **PAITA**, a town of Peru, in the province of Piura, with only 2390 inhabitants in 1876, but of importance as the northmost harbour of the Peruvian coast, the port of the city of Piura (San Miguel de), with which it is connected by rail, a regular calling-place for steamers, and a great rendezvous for whaling vessels. It consists of a single narrow street of reed and wattle houses, but there are a good harbour and an iron custom-house. The great drawback of the place used to be want of water, previous to the construction by the Government of an aqueduct from the Chira river. Straw hats, cattle, hides, and cotton are exported. Formerly a rich and flourishing place, Payta has never recovered from the effects of Lord Anson's

attack in 1741, when only two of its churches were spared. There is a raised beach at Payta 300 feet high; the slate and sandstone are covered by conglomerate sand and a gypsum formation containing shells of living species.

**PAZ DE AYACUCHO, LA.** See **LA PAZ**.

**PEA** (*Pisum*), a genus of *Leguminosæ*, consisting of herbs with compound pinnate leaves ending in tendrils, by means of which the weak stems are enabled to support themselves, and with large leafy stipules at the base. The flowers are typically "papilionaceous," with a "standard" or large petal above, two side petals or wings, and two front petals below forming the keel. The stamens are ten,—nine united, the tenth usually free or only slightly joined to the others. The ovary is prolonged into a long, thick, bent style, compressed from side to side at the tip and fringed with hairs. The fruit is a characteristic "legume" or pod, bursting when ripe into two valves, which bear the large globular seeds (peas) on their edges. These seeds are on short stalks, the upper extremity of which is dilated into a shallow cup or aril; the two cotyledons are thick and fleshy, with a radicle bent along their edges on one side. The genus is exceedingly close to *Lathyrus*, being only distinguished technically by the style, which in the latter genus is compressed from above downwards and not thick. It is not surprising, therefore, that under the general name "pea" species both of *Pisum* and of *Lathyrus* are included. The common field or grey pea with compressed mottled seeds and two to four leaflets in *Pisum arvense*, which is cultivated in all temperate parts of the globe, but which, according to the Italian botanists, is truly a native of central and southern Italy. The garden pea, *P. sativum*, is more tender than the preceding, and its origin is not known. It has not been found in a wild state anywhere, and it is considered that it may be a form of *P. arvense*, having, however, from four to six leaflets to each leaf and globular seeds of uniform colour.

*P. sativum* was known to Theophrastus; and De Candolle points out that the word "pison" or its equivalent occurs in the Albanian tongue as well as in Latin, whence he concludes that the pea was known to the Aryans, and was perhaps brought by them into Greece and Italy. Peas have been found in the Swiss lake-dwellings of the bronze period. The garden peas differ considerably in size, shape of pod, degree of productiveness, form and colour of seed, &c. The sugar peas are those in which the inner lining of the pod is very thin instead of being somewhat horny, so that the whole pod can be eaten. Unlike most papilionaceous plants, pea-flowers are perfectly fertile without the aid of insects, and thus do not intercross so freely as most similar plants do. On the other hand, a case is known wherein the pollen from a purple-podded pea applied to the stigma of one of the green-podded sugar peas produced a purple pod, showing that not only the ovule but even the ovary was affected by the cross. The numerous varieties of peas in cultivation have been obtained by cross-fertilization, but chiefly by selection. Peas constitute a highly nutritious article of diet from the large quantity of nitrogenous materials they contain in addition to starchy and saccharine matters.

The *Sweet Pea*, cultivated for the beauty and fragrance of its flowers, is not a true *Pisum*, but a species of *Lathyrus* (*L. odoratus*), a native of southern Europe. The *Chick Pea* (*Cicer arvense*), not cultivated in England, is still farther removed from the true pea. The *Everlasting Pea* of gardens is a species of *Lathyrus*, with very deep fleshy roots, bold foliage, and beautiful but scentless flowers. *L. latifolius*, a British wild plant, is the source of most of the garden varieties.

**PEABODY**, a town of the United States, in Essex county, Massachusetts, 5 miles north-west of Salem. Incorporated as South Danvers in 1855, it adopted its present name in 1868 in honour of the philanthropist George Peabody, who was born in the township, and in 1852 erected there the Peabody Institute, which now contains various memorials of its founder, the portrait of herself presented by Queen Victoria, the Congress medal, &c. Peabody contains a large number of leather and morocco factories, and several glue-works, print-works, &c. Its inhabitants numbered 7343 in 1870 and 9028 in 1880,

PEABODY, GEORGE (1795-1869), philanthropist, was descended from an old yeoman family of Hertfordshire, England, named Pebody or Pebody, who, six generations before his birth, had emigrated to New England. He was born at Danvers (now Peabody), Massachusetts, 18th February 1795. The only regular education he received was at the district school, and when only eleven years of age he became apprentice at a grocery store. At the end of four years he became assistant to his brother, who kept a dry goods shop, and a year afterwards, on the shop being burned, to his uncle, who had a business in George Town, District of Columbia. After serving as a volunteer at Fort Warburton in the short war between Great Britain and the United States in 1812, he became partner with Eliaha Riggs in a dry goods store, Riggs furnishing the capital, while Peabody had the practical management. As bagman he travelled through the western wilds of New York and Pennsylvania and the plantations of Maryland and Virginia. Through his energy and skill the business increased with astounding rapidity, and on the retirement of Riggs about 1830 Peabody found himself at the head of one of the largest mercantile concerns in the world. About 1837 he established himself in London as merchant and money-broker at Wanford Court, City, and in 1843 he withdrew from the concern in America. It is, however, as a sagacious and generous philanthropist that Peabody has made his name a household word. While holding aloof from the strife of politics in the United States, he was ready to give his native country the benefit of his business skill and the aid of his wealth in its financial difficulties. The number of his great benefactions to public objects is too great for bare mention here. It must suffice to name among the more important a gift of £25,000 for educational purposes at Danvers; of £100,000 to found and endow an institution for science in Baltimore, a sum afterwards increased by a second donation of £100,000; of various sums to Harvard University; and of £350,000 for the erection of dwelling-houses for the working-classes in London, which sum was increased by his will to half a million. If this last benefaction has failed to produce the good results anticipated, this has been due to causes for which Peabody was not responsible, and which do not at all detract from the wise beneficence of the gift. He received from the Queen the offer of a baronetcy, but declined it. In 1867 the United States Congress awarded him a special vote of thanks for his many large gifts to public institutions in America. He died at Eaton Square, London, 14th November 1869.

PEACH. By Bentham and Hooker the peach is included under the genus *Prunus* (*Prunus persica*), and its resemblance to the plum is indeed obvious; others have classed it with the almond, *Amygdalus*; while others again have considered it sufficiently distinct to constitute a genus of its own under the name *Pernica*.

In general terms the peach may be said to be a medium-sized tree, with lanceolate, stipulate leaves, borne on long, slender, relatively unbranched shoots, and with the flowers arranged singly, or in groups of two or more, at intervals along the shoots. The flowers have a hollow tube at the base bearing at its free edge five sepals, an equal number of petals, usually concave or spoon-shaped, pink or white, and a great number of stamens. The pistil consists of a single carpel with its ovary, style, stigma, and solitary ovule or twin ovules. This carpel is, in the first instance, free within the flower-tube, but, as growth goes on, the flower-tube and the carpel become fused together into one mass, the flesh of the peach, the inner layers of the carpel becoming woody to form the stone, while the ovule ripens into the kernel or seed. This is exactly the structure of the plum or apricot, and differs from that of the almond,

which is identical in the first instance, only in the circumstance that the fleshy part of the latter eventually becomes dry and leathery and cracks open along a line called the suture.

The nectarine is a variation from the peach, mainly characterized by the circumstance that, while the skin of the ripe fruit is downy in the peach, it is shining and destitute of hairs in the nectarine. That there is no essential difference between the two is, however, shown by the facts that the seeds of the peach will produce nectarines, and *vice versa*, and that it is not very uncommon, though still exceptional, to see peaches and nectarines on the same branch, and fruits which combine in themselves the characteristics of both nectarines and peaches. The blossoms of the peach are formed the autumn previous to their expansion, and this fact, together with the peculiarities of their form and position, requires to be borne in mind by the gardener in his pruning and training operations, as mentioned in *HORTICULTURE* (vol. xii. pp. 272, 273). The only point of practical interest requiring mention here is the very singular fact attested by all peach-growers, that, while certain peaches are liable to the attacks of a parasitic fungus known as mildew, others are not, showing a difference in constitution analogous to that observed in the case of human beings, some of whom will readily succumb to particular diseases, while others seem proof against their attacks. In the case of the peach this peculiarity is in some way connected with the presence of small glandular outgrowths on the stalk, or at the base of the leaf. Some peaches have globular, others reniform glands, others none at all, and these latter trees are much more subject to mildew than are those provided with glands.

The history of the peach, almond, and nectarine is interesting and important as regards the question of the origin of species and the production and perpetuation of varieties. As to the origin of the peach two views are held, that of Alphonse de Candolle, who attributes all cultivated varieties to a distinct species, probably of Chinese origin, and that adopted by many naturalists, but more especially by Darwin, who looks upon the peach as a modification of the almond. The importance of the subject demands that a summary of the principal facts and inferences bearing on this question should be given. In the first place, the peach as we now know it has been nowhere recognized in the wild state. In the few instances where it is said to have been found wild the probabilities are that the tree was an escape from cultivation. Aitchison, however, gathered in the Hazārārakht ravine in Afghanistan a form with different-shaped fruit from that of the almond, being larger and flatter. "The surface of the fruit," he observes, "resembles that of the peach in texture and colour; and the nut is quite distinct from that of 419 [the wild almond]. The whole shrub resembles more what one might consider a wild form of the peach than that of the almond." It is admitted, however, by all competent botanists that the almond is wild in the hotter and drier parts of the Mediterranean and Levantine regions. Aitchison also mentions the almond as wild in some parts of Afghanistan, where it is known to the natives as "bédam," the same word that they apply to the cultivated almond. The branches of the tree are carried by the priests in religious ceremonies. It is not known as a wild plant in China or Japan.

As to the nectarine, of its origin as a variation from the peach there is abundant evidence, as has already been mentioned; it is only requisite to add the very important fact that the seeds of the nectarine, even when that nectarine has been produced by bud-variation from a peach, will generally produce nectarines, or, as gardeners say, "come true."

Darwin brings together the records of several cases, not only of gradations between peaches and nectarines, but also of intermediate forms between the peach and the almond. So far as we know, however, no case has yet been recorded of a peach or a nectarine producing an almond, or *vice versa*, although if all have had a common origin such an event might be expected. Thus the botanical evidence seems to indicate that the wild almond is the source of cultivated almonds, peaches, and nectarines, and consequently that the peach was introduced from Asia Minor or Persia, whence the name *Persica* given to the peach; and Aitchison's discovery in Afghanistan of a form which reminded him of a wild peach lends additional force to this view.

On the other hand, Alphonse de Candolle, from philological and other considerations, considers the peach to be of Chinese origin.



The peach has not, it is true, been found wild in China, but it has been cultivated there from time immemorial; it has entered into the literature and folk-lore of the people; and it is designated by a distinct name, "to" or "tao," a word found in the writings of Confucius five centuries before Christ, and even in other writings dating from the 10th century before the Christian era. Though now cultivated in India, and almost wild in some parts of the north-west, and, as we have seen, probably also in Afghanistan, it has no Sanskrit name; it is not mentioned in the Hebrew text of the Scriptures, nor in the earliest Greek times. Xenophon makes no mention of the peach, though the Ten Thousand must have traversed the country where, according to some, the peach is native, but Theophrastus, a hundred years later, does speak of it as a Persian fruit, and De Candolle suggests that it might have been introduced into Greece by Alexander. According to his view, the seeds of the peach, cultivated for ages in China, might have been carried by the Chinese into Kashmir, Bokhara, and Persia between the period of the Sanskrit emigration and the Græco-Persian period. Once established, its cultivation would readily extend westward, or, on the other hand, by Cabul to north-western India, where its cultivation is not ancient. While the peach has been cultivated in China for thousands of years, the almond does not grow wild in that country, and its introduction is supposed not to go back farther than the Christian era.

On the whole, we should be inclined to attribute greater weight to the evidence from botanical sources than to that derived from philology, particularly since the discovery both of the wild almond and of a form like a wild peach in Afghanistan. It may, however, well be that both peach and almond are derived from some pre-existing and now extinct form whose descendants have spread over the whole geographic area mentioned; but of course this is a mere speculation, though indirect evidence in its support might be obtained from the nectarine, of which no mention is made in ancient literature, and which, as we have seen, originates from the peach and reproduces itself by seed, thus offering the characteristics of a species in the act of developing itself. (M. T. M.)

**PEACOCK** (the first syllable from the Latin *Pavo*, in Anglo-Saxon *Pawe*, Dutch *Pauuw*, German *Pfau*, French *Paon*), the bird so well known from the splendid plumage of the male, and as the proverbial personification of pride. A native of the Indian peninsula and Ceylon, in some parts of which it is very abundant, its domestication dates from times so remote that nothing can be positively stated on that score. Setting aside its importation to Palestine by Solomon (1 Kings x. 22; 2 Chron. ix. 21), its assignment in classical mythology as the favourite bird of Hera or Juno testifies to the early acquaintance the Greeks must have had with it; but, though it is mentioned by Aristophanes and other older writers, their knowledge of it was probably very slight until after the conquests of Alexander. Throughout all succeeding time, however, it has never very freely rendered itself to domestication, and, retaining much of its wild character, can hardly be accounted an inhabitant of the poultry-yard, but rather an ornamental denizen of the pleasure-ground or shrubbery; while, even in this condition, it is seldom kept in large numbers, for it has a bad reputation for doing mischief in gardens, it is not very prolific, and, though in earlier days highly esteemed for the table,<sup>1</sup> it is no longer considered the delicacy it was once thought.

As in most cases of domestic animals, pied or white varieties of the ordinary Peacock, *Pavo cristatus*, are not unfrequently to be seen; and, though lacking in proportion the gorgeous resplendence for which the common bird stands unsurpassed, they are valued as curiosities. Greater interest, however, attends what is known as the "japanned" Peacock, often erroneously named the Japanese or Japan Peacock, a form which has received the name of *P. nigripennis*, as though it were a distinct species. In this form the cock, besides other less conspicuous differences, has all the upper wing-coverts of a deep lustrous blue instead of being mottled with brown and white, while the hen is of a more or less greyish-white, deeply tinged

<sup>1</sup> Classical authors contain many allusions to its high appreciation at the most sumptuous banquets; and mediæval bills of fare on state occasions nearly always include it. In the days of chivalry one of the most solemn oaths was taken "on the Peacock", which seems to have been served up garnished with its gaudy plumage.

with dull yellowish-brown near the base of the neck and shoulders. It "breeds true"; but occasionally a presumably pure stock of birds of the usual coloration throws out one or more having the "japanned" plumage, leading to the conclusion that the latter may be due to "reversion to a primordial and otherwise extinct condition of the species", and it is to be observed that the "japanned" male has in the coloration of the parts mentioned no little resemblance to that of the second indubitably good species, the *P. muticus* (or *P. spicifer* of some writers) of Burma and Java, though the character of the latter's crest—the feathers of which are barbed along their whole length instead of at the tip only—and its golden-green neck and breast furnish a ready means of distinction. The late Sir R. Heron was confident that the "japanned" breed had arisen in England within his memory,<sup>2</sup> and Darwin (*Anim. and Plants under Domestication*, i. pp. 290-292) was inclined to believe it only a variety; but its abrupt appearance, which rests on indisputable evidence, is most suggestive in the light that it may one day throw on the question



"Japanned" or "black-shouldered" Peafowls.

of evolution as exhibited in the origin of "species". It should be stated that the "japanned" bird is not known to exist anywhere as a wild race. The accompanying woodcut is copied from a plate drawn by Mr Wolf, given in Mr Elliot's *Monograph of the Phasianidae*.

The Peafowls belong to the group *Gallinæ*, from the normal members of which they do not materially differ in structure; and, though by some systematists they are raised to the rank of a Family, *Phasianidae*, most are content to regard them as a Subfamily of *Phasianidae* (PHEASANT, *q.v.*). Akin to the genus *Pavo* is *Polyplectrum*, of which the males are armed with two or more spurs on each leg, and near them is generally placed the genus *Argusianus*, containing the Argus-Pheasants, remarkable for their wonderfully ocellated plumage, and the extraordinary length of the secondary quills of their wings, as well as of the tail-feathers. It must always be remembered that the so-called "tail" of the Peacock is formed not by the rectrices or true tail-feathers, but by the singular development of the tail-coverts, a fact of which any one may be satisfied by looking at the bird when these magnificent plumes are erected and expanded in disk-like form as is his habit when displaying his beauty to his mates. (A. N.)

**PEACOCK, GEORGE** (1791-1858), mathematician, was born at Thornton Hall, Denton, near Darlington, 9th April

<sup>2</sup> This is probably not the case. The present writer has a distinct recollection of having seen a bird of this form represented in an old Dutch picture, though when or where he cannot state.

1791. He was educated at Richmond, Yorkshire, and entered Trinity College, Cambridge, in 1809. He was second wrangler in the mathematical tripos of 1812 (Sir J. F. W. Herschel being senior), was elected fellow of his college in 1814, and became assistant tutor and lecturer in 1815, full tutor in 1823, and sole tutor of "his side" in 1835. Peacock distinguished himself by his business capacity, and by his broad views of the duties and functions of the educational institution in whose management he had so large a share.

Peacock was all his life an ardent educational reformer. While still an undergraduate he formed a league with Herschel, Babbage, and Maule to conduct the famous struggle of "d-ism *versus* dot-age," which ended in the introduction into Cambridge of the Continental notation  $\left(\frac{dy}{dx}\right)$  in the infinitesimal calculus to the exclusion of the fluxional notation ( $\dot{y}$ ) of Newton. This was an important reform, not so much on account of the mere change of notation (for nowadays mathematicians follow Lagrange in using both these notations), but because it signified the opening to the mathematicians of Cambridge of the vast storehouse of Continental discoveries. Up to that time Cambridge mathematicians had been resting supinely under the shadow of Newton, despising the Continental methods, but doing nothing to demonstrate the power of their own. The analytical society thus formed in 1813 published various memoirs, and translated Lacroix's *Differential Calculus* in 1816. Peacock powerfully aided the movement by publishing in 1820 *A Collection of Examples of the Application of the Differential and Integral Calculus*, which remains a valuable text-book to this day. He also took a great interest in the general question of university education. In 1841 he published a pamphlet on the university statutes, in which he indicated the necessity for reform; and in 1850 and 1855 he was a member of the commission of inquiry relative to the university of Cambridge.

In 1837 he was appointed Lowndean professor of astronomy. In 1839 he took the degree of D.D., and the same year was appointed by Lord Melbourne to the deanery of Ely. Without in any way neglecting his university duties, Peacock threw himself with characteristic ardour into the duties of this new position. He improved the sanitation of Ely, published in 1840 *Observations on Plans for Cathedral Reform*, and carried out extensive works of restoration in his own cathedral. He was twice prolocutor of the lower house of convocation for the province of Canterbury.

This list by no means exhausts the sphere of Peacock's activity. He was a prime mover in the establishment of the Cambridge Astronomical Observatory, and in the founding of the Cambridge Philosophical Society. He was a fellow of the Royal, Royal Astronomical, Geological, and other scientific societies. In 1838, and again in 1843, he was one of the commissioners for standards of weights and measures; and he also furnished valuable information to the commissioners on decimal coinage, a matter in which he took great interest. He died on the 8th November 1858, before the university commission, in whose work he took so great an interest, had finished its labours.

It will excite little surprise that a man of so many occupations should have left more mark upon the men of his own day than upon the science of the succeeding generation. Although Peacock was most distinguished and will be longest remembered as a mathematician, it would be difficult to point to much work of his which is of importance at the present day. His original contributions to mathematical science were concerned chiefly with the philosophy of its first principles. He did good service in systematizing the operational laws of algebra, and in throwing light upon the nature and use of imaginaries. His work in this field was, however, thrown into the shade by the later and farther-reaching discoveries of Hamilton and Grassmann. Two great services he did for mathema-

tical education which deserve especial mention. He published, first in 1830, and then in an enlarged form in 1842, a *Treatise on Algebra*, in which he applied his philosophical ideas concerning algebraical analysis to the elucidation of its elements. This text-book was probably too far ahead of his age, for it does not seem to have come into very general use; at all events, it might with great advantage be studied by the teachers of elementary mathematics at the present day, and is very much superior in method and arrangement to any of the English text-books at present in vogue. The second great service was the publication in the *British Association Reports* for 1833 of his "Report on the Recent Progress and Present State of certain branches of Analysis." English mathematicians of this generation will doubtless find on reading this brilliant summary a good many dicta which they will call in question, and they will see a good deal of evidence that Peacock did not always fully appreciate, or perhaps always quite understand, the work of the foremost Continental mathematicians of his time; but they will be ready to condone these shortcomings when they remember that they were carried on the shoulders of Peacock and his "d-istic league" out of the mire into which English mathematics had fallen, and that it is but natural that they should catch a better view of the surrounding scenery than did their bearer. Whatever its defects may be, Peacock's report remains a work of permanent value, one of the first and one of the best of those valuable summaries of scientific progress which have enriched the annual volumes of the British Association, and which would have justified its existence had it done nothing else for the advancement of science.

PEACOCK, THOMAS LOVE (1785-1866), novelist and poet, was born at Weymouth, 18th October 1785. His father, a glass merchant in London, died soon after his son's birth, and young Peacock received his education at a private school at Englefield Green, where he distinguished himself by unusual precocity. After a brief experience of business he elected to devote himself to study and the pursuit of literature, living with his mother on their private means. His first books were poetical, *The Monks of St Mark* (1804), *Palmyra* (1806), *The Genius of the Thames* (1810), *The Philosophy of Melancholy* (1812),—works of no great merit. He also made several dramatic attempts, which did not find their way to the stage. He served for a short time as secretary to Sir Home Popham at Flushing, and paid several visits to Wales. In 1812 he became acquainted with Shelley, who made him his executor together with Lord Byron. In 1815 he evinced his peculiar power by writing *Headlong Hall*, the prototype of all his subsequent novels. It was published in 1816, and *Melincourt* followed in the ensuing year. During 1817 he lived at Great Marlow, enjoying the almost daily society of Shelley, and writing *Nightmare Abbey* and *Rhododaphne*, by far the best of his long poems. In 1819 he received the appointment of assistant examiner at the India House, at the same time as Mill and Strachey. Peacock's nomination appears to have been due to the influence of his old schoolfellow Peter Auber, secretary to the East India Company, and the papers he prepared as tests of his ability were returned to him with the high encomium, "Nothing superfluous and nothing wanting." This was characteristic of the whole of his intellectual work; and equally characteristic of the man was his marriage about this time to a Welsh lady, to whom he proposed by letter, not having seen her for eight years. His official duties greatly interfered with independent composition. *Maid Marian* nevertheless appeared in 1822, *The Misfortunes of Elphin* in 1829, and *Crochet Castle* in 1831; and he would probably have written more but for the death in 1833 of his mother, to whom he was deeply attached. He also contributed to the *Westminster Review* and the *Examiner*. His services to the East India Company, outside the usual official routine, were considerable. He defended it successfully against the attacks of Mr J. S. Buckingham and the Liverpool salt interest, and made the subject of steam navigation to India peculiarly his own. He represented the company before the various parliamentary committees on this question; and in 1839 and 1840 superintended the construction of iron steamers,

which not only made the voyage round the Cape successful, but proved very useful in the Chinese war. He also framed instructions for the Euphrates expedition, pronounced by General Chesney to be models of sagacity. In 1836 he succeeded Mill as chief examiner, and in 1856 he retired upon a pension. During his later years he contributed several papers to *Fraser's Magazine*, including reminiscences of Shelley. He also wrote in the same magazine his last novel, *Gryll Grange* (1860), inferior to his earlier writings in humour and vigour, but still a surprising effort for a man of his age. He died 23d January 1866 at Lower Halliford, near Chertsey, where, so far as his London occupations would allow him, he had resided for more than forty years.

Peacock's position in English literature is unique. There was nothing like his type of novel before his time; though there might have been if it had occurred to Swift to invent a story as a vehicle for the dialogue of his *Polite Conversations*. But, while Swift's interlocutors represent ordinary types, Peacock's are highly exceptional; while the humour of the former consists in their stereotyped conventionality or unconscious folly, the talk in Peacock's novels is brilliant; and, while Swift's characters utter proverbs, Peacock's are equipped from the author's own stores of humorous observation or reflexion. He speaks as well in his own person as through his puppets; and perhaps no writer since Pope has enriched English literature with such an abundance of quotable things. This pithy wit and sense, combined with remarkable grace and accuracy of natural description, atone for the primitive simplicity of plot and character. There is just enough of both to keep the story going, and the author's plan required no more. Of his seven fictions, *Nightmare Abbey* and *Crotchet Castle* are perhaps on the whole the best, the former displaying the most *vis comica* of situation, the latter the fullest maturity of intellectual power, and the most skilful grouping of the motley crowd of "perfectibilians, deteriorationists, statu-quo-ites, phrenologists, transcendentalists, political economists, theorists in all sciences, projectors in all arts, morbid visionaries, romantic enthusiasts, lovers of music, lovers of the picturesque, and lovers of good dinners," who constitute the *dramatis personae* of that comedy in narrative, the Peacockian novel. *Maid Marian* and *The Misfortunes of Elphin* are hardly less entertaining, but are somewhat cramped by the absence of portraiture from the life and the necessity for historical colouring. Both contain descriptive passages of extraordinary beauty. *Melincourt* is a comparative failure, the excellent idea of an orang-outang mimicking humanity being insufficient as the sole groundwork of a novel. *Headlong Hall*, though more than foreshadowing the author's subsequent excellence, is marred by a certain bookish awkwardness characteristic of the recluse student, which reappears in *Gryll Grange* as the pedantry of an old-fashioned scholar, whose likes and dislikes have become inveterate and whose sceptical liberalism, always rather inspired by hatred of cant than enthusiasm for progress, has petrified into only too earnest conservatism. Pianos and perspective equally with competitive examinations and "panto-pragmatism" are the objects of the writer's distaste, and for the first time in his career we feel inclined to laugh at him, being no longer able to laugh with him. The book's quaint resolute paganism, however, is very refreshing in an age eaten up with introspection; it is the kindest of Peacock's writings, and contains the most beautiful of his poems, "Years Ago," the reminiscence of an early attachment. In general the ballads and songs interspersed through his tales are models of exact and melodious diction, and instinct with true feeling. His more ambitious poems are worth little, except *Rhododaphne*, attractive as a story and perfect as a

composition, but destitute of genuine poetical inspiration. His critical and miscellaneous writings are always interesting, especially the restorations of lost classical plays in the *Horns Dramatics*, but the only one of great mark is the witty and crushing exposure in the *Westminster Review* of Moore's ignorance of the manners and belief he has ventured to portray in his *Epicureans*. Peacock resented the misrepresentation of his favourite sect, the good and ill of whose tenets were fairly represented in his own person. Somewhat sluggish and self-indulgent, incapable of enthusiasm or self-sacrifice, he yet possessed a deep undemonstrative kindness of nature; he could not bear to see any one near him unhappy or uncomfortable; and his sympathy, no less than his genial humour, gained him the attachment of children, dependants, and friends. His feelings were steady rather than acute; he retained throughout life with touching fidelity the memory of an early affection. In official life he was upright and conscientious; his judgment was shrewd and robust, and the quaint crotchets and prejudices which contrasted so curiously with his usual sagacity were in general the exaggeration of sound ideas held with undue exclusiveness. As a candidate for literary immortality he should be safe. The same causes which restrict his popularity ensure his permanence. His novels depend but slightly on temporary phases of manners, but are vitally associated with standard literature, and with general tendencies innate in the human mind. Neither his intellectual liberalism nor his constitutional conservatism will ever be out of date; and what Shelley justly termed "the lightness, strength, and chastity" of his diction secures him an honourable rank among those English writers whose claims to remembrance depend not only upon matter but upon style.

Peacock's works were collected, though not completely, and published in three volumes in 1875, at the expense of his friend and former protégé, Sir Henry Cole, with an excellent memoir by his grand-daughter Mrs Clarko, and a critical essay by Lord Houghton. Other criticisms have been written, by Mr Spedding in the *Edinburgh Review* and by James Hannay in the *North British Review*. For an interesting personal notice, see *A Poet's Sketch Book*, by R. W. Buchanan, 1884. (R. G.)

**PEAR** (*Pyrus communis*). The pear has essentially the same floral structure as the apple. In both cases the so-called fruit is composed of the flower-tube or upper end of the flower-stalk greatly dilated, and enclosing within its cellular flesh the five cartilaginous carpels which constitute the "core" and are really the true fruit. From the upper rim of the flower-tube or receptacle are given off the five sepals, the five petals, and the very numerous stamens. The form of the pear and of the apple respectively, although usually characteristic enough, is not by itself sufficient to distinguish them, for there are pears which cannot by form alone be distinguished from apples, and apples which cannot by superficial appearance be recognised from pears. The main distinction is the occurrence in the tissues of the fruit, or beneath the rind, of clusters of cells, filled with hard woody deposit in the case of the pear, constituting the "grit," while in the apple no such formation of woody cells takes place. The appearance of the tree—the bark, the foliage, the flowers—is, however, usually quite characteristic in the two species. Cultivated pears, whose number is enormous, are without doubt derived from one or two wild species widely distributed throughout Europe and western Asia, and sometimes forming part of the natural vegetation of the forests. In England, where the pear is sometimes considered wild, there is always the doubt that it may not really be so, but the produce of some seed of a cultivated tree deposited by birds or otherwise, which has degenerated into the wild spine-bearing tree known as *Pyrus commensis*.

The cultivation of the pear extends to the remotest:

antiquity. Traces of it have been found in the Swiss lake-dwellings; it is mentioned in the oldest Greek writings, and was cultivated by the Romans. The word "pear" or its equivalent occurs in all the Celtic languages, while in Slavonic and other dialects different appellations, but still referring to the same thing, are found,—a diversity and multiplicity of nomenclature which leads De Candolle to infer a very ancient cultivation of the tree from the shores of the Caspian to those of the Atlantic. A certain race of pears, with white down on the under surface of their leaves, is supposed to have originated from *P. nivalis*, and their fruit is chiefly used in France in the manufacture of PERRY (*q.v.*). Other small-fruited pears, distinguished by their precocity and apple-like fruit, may be referred to *P. cordata*, a species found wild in western France, and in Devonshire and Cornwall.

The late Professor Karl Koch considered that cultivated pears were the descendants of three species—*P. persica* (from which the bergamots have descended), *P. sinensis*, and *P. sinensis*. DeCandolle, who made the subject one of critical study for a number of years, and not only investigated the wild forms, but carefully studied the peculiarities of the numerous varieties cultivated in the Jardin des Plantes, refers all cultivated pears to one species, the individuals of which have in course of time diverged in various directions, so as to form now six races:—(1) the Celtic, including *P. cordata*; (2) the Germanic, including *P. communis*, *P. achras*, and *P. pyrastrer*; (3) the Hellenic, including *P. parviflora*, *P. sinatica*, and others; (4) the Pontic, including *P. sinensis*; (5) the Indian, comprising *P. paschei*; and (6) the Mongolic, represented by *P. sinensis*. With reference to the Celtic race, *P. cordata*, it is interesting to note its connexion with Arthurian legend, and the Isle of Avalon or Isle of Apples. An island in Loch Awe has a Celtic legend containing the principal features of Arthurian story; but in this case the word is "berries" instead of "apples." Dr Phené visited Armorica (Brittany) with a view of investigating these matters, and brought thence fruits of a small berry-like pear, which were identified by the writer with the *Pyrus cordata* of western France, as well as with a tree which had then been recently discovered in some parts of Devonshire and Cornwall by Mr Briggs. (For cultivation of pears see HORTICULTURE, vol. xii. p. 274.)

**PEARL.** Pearls are calcareous concretions of peculiar lustre, produced by certain mollusca, and valued as objects of personal ornament. It is believed that most pearls are formed by the intrusion of some foreign substance between the mantle of the mollusc and its shell, which, becoming a source of irritation, determines the deposition of nacreous matter in concentric layers until the substance is completely encysted. The popular notion that the disturbing object is commonly a grain of sand seems untenable; according to Dr Gwyn Jeffreys and some other conchologists, it is in most cases a minute parasite; while Dr Kelaart has suggested that it may be the frustule of a diatom, or even one of the ova of the pearl-producing mollusc itself. The experience of pearl-fishers shows that those shells which are irregular in shape and stunted in growth, or which bear excrescences, or are honeycombed by boring parasites, are those most likely to yield pearls.

The substance of a pearl is essentially the same as that which lines the interior of many shells, and is known as "mother-of-pearl."—Sir D. Brewster first showed that the iridescence of this substance was an optical phenomenon due to the interference of rays of light reflected from microscopic corrugations of the surface—an effect which may be imitated by artificial striations on a suitable medium. When the inner laminated portion of a nacreous shell is digested in acid the calcareous layers are dissolved away, leaving a very delicate membranous pellicle, which, as shown by Dr Carpenter, may retain the iridescence as long as it is undisturbed, but which loses it when pressed or stretched.

Although a large number of molluscs secrete MOTHER-OF-PEARL (*q.v.*), only a few of them yield true pearls. The finest are obtained from the so-called "pearl oyster," the *Avicula (Melaugrina) margaritifera*, Linnaeus, while fresh-

water pearls are procured chiefly from the "pearl mussel," *Unio (Margaritana) margaritifera*, L.<sup>1</sup> These river-pearls are generally of dull leaden hue, and inferior in beauty to those of marine origin.

It is obvious that if a pearl presents a perfectly spherical form it must have remained loose in the substance of the muscles or other soft tissues of the mollusc. Frequently, however, the pearl becomes cemented to the interior of the shell, the point of attachment thus interfering with its symmetry. In this position it may receive successive nacreous deposits, which ultimately form a pearl of hemispherical shape, so that when cut from the shell it may be flat on one side and convex on the other, forming what jewellers know as a "perle bouton." In the course of growth the pearl may become involved in the general deposit of mother-of-pearl, and be ultimately buried in the substance of the shell. It has thus happened that fine pearls have occasionally been unexpectedly brought to light in cutting up mother-of-pearl in the workshop.

When a pearl oyster is attacked by a boring parasite the mollusc protects itself by depositing nacreous matter at the point of invasion, thus forming a hollow body of irregular shape known as a "blister pearl." Hollow warty pearl is sometimes termed in trade "coq de perle." Solid pearls of irregular form are often produced by deposition on rough objects, such as small fragments of wood, and these, and in fact all irregular-shaped pearls, are termed "perles baroques" or "barrok pearls." It appears that the Romans in the period of the Decline restricted the name *unio* to the globular pearl, and termed the baroque *margaritum*. It was fashionable in the 16th and 17th centuries to mount curiously-shaped baroques in gold and enamel so as to form ornamental objects of grotesque character. A valuable collection of such mounted pearls by Dinglinger is preserved in the Green vaults at Dresden.

A pearl of the first water should possess, in jewellers' language, a perfect "akin" and a fine "orient"; that is to say, it must be of delicate texture, free from speck or flaw, and of clear almost translucent white colour, with a subdued iridescent sheen. It should also be perfectly spherical, or, if not, of a symmetrical pear-shape. On removing the outer layer of a pearl the subjacent surface is generally dull, like a dead fish-eye, but it occasionally happens that a poor pearl encloses a "lively kernel," and may therefore be improved by careful peeling. The most perfect pearl in existence is said to be one, known as "La Pellegrina," in the museum of Zoëma in Moscow; it is a perfectly globular Indian pearl of singular beauty, weighing 28 carats. The largest known pearl is one of irregular shape in Mr Beresford Hope's collection at the South Kensington museum. This magnificent pearl weighs 3 oz., has a circumference of 4½ inches, and is surmounted by an enamelled and jewelled gold crown, forming a pendant of great value.

**Pearl Fisheries.**—The ancients obtained their pearls chiefly from India and the Persian Gulf, but at the present time they are also procured from the Sulu seas, the coast of Australia, the shores of Central America, and some of the South Pacific islands. The ancient fisheries of Ceylon (Taprobane) are situated in the Gulf of Manaar, the fishing-

<sup>1</sup> *Melaugrina margaritifera*, L., belongs to the family *Aviculidae* of most zoologists, to the family *Aviculaceæ*, order *Monomya*, of article MOLLUSCA. *Melaugrina* is merely a sub-genus of *Avicula*. The animal which produces fresh-water pearls in Britain and other parts of Europe was named *Unio margaritifera* by Beudant in *Nouv. Gen. Test.*, and this is the name adopted by most modern zoologists; the animal was placed in a separate genus, *Margaritana*, by Schumacher for insufficient reasons. It belongs to the order *Isomya*, family *Unionacea*. The molluscs from which river-pearls are obtained in the United States and other parts of the world are mostly species of *Unio* or *Anodonta*. The above are all Lamellibranchia.



banks lying from 6 to 8 miles off the western shore, a little to the south of the isle of Manaar. The Tinnevely fishery is on the Madras side of the strait, near Tuticorin. These Indian fishing-grounds are under the control of Government inspectors, who regulate the fisheries, and permit fishing only when they consider the banks to be in a satisfactory condition. The oysters yield the best pearls at about four years of age. Fishing, when permitted, generally commences in the second week in March, and lasts for from four to six weeks, according to the season. The boats are grouped in fleets of from sixty to seventy, and start usually at midnight so as to reach the oyster-banks at sunrise. Each boat generally carries ten divers. On reaching the bank a signal-gun is fired, and diving commences. To facilitate the descent of the diver, a stone of granite weighing about 40 lb is attached to the cord by which he is let down. The divers work in pairs, one man diving while the other watches the signal-cord, drawing up the sink-stone first, then hauling up the baskets of oysters, and finally raising the diver himself. On an average the divers remain under water from fifty to eighty seconds, though some can endure a much longer submergence, and exceptional instances are cited of men remaining below for as long as six minutes. After resting for a minute or two at the surface, the diver descends again; and so on, until exhausted, when he comes on board and watches the rope, while his comrade relieves him as diver. Using neither diving dress nor bell, the native descends naked, carrying only a girdle for the support of the basket in which he places the pearl-oysters. In his submarine work the diver makes skilful use of his toes for prehensile purposes. To arm himself against the attacks of the sharks and other fishes which infest the Indian waters, he carries spikes of ironwood; and the genuine Indian diver never descends without the incantations of shark-charmers, one of whom accompanies the boat while others remain on shore. Not only is the diver exposed to the danger of attack by sharks, but his exciting calling, in a tropical climate, is necessarily exhausting, and as a rule he is a short-lived man.

The diving continues from sunrise to about noon, when a gun is fired, and the work stopped. On the arrival of the fleet at shore, the divers carry their oysters to a shed, where they are made up into four heaps, one of which is taken by the diver as his remuneration. The oysters are then sold by auction in lots of 1000 each. The pearls, after removal from the dead oysters, are "classed" by passing through a number of small brass cullenders, known as "baskets," the holes in the successive vessels being smaller and smaller. Having been sized in this way, they are sorted as to colour, weighed, and valued. (For the history and production of the Ceylon fishery, see *Ceylon*, vol. v. p. 364.)

Since the days of the Macedonians pearl-fishing has been carried on in the Persian Gulf. It is said that the oyster-beds extend along the entire Arabian coast of the gulf, but the most important are on sandbanks off the islands of Bahrein. According to Colonel Pelly's report in 1863, there were 1500 boats belonging to Bahrein alone, and the annual profit from the pearl-fishery was about £400,000. The chief centre of the trade is the port of Lingah. Most of the products of this fishery are known as "Bombay pearls," from the fact that many of the best are sold there. The shells usually present a dark colour about the edges, like that of "smoked pearl." The yellow-tinted pearls are sent chiefly to Bombay, while the whitest go to Baghdad. Very small pearls, much below a pea in size, are generally known as "seed-pearls," and these are valued in India and China as constituents of certain electuaries, while occasionally they are calcined for *chunam*, or

lime, used with betel as a masticatory. There is a small pearl-fishery near Kurrachee on the coast of Bombay.

From the time of the Ptolemies pearl-fishing has been prosecuted along the coast of the Red Sea, especially in the neighbourhood of Jiddah and Koseir. This fishery is now insignificant, but the Arabs still obtain from this district a quantity of mother-of-pearl shells, which are shipped from Alexandria, and come into the market as "Egyptians."

Very fine pearls are obtained from the Sulu Archipelago, on the north-east of Borneo. The mother-of-pearl shells from the Sulu seas are characterized by a yellow colour on the border and back, which unfits them for many ornamental purposes. Pearl-oysters are also abundant in the seas around the Aru Islands to the south-west of New Guinea. From Labuan a good many pearl-shells are occasionally sent to Singapore. They are also obtained from the neighbourhood of Timor, and from New Caledonia. The pearl-oyster occurs throughout the Pacific, mostly in the clear water of the lagoons within the atolls, though fine shells are also found in deep water outside the coral reefs. The Polynesian divers do not employ sink-stones, and the women are said to be more skilful than the men. They anoint their bodies with oil before diving. Fine pearl-shells are obtained from Navigators' Islands, the Society Islands, the Low Archipelago or Paumotu Isles, and the Gambier Islands. Many of the Gambier pearls present a bronzy tint.

Pearl-fishing is actively prosecuted along the western coast of Central America, especially in the Gulf of California, and to a less extent around the Pearl Islands in the Bay of Panama. These pearls are obtained from the *Meleagrina californica*, Cpr., and the mother-of-pearl shell is known in commerce as "Panama" or "bullock" shell. The fishing-grounds are in water about 40 feet deep, and the season lasts for four months. An ordinary fishing-party expects to obtain about three tons of shells per day, and it is estimated that one shell in a thousand contains a pearl. The pearls are shipped in barrels from San Francisco and Panama. Some pearls of rare beauty have been obtained from the Bay of Mulege, near Los Coyotes, in the Gulf of California; and in 1882 a pearl of 75 carats, the largest on record from this district, was found near La Pas in California. The coast of Guayaquil also yields pearls. Columbus found that pearl-fishing was carried on in his time in the Gulf of Mexico, and pearls are still obtained from the Caribbean Sea. These are produced chiefly by *Meleagrina squamulosa*, Lam.; and the mother-of-pearl shells are known as "blue-edged" or "black-lipped," these being less valuable than the "silver-lipped" shells of India. In the West Indies the best pearls are obtained from St Thomas and from the island of Margarita, off the coast of Venezuela. From Margarita Philip II. of Spain is said to have obtained in 1579 a famous pearl of 250 carats.

Of late years pearl-fishing has been started with considerable success in the Australian seas. Good pearls are found in Shark's Bay, on the coast of West Australia, especially in an inlet termed Useless Harbour. Mother-of-pearl shells are also fished at many other points along the western coast, between the 15th and 25th parallels of south latitude. An important pearl-fishery is also established in Torres Strait and on the coast of Queensland. The shells occur in water from four to six fathoms deep, and the divers are generally Malays and Papuans, though sometimes native Australians. On the western coast of Australia the pearl-shells are obtained by dredging rather than by diving. Quite recently (1884) pearl-shells have been found at Port Darwin. Pearls have also been found in Oakley Creek, New Zealand.

*Non-pearls* are produced by the fresh-water mussels inhabiting

the mountain-streams of temperate climates in the northern hemisphere,—especially in Scotland, Wales, Ireland, Saxony, Bohemia, Bavaria, Lapland, and Canada. The pearls of Britain are mentioned by Tacitus and by Pliny, and a breastplate studded with British pearls was dedicated by Julius Cæsar to Venus Genetrix. As early as 1356 Scotch pearls are referred to in a statute of the goldsmiths of Paris; and in the reign of Charles II. the Scotch pearl trade was sufficiently important to attract the attention of parliament. Writing in 1705, John Spruel says, "I have dealt in pearls these forty years and more, and yet to this day I could never sell a necklace of fine Scots pearl in Scotland, nor yet fine pendants, the generality seeking for Oriental pearls, because farther fetched. At this very day I can show some of our own Scots pearl as fine, more hard and transparent, than any Oriental" (*An Account Current betwixt Scotland and England*, Edinburgh, 1705). The Scotch pearl-fishery, after having declined for years, was revived in 1860 by a German named Moritz Unger, who visited Scotland and bought up all the pearls he could find in the hands of the peasantry, thus leading to an eager search for more pearls the following season. It is estimated that in 1865 the produce of the season's fishing in the Scotch rivers was worth at least £12,000. This yield, however, was not maintained; the rivers were over-fished, and the industry was discouraged inasmuch as it tended to interfere with the salmon-fishery, and in some cases injured the banks of the streams. At the present time only a few pearls are obtained at irregular intervals by an occasional fisherman.

The principal rivers in Scotland which have yielded pearls are the Spey, the Tay, and the South Esk; and to a less extent the Doon, the Dee, the Don, the Ythan, the Teith, the Forth, and many other streams. In North Wales the Conway was at one time celebrated for its pearls; and it is related that Sir Richard Wynn, chamberlain to the queen of Charles II., presented her with a Conway pearl which is believed to occupy a place in the British crown. In Ireland the rivers of Donegal, Tyrone, and Wexford have yielded pearls. It is said that Sir John Hawkins the circumnavigator had a patent for pearl-fishing in the Ir in Cumberland. Although the pearl-fisheries of Britain are now neglected, it is otherwise with those of Germany. The most important of these are in the forest-streams of Bavaria, between Ratibon and Passau. The Saxon fisheries are chiefly confined to the basin of the White Elster, and those of Bohemia to the Horadiowitz district of Wotawa. For more than two centuries the Saxon fisheries have been carefully regulated by inspectors, who examine the streams every spring, and determine where fishing is to be permitted. After a tract has been fished over, it is left to rest for ten or fifteen years. The fisher folk open the valves of the mussels with an iron instrument, and if they find no pearl restore the mussel to the water.

River-pearls are found in many parts of the United States, and have been systematically worked in the Little Miami river, Warren county, Ohio. The season extends from June to October. Japan produces freshwater pearls, found especially in the *Asadonta japonica*. But it is in China that the culture of the pearl-mussel is carried to the greatest perfection. The Chinese also obtain marine pearls, and use a large quantity of mother-of-pearl for decorative purposes. More than twenty-two centuries before our era pearls are enumerated as a tribute or tax in China; and they are mentioned as products of the western part of the empire in the *Sh'ya*, a dictionary compiled earlier than 1000 a.c. A process for promoting the artificial formation of pearls in the Chinese river-mussels was discovered by Ye-jin-yang, a native of Hoochow, in the 13th century; and this process is still extensively carried on near the city of Teh-tsing, where it forms the staple industry of several villages, and is said to give employment to about 5000 people. Large numbers of the mussels are collected in May and June, and the valves of each are gently opened with a spatula to allow of the introduction of various foreign bodies, which are inserted by means of a forked bamboo stick. These "matrixes" are generally pellets of prepared mud, but may be small bosses of bone, brass, or wood. After a number of these objects have been placed in convenient positions on one valve, the unfortunate mollusc is turned over and the operation is repeated on the other valve. The mussels are then placed in shallow ponds connected with the canals, and are nourished by tubs of night-soil being thrown in from time to time. After several months, in some cases two or three years, the mussels are removed, and the pearls which have formed over the matrixes are cut from the shells, while the molluscs themselves serve as food. The matrix is generally extracted from the pearl and the cavity filled with white wax, the aperture being neatly sealed up so as to render the appearance of the pearl as perfect as possible. Millions of such pearls are annually sold at Soo-chow. The most curious of these Chinese pearls are those which present the form of small seated images of Buddha. The figures are cast in very thin lead, or stamped in tin, and are inserted as previously described. As many as twenty may sometimes be seen, ranged in parallel rows, in the valves of a single individual. Covered with nacreous matter, closely adherent to the shell, they have all the appearance of natural objects, and, exciting the wonder

of the ignorant, are prized as amulets. Specimens of these Buddha pearls in the British Museum are referred to the species *Dipus plicata*. It should be mentioned that Linnæus, probably ignorant of what had long been practised in China, demonstrated the possibility of producing artificial pearls in the freshwater mussels of Sweden.

Pink pearls are occasionally found in the great conch or fountain shell of the West Indies, *Strombus gigas*, L.; but these, though much prized, are not nacreous, and their tint is apt to fade. They are also produced by the chank shell, *Turbinella scylosus*, L. Yellowish-brown pearls, of little or no value, are yielded by the *Pincta squamosa*, and bad-coloured concretions are formed by the *Placuna placenta*.<sup>2</sup> Black pearls, which are very highly valued, are obtained chiefly from the pearl-oyster of the Gulf of Mexico.

Artificial pearls were first made in western Europe in 1630 by Jacquin, a rosy-maker in Paris, and the trade is now largely carried on in France, Germany, and Italy. Spheres of thin glass are filled with a preparation known as "essence d'orient," made from the silvery scales of the bleak or "ablette," which is caused to adhere to the inner wall of the globe, and the cavity is then filled with white wax. The scales are in some cases incorporated with celluloid. Many imitation pearls are now formed of an opaline glass of nacreous lustre, and the soft appearance of the pearl obtained by the judicious use of hydrofluoric acid. An excellent substitute for black pearl is found in the so-called "ironstone jewellery," and consists of close-grained hematite, not too highly polished; but the great density of the hematite immediately destroys the illusion. Pink pearls are imitated by turning small spheres out of the rosy part of the conch shell, or even out of pink coral.

See W. H. Dall, "Pearls and Pearl Fisheries," in *American Naturalist*, xvi., 1882, p. 549; F. L. Rimmonda, *The Commercial Products of the Sea* (London, 1877); Clements R. Markham, "The Tinsely Pearl Fishery," in *Journal Sea, Arts, &c.*, 1867, p. 269; D. T. Macgowan, "Pearls and Pearl-making in China," *Geol. M.*, 1884, p. 73; J. Hagen, "On the Natural and Artificial Production of Pearls in China," in *Journal. E. Asiatic Soc.*, xvi., 1856; H. J. Le Beck, "Pearl Fishery in the Gulf of Manar," in *Asiatic Researches*, v., 1798, p. 298; T. Von Haussling, *Die Perlmuschel und ihre Perlen* (Leipzig, 1859); K. Möbius, *Die schöne Perlen* (Hainburg, 1867). (F. W. L.)

PEARSON, JOHN (1612-1686), a learned English bishop, was born at Great Snoring in the county of Norfolk, on the 28th of February 1612. After attending Eton, he entered Queens' College, Cambridge, 10th June 1631, and was elected a scholar of King's in April following and a fellow in 1634. Entering holy orders in 1639, he was collated to the prebend of Nether-Avon, in the church of Sarum. In 1640 he was appointed chaplain to the lord-keeper Finch, by whom he was presented to the living of Thorington in Suffolk during the same year. In 1650 he was made preacher of St Clement's, Eastcheap, in London. Seven years later he and Peter Gunning had a dispute with two Roman Catholics upon the subject of schism, a one-sided account of which was printed at Paris by one of the Roman Catholic disputants, under the title *Schism Unmasked*, 1658. In 1659 Pearson published at London his celebrated *Exposition of the Creed*, dedicated to his parishioners of St Clement's, Eastcheap, to whom the substance of that now standard work had been preached several years before, and by whom he had been desired to make it public. The same year he likewise published the *Golden Remains of the ever-memorable Mr John Hales of Eton*, to which he prefixed a preface containing a character of that eminent man, with whom he had been acquainted for many years, drawn up with great elegance and force. Pearson had also a principal share in the editing of the *Critici Sacri*, first published in 1660. Soon after the Restoration he was presented by Juxon, then bishop of London, to the rectory of St Christopher's in that city; and he was also in 1660 created doctor of divinity at Cambridge, in pursuance of the king's letters mandatory, installed prebendary of Ely, archdeacon of Surrey, and made master of Jesus College, Cambridge. In 1661 he was appointed Lady Margaret professor of divinity

<sup>1</sup> *Strombus gigas*, L., is a Gastropod belonging to the family Strombidae, of the order Agyrobranchia. *Turbinella scylosus*, Lam., is a Gastropod belonging to the family Muricidae, of the same order.

<sup>2</sup> *Placuna placenta*, L., belongs to the family Ostreidae of the mollusks (family Ostreae of article MOLLUSCA); it is found on the shores of North Australia. *Pincta squamosa*, Gmelin, belongs to the Mytilidae (the Mytilaceæ of article MOLLUSCA); it occurs in the Mediterranean. Both are Lamellibranchia.



in that university; and on the first day of the ensuing year he was nominated one of the commissioners for the review of the liturgy in the conference held at the Savoy. On the 14th of April 1662 he was elected master of Trinity College, Cambridge, and in August resigned his rectory of St Christopher's and his prebend of Ely. In 1667 he was admitted a Fellow of the Royal Society. In 1672 he published at Cambridge *Vindiciae Epistolarum S. Ignatii*, in 4to, in answer to Daillé, to which is subjoined *Isaaci Vossii Epistola aduersus Davidem Blondellum*. Upon the death of Dr. Wilkins in 1672, Pearson was appointed his successor in the see of Chester. In 1682 his *Annales Cypriani* were published at Oxford, with Fell's edition of that father's works. Pearson was disabled from all public service by ill health a considerable time before his death at Chester on the 16th of July 1686. His last work, the *Two Dissertations on the Succession and Times of the First Bishops of Rome*, formed the principal part of his *Opera Posthuma*, edited by Henry Dodwell in 1688.

See the memoir in *Biographia Britannica*, and another by Edward Charbon prefixed to the edition of Pearson's *Minor Theological Works*, 2 vols., Oxford, 1844.

PEAT. See FUEL, vol. ix. p. 808.

PECCARY. Under this name are included two species of small pig-like animals forming the genus *Dicotyles* of Cuvier, belonging to the section *Suina* of the Artiodactyle Ungulates (see MAMMALIA, vol. xv. p. 430). They are peculiar to the New World, and in it are the only surviving members of the large group now represented in the Old World by the various species of swine, babirusas, wart-hogs, and hippopotami.

The teeth of the peccaries differ from those of the true pigs (genus *Sus*) numerically, in wanting the upper outer incisor and the anterior premolar on each side of each jaw, the dental formula being  $i \frac{3}{3}, c \frac{1}{1}, p \frac{3}{3}, m \frac{3}{3}$ , total 38. The upper canines have their points directed downwards, not outwards or upwards as in the boars, and they are very sharp, with cutting hinder edges, and completely covered with enamel until worn. The lower canines are large and directed upwards and outwards, and slightly curved backwards. The premolar and molar teeth form a continuous series, gradually increasing in size from the first to the last. The true molars have square quadricuspidate crowns. The stomach is much more complex than in the true pigs, almost approaching that of a ruminant. In the feet the two middle (third and fourth) metapodial bones, which are completely separate in the pigs, are united at their upper ends, as in the ruminants. On the fore foot the two (second and fifth) outer toes are equally developed as in pigs, but on the hind foot, although the inner (or second) is present, the outer or fifth toe is entirely wanting, giving an unsymmetrical appearance of the member, very unusual in Artiodactyles. As in all other existing Ungulates, there is no trace of a first digit (pollex or hallux) on either foot. As in the pigs, the snout is truncated, and the nostrils are situated in its flat, expanded, disk-like termination. The ears are rather small, ovate, and erect; and there is no external appearance of a tail. The surface is well covered with thick bristly hair, and rather behind the middle of the back is a large and peculiar gland, which secretes an oleaginous substance with a powerful musky odour. This was mistaken by the old travellers for a second navel, a popular error which suggested to Cuvier the name of *Dicotyles*. When the animal is killed for food, it is necessary speedily to remove this gland, otherwise it will taint the whole flesh so as to render it uneatable.

There are two species, so nearly allied that they will breed together freely in captivity. Unlike the true pigs, they never appear to produce more than two young ones at a birth,

The collared peccary (*D. tajacu*, Linn., *torquatus*, Cuvier) ranges from the Red river of Arkansas through the forest



Peccary.

districts of Central and South America as far as the Rio Negro of Patagonia. Generally it is found singly or in pairs, or at most in small herds of from eight to ten, and is a comparatively harmless creature, not being inclined to attack other animals or human beings. Its colour is dark grey, with a white or whitish band passing across the chest from shoulder to shoulder. The length of the head and body is about 36 inches. The white-lipped peccary or warree (*D. labiatus*, Cuvier) is rather larger, being about 40 inches in length, of a blackish colour, with the lips and lower jaw white. Its range is less extensive; it is not found farther north than British Honduras or south of Paraguay. It is generally met with in large droves of from fifty to a hundred or more individuals, and is of a more pugnacious disposition than the former species, and capable of inflicting severe wounds with its sharp tusks. A hunter who encounters a herd of them in a forest has often to climb a tree as his only chance of safety. Both species are omnivorous, living on roots, fallen fruits, worms, and carrion; and when they approach the neighbourhood of villages and cultivated lands they often inflict great devastation upon the crops of the inhabitants.

Fossil remains of extinct species of peccaries of the Pleistocene period have been found in the caves of Brazil, and also as far north as Virginia and South Carolina. They have also been traced backwards in time, with apparently little modification of structure, to the Upper Miocene formations of Oregon.

PECS. See FÜNFKIRCHEN, vol. ix. p. 827.

PEDOMETER is an apparatus in the form of a watch, which, carried on the person of a traveller, indicates the number of paces made, and thereby approximately the distance travelled. The ordinary form has a dial-plate with chapters for yards and miles respectively, but in some, miles and their fractions only are indicated, while others are divided for kilometres, &c. The registration is effected by the fall of a heavy pendulum, caused by the percussion of each step. The pendulum is forced back to a horizontal position by a delicate spring, and with each stroke a fine-toothed ratchet-wheel attached to it is moved round a certain length. The ratchet communicates with a train of wheels which govern the dial-hands. In using the apparatus a measured mile or other known distance is walked, and the indication thereby made on the dial-plate observed. According as it is too great or too small, the stroke of the pendulum is shortened or lengthened by a screw which correspondingly affects the ratchet motion,

and thereby regulates the indication to the average pace. Obviously the pedometer is little better than an ingenious toy, depending even for rough measurements on the uniformity of pace maintained throughout the journey measured.

**PEDRO (PETEK)**, the name borne by several sovereigns of Aragon, Castile, and Portugal. Three of them were contemporaries, and, to add to the confusion to which this has given rise, each of them was the son and successor of an Alphonso.

**Aragon.**—**PEDRO IV.** (1317-1387), surnamed "the Ceremonious," succeeded his father Alfonso IV. in 1336, placing the crown upon his own head at Saragossa to make it quite plain that he did not hold of the pope. In 1344 he deposed his brother-in-law Jayme from the throne of Majorca, and again made the Balearic Isles, Cerdagne, and Roussillon directly subject to the crown of Aragon. In 1346 jealousy of his brother Jayme led him to alter the succession in favour of his daughters, but two powerful unions or leagues in Aragon and Valencia compelled him in the following year anew to recognize the legitimate heir-presumptive. The victory of Epila, however, in 1348 enabled him to triumph over his factious nobles and to cancel the privileges they had extorted from him. In 1351 Pedro, desiring to strengthen his precarious hold upon the island of Sardinia, entered into an alliance with Venice, and began hostilities against Genoa, which, carried on at intervals for many years, were definitively terminated only by his successor. In 1356 a breach of neutrality by some Catalan ships at San Lucar led to a war with the king of Castile, which was carried on with occasional suspensions until 1375, when the infanta Leonora of Aragon was married to Don Juan (afterwards John I.) of Castile. In 1377 Pedro succeeded in reconquering Sicily after the death of Frederick III., but, to avoid the threatened interdict of Urban VI., he ceded the island to Martin, his grandson, retaining the suzerainty only. In 1382 he sent troops to Greece to seize, on his behalf, the duchy of Athens. Pedro died at Barcelona on 5th January 1387, and was succeeded by his son John I. He left a curious history of his reign, written in Catalan, which has been printed by Carbonell in his *Chroniques de Espanya* (1547).

Three other kings of Aragon bore this name. **PEDRO I.** succeeded his father Sancho Ramirez on the throne of Aragon and Navarre in 1094, and died in 1104. The leading event of his reign was the conquest of Huesca (1096). **PEDRO II.** (1174-1213) succeeded his father Alphonso II. in 1196. In November 1204 he was crowned in St Peter's, Rome, by Innocent III., in return for which honour he declared his kingdom feudatory of the Roman see and promised an annual tribute, not, however, without a strong protest on the part of his subjects, whose hostile demonstrations in the following year he had difficulty in repressing. In 1209 he purchased peace with Sancho VII. of Navarre, and in 1212 he, along with that sovereign, gave valuable help to Alphonso of Castile in securing the splendid victory over the Arabs at Navas de Tolosa. In the following year, having taken up arms on behalf of his brother-in-law, Count Raymond of Toulouse, he was slain in the disastrous battle of Muret (12th September 1213). He was succeeded by his only son, Jayme I., "el Conquistador." **PEDRO III.** (1286-1285), son of Jayme I. and grandson of Pedro II., succeeded to the crowns of Aragon, Catalonia, and Valencia in 1276. In 1282 he had married Constance, daughter of Manfred, king of the Sicilies, and on the strength of this alliance he took advantage of the Sicilian Vespers to lay claim to the kingdom of Sicily. This involved him in a ruinous war, in the course of which his dissatisfied subjects united to assert their ancient "fueros" or privileges, exacting from him at Saragossa in 1283 the "Privilegio General," which in spirit and import may be compared to the English Great Charter. Charles of Valois, invested by the pope with the crown of Aragon, sought to invade the kingdom, but was repulsed both by land and sea. Charles's death in 1285, which terminated the war, was followed by that of Pedro in the same year.

**Castile and Leon.**—**PEDRO I.** (1333-1369), commonly surnamed "the Cruel," but sometimes referred to as "the Justiciary," was the only legitimate son of Alphonso XI., and was born at Burgos on 30th August 1333. When

raised to the throne at Seville by his father's premature death before Gibraltar (29th March 1350), Pedro was a mere lad, with exceptionally small experience of courts and camps, having lived in comparative retirement along with his mother, Doña Maria of Portugal, in the Andalusian capital, while his illegitimate brothers, the children of Leonora de Gusman, the eldest of whom were Don Enrique (Henry), count of Trastamara, and Don Fadrique (Frederick), grandmaster of Santiago, had remained beside Alphonso, and had accompanied him on his warlike expeditions. At the beginning of his reign he was thus, almost of necessity, compelled to abandon the conduct of affairs to more experienced hands; by the skilful policy, accordingly, of the powerful and ambitious Juan Alonso de Alburquerque, who had been his father's chancellor and prime minister, his many enemies and rivals were, for a time at least, successfully kept at bay. The king, however, soon began to assert his independence; whereupon the minister, remembering how helpful a royal mistress had been for the furtherance of his own ends during the preceding reign, did not scruple to encourage Pedro's passion for the young, well-born, and beautiful Maria de Padilla, even after his marriage with Blanche de Bourbon had been arranged. His experiment proved a disastrous one, and not least so to himself. The influence of Maria and of her relations, which rapidly became great, was soon turned against the too politic Alburquerque; and, as a first step towards his dismissal from power, they succeeded in making him seem less indispensable by effecting a superficial reconciliation between the king and his brothers. Then, on the minister's remonstrating against the conduct of Pedro in deserting Blanche for his mistress almost immediately after his marriage at Valladolid in June 1354, a complete change of administration took place, and Alburquerque retired to his estates. Shortly afterwards he was joined by the king's brothers Enrique and Fadrique in raising the standard of revolt in Castile; in this formidable movement they were speedily joined by Pedro's cousins, the infantes of Aragon, as well as by increasing numbers of the ricos hombres and caballeros of the kingdom, and by several of the towns, their grievances being his repudiation of Blanche, his deposition of Alburquerque, and the murder of Juan Nuñez de Prado, the master of Calatrava, for which he was believed to be responsible. The cortes of Toro accordingly asked him to take back his queen and dismiss the Padillas; and so general was the national feeling in this matter that even his own mother deserted his cause, and on his giving evasive replies he found himself before the end of the year practically stripped of all his real authority, surrounded by officials of his enemies' choosing, and virtually a prisoner in their hands. He succeeded, however, in making his escape from Toro to Segovia with a handful of followers in the following year, and the divergence of interest that soon arose to separate the Aragonese princes from the bastard sons of Alphonso XI. so wrought in his favour that he was soon able (1356) to recover all the authority he had ever had, and to secure at least a transitory peace by the policy of reckless assassination which years previously he had inaugurated while Alburquerque was still his minister, and which he brought to a climax in the cold-blooded murder of his brother Don Fadrique at Seville in 1358, the tragedy to which he is said to have been specially indebted for his unenviable surname. In 1356 he already found himself strong enough to enter upon a war with his namesake Pedro IV. of Aragon, and, with inconsiderable intervals of truce brought about through the intervention of the papal legate, he continued to carry it on for several years. In 1365 he was still campaigning beyond the borders of his kingdom when Castile was invaded by the "free companies" of French and English troops under Du Guesclin and

Calverley on behalf of Don Enrique, whose cause had now been espoused by France. He returned only to find himself practically unthroned, and towards the close of 1366 he sailed from Coruna for Guienne almost unaccompanied, save by his three daughters, but taking with him a considerable quantity of money and jewels. He was befriended in his exile by the Black Prince, and by liberal promises obtained his alliance and assurances of material help; the English troops accordingly crossed the Pyrenees in the following spring, and, by the bloody victory of Najera or Navarrete near Logroño (13th April 1367), once more restored him to his kingdom. Pedro, however, was unwilling or unable to implement the bargain he had made, and by his arrogant demeanour soon alienated his chivalrous ally; before the close of the year Don Enrique had again begun to collect his forces, while the Black Prince, injured and indignant, turned his face homewards. A final battle between Pedro and his brother took place at Montiel (13th March 1369), with the result that the former was driven for shelter into the fortress. Ten days afterwards he was induced to visit the camp of Enrique by illusory hopes of a favourable treaty through Du Guesclin; the brothers, who had not seen each other for fifteen years, met for the last time; angry words passed between them, soon they came to blows, and in the desperate struggle that ensued Don Pedro met his death. Pedro was in no way remarkable either as a soldier or as a ruler of men, and his character, so odious in the one feature expressed by his only too well deserved surname, presents singularly few redeeming traits; it is not even picturesque. The best that can be alleged by way of apology for him and excuse for his barren reign is the untowardness of the circumstances of his birth, education, and accession. To a narrow and uncultivated mind like his "the tyrant's plea" could hardly ever have appealed with greater plausibility. It is significant, however, that in Spain itself there are two nearly opposite points of view from which Pedro appears not as "el Cruel" but as "el Justiciero." On the one hand, the common people of Andalucía among whom he lived, the Jews whose commerce he encouraged, the Moors whom his very want of religion enabled him to tolerate, have helped to keep alive the tradition of the substantial if occasionally capricious and whimsical justice he often delighted personally to administer. The other point of view is that of such monarchs as Isabella "la Católica" and Philip II., who could not but be grateful to him for all he had done to weaken the power of the nobles of Castile.

The chief source for the incidents of the reign of Don Pedro is the *Chronicles of Castile*, by Pero Lopez de Ayala, of which there are two redactions known as the *Vulgar* and the *Abreviada*. These form the basis of Prosper Mérimée's *Histoire de Don Pedro, Premier Roi de Castille* (1848; 2d ed. 1865; Eng. trans., anon., 1849).

**Portugal.**—PEDRO I. (1320-1367) was the son of Alphonso IV. and Beatrice of Castile, and in 1339 married Constance, daughter of the duke of Peñafiel and marquis of Villena. The story of his passion for Inez de Castro, of his supposed marriage with her, of her cruel murder in 1355, and of the exhumation and coronation of her dead body has been told elsewhere (see vol. v. p. 202). He succeeded to the throne in 1357 and died in 1367, after a peaceful and comparatively uneventful reign of ten years.

For other sovereigns bearing this name see BRAZIL and PORTUGAL. PEBBLES, a midland county of Scotland, is bounded N. and N.E. by Midlothian, E. and S.E. by Selkirk, S. by Dumfries, and W. by Lanark. Its outline is somewhat irregular, the greatest length from north to south being about 30 miles, the greatest breadth about 20, and the smallest about 10. The area is 226,899 acres, or about 355 square miles.

From the fact that the county lies within the upper valley of the Tweed, it is sometimes known as Tweeddale. The surface consists of a succession of hills broken by the vale of the Tweed, which in some parts attains considerable breadth, and by the narrow valleys forming the courses of numerous "waters" and smaller streams. The lowest point above sea-level is about 450 feet, but the hills generally vary in height from 900 to 1500 feet, while several attain an altitude considerably over 2000 feet. The highest summits are Broad Law (2754 feet), Cramalt Craig (2723 feet), and Dollar Law (2680 feet). The hills for the most part are rounded in form. The scenery is thus generally devoid of very striking or picturesque features, and its quiet pastoral character has a pleasing effect, while the exuberant plantations which clothe the sides and summits of the hills in the neighbourhood of the Tweed, with the well-cultivated fields adjoining its banks, lend to this district an aspect of rich luxuriance.

The Tweed has its source in a small fountain named Tweed's Well at the base of a hill on the south-western border called Tweed's Cross, from the farther side of which flow the Annan and the Clyde. It rises about 1300 feet above sea-level, and, with waters of sparkling clearness and purity, justly entitling it to the name of the "silver Tweed," flows with rapid course north-eastwards to the town of Peebles, receiving continual accessions from mountain streamlets, the principal being the Biggar Water from the west at Drumelzier, the Lyne from the north-west at Lyne, the Manor Water from the south near Edderston, and the Eddlestone Water from the north at Peebles. After passing Peebles the river bends in a more easterly direction, receiving, before it leaves the county, the Quair Water from the south and the Leithen from the north. The Megget Water flows eastwards into St Mary's Loch, which forms, for a very short distance, the south-eastern boundary of the county with Selkirkshire. The Medwin Water separates a portion of the south-western boundary of Linton pariah from Lanarkshire. Peebles is, perhaps, more resorted to by anglers than any other county in Scotland, and it would be difficult to find anywhere else in the kingdom, within an equal area, so many streams and rivers affording such good sport and so unhampered by restrictions. Apart from St Mary's Loch, on the borders of the county, there are no sheets of water of much extent.

**Geology.**—Peeblesshire is included in the Silurian tableland of southern Scotland, and consists chiefly of Upper Silurian rocks, having generally a north-western dip. The strata have been thrown into great flexures by volcanic action, and are frequently mingled with igneous rocks, such as trap, felspar, and porphyry. In the valley of the Tweed, where there is a great anticlinal flexure, slates with thin beds of anthracite are found, and also limestone. In a slate-quarry near Traquair graptolites, trilobites, and shells are met with, but nowhere else in the county have fossils been discovered. There are evidences of glacial action in the rounded forms of the hills, the frequent groovings along their flanks, and the large number of striated boulders. In the northern part of the county, in the parishes of Linton and Newlands, the Silurian rocks dip beneath the Carboniferous strata of the West of Scotland coal-field. In Peeblesshire the strata consist of sandstone and coal-beds. Ironstone is also found, and lead-ore occurs in thin beds near the Leithen. Limestone and marl are abundant, and at Stobo there is a quarry of excellent blue slate.

**Climate, Soil, and Agriculture.**—In the uplands the climate, though colder than that of the Lothians, is generally pure and dry, and remarkably healthy. The average rainfall is about 29 inches. On the summits and slopes of

the hills frequent showers occur when it is quite fair in the valleys. The reflexion of the "slanters" on the hillsides sometimes greatly increases the heat in the valleys and assists the early ripening of the crops. The character of the soil varies considerably, moss, gravel, and clay being all represented. The flat lands consist generally of rich loam, composed of sand and clay.

As may be supposed from its hilly character, the county is pastoral rather than agricultural. The old system of small farms is nearly completely broken up, the average size of the holdings being now about 200 acres of arable land, with pasturage for 600 to 800 sheep attached. According to the agricultural returns of 1883, of the total area only 42,433 acres, or a little less than a fifth, were under cultivation, corn crops occupying 9832 acres, green crops 5716, rotation grasses 12,078, and permanent pasture 14,768. There were 10,177 acres under woods, 11 acres of market-gardens, and 6 of nursery-grounds. The most common rotation of crops is a six-course shift of (1) turnips, (2) barley or oats, (3), (4), and (5) grass or pasture, and (6) oats. The principal crops are oats, which in 1883 occupied 8797 acres, or about nine-tenths of the total area under corn crops, and turnips, for which the soil is specially well adapted, and which occupied 4679 acres, or about four-fifths of the total area under green crops. Horses in 1883 numbered 1142, cattle 5664, and sheep 192,122. The horses are frequently Clydesdales, and many are bred in the county. The most common breed of cattle in the county is a cross between Ayrshire and shorthorns, the cows being principally Ayrshire. Yorkshire calves and stirks are occasionally bought for feeding. The pasture, on account of the hilly character of the land, is better adapted for sheep than for cattle. On the green grassy pasture Cheviots and half-breds are the sheep most commonly preferred, and the heathery ranges are stocked with blackfaced. Crosses of blackfaced, Cheviot, and half-bred ewes with Leicestershire rams are common.

According to the latest return, the land was divided among 708 proprietors, possessing 232,410 acres, with an annual valuation of £142,614, the annual average value per acre being about 12s. 8d. Of the owners, 552, or about 75 per cent., possessed less than one acre each. The following possessed over 5000 acres each:—earl of Wemyss and March, 41,247; Sir G. G. Montgomerie, 18,173; Sir J. Murray Kasmith, 15,485; John Miller, 13,000; James Tweedie, 11,151; trustees of the late earl of Traquair, 10,778; Colonel James M'Kenzie, 9408; Sir Robert Hay, 9155; Sir W. H. G. Carmichael, 8756; John White, 6366; George Graham Bell, 6600; James Wolfe Murray, 5108.

**Manufactures.**—Although the county has the advantage of convenient railway communication both by the North British and Caledonian systems, and possesses also abundant water-power, the only textile industries are the weaving of tweeds and shawls at Peebles and Innerleithen. The other manufactures are connected with the immediate wants of an agricultural population.

**Administration and Population.**—The county includes sixteen parishes, and one royal burgh, the county town. Along with the neighbouring county of Selkirk it forms a parliamentary county, which returns one member to parliament. Within the last fifty years the population of Peebles has increased about one-third, and, while in the first decade, between 1831 and 1841, there was a decrease from 10,578 to 10,499, the rate of increase has since then augmented in every succeeding decade. In 1861 the population amounted to 11,408, in 1871 to 12,350, and in 1881 to 13,822, of whom 6626 were males and 7196 females. In 1881 females were in a minority, being only 5236 to 5342 males. The county includes two towns, Peebles (3495) and Innerleithen (2313), and two villages, Walkerburn (1026) and West Linton (434). The town population in 1881 numbered 5808, the village 1460, and the rural 6554.

**History and Antiquities.**—There are a great number of British remains, including five circular British camps and numerous sepulchral tombs, where many cists and stone coffins have been discovered, sometimes containing armilles of gold, and stone axes and hammers. The standing-stones of Tweedsmuir and the remarkable earthen terraces on the hillsides, especially at Purvis Hill near Innerleithen and at Romanno, also deserve notice. The only important Roman remains are traces of a camp on the Lyne, which some suppose to be the Coria of Ptolemy. The district was included in the old kingdom of Northumbria, and passed to the kingdom of Scotland in the 11th century. By David I. it was made a deanery in the archdeaconry of Peebles, and it was subsequently included in the diocese of Glasgow. About the middle of the 12th century it was placed under the jurisdiction of two sheriffs, one of whom was settled at Traquair and the other at Peebles. There are a considerable number of old castles, some of special interest, as Neidpath Castle on the Tweed, about a mile west from Peebles, originally a Norman keep, built about the time of David I., and enlarged for a baronial residence by the Hays, who came into possession of it in the 15th century; Horsburgh Castle, a picturesque

ruin near Innerleithen, once the seat of the Horsburghs, hereditary sheriffs-deputes of Peebles; and the mansion-house or palace of Traquair, frequently resided in by the Scottish kings when they came to hunt in Ettrick Forest.

See Pennecuik, *Description of Tweeddale*, 1715; W. Chambers, *History of Peebleshire*, 1864.

**PEEBLES**, the county town of Peebleshire, is finely situated at the junction of the Eddlestone Water and the Tweed, and on the North British and Caledonian Railways, 22 miles south of Edinburgh. The new town, consisting of a main street (High Street) with several streets diverging, is situated on the south side of the Eddlestone Water; and the old town, consisting now of only a small number of houses, is on the north side; while a number of villas cover the elevated ground on the south of the Tweed. The Tweed is crossed by a bridge of five arches, lately widened and improved, and the Eddlestone Water by two bridges. Among the modern public buildings are the town-hall, the corn exchange, and the hydropathic establishment. At the beginning of the present century Peebles possessed manufactures of fine cottons, but the industry is now discontinued. The town possesses woollen mills and meal and flour mills; it is also a centre of agriculture and has attractions as a summer residence. The population in 1801 was 2088, which had increased in 1831 to 2750, and, although in 1871 it had diminished to 2631, by 1881 it had increased to 3495. The population of the royal burgh in 1881 was 2609.

The castle of Peebles had disappeared about the beginning of the 18th century, and its site is now occupied by the parish church. There are still, however, numerous antique architectural relics, including some portions of the old town wall; the ruins of the church of the Holy Cross, founded in 1261, and of St Andrew's parish church, founded in 1195, both in the old town; vaulted cellars of the 16th and 17th centuries, situated in a close behind Mungo Park's laboratory, and built for security against Border freebooters. Queensberry Lodge, formerly the town residence of the duke of Queensberry, a building in the old style of Scottish domestic architecture, was purchased by the late William Chambers of Edinburgh, and, after being fitted up as a public reading-room, museum, and gallery of art, was presented by him to his native town under the name of the Chambers' Institution (opened in 1856). The ancient cross of Peebles now occupies the centre of the courtyard of the institution.

Peebles was at a very early period a favourite residence of Scottish kings, who came to hunt in the neighbouring Ettrick Forest. It received its original charter in all probability from Alexander III., who built and endowed the church of the Holy Cross, and also founded a monastery for red friars. It was created a royal burgh in 1367. In 1545 the town and the ancient churches were destroyed by Protector Somerset, and in 1604 it suffered severely from accidental fire. Its charter was extended by James VI., but after the union of the English and the Scottish crowns it lost its early importance.

**PEEKSKILL**, a manufacturing village of the United States in Cortlandt township, Westchester county, New York, lies on the east bank of the Hudson, 43 miles above New York city, with which it has communication by rail and (in summer) by river. Besides iron-smelting, it carries on the manufacture of railings, stoves, and fire-bricks. A church, dating from 1767, and the Van Cortlandt mansion are among its principal buildings. Incorporated in 1816, Peekskill had 6560 inhabitants in 1870 and 6893 in 1880.

**PEEL**, SIR ROBERT (1788-1850), twice prime minister and for many years the leading statesman of England, was born 5th February 1788 in a cottage near Chamber Hall, the seat of his family, in the neighbourhood of Bury (Lancashire),—Chamber Hall itself being at the time under repair. He was a scion of that new aristocracy of wealth which sprang from the rapid progress of mechanical discovery and manufactures in the latter part of the 18th century. His ancestors were Yorkshire yeomen in the district of Craven, whence they migrated to Blackburn in Lancashire. His grandfather, Robert Peel, first of Peelfold, and afterwards of Brookside, near Blackburn, was a calcio-

printer, who, appreciating the discovery of his townsman Hargreaves, took to cotton-spinning with the spinning-jenny and grew a wealthy man. His father, Robert Peel, third son of the last-named, carried on the same business at Bury with still greater success, in partnership with Mr Yates, whose daughter Ellen he married. He made a princely fortune, became the owner of Drayton Manor and member of parliament for the neighbouring borough of Tamworth, was a trusted and honoured, as well as ardent, supporter of Pitt, contributed magnificently towards the support of that leader's war policy, was rewarded with a baronetcy, and founded a rich and powerful house, on whose arms he emblazoned, and in whose motto he commemorated, the prosperous industry from which it sprang. The example and precepts of the father took early effect upon his eldest son, whom from the first he destined and prepared to serve his country in public life. At Harrow, according to the accounts of his contemporaries, Peel was a steady industrious boy, the best scholar in the school, fonder of solitary walks than of the games of his companions, but ready to help those who were duller than himself, and not unpopular among his fellows. At Christ Church, where he entered as a gentleman commoner, he studied hard, and was the first who, under the new examination statutes, took a first class both in classics and in mathematics. His examination for his B.A. degree in 1808 was an academical ovation in presence of a numerous audience, who came to hear the first man of the day; and a relation who was at Oxford at the time has recorded that the triumph, like both the triumphs and reverses of after life, was calmly borne. From his classical studies Robert Peel derived not only the classical, though somewhat pompous, character of his speeches and the Latin quotations with which they were often happily interspersed, but something of his lofty ideal of political ambition. Nor did he ever cease to love these pursuits of his youth; and in 1837, when elected lord rector of Glasgow university, in his inaugural speech he passed a glowing eulogy on classical education. To his mathematical training, which was then not common among public men, he no doubt owed in part his method, his clearness, his great power of grasping steadily and working out difficult and complicated questions. His speeches show that, in addition to his academical knowledge, he was well versed in English literature, in history, and in the principles of law. While reading hard he did not neglect to develop his tall and vigorous frame, and fortify his strong constitution, by many exercises; and, though he lost his life partly through his bad riding, he was always a good shot and an untiring walker after game. Sprung from the most religious class of English society, he grew up and remained through life a religious man, and from that source drew deep conscientiousness and tranquillity under all difficulties and in all fortunes. His Oxford education confirmed his attachment to the Protestant Church of England. His practical mind remained satisfied with the doctrines of his youth; and he never showed that he had studied the great religious controversies, or that he understood the great religious movements of his day.

In 1809, being then in his twenty-second year, he was brought into parliament for the close borough of Cashel, which he afterwards exchanged for Chippenham, and commenced his parliamentary career under the eye of his father, then member for Tamworth, who fondly saw in him the future leader of the Tory party. Pitt, Fox, and Burke were gone. Sheridan alone with an expiring ray. But in that House of Commons sat Wilberforce, Windham, Tierney, Grattan, Perceval, Castlereagh, Plunkett, Romilly, Mackintosh, Burdett, Whitbread, Horner, Brougham, Parnell, Huskisson, and, above all, George Canning. Lord

Palmerston entered the house at the same time, and Lord John Russell a few years afterwards. Among these men young Peel had to rise. And he rose, not by splendid eloquence, by profound political philosophy, or by great originality of thought, but by the closest attention to all his parliamentary duties, by a study of all the business of parliament, which made him at length familiar with the whole range of public questions and public interests, and by a style of speaking which, owing its force not to high flights of oratory, but to knowledge of the subject in hand, clearness of exposition, close reasoning, and tact in dealing with a parliamentary audience, backed by the character and position of the speaker, improved with his information, practice, station, and experience till it gave him an unrivalled command over the House of Commons. The Tory party was then all-powerful at home; while abroad Europe was at the feet of Napoleon. But Napoleon's fortune was about to turn; and, with the close of the struggle against revolutionary France, political progress in England was soon to resume the march which that struggle had arrested. Young Peel's lot, however, was cast, through his father, with the Tory party. In his maiden speech in 1810, seconding the address, he defended the Walcheren expedition, which he again vindicated soon afterwards against the report of Lord Porchester's committee. It is said that even then Lord Liverpool discerned in him a dangerous tendency to think for himself, and told his father that he must be put at once into the harness of office. At all events he began official life as Lord Liverpool's private secretary, and shortly afterwards, in 1811, was made under-secretary for the colonies by Perceval. In 1812 he was transferred by Lord Liverpool to the more important but unhappy post of secretary for Ireland. There he was engaged till 1817 in maintaining, by insurrection Acts and other repressive measures, English and Protestant ascendancy over a country heaving with discontent, teeming with conspiracy, and ever ready to burst into rebellion. A middle course between Irish parties was impossible. Peel became, by the necessity of his situation, "Orange Peel," and plied the established engines of coercion and patronage with a vigorous hand. At the same time, it was his frequent duty to combat Grattan, Plunkett, Canning, and the other movers and advocates of Catholic emancipation in the House of Commons. He, however, always spoke on this question with a command of temper wonderful in hot youth, with the utmost courtesy towards his opponents, and with warm expressions of sympathy and even of admiration for the Irish people. Nor was the ground he took against the Catholics that of religious principle never to be abandoned, but that of political expediency, which political necessity might overcome. He also, thus early, did his best to advocate and promote secular education in Ireland as a means of reconciling sects and raising the character of the people. He materially improved the conduct of ordinary business in his office, and gave great satisfaction to merchants and others with whom he had to deal. But his greatest service to Ireland as secretary was the institution of the regular Irish constabulary, nicknamed after him "Peelers," for the protection of life and property in a country where both were insecure. His moderation of tone did not save him from the violent abuse of O'Connell, whom he, young, hot-tempered (though his temper was generally under control), and sensitive on the point of honour, was ill advised enough to challenge,—an affair which covered them both with ridicule. In 1817 he obtained the highest parliamentary distinction of the Tory party by being elected member for the university of Oxford,—an honour for which he was chosen in preference to Canning on account of his hostility to Catholic emancipation, Lord Eldon lending



him his best support. In the following year he resigned the Irish secretaryship, of the odious work of which he had long been very weary, and remained out of office till 1822. But he still supported the ministers with official zeal, even in the question of the "Peterloo massacre." In the affair of Queen Caroline, however, he stood somewhat aloof, disapproving some steps taken by the Government, and sensitive to popular opinion; and when Canning retired on account of this affair Peel declined Lord Liverpool's invitation to take the vacant place in the cabinet. During this break in his tenure of office he had some time for reflexion, which there was enough in the aspect of the political world to move. But early office had done its work. It had given him excellent habits of business, great knowledge, and a high position; but it had left him somewhat stiff, somewhat punctilious, somewhat too cold and reserved to win the hearts of those whose confidence he might command, and somewhat over anxious for formal justifications when he might well have left the essential patriotism and probity of his conduct to the judgment of men of honour and the heart of the people. At the same time he was no pedant in business; in corresponding on political subjects he loved to throw off official forms and communicate his views with the freedom of private correspondence; and, where his confidence was given, it was given without reserve.

At this period he was made chairman of the bullion committee on the death of Horner. He was chosen for this important office by Huskisson, Ricardo, and their fellow-economists, who saw in him a mind open to conviction, though he owed hereditary allegiance to Pitt's financial policy, and had actually voted with his Pittite father for a resolution of Lord Liverpool's Government denying the existence of any depreciation in the paper currency. The choice proved judicious. Peel was converted to the currency doctrines of the economists, and proclaimed his conversion in a great speech on the 24th of May 1819, in which he moved and carried four resolutions embodying the recommendations of the bullion committee in favour of a return to cash payments. This laid the foundation of his financial reputation, and his co-operation with the economists tended to give a liberal turn to his commercial principles. In the course he took he somewhat diverged from his party, and particularly from his father, who remained faithful to Pitt's depreciated paper, and between whom and his schismatic son a solemn and touching passage occurred in the debate. The author of the Cash Payments Act had often to defend his policy, and he did so with vigour. The Act is sometimes said to have been hard on debtors, including the nation as debtor, because it required debts to be paid in cash which had been contracted in depreciated paper; and Peel, as heir to a great fundholder, was even charged with being biassed by his personal interests. But it is answered that the Bank Restriction Acts, under which the depreciated paper had circulated, themselves contained a provision for a return to cash payments six months after peace.

In 1820 Peel married Julia, daughter of General Sir John Floyd, who bore him five sons and two daughters. Three of his sons, Robert, Frederick, and Arthur, have followed him in holding parliamentary office, the youngest being now (1884) speaker of the House of Commons; while another, William, the sailor, has run a bright course in another sphere, and found a glorious grave. The writers who have most severely censured Sir Robert Peel as a public man have suspended their censures to dwell on the virtues and happiness of his private and domestic life. He was not only a most loving husband and father but a true and warm-hearted friend. In Whitehall Gardens or at

Drayton Manor he gladly opened his mind, wearied with the cares of state, to the enjoyments of a circle in which it was his pleasure and his pride to gather some of the most distinguished intellects of the day. He indulged in free and cheerful talk, in which he showed a keen sense of the ridiculous, and a dry sarcastic humour, which often broke out also in his speeches in the House of Commons. He sought the conversation of men of science; he took delight in art, and was a great collector of pictures; he was fond of farming and agricultural improvements; he actively promoted useful works and the advancement of knowledge; he loved making his friends, dependants, tenants, and neighbours happy. And, cold as he was in public, even to those whom he desired to win, yet in his gay and social hour few men whose minds were so laden could be more bright and genial than Sir Robert Peel.

In 1822 Peel consented to strengthen the enfeebled ministry of Lord Liverpool by becoming home secretary; and in that capacity he had again to undertake the office of coercing the growing discontent in Ireland, of which he remained the real administrator, and had again to lead in the House of Commons the opposition to the rising cause of Catholic emancipation. In 1825, being defeated on the Catholic question in the House of Commons, he wished to resign office, but Lord Liverpool pleaded that his resignation would break up the Government. He found a happier and more congenial task in reforming and humanizing the criminal law, especially those parts of it which relate to offences against property and offences punishable by death. The five Acts in which Peel accomplished this great work, the first step towards a complete and civilized code, as well as the great speech of 9th March 1826, in which he opened the subject to the House, will form one of the most solid and enduring monuments of his fame. Criminal law reform was the reform of Romilly and Mackintosh, from the hands of the latter of whom Peel received it. But the masterly bills in which it was embodied were the bills of Peel,—not himself a creative genius, but, like the founder of his house, a profound appreciator of other men's creations, and unrivalled in the power of giving them practical and complete effect. This great measure, beyond the sphere of party, was probably also another step in the emancipation of Peel's mind.

In 1827 the Liverpool ministry was broken up by the fatal illness of its chief, and under the new premier, George Canning, Peel, like the duke of Wellington and other high Tory members of Lord Liverpool's cabinet, refused to serve. Canning and Peel were rivals; but we need not interpret as mere personal rivalry that which was certainly, in part at least, a real difference of connexion and opinion. Canning took a Liberal line, and was supported by many of the Whigs; the seceders were Tories, and it is difficult to see how their position in Canning's cabinet could have been otherwise than a false one. Separation led to public coolness and occasional approaches to bitterness on both sides in debate. But there seems no ground for exaggerated complaints against Peel's conduct. Canning himself said to a friend that "Peel was the only man who had behaved decently towards him." Their private intercourse remained uninterrupted to the end; and Canning's son afterwards entered public life under the auspices of Peel. The charge of having urged Catholic emancipation on Lord Liverpool in 1825, and opposed Canning for being a friend to it in 1827, made against Sir Robert Peel in the fierce corn-law debates of 1846, has been withdrawn by those who made it.

In January 1828, after Canning's death, the duke of Wellington formed a Tory Government, in which Peel was home secretary and leader of the House of Commons. This cabinet, Tory as it was, did not include the impracti-



cable Lord Eldon, and did include Huskisson and three more friends of Canning. Its policy was to endeavour to stave off the growing demand for organic change by administrative reform, and by lightening the burdens of the people. The civil list was retrenched with an unsparring hand, the public expenditure was reduced lower than it had been since the Revolutionary war, and the import of corn was permitted under a sliding scale of duties. Peel also introduced into London the improved system of police which he had previously established with so much success in Ireland. But the tide ran too strong to be thus headed. First the Government were compelled, after a defeat in the House of Commons, to acquiesce in the repeal of the Test and Corporation Acts, Peel bringing over their High Church supporters, as far as he could, through Dr Lloyd, bishop of Oxford, his tutor at Christ Church, and now his beloved friend and the partner of his counsels in political matters affecting the interests of the church. Immediately afterwards the question of Catholic emancipation was brought to a crisis by the menacing power of the Catholic Association and the election of O'Connell for the county of Clare. Peel expressed to the duke of Wellington his conviction that the Catholic question must be settled. The duke consented. The consent of the king, which could scarcely have been obtained except by the duke and Peel, was extorted, withdrawn (the ministers being out for a few hours), and again extorted; and on the 5th of March 1829 Peel proposed Catholic emancipation in a speech of more than four hours, which was listened to with unflinching attention, and concluded amidst cheers which were heard in Westminster Hall. The apostate was overwhelmed with obloquy. Having been elected for the university of Oxford as a leading opponent of the Catholics, he had thought it right to resign his seat on being converted to emancipation. His friends put him again in nomination, but he was defeated by Sir R. H. Inglis, though the great majority of distinction and intellect was on his side. He took refuge in the close borough of Westbury, whence he afterwards removed to Tamworth, for which he sat till his death. Catholic emancipation was forced on Peel by circumstances; but it was mainly owing to him that the measure was complete, and based upon equality of civil rights. This great concession, however, did not save the Tory Government. The French Revolution of July 1830 gave fresh strength to the movement against them, though, schooled by the past, they promptly recognized King Louis Philippe. The parliamentary reform movement was joined by some of their offended Protestant supporters. The duke of Wellington committed them fatally against all reform, first by cashiering Huskisson for voting in favour of giving the forfeited franchise of East Retford to Birmingham, and then by a violent anti-reform declaration in the House of Lords. The elections went against them on the demise of the crown; they were compelled, by popular feeling, to put off the king's visit to the city; they were beaten on Sir H. Parnell's motion for a committee on the civil list, and resigned.

While in office, Peel succeeded to the baronetcy, Drayton Manor, and a great estate by the death of his father 3d May 1830. The old man had lived to see his fondest hopes fulfilled in the greatness of his son; but he had also lived to see that a father must not expect to fix his son's opinions,—above all, the opinions of such a son as Sir Robert Peel, and in such an age as that which followed the French Revolution.

The ability and obstinacy of Sir Robert Peel's resistance to the Reform Bill won back for him the allegiance of his party. His opposition was resolute, but it was temperate, and not such as to inflame the fierce passions of the time,

delay the return of civil peace, or put an insurmountable barrier between his friends and the more moderate among their opponents. Once only he betrayed the suppressed fire of his temper, in the historical debate of the 22d April 1831, when his speech was broken off by the arrival of the king to dissolve the parliament which had thrown out reform. He refused to join the duke of Wellington in the desperate enterprise of forming a Tory Government at the height of the storm, when the Grey ministry had gone out on the refusal of the king to promise them an unlimited creation of peers. By this conduct he secured for his party the full benefit of the reaction which he no doubt knew was sure to ensue. The general election of 1832, after the passing of the Reform Bill, left him with barely 180 followers in the House of Commons; but this handful rapidly swelled under his management into the great Conservative party. He frankly accepted the Reform Act, stamped it as final, taught his party to register instead of despairing, appealed to the intelligence of the middle classes, whose new-born power he appreciated, steadily supported the Whig ministers against the Radicals and O'Connell, and gained every moral advantage which the most dignified and constitutional tactics could afford. The changes which the Reform Act necessarily drew with it, such as municipal reform, he rather watched in the Conservative interest than strongly opposed. To this policy, and to the great parliamentary powers of its author, it was mainly due that, in the course of a few years, the Conservatives were as strong in the reformed parliament as the Tories had been in the unreformed. It is vain to deny the praise of genius to such a leader, though his genius may have been of a practical, not of a speculative or imaginative kind. The skill of a pilot who steered for many years over such waters may sometimes have resembled craft. But the duke of Wellington's emphatic eulogy on him was, "Of all the men I ever knew, he had the greatest regard for truth." The duke might have added that his own question, "How is the king's Government to be carried on in a reformed parliament?" was mainly solved by the temperate and constitutional policy of Sir Robert Peel, and by his personal influence on the debates and proceedings of the House of Commons during the years which followed the Reform Act.

In 1834, on the dismissal of the Melbourne ministry, power came to Sir Robert Peel before he expected or desired it. He hurried from Rome at the call of the duke of Wellington, whose sagacious modesty knew his superior in politics and yielded him the first place, and became prime minister, holding the two offices of first lord of the treasury and chancellor of the exchequer. He vainly sought to include in his cabinet the two recent seceders from the Whigs, Lord Stanley and Sir James Graham. A dissolution gave him a great increase of strength in the House, but not enough. He was outvoted on the election of the speaker at the opening of the session of 1835, and, after struggling on for six weeks longer, was finally beaten, and resigned on the question of appropriating the surplus revenues of the church in Ireland to national education. His time had not yet come; but the capacity, energy, and resource he displayed in this short tenure of office raised him immensely in the estimation of the House, his party, and the country. Of the great budget of practical reforms which he brought forward, the plan for the commutation of tithes, the ecclesiastical commission, and the plan for settling the question of dissenters' marriages bore fruit, then or afterwards. His scheme for settling the question of dissenters' marriages, framed in the amplest spirit of liberality, was a striking instance of his habit of doing thoroughly and without reserve that which he had once made up his mind to do.

From 1835 to 1840 he pursued the same course of patient and far-sighted opposition, the end of which, sure though distant, was not only office but power. In 1837 the Conservative members of the House of Commons, with victory now in sight, gave their leader a grand banquet at Merchant Taylors' Hall, where he proclaimed in a great speech the creed and objects of his party. In 1839, the Whigs having resigned on the Jamaica Bill, he was called on to form a Government, but failed, through the refusal of the queen, by advice of Lords John Russell and Palmerston, to part with the ladies of her bedchamber, whom he deemed it necessary to replace by ladies not connected with his political opponents. His time was not even yet fully come. In 1840 he was hurried, it is believed by the ardour of his followers, into a premature motion of want of confidence, which was brought forward by Sir John Yarde Buller and failed. But in the following year a similar motion was carried by a majority of one, and the Whigs were compelled to appeal to the country. The result was a majority of ninety-one against them on a motion of want of confidence in the autumn of 1841, upon which they resigned, and Sir Robert Peel, becoming first lord of the treasury, with a commanding majority in both Houses of Parliament, the country in his favour, and many colleagues of the highest ability and distinction, grasped with no doubtful hold the reins of power.

The crisis called for a master-hand. The finances were in disorder. For some years there had been a growing deficit, which for 1841 was upwards of two millions, and attempts to supply this deficit by additions to assessed taxes and customs duties had failed. Distress and discontent reigned in the country, especially among the trading and manufacturing classes. The great financier took till the spring of 1842 to mature his plans. He then boldly supplied the deficit by imposing an income-tax on all incomes above a certain amount. He accompanied this tax with a reform of the tariff, by which prohibitory duties were removed and other duties abated on a vast number of articles of import, especially the raw materials of manufactures and prime articles of food. The increased consumption, as the reformer expected, countervailed the reduction of duty. The income-tax was renewed and the reform of the tariff carried still further on the same principle in 1845. The result was, in place of a deficit of upwards of two millions, a surplus of five millions in 1845, and the removal of seven millions and a half of taxes up to 1847, not only without loss, but with gain to the ordinary revenue of the country. The prosperous state of the finances and of public affairs also permitted a reduction of the interest on a portion of the national debt, giving a yearly saving at once of £625,000, and ultimately of a million and a quarter to the public. In 1844 another great financial measure, the Bank Charter Act, was passed and, though severely controverted and thrice suspended at a desperate crisis, has ever since regulated the currency of the country. In Ireland O'Connell's agitation for the repeal of the Union had now assumed threatening proportions, and verged upon rebellion. The great agitator was prosecuted, with his chief adherents, for conspiracy and sedition; and, though the conviction was quashed for informality, repeal was quelled in its chief. At the same time a healing hand was extended to Ireland. The Charitable Bequests Act gave Roman Catholics a share in the administration of charities and legal power to endow their own religion. The allowance to Maynooth was largely increased, notwithstanding violent Protestant opposition. Three queen's colleges, for the higher education of all the youth of Ireland, without distinction of religion, were founded, notwithstanding violent opposition, both Protestant and Roman Catholic. The principle of toleration, once

accepted, was thoroughly carried out. The last remnants of the penal laws were swept from the statute-book, and justice was extended to the Roman Catholic Church in Canada and Malta. In the same spirit Acts were passed for clearing from doubt Irish Presbyterian marriages, for settling the titles of a large number of dissenters' chapels in England, and removing the municipal disabilities of the Jews. The grant for national education was trebled, and an attempt was made, though in vain, to introduce effective education clauses into the factory bills. To the alienation of any part of the revenues of the Established Church Sir Robert Peel never would consent; but he had issued the ecclesiastical commission, and he now made better provision for a number of populous parishes by a redistribution of part of the revenues of the church. The weakest part of the conduct of this great Government, perhaps, was its failure to control the railway mania by promptly laying down the lines on a Government plan. It passed an Act in 1844 which gave the Government a right of purchase, and it had prepared a palliative measure in 1846, but was compelled to sacrifice this, like all other secondary measures, to the repeal of the corn laws. It failed also, though not without an effort, to avert the great schism in the Church of Scotland. Abroad it was as prosperous as at home. It had found disaster and disgrace in Afghanistan. It speedily ended the war there with honour. By the hand of its governor-general of India the invading Sikhs were destroyed upon the Sutlej. Guizot has said that the objects—not only the ostensible but the real objects—of Sir Robert Peel's foreign policy were peace and justice among nations. The angry and dangerous questions with France, touching the right of search, the war in Morocco, and the Tahiti affair, and with the United States touching the Maine boundary and the Oregon territory, were happily settled by frank and patient negotiation. In this and in other parts of his administration Sir Robert Peel was well seconded by the ability of his colleagues, but the premier himself was the soul of all.

Yet there was a canker in all this greatness. There were malcontents in Sir Robert Peel's party whose presence often caused embarrassment and twice collision and scandal. The Young Englanders disliked him because he had hoisted the flag of Conservatism instead of Toryism on the morrow of the Reform Bill. The strong philanthropists and Tory Chartists disliked him because he was a strict economist and an upholder of the new poor law. But the fatal question was protection. That question was being fast brought to a crisis by public opinion and the Anti-Corn-Law League. Sir Robert Peel had become in principle a free-trader. Since his accession to power a new responsibility had fallen on him, which compelled him to think less of a class and more of the people. He had expressed to Guizot a deep, nay, a passionate conviction that something must be done to relieve the suffering and precarious condition of the labouring classes. He had lowered the duties of the sliding scale, and thereby caused the secession from the cabinet of the duke of Buckingham. He had alarmed the farmers by admitting foreign cattle and meat under his new tariff, and by admitting Canadian corn. He had done his best in his speeches to put the maintenance of the corn laws on low ground, and to wean the landed interest from their reliance on protection. But to protection the landed interest fondly clung; and it is hard to say how far Sir Robert Peel himself dreaded the consequences of repeal to the steadiness of prices and to mortgaged estates. The approach of the Irish famine in 1845 decisively turned the wavering balance. The ports must be opened, and, being opened, they could not again be closed upon the same conditions. The Clare election and Catholic emancipation were played over again. Sir

Robert proposed to his cabinet the repeal of the corn laws. Lord Stanley and the duke of Buccleuch dissented, and Sir Robert resigned. But Lord John Russell failed to form a new Government. Sir Robert again came into office; and now, with the consent of all the cabinet but Lord Stanley, who retired, he, in a great speech on 27th January 1846, brought the repeal of the corn laws before the House of Commons. In the long and fierce debate that ensued he was overwhelmed, both by political and personal enemies, with the most virulent invective, which he bore with his wonted calmness, and to which he made no retorts. His measure was carried; but immediately afterwards the offended protectionists, goaded by Lord George Bentinck and Disraeli, coalesced with the Whigs, and threw him out on the Irish Coercion Bill. He went home from his defeat, escorted by a great crowd, who uncovered as he passed, and he immediately resigned. So fell a Conservative Government which would otherwise have probably ended only with the life of its chief. Those who overthrew Sir Robert Peel have dwelt on what they naturally believe to have been the bitterness of his fall. It is certain that he was deeply pained by the rupture with his party, but it is doubtful whether otherwise his fall was so bitter. For evening had begun to steal over his long day of toil; he had the memory of immense labours gone through, and of great things achieved in the service of the state; he had a kingly position in the country, great wealth, fine tastes, and a happy home.

Though out of office he was not out of power. He had "lost a party, but won a nation." The Whig ministry which succeeded him leant much on his support, with which he never taxed them. He joined them in carrying forward free-trade principles by the repeal of the navigation laws. He joined them in carrying forward the principle of religious liberty by the bill for the emancipation of the Jews. One important measure was his own. While in office he had probed, by the Devon commission of inquiry, the sores of Ireland connected with the ownership and occupation of land. In 1849, in a speech on the Irish Poor Laws, he first suggested, and in the next year he aided in establishing, a commission to facilitate the sale of estates in a hopeless state of encumbrance. The Encumbered Estates Act made no attempt, like later legislation, to secure by law the uncertain customary rights of Irish tenants, but it transferred the land from ruined landlords to solvent owners capable of performing the duties of property towards the people. On the 28th of June 1850 Sir Robert Peel made a great speech on the Greek question against Lord Palmerston's foreign policy of interference. This speech, being against the Government, was thought to show that he was ready to return to office. It was his last. On the following day he was thrown from his horse on Constitution Hill, and mortally injured by the fall. Three days he lingered in all the pain which the quick nerves of genius can endure. On the fourth (2d July 1850) he took the sacrament, bade a calm farewell to his family and friends, and died; and a great sorrow fell on the whole land. All the tributes which respect and gratitude could pay were paid to him by the sovereign, by parliament, by public men of all parties, by the country, by the press, and, above all, by the great towns and the masses of the people to whom he had given "bread unleavened with injustice." He would have been buried among the great men of England in Westminster Abbey, but his will desired that he might be laid in Drayton church. It also renounced a peerage for his family, as he had before declined the garter for himself when it was offered him by the queen through Lord Aberdeen.

Those who judge Sir Robert Peel will remember that he

was bred a Tory in days when party was a religion; that he entered parliament a youth, was in office at twenty-four and secretary for Ireland at twenty-five; that his public life extended over a long period rife with change; and that his own changes were all forwards and with the advancing intellect of the time. They will enumerate the great practical improvements and the great acts of legislative justice of those days—Catholic emancipation, freedom for dissenters, free trade, the great reforms in police, criminal law, currency, finance, the Irish Encumbered Estates Act, even the encouragement of agricultural improvement by loans of public money—and note how large a share Sir Robert Peel had, if not in originating, in giving thorough practical effect to all. They will observe that of what he did nothing has been undone. They will reflect that as a parliamentary statesman he could not govern without a party, and that it is difficult to govern at once for a party and for the whole people. They will compare his administration with those that preceded and those that followed, and the state and fortunes of his party when he was at its head with its state and fortunes after his fall. They will consider the peace and goodwill which his foreign policy diffused over Europe. They will think of his ardent love of his country, of his abstinence from intrigue, violence, and faction, of his boundless labour through a long life devoted to the public service. Whether he was a model of statesmanship may be doubted. Models of statesmanship are rare, if by a model of statesmanship is meant a great administrator and party leader, a great political philosopher, and a great independent orator, all in one. But if the question is, whether he was a ruler loved and trusted by the English people, there is no arguing against the tears of a nation.

Those who wish to know more of him will consult his own posthumous memoirs, edited by his literary executors Earl Stanhope and Viscount Cardwell; the four volumes of his speeches; a sketch of his life and character by Sir Lawrence Peel; an historical sketch by Lord Dalling; Guizot's *Sir Robert Peel* (1857); Kunze's *Leben und Reden Sir Robert Peels* (1851); Disraeli's *Life of Lord George Bentinck* (1858); Morley's *Life of Cobden*; and the general histories of the time. (G. H.—C. B. P.)

PEELE, GEORGE (1558-1598), was one of the group of university poets with whom Shakespeare entered into competition at the beginning of his career. His exact age has been ascertained and the facts of his life diligently searched out by Mr Dyce, the editor of his works. It appears from a deposition made by him at Oxford that he was twenty-five years old in 1583. He took his bachelor's degree at Oxford in 1577, and his master's degree two years afterwards. Before he reached middle age, Peele was "driven to extreme shifts" for a living, and he became so notorious for disreputable practical jokes that a body of "merrie conceited jests" was fathered upon him; but he began life brilliantly. He was "a noted poet at the university." He married a woman of property. When a distinguished foreigner was entertained at Christ Church with elaborately-mounted plays and pageants, Peele was entrusted with the superintendence of the show. He was complimented in Latin pentameters on his translation of one of the plays of Euripides. He wrote *The Arraignment of Paris*, a bright little comedy with pretty songs, for representation before Queen Elizabeth. This was published in 1584; and in 1587 his friend Nash declared him to be "the chief supporter of pleasaunce now living, the atlas of poetry, and *primus verborum artifex*." From this brilliant height the reckless poet quickly slid down to a much less respectable position, and acquired renown of a different kind by his clever tricks on creditors, tavern-keepers, and "crahabella." He began to write for the common players, whose ingratitude to gentlemen of education was bitterly deplored by his friend Greene. Of

these productions the following have been preserved and edited by Mr Dyce:—*The Chronicle History of Edward I.* (published in 1593); *The Battle of Alcasar* (1594); *The Old Wives' Tale* (1595); *David and Bethsabe* (1599); *Sir Clyomon and Sir Clamydes* (1599). These plays, which are very different in kind, testify to Peele's versatility and adroitness, but do not entitle him to much consideration either as a poet or as a dramatist. Quickness of wit

and fancy and a certain neatness of versification are their highest qualities. As Peele lived through the transition from the first tentative essays to the full maturity of the great Elizabethan drama, his works have an historical interest as showing what an ingenious man of culture could do with the common stock of theatrical characters, situations, and imagery. His comedies are often pretty, but his tragedies are inflated and preposterous.

## P E E R A G E

IT was remarked in the article NOBILITY (vol. xvii. pp. 529, 530) that the existence of the peerage, as that word is understood in the three British kingdoms, is something altogether peculiar to those kingdoms, and that it has actually hindered them from possessing a nobility of the Continental type. Before we try to trace out the history of the British peerage, it will be well to show more fully than was done in that article in what the institution consists, and in what it differs from those institutions in other countries which are most like it. And to this end we must define what we understand by the word peerage in the British sense. In its historical use it takes in all the members or possible members of the House of Lords and no other persons. But modern usage and modern decisions seem to limit the use of the name on one side, and to extend it on another. There is no kind of doubt that, according to the earliest precedents—precedents reaching up to the earliest official use of the word *peer*—the spiritual lords are equally peers with the temporal. But it has been held, at least from the 17th century, that the spiritual lords, though lords of parliament equally with the temporal lords, are not, like them, peers. Again, in earlier times no peers were heard of except members of the House of Lords, but membership of that House, even as a temporal lord, was not necessarily hereditary. But a decision of the present reign has ruled that a life-peerage is possible, but that the holder of such a peerage has no right to a seat as a lord of parliament. And an Act of the present reign of later date has actually called into being a class of lords who, it would seem, may possibly be either lords of parliament without being peers, or peers without being lords of parliament. These doctrines, some of which trample all the facts of history under foot, but which must be supposed to declare the modern law, establish the possibility of peers who are not lords of parliament, as well as of lords of parliament who are not peers. The question whether all lords of parliament were peers has been debated for several centuries; that all peers were *in esse* or *in posse* lords of parliament, that the right to a seat in parliament was the essence of peerage round which all other rights have grown, was surely never doubted till the year 1856.

Still these later doctrines, though founded on altogether wrong historical grounds, give us a definition of peerage which is intelligible and convenient. Setting aside the possible peers who are not lords of parliament, the two decisions between them rule that the parliamentary peerage is confined to the temporal lords, and that, except in the case of the very modern official lords, their peerage is necessarily hereditary. This definition is convenient in practice, because it is the hereditary temporal peerage whose growth and constitution is of that unique kind which distinguishes it from all other bodies which bear the same name or which present any likeness to it in other ways. It will save trouble in this inquiry if we use the word *peerage* in what—with the possible exception of the last-created official lords—seems now to be its legal sense, as meaning the hereditary temporal peerage only.

In this sense then—the peerage of England—continued after the union between England and Scotland in the peerage of Great Britain, and after the union between Great Britain and Ireland in the peerage of the United Kingdom—is a body of men possessing privileges which are not merely personal but hereditary, privileges which descend in all cases according to some rule of hereditary succession, but which pass only to one member of a family at a time. In this the peerage differs from nobility strictly so called, in which the hereditary privileges, whatever they may consist in, pass on to all the descendants of the person first created or otherwise acknowledged as noble. The essential and distinguishing privilege of the peer, as defined above, is that he is an hereditary lord of parliament, that he has, by virtue of his birth, a right to a summons from the crown to attend personally in every parliament and to take his seat in the House of Lords. He is thus, by right of birth, a member of the great council of the nation, an hereditary legislator, and an hereditary judge. Whatever other privileges, substantial or honorary, the peer may possess, they have all gathered round this central privilege, which is that which distinguishes the peer from all other men. The peer of parliament thus holds a different position from the lords spiritual, equally lords of parliament with himself, but holding their seats by a different tenure from that of an hereditary peerage. He holds a different position from the possible non-parliamentary peers implied in the decision of 1856. He holds a different position from the official lords of parliament created by the last Act. The number of the peerage is unlimited; the crown may raise whom it will to any of its ranks; but it is now understood that, in order to make the persons so raised peers in the full sense, to make them lords of parliament, the creation must extend to their heirs of some kind as well as to themselves.

The special character of the British peerage, as distinguished from privileged orders in any other time or place, springs directly from the fact that the essence of the peerage is the hereditary right of a personal summons to parliament. To determine the origin of the peerage is thus to determine how a certain body of men came to possess this hereditary right of summons. But, before we enter on this inquiry, one or two remarks will be needful which are naturally suggested by the definition of peerage which has just been given.

It has been said above that the holder of a peerage as defined is a lord of parliament *in esse* or *in posse*. It has become necessary during the present and last centuries to add these last words to the definition. For it is plain that, since the successive unions of England and Scotland and of Great Britain and Ireland, an hereditary peerage has not always in practice carried with it a seat in the House of Lords (cf. the *Lords' Report on the Dignity of a Peer*, ii. 16). For since those unions certain persons, namely those peers of Scotland and Ireland who are not representative peers and who do not hold peerages of England, of Great Britain, or of the United Kingdom, have been undoubted peers, they have enjoyed some or all of the per-

sonal privileges of peerage, but they have had no seats in the House of Lords. But this is a modern accident and anomaly. The persons spoken of hold peerages which entitled their holders to seats in the parliaments of Scotland and Ireland as long as those parliaments were distinct bodies. And their present holders, if not members of the House of Lords *in esse*, are such *in posse*. They have a capacity for being chosen to seats in that House which is not shared by other persons. Their membership of the House is rather suspended than altogether taken away. Their rather anomalous case hardly affects the general principle that, as far as the hereditary peerage is concerned, peerage and membership of the House of Lords are the same thing.

A few words are also needed as to the effect of the earlier doctrine which rules that peerage is an attribute of the lords temporal only and not of the lords spiritual (see *Lords' Report*, i. 323, 393; ii. 75). This is doubtless meant to imply a certain inferiority on the part of the spiritual lords, as not sharing in that nobility of blood which is looked on as the special attribute of the hereditary peerage. But the inferiority thus implied, as it has nothing to do with parliamentary powers, has also nothing to do with precedence. The lords spiritual as a body are always mentioned first; one class of them, namely the archbishops, take precedence of all temporal peers who are not of the royal family, as the other bishops take precedence of the temporal barons. What the distinction is concerned with is simply certain personal privileges, such as the right of being tried by the court of our lord the king in parliament, that is by the House of Lords or some part of it, instead of in the ordinary way by a jury. The doctrine which denies "peerage" to the spiritual lords is altogether contrary to earlier precedents; but the way in which it came about is one of the most curious parts of our inquiry. It was the natural result of the ideas under whose influence the temporal peerage grew up and put on its distinguishing character.

The use of the word peers (*parēs*) to denote the members of the House of Lords first appears in the 14th century, and it was fully established before the end of that century. The name seems to be rather a direct importation from France than anything of natural English or even Norman growth. In the 12th, and 13th centuries the great men of the realm appear under various names, English, Latin, and French, *uitan*, *sapientes*, *magnates*, *proceres*, *grants*, and the like; they are *parēs* only incidentally, as other men might be. In the Great Charter the word *parēs*, in the phrase *judicium parium*, has simply the general meaning which it still keeps in the rule that every man shall be tried by his peers, the peer (in the later sense) by his peers and the commoner by his. In the 13th century this seems to have still been the only meaning of the word in England. This is illustrated by the story of Peter des Roches, bishop of Winchester (see B. Wendover, iv. 277; M. Paris, ed. Luard, iii. 252; Stubbs, *Const. Hist.*, ii. 48, 183), when in 1233 the right of being tried by their peers was asserted on behalf of Richard earl Marshall, and others. The bishops and other lords exhort the king to make peace with certain of his nobles and other subjects, "quos absque iudicio parium exsulaverat," &c. The Poitevin bishop, either through ignorance or of set purpose, misunderstood the phrase, and answered that in England there were no peers (*parēs*) as there were in France, and that therefore the king might deal with all his subjects as he chose by means of his own justices only.<sup>1</sup> The word *parēs* is here clearly used in one sense and understood in another. The English lords used

the word in its older general sense; Peter des Roches used it in the special sense which it bore in France. Neither used it in the sense which it took in the next century. It was perfectly true that there was in England no body of men answering to the peers of France, of whom we shall speak presently. But there is every likelihood that the name, as describing a particular body of men in England, was borrowed from the peers of France.

But the thing is more important than the name. Whatever view may be taken of the constitution of the ancient Witenagemót, we may safely assume that that assembly, with whatever change in its constitution, is personally continued in the House of Lords. That house consists of two classes of men who have never lost their right to a personal summons, together with certain other classes who have acquired that right in later times. Two classes of men, namely earls and bishops, have, with a certain interval in the 17th century, sat continuously in the councils of the nation from the earliest times. These two classes are those whose presence connects the earliest and the latest English assemblies. From the time when the House of Lords began to take anything like its present shape, other classes of men, spiritual and temporal, were summoned as well as the bishops and earls, but not with the same regularity as they were. Some abbots were always summoned from the beginning, and a few other churchmen afterwards obtained the same right. But, while every bishop—except in a few cases of personal enmity on the part of the king—was summoned as a matter of course, there was great irregularity in summoning of abbots. So some barons were always summoned as well as the earls; but, while every earl was—with a few such exceptions as in the case of the bishops—summoned as a matter of course, there was great irregularity in summoning the barons. The bishops and earls in short were personages too great to be left out; so were a few of the greatest abbots. Lesser men, spiritual or temporal, might be summoned or not according to a hundred reasons of convenience, caprice, or accident. But it is only the common tendency of things that the occasional summons should grow into the perpetual summons, and that the perpetual summons should, wherever it was possible, that is, in the case of the temporal lords, grow into the hereditary summons. In other words, the doctrine was gradually established that, when a man was once summoned, a right of summons was created for him and his heirs for ever. The establishment of this doctrine called into being a new order of men, of lower rank than the bishops and earls but of equal parliamentary power, namely the class of barons having an hereditary right to seats in parliament. Presently, in the course of the 14th and 15th centuries, the ranks of the temporal peerage were increased by the invention of new orders, those of duke, marquess, and viscount, the two former classes taking precedence of the ancient earls.

It is easy to see how the growth of these several classes of hereditary lords of parliament tended to strengthen the notion of the temporal peerage as a body by itself, apart from all other men, even from those lords of parliament whose seats were not hereditary. Here were five classes of men who were not peers in the sense of strict equality among themselves, for they were divided by rigid rules of precedence, but who were peers in the sense of having each of them an equal right to something peculiar to themselves, something which was so far from being shared with any who were not lords of parliament that it was not shared by all who were. The archbishop took precedence of the duke, the bishop took precedence of the baron; but duke and baron alike shared in something which archbishop and bishop had not, the hereditary right to a summons to

<sup>1</sup> "Quod non sunt parēs in Anglia, sicut in regno Francorum, unde Rex regi Anglorum per iustitiales quos constituerit quoslibet de regno suo exulare et mediante iudicio condemnare."

parliament. The peerage of the temporal lord came to be looked on as something inherent in the blood, something which could not, like the official seat of the churchman, be resigned or lost by any means except by such legal processes as involved "corruption of blood." The parliamentary powers, the formal precedence, of the spiritual lords were not touched, but the idea silently grew that they were not the peers of the hereditary members of the House. In short, the doctrine grew that the temporal lords alone were peers, as alone having their blood "ennobled," which is the herald's way of saying that they held their seats by hereditary right. The extinction of so many temporal peerages in the Wars of the Roses, the creation of so many new peerages under the Tudors, while in one way they lowered the strength and dignity of the order, in another way helped more and more to mark it out as a separate order, distinct from all others.

But the spiritual lords were not the only class that lost by the growth of the doctrine of hereditary peerage. No doctrine about blood or peerage could get rid of the fact that the parliamentary position of the bishops and the greater abbots was as old as that of the earls, far older than that of the barons, to say nothing of the ranks more lately devised. But there was another body of men whom the growth of the hereditary doctrine hindered from becoming peers, and from becoming lords of parliament in any full sense. These were the judges. As the judges grew to be a distinct and recognized class, they came to be summoned to parliament like the barons. The same reason which made it expedient to summon bishops, earls, and barons, made it expedient to summon judges also. It would not have been unreasonable if, in the many shiftings and experiments which took place before the constitution of the two Houses finally settled itself, the judges had come to hold official seats in the House of Lords in the same way as the bishops. But the growth and strengthening of the hereditary doctrine hindered the judges as a body from ever winning the same position in parliament as the bishops and abbots. They had not the same antiquity; they had not the same territorial position; their tenure was less secure; the spiritual lord might lose his office by resignation or by a legal process; the judge might lose his by the mere arbitrary will of the sovereign. The bishops then could be denied the right of personal peerage; they could not be denied their full parliamentary position, their seats and votes. But the same feeling which deprived the bishop of his personal peerage hindered the judge from ever obtaining the personal peerage, and even from obtaining a full seat and vote in parliament. Owing to these influences, the judges have ever held an anomalous position in parliament; they came to be in a manner in the House of Lords but not of it, to be its counsellors and assessors, but not its members.

The growth of the hereditary doctrine pressed hardly, we must allow, on both bishops and judges. But its working on either of those classes has been of small moment indeed compared with the effect on the nation at large. There is no institution for which England has greater reason to be thankful than for her hereditary peerage; for, as we began by saying, it has saved her from the curse of a nobility. Or rather, to speak more accurately, the growth of the peerage with its comparatively harmless privileges hindered the real nobility from keeping or winning privileges which would have been anything but harmless. If the word *nobility* has any real meaning, it must, according to the analogy of lands where there is a real nobility, take in all who bear coat-armour by good right (see *NOBILITY*). It is a remark which has been made a thousand times, and no remark can be truer, that countless families which would be reckoned as noble any-

where else are not reckoned as noble in England. That is to say, though they may be rich and ancient, though they may claim an illustrious pedigree and may be able to prove their claim, yet they have nothing to do with the peerage. In England no family is looked upon as noble unless its head is a peer. In other words, the idea of peerage has altogether displaced the older idea of nobility. The growth of the order of peers has hindered the growth of any nobility apart from the peerage. The hereditary dignity of the peer, the great political position which it carries with it, stands so immeasurably above any hereditary dignity which attaches to the simple gentleman by coat-armour, that the gentleman by coat-armour—the noble of other lands—ceased in England to be looked on, or rather perhaps never came to be looked on, as noble at all. In other words, the growth of the peerage saved the country from the curse of a nobility after the fashion of the nobility of France or of Germany. The difference in this respect between England and other lands is plain at first sight, and there really seems no other way to explain the difference except that every notion of hereditary dignity and privilege gathered so exclusively round the hereditary peerage as to leave nothing of any account to gather round any smaller hereditary position.

But, while the growth of the peerage thus hindered the growth of a nobility of which every gentleman should be a member, it was still possible that a real nobility might have grown up out of the peerage itself. That is to say, it might have come about that, while none but the descendants of peers were privileged, all the descendants of peers should be privileged. A nobility might thus have been formed, much smaller than a nobility taking in all lawful bearers of coat-armour, but still a nobility by no means small. But in England no such nobility has ever grown up. No one has any substantial privilege except the peer himself. No one in short is noble but the peer himself. Even in common speech, though we speak of a noble family, we do not personally apply the word *noble* to any other member of that family, unless, in the case of the higher ranks of the peerage, to a few immediate descendants of the peer. In short, while the blood of the peer is said to be ennobled, it is ennobled with a nobility so high and rare that it cannot pass to more than one at a time even of his own descendants (see the plain speaking of Dr Stubbs, *Const. Hist.*, iii. 443). The eldest son of a duke is legally a commoner; the children of his younger sons are not only legally but socially undistinguishable from other commoners. That is to say, the hereditary possession of the peer is not nobility at all in the sense which that word bears in other lands. It is a fiction to say that the peer's blood is ennobled, when the inheritors of his blood are not inheritors of his nobility. In short, as there is no nobility outside the families whose heads are peers, neither is there any real nobility within those families. As the growth of the hereditary peerage made nobility impossible outside the families of peers, so the particular form of its growth made true nobility impossible even within those families. For, after all, the essence of peerage is simply that the peer becomes by birth what other men become either by royal nomination or by popular election. The official origin of the peer still cleaves to him. The best description of his position is that he holds a great hereditary office. His place as legislator and judge is in itself as strictly official as the dignity of the bishop or the sheriff; but, as, unlike the dignity of the bishop and the sheriff, it has become hereditary, something of the magic sentiment of hereditary descent has spread itself over its actual holder and over a few of his immediate descendants. But, as the dignity is in itself official, the hereditary sentiment has not been able to go further than



this; it has not prevailed so far as to establish any nobility or any privilege of any kind for all the descendants of the hereditary legislator and hereditary judge.

This result was further strengthened by the peculiar nature of the office which became hereditary in the peers of England; it is an office which can be discharged only in concert with others; the very essence of the peerage is the summons to take part in the proceedings of an assembly. In itself nothing is more natural than the growth of nobility out of office; it is as one of the chief ways in which nobility has come into being. And, to take a position higher than that of mere nobility, men in other lands whose dignity was in its beginning yet more purely official than that of the peers of England, say the dukes and counts of Germany, contrived, not only to make their offices hereditary but to make at least their honorary privileges extend to all their descendants for ever and ever. That is to say, they grew into a nobility—a nobility to be sure within a wider nobility—in the strictest sense. Why did not the English peerage do the same? For two reasons, which are in truth different forms of the same reason, different results of the fact that the royal power was so much stronger in England than it was in Germany. One is because the growth of the dukes and counts of Germany belongs to a much earlier state of things than the growth of the English peerage, to a state of things when national unity and the royal authority, though much stronger than they were afterwards, were much less firmly established than they were in England in the age when the hereditary peerage grew up. But partly also, and chiefly, because the dignity and authority of the German duke or count was mainly a local and personal dignity and authority, a dignity and authority which he held in himself and exercised apart from his fellows, while the dignity and authority of the English peer was one which he could hold and exercise only in partnership with his fellows. To the German duke or count his position in the national assembly was the least important part of his powers; to the English peer it was the essence of his whole position. After the purely official character of the earldoms had died out, the English peer was nothing apart from his brother peers. His greatness was the greatness of the member of a powerful assembly. He might be hereditary legislator and hereditary judge; but he could not act as either except in concert with all the other hereditary legislators and hereditary judges. The earls and bishops of England, each by himself, might, if the royal authority had been weaker, have grown into princes, like the dukes and bishops of Germany. The earls, after the change in their character, and the other ranks of peerage from their beginning, were shown to be simple subjects by the very nature of their dignity and power. The position of the German duke or count doubtless came from a royal grant; but it was from a royal grant of some distant age. The position of the English peer rested altogether on a writ from the crown, and that not a writ of past ages, but a writ which, though it could not be refused, needed to be renewed in each successive parliament. In other lands the assembly of the nobles was great and powerful because it was an assembly of great and powerful men; in England the peer was great and powerful because he was a member of a great and powerful assembly. A parliamentary dignity of this kind, even when it became strictly hereditary, was very different from the *quasi* princely position of the great nobles of other lands. And, though the peer commonly had a great local position, sometimes an almost princely position, it was not as peer that he held it. Whatever might be his local dignity and local rights, they had nothing to do with his peerage; they were shared in his degree by the smallest lord of a manor. In short, the hereditary dignity

of the peer, hereditary membership of the great council of the nation, was on the one hand so transcendent as to extinguish all other hereditary dignities; on the other hand, as resting on membership of an assembly, it could not well grow into nobility in the strictest sense. The peerage therefore, the office of hereditary legislator and hereditary judge, passed, and such nobility as it conferred passed with it, to one member only of the family at a time. The other members had no share in the office, and therefore had no share in the nobility which it conferred.

It was then in this way that the peerage, growing out of the hereditary summons to parliament, hindered the growth of any nobility outside the families of peers and by the same means hindered the growth of any real nobility within their families. To the existence of the peerage, then, more than to any other cause, England owes its happy freedom from the curse of a really privileged class, the happy equality in the eye of the law of all men who are not actually peers,—an equality which reaches so high that the children of the sovereign himself, whatever may be their personal honours and precedence, are, unless they are formally created peers, in the eye of the law commoners like other men. The privileges of the actual peerage have been a small price to pay for such a blessing as this. But we must remember that this happy peculiarity, like all other features in the English constitution, came about by accident, or more truly by the silent working of historical circumstances. As no English lawgiver ever decreed in so many words that there should be two Houses of Parliament and not one, three, or four—as no lawgiver ever decreed in so many words that one of these Houses should be elective and the other hereditary or official—so no lawgiver ever decreed in so many words that the children of the hereditary lord of parliament should be in no way partaker of his privileges. All these things came of themselves; we cannot point to any particular enactment which established any of them, or to any particular moment when they were established. Like everything else, they grew by usage, not by enactment; later enactments confirmed them or took them for granted (see *Lords' Report*, i. 47, 483; ii. 25). But we can see that the rule which has established but one form of real distinction among Englishmen, that which parts the actual peer and the commoner, grew out of the way in which the elements of the parliament finally settled themselves. The parliamentary line was in the end drawn between the baron and the knight. One is rather surprised that it was drawn at that point. The gap between the earl and the baron, and again the gap between the knight and the citizen, might either of them seem wider than the gap between the baron and the knight. Yet in the end the barons were lifted up to the fellowship of bishops and earls, while the knights were thrust down to the fellowship of citizens and burgesses. This must have done much to hinder the knightly families, families which in any other land would have ranked as noble, from keeping or claiming any strictly hereditary privilege. On the other hand, as we have already seen, the nature of that privilege of peerage which the barons were admitted to share hindered the baronial families from claiming any fresh hereditary privilege beyond the hereditary transmission of the peerage itself.

Such is a general view of the nature and origin of peerage in England, following at greater length the lines already traced out in the article ENGLAND. This view may now be confirmed by a few of the special facts and dates which stand out most conspicuously in that course of events which led to the received doctrine of peerage. We assume the House of Lords as the personal continuation of the ancient *Witenagemót*, *Mycel Gemót*, *Magnum Concilium*, by whatever name we choose to call that im-

memorial body which, whatever was its constitution, was certainly not representative in the sense of being elective. Alongside of this older body grew up that newer representative and elective body which became the House of Commons. We may best place the beginnings of the peerage at the point when we can distinctly see that barons are personally summoned to the one House, while knights find their way into the other only by election. It hardly needs to be explained that the word *baron*, originally meaning simply *man*, has in itself nothing to do with peerage or with seats in parliament. Survivals of its earlier and wider meaning may still be traced in the titles of the Barons of the Exchequer and the Barons of the Cinque Ports, and in other uses of the word, more common perhaps in Scotland and Ireland than in England. *Baro* often translates the older English *thegn*, and perhaps neither of these names is very easy to define. By the 13th century the name *baron* had come specially to mean the highest class among the king's lay tenants-in-chief under the rank of earl; the baron was the holder of several knight's fees. In a wider and vaguer sense, the word often takes in both the earls and the spiritual lords. In its narrower sense it means those who were barons and not more than barons. As the practice of personal summons to parliament came in, the barons formed a class of men who might reasonably hope or fear, as the case might be, that the personal summons might come to them; and to many of them it did come. And its coming or not coming established a distinction between two classes of barons. A distinction between greater and lesser barons is implied in the Great Charter (c. xiv.), which asserts the right of the "majores barones" to a personal summons along with the archbishops, bishops, abbots, and earls, while the other tenants-in-chief—among them by implication such barons as did not come under the head of *majores*—were to be summoned generally by the sheriff. And this ordinance must be taken in connexion with the earlier writ of 1215 (Selden, *Titles of Honour*, 587; Stubbs, *Select Charters*, 278, and *Const. Hist.*, i. 568), in which the sheriff is bidden to summon the knights in arms, and the barons without arms, and also four discreet men from each shire, "ad loquendum nobiscum de negotiis regni nostri," that is, in other words, to a parliament. The Charter thus secures to the greater barons, as a separate class, the right of being personally summoned by the king, and not by the sheriff along with other men. It parts them off from other tenants-in-chief and puts them alongside of the prelates and earls. These two documents between them may be taken as giving us at once the first distinct approach to the notion of peerage and the first distinct approach to the notion of representation. The "majores barones" are not defined; but the summons supplied the means of defining them, or rather it became a means of making them the only barons. As the summons became hereditary, barons came more and more to be looked on simply as a class of men who had seats in the House of Lords. The word came to mean a rank in the peerage, and it was gradually forgotten that there ever had been territorial barons who had no claim to seats in parliament.

But it was only by slow degrees that the hereditary summons, or even the necessary summons of every man who had once been summoned, became the established rule. Throughout the 13th century the language in which the national assembly is spoken of is wonderfully shifting. Sometimes its constitution seems more popular, sometimes less so. Sometimes its more dignified members are spoken of vaguely under such names as *magnates*, without distinction into particular classes. But, when particular classes are reckoned up, the barons always form one class among them; but the number of barons summoned varies greatly.

The Charter gives the *majores barones* the right of personal summons; but the *majores barones* are not as yet a defined and undoubted class of men like the bishops and earls. None but the holder of a barony in the territorial sense was likely to be summoned; but the king still had a wide choice as to whom among the holders of such baronies he would acknowledge as *majores barones*; and we find that dissatisfaction was caused by the way in which the king exercised this power. In 1255 there is a remarkable notice in Matthew Paris (v. 520, ed. Luard; cf. Hallam, *Middle Ages*, ii. 153) where the "magnates" complain that all of their number had not been summoned according to the Charter, and they therefore decline to grant an aid in the absence of their peers.<sup>1</sup> It is possible that some bishops or earls may, for some personal reason, have been left unsummoned, but the complaint is far more likely to have come from the barons specially so called. Here the word *paries* is still used in its more general sense, but it is used in a way that might easily lead to its special use. On the other hand, it has been alleged that, by a statute of the later years of Henry III., it was formally ordained that no barons, or even earls, should come to parliament, except those whom the king should specially summon (see Selden, *Titles of Honour*, 589; Hallam, *Middle Ages*, ii. 142; Stubbs, *Const. Hist.*, ii. 203). The existence of such a statute may be doubted; but, as far as the barons are concerned, the story fairly expresses the facts of the case. Under Edward I. an approach, to say the least, is made to the creation of a definite class of parliamentary barons. Dr Stubbs marks the year 1295 as "the point of time from which the regularity of the baronial summons is held to involve the creation of an hereditary dignity, and so to distinguish the ancient qualification of barony by tenure from that of barony by writ" (*Const. Hist.*, iii. 437). In another passage (ii. 183) he thus marks the general result of Edward's reign—

"The hereditary summoning of a large proportion of great vassals was a middle course between the very limited peerage which in France coexisted with an enormous mass of privileged nobility, and the unmanageable, ever-varying assembly of the whole mass of feudal tenants as proscribed in Magna Carta."

It may be thought that the hereditary nature of the barony is here put a little too strongly for the days of Edward I. One may certainly doubt whether Edward, when he summoned a baron to parliament, meant positively to pledge himself to summon that baron's heirs for ever and ever, or even necessarily to summon the baron himself to every future parliament. The facts are the other way; the summons still for a while remains irregular (see Nicolas, *Historic Peerage*, xxiv., xxv., ed. Courthope; *Lords' Report*, ii. 29, 290). But the perpetual summons, the hereditary summons, gradually became the rule, and that rule may in a certain sense be said to date from 1295. That is, from that time the tendency is to the perpetual summons, to the hereditary summons; from that time anything else gradually becomes exceptional (cf. *Const. Hist.*, ii. 203 with iii. 439); things had reached a point when the lawyers were sure before long to lay down the rule that a single summons implied a perpetual and an hereditary summons. It is not too much to fix the reign of Edward I. as the time when the hereditary parliamentary baronage began, without rigidly ruling that the king could not after 1295 lawfully refuse a summons to a man who had been summoned already.

From this time then we may look on the class of parliamentary barons with succession as beginning and steadily growing. And the admission of the barons had a great

<sup>1</sup> "Responsum fuit, quod omnes tunc temporis non fuerunt juxta tenorem magnæ cartæ suæ, et ideo sine paribus suis tunc absentibus nullum responsum dare vocati auxilium concedere aut prestare."

effect on the position of the older members of the House, the prelates and earls. It was in fact their admission which gave the English peerage its distinctive character. A house of earls, bishops, and great abbots would have remained an official house. The earldom might pass from father to son; but it would pass as an hereditary office, entitling its holder to a seat by virtue of his office, just like those lords who held their seats by virtue of offices which did not pass from father to son. Indeed we must not forget the meaning of the word *hereditary* in early times. It is applied to whatever goes by succession, whether that succession is ruled by natural generation, by election or nomination, or by any other way. The office and estate of the bishop or abbot is hereditary in this sense; it must pass to some successor, and it is therefore often spoken of as hereditary. Indeed, as long as the earl was appointed, his office was hereditary only in the same sense as that of the bishop. The only difference was that the office of the bishop could not possibly become hereditary in the modern sense, while the office of the earl easily might, and therefore did. But, if the earls had continued to have no fellows in the Upper House except the prelates, the earldom could hardly have sunk into a mere rank. It was the addition of a class which had no official position—save that which their seats in parliament conferred upon them—a class whose seats were first purely personal and then purely hereditary in the modern sense, which helped more than anything else to do away with the official character of the earls. And in so doing it helped to widen the gap between the spiritual and temporal lords. The earl and the baron alike came to be looked on as sitting by some hereditary virtue of descent; their blood was said to be ennobled, while the bishop and the abbot still sat only by what might seem to be in some sort the lower claim of holding an elective office.

It is then to the days of Edward I. that we are to look, not strictly for the creation of peerage in the modern sense, but for the beginning of a system out of which peerage in that sense very naturally grew. In the words of the great constitutional historian, Edward I. must,

"in the selection of a smaller number to be the constant recipients of a summons, have introduced a constitutional change scarcely inferior to that by which he incorporated the representatives of the commons in the national council; in other words, he created the House of Lords as much as he created the House of Commons."

That is to say, he did not create the first elements of either, which existed long before, nor did he give either its final shape, which neither took till afterwards; but he established both in such a shape that all later changes may be fairly looked on as merely changes in detail.

The succession of regular parliaments in the established sense of the word thus begins in 1295, and from that time we have a House of Lords consisting of prelates, earls, and barons, of whom the barons are fast becoming hereditary as well as the earls. But the body so formed is still spoken of by various names (see *Lords' Report*, i. 273, 277, 279, 302, 316—where we find the word *nobles*—et al.). The earliest use of the word *peer* in anything like its present sense is found in the Act against the Despensers, 1322 (*Lords' Report*, i. 281), where, as Bishop Stubbs says (*Const. Hist.*, ii. 183), "it is used so clumsily as to show that it was in this sense a novelty." The words are "prelates, countes, baronnes, et les autres *piers* de la terre," and again "nous *piers* de la terre, countes et barouns." It comes again in the act of deposition of Richard II. (*Lords' Report*, i. 349) in the form "*mares* et proceres regni Anglie, spirituales et temporales." Nothing therefore can be plainer than that the spiritual lords were looked on as peers no less than the temporal. The point indeed was formally settled at an intermediate time, namely by the Act of 1341

(*Lords' Report*, i. 313; Stubbs, *Const. Hist.*, ii. 389), when Archbishop Stratford secured the right of the peers ("*piers de la terre*") of both orders to be tried only by their peers in parliament ("*en pleyn parlement et devant les piers ou le roi se fait partie*"). It is worth noticing that at this point the *Lords' Report* stops to comment at some length on the special position of the peerage now established. As the committee puts it,

"The distinction of the peers of the realm as a separate class, by privileges confined to themselves personally as peers, and not extending to any others, but throwing at the same time all the rest of the free population into one class, having all equal rights, is a singularity which marks the constitution of the English government, and was first apparently clearly established by this statute to which all the other subjects of the realm gave their assent."

And again they remark (p. 314) that

"the confinement of the privilege of peerage to those called the peers of the realm, as a personal privilege, giving no privilege or even legal rank to their families, and moulding all who had not that privilege, however high their birth, into the mass of the commons, has been considered an important feature in the constitution of the government of England. It may have prevailed, and probably did in some degree prevail, before; but by this statute it was clearly and distinctly recognized."

This is true; yet the object of the statute is not to shut out the peers' children from privilege, but to assert the disputed privilege of the peers themselves. The exclusion of the peers' children from privilege is a mere inference, though a necessary one. No legislator ever decreed in so many words the exclusion of the children of peers from privilege, because no legislator ever decreed in so many words the privileges of the peers themselves.

By this time we may look on the position of the peerage as fully established. It is now fully received, as at least the ordinary rule, that the baron who was once summoned should be always summoned, and that his right to the summons should pass to his representative after him (*Lords' Report*, ii. 28). In short the parliamentary position of baron has become successive, a word answering pretty well to hereditary in the older sense. A question might now arise as to the nature of the succession, a question which could not arise as long as the person summoned had no certainty that he would be summoned again. In other words, was it necessarily hereditary in the later sense of that word? That is to say, the question of peerage by tenure, or rather the question whether the succession to a peerage might be by tenure, now sprang up. Did the right to the summons, and hereby the right to the peerage, go with the territorial barony itself, or did it go according to the line of natural descent from the first baron? There was a good deal to be said for the first view. We cannot doubt that barony by writ arose out of barony by tenure, that is, that the writ of summons was originally sent only to persons who held by barony, and, as the phrase "*majores barones*" implies, not to all of them. If then the barony and the natural line of descent of the first baron should be parted from each other, it was by no means unreasonable to argue that the writ, a consequence of the tenure, should go with the actual barony rather than follow the line of natural descent. And the same notion seems implied in the ancient practice of sending writs to the husbands of heiresses, even, by the courtesy of England, after the death of their wives (see Stubbs, *Const. Hist.*, iii. 438; *Hist. Peerage*, xxviii.). On the other hand the natural feeling in favour of direct hereditary succession would tell the other way, especially as soon as the doctrine of the ennobling of the blood had fully come in. It is that doctrine more than anything else which has got rid alike of peerages by tenure, of peerages for life, and of peerages held by the husbands of heiresses. If the peerage could pass by marriage or purchase, the doctrine of nobility of blood was set aside. Till that doctrine was fully established, there was nothing unreasonable in

either practice. Again, as the hereditary right to the summons became the rule, writs, held to be no less hereditary than those issued to the barons by tenure, began, even under Edward I., to be issued to persons who had no baronial tenure at all (see Stubbs, *Const. Hist.*, ii. 204; *Historic Peerage*, xxvi.). This practice would of course tell in favour of strict hereditary succession and against succession by tenure. The result has been that hereditary succession became the rule, but that the claim of succession by tenure was brought forward in some particular cases, as the earldom of Arundel and the baronies of Abergavenny, Berkeley, and others. The case of the earldom of Arundel (more truly of Sussex) is discussed at length in the *Lords' Report* (i. 405 sq.), and it is held (ii. 320) to be the only case in which peerage by tenure has been allowed. Yet nothing can be more contrary to all ancient notions of an earldom than that it should follow the possession of certain lands and buildings, as the castle and honour of Arundel. What is chiefly proved is that by the eleventh year of Henry VI. the ancient notion of an earldom had passed away, and that the earldom had sunk to be a mere rank. The succession to the earldom of Arundel was settled by Act of Parliament in 1627 (*Lords' Report*, ii. 242), an Act whose preamble seems to acknowledge the fact of the earldom by tenure. But succession by tenure seems as distinctly agreeable to the oldest notion of a barony as it is contrary to the oldest notion of an earldom. The tendency of later times has been against it, because it contradicts the fancy about "ennobling" of blood; yet those who have at different times claimed a place in the peerage by virtue of baronies by tenure have not been without strong arguments in the way of precedent. The latest claim of the kind, that to the barony of Berkeley, was not formally decided. The facts and arguments will be found at great length in Appendix III. to Sir Harris Nicolas's *Report on the Barony of Lisle*. His conclusion is against the claim by tenure; yet it certainly seems that, when the castle of Berkeley, the tenure of which was said to carry with it the barony and peerage, was separated from the direct line of succession, as specially when the castle was held by the crown in the 16th century (see pp. 321-327), the heirs were not summoned to parliament, or were summoned as a new creation (see on the other hand *Lords' Report*, ii. 143). There is no strictly legal decision of the general question; but an order in council in 1669 (*Lords' Report*, ii. 242) declares against barony by tenure, rather on grounds of expediency than of law. It was declared in the case of the barony of Fitzwalter that "barony by tenure had been discontinued for many ages, and was not then in being, and so not fit to be revived, or to admit any pretence of right to succession thereon." And the Lords' Committee (p. 241) give their own opinion that "the right of any person to claim to be a lord of parliament, by reason of tenure, either as an earl or as a baron, supposing such a right to have existed at the time of the charter of John, may be considered as abrogated by the change of circumstances, without any distinct law for the purpose." That is to say, the claim was as legal as any other claim of peerage, resting equally on usage; but it was inconvenient according to the new doctrine about blood being "ennobled."

The same age which saw the earls and barons put on the shape of an hereditary peerage was also that which saw the order enlarged by the creation of new classes of peers. The ancient earls of England now saw men placed over their heads bearing the French titles of *duke* and *marquess*. Neither title was absolutely new in England; but both were now used in a new sense. *Duke* and *earl* were in truth the same thing; *dux*, afterwards supplanted by *comes*, was the older Latin translation of the English

*ealdorman* or *eort*, and *eort* was the English word commonly used to express the *dukes* as well as the *counts* of other lands. So the *marchio*, *markgraf*, *marquis*, was known in England in his official character as the *lord marcher*. But now, first dukes and then marquesses come in as distinct ranks of peerage higher than earl. That the earls of England put up with such an assumption was most likely owing to the fact that the earliest dukes were the king's own sons and near kinsmen, the first of all being the eldest son of Edward III. He was created duke of Cornwall in 1337, a dukedom to which the eldest son of the reigning sovereign is born. Marquesses began under Richard II. in 1386, when Robert Vere, earl of Oxford, was created marquess of Dublin and directly afterwards duke of Ireland (*Lords' Fifth Report*, 78, 79). Lastly, in the next century, the tale of the ranks of the temporal peerage was made up by the insertion of another French title, that of *viscount*, between the earl and the baron. John Beaumont was in 1440 created Viscount Beaumont (*Lords' Fifth Report*, 235). The choice of a title, as concerned England, was a strange one, since, at least from the Norman Conquest onwards, *viscount*, *viccomes*, had been the everyday French and Latin description of the ancient English sheriff (see Stubbs, *Const. Hist.*, iii. 436, and the patent of creation in *Lords' Report*, v. 235, where the new viscount is placed "super omnes barones regni"). Since that time no title conveying the rights of peerage has been devised. The Lords' Committee (i. 470) look on it as doubtful whether such a power abides in the crown, and a decision in the spirit of the Wensleydale decision would most likely rule that such a creation would at least give no right to a seat in the House of Lords. Yet, if the crown be, as lawyers tell us it is, the fountain of honour, it is hard to see why its streams should not flow as readily in one age as in another. If Henry VI. could give his new invention of viscounts seats in parliament with precedence over barons, it is hard to see why James I. might not, if he had chosen, have given his new invention of baronets seats in parliament with precedences over dukes.

The five ranks of the temporal peerage were thus established in the order of duke, marquess, earl, viscount, baron. But it must be noticed that duke, marquess, and viscount, are strictly speaking titles in a sense in which baron is not. Baron in truth is very seldom used as a personal description (Stubbs, *Const. Hist.*, iii. 440), except in two or three special cases which are hard to account for, those chiefly of the baronies of Stafford and Greystock (see *Lords' Report*, i. 261, 394; ii. 185). The baron is commonly described by some of the endless forms of *senior*, or as *chevalier*, or sometimes—doubtless if he held that particular dignity—as *banneret*. To this day, though in familiar speech all ranks of peerage under duke are often confounded under the common description of *lord*, yet the names marquess, earl, and viscount are all far more commonly heard than the name baron, which is hardly ever used except in the most formal language. As for bannerets, though they seem sometimes to be mentioned along with various ranks of peerage (*Lords' Report*, i. 328), it does not appear (see Stubbs, *Const. Hist.*, iii. 446) that banneret ever really was a rank of peerage, like the others from baron up to duke.

The invention of these new ranks of peerage undoubtedly helped to strengthen the notion of the temporal peerage as an order distinct both from all who are not lords of parliament and from the spiritual lords also. Another novelty also came in along with the dukes and marquesses. The right of the earls was immemorial; the right of the barons had grown up by usage. Edward III. began to create earls and, when dukes were invented, dukes also, by patent. They were commonly created in parliament and with becoming ceremonies. Earls were thus first created

in 1328. This bestowal of an earldom as an hereditary rank is another process from granting an earldom, conceived as an office or even as *all estate*. Later in the century, in 1387, Richard II began to create barons also by patent (*Historic Peerage*, p. xlii.), and this form of creation gradually supplanted the ancient peerage by writ. The object of this change seems to have been (see *Historic Peerage*, p. xviii.) the better to mark the dignity as hereditary (for the hereditary nature of the barony by writ was after all only a matter of usage or inference), and at the same time to define the line of succession. This, in the baronies by writ, is said to be in the heirs-general of the grantee—words to be understood, as it would seem, of the heirs-general of his body only; in a barony or other peerage conferred by patent the line of succession may take any shape that the crown chooses, the most common limitation being to the heirs-male of the body of the grantee. Very singular lines of succession have sometimes been chosen (*Historic Peerage*, xlv.), as specially in the case of the dukedom of Somerset in 1547, in which the line of the eldest son was placed after that of the second. And the manifest right of the crown to name no line of succession at all, that is, to create a life-peerage only, was often exercised in the first days of dukes and marquesses. A duke of Exeter was created for life as late as 1416. Perhaps the strangest case of all is the patent of the barony of Lisle in 1444, which may be called the creation by patent of a barony by tenure. The whole story of the Lisle barony has been dealt with by Sir Harris Nicolas in a separate volume (see also *Lords' Report*, ii. 199 *sq.*; Stubbs, *Const. Hist.*, iii. 437); but it is only this patent that concerns us. It seems to grant a barony with a seat in parliament to the grantee John Talbot and his heirs and assigns, being lords of the manor of Kingston Lisle (see the document, the language of which varies in different parts, in the *Lords' Report*, ii. 199; v. 243). This is certainly strange; but, if we once grant the royal power to create peerages and to limit their succession at pleasure, it seems necessarily to follow that the crown may exercise that power in any way that it chooses, whether by limiting it to the grantee personally or giving any kind of remainder that it is thought good.

The temporal peerage being thus fully established on its present ground in the course of the 15th century, we come in the course of the next two centuries to see the effect of the theories under which it had grown up. A series of deductions are gradually made, naturally enough as deductions from the premises; but then the premises can be admitted only by trampling ancient precedents under foot. First of all, we have the denial already spoken of of some of the personal privileges of peerage to the spiritual lords. This was silently brought about in the Tudor times, when Bishop Fisher and Archbishop Cranmer—one might perhaps add Abbot Whiting—were tried by juries in defiance of the principle laid down by Archbishop Stratford under Edward III. Against this course no remonstrance seems to have been made; indeed the times were not favourable for remonstrances, least of all for remonstrances made by spiritual persons. The doctrine that the spiritual lords were lords of parliament but not peers was established by a standing order of the House of Lords older than 1625, as it is referred to in the journals of the House in that year. It was then referred to a committee of privileges for further consideration, but no report is recorded (cf. *Coke's Institutes*, ii. 30).

Presently all the powers both of the spiritual and the temporal lords were for a while extinguished, and those of the spiritual lords by an undoubted legislative act. The Act of 1642, by which the bishops lost their seats in parliament, stands distinguished, as a real and lawful act of

the legislature, from the process by which so much of the so-called law on the subject grew up through a series of resolutions, dictated mostly, we may venture to say, neither by precedent nor by written law, but by the prejudices and assumptions of a particular class of men. The exclusion of the bishops by the regular Act of 1642 was followed in 1649 by the less regular exclusion of the temporal lords also. The House of Lords was abolished by a vote of the House of Commons only. The essence of peerage was thus taken away, but the peers kept their titles and precedence, and they were allowed to be chosen to seats in the House of Commons. When the old parliamentary constitution revived in 1660, the Act of 1649 was naturally treated as null, while the Act of 1642 was of course treated as valid. In 1660 therefore a House of Lords again sat which consisted of temporal lords only. But the bishops were restored to their seats by an Act of the next parliament in 1661, and the lords again ordered a committee "to consider of an order in the standing orders of this House which mentions the lords the bishops to be only lords of parliament and not peers, whereas several Acts of Parliament mentions them to be peers." Nothing came of the labours of this second committee, and the doctrine which it was to consider has since been held for law. Both the doctrine and the reason for it have raised the indignation, not only of the two great constitutional historians, one of them himself a churchman, but of at least one great legal authority (see Blackstone, book i. c. 12, vol. i. p. 401, ed. Christian; and contrast Stephen, *New Commentaries*, ii. 590, and Kerr's Blackstone, i. 407; cf. Hallam, *Middle Ages*, ii. 138; *Lords' Report*, ii. 323, 339). The attack on the rights of the spiritual lords was carried yet further by the Commons in the case of the earl of Derby in 1679, when they objected to their voting on an impeachment even in its preliminary stages. Their right to take a part in all such proceedings up to the question which might involve life or death (a share in which on the part of churchmen would be contrary to canon law) is asserted by the eleventh article of the Constitutions of Clarendon (Stubbs, *Select Charters*, 133). The question now raised, which was decided in favour of the bishops, according to the terms of the Constitutions, did not directly touch the question of the peerage of the bishops, but it had an indirect connexion with it. The denial of the bishops' peerage implied that they had no right to be tried as peers in the court of the king in parliament, as not being, as the phrase goes, "of trial by nobility." It might therefore be plausibly argued that they had no right to be judges in that court. The right of the bishops to vote on a bill of attainder, which, on any canonical ground, would seem quite as objectionable as their voting on an impeachment, was never denied, because a bill of attainder is a legislative act, and does not touch the question of peerage. Indeed, we may say that the law is still far from clear on the whole matter. The statute of 1696 (7 and 8 Will. III.) for "regulating of Trials in cases of Treason and Misprision of Treason" speaks of "trials of peers" and of "all the peers who have a right to sit and vote in parliament," without distinctly defining whether the word *peer* is meant to apply to the lords temporal only.

In the same century another step in the development of the theory of peerage was taken by the resolutions of the lords in 1640 and 1678 that a peer could not relinquish his peerage. This inference also, whatever may be thought of it, though distinctly against earlier precedents, follows (see *Lords' Report*, ii. 25, 26, 48) directly from the doctrine of "ennobling of blood."

The next point in the history of the peerage is one which, like the exclusion of the bishops in 1642, was a matter of real legislation, as distinguished from mere

decisions and resolutions. This was the change in the theory of peerage which followed on the union of England and Scotland in 1707. By the treaty of union the peerage of Scotland was to be represented by sixteen of its number chosen for each parliament by the Scottish peers themselves. This amounted, as has been already set forth, to the creation of a class of men who are peers as concerns their personal privileges, but who are lords of parliament only *in posse* and not *in esse*. The Scottish peers were made incapable of sitting in the House of Commons, and the Scottish peerage was doomed to gradual extinction, as no new peers of Scotland were to be created. And further, by a resolution of the lords in 1711, it was held during the greater part of the last century that a patent of peerage of the United Kingdom granted to a Scottish peer did not give him a seat in parliament. Presently an attempt at legislation with regard to the peerage was made which, if carried, would have altogether changed its character. This was the Peerage Bill of 1719. That bill was not carried, but its proposals are worth notice, not only because they would, if they had become law, have altogether changed the nature of the peerage as a political institution, but also because they illustrate the way in which, like everything else in English constitutional history, the peerage and everything belonging to it had grown up gradually by force of precedent. The right of the crown to create peers at pleasure, and to entail their peerages on any line of succession that it thought good, had never been disputed, but neither had it ever been the subject of any legislative enactment. The proposed bill, in limiting both powers, would have given them their first being by formal legislation. The proposal was that the peerage of the United Kingdom should, after a creation of six peers, be confined to its existing number, with an exception in favour of members of the royal family. For the future, with that exception, no peerage could be created, except when one had become extinct. Instead of the sixteen elective peers of Scotland, the king was to bestow hereditary seats on twenty-five members of the Scottish peerage, and the number was to be kept up by a new promotion whenever any of the twenty-five peerages became extinct. It was forcibly remarked at the time that this would place the remainder of the Scottish peerage in a condition politically inferior to that of all other British subjects, as they would have been incapable both of sitting in either house of parliament and of choosing those who should sit in either. But the general effect of the bill on the constitution of the country would have been far more important. The crown would have lost one of its chief powers, and the relations between the peers and the rest of the nation would have been altogether changed. They would not have come any nearer to the strict notion of a nobility, for it was not proposed to confer direct privilege on any but the peers themselves. But the bill would have placed both the peers and their families in a wholly new position. They would have become a body into which no one could be raised, except in the occasional case of a peerage becoming extinct. It would have been impossible to move a statesman from the Commons to the Lords at any moment when it might be for the public good that he should be moved. Even the lord chancellor, the speaker of the House of Lords, could not have received a peerage unless one chanced to be extinct at the needful time. It is plain that the peers, if they did not become a nobility, would have become an oligarchy, a close body, cut off both from the crown and from the mass of the people in a way in which they had never been cut off before.

The next change in the peerage was that which followed the union with Ireland in 1800. The terms of that union, as regarded the peerage, differed a good deal from those of

the union with Scotland. The twenty-eight representative peers of Ireland are chosen for life, and the other Irish peers are capable of sitting in the House of Commons for constituencies in Great Britain; only by so doing they lose the privileges of peerage (other than mere titles and precedence) so long as they are members of that body. The Irish peerage is not doomed to extinction as well as the Scottish; one Irish peerage may always be created whenever three have become extinct, and the Irish peerage is always to be kept up to the number of one hundred, not counting those who hold peerages of the United Kingdom.

The changes with regard to the lords spiritual introduced by the union with Ireland, by the disestablishment of the Irish Church, and by the increase in the number of English bishoprics have affected the character of the House of Lords, but not that of the hereditary temporal peerage. By the Act of Union one Irish archbishop and four bishops—afterwards only three—were entitled to seats in rotation, changing, not from parliament to parliament, but from session to session. This arrangement was probably practically more convenient; but it seems contrary to the nature of a summons, which must surely be a summons for the whole life of a parliament. Each Irish bishop was thus an *in posse* lord of parliament, like the Scottish and Irish temporal peers, only with the certainty of a seat some time, if he lived long enough. By the Act of Disestablishment in 1869 the Irish bishops lost their seats altogether. And by two Acts of the present reign the English prelates, except the holders of the two archiepiscopal sees and those of London, Durham, and Winchester, have their position completely changed. The number of bishops has been increased, but not the number of spiritual lords. The bishop therefore who holds any see but one of those five waits for his summons to parliament till he reaches it by seniority. Till then he too is a lord of parliament *in posse*.

In our own day too we come, in 1856, to the case of the Wensleydale peerage, which has been already referred to (see May, *Constitutional History*, i. 291-298). Sir James Parke was by letters-patent created a peer for life only, and a summons to parliament was issued to him accordingly. This was a return to the ancient practice of the 14th and 15th centuries; but the power does not appear to have been exercised in later times except in the case of peeresses (see Nicolas, *Historic Peerage*, xvi.; May, i. 292). One hardly knows what to make of such creations as those of Lord Hay in 1606 and Lord Reede in 1644, the accounts of which in the *Historic Peerage* (xvi. 243, 394) seem somewhat contradictory. But, if the creation of Lord Hay was a real creation of a peer for life, but without the right to a seat in parliament, it was so defined by a clause in the patent itself, which would seem to imply that, without such a clause, the creation would have given a right to a seat in parliament. The right of the crown to create life-peers, though not exercised, was constantly asserted by the best lawyers, and it is admitted even in the *Lords' Report* (ii. 37; see May, i. 294). Yet in 1856 the House of Lords took upon itself, in defiance of the whole history of their order, to refuse admission to a baron lawfully created, lawfully summoned, merely because the crown had not bound itself, in the 19th century any more than in the 13th or 14th, to summon the representatives of the baron so created for ever and ever. This decision seems to be now accepted as law; yet it is hard to see how, except when they have been taken away by Act of Parliament, any powers which were exercised by Edward I. can be refused to Queen Victoria. In short, the rights of the crown, the reason and expediency of the case, were all sacrificed to the superstition about "ennobling of blood." And Sir T. E. May, recording the resolution with admiration (i. 296), tells us that "by constitutional usage, having the force of law, the House



of Lords had been for centuries a chamber consisting of hereditary councillors of the crown," and that "the crown could not change its constitution by admitting a life-peer to a seat in parliament." Three pages further on he found out that the House of Lords contained other members whose seats were not "hereditary" in the modern sense, and we can hardly think that he used that word in its ancient meaning. The crown yielded to the pretensions of the lords; Lord Wensleydale received a fresh creation by a patent extending to his imaginary heirs, and it is to be presumed that he was thereby "ennobled in blood" to the satisfaction of those with whom he had to sit. While the question of life-peerage was left in abeyance, the official peerages referred to at the beginning of this article were created by an act of 1876. These are the Lords of Appeal in Ordinary, paid officers who hold their office, like other judges, during good behaviour, who are lords of parliament, with a right to a writ of summons to sit and vote so long as they hold office, and who rank for life as barons with such titles as the crown may appoint. In the case therefore of the resignation or removal from office of a lord of appeal we should have the non-parliamentary baron revived. Whether in such a case he would be entitled to be tried in the king's court in parliament does not appear. Nor does the Act rule whether the lord so created is a peer, either while he is a lord of parliament or after he ceases to be such. The doctrine of "ennobling of blood" would seem to imply that, as his title is not hereditary, he is not a peer. It would follow then that a lord of appeal who has resigned or has been removed, though "entitled to rank as a baron for life," is a baron who is neither a peer nor a lord of parliament.

A peerage, by the decisions of 1640 and 1678 (*Lords' Report*, ii. 25, 49) cannot be either surrendered to the crown or alienated to any other person. It can be forfeited only by attainder or by Act of Parliament. Of this last process there seems to be only one case, that of George Neville, duke of Bedford, degraded by parliament in the reign of Edward IV., as not being wealthy enough to support his dignity. This of course, like attainder by Act of Parliament, comes under the general principle that parliament may do anything. It is further held (*Historic Peerage*, lrviii.) that, while an attainder for high treason extinguishes a peerage of any kind, an attainder for felony only extinguishes a peerage by writ, but not a peerage by patent. A peeress in her own right by descent or creation has all the privileges of a peer, except that of sitting in parliament, which is suspended while the peerage is held by a female, but revives when it passes to a male heir. The wife or widow of a peer, not being a peeress in her own right, has also the same privileges; but she loses them if she marries a commoner. By social usage she keeps her title, but, if charged with treason or felony, she is tried by a jury and not by the lords. If a peerage which passes to heirs-general, like the ancient baronies by writ, is held by a man who leaves no son, but more than one daughter, the peerage goes into abeyance; that is, it is held by no one till the abeyance is terminated. If there comes to be only one person representing the claims of all the sisters, he can claim the termination of the abeyance as a matter of right. The crown also can terminate it at any moment in favour of any of the persons between whom it is in abeyance, that is, in favour of the representative of any of the sisters. It is by this transmission through females that the ancient baronies have mainly lived on, often overshadowed by higher but more modern titles. Those peers who can show a direct succession in the male line from 1295 are few indeed. By female succession also the titles of these and other ancient baronies have in most cases got parted from the original surnames of the holders. This seems to

have led to the practice, which of late has been rather the rule than the exception, of creating peers with fancy titles, often very strange ones, sometimes neither their own surnames nor the name of any place with which they have anything to do. Yet, by a survival of the ancient notion of barony, the baron is always created Lord A of B (perhaps more strictly Lord A, Baron of B), though the place named is by no means always his own manor. The earl of course could originally be only the earl of a shire—the name of the shire and of the shire-town being often used indifferently. But, as the order of earls became more numerous, and as the official character of the earldom was quite forgotten, men were made earls of places of all kinds, and in modern times a surname has often been the title of both earls and marquesses. It is needless to say that the titles of marquesses, when territorial, have had no necessary reference to the original meaning of the title, as keeper of a march. The titles of dukedoms seem always to have been territorial, unless in the singular case of "Duchess Dudley" in the reign of Charles I. Dudley was the lady's surname; she does not seem to have been in any sense duchess of the town of Dudley. Clarendon always talks of "Duke Hamilton"; but here the surname is taken from a place. Viscounts take their titles both from names and places; but the viscount who has a territorial title is never spoken of as viscount of A, as the duke is always, and the marquess and the earl in language which is at all formal.

Children of peers have a definite precedence and an elaborate system of courtesy titles and epithets which perplexes foreigners and sometimes natives. The eldest son of a peer ranks immediately after peers of the rank next below that of his father; the younger sons rank after peers of the next degree below that. Thus a duke's eldest son ranks next after marquesses; a marquess's eldest son ranks next after earls, and a duke's younger son next after eldest sons of marquesses. The precedence of daughters follows the general principle, the principle implied in the doctrine of abeyance, that all daughters rank with the eldest son. Then again the eldest sons of dukes, marquesses, and earls bear by courtesy the second title of their fathers, and the eldest sons of the eldest sons of dukes and marquesses bear what may be called the grandfather's third title. All these, though called by a title of peerage, are, as we have already had need to insist, legally commoners; but the eldest sons of peers have been not uncommonly summoned to the House of Lords by the title of some barony held by their fathers. Their precedence is in no way affected by the title which they may happen to bear. The eldest son of a duke always ranks next after marquesses, whether his courtesy title, that is the second title of his father, is marquess or baron. The younger sons of dukes and marquesses bear the courtesy title of Lord with the Christian and surname, and, on the principle which regulates the precedence of daughters, the title of Lady extends to the daughters of earls as well as to those of dukes and marquesses. The daughter of a peer married to a commoner keeps her rank; but, if she marries a peer, she takes the rank of her husband, whether that be higher or lower than the rank which she has by birth. In all these matters the substantial privileges of the peerage and its mere honorary titles and precedence are often at curious cross purposes with one another. All sons of peers are esquires of right. By courtesy all children of peers who do not bear any higher title are entitled to the conventional epithet of "honourable"; "noble" they are not in any, even conventional, sense. The style formerly was, with perfect correctness, "Hon. A B, Esq." The "Esq." is now left out; it is not easy to see why.

It is curious to compare the peerage of England, and the peerages of Scotland and Ireland formed after its model, with the famous body of the twelve peers of France, from which we cannot doubt that the name *peers* was transferred to the English assembly of *witan*, *magnates*, or *proceres*. The twelve were the archbishop and duke of Rheims, the bishops and dukes of Langres and Laon, the bishops and counts of Beauvais, Noyon, and Châlons, the dukes of Burgundy, Normandy, and Aquitaine, the counts of Flanders, Toulouse, and Champagne. The list of the spiritual peers, a little startling at first, is easily understood when we take in the circumstances of the French kingdom in the 12th century. The six prelates are those who held of the king of the French as king; the other great churchmen of the Western Kingdom held either of one of the vassal princes (as the archbishop of Rouen did of the duke of the Normans) or of the king as duke, as did among others the bishop of Paris, whom at first sight we might have looked for on the list. The institution of this body is commonly attributed to the age of Philip Augustus, and indeed to that king personally; and it can hardly be doubted that it had its origin in the romances of Charlemagne. The twelve peers are said to have appeared at Philip's coronation, and also to have formed the court by which John, duke of the Normans and king of the English, was deprived of the lands that he held in fief of the French crown. But it is certainly hard to see them all in the character of twelve peers on either occasion, though it is certain that some of them were present at Philip's coronation in 1179, and among them the then duke of the Normans and husband of the duchess of Aquitaine, Henry king of the English.<sup>1</sup> Nor does the exact name of *peers* seem to be given by any contemporary writer to the body by which John is said to have been condemned, though it is so used in the next century (see *Prædara Francorum Facinora*, ap. Duchêne, *Rev. Franc. Script.*, v. 764). But

that there was an acknowledged body of peers of France in the 13th century is shown, if by nothing else, by the speech of Peter bishop of Winchester quoted above. Gradually all the temporal peerages became united with the crown, save only Flanders, which was released from vassalage when the emperor Charles V. was its count. It therefore became needful on ceremonial occasions that, while the spiritual peers appeared in person, the temporal peers should be represented by persons who were created peers for the occasion. The later peerage of France, those dukes, counts, and barons who were distinguished as *peers*, dates from the 14th century. The duchies so distinguished were at first confined to the royal family, and in some sort represented the ancient peerage; but the title of *duke and peer* was afterwards extended to others, among them in 1674 to at least one prelate, that of Paris, then become an archbishopric. The counties and baronies distinguished as peerages were but few, and most of them were reunited to the crown; they are therefore much less known than the duchies. In the more modern use of the word, the Chamber of Peers dates from the charter of Louis XVIII in 1814. It was a body of hereditary members created by the crown after the model of the temporal peerage of England. After the revolution of 1830 this was changed into a Chamber of Peers for life, which "ceased to exist" at the revolution of 1848.

The fullest account of the origin and growth of the English peerage will be found in the five volumes of the *Reports of the Lords Committee touching the Dignity of a Peer of the Realm* (1820-1829). The mass of information brought together is wonderful, and, though the prejudices of the order sometimes peep through, the general treatment of the subject is on the whole fair and highly creditable, especially when we remember that the inquiry was begun before any light had been thrown on the subject by modern research. Besides this, the works of Selden, Hallam, Nicolas, and Stubbs have been, as will have been remarked, constantly referred to throughout the article. But it is sometimes curious to compare the point of view of a professional antiquary like Sir Harris Nicolas with that of the two great constitutional historians. (E. A. F.)

PEGASUS, a famous horse of Greek fable, was said to have sprung from the trunk of the Gorgon Medusa when her head was cut off by Perseus. Bellerophon caught him as he drank of the spring Peirene on the Acrocorinthus at Corinth, or (according to another version) received him tamed and bridled at the hands of Athens. Mounted on Pegasus, Bellerophon slew the Chimera and overcame the Solymi and the Amasons, but when he tried to fly to heaven on his back the horse threw him and continued his heavenward course. Arrived in heaven, Pegasus served Zeus, fetching for him his thunder and lightning. Hence some have thought that Pegasus is a symbol of the thundercloud. In later legend he is the horse of Eos, the Morning. Pindar and later poets represent him as winged. The name is from πηγῆς, "compact," "stout." The erroneous derivation from πηγῆ, "a spring of water," may have given birth to the legends which connect Pegasus with water, as that his father was Poseidon, that he was born at the springs of Ocean (like the fabulous Indian horse Uccaihsravas, prototype of horses, produced at the churning of Ocean), and that he had the power of making springs gush from the ground by a blow of his hoof. This was said to have been the origin of Hippocrene (Horse-spring), the fountain of the Muses on Mount Helicon, as well as of another spring of the same name at Troezen. But there are facts that speak for an independent mythological connexion between horses and water, e.g., the sacredness of the horse to Poseidon, the epithets Hippios and Equester

applied to Poseidon and Neptune, the Greek fable of the origin of the first horse (produced by Poseidon striking the ground with his trident), and the custom in Argolis of sacrificing horses to Poseidon by drowning them in a well. (The Illyrians similarly sacrificed horses by drowning.) From his connexion with Hippocrene Pegasus has come to be regarded as the horse of the Muses and hence as a symbol of poetry. But this is a modern attribute of Pegasus, not known to the ancients, and dating only from the *Orlando Innamorato* of the Italian poet Boiardo.

PEGU, a division of British Burmah, comprising the districts of Rangoon, Hanthawaddy, Tharawadi, and Promé, has an area of 9159 square miles, with a population (in 1881) of 1,162,393. The province of Pegu was annexed by the British after the second Burmese war in 1852-53.

PEGU, an ancient town in the Rangoon district of British Burmah, is situated on the Pegu river, 20 miles west of the Tait-toung, in 17° 20' N. lat. and 96° 30' E. long. It was founded in 573 A.D., and was for a long time the capital of the Talaing kingdom, overthrown by Aloung-bhura in the middle of the 18th century. Early European travellers describe the city as of great size, strength, and magnificence. Modern Pegu lies close to the river-side, and had a population in 1881 of 5891.

PEHLEVI. See PAHLAVI.

PEIRCE, BENJAMIN (1809-1880), mathematician and astronomer, was born at Salem, Massachusetts, 4th April 1809. Graduating at Harvard College in 1829, he became mathematical tutor there in 1831 and professor in 1833. He had already assisted Bowditch in his translation of the *Mécanique Céleste*, and now produced a series of mathematical text-books characterized by the brevity

<sup>1</sup> See Rigordus, *De Gestis Philippi Augusti*, ap. Duchêne, *Hist. Frana. Script.*, v.; Will. Arn., *ib.* 101; Ben. Petrib. 242, ed. Stubbs; Matthew Paris, *ii.* 658, ed. Luard; cf. Sismondi, *Histoire des Français*, *l.* 363, 489-492.

and terseness which marks all his work and made his teaching unattractive to inapt pupils. To young men of real talent, on the contrary, his teaching and warm personal interest in their work were of the greatest advantage, and he holds a most honourable place in the development of American mathematics. After Bowditch's death in 1838 Peirce stood at the head of American mathematicians; but the first work that gave him a wider fame was his computation of the general perturbations of Uranus and Neptune (*Proc. Amer. Acad.*, 1848). In 1849 he became consulting astronomer to the American Nautical Almanac, and for this work he prepared new tables of the moon (1852). Another piece of important astronomical work was his discussion of the equilibrium of Saturn's ring, in which he showed that a fluid ring was necessarily unstable as well as a solid one. From 1867 to 1874 he was superintendent of the coast survey; in 1857 he published his largest and most characteristic work, the *System of Analytical Mechanics*. He himself, however, seems to have thought most of his *Linear Associative Algebra* (lithographed privately in a few copies, 1870; reprinted in the *American Journ. of Math.*, 1882). His death took place at Cambridge, United States, on 6th October 1880.

PEKING or PEKIN, the capital of the Chinese empire, is situated in 39° 54' 36" N. lat. and 116° 27' E. long., and stands on the northern extremity of the great alluvial delta which extends southwards from its walls for 700 miles. For the last nine centuries Peking, under various names and under the dominion of successive dynasties, has, with some short intervals, remained an imperial city. Its situation near the northern frontier recommended it to the Tatar invaders as a convenient centre for their power, and its peculiarly fortunate position as regards the supernatural terrestrial influences pertaining to it has inclined succeeding Chinese monarchs to accept it as the seat of their courts. In 986 it was taken by an invading force of Khitan Tatars, who adopted it as their headquarters and named it Nanking, or the "southern capital." During the early part of the 12th century the Chinese recaptured it and reduced it from the rank of a metropolis to that of a provincial city of the first grade, and called it Yen-shan Foo. In 1151 it fell into the hands of the Kin Tatars, who made it a royal residence under the name of Chung-tu, or "central capital." Less than a century later it became the prize of Jenghiz Khan, who, having his main interests centred on the Mongolian steppes, declined to move his court southwards. To his great successor Kublai Khan (1280-1294), however, the establishment of a capital within the frontiers of China became a necessity, and, following the example set him by preceding sovereigns, he made choice of Yenking, as he rechristened the city. With his usual magnificence, he rebuilt the town, which became known in Chinese as Ta-tu, or "great capital," and in Mongolian as Khanbalik, or "city of the khan." During the reign of the first emperor of the dynasty (1368-1399) which succeeded that founded by Jenghiz Khan the court resided at the modern Nanking, but in the eyes of the succeeding sovereign Yung-lo (1403-1425) the political advantages of a northern residence appeared so obvious that he transferred his court to Peking (i.e., the northern capital), which has ever since been the seat of government.

During the periods above mentioned the extent and boundaries of the city varied considerably. Under the Kin dynasty the walls extended to the south-west of the Tatar portion of the present city, and the foundations of the northern ramparts of the Khan-balik of Kublai Khan are still to be traced at a distance of about 2 miles in a northerly direction beyond the existing walls. The modern city consists of two parts, the *nei ch'ing*, or inner city, commonly known to foreigners as the "Tatar city," and the *wai ch'ing*, or outer city, known in the same way as the "Chinese city." These names are somewhat misleading, as the inner city is not enclosed within the outer city, but adjoins its northern wall, which, being longer than the *nei ch'ing* is wide, outflanks it considerably at both ends, as may be seen in the accompanying plan. The outer walls of the double city contain an area of about 25 square miles, and measure 30 miles in circumference. Unlike the walls of most Chinese cities, those of Peking are kept in perfect order. Those of the Tatar portion, which is the oldest part of the city, are 50 feet high, with a width of 60 feet at the base and 40 feet at the top, while those of the Chinese city, which were built by the emperor Kea-ting in 1543, measure 30 feet in height, and have a width of 25 feet at the base and 15 feet at the top. The terre-plein is well and smoothly paved, and is defended by a crenellated parapet. The outer faces of the walls are strengthened by square buttresses built out at intervals of 60 yards, and on

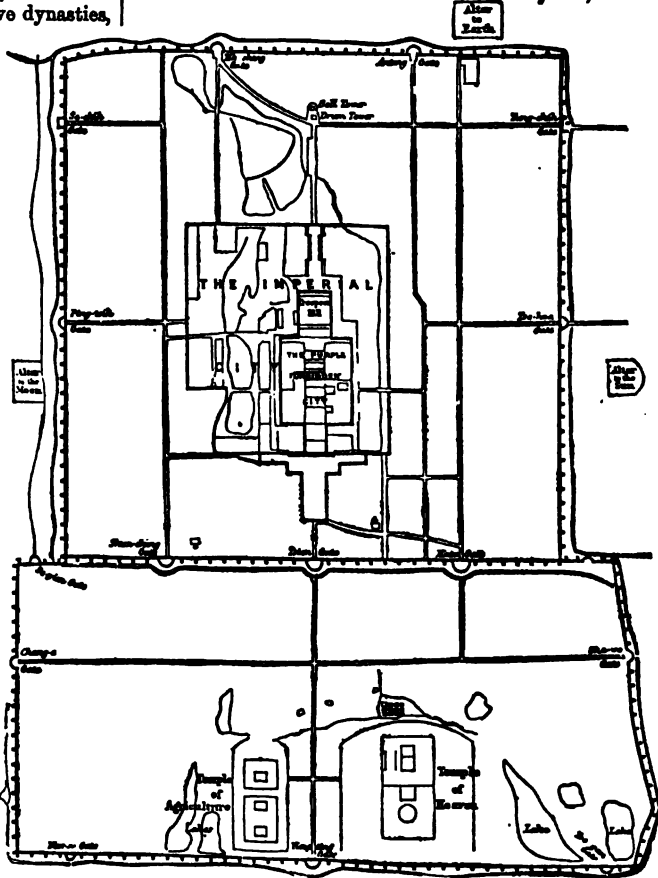

Plan of Peking. (Scale, one mile and a half to an inch.) the summits of these stand the guard-houses for the troops on duty. Each of the sixteen gates of the city

is protected by a semicircular enceinte, and is surmounted with a high tower built in galleries and provided with countless loopholes.

The population of Peking is reckoned to be about 1,000,000, a number which is out of all proportion to the immense area enclosed within its walls. This disparity is partly accounted for by the facts that large spaces, notably in the Chinese city, are not built over, and that the grounds surrounding the imperial palace, private residences, and temples are very extensive. Viewed from the walls Peking looks like a city of gardens. Few crowded neighbourhoods are visible, and the characteristic features of the scene which meets the eye are the upturned roofs of temples, palaces, and mansions, gay with blue, green, and yellow glazed tiles, glittering among the groves of trees with which the city abounds. Enclosed within the Tatar city is the *Huang ch'ing*, or "Imperial city," which in its turn encloses the *Tze-kin ch'ing*, or "Purple Forbidden city," in which stands the emperor's palace. On the north of the *Tze-kin ch'ing*, and separated from it by a moat, is an artificial mound known as the *King shan*, or "Prospect Hill." This mound, which forms a prominent object in the view over the city, is about 150 feet high, and is topped with five summits, on each of which stands a temple. It is encircled by a wall measuring upwards of a mile in circumference, and is prettily planted with trees, on one of which the last emperor of the Ming dynasty (1644), finding escape from the Manchu invaders impossible, hanged himself. On the west of Prospect Hill is the *Se yuen*, or "Western Park," which forms part of the palace grounds. This park is tastefully laid out, and is traversed by a lake, which is mainly noticeable from the remarkably handsome marble bridge which crosses it from east to west. Directly northwards from Prospect Hill stand the residence of the Titu, or "governor of the city," and the Bell and the Drum Towers, both of which have attained celebrity from the nature of their contents,—the first from the huge bell which hangs in it, and the second from the appliances it contains for marking the time. The bell is one of five which the emperor Yung-lo ordered to be cast. In common with the others, it weighs 120,000 lb, is 14 feet high, 34 feet in circumference at the rim, and is 9 inches thick. It is struck by a wooden beam swung on the outside, and only at the changes of the night-watches, when its deep tone may be heard in all parts of the city. In the Drum Tower incense-sticks, specially prepared by the Astronomical Board, are kept burning to mark the passage of time, in which important duty their accuracy is checked by a clepsydra. Another of Yung-lo's bells is hung in a Buddhist temple outside the north-west angle of the city wall, and is covered both on the inside and outside with the Chinese texts of the *Lankavatara Sūtra*, and the *Saddharma pundarika Sūtra*.

Turning southwards we again come to the Purple Forbidden city, the central portion of which forms the imperial palace, where, in halls which for the magnificence of their proportions and barbaric splendour are probably not to be surpassed anywhere, the Son of Heaven holds his court, gives audience to ambassadors from tributary states, and receives the congratulations of his ministers at the annual seasons of rejoicing. In the eastern and western portions of this city are situated the residences of the highest dignitaries of the empire; while beyond its confines on the south stand the offices of the six official boards which direct the affairs of the eighteen provinces. It was in the "yamun" of one of these boards—the *Le Pu* or board of rites—that Lord Elgin signed the treaty at the conclusion of the war in 1860,—an event which derives especial interest from the fact of its having been the first occasion on which a European plenipoten-

tiary ever entered Peking accompanied by all the pomp and circumstance of his rank.

Outside the Purple Forbidden city the most noteworthy building is the Temple of Heaven, which stands in the outer or Chinese city. Here at early morn on the 22d of December the emperor offers sacrifice on an open altar to Shang-ti, and at periods of drought or famine presents prayers for relief to the same supreme deity. The altar at which these solemn rites are performed "consists of a triple circular marble terrace, 210 feet wide at the base, 150 in the middle, and 90 at the top." The uppermost surface is paved with blocks of the same material forming nine concentric circles, the innermost consisting of nine blocks, and that on the outside of eighty-one blocks. On the central stone, which is a perfect circle, the emperor kneels, "surrounded first by the circles of the terraces and their enclosing walls, and then by the circle of the horizon." In the same temple stands the altar of prayer for good harvests, which is surmounted by a triple-roofed circular structure 99 feet in height. The tiles of these roofs are of glazed porcelain of the most exquisite deep-blue colour, and add a conspicuous element of splendour to the shrine, which even without their aid would inspire admiration by the grace of the design and the rare beauty of the materials employed in its construction.

The other powers of nature have shrines dedicated to them at the altar to Earth on the north of the city, the altars to the Sun and Moon outside the north-eastern and north-western angles respectively of the Chinese city, and the altar of Agriculture inside the south gate of the Chinese city. Next to these in religious importance comes the Confucian temple, known as the *Kwo-tse-kuen*. Here there is no splendour; everything is quite plain; and one hall contains all that is sacred in the building. There the tablets of "the soul of the most holy ancestral teacher, Confucius," and of his ten principal disciples stand as objects of worship for their countless followers. In one courtyard of this temple are deposited the celebrated tea stone drums which bear poetical inscriptions commemorative of the hunting expeditions of King Suen (827-781 a.c.), in whose reign they are believed, though erroneously, to have been cut; and in another stands a series of stone tablets on which are inscribed the names of all those who have obtained the highest literary degree of *Tsin-tsu* for the last five centuries.

In the south-eastern portion of the Tatar city is the observatory, which was built by order of Kublai Khan in 1296. During the period of the Jesuit ascendancy in the reign of K'ang-he (1661-1721), the superintendence of this institution was confided to Roman Catholic missionaries, under whose guidance the bronze instruments now existing were constructed. Unlike the thoroughfares in the cities of central and southern China, the streets of Peking are wide and open, but, being unpaved and the soil being light and alluvial, they easily become almost impassable from mud in wet weather and ankle-deep in dust in dry weather. The inhabitants of Peking being consumers only, and in no way producers, the trade of the city is very small, and the article of the European treaties which prohibits foreign merchants from trading within the walls is, therefore, to be regretted only as an instance of the narrow-mindedness of the Chinese Government.

E. Bretschneider, *Archæological and Historical Researches on Peking and its Environs* (1876); S. Wells Williams, *The Middle Kingdom* (1884); Edkins, *Peking* (1870). (R. K. D.)

PELAGIA, St. An Antiochene saint of this name, a virgin of fifteen years, who chose death by a leap from the housetop rather than dishonour, is mentioned by Ambrose (*De Virg.*, iii. 7, 33 sq., Ep. xxxvii. ad Simplic.), and is the subject of two sermons by Chrysostom. More famous is

the story of another Pelagia of Antioch, a famous ballet-girl of the town, who, in the full flower of her beauty and guilty sovereignty over the youth of the city, was suddenly converted by the influence of the holy bishop Nonnus, whom she had seen and heard for a moment as he preached in front of a church which she happened to pass with her gay train of attendants and admirers. She sought out Nonnus, and her tears of genuine penitence overcame his canonical scruples; she was baptized, and, disguising herself in male attire and in the dress of a penitent, she retired to the grotto on the Mount of Olives which still bears her name, and there died after three years of strict penance. This story, which seems to combine with the name of the older Pelagia some traits from an actual history referred to by Chrysostom (*Hom. lxvii. in Mat. § 3*), is preserved in a narrative bearing the fictitious name of John, a deacon of the equally fictitious Nonnus, which by internal evidence is assigned by Usener to the second quarter of the 5th century. Usener, however, has shown that the very popular legend has a much older basis, and that, in common with a number of other female saints, including Marina or MARGARITA (q.v.), and Pelagia of Tarsus, whose story is closely akin to the Marina legend, Pelagia is only a Christianized travesty of an old local form of Aphrodite. The name of Marina or Pelagia is an epithet of Aphrodite; the parallel figure of Anthusa in Seleucia of Cilicia bears a name to be explained by the Anthera of Cnossus; the corresponding saint at Tyre is Porphyria, corresponding to Venus Purpurissa. The contradictory attributes of a pure virgin and a penitent are explicable in legends proper to the Syrian coast, where Astarte-Aphrodite had correspondingly opposite forms and character; the masculine garb of the converted Pelagia is to be explained from the hermaphrodite Aphroditus-Aphrodite of western Asia, the Cyprian Amathusia.

See Usener, *Legenden der heiligen Pelagia*, Bonn, 1879, and Gildemeister's edition of the Syriac version of the legend of Pelagia of Antioch, *Bonn Univ. Progr.* of 22d March 1879.

**PELAGIUS.** Of the origin of Pelagius almost nothing is known. The name is supposed to be a Grecized form of the Cymric *Morgan* (*muir*, sea; *gin*, begotten). His contemporaries understood that he was of British birth, and gave him the distinctive appellation *Brito*. He was a large ponderous person, heavy both in body and mind, if we are to believe Jerome ("stolidissimus et Scotorum pulvis prægravatus"). Born during the second half of the 4th century, he was influenced by the monastic enthusiasm which had been kindled in Gaul by Athanasius (336), and which, through the energy of Martin of Tours (361), rapidly communicated itself to the Britons and Scots. For, though Pelagius remained a layman throughout his life, and though he never appears in any strict connexion with a cenobitical fraternity, he yet adhered to monastic discipline ("veluti monachus"), and distinguished himself by his purity of life and exceptional sanctity ("egregie Christianus"). He seems to have been one of the earliest, if not the very earliest, of that remarkable series of men who issued from the monasteries of Scotland and Ireland and carried back to the Continent in a purified form the religion they had received from it. Coming to Rome in the beginning of the 5th century (his earliest known writing is of date 405), he found a scandalously low tone of morality prevalent. From his extant *Commentaries on the Epistles of St Paul* it may be gathered that men were encouraged to rely on a profession of the Christian creed, and on the magical efficacy of the sacraments, while they entirely neglected to cultivate a Christian character. This state of things Pelagius denounced. But his remonstrances were met by the plea of human weakness ("durum est, arduum est, non possumus, homines sumus, fragili carne circum-

dati"). To remove this plea by exhibiting the actual powers of human nature became his first object. It seemed to him that the Augustinian doctrine of total depravity and of the consequent bondage of the will both cut the sinew of all human effort and threw upon God the blame which really belonged to man. Unless men had the power to do God's will, it was vain for Him to declare it. And, if men believed they were incapable of virtue, they would make no effort to reach it. His favourite maxim was, "If I ought, I can." Accordingly, he expressed unmeasured disapproval when he heard a bishop at Rome quoting with approbation the characteristic words of Augustine: "Give what Thou commandest, and command what Thou wilt."

The views of Pelagius did not originate in a conscious reaction against the influence of the Augustinian theology, although each of these systems was developed into its ultimate form by the opposition of the other. Neither must too much weight be allowed to the circumstance that Pelagius was a monk, for he was unquestionably alive to the delusive character of much that passed for monkish sanctity. Yet possibly his monastic training may have led him to look more at conduct than at character, and to believe that holiness could be arrived at by rigour of discipline. This view of things suited his natural temperament, which was essentially matter-of-fact and somewhat shallow. Judging from the general style of his writings, his religious development had been equable and peaceful, not marked by the prolonged mental conflict, the spiritual turmoil, the hand-to-hand wrestling with God, the abrupt transitions, which characterized the experience of his great opponent. With no great depth of mind, he saw very clearly the thing before him, and many of his practical counsels are marked by sagacity, and are expressed with the succinctness of a proverb ("corpus non frangendum, sed regendum est"). His interests were primarily ethical; hence his insistence on the freedom of the will and his limitation of the action of divine grace.

The peculiar tenets of Pelagius, though indicated in the commentaries which he published at Rome previous to 409, might not so speedily have attracted attention had they not been adopted by Coelestius, a much younger and bolder man than his teacher. Coelestius had been trained as a lawyer, but abandoned his profession for an ascetic life. When Rome was sacked by the Goths (410) the two friends crossed to Africa. There Pelagius once or twice met with Augustine, but very shortly sailed for Palestine, where he justly expected his opinions would be more cordially received. Coelestius remained in Carthage with the view of receiving ordination. But Aurelius, bishop of Carthage, being warned against him, summoned a synod, at which Paulinus, a deacon of Milan, charged Coelestius with holding the following six errors:—(1) that Adam would have died even if he had not sinned; (2) that the sin of Adam injured himself alone, not the human race; (3) that new-born children are in the same condition in which Adam was before the fall; (4) that the whole human race does not die because of Adam's death or sin, nor will the race rise again because of the resurrection of Christ; (5) that the law gives entrance to heaven as well as the gospel; (6) that even before the coming of Christ there were men who were entirely without sin. To these propositions a 7th is sometimes added, "that infants, though unbaptized, have eternal life," a corollary from the third. Coelestius did not deny that he held these opinions, but he maintained that they were open questions, on which the church had never pronounced. The synod, notwithstanding, condemned and excommunicated him. Coelestius, after a futile appeal to Rome, repaired to Ephesus, and there received ordination.

In Palestine Pelagius lived unmolested and revered,

until in 415 Orosius, a Spanish priest, came from August-ine to warn Jerome against him. The result was that in June of that year Pelagius was cited before John, bishop of Jerusalem, and charged with holding that man may be without sin, if only he desires it. This prosecution broke down, and in December of the same year Pelagius was summoned before a synod of fourteen bishops at Diospolis (Lydda). The prosecutors on this occasion were two Gallican bishops, Heros of Arles and Lazarus of Aix, but on account of the illness of one of them neither could appear. The proceedings, being conducted in various languages and by means of interpreters, lacked certainty, and justified Jerome's application to the synod of the epithet "miserable." But there is no doubt that Pelagius repudiated the assertion of Cœlestius, that "the divine grace and help is not granted to individual acts, but consists in free will, and in the giving of the law and instruction." At the same time he affirmed that a man is able, if he likes, to live without sin and keep the commandments of God, inasmuch as God gives him this ability. The synod was satisfied with these statements, and pronounced Pelagius to be in agreement with Catholic teaching. Pelagius naturally plumed himself on his acquittal, and provoked Augustine to give a detailed account of the synod, in which he shows that the language used by Pelagius was ambiguous, but that, being interpreted by his previous written statements, it involved a denial of what the church understood by *grace* and by man's dependence on it. The North-African church as a whole resented the decisions of Diospolis, and sent up from their synods of Carthage and Mileve (416) an appeal to Innocent, bishop of Rome, who decided the question in favour of the African synods on "the broad, popular, and unanswerable ground that all Christian devotion implies the assistance of divine grace, that it is admitted in every response of the service, in every act of worship." And, though his successor Zosimus wavered for a time, influenced partly by his Greek training, which led him to consider the points in dispute as idle, and partly by the *Confession of Faith* which Pelagius had addressed to the see of Rome, he at length fell in with what he saw to be the general mind of both the ecclesiastical and the civil powers. For, simultaneously with the largely attended African synod which finally condemned Pelagianism in the West, an imperial edict was issued at Ravenna on 30th April 418, peremptorily determining the theological question and enacting that not only Pelagius and Cœlestius but all who accept their opinions shall suffer confiscation of goods and irrevocable banishment. Thus prompted, Zosimus drew up a circular inviting all the bishops of Christendom to subscribe a condemnation of Pelagian opinions. To this document signature was refused by nineteen Italian bishops, among whom was Julian of Eclanum (Apulia), a man of good birth, approved sanctity, and great capacity, who now became the recognized leader of the movement. But not even his acuteness and zeal could redeem a cause which was rendered hopeless when the Eastern Church (Ephesus, 431) confirmed the decision of the West.

#### *Pelagianism.*

The system of Pelagius is a consistent whole, each part involving the existence of every other. Starting from the idea that "ability limits obligation," and resolved that men should feel their responsibility, he insisted that man is able to do all that God commands, and that there is, and can be, no sin where the will is not absolutely free,—able to choose good or evil. The favourite Pelagian formula, "Si necessitatis est, peccatum non est; si voluntatis, vitari potest," has an appearance of finality which imposed on superficial minds. The theory of the will involved in this fundamental axiom of Pelagianism is that which is commonly known as the "liberty of indifference," or "power of contrary choice,"—a theory which affirms the freedom of the will, not in the sense that the individual is self-determined, but in the sense that in each volition and at each

moment of life, no matter what the previous career of the individual has been, the will is in equipoise, able to choose good or evil. We are born characterless (non pleni), and with no bias towards good or evil (ut sine virtute, ita et sine vicio). It follows that we are uninjured by the sin of Adam, save in so far as the evil example of our predecessors misleads and influences us (non propagat sed exemplo). There is, in fact, no such thing as original sin, sin being a thing of will and not of nature; for if it could be of nature our sin would be chargeable on God the creator. This will, capable of good as of evil, being the natural endowment of man, is found in the heathen as well as in the Christian, and the heathen may therefore perfectly keep such law as they know. But, if all men have this natural ability to do and to be all that is required for perfect righteousness, what becomes of grace, of the aid of the Holy Spirit, and, in a word, of Christianity? Pelagius vacillates considerably in his use of the word "grace." Sometimes he makes it equivalent to natural endowment. Indeed one of his most careful statements is to this effect: "We distinguish three things—the ability, the will, the act (*posse, velle, esse*). The ability is in nature, and must be referred to God, who has bestowed this on His creature; the other two, the will and the act, must be referred to man, because they flow from the fountain of free will" (Aug. *De Gr. Christi*, c. 4). But at other times he admits a much wider range to grace, so as to make Augustine doubt whether his meaning is not, after all, orthodox. But, when he speaks of grace "sanctifying," "assisting," and so forth, it is only that man may "more easily" accomplish what he could with more difficulty accomplish without grace. A decisive passage occurs in the letter he sent to the see of Rome along with his *Confessio Fidei*: "We maintain that free will exists generally in all mankind, in Christians, Jews, and Gentiles; they have all equally received it by nature, but in Christians only it is assisted by grace. In others this good of their original creation is naked and unarmed. They shall be judged and condemned because, though possessed of free will, by which they might come to the faith and merit the grace of God, they make an ill use of their freedom; while Christians shall be rewarded because, by using their free will aright, they merit the grace of the Lord and keep His commandments" (*ib.*, c. 33, 34). Pelagius allowed to grace everything but the initial determining movement towards salvation. He ascribed to the unassisted human will power to accept and use the proffered salvation of Christ. It was at this point his departure from the Catholic creed could be made apparent: Pelagius maintains, expressly and by implication, that it is the human will which takes the initiative, and is the determining factor in the salvation of the individual; while the church maintains that it is the divine will that takes the initiative by renewing and enabling the human will to accept and use the aid or grace offered.

#### *Semipelagianism.*

It was easy for Augustine to show that this was an "impia opinio"; it was easy for him to expose the defective character of a theory of the will which implied that God was not holy because He is necessarily holy; it was easy for him to show that the positions of Pelagius were anti-Scriptural (see *AVOUCINE*); but, though his arguments prevailed, they did not wholly convince, and the rise of Semipelagianism—an attempt to hold a middle course between the harshness of Augustinianism and the obvious errors of Pelagianism—is full of significance. This earnest and conciliatory movement discovered itself simultaneously in North Africa and in southern Gaul. In the former church, which naturally desired to adhere to the views of its own great theologian, the monks of Adrumetum found themselves either sunk to the verge of despair or provoked to licentiousness by his predestinarian teaching. When this was reported to Augustine he wrote two elaborate treatises to show that when God ordains the end He also ordains the means, and if any man is ordained to life eternal he is thereby ordained to holiness and zealous effort. But meanwhile some of the monks themselves had struck out a *via media* which ascribed to God sovereign grace and yet left intact man's responsibility. A similar scheme was adopted by Cassian of Marseilles (hence Semipelagianism are often spoken of as *Masilianism*), and was afterwards ably advocated by Vincent of Lerins and Faustus of Rhegium. These writers, in opposition to Pelagius, maintained that man was damaged by the fall, and seemed indeed disposed to purchase a certificate of orthodoxy by the abusive epithets they heaped upon Pelagians (*rana, musca moritura, &c.*). The differentia of Semipelagianism is the tenet that in regeneration, and all that results from it, the divine and the human will are co-operating (synergistic) coefficient factors. After finding considerable acceptance, this theory was ultimately condemned, because it retained the root-principle of Pelagianism,—that man has some ability to will good and that the beginning of salvation may be with man. The councils of Orange and Valence (529), however, which condemned Semipelagianism, did so with the significant restriction that predestination to evil was not to be taught,—a restriction so agreeable to the general feeling of the church that, three centuries after, Gottschalk was sentenced to be



degraded from the priesthood, scourged, and imprisoned for teaching heresies. The questions raised by Pelagius continually recur, but, without tracing the strife as sustained by Thomists and Jansenists on the one side and the Jesuits and Arminians on the other, this article can only indicate the general bearing of the controversy on society and the church.

The anthropology of Pelagius was essentially naturalistic. It threatened to supersede grace by nature, to deny all immediate divine influence, and so to make Christianity practically useless. Pelagius himself did not carry his rationalism through to its issues; but the logical consequence of his system was, as Augustine perceived, the denial of the atonement and other central truths of revealed religion. And, while the Pelagians never existed as a sect separate from the church catholic, yet wherever rationalism has infected any part of the church there Pelagianism has sooner or later appeared; and the term "Pelagian" has been continued to denote views which minimize the effects of the fall and unduly magnify man's natural ability. These views and tendencies have appeared in theologies which are not in other respects rationalistic, as, e. g., in Arminianism; and their presence in such theologies is explained by the desire to remove everything which might seem to discourage human effort.

It is not easy to determine how far the vices which ate so deeply into the life of the church of the Middle Ages were due to the sharpness with which some of the severer features of the Augustinian theology were defined during the Pelagian controversy. The pernicious belief in the magical efficacy of the sacraments and the consequent defective ethical power of religion, the superstitious eagerness to accept the church's creed without examining or really believing it, the falsity and cruelty engendered and propagated by the idea that in the church's cause all weapons were justifiable, these vices were undoubtedly due to the belief that the visible church was the sole divinely-appointed repository of grace. And the sharply-accentuated tone in which Augustinianism affirmed man's inability quickened the craving for that grace or direct agency of God upon the soul which the church declared to be needful and administered through her divinely-appointed persons and sacraments, and thus brought a decided impulse to the development of the sacerdotal system.

Again, although it may fairly be doubted whether, as Baur supposes, Augustine was permanently tainted with the Manichean notion of the inherent evil of matter, it can scarcely be questioned that his views on marriage as elicited by the Pelagian controversy gave a considerable impulse to the already prevalent idea of the superiority of virginity. When the Pelagians declared that Augustine's theory of original sin discredited marriage by the implication that even the children of the regenerate were born in sin, he could only reply (*De Nuptiis et Concupiscentia*) that marriage now cannot partake of the spotless purity of the marriage of unfallen man, and that, though what is evil in concupiscence is made a good use of in marriage, it is still a thing to be ashamed of,—not only with the shame of natural modesty (which he does not take into account) but with the shame of guilt. So that, even although he is careful to point out the advantages of marriage, an indelible stigma is still left even on the lawful procreation of children.

The remark of Milman, that "all established religions subside into Pelagianism, or at least semi-Pelagianism," is unexpected, but the converse remark, that "no Pelagian ever has or ever will work a religious revolution," may be easily substantiated. It has indeed become a commonplace of historical science that in order to do or to endure great things men must believe in one form or other of predestination. They must feel confident that they are made use of by God to accomplish things that to Him seem worthy, and that until these be accomplished no earthly power can defeat or harm them. They must feel that their will is embraced in the divine and empowered by it. And it is the consciousness of their own impotence that leads men to yield themselves as instruments of the divine power. Pelagianism is the creed of quiet times and commonplace people; Augustinianism is the inevitable faith of periods that are dangerous and eventful, and in which men must exhibit some heroism.

Of the writings of Pelagius there have been preserved to us in the works of Jerome (9th vol. of Martianus's ed., and 11th vol. of Vallarsi's ed.);—(1) *Commentarii in Epistolam Pauli*; (2) *Epistolæ ad Demetriadem* (also published separately by Samler, Halle, 1776); (3) *Liberius Fides*. But in Augustine's various writings against Pelagianism (in the 10th vol. of Bened. ed.) many passages are cited from the writings of Pelagius; and in the appendix of the same volume a valuable collection of documents connected with the controversy will be found. In the ordinary histories of the church other authorities are mentioned, and references need here be made only to Wiggers, *Forsch.* . . . *des Augustinismus und Pelag.* (Hamburg, 1838; translated by Emerson, Andover, 1840); Wörter, *Der Pelagianismus* (2d ed., Freiburg, 1874); Guizot, *Histoire de la Civilisation en France*, 1<sup>re</sup> leçon; Mosley, *Augustinian Doctrines of Predestination* (London, 1856); and Cunningham, *Historical Theology* (Edin., 1868). (M. D.)

PELAGIUS I., pope from 555 to 560, was a Roman by birth, and first appears in history at Constantinople in the rank of deacon, and as apocriarius of Pope Silverius, whose overthrow in favour of Vigilius his intrigues pro-

moted. Vigilius continued him in his diplomatic appointment, and he was sent by the emperor Justinian in 542 to Antioch on ecclesiastical business; he afterwards took part in the synod at Gaza which deposed Paul of Alexandria. In his official position he had amassed some wealth, which on his return to Rome he so employed among the poor as to secure for himself great popularity; and, when Vigilius was summoned to Byzantium in 544, Pelagius, now archdeacon, was left behind as his vicar, and by his tact in dealing with Totila, the Gothic invader, succeeded in saving the citizens from murder and outrage. He appears subsequently to have followed his master to Constantinople, and there to have taken part in the Three Chapters controversy; in 553, at all events, he signed the "constitutum" of Vigilius in favour of these, and for refusing, along with him, to accept the decrees of the fifth general council (the 2d of Constantinople, 553) shared his sentence of exile. Like Vigilius, he afterwards, however, condemned the chapters, and accordingly, when the citizens of Rome, through the mediation of Narses, begged for the restoration of the pope and his clergy, both were recalled from banishment. The emperor now asked the Roman representatives whom they should prefer—Vigilius or Pelagius—and it may safely be presumed that their reply, to the effect that they would not choose the latter as long as the former was alive, was hardly such as Justinian had expected or wished. Both set out for Rome, but Vigilius died mysteriously on the way at Syracuse. Pelagius, as the nominee of Justinian, at once succeeded on his arrival in Rome, but most of the clergy, suspecting his orthodoxy, and believing him to have had some share in the unlooked-for removal of his predecessor, shunned his fellowship, and only two bishops and one presbyter could be got to take part in his ordination to the pontificate. He enjoyed, however, the support of Narses, and, after he had publicly purged himself of the charge of complicity in Vigilius's death by solemn oath in the church of St Peter, he met with toleration, at least so far as his own immediate diocese was concerned, the populace remembering his former charities and his success in dealing with Totila. The rest of the Western bishops, however, still held aloof from the man who, by condemning the Three Chapters, had put a slight, as they thought, upon the council of Chalcedon; and the episcopate of Tuscanly caused his name to be removed from the diptychs. This elicited from him a circular, in which he asserted his loyalty to the four general councils, and declared that in their action against the holy see the hostile bishops had been guilty of schism. The bishops of Liguria and Emilia, headed by the archbishop of Milan, and those of Istria and Venice, headed by Paulinus of Aquileia, also withheld their fellowship from one who had taken part in the council of Constantinople; but Narses resisted the appeals of Pelagius, who would fain have invoked the secular arm. Childebert, king of the Franks, also, even after the pope had sent a confession of his faith, refused to interfere. Pelagius died on 3d March 560, and was succeeded by John III.

PELAGIUS II., a native of Rome, but of Gothic descent, was pope from 578 to 590, having been consecrated successor of Benedict I., without awaiting the sanction of the emperor, on 27th November of the former year. To make his apologies for this irregularity he sent deacon Gregory, who afterwards became Pope Gregory the Great, as his apocriarius to Constantinople. In 585 he sought to heal the schism which had subsisted since the time of Pelagius I. in connexion with the Three Chapters controversy by writing to the bishops of Istria with the exhortation to "avoid foolish and unlearned questions," but his efforts as a peacemaker were without success. In 588 John, patriarch of Constantinople, by reviving the

old and disputed claim to the title of œcumenic patriarch, elicited a vigorous protest from Pelagius, but the decretal which professes to convey the exact words of the document is now known to be false. He died in January 590, and was succeeded by Gregory I.

**PELARGONIUM.** See GERANIUM, vol. x. p. 439, and HORTICULTURE, vol. xii. pp. 263-4.

**PELASGI.** See GREECE, vol. xi. p. 90, and ITALY, vol. xiii. p. 444.

**PELEW, PELLEW, PALAU, or PALAO, ISLANDS,** a group in the western Pacific at the intersection of 134° 30' E. long. by 7°, 8°, and 9° N. lat., which, as it is often considered part of the Caroline Archipelago, has been described in the article CAROLINE ISLANDS, vol. v. pp. 125, 126. The name Ialas Palaos, by which the islands are first designated, is of doubtful but certainly not of native origin, and was originally applied by the Spaniards in an indefinite way to all the islands east of Mindanao (Philippines). The English form "Pelaw" may be a corruption either of Palao or of Peleliu (Pellelew), the proper name of one of the southern islands. According to Miklukho-Maklay (*Investiya of the Imp. Russian Geogr. Soc.*, 1878, pp. 287-297; cf. *Zeitschr. f. Ethnol.*, Berlin, 1878) the ordinary nomenclature on our maps is often erroneous, the correct forms being Babeltop, Kayangel (not Yanguel or Kiangle), N'yaur (not Angaur or Angour), Arkledeu (not Korph), Namalakai (not Amanakai), &c. The men vary in height from 5 feet to 5 feet 7 inches, the women from 4 feet 9 to 5 feet 2. The character of the hair differs greatly in different individuals; both sexes wear it wound up in a back-knot. Tattooing (but not of a very elaborate type) is in vogue, especially among the women, by whom the operation is always performed. The skull shows a strong tendency to brachycephalism. Adults of both sexes have their teeth carefully blackened by *teddalek* (a kind of earth). Sir John Lubbock (*The Origin of Civilisation*) places the Pelaw Islanders among the peoples destitute of religion; but Miklukho-Maklay found among them a well-developed Shamanism, every village having a *kalit*, or shaman, and the group containing five high kalits with an extensive jurisdiction. The ornithology of the Pelaw Islands has been investigated by Dr Otto Finsch (*Journal des Muséum Godeffroy*, 1875), who enumerates fifty-six species, of which twelve are peculiar to the group. The occurrence of *Gallus bankiva* and the Nicobar pigeon and the absence of parrots and finches are points of interest.

**PELHAM, SIR HENRY** (1696-1754), prime minister of England, was the younger brother of Thomas Holles Pelham, duke of Newcastle, and was born in 1696. He was educated by a private tutor and at Christ Church, Oxford, which he entered in July 1710. As a volunteer he served in Dormer's regiment at the battle of Preston in 1715; subsequently he spent some time on the Continent, and in 1718 entered parliament for Seaford, Sussex. Through strong family influence and the recommendation of Walpole he was chosen in 1721 a lord of the treasury. The following year he was returned for Sussex county. In 1724 he entered the cabinet as secretary of war, but this office he exchanged in 1730 for the more lucrative one of paymaster of the forces. He made himself conspicuous by his support of Walpole on the question of the excise, and during the subsequent attacks, which ultimately led to his resignation in 1742. In the following year a union of parties resulted in the formation of the administration of which Pelham was prime minister, with the additional office of chancellor of the exchequer. Being strongly in favour of peace, he carried on the war with languor and indifferent success, but the country, wearied of the interminable struggle, was disposed to acquiesce in his foreign policy almost without a murmur. The king, thwarted in his favourite schemes,

made overtures in 1746 to Lord Bath, but his purpose was upset by the sudden resignation of the Pelhams, who, however, at the king's request, immediately resumed office. His very defects were, in the peculiar condition of parties, among the chief elements of Pelham's success, for one with a strong personality, moderate self-respect, or high conceptions of statesmanship could not have restrained the discordant elements of the cabinet for any length of time. Moreover, he undoubtedly possessed the important requisites of considerable practical tact and a thorough acquaintance with the details of business and the forms of the House. Whatever quarrels or insubordination might exist within the cabinet, they never broke out into open revolt, and during his administration there was seemingly a complete lull in the strife of parties. Nor can a high degree of praise be denied to his financial policy, especially his plans for the reduction of the national debt and the simplification and consolidation of its different branches. He died 6th March 1754.

See Cox, *Memoirs of the Pelham Administration*, 2 vols., 1822.

**PELLIAS, PELLIADES.** Pelias, a celebrated character in Greek fable, was the son of Poseidon and Tyro, daughter of Salmoneus. Because Tyro afterwards married her father's brother Cretheus, king of Iolcus in Thessaly, to whom she bore Æson, Phereas, and Amythaon, Pelias was by some thought to be the son of Cretheus. He and his twin-brother Neleus were exposed by their mother, but were found and nurtured by a herdsman, who called one of them Pelias, because his face was discoloured by a blow from the hoof of a mare, and the other Neleus, because a bitch had out of pity suckled him. When grown to manhood they discovered their mother, and Pelias slew Sidero, Tyro's stepmother, on the altar of Hera, whither she had fled, because she had ill-used their mother. On the death of Cretheus Pelias made himself master of the kingdom of Iolcus. (According to others, after the death of his half-brother Æson, he ruled as regent for Æson's son Jason.) He had previously quarrelled with his brother Neleus, who went to Messenia, where he founded Pylus. Pelias married Anaxibia, daughter of Bias, or, according to others, Philomache, daughter of Amphion, and became the father of a son, Acastus, and of daughters, Piriadice, Pelopes, Hippothoe, and Alcestis; to these daughters (called Peliades after their father) others add Amphinome, Evadne, Asteropsea, and Antinoe. In order to rid himself of Jason Pelias sent him to Colchis in quest of the golden fleece, and he availed himself of the absence of the son in order to put to death his father Æson together with his mother and brother. When Jason returned with the golden fleece he cast about how he should avenge the death of his parents. In this he was helped by Medea, who persuaded the Peliades to cut in pieces and boil their father Pelias, assuring them that he would thus be restored to youth. Acastus drove out Medea and celebrated far-famed funeral games in honour of his father. The Peliades fled to Mantinea in Arcadia, where their graves were shown in the time of Pausanias.

The tragic death of Pelias was the subject of Sophocles's drama *Rhesotomoi* (Root-cutters), and in the *Tyro* he treated another portion of the legend. *Peliades* was the name of Euripides's first play.

**PELLICAN** (Fr. *Pelican*, Lat. *Pelecanus* or *Pelicanus*), a large fish-eating water-fowl, remarkable for the enormous pouch formed by the extensible skin between the lower jaws of its long, and apparently formidable but in reality very weak, bill. The ordinary Pelican, the *Oncrotalus* of the ancients, to whom it was well known, and the *Pelecanus oncotatus* of ornithologists, is a very abundant bird in some districts of South-eastern Europe, South-western Asia, and North-eastern Africa, occasionally straying, it is

believed, into the northern parts of Germany and France; but the possibility of such wanderers having escaped from confinement is always to be regarded,<sup>1</sup> since few zoological gardens are without examples which are often in the finest condition. Its usual haunts are the shallow margins of the larger lakes and rivers, where fishes are plentiful, since it requires for its sustenance a vast supply of them, pursuing them under water, and rising to the surface to swallow those that it has captured in its capacious pouch. The nest is formed among the reeds that border the waters it frequents, placed on the ground and lined with grass. Therein two eggs, with white, chalky shells, are commonly laid. The young during the first twelvemonth are of a greyish-brown, but this dress is slowly superseded by the growth of white feathers, until when mature almost the whole plumage, except the black primaries, is white, deeply suffused by a rich blush of rose or salmon-colour, passing into yellow on the crest and lower part of the neck in front. A second and somewhat larger species, *Pelecanus crispus*, also inhabits Europe, but in smaller numbers. This, when adult, is readily distinguishable from the ordinary bird by the absence of the blush from its plumage, and by the curled feathers that project from and overhang each side of the head, which with some differences of coloration of the bill, pouch, bare skin round the eyes, and irides give it a wholly distinct expression.<sup>2</sup> Two specimens of the humerus of as many Pelicans have been found in the English fens (*Ibis*, 1868, p. 363; *Proc. Zool. Society*, 1871, p. 702), thus proving the former existence of the bird in England at no very distant period, and one of them being that of a young example points to its having been bred in this country. It is possible from their large size that they belonged to *P. crispus*. Ornithologists have been much divided in opinion as to the number of living species of the genus *Pelecanus* (cf. *op. cit.*, 1868, p. 264; 1869, p. 571; 1871, p. 631)—the estimate varying from six to ten or eleven; but the former is the number recognized by the latest author on the subject, M. Dubois (*Bull. Mus. de Belgique*, 1883). North America has one, *P. erythrorhynchus*, very similar to *P. onocrotalus* both in appearance and habits, but remarkable for a triangular, compressed, horny excrescence which is developed on the ridge of the male's bill in the breeding season, and, as ascertained by Mr Ridgway (*Ibis*, 1869, p. 350), falls off without leaving trace of its existence when that is over. Australia has *P. conspicillatus*, easily distinguished by its black tail and wing-coverts. Of more marine habit are *P. philippensis* and *P. fuscus*, the former having a wide range in Southern Asia, and, it is said, reaching Madagascar, and the latter common on the coasts of the warmer parts of both North and South America.

The genus *Pelecanus* as instituted by Linnæus included the CORMORANT (vol. vi. p. 407) and GANNET (vol. x. p. 70) as well as the true Pelicans, and for a long while these and some other distinct groups, as the SNAKE-BIRDS (*q.v.*), FRIGATE-BIRDS (vol. ix. p. 786), and TROPIC-BIRDS (*q.v.*), which have all the four toes of the foot connected by a web, were regarded as forming a single Family, *Pelecanidae*; but this name has now been restricted to the Pelicans only, though all are still usually associated under the name *Steganopodes* (ORNITHOLOGY, p. 46). It may be necessary to state that there is no foundation for the venerable legend of the Pelican feeding her young with blood from

her own breast, which has given it an important place in ecclesiastical heraldry, except that, as Mr Bartlett has suggested (*Proc. Zool. Society*, 1869, p. 146), the curious bloody secretion ejected from the mouth of the Flamingo may have given rise to the belief, through that bird having been mistaken for the "Pelican of the wilderness." (A. N.)

PELIGNI. See ITALY, vol. xiii. p. 444.

PÉLISSIER, JEAN JACQUES AMABLE (1794-1864), duke of Malakhoff, marshal of France, was born 6th November 1794 at Maromme (Seine Inférieure), where his father was employed in a powder-magazine. After attending the military college of La Flèche and the special school of St Cyr, he in 1815 entered the army as sub-lieutenant in an artillery regiment. A brilliant examination in 1819 secured his promotion to the staff. He served as aide-de-camp in the Spanish campaign of 1823, and in the expedition to the Morea in 1828-29, at the conclusion of which he received the grand cross. In 1830 he took part in an expedition to Algeria, and on his return was promoted to the rank of major. Nine years later he was again sent to Algeria as chief of the staff with the rank of lieutenant-colonel, and remained there in active service till the Crimean war, taking a prominent part in many important operations, and, by gradual promotion, advancing to the rank of general of division. The merciless severity of his conduct in suffocating a whole Arab tribe in a cavern, where they had taken refuge and refused to surrender, awakened in 1846 such a strong feeling of indignation in Europe that Marshal Soult, the French minister of war, expressed in the chambers his regret at its occurrence; but Marshal Bugeaud, the governor-general of Algeria, not only gave it his approval but shortly afterwards secured for Péliissier further promotion. On the declaration of war with Russia Péliissier was sent to the Crimea, where on 16th May 1855 he succeeded Marshal Canrobert as commander-in-chief of the French forces before Sebastopol. After the capture of the fortress he was, on the 12th September, promoted to be marshal. On his return to Paris he was named senator, created duke of Malakhoff (22d July 1856), and rewarded with a grant of 100,000 francs per annum. From March 1858 to May 1859 he acted as French ambassador in London, whence he was recalled to take command of the army of observation on the Rhine. In 1860 he was appointed governor-general of Algeria; and he died there 22d May 1864.

See ALGERIA (vol. i. pp. 568, 569); Marband, *Le Maréchal Pélissier*, 1863; Castilla, *Fortraits Historiques*, 2d series, 1859.

PELL, JOHN (1610-1685), mathematician, was born on 1st March 1610 at Southwick in Sussex, where his father was minister. He was educated at the free school of Steyning, and entered Trinity College, Cambridge, at the age of thirteen. During his university career he made himself an accomplished linguist, and even before he took his M.A. degree (in 1630) he was engaged in learned correspondence with Briggs and other mathematicians. His great reputation and the influence of Sir William Boswell, the English resident, with the States-General procured his election in 1643 to the chair of mathematics in Amsterdam, whence he removed in 1646, on the invitation of the prince of Orange, to Breda, where he remained till 1652.

From 1654 to 1658 Pell acted as Cromwell's political agent to the Protestant cantons of Switzerland. On his return to England he took orders and was appointed by Charles II. to the rectory of Fobbing in Essex, and in 1673 he was presented by Bishop Sheldon to the rectory of Laindon in the same county. His devotion to mathematical science seems to have interfered alike with his advancement in the church and with the proper management of his private affairs. Cheated, it is said, by his tenants and relations, he was reduced to the utmost

<sup>1</sup> This caution was not neglected by the prudent, even so long ago as Sir Thomas Browne's days; for he, recording the occurrence of a Pelican in Norfolk, was careful to notice that about the same time one of the Pelicans kept by the king (Charles II.) in St James's Park had been lost.

<sup>2</sup> It is also said to have twenty-two rectrices, while the ordinary species has only eighteen.

poverty. For a time he was confined as a debtor in the King's Bench prison. He lived, on the invitation of Dr Whistler, for a short time in 1682 at the College of Physicians, but died 12th December 1685 at the house of Mr Cothorne, reader of the church of St Giles in the Fields. He was buried at the expense of the rector of this church and of Dr Busby, the master of Westminster School. Many of Pell's manuscripts fell into the hands of Dr Busby, and afterwards came into the possession of the Royal Society; they are still preserved in something like forty folio volumes, which contain, not only Pell's own memoirs, but much of his correspondence with the mathematicians of his time.

The Diophantine analysis was a favourite subject with Pell; he lectured on it at Amsterdam; and he is now best remembered for his solution of the indeterminate equation,  $x^2 - y^2 = 1$ , which is now known by his name, and which had been proposed by Fermat as a challenge to the English mathematicians. His chief works are *Astronomical History of Observations of Heavenly Motions and Appearances*, 1634; *Ecliptica Prognostica*, 1634; *Controversy with Longomontanus concerning the Quadrature of the Circle*, 1646 (f); *An Idea of the Mathematica*, 1660; *Branker's Translation of Rhombus's Algebra, much altered and augmented*, 4to, 1668; *A Table of Ten Thousand Square Numbers*, fol., 1672.

PELLA. See MACEDONIA, vol. xv. p. 137.

PELLAGRA (Ital. *pelle agra*, smarting skin) is the name given, from one of its early symptoms, to a peculiar disease, of comparatively modern origin, occurring among the peasantry in Lombardy and other provinces of northern Italy, and in the Asturias (*mal de la rosa*), Gascony, Roumania, and Corfu. It is a progressive disease of nutrition tending towards profound paralytic and mental disorders, and is associated to a very significant extent, if not even invariably, with a staple diet of damaged maize along with other peculiarly wretched and hopeless conditions of living. Although Lombardy is the garden of Italy, its peasantry are over-worked, under-paid, and under-fed; instead of a diet suited to their severe labour, their sustenance consists largely of the more worthless kinds of Indian corn of their own growing, the produce of poorly-cultivated ground, sown late, harvested before maturity, and stored carelessly in its wet state; even if they grow a certain proportion of good maize-corn the millers, to whom they are often in debt, are more likely to grind the worst samples for the peasants' own use. The flour is either made into a kind of porridge—the "polenta" of Italy, the "cruchade" of Gascony, or the "mamaliga" of Roumania—or it is made into loaves, without yeast, baked hastily on the surface only or on one side, and raw and wet within, large enough to last a week, and apt to turn sour and mouldy before the week is out.<sup>1</sup>

That pellagra is not a *morbus miseris* pure and simple, wanting some more specific cause, will be at once apparent when we consider that the misery of living is as old as the human race, whereas pellagra is a disease of the last hundred years or so, and that in Ireland, Russia, Upper Silesia, Galicia, or other headquarters of the *morbi miseris*,

<sup>1</sup> Of the peasantry of the Asturias, Townsend, a traveller of the last century, says:

"They eat little flesh, they drink little wine; their usual diet is Indian corn, with chestnuts, apples, pears, melons, and cucumbers; and even their bread, made of Indian corn, has neither barn nor leaven, but is unfermented, and in the state of dough; their drink is water" (ll. 14).

The following is the most recent account (by Dr Petit) of the condition of the peasantry in the pellagrous district of the Gironde:

"The cultivation of this district consists of millet, &c., a small quantity of maize, and a few vineyards. The soil does not suffice for the nourishment of the miserable population who cultivate it. They are slovenly, and sleep in their clothes; their labour is in general of the severest kind, and they are very ill fed. Their food is mostly a porridge of millet; maize is rarely part of their diet [elsewhere he says, "in all these provinces the flour of maize enters largely into the food of the people"], which includes a little rye-bread, sour most of the time, a few sardines, and rancid lard. Meat is almost excluded from their food; sometimes on five-days one may see a quarter of mutton or veal at the table. Their usual drink is water and mostly bad water; wine is not drunk except in well-to-do families. Their dwellings are deplorable; they are low-roofed and damp, built of wattle, and constantly enveloped in reek. It often happens that man and beast live together. Pellagra rages as an endemic among these populations."

pellagra is unknown. The special factor is undoubtedly maize as an article of diet or as the staple diet; but it is, on the other hand, perfectly clear that there is nothing in a maize diet itself to induce pellagra. Compared with the enormous extent of the maize-zone both in the western and eastern hemispheres, the pellagra-area is a mere spot on the map; excluding Corfu, it lies between the parallels of 46° and 42° N.; and the exception of Corfu is a significant one. It is only since 1856 that pellagra has become endemic in that island. Maize has always thriven well there; but wine-growing has displaced it to a great extent, and the maize, which is still largely in request with the peasantry, is now mostly imported; it is in fact chiefly Roumanian maize of an inferior kind, and all the more deteriorated owing to its long water-transit by way of the Danube and Black Sea. Again, in the Danubian provinces themselves the peasantry of Transylvania, who are by no means well off, are free from pellagra, notwithstanding their addiction to polenta, having long ago learned the art of husbandry from the Saxon part of the population; they allow the maize to ripen to the utmost, and then let it dry on the ground and afterwards in barns, whereas the Wallack peasantry of Roumania, who are subject to pellagra, gather the corn before it is ripe, and shoot it into pits where it becomes musty. In other countries where the conditions of climate and soil are somewhat trying for maize, as in Burgundy, Franche Comté, and the Bresse in France, and in Mexico, the greatest care is taken to dry the Indian corn before it is stored; and it may be said that wherever these precautions are taken pellagra does not follow. It has happened on several occasions, after a particularly bad maize-harvest, that pellagra has risen almost to an epidemic. Again, its prevalence within its actual endemic area varies much from province to province or from commune to commune, being always last where the maize-diet is supplemented by wheat flour, rice, beans, chestnuts, potatoes, or fish.

*Characters of the Disease.*—The indications of pellagra usually begin in the spring of the year, declining towards autumn, and recurring with increasing intensity and permanence in the spring seasons following. A peasant who is acquiring the malady feels unfit for work, suffers from headaches, giddiness, ringing in the ears, a burning of the skin, especially in the hands and feet, and diarrhoea. At the same time a red rash appears on the skin, of the nature of erysipelas, the red or livid spots being tense and painful, especially where they are directly exposed to the sun. About July or August of the first season these symptoms disappear, the spots on the skin remaining rough and dry. The spring attack of the year following will probably be more severe and more likely to leave traces behind it; with each successive year the patient becomes more like a mummy, his skin shrivelled and sallow, or even black at certain spots, as in Addison's disease, his angles protruding, his muscles wasted, his movements slow and languid, and his sensibility diminished. Meanwhile there are more special symptoms relating to the nervous system, including drooping of the eyelid, dilatation of the pupil, and other disorders of vision, together with symptoms relating to the digestive system, such as a red and dry tongue, a burning feeling in the mouth, pain on swallowing, and diarrhoea. Peasants with this progressive malady upon them come to the towns spring after spring seeking relief at the various hospitals, and under a good regimen and a permanently improved diet the malady is often checked. But after a certain stage the disease is confirmed in a profound disorganization of the nervous system; spasms of the limbs begin to occur, and contractures of the joints from partial paralysis of the extensor muscles and preponderant action of the flexors; melancholy, imbecility,

and a strong suicidal tendency are common accompaniments. A large number of pellagrous peasants end their days in lunatic asylums in a state of drivelling wretchedness or raving madness; many more drag out a miserable existence in the communes where their working years had been spent, sometimes receiving the communal relief to which the law entitles them; while the cases that are reckoned curable are in Italy received into the various endowed hospitals, of which there are a large number. Cases that are rapidly fatal end in delirium or a state of typhoid stupor; the more protracted cases are cut off at last by rapid wasting, colliquative and ill-smelling sweats, profuse diarrhoea, and dropsy. After death a variety of textural changes are found, which may be referred in general to trophic disorders, or disorders of tissue-nutrition; in a considerable number the kidneys are in the contracted state corresponding to the clinical condition of Bright's disease without albuminuria; another condition often remarked is thinning of the muscular coats of the intestine; deposits of pigment in the internal organs are also characteristic, just as the discoloration of the skin is during life.

*Treatment.*—There is hardly any doubt as to the remedy for pellagra, just as there is hardly any doubt as to its cause. The question is mainly one of the social condition of the peasantry, of their food and wages; it is partly, also, a question of growing Indian corn on a soil or in a climate where it will not mature unless with high farming. There is nothing in the resources of medicine proper to cure this disease; as the cause is, so must the remedy be.

*Affalies of Pellagra.*—The disease has the general characters of a tropho-neurosis. The early involvement of certain areas of the skin, especially in exposed places such as the hands and feet, suggests leprosy; as in that disease, there is first hyperaesthesia and then loss of sensibility, sometimes a thickening of the surface and discolorations; and, although in pellagra the onset each successive spring and the subsidence towards autumn are distinctive, yet in leprosy also the cutaneous disorder is apt to come and go at first, reappearing at the same spots and gradually becoming fixed. The grand difference in leprosy, at least in the nodular variety of it, is that a new growth of a granulomatous kind arises at these spots in the skin and around the nerves. The occasional deep discoloration of the pellagrous skin in certain spots has suggested a resemblance to Addison's disease of the suprarenals, and has even made the diagnosis difficult. But after the cutaneous disorders the course of pellagra is something *sui generis*; the melancholy, imbecility, or mania, as well as the mummified state of the body, are peculiar to it. With ergotism the points of resemblance are more perhaps in the causation than in the nosological characters; both diseases are specifically due to damaged grain, ergotism being caused by the presence of an actual bulky parasitic mould on rye, whereas pellagra is more probably caused by fermentation and decomposition within the proper substance of the maize-corn. As regards heredity, it is much less marked in pellagra than in leprosy, but there are good grounds for believing that the disease is in fact inherited sometimes by the offspring; infants at the breast may show the symptoms of it, but that fact is not in itself conclusive for heredity, for the reason that infants at the breast are partly fed on the household polenta. As regards contagiousness, there is no more proof of it in pellagra than there is in leprosy.

*Geographical Distribution and History.*—Pellagra is peculiarly a disease of the peasantry, being hardly ever seen in residents of the towns. In Italy the number of peasants affected by it was estimated in 1879 at 100,000, the distribution being as follows:—Lombardy, 40,838; Venetia, 29,386; Piedmont, 1692; Liguria, 148; Emilia, 18,728; Tuscany, 4382; the Marches and Umbria, 2155; Rome, 76. In Lombardy the worst centres are in the provinces of Brescia, Pavia, Piacenza, and Ferrara. In Italy the disease has increased very considerably within the last thirty years; thus, in the province of Vicenza the number of persons known to be pellagrous in 1853-55 was 1380, in 1860 it was 2974, and in 1879 it had risen to 3400. There are no accurate returns from the Asturias and other affected provinces of Spain, but the maledy there is said to have declined very materially of late. In Gascony, where it did not begin until about fifty years ago, it is somewhat common, more in the Landes than in the Gironde; in one district of the latter Petit estimates that there are 200 cases in a population of 6000. In Roumania the total number is given at 4500, Moldavia having a larger share than Wallachia. In Corfu it exists in 27 out of the

117 communes, the proportion of cases for the whole island being 8·2 per 1000 inhabitants.

Maize was grown in Europe for many years before pellagra showed itself (see MAIZE); but the outbreak of the disease corresponds on the whole closely in time (particularly in Gascony and Roumania) with the introduction of an inferior kind of maize as the staple food of the peasantry. The first accounts of pellagra come from Spain. Casal in 1762 described the disease in the Asturias under the name of *mal de la roca*; it is said to have been noticed first in 1785 around Oviedo, being then confined within very narrow limits. The Asturias are still its headquarters in Spain, but it is prevalent also in Burgos, Navarra, Zaragoza, Lower Aragon, Guadalajara, and Cuenca, and it is met with in other provinces as well. In Italy it was first reported from the vicinity of Lago Maggiore, and a few years later (in 1750) it broke out simultaneously in the districts of Milan, Brescia, Bergamo, and Lodi, extending afterwards to Como, Cremona, Mantua, and Pavia, and to the whole of Lombardy before the end of the century. It became endemic also in Venetia on the one side and in Piedmont on the other, almost contemporaneously with this. Within the present century it has extended its area southwards into Emilia and into Tuscany, while it has become more prevalent in its earlier seats at the same time. There is very little of it in central Italy, while southern Italy with Sicily, is absolutely exempt, notwithstanding the common use of Indian corn in the form of bread and macaroni. The first authentic information of its existence in Gascony came from near Arcahon in 1818, after which it spread along the coast of the Gironde and the Landes. It has extended subsequently along the left bank of the Garonne and towards the Pyrenees; but around Dax it is said to have decreased considerably of late. In Roumania, where the medical profession is unanimous in tracing it to the use of damaged maize, it dates from about 1833-46. It is only since 1856 that it has become endemic in Corfu, under the circumstances already mentioned.

*Literature.*—*La Pellagra in Italia*, Rome, 1850 (official report, with appendices relating to France, Spain, and Roumania, and a copious bibliography extending to fifteen pages). An article on "The Pellagra in Italy" in the *Brit. Rev.* for April 1881, is based on this report. The authority for Corfu is T. Valdes. The best inquiries on the toxic properties of damaged maize are those of Lombroso. See also Hirsch, *Historisch-geographische Pathologie*, vol. ii., 2d ed., Stuttgart, 1853 (Engl. trans.) (G. C.)

PELLICANUS, CONRAD (1478-1556), one of the most interesting minor figures in German theology and scholarship in the great age of the Reformation, was born at Ruffach in Alsace in the winter of 1478. His paternal name was Kürsner, his father's father having been a carrier of Wyl in the Black Forest. The Latin name of Pellicanus was chosen for him by his mother's brother Jodocus Gallus, an ecclesiastic connected with the university of Heidelberg, who gave his nephew sixteen months at the university at the cost of some fourteen florins in 1491-92. Pellicanus's parents were worthy people, but very poor; the boy was eager for learning, but had no books; at school at Ruffach, where he had learned well, "with much fear and many a scourging," it was only the richer boys who had a copy of the Ulm Donatus of 1485. So when his uncle tired of him and he came back to Ruffach, with some knowledge of the great Latin classics as well as of the usual bachelor's course, he was glad to teach gratis in the Minorite convent school that he might borrow books from the library, and in his sixteenth year he resolved to become a friar. This step helped his studies, for he was sent to Tübingen in 1496 and became a favourite pupil of the guardian of the Minorite convent there, Paulus Scriptoris, a man of considerable general learning and of much boldness and honesty, who anticipated Luther in his open preaching on such topics as vows, indulgences, and the sacraments. There seems to have been at that time in south-west Germany a considerable amount of sturdy independent thought among the Franciscans, and more genuine conformity to the original ideas of the order than is often supposed; Pellicanus himself became a Protestant very gradually, and without any such revulsion of feeling as marked Luther's conversion; at the moment when he went to Zurich and threw off the cowl he was pleased to think that the good St Francis would not abhor him for his change of dress, and for learning for the first time at the age of forty-eight the difference between crowns, florins, and batzen. At Tübingen the future "apostate in three

languages" was able to begin the study of Hebrew. He had no teacher and no grammar; but Paulus Scriptoris carried him a huge codex of the prophets on his own shoulders all the way from Mainz. He learned the letters from the transcription of a few verses in the *Star of the Messiah* of Petrus Niger, and, with a subsequent hint or two from Reuchlin, who also lent him the grammar of Moses Kimhi, made his way through the Bible for himself with the help of Jerome's Latin. He got on so well that he was not only a useful helper to Reuchlin but anticipated the manuals of the great Hebraist by composing in 1501 the first Hebrew grammar in a European tongue. It was printed in 1503, and afterwards included in Reysch's *Margaritha Philosophica*. Hebrew remained a favourite study to the last. Pellican's autobiography is full of interesting details as to the gradual multiplication of accessible books on the subject, which he hunted up in every journey; and ultimately he not only studied but translated a vast mass of rabbinical and Talmudic texts. With a cooler judgment than Reuchlin, however, he was not deceived as to the true value of the later Hebrew wisdom, and his interest in Jewish literature was mainly philological. In linguistic knowledge he reached a high standard for that time,—certainly higher than that of his better-known pupil, S. Münster. The chief fruit of these studies is the vast Biblical commentary published at Zurich in his later years (1532-39, 7 vols.), which shows a remarkably sound judgment on questions of the text, and a sense for historical as opposed to typological exegesis, such as soon disappeared from the Protestant Church and was hardly equalled by any in his own day. Pellicanus became priest in 1501 and continued to serve his order at Ruffach, Pforzheim, and Basel till 1526. At Basel he did much laborious work for Froben's editions, and acquired a thorough knowledge of the early fathers, through which his dissatisfaction with current dogma gradually ripened into conviction that the church taught many doctrines of which the early doctors of Christendom knew nothing. He spoke his views frankly, but he disliked polemic, and was happy in his convent or in long journeys in the service of his order, which carried him over all south Germany and through Italy as far as Rome; he found also more toleration than might have been expected, even after he became active in circulating Luther's books. Thus, supported by the civic authorities, he remained guardian of the convent of his order at Basel from 1519 till 1524, and, even when he had to give up this post, remained in the monastery for two years, professing theology in the university and always toiling with indefatigable zeal. At length, when the position was becoming quite untenable, he received through Zwingli a call to Zurich as professor of Hebrew, and, formally throwing off his monk's habit, entered on a new life. Here he remained till his death in 1556, falling into his new surroundings with the ease of a simple affectionate nature, happy in the friendship of Zwingli and Bullinger, hospitably entertaining the many learned strangers who visited Zurich or the poor students who crowded to its school, avoiding religious controversy, and always deep in his books. The step in life which cost him most thought was his marriage, but this also proved so happy an experiment that he lived to be married a second time. In his later years he was afflicted with the stone, the torture of so many of the older scholars, but he continued active till the last.

Pellican's scholarship, though not brilliant, was really extensive; his sound sense and his singularly pure and devoted character gave him a great influence, as is apparent even in the too modest autobiography which he wrote for his son. He was curiously free from the pedantry of the time for a man who had lived so much among books; his views about the use of the German vernacular as a vehicle of culture (*Chron.*, 185, 86) are a striking proof of this.

As a theologian his natural affinities were with Zwingli, with whom in his smaller sphere he shared the advantage of having grown up to the views of the Reformation, without any sudden and violent mental struggle, by the natural progress of his studies and religious life. Thus he never lost his sympathy with humanism and with its great German representative, Erasmus. The Reformed Church might have had a happier course if it had longer kept to the lines of the first Zurich doctors. Pellican's Latin autobiography (*Chronicon C. P. R.*) is one of the most interesting documents of the period. It was first published by Riggenbach in 1877, and in this volume the other sources for his life are registered.

PELLICO, SILVIO (1788-1854), Italian dramatist, was born at Saluzzo in Piedmont on 24th June 1788, the earlier portion of his life being passed at Pinerolo and Turin under the tuition of a priest named Manavella. A taste for the drama, fostered by private theatrical recitals, showed itself at the age of ten in the composition of a tragedy under the inspiration of Casarotti's translation of the Ossianic poems. On the marriage of his twin sister Bosina with a maternal cousin at Lyons he went to reside in that city, devoting himself during four years to the study of French literature. His patriotism having been re-awakened by the reading of Foscolo's *Dei Sepolcri*, he returned in 1810 to Milan, where he became professor of French in the Collegio degli Orfani Militari. The appearance of Carlotta Marchionni on the Milan stage induced him to compose for her the tragedy *Francesca da Rimini*, which, despite the adverse criticism of Foscolo, was brought out with success on the return of the actress to the city a few years later. Its publication was followed by that of the tragedy *Eufemio da Messina*, but the representation of the latter was forbidden. Pellico had in the meantime continued his work as tutor, first to the unfortunate son of Count Briche, and then to the two sons of Count Porro Lambertenghi. In this capacity he was brought into contact with many of the foremost men of the day and threw himself heartily into an attempt to weaken the hold of the Austrian despotism by indirect educational means. Of the powerful literary executive which gathered about Counts Porro and Confalonieri, Pellico was the able secretary,—the management of the *Conciliatore*, which appeared in 1818 as the organ of the association, resting largely upon him. But the paper, under the relentless censorship of the Austrian officials, ran for a single year only, and the society itself was broken up by the more vigorous action of the Government consequent upon the formation of the constitution of Naples. In October 1820 Pellico was arrested on the charge of carbonarism and conveyed to the Santa Margherita prison. Occupied at first in preparing his defence and in religious meditation, he found means, after his removal to the Piombi at Venice in February 1821, to resume literary work, composing there several *Cantiche* and the tragedies *Ester d'Engaddi* and *Iginia d'Asi*. The sentence of death pronounced on him in February 1822 was finally commuted to fifteen years *carcere duro*, and in the following April he was placed in the Spielberg at Brünn. His chief work during this part of his imprisonment was the tragedy *Leoniero da Dertona*, for the preservation of which he was compelled to rely on his memory. After his release in 1830 he commenced the publication of his prison compositions, of which the *Ester* was played at Turin in 1831, but immediately suppressed. In 1832 appeared his *Gimonda da Mendrisio*, *Erodiade*, and the *Leoniero*, under the title of *Tre nuovi Tragedie*, and in the same year the work which gave him his European fame, *Le Mie Prigioni*. The last gained him the friendship of the Marchesa di Barolo, the reformer of the Turin prisons, and in 1834 he accepted from her a yearly pension of 1200 francs. His tragedy *Tommaso Moro* had been published in 1833, his most important subsequent publication being the *Opere Inedite* in 1837. On the decease of his parents in 1838 he was received into the Casa Barolo, where he



remained till his death, assisting the marchesa in her charities, and writing chiefly upon religious themes. Of these works the best known is the *Dei Doveri degli Uomini*, a series of trite maxims which do honour to his piety rather than to his critical judgment. A fragmentary biography of the marchesa by Pellico was published in Italian and English after her death. He died 31st January 1854, and was buried in the Campo Santo at Turin. His writings, whether in prose or verse, are chaste and graceful, but defective in virility and breadth of thought, and his tragedies display neither the insight into character nor the constructive power of a great dramatist. It is in the simple narrative and naive egotism of *Le Miei Prigioni* that he has established his strongest claim to remembrance, winning fame by his misfortunes rather than by his genius.

Cf. Piero Maroncelli, *Addizionale alle Miei Prigioni*, Paris, 1834; the biographies by Latour; Gabriels Rosselli; Didier, *Revue des Deux Mondes*, September, 1842; De Loménie, *Galerie des Contemp. Illustr.*, iv., 1842; Ohiala, Turin, 1852; Nolle-Fabert, 1854; Giorgio Briano, 1854; Bourdon, 1868; and the life of the Marchesa di Berolo.

PELOPIDAS, a distinguished Greek general, who, in conjunction with Epaminondas, raised his native city Thebes to a pitch of power such as she never attained to before or afterwards. He was the son of Hippoclus and member of an illustrious Theban family. The large property to which he succeeded in his youth, and which he seems to have increased by a brilliant marriage, was liberally employed by him in the relief of the destitute. When he could not persuade his friend Epaminondas to share his wealth, he imitated that great man in the stern simplicity and frugality of his life and in his cheerful endurance of hardships. Though his taste for hunting and gymnastics, and his fiery temper, contrasted with the studious habits and the "gentle and majestic patience" of his friend, no one appreciated better than Pelopidas the greatness of Epaminondas, to whom, if inferior as a general and a statesman, he was equal in romantic courage and unselfish devotion to his fatherland. Their friendship continued unbroken till death. It was cemented by a battle in which Epaminondas saved the life of Pelopidas. When the Spartans under Phœbidas seized the Cadmea or citadel of Thebes (summer of 383 or 382 a.c.), Pelopidas, as a member of the democratic club which was opposed to the Spartans, was forced to flee. Along with other exiles he found a refuge at Athens. Epaminondas, protected from suspicion by his poverty and his studies, was suffered to remain in Thebes. Though a very young man, Pelopidas took a leading part in persuading his fellow-exiles to strike a blow for the liberation of Thebes. Having concerted a plan with their friends in Thebes, Pelopidas, with a few companions, entered the city in disguise, surprised and slew the magistrates favourable to Sparta, and roused the people to attack the Spartan garrison in the citadel. But the Spartans capitulated and marched out. This happened in the early winter of 379. Pelopidas and two others of the liberators were elected "boeotarchs," or chief magistrates of Bœotia, an office which had been in abeyance for some years. Henceforward to the end of his life Pelopidas was annually elected to one of the chief offices of the state. The treacherous attempt made soon afterwards by the Spartan Sphodrias to seize the Piræus was said, with little probability, to have been instigated by Pelopidas in order to embroil Sparta with Athens. The liberation of Thebes was followed by some years of desultory warfare with Sparta. At Tanagra, however, Pelopidas defeated the enemy and slew the Spartan governor. Still more brilliant was the victory gained by him at Tegyra over a numerically superior force of two Spartan divisions. His success was due chiefly to the disciplined valour of the

Sacred Band, a picked regiment of 300 men, whom Pelopidas led to glory on many a bloody field. The battle of Tegyra, as the first occasion on which the Spartans had ever been worsted by an inferior force, made a deep impression on Greece. At the great battle of Leuctra (July 371), which permanently crippled the power of Sparta, Pelopidas and the Sacred Band were again conspicuous. Pelopidas was one of the generals in command of the Theban army which invaded the Peloponnesus in 370-369, and he joined with Epaminondas in persuading their colleagues to prosecute the campaign even after the expiry of their year of office. For this the two friends were tried for their life, but acquitted. Soon afterwards (apparently in 369), in response to a petition of the Thessalians, Pelopidas was despatched with an army to Thessaly against Alexander, tyrant of Phœræ. After occupying Larissa and freeing the Thessalians from the oppression of the tyrant, Pelopidas marched into Macedonia, where, at the request of the belligerents, he acted as arbitrator between Alexander king of Macedonia and the pretender Ptolemæus. Having concluded an alliance with the Macedonian king, he brought back to Thebes, amongst other hostages, the youthful Philip, brother of the king and afterwards father of Alexander the Great. In the following year (368), Pelopidas returned to Thessaly as ambassador and without an army. Learning that Ptolemæus had killed Alexander of Macedonia and seized the throne, he collected a body of mercenaries and marched against him. Ptolemæus induced the troops of Pelopidas to desert their leader, but he was too prudent to press his advantage, and agreed to act as regent for the brothers of the late king and to be an ally of Thebes. On his return from Macedonia Pelopidas was seized and detained by Alexander of Phœræ. From this captivity, in which his scornful bearing excited the wonder of his captor, he was released by a Theban force under Epaminondas. By the exertions of Epaminondas and Pelopidas, Thebes had by this time become the most powerful state in Greece; and that she might be formally recognized as such Pelopidas was sent as ambassador (367) to the Persian court. Favourably impressed by the renown and still more by the personal character of the envoy, the Persian king, Artaxerxes, loaded him with marks of honour and ratified all his proposals. These were, that Messene should be independent, that Athens should lay up her warships, and that any city which declined to follow the leadership of Thebes should be treated as an enemy by Persia. The purpose of the treaty, to strengthen Thebes by weakening Athens and Sparta, was obvious. It found no favour with the Greek states and remained a dead letter. In 364 the Thessalian towns once more appealed to Pelopidas for help against their old enemy Alexander of Phœræ. Disregarding an ominous eclipse of the sun, Pelopidas pushed on with a handful of troops, leaving the main body to follow. At the heights of Cynoscephalæ, near Pharsalus, he came up with the tyrant Alexander at the head of a much superior force. The valour of Pelopidas secured another victory, but it was his last,—catching sight of his hated foe, he rushed on him single-handed and fell covered with wounds. The Thessalians, in whose cause he died, requested and received the honour of carrying the hero to his last home, and the crowns, trophies, and golden arms by which the coffin was surrounded bore witness to the love and sorrow of a whole people. His friend did not long survive him. He too was to die fighting his country's battles in a foreign land. The pre-eminence of Thebes was the work of these two men alone, and with them it passed away.

Our chief authority is Plutarch's *Life of Pelopidas*. Xenophon was a contemporary, and his history covers the whole period of the life of Pelopidas, but, with his usual malignity to the enemies of

Sparta, he only mentions Pelopidas in connexion with his fruitless embassy to Persia. There is a meagre life by Cornelius Nepos. See also Diod. Sic., xv. 62, 67, 71, 75, 80, 81.

#### PELOPONNESUS. See GREECE.

**PELOPS**, a hero of Greek mythology, was the grandson of Zeus, son of Tantalus and Dione, and brother of Niobe. His father's home was on Mount Sipylus in Asia Minor, whence Pelops is spoken of as a Lydian or a Phrygian, or even as a Paphlagonian. Tantalus was a friend and companion of the gods, and one day he served up to them his own son boiled and cut in pieces. The gods detected the crime, and none of them would partake except Demeter (according to others Thetis), who, distracted by the loss of her daughter Persephone, ate of the shoulder. The gods restored Pelops to life, and the shoulder consumed by Demeter was replaced by one of ivory. Wherefore the descendants of Pelops had a white mark on their shoulder ever after. This tale is perhaps a reminiscence of human sacrifice, of which numerous traces remain in Greek legend and history. Poseidon admired Pelops, the beautiful boy, and carried him off to Olympus, where he dwelt with the gods, till, for his father's sins, he was cast out from heaven. Then, taking much wealth with him, he crossed over from Asia to Greece. He went to Pisa in Elis as suitor of Hippodamia, daughter of King Enomau, who had already vanquished in the chariot-race and slain many suitors for his daughter's hand. But by the help of Poseidon, who lent him winged steeds, or of Enomau's charioteer Myrtilus, whom he or Hippodamia bribed, Pelops was victorious in the race, wedded Hippodamia, and became king of Pisa. Pelops's race for his wife was a favourite subject of Greek poetry and art. It may be a confused recollection of the custom of wife-matching prevalent in early times. When Myrtilus claimed his promised reward, Pelops flung him into the sea near Geræstus in Eubœa, and from his dying curse sprang those crimes and sorrows of the house of Pelops which supplied the Greek tragedians with such fruitful themes. Among the sons of Pelops by Hippodamia were Atreus, Thyestes, and Chrysippus. According to others Chrysippus was his son by a different mother. Atreus and Thyestes were jealous of Chrysippus and murdered him, wherefore Pelops drove them out. According to another story it was Hippodamia who murdered him and fled, but afterwards her bones were brought back to Olympia, where she had a temple, in which the women offered her a yearly sacrifice. From Pisa Pelops extended his sway over the neighbouring Olympia, where he celebrated the Olympian games with a splendour unknown before. He warred against and treacherously slew Stymphalus, king of Arcadia. His power and fame were so great that henceforward the whole peninsula was known to the ancients as Peloponnesus (Isle of Pelops). In after times Pelops was honoured at Olympia above all other heroes; a temple was built for him by Heracles, his descendant in the fourth generation, in which the annual magistrates sacrificed to him a black ram. During the Trojan war the Greeks were told that Troy could not be taken until they fetched a bone of Pelops. So a shoulder-blade of Pelops was brought from Pisa. When it was being brought back again the ship carrying it was wrecked off Eubœa. Many years afterwards the bone was taken up by Damarmenus, a fisherman, in his net. Astonished at its size, he went to inquire of the Delphic oracle. There he met envoys from Elis come to discover a remedy for a pestilence. The oracle bade them recover the bone of Pelops, and commanded Damarmenus to restore it to them. He did so, and he and his descendants were appointed custodians of the bone. Some thought that the Palladium was made of the bones of Pelops. This belief in the miraculous efficacy of

the bones of heroes was common in Greece (witness, e.g., the story of the bones of Orestes in Herodotus). From the great size of the bones they may sometimes have been those of large extinct animals.

From the reference to Asia in the tales of Tantalus, Niobe, and Pelops it has been conjectured with some probability that Asia was the original seat of these legends, and that it was only after emigration to Greece that the people amongst whom they were current localized a part of the tale of Pelops in their new home. In the time of Pausanias the throne of Pelops was still shown on the top of Mount Sipylus. The story of Pelops is told in the beautiful first Olympian ode of Pindar. The prosaic version of the story found in Nicolaus Damascenus (17) differs in several points from the usual legend.

**PELOUZE, THÉOPHILE JULES** (1807-1867), French chemist, was born on 26th February 1807 at Valognes in Normandy, where his father was manager of a porcelain manufactory. The elder Pelouze was a man of great ability and energy, but of a peculiarly susceptible temperament, which made it impossible for him to remain long in any position. He gave up his post at Valognes, and found employment successively at the glass-works of St Gobain, the iron-works at Charenton, and in gas-works. This moving life was unfavourable for the family finances, but doubtless gave young Pelouze opportunities of seeing and becoming familiar with a great variety of chemical operations on a large scale. He studied pharmaceutical chemistry first at La Fère, and afterwards, under Chevalier, at the École de Pharmacie in Paris. He then became a clinical clerk under Magendie in the Salpêtrière hospital. One day, when returning from a visit to his father at Charenton, he was surprised by a heavy shower, and seeing what he took to be a public carriage—the omnibus of the period—he hailed it. It contained only one passenger, but the driver, instead of stopping for another fare, drove on without taking the least notice. Pelouze rushed up and stopped the horse. On this the solitary passenger, who was Gay-Lussac, explained that he had hired the vehicle for his own use, but that he would be glad of the company of the new-comer. The result of this accidental introduction was that Pelouze abandoned medicine and continued the study of chemistry in Gay-Lussac's laboratory. From 1827 to 1829 he acted as assistant to Gay-Lussac and Lassaigne, and in 1830, on the recommendation of Gay-Lussac, he was appointed professor of chemistry at Lille. Returning to Paris, he was appointed in 1831 professor of chemistry at the École Polytechnique and at the Collège de France, in 1833 assayer to the mint, and in 1848 president of the Mint Commission. In 1850 he succeeded Gay-Lussac as chemical adviser to the glass-works of St Gobain. He was elected a member of the Institute of France in 1837. He died, after a short illness, on the 31st of May 1867.

Along with Frémy, Pelouze published a *Treatise on Chemistry* (1849-50; 2d ed. 1854-56). His numerous chemical papers were published in the *Annales de Chimie et de Physique* and in the *Comptes rendus*. Among these the most important are:—"On Bootroot Sugar" (1831), "On Salicine" (1830 and 1831), "On the Transformation of Hydrocyanic Acid and Water into Formiate of Ammonia" (1831), "On Lactic Acid" (with Gay-Lussac, 1833), "On Tannin, Gallic Acid, Pyrogallie Acid, &c." (1835), "On the Product of the Distillation of Organic Acids" (1834), "On Nitrosulphates" (1835), "On Butyric Acid" (with Gella, 1844), "On Gun-cotton" (1846 and 1847), "On the Effect of Light on the Colour of Glass" (1865 and 1867).

**PELTIER, JEAN CHARLES ATHANASE**, was originally a watchmaker, but retired from business about the age of thirty and devoted himself to experimental and observational science. He was born at Ham (Somme) in February 1785; his death took place at Paris in October 1845.

His great experimental discovery was the heating or

*cooling* of the junctions in a heterogeneous circuit of metals according to the direction in which an electric current is made to pass round the circuit (1834). This reversible effect is proportional directly to the strength of the current, not to its square, as is the irreversible generation of heat due to resistance in all parts of the circuit. It is found that, if a current pass from an external source through a circuit of two metals, it *cools* one junction and heats the other. It cools the junction if it be in the same direction as the thermo-electric current which would be caused by directly heating that junction. In other words, the passage of a current from an external source produces in the junctions of the circuit a distribution of temperature which leads to the weakening of the current by the superposition of a thermo-electric current running in the opposite direction. The true importance of this so-called "Peltier effect" in the explanation of thermo-electric currents was first clearly pointed out by Joule; and Sir W. Thomson (see vol. viii. p. 97) further extended the subject by showing, both theoretically and experimentally, that there is something closely analogous to the Peltier effect when the heterogeneity is due, not to difference of quality of matter, but to difference of temperature in contiguous portions of the same material. Shortly after Peltier's discovery was published, Lenz effected by means of it the freezing of small quantities of water by the cold developed in a bismuth-antimony junction when a voltaic current was passed through the metals in the order named.

Peltier's other papers, which are numerous, are devoted in great part to atmospheric electricity, waterspouts, cyanometry and polarization of sky-light, the temperature of water in the spheroidal state, and the boiling-point at great elevations. There are also a few devoted to curious points of natural history. But his name will always be associated with the thermal effects at junctions in a voltaic circuit, a discovery of importance quite comparable with those of Seebeck and Cumming.

**PELUSIUM**, an ancient city of Egypt, at the mouth of the most easterly (Pelusiac) branch of the Nile, was the key of the land towards Syria and a strong fortress, which, from the Persian invasion at least, played a great part in all wars between Egypt and the East. It has not, however, been satisfactorily identified with any place mentioned in the hieroglyphic monuments, and the conjecture of Jerome, who supposes it to be the Sin of Ezekiel xxx. 15, 16, though admirably suited to the context and certainly preferable to the Sais of the LXX., cannot be positively established. Pelusium is the Faramá of the Arabs; the neighbouring place still called Tina is hardly to be identified stymologically with Sin. The country about Pelusium was noted for the production of flax; the fame of the Pelusian linen is, perhaps, still preserved in the word "blouse." The whole district has now relapsed into sand and marsh, and the site has not yielded any important remains.

**PEMBERTON**, an urban sanitary district of Lancashire, England, situated on the Lancashire and Yorkshire Railway,  $2\frac{1}{2}$  miles west from Wigan. Near the town are stone quarries and collieries, and the town itself possesses cotton-mills, chemical works, and iron-foundries. At a short distance is Hawley Hall, an ancient timber house. At Anciff in the township of Pemberton there was, according to ancient records, a burning well of considerable fame, but the name Anciff has now disappeared, and the site cannot be verified. The population of the urban sanitary district (area 2894 acres) in 1871 was 10,374, and in 1881 it was 13,762.

**PEMBROKE**, the most westerly county of South Wales, lies to the west of the counties of Cardigan and Carmarthen, and is bounded on three sides by the ocean—on the S. by the Bristol Channel, on the W. by St George's

Channel, and on the N. by Cardigan Bay. Its length from Strumble Head to St Gowan's Head is about 30 miles, and its average breadth a little over 20. The area is 393,682 acres, or about 615 square miles.

The coast-line is extremely irregular and extends to over 100 miles, the principal inlets being Newport Bay; Fishguard Bay, 3 miles in breadth, with an average depth of from 30 to 70 feet, and possessing a good anchorage-ground of mud and sand; St Bride's Bay, 8 miles long by 8 broad; and Milford Haven, a splendid landlocked natural harbour, having a length of about 20 miles, and including numerous small bays and creeks. A considerable number of islands adjoin the coast, the largest being Ramsey, which (excepting some small rocks) includes the most westerly land in Wales; Skomer and Stockham, between St Bride's Bay and Milford Haven; and Caldy, south of Tenby. The southern coast, consisting of bare, broken, and beetling limestone cliffs, in many cases 200 feet in height, is exposed to the full force of the Atlantic, which in several places has hollowed out long funnel-shaped cavities into which the sea has entrance, the most remarkable being Bosheston Mere, near St Gowan's Head. Owing to the ocean storms the county is almost bare of trees, and the bareness is not relieved or atoned for by mountains, although in many parts of the coast the scenery is wildly picturesque. For the most part the surface is gently undulating, the small rounded hills rising in height towards the north, until they merge in the Presaley range, which runs from east to west and divides the county into two parts, the highest summits being Cwm-Cerwyn, 1754 feet, in the centre of the chain, the lesser eminences of Moel Trigarn and Carn-meyn in the east, and Bwlch-gwnt and Foel Eryr in the west. The principal rivers are the Teifi, which forms for a short distance the north-eastern boundary of the county with Cardiganshire; the Cleddy or Cleddou, of which there are two branches, an eastern and a western, both flowing south and mingling their waters in Milford Haven; the Nevers, which flows north into Newport Bay; and the Gwasen, which flows through a narrow and beautifully-wooded glen to Fishguard Bay.

*Geology and Minerals.*—Three-fourths of the county, including the northern portion stretching westwards to the western Cleddou river, and, with certain exceptions, to the Channel, is formed of Llandeilo flags. The Carboniferous strata from the South-Wales coal-field extend across the centre of the county from east to west, their area narrowing towards the west. The Pembrokehire coal-field differs entirely from the South-Wales coal-field both in the lie of the strata and in the character of its beds, due to the occurrence of volcanic action. It is separated also from the main field by an interpolation of Old Red Sandstone. North, east, and north-west it is bounded by beds of mountain limestone and millstone grit, and on the south by Cambrian beds and by the ocean, below which the Coal-measures extend. The strata are composed of Coal-measures, Carboniferous Limestone, and Old Red Sandstone, and are frequently extremely contorted. Igneous stratified rocks also occur in the Presaley range, and in the neighbourhood of St David's Head. The coal is anthracite, and when put on the fire in a wet state emits a blue flame without smoke. About 80,000 tons are now dug annually, the coal being used for furnaces and for smelting and brewing purposes. There is a lead mine at Llanfyrnach, from which a considerable yield of silver is obtained, the annual value of the ore raised being about £15,000. In caves explored near Tenby and on Caldy Island there have been found remains of various species of extinct mammals.

*Climate, Soil, and Agriculture.*—Although Pembrokehire is exposed to frequent violent gales from the south-west, the climate in the south is very mild and warm; and

flowers, fruits, and vegetables are earlier than in most other districts of the United Kingdom. Towards the north, especially on the higher ground, it is much colder, and damp fogs and rain are frequent. The most common soil is a dark-grey loam, which is much improved by admixture with lime and sand. The sandstone and limestone formation in the south produces an excellent quick soil, admirably adapted for horticulture, which is generally pursued in this district. In the more northerly and higher regions more attention is given to cattle-rearing and dairy-farming than to the raising of crops or sheep-farming. The farm-houses and buildings, which formerly were rude and primitive in construction, with low mud-walls, are now generally built of stone on improved methods. The cottages of the peasants are, however, still for the most part uncomfortable huts built of a clay and straw compound called "clom." Great improvements have lately taken place in farming, owing in great part to the enlightened encouragement of the landlords.

From 5935 in 1875 the number of holdings had increased to 5999 in 1880 (the latest return). Nearly four-fifths, 4222, were not above 50 acres each in extent, 837 were between 50 and 100 acres, 853 between 100 and 300, and only 87 above 300 acres. In 1883 there were 305,644 acres, or about 77 per cent. of the total area, under tillage, corn crops occupying 55,011 acres, green crops 13,266, rotation grasses 28,409, permanent pasture 206,052, and fallow 2906. The principal cereals are barley occupying 24,799 acres and oats (of which the black species occupy a large area) 25,494 acres, wheat occupying only 4604 acres. Potatoes were grown on 3042 acres, turnips and sweetens on 8038, and mangolds on 1322. Horses in 1883 numbered 14,333 (of which 8665 were used solely for purposes of agriculture), cattle 83,436 (of which 31,779 were cows and heifers in milk or in calf), sheep 91,901, and pigs 27,623. The principal breed of cattle are the native Castlemartins, black in colour, and well suited to the climate and the system of farming, as they both fatten readily and yield large supplies of milk. Herofords and Alderneys have lately been introduced on many farms, but the old breed is still the favourite.

According to the latest return the land was divided among 3121 owners, possessing 356,699 acres, at an annual valuation of £389,701, or about £1 1s. 10d. per acre. The estimated amount of common or waste land was 11,260 acres. Of the owners, 1492, or about 44 per cent., possessed less than one acre each. The following owned over 5000 acres each, viz., C. E. G. Phillips, 18,729 acres; earl of Cadw, 17,736; Sir Owen Scourfield, Bart., 11,243; Lord Kensington, 6537; bishop of St David's, 5651; George Harries, 5173; and M. A. Sawin, 5168.

**Manufactures.**—Flannels are woven in various towns, and are the principal textile manufacture of the county; there are also rope and sail works, and hat-making is practised. Many of the inhabitants are engaged in coal-mining and in fishing. At Pater there is a very extensive dockyard, and shipbuilding is carried on at several other ports. Since the opening up of railway communication the shipping trade, and the mining and other industries, have made extensive progress, but the railway connexion is still somewhat imperfect.

**Administration and Population.**—The county includes seven hundreds; the municipal boroughs of Haverfordwest (6398), Pembroke (14,156), and Tenby (4750), and part (2058) of the municipal borough of Cardigan, the remainder of which is in Cardiganshire. In addition to Haverfordwest, Pembroke, and Tenby, there are four other market towns,—Fishguard (2009), Milford (3812), Narberth (2334), and Newport (1504). The county is divided into three poor-law unions—Haverfordwest, Pembroke, and Narberth. It is included in the south-western circuit. It has one court of quarter-sessions, and is divided into seven petty and special sessions divisions. One member is returned to parliament for the county, one for the Haverfordwest district of boroughs, consisting of Fishguard, Haverfordwest, and Narberth, and one for the Pembroke district of boroughs, consisting of Milford, Pembroke, Tenby, and Wiston. Pembrokeshire contains 153 civil parishes, with part of one other. It constitutes the archdeaconry of St David's in the diocese of the same name, and forms part of the province of Canterbury. From 56,280 in 1801 the population had increased in 1821 to 74,009, in 1851 to 94,740, but in 1871 it had diminished to 91,998, and in 1881 to 91,824, of whom 43,449 were males and 48,375 females. The number of inhabited houses in 1881 was 19,462, the average number of persons to an acre 0.23, and of acres to a person 4.26.

**History, &c.**—Although the limestone caves of Pembrokeshire abound with relics of the Pleistocene fauna, no traces have as yet been discovered of Palaeolithic man. Neolithic remains are plenti-

ful. In caves, cliff-castles, bogs, kitchen-middens, &c., implements of the polished stone age are frequently found, but, strange to say, the long barrows typical of this period are wanting; dolmens or cromlechs, however, are very common: the ordnance map gives fifty-two, but this is by no means an exhaustive list. Litch-y-Drybedd near Nevern, Pentre Evan near Newport, another one in the same town, Loughouse near Mladry, Tre Llys on Pencair, are magnificent specimens of Megalithic work. Stone circles, cairns, monoliths, and earthworks abound in the county; what proportion of these are attributable to the dolichocephalic non-Aryan Silures who used stone implements it is impossible to say.

The Goidel or Gaelic branch of the Celtic family has the credit of having introduced bronze and round tumuli with cremated bodies; of these latter there are a great number in Pembrokeshire, and considerable quantities of bronze implements have been discovered. A mixture of Silures and Goidels seem to have held the country until they were conquered by the Romans about the year 70 A.D. Roman remains are but scantily represented in Pembrokeshire. Via Julia terminated at St David's, but no traces of the peculiar Roman roadmaking exist. Fenton, the county historian, fancied he discovered the station *Ad Vigintium* of the spurious *Itinerary* of Antonine at Ambleston, and there can be no doubt that a large Roman building of some sort did exist at that place. The late Professor Rolleston and Mr E. Law discovered Samian ware in the cave of Loughby near Tenby, and Roman coins, ranging from Vespasian, 78 A.D., to Constantine II., 340 A.D., have been found very plentifully in the county.

When the Saxons pressed the Cymric tribe of Brythonic Celts in Cumbria, the latter appear to have migrated into Wales, and to have conquered the inhabitants; the Pembrokeshire Goidels seem to have held out for some time. During this troubled period there was a great incursion of missionaries, both Goidel and Cymric; to these we owe the nomenclature of many villages. To this period must be attributed the sepulchral inscriptions in that strange character which has been called Ogam. Of these so many are to be found in Pembrokeshire that it has been considered probable they were invented in the district. They are usually in base Latin; good specimens are to be seen on Caldy Island, St Dogmel's, Cwmgloyn near Nevern, and Treffgarne near Haverfordwest. Most of the crosses must be attributed to this period, though probably the inscribed ones at Carew and Nevern are of later date.

After Wales had been completely conquered by the Cymry, Rhodri Mawr divided it among his sons, and Pembrokeshire fell to Cadell in 877. From that period until its complete incorporation with England it suffered terribly from the family feuds of the Welsh princes. The Scandinavians also proved a fearful scourge. Their first incursion, according to the *Brut-y-Tywyssogion*, took place in 795. The creeks of Pembrokeshire were peculiarly adapted to the wants of the vikings, and they seem to have formed a strong colony in the county, of which such names as Asgard, Fishguard, Grafsholm, Freystrop, Goodwich, Milford Haven (Midfjord Havn), Haverfordwest (Havards Fjord), &c., are an abiding evidence.

During the reign of William Rufus, Arnulph de-Montgomery, son of Roger de Belesme, invaded the southern portion of the county with the king's sanction; he gained a district and built Pembroke Castle; Manorbier was most likely erected at the same time. In 1107 a colony of Flemings was sent into Pembrokeshire by the king (Henry I.); they settled at Haverford and Tenby. A second party of Flemings and other adventurers was despatched to Pembroke by Henry II.; these were mercenaries who had served in the civil war between Stephen and Maud. In April 1170 a party of Pembrokeshire men invaded and overran the eastern shores of Ireland.

In 1405 Owen Glendower harried the county; he occupied Tenby with 10,000 Welshmen, and was joined by a French force of 12,000 men who had landed in Milford Haven. In 1456 Henry VII. was born in Pembroke Castle, the residence of his uncle Jasper Tudor, earl of Pembroke. After a long exile he landed at Brunt near Dale with French troops; here he was joined by Sir Rhys ap Thomas at the head of a large number of Welshmen, with whom he marched to Bosworth field. When the church property was disposed of under Henry VIII., Lamphey Court, once a bishop's seat, fell to the Devereux family, and it was the residence of the three Devereux earls of Essex. These noblemen were extremely popular, and it was most likely in consequence of the political views held by Robert the third earl that when the civil war broke out Pembrokeshire was found to be "the most seditious county in all Wales, or rather of England, for the inhabitants were like English corporations, unlike loyal Welshmen" (*Mercurius Aulicus*, 29th week, 20th July 1644). Pembroke and Tenby held out until 1648, when the Presbyterians rebelled against the Independents; then under Mayor and Colonel Poyer the royal standard was hoisted on Pembroke keep. Cromwell himself besieged Pembroke, which yielded to him on 17th July 1648.

Besides the ruins of the fine castle of Pembroke, many others are to be found in the county,—Manorbier, Carew, Lamphey, Narberth.

Llwhaddon, Haverford, Roch, Newport; but Newport has been turned into a modern dwelling-house. Most of these are Edwardian erections on Norman work, some of them having Tudor additions.

The most important ecclesiastical building is the cathedral of St David's. Some sort of church existed on the site from the 6th century, but the earliest work now remaining is that of Bishop Peter de Leia (1180). This was seriously injured by the fall of the tower in 1220; the damage had scarcely been repaired when the church was wrecked by an earthquake in 1248. In 1328 Henry Gower succeeded to the bishopric, the most munificent benefactor the church of St David's ever saw; he transformed the cathedral, introducing the Decorated style throughout the edifice. After the Reformation the building was permitted to fall gradually into decay, until it had become little better than a ruin. But in 1868 the edifice, more especially the tower, was thoroughly restored under the late Sir Gilbert Scott.

**PEMBROKE**, a municipal and parliamentary borough of South Wales, is picturesquely situated on an elevated ridge at the head of Pannar Mouth Creek, on the south side of Milford Haven, 30 miles south-west of Carmarthen. The ruins of the ancient castle, originally founded by Arnulph de Montgomery in 1094, occupy the summit of the ridge. The castle was one of the strongest of the ancient fortresses of Wales. Beneath it is an enormous natural cavern, called "The Wogan," 70 feet long and 50 feet wide. At the beginning of the Civil War the castle was held for the Parliament, but, the commanders having gone over to the Royal cause, it was taken by Cromwell after six weeks' siege. Near the castle are the ruins of Monkton Priory church, in the Norman style, containing a long vaulted nave in good preservation. The church of St Mary, in the Early Pointed style, possesses a massive steeple. At Pater, 2 miles west of Pembroke, is Pembroke dock, an important Government dockyard, surrounded with very strong fortifications. The dock is 70 acres in extent, and the yard affords employment to about 24,000 artisans. There are also artillery and infantry barracks. Pembroke possesses a town-hall, assembly room, a mechanics' institute, an infirmary, and several charities. The town was incorporated by Strongbow, earl of Pembroke, in the reign of Stephen, but the earliest charter preserved is one granted by John, which was confirmed by successive sovereigns. The population of the municipal borough (area, 5626 acres), which includes the two wards of Pater and Pembroke, in 1871 was 13,704, and in 1881 it was 14,156. The population of the parliamentary borough (area, 6298 acres) in the latter year was 16,339.

**PEMPHIGUS.** See SKIN, DISEASES OF.

**PEN**, an instrument for writing or for forming lines with an ink or other coloured fluid. The English word, as well as its equivalents in French (*plume*) and in German (*Feder*), originally means a wing-feather, but in ancient times the implements used for producing written characters were not quills. The earliest writing implement was probably the stylus (Gr. *στῦλος*), a pointed bodkin of metal, bone, or ivory, which, however, was only used for producing incised or engraved letters. The calamus (Gr. *κάλαμος*) or arundo, the hollow tubular stalk of grasses growing in marshy lands, was the true ancient representative of the modern pen; hollow joints of bamboo were similarly employed. The use of such pens can be traced to a remote antiquity among the civilized nations of the East, where reeds and canes are to this day in common use as writing instruments. The earliest specific allusion to the quill pen occurs in the writings of St Isidore of Seville (early part of the 7th century).<sup>1</sup> But there is no reason to assume that the quill pen was not in use at an earlier period, and, indeed, remains have been found which prove that even metal pens were not altogether unknown to the ancient Romans.

The quills, formerly in exclusive use, and still largely employed among Western communities as writing instruments, are obtained principally from the wings of the goose. Swan-quills are also highly prized, and for special purposes crow-quills and the wing-feathers of certain other birds are adopted. For the method of preparing quills, &c., see FEATHERS, vol. ix. p. 60. In 1809 Joseph Bramah, the famous inventor, devised and patented a machine for cutting up the quill into separate nibs by dividing the barrel into three or even four parts, and cutting these transversely into "two, three, four, and some into five lengths." Bramah's invention first familiarized the public with the appearance and use of the nib and holder in place of the complete quill or barrel, and in that sense he anticipated the form of pen now most commonly used. In 1818 Charles Watt obtained a patent for gilding and preparing quills and pens by manual labour and chemical means, which may be regarded as the precursor of the gold pen. But a more distinct advance in this direction was effected in 1822, when Hawkins and Mordan patented the application of horn and tortoise-shell to the formation of pen-nibs, the points of which were rendered durable by impressing into them small pieces of diamond, ruby, or other very hard substance, or by lapping a small piece of thin sheet gold over the end of the tortoise-shell, and by various other ways, securing a hard unalterable point to the pen.

Metallic pens, though perhaps not altogether unknown even in classical times, did not come into use till the present century, and indeed did not become common till near the middle of the century. At the meeting of the British Association in Birmingham in 1839 steel pens were scarcely known; ten years later the manufacture had become an important local industry. In 1803 a steel pen was made and sold in London by a Mr Wise, which was in the form of a tube or barrel pen, the edges meeting to form the slit with sides cut away as in the case of an ordinary quill. These sold at about five shillings each, and as they were hard, stiff, and unsatisfactory instruments they were not in great demand. In 1808 a metallic pen was patented by Bryan Donkin, made of two separate parts, flat or nearly so, with the flat sides opposite each other forming the slit of the pen, or, as an alternative, of one piece, flat and not cylindrical as in the usual form, bent to the proper angle before being inserted into the tube which forms its holder. In Birmingham a steel pen was made by a splitting manufacturer, Harrison, for Dr Priestley towards the end of the 18th century. Harrison in after years became associated in the split-ring business with Josiah Mason, who was one of the great pioneers of the steel-pen trade. Mason developed the manufacture on the basis of an invention by James Perry, who in 1830 obtained a patent for improvements which must be regarded as the foundation of the steel-pen industry. Perry's improvements consisted in producing pens from hard, thin, and elastic metal, the most suitable material being described as the very best steel brought to a spring temper. The necessary flexibility was given to the pen by a central hole formed in the pen between the nib and the shoulder in connexion with a central slit, and by making between the nib and the shoulder one or more lateral slits on each side of the central slit. Joseph Gillott, who divides with Mason and Perry the credit of perfecting the metallic pen, does not appear as a patentee till 1831, when he patented an improvement which consisted in forming elongated points on the nibs of pens. These early pens lacked softness, flexibility, and smoothness of action, and subsequent inventions of Perry, Gillott, Mordan, and others were largely devoted to overcoming such defects. Metals other than steel were also frequently suggested by inventors, those most commonly

<sup>1</sup> "Instrumenta scribæ calamus et penna; ex his enim verba paginis inquantur: ead calamus arboris est, penna avis, cujus acumen divider in duo."

proposed being silver, zinc, German silver, aluminium, and aluminium bronze, the last-named having at one time come into extensive use. The development of the gold pen cannot be traced through the patent records in the same way as some others. Dr Wollaston, it is recorded, used a gold pen composed of two thin slips of gold tipped with rhodium, made apparently on the principle patented by Donkin in 1808. Messrs Mordan of London have the credit of being the earliest regular makers of gold pens with tips of osmium-iridium alloy, and that manufacture was subsequently developed by Messrs Wiley of Birmingham. The gold pens now made are provided with iridium tips, and their manufacture is a special industry, requiring processes and machines different from those used in the steel-pen industry.

Fountain pens and penholders in which considerable reservoirs of ink could be carried ready for use were introduced by a patented invention of the ingenious Joseph Bramah. Of his several plans for a fountain pen one proposal was a hollow tube of silver or other metal, the tube being made so thin that it could readily be compressed out of shape and so cause an escape of ink to the nib, and another plan was to fit the tube with a piston which might slide down the interior and so force out ink. John Scheffer in 1819 patented a device consisting of a reservoir in the holder operated on by a stud, which, when pressed by the thumb, yielded a flow of ink to the nib. Many forms of attachment and modifications of the shape of the pen have also been introduced with the view of enabling the pen itself to carry a considerable supply of ink, and to discharge it in writing in a safe and equal manner. A highly original and comparatively successful form of fountain pen of recent introduction is known as the stylograph, in which the ordinary form of nib is dispensed with, and connected with the barrel or reservoir is a finely-tapered point tipped with iridium pierced with a fine aperture. Into the aperture is fitted an iridium needle or plug attached internally to a delicate gold spring, and the act of writing sufficiently pushes back the needle to allow the escape of the requisite flow of ink by the aperture. The two principal forms of stylograph are that of Mackinnon, patented first in the United States in March 1879, and that of Cross, the United States patent for which was secured in January 1878.

The finish which the common steel pen now shows, and the low price at which it can be sold, are triumphs of manufacturing skill, the credit of which is largely due to Birmingham. For the fraction of a farthing there can now be purchased an article incomparably superior to that which in the early years of the century cost five shillings. The metal used consists of rolled sheets of cast steel of the finest quality, made from Swedish charcoal iron. These sheets are cut into strips of suitable width, annealed in a muffle furnace, and pickled in a bath of dilute sulphuric acid to remove the oxidized scale from the surface. The strips so cleaned are next rolled between steel rollers till they are reduced to ribbons the thickness of the pens to be made. At this stage the raw material is ready for the series of manufacturing operations, most of which are performed with the aid of hand fly-presses, moving suitable cutting, stamping, and embossing attachments. The pen blanks are first cut out of the ribbon so as to leave as little scrap as possible. These blanks are next pierced, that is, the central perforation and the side or shoulder slits by which flexibility is secured are made at one operation. After again annealing, they are marked and embossed with maker's name, trade-mark, or any of the endless variety of marks by which pens are distinguished from each other. Up to this point the blanks are flat; they are now raised or rounded into the semi-cylindrical form in which pens are used. At this stage the pens are tempered by heating in iron boxes in a muffle, plunging in oil, and heating over a fire in a rotating cylindrical vessel till their surfaces attain the dull blue colour characteristic of spring steel elasticity. They are then scoured and polished by being revolved in large tin cylinders, in which they are mixed with sand, pounded crucibles, or such substances. The grinding of the points next follows, an operation performed by small rapidly-revolving emery-wheels, on which the points are first ground lengthwise and then across the nib, the object of the process being to increase the elasticity of the point. The slitting process which

follows—that is, the cutting of the pen-slit from the perforation to the point—is effected with a chisel-cutter worked by a hand screw-press. On the precision with which the slit divides the point depends the perfection of the pen, to finish which it now only remains to colour the surface in a revolving cylinder over a charcoal fire, and to varnish it in a solution of shellac.

Birmingham, which was the first home of the steel-pen industry, continues to be its principal centre, but steel pens are also made in the United States and in France and Germany. (J. P.A.)

**PENANCE.** The word "penance" (*penitentia*) has a double signification,—its strict legal meaning of a penalty inflicted by the formal sentence of a spiritual authority in punishment of an offence, and with the primary object of amending and so benefiting the offender; and its wider and more popular sense of any ascetic practice adopted, whether voluntarily or under compulsion, for the expiation of sin or for advance in spiritual attainment. Broadly speaking, no trace of such a theory is visible in classical paganism, from which the idea of sin as a moral defilement is almost absent. There are faint marks discernible in the Greek heroic legends of something analogous to penance, when we read of a hero being driven into exile for some crime (most usually unpremeditated homicide), and not permitted to return till he had found some one able and willing to purify him with certain lustral sacrifices. In the historical period these lustral sacrifices continue, but the accompanying penalty disappears. Punishments for religious offences, and of a very severe kind, extending to death itself, as in the case of Socrates, are frequent, but they are not of the nature of penance, not having the amendment of the offender in view, but only the safety of the state, to be secured by an act of vengeance designed to avert the anger of the gods and to prevent the repetition of the crime believed likely to invoke it. The Oriental religions, contrariwise, teem with the ascetic principle, and personal austerities form a large part of the Zoroastrian, Buddhist, and Brahman systems. Yet, with the exception of the pilgrimages, which enter so deeply and widely into the religious habits of the peoples professing these creeds, and involve much toil and suffering in the case of the poorer pilgrims, these austerities are not of general incidence, but are confined to a comparatively small, and, so to say, professional body of devotees, such as the Indian Jogis, who are entirely distinct from the main body of their co-religionists. Islam had originally nothing even remotely like the practices in question, save in so far as the annual fast of Ramadan and the hajj to Mecca and other sacred places necessitated self-denial; and it is even on record that Mohammed himself directly discouraged an ascetic spirit which displayed itself in some of his trustiest companions and disciples, such as 'Omar, 'Ali, Abū-Dharr, and Abū-Horseirah. But the reaction of conquered Persia, long the home of Zoroastrian asceticism, on the Arab victors was marked and early, and an inner body of austere devotees arose in the midst of Mohammedanism within a century and a half of the Flight, though having no justification in the Koran or in the body of early tradition for their tenets and usages. They were in almost every instance of Persian origin, and the most famous of them all, the converted robber Fodheil Abū 'Ali Zalikhanī, the Benedict of Islam, who first organized the scattered ascetics into the brotherhood of dervishes, was himself a Khorasani of pure descent. But, like the Indian Jogis, the Mohammedan dervishes and fakirs have continued as an isolated class, and have never exerted the kind of influence which Christian monachism, especially in the West, has done. Nor has the principle of penance ever formed an important integer of the Jewish religion. The Levitical code enjoins the performance of various lustral sacrifices in expiation of certain sins; but the cost of the victims is the only element of penalty, being virtually a money fine



on the offender. The prophets, while dwelling much on the necessity of repentance, of a moral change in the sinner, are almost entirely silent as to any accompanying acts and observances of an ascetic nature; and, though occasional references to prolonged fastings and to the wearing of sackcloth as penitential exercises are found, yet they appear as exceptional and spontaneous, and not as part of an accredited system, nor as enjoined by any authority external to the devotee or penitent himself. Even under the Talmudic code there is no organized system of penance. The three degrees of excommunication, *midon*, *cherem*, and *shammata*, ascending from mere exclusion from the congregation for a month, through the stage of anathema, to that of public and ignominious expulsion from fellowship in Israel (and that at first irrevocably, though the penalty was afterwards relaxed), practically exhaust the code, since there are no formal provisions for inflicting other penalties, whatever voluntary observances may at any time have been superadded.

The Christian theory of penance ultimately rests on the view that the Christian church is the precise analogue of the Jewish people under the elder dispensation. As the Jews were the one family on earth in direct covenant with God, so that it became necessary for all Gentiles who desired to be brought into the like relation to abandon their own proper nationality and to become Jews by adoption, forsaking their former habits and associations together with their creed; and as various offences against the law of Moses were punished with temporary or final exclusion from fellowship in the Hebrew polity; so was it from a very early period in the Christian church. One marked difference between the Rabbinical and the Christian discipline is indeed visible from the first, that the former involved the suspension or deprivation of civil rights, whereas the latter, in all the earlier centuries at any rate, was a purely spiritual penalty. But they are agreed in combining two ideas, one wholly foreign (as already observed) to paganism, and the other but vaguely shadowed therein,—the aim of healing the offender himself and the need of his making public satisfaction to the society whose rules he had broken, and which might suffer in reputation and influence by reason of his misconduct. It is this notion of satisfaction which has led to the extension of the word "penance" itself from its more restricted and legal meaning to its wider use as covering the whole range of ascetic practices. And, as it soon came to be accepted that the inward sorrow for sin would be attended with an outward token of that sorrow, involving pain or humiliation in some form or other, there are four distinct stages in the ecclesiastical use of the word "penitentie,"—first, as denoting the change of mind due to sorrow for sin; next, the external penalty attached to each offence; thirdly, the discipline of the church in dealing with all spiritual offences; and lastly, any piece of austerity practised with a religious motive; and the fact of the Latin language having no doublets like the English "penitence" and "penance" to express the distinct though allied ideas of the mental attitude and the outward action has powerfully conditioned Latin theology and practice.<sup>1</sup>

There is naturally but little to be found in the New Testament on the subject of discipline; but the whole principle is provided for and anticipated in one saying of

Christ—that which directs that he who neglects to hear the church as arbiter in a dispute shall be regarded as a heathen man and a publican, and which goes on to confer upon the apostles the power of binding and loosing (Matt. xviii. 17, 18),—words which they, with their Jewish experience and associations, must needs have interpreted as authorizing, and even enjoining, the infliction of penalties, and notably that of excommunication, upon members of the new society. Accordingly, the leading example of such discipline, the case of the incestuous Corinthian, attests plainly some form of trial, a sentence of excommunication, some proof of repentance, and the consequent reconciliation and restoration of the offender (1 Cor. v.; 2 Cor. ii. 6-10); and it is most probable that some such method was pursued in the sub-apostolic church, each case being dealt with locally, and on its separate merits, long before any formal system or code came into existence. The penalties seem at first to have been very simple and lenient, leaving out of account the difficult problem of the phrase "delivering to Satan," twice found in this connexion (1 Cor. v. 5; 1 Tim. i. 20), which may mean merely relegating to heathen fellowship by exclusion from the society of Christians, but also may cover much more ground. Exclusion from the eucharist itself, exclusion from non-communicating attendance at the eucharist, and exclusion from all religious assemblies for even the minor offences of worship are the only censures discoverable in the earlier period, though it is not long before certain additional penalties accompanying these grades of separation begin to appear. The following broad rules govern all cases of penitential discipline in the ancient church.

(1) Penance related only to baptized and communicant Christians. Even catechumens were not held capable of it, to say nothing of Jews or Pagans. (2) It was exclusively spiritual, and in no way touched the civil condition of the penitent, even after the conversion of the empire. (3) It was not compulsory, but spontaneous; nay, so far was it from being imposed, that it had to be sought as a favour. Of course, where it was not so sought the excommunication of the offender remained in force, but this excommunication was not regarded as in itself a penance in the later use of that term. (4) The most usual rule allowed of penance but once. The relapsing offender had no second opportunity granted him. (5) It was always preceded by confession (*ἔξομολόγησις*), a term which, however, even as early as Tertullian's time, was already extended to include, over and above the oral acknowledgment of guilt, the external acts of mortification accompanying it (*De Pœn.*, c. 9). (6) There was a careful classification of the offences involving penance, and after a time a corresponding classification of penitents into certain fixed grades, through which it was in many cases necessary to pass, from the lowest to the highest, before receiving absolution and being restored to full communion.

The case dealt with by St Paul establishes one point, that of the comparative brevity of the time of penance, even for very grave offences, since three years is the longest period which can have elapsed between the two epistles to the Corinthians; whereas under the later system periods of fifteen and twenty years are not rarely to be found, and in some cases penance was for life, however protracted. The earlier method can be shown to have come into wide acceptance far within the 2d century, because it forms the subject of a charge made against the church by Tertullian in one of his Montanist treatises (*De Pudicitia*); and the more stringent discipline of the succeeding era appears to be due to the nearly simultaneous action of two causes,—the great success which attended the persecution set on foot by the emperor Decius in 249, resulting as it did in a far larger propor-

<sup>1</sup> The Greek word *μετάνοια*, which stands both for repentance and for the sacrament or mystery of penance, has undergone a singular degeneration of meaning in ecclesiastical language, being often used to denote an observance of head and body, because that gesture is one which was enjoined upon penitents as part of the outward expression of sorrow for sin. But this ambiguity has had no theological results; because the penalty imposed in the confessional is not called *μετάνοια*, but *ἐπιτίμια*, and thus no confusion can arise, especially as the context always shows clearly when *μετάνοια* stands for a mere gesture.

methodized and determinate order in use during the 6th and immediately succeeding centuries. There is no theological difference between them, however, in respect of their view of absolution, although in the one case a declaratory, and in the other a precatory, form is employed. But a distinction in practice is maintained hereupon, for even the United Greeks are obliged, in virtue of an instruction issued by Clement VIII. in 1595, to use only the declaratory form when pronouncing absolution. In Latin theology the matter of the sacrament of penance is distinguished as "remote" and "proximate," as "exterior" and "interior," as "necessary" and "sufficient." The remote and exterior matter of penance is all post-baptismal sin, with the remission and correction of which penance has to do. The class of mortal sins are the necessary exterior matter, because confession is the only recognized mode of obtaining their remission. Venial sins are sufficient or voluntary matter of penance, because confession of them is not compulsory, and remission may be otherwise had. The contrition, confession, and satisfaction of the penitent are the proximate and interior matter of penance, with this further distinction, that the two former are "essential" and inseparable parts of it, while satisfaction, though an "integral" part, is not essential, being capable of dispensation. The form of the sacrament is the absolution pronounced by the priest. And, as before stated, the acts of bodily or spiritual mortification enjoined on the penitent as parts of his satisfaction, are called penances.

In the Church of England, penance, governed by pre-Reformation canons and statutes, has continued to be inflicted by sentence of the ecclesiastical courts down to very recent times,—one of its commonest forms being that of standing at the church-door clad in a white sheet. Precautions were taken by constitutions of Cardinal Othobon and Archbishop Stratford against the abuse of money commutations of penance; and the right of the spiritual courts to deal with cases involving penance, whether corporal or pecuniary, was protected against writs of prohibition by the statutes *Circumspecte agatis*, 13 Edward I. st. 4, and *Articuli Cleri*, 9 Edward II. st. 1, c. 2. The *Reformatio Legum* provided that ecclesiastical penances should not be commuted for money, save for some grave and necessary cause, and that such money should be applied to the relief of the poor, while a repeated offence should admit of no commutation. This same question came up frequently, having been dealt with under Queen Elizabeth, Charles I., William III., and Queen Anne, on the last occasion by Convocation, which laid down rules that no commutation-money should be allowed by any ecclesiastical judge without the consent of the ordinary in writing, nor disposed of without the like consent. The commutation office in the Book of Common Prayer makes reference to the solemn Lenten penance described above, as a thing desirable to be restored; but no action has ever been taken for the purpose.

In the Lutheran communion, penance, though at first amongst the usages intended to be maintained, and acknowledged in the *Articles* of Schmalkald, and also in the *Apology* for the Confession of Augsburg, has never held an effective place, being in truth incompatible with the doctrines and polity elaborated by Luther himself; so that, although confession and absolution continue as survivals in the Lutheran system, they are not associated with any regular discipline. Far otherwise is it with Calvinism. The twelfth chapter of the fourth book of Calvin's *Institutes* is mainly taken up with the question of ecclesiastical discipline, whose necessity is broadly stated, and alleged to extend to the whole body, clerical and lay alike, and to be derived from the power of the Keys. No precise rules are laid down, beyond saying that censures may begin with private monition, but should ascend in

severity in proportion to the gravity and notoriety of offences; but, in point of fact, the system raised on this basis by most of the Calvinist societies was a stringent and searching one. In particular, the *First* and *Second Books of Discipline*, put forth by John Knox and by the second generation of Scottish Reformers, lay down the principles for dealing with offenders against religion and morals with much clearness and precision, and the *Form of Process in the Judicatories of the Kirk*, as approved by the General Assembly in 1707, prescribes the manner of proceeding to inflict the several penalties enacted against a variety of offences and scandals. These at one time covered a wide area, but in later times only certain forms of immorality have continued to be brought under ecclesiastical cognizance for public censure and penalties. All the other more important Protestant sects have their own systems of discipline, more or less stringent, but they are virtually restricted in operation to suspension of communion with the body, or to expulsion from membership, no other penalties being provided.

*Bibliography.*—Morinus, *Comment. Hist. de Discipl. in Administr. Sacram. Pœnit.* (Antwerp, 1632); Felliccia, *De Christ. Eccl. Pol.* (Cologne, 1828-38); Siegel, *Handb. der Christ. kirchl. Alterthümer*, a. v. "Buße" (Leipzig, 1880); Bingham, *Antiq. of the Christ. Church*, bk. xvi. (London, 1840); Smith and Cheetham, *Dict. of Christ. Antiq.*, a. v. "Penitence" (London, 1880); Richard et Giraud, *Bibliothèque Sacrée*, a. v. "Penitence" (Paris, 1824); Wasserschleben, *Bussordn. der Abendl. Kirche* (Halle, 1851); Theodori Cantuariensis, *Pœnitentiale* (Paris, 1679); Probst, *Kirchl. Discipl. in den drei ersten Christ. Jahrh.* (Tübingen, 1878), and *Sakramente u. Sakramentalien in d. drei erst. Christ. Jahrh.* (Tübingen, 1872); Chardon, *Hist. des Sacram.* (Paris, 1745); Guettée, *Esquis. de la Doct. de l'Ég. Cathol. Orthod.* (Paris, 1866); Macaire, *Théol. Dogm. Orthod.* (Paris, 1860); Calvin, *Institutiones*; Phillimore, *Eccles. Law of the Ch. of Engl.* (London, 1873); Ayliffe, *Paragon Jur. Civ. Angl.* (London, 1726); Du Cange, *Gloss. ad Script. Med. et Inf. Lat.*, a. v. "Pœnitentia" (Basel, 1762); *Compend. of the Laws of the Ch. of Scotl.* (Edinburgh, 1881). (R. F. L.)

PENANG. See PRINCE OF WALES ISLAND.

PENARTH, a seaport of Glamorganshire, Wales, is picturesquely situated on rising ground on the south side of the mouth of the Taff opposite Cardiff, from which it is four miles distant by rail and two by steamer. It was a small and unimportant village until an Act was passed in 1856 for making a tidal harbour. The docks (1865-84) are on a very extensive and complete scale, and the town is now an important shipping port for the minerals of South Wales, especially alabaster, coal, and iron. In 1883 there entered 1130 steamers and 567 sailing-vessels with an aggregate registered tonnage of 1,316,265 tons. The total quantity of coal and coke shipped in the same year was 2,274,003 tons. A line of rails 4 miles in length connects the docks with the Taff Vale Railway. The town is frequented in summer as a bathing-place, and the Rhetic beds at the head are of special interest to geologists. The principal buildings are the custom-house and dock-offices, and the church of St Augustine, in the Early English style, erected by the Baroness Windsor, who also built national schools. The population of the urban sanitary district (area, 2202 acres) in 1871 was 3104, and in 1881 it was 6228.

PENATES, Roman gods of the store-room and kitchen, derived their name from *penes*, "atables, food." The store-room over which they presided was, in old times, beside the *atrium*, the room which served as kitchen, parlour, and bedroom in one; but in later times the store-room was in the back part of the house. It was sanctified by the presence of the Penates, and none but pure and chaste persons might enter it, just as with the Hindus the kitchen is sacred and inviolable. The family hearth, which anciently stood in the *atrium*, was their altar; on it were placed their images, two in number, for the Penates were always in pairs—the name does not occur in the singular.

They had no individual names, but were always known under the general designation, Penates. Closely associated with the Penates were the Lares, another species of domestic deity, who seem to have been the deified spirits of deceased ancestors (see *LARES*). But while each family had two Penates it had but one Lar. In the household shrine the image of the Lar (dressed in a toga) was placed between the two images of the Penates, which were represented as dancing and elevating a drinking-horn in token of joy and plenty. The three images together were sometimes called Penates, sometimes Lares, and either name was used metaphorically for "home." The shrine stood originally in the *atrium*, but when the hearth and the kitchen were separated from the *atrium* and removed to the back of the house, and meals were taken in an upper story, the position of the shrine was also shifted. In the houses at Pompeii it is sometimes in the kitchen, sometimes in the rooms. In the later empire it was placed behind the house-door, and a taper or lamp was kept burning before it. But the worship in the interior of the house was also kept up even into Christian times; it was forbidden by an ordinance of Theodosius (392 A.D.). The old Roman used, in company with his children and slaves, to offer a morning sacrifice and prayer to his household gods. Before meals the blessing of the gods was asked, and after the meal, but before dessert, there was a short silence, and a portion of food was placed on the hearth and burned. If the hearth and the images were not in the eating-room, either the images were brought and put on the table, or before the shrine was placed a table on which were set a salt-cellar, food, and a burning lamp. Three days in the month, viz., the Calends, Nones, and Ides (i.e., the first, the fifth or seventh, and the thirteenth or fifteenth), were set apart for special family worship, as were also the *Caristia* (22d February) and the *Saturnalia* in December. On these days as well as on such occasions as birthdays, marriages, and safe returns from journeys, the images were crowned and offerings made to them of cakes, honey, wine, incense, and sometimes a pig. As each family had its own Penates, so the state, as a collection of families, had its public Penates. Intermediate between the worship of the public and private Penates were probably the rites (*sacra*) observed by each clan (*gens*) or collection of families supposed to be descended from a common ancestor. The other towns of Latium had their public Penates as well as Rome. The sanctuary of the whole Latin league was at Lavinium. To these Penates at Lavinium the Roman priests brought yearly offerings, and the Roman consuls, praetors, and dictators sacrificed both when they entered on and when they laid down their office. To them, too, the generals sacrificed before departing for their provinces. Alba Longa, the real mother-city of Latium, had also its ancient Penates, and the Romans maintained the worship on the Alban Mount long after the destruction of Alba Longa. The Penates had a temple of their own at Rome. It was on the Velia near the Forum, and has by some been identified with the round vestibule of the church of SS. Cosma e Damiano. In this and many other temples the Penates were represented by two images of youths seated holding spears. The Penates were also worshipped in the neighbouring temple of Vesta. To distinguish the two worships, it has been supposed that the Penates in the former temple were those of Latium, while those in the temple of Vesta were the Penates proper of Rome. Certainly the worship of the Penates, whose altar was the hearth and to whom the kitchen was sacred, was closely connected with that of Vesta, goddess of the domestic hearth.

The origin and nature of the Penates was a subject of much discussion to the Romans themselves. They were traced to the mysterious worship of Samothrace; Dar-

danus, it was said, took the Penates from Samothrace to Troy, and after the destruction of Troy Æneas brought them to Italy and established them at Lavinium. From Lavinium Ascanius carried the worship to Alba Longa, and from Alba Longa it was brought to Rome. Equally unsatisfactory with this attempt to connect Roman religion with Greek legend are the vague and mystic speculations in which the later Romans indulged respecting the nature of the Penates. Some said they were the great gods to whom we owe breath, body, and reason, viz., Jupiter representing the middle ether, Juno the lowest air and the earth, and Minerva the highest ether, to whom some added Mercury as the god of speech (Servius, on *Æn.*, ii. 296; Macrobius, *Sat.*, iii. 4, 8; Arnobius, *Adv. Nat.*, iii. 40). Others identified them with Apollo and Neptune (Macrobius, iii. 4, 6; Arnobius, *l.c.*; Servius, on *Æn.*, iii. 119). The Etruscans held the Penates to be Ceres, Pales, and Fortuna, to whom others added Genius Jovialis (Servius, on *Æn.*, ii. 325; Arnobius, *l.c.*). The late writer Martianus Capella records the view that heaven was divided into sixteen regions, in the first of which were placed the Penates along with Jupiter, the Lares, &c. More fruitful than these misty speculations is the suggestion, made by the ancients themselves, that the worship of these family gods sprang from the ancient Roman custom (common to many savage tribes) of burying the dead in the house. But this would account for the worship of the Lares rather than of the Penates. A comparison with other primitive religious beliefs suggests the conjecture that the Penates may be a remnant of that fetichism or animism (i.e., the attribution of life, thought, and feeling to all objects animate and inanimate) in which many savage tribes exist to this day, and through which the higher races have probably passed at some period of their history, whether we suppose animism to be the primitive state of the human mind, or to be itself a development from the worship of ancestors, as Mr Herbert Spencer believes, or from some lower form of belief. The Roman *genii* seem certainly to have been fetiches, and the Penates were perhaps originally a species of *genii*. Thus the Penates, as simple gods of food, are probably much more ancient than deities like Jupiter, Neptune, Apollo, and Minerva, whose wide and varied attributes represent a power of abstraction and generalization in the minds of their worshippers such as is not possessed by very primitive men. With the Penates we may compare the kindly household gods of old Germany; they too had their home on the kitchen hearth and received offerings of food and clothing. In the castle of Hudemühlen (Hanover) there was a kobold for whom a cover was always set on the table. In Lapland each house had one or more spirits. The souls of the dead are regarded as house-spirits by the Russians; they are represented as dwarfs, and are served with food and drink. Each house in Servia has its patron-saint. In the mountains of Mysore every house has its bhuta or guardian deity, to whom prayer and sacrifices are offered. The Chinese god of the kitchen presents some curious analogies to the Penates: incense and candles are burnt before him on the first and fifteenth of the month; some families burn incense and candles before him daily; and on great festivals, one of which is at the winter solstice (nearly corresponding to the Saturnalia), he is served with cakes, pork, wine, incense, &c., which are placed on a table before him.

See Hartung, *Die Religion der Römer*; Hertzberg, *De diis Roman. patr.*; Pruller, *Röm. Mythol.*; Marquardt, *Röm. Staatsverwaltung*, vol. iii. For household gods of other peoples see Bastian, *Der Mensch in der Geschichte*, iii. p. 202 sq. (J. G. FR.)

PENCIL (Lat. *penicillus*, a small tail), a name originally applied to a small fine-pointed brush used in painting, and still employed to denote the finer camel's-hair and sable

brushes used by artists, has, in English, come commonly to signify solid cones or rods of various materials used for writing and drawing. Some method of producing black or coloured markings with rods of solid material on parchment, paper, wood, and other like smooth surfaces must have been known from time immemorial, but the ordinary so-called black-lead pencil does not possess a very high antiquity. It has been asserted that a manuscript of Theophilus, attributed to the 13th century, shows signs of having been ruled with a black-lead pencil; but the first distinct allusion to the common form of the instrument occurs in the treatise on fossils by Conrad Gesner of Zurich (1565), who describes an article for writing formed of wood and a piece of lead, or, as he believed, an artificial composition called by some *stimmis anglicanum* (English antimony). The famous Borrowdale mine in Cumberland having been discovered about that time, it is probable that we have here the first allusion to that great find of graphite which for so long supplied the world with its best lead pencils. While the supply of the Cumberland mine lasted, the material for the highly-esteemed English pencils consisted simply of the native graphite as taken from the mine. The pieces were sawn into thin veneers, which again were cut into the slender square rods forming the "lead" of the pencil. These leads were either cased in pencil cedar (the wood of the Virginian cedar, *Juniperus virginiana*), forming ordinary pencils, or they were, by an ingenious and delicate process of turning, in which ruby-cutters were used, rendered circular to supply the "ever-pointed pencils," which, however, are of comparatively modern origin.

Strenuous efforts were made on the Continent and in England to enable manufacturers to become independent of the product of the Cumberland mine. In Nuremberg, where the great pencil factory of the Faber family was established in 1761, pencils were made from pulverised graphite cemented into solid blocks by means of gums, resins, glue, sulphur, and other such substances, but none of these preparations yielded useful pencils. About the year 1795 Conté of Paris devised the process by which now all black-lead pencils, and indeed pencils of all sorts, are manufactured. In 1843 Mr Brockedon patented a process for compressing pure black-lead powder into solid compact blocks by which he was enabled to use the dust, fragments, and cuttings of fine Cumberland lead. He submitted the powdered substance to enormous pressure, and, by concurrently exhausting the air from the dies and the block of graphite in process of compression, he succeeded in forming a dense compact and uniform cake which could be treated in the same way as natural massive graphite from the mine. Brockedon's process would have proved successful and important had the supply of fine English black lead continued, but the exhaustion of the Borrowdale supplies and the excellence of Conté's process have rendered it more of scientific interest than of commercial value.

The pencil leads prepared by the Conté process consist of a most intimate mixture of graphite and clay, both first brought to a condition of the finest subdivision. The graphite is reduced to fine powder in a mortar; it is sifted and sometimes treated with mineral acid, to free it from iron, &c., then washed, and thereafter calcined at a bright-red heat. To get it in the condition of fine division, it is mixed with water and poured into a vat, where the heavier particles sink. From this vat the water bearing the lighter particles passes into another at a lower level, and so into one or two more, in each of which the comparatively heavy particles sink, and only the still finer particles are carried over. That which sinks in the last of the series is in a condition of extremely fine division, and is used for pencils of the highest quality. The clay, which must be free of sand and iron, is treated in the same manner, and brought to a state of great uniformity and smoothness. Clay and graphite so prepared are mixed in varying proportions from about equal parts to two of clay for one of graphite according as the pencils are to be hard or soft. They are thoroughly incorporated and ground together, then placed in bags and squeezed in a hydraulic press till

they have the consistency of stiff dough, in which condition they are ready for forming pencil rods. For this purpose the plastic mass is placed in a strong upright cylinder of brass, into which a plunger or piston works, moved by a powerful screw-press. The bottom of the cylinder consists of a thick bronze plate having in it a number of small apertures the section and size of the leads to be made. By the application of pressure to the plunger the graphite mixture is squeezed in continuous threads through the holes, and these threads are received and arranged in straight continuous lengths on a board, on which they are left to dry for some hours. For further drying by gentle heat they are placed in straight grooves in a grooved board, covered with another board, in which position they harden to stiff rods. These are afterwards cut into lengths for pencils, which are packed with charcoal in a covered crucible and submitted to a high furnace-heat. The two elements which regulate the comparative hardness and blackness of pencils are the proportions of graphite and clay in the leads and the heat to which they are raised in the crucible. According as the proportion of graphite is greater and the heat lower the pencil is softer and of deeper black streak.

The cedar in which pencils are cased is cut into two sets of rectangular slips of unequal thickness; but so that a thick and a thin slip put together form in section a square. In the thick or body piece is formed the groove or depression to receive the lead, which perfectly fits and fills it. The thinner covering piece is glued on and the pencil rounded between revolving cutters working at great speed. The cutters leave the rounded surface perfectly smooth, and it only remains to stamp the finished pencil with name and grade, &c. Very many pencils—but not usually good English qualities—are lacquered or varnished, and have the names, &c., stamped in gold letters.

Black pencils of an inferior quality are made from the dust of graphite melted up with sulphur and run into moulds. Such, with a little tallow added to give them softness, are the pencils commonly used by carpenters. Coloured pencils consist of a mixture of clay, with appropriate mineral colouring matter, wax, and tallow, treated by the Conté method as in making lead pencils. In the indelible and copying pencils which have come into use in recent years, the colouring matter is an aniline preparation mixed with clay and gum. The mixture not only makes a streak which adheres to the paper, but, when the writing is moistened with water, it dissolves and assumes the appearance and properties of an ink.

Nuremberg is the great centre of the pencil trade, possessing twenty-six factories which give employment to 5500 persons, the annual output of pencils numbering not less than 250 millions, of a value of upwards of £400,000. (J. PA.)

**PENDULUM.** See **CLOCKS**, vol. vi. p. 14, and **MECHANICS**, vol. xv. pp. 705, 718, 768.

**PENELOPE**, the faithful wife of the Greek hero Odysseus (Ulysses), immortalized by Homer in the *Odyssey*. She was the daughter of the Spartan Icarus and Periboea. Shortly before Odysseus left his native island of Ithaca to war against Troy, Penelope bore him a son, Telemachus. When her husband tarried long many chieftains of Ithaca and the islands round about wooed her to wife; they behaved wantonly, wasting the substance of Odysseus, insulting his son, and corrupting the maidservants. The heart of Penelope yearned for Odysseus, and, to rid herself of the importunities of the wooers, she bade them wait till she had woven a winding-sheet for old Laertes, the father of Odysseus. But every night she undid the piece which she had woven by day, so that the web was always unfinished. This she did for three years, till her maids revealed the secret to the wooers. Robbed of her pretext for delay she was in sore straits, till she was relieved by the arrival of Odysseus after an absence of twenty years. He slew the wooers, and the long-parted husband and wife were united once more.

Such is the story of Penelope in Homer. Later writers add other particulars about her. She was won by Odysseus in a race proposed by Icarus to his daughter's suitors. When Icarus would fain that Odysseus should bide with him in Sparta, or at least leave him his daughter, and Odysseus let Penelope choose whether she would go with him to Ithaca or stay with her father in Sparta, she silently drew her veil over her face. Her father understood her and let her go (Pausan., iii. 12, 30). Some said that she bore a son, Ptoleporthes, to Odysseus after his return from Troy. Others (marrying Homer's picture of her as a true and loving wife) said that in her husband's absence she bore Pan to Hermes or the suitors. Another story was that on his return Odysseus repudiated her as

unfaithful, that she went to Sparta and thence to Mantinea, where she died and where her tomb was shown (Pausan., viii. 12). According to others, after the death of Odysseus she married Telegonus (son of Odysseus and Circe) in *Æsea*, or in the Islands of the Blest. The name is connected with *πῆνος*, *πῆνη*, "wool," and hence means "weaver." The Homeric form is Penelopeia.

PENGUIN, the name (of very uncertain origin) of a flightless sea-bird,<sup>1</sup> but, so far as is known, first given to one inhabiting the seas of Newfoundland, as in Hore's "Voyage to Cape Breton," 1536 (Hackluyt, *Researches*, iii. pp. 168-170), which subsequently became known as the Great Auk or GARE-FOWL (vol. x. p. 78); and, though the French equivalent *Pingouin*<sup>2</sup> preserves its old application, at the present day, the word Penguin is by English ornithologists always used in a general sense for certain Birds inhabiting the Southern Ocean, called by the French *Manchots*, the *Spheniscids* of ornithologists, which in some respects form perhaps the most singular group of the whole Class, or at least we may say of the Carinate Subclass. For a long while their position was very much misunderstood, some of the best of recent or even living systematists having placed them in close company with the *Alcids* or Auks, to which they bear only a relationship of analogy, as indeed had been perceived by a few ornithologists, who recognized in the Penguins a very distinct Order, *Impennes*. The view of the latter is hardly likely to be disputed in future, now that the anatomical researches of MM. Paul Gervais and Alix (*Journ. de Zoologie*, 1877, pp. 424-470), M. Filhol (*Bull. Soc. Philomathique*, ser. 7, vi. pp. 226-248), and above all of Prof. Watson (*Zoology, Voy. Challenger*, part xviii.) have put the independent position of the *Spheniscids* in the clearest light.<sup>3</sup> The most conspicuous outward character presented by the Penguins is the total want of quills in their wings, which are as incapable of flexure as the flippers of a Cetacean, though they move freely at the shoulder-joint, and some at least of the species occasionally make use of them for progressing on land. In the water they are most efficient paddles, and are usually, if not always, worked alternately with a rotatory action. The plumage which clothes the whole body, leaving no bare spaces, generally consists of small scale-like feathers, many

of them consisting only of a simple shaft without the development of barbs; but several of the species have the head decorated with long cirrhus tufts, and in some the tail-quills, which are very numerous, are also long.<sup>4</sup> In standing these birds preserve an upright position, generally resting on the "tarsus"<sup>5</sup> alone, but in walking or running on land this is kept nearly vertical, and their weight is supported by the toes alone.

The most northerly limit of the Penguins' range in the Atlantic is Tristan d'Acunha, and in the Indian Ocean Amsterdam Island, but they also occur off the Cape of Good Hope and along the south coast of Australia, as well as on the south and east of New Zealand, while in the Pacific one species at least extends along the west coast of South America and to the Galapagos; but north of the equator none are found. In the breeding season they resort to the most desolate lands in higher southern latitudes, and indeed have been met with as far to the southward as navigators have penetrated. Possibly the Falkland Islands may be regarded as the locality richest in species,<sup>6</sup> though, whatever may have been the case once, their abundance there



King-Penguin (*Aptenodytes pennanti*).

as individuals does not now nearly approach what it is in many other places, owing doubtless to the ravages of man, whose advent is always accompanied by massacre and devastation on an enormous scale—the habit of the helpless birds, when breeding, to congregate by hundreds and thousands in what are called "Penguin-rookeries" contributing to the ease with which their slaughter can be effected. Incapable of escape by flight, they are yet able to make enough resistance or retaliation (for they bite powerfully

<sup>1</sup> Of the three derivations assigned to this name, the first is by Drayton in 1618 (*Polyolbion*, Song 9), where it is said to be the Welsh *pen gwyn*, or "white head"; the second, which seems to meet with Linnæus's approval, deduces it from the Latin *pinguis* (fat); the third supposes it to be a corruption of "pin-wing" (*Ann. Nat. History*, ser. 4, iv. p. 133), meaning a bird that has undergone the operation of pinioning or, as in one part at least of England it is commonly called, "pin-winging." In opposition to the first of these hypotheses it has been urged (1) that there is no real evidence of any Welsh discovery of the bird, (2) that it is very unlikely for the Welsh, if they did discover it, to have been able to pass on their name to English navigators, and (3) that it had not a white head, but only a patch of white thereon. To the second hypothesis Prof. Skeat (*Dictionary*, p. 433) objects that it "will not account for the suffix *-in*, and is therefore wrong; besides which the 'Dutchmen' [who were asserted to be the authors of the name] turn out to be Sir Francis Drake" and his men. In support of the third hypothesis Mr. Reeks wrote (*Zoologist*, ser. 2, p. 1854) that the people in Newfoundland who used to meet with this bird always pronounced its name "Pin wing." Prof. Skeat's inquiry (*loc. cit.*), whether the name may not after all be South-American, is to be answered in the negative, since, so far as evidence goes, it was given to the North-American bird before the South-American was known in Europe.

<sup>2</sup> *Gorfon* has also been used by some French writers, being a corruption of *Oeirfowl* or Gare-fowl.

<sup>3</sup> Though the present writer cannot wholly agree with the conclusions of the last of these investigators, his remarks (pp. 230-232) on the "Origin of the Penguins" are worthy of all attention. He considers that they are the surviving members of a group that branched off early from the primitive "avian" stem, but that at the time of their separation the stem had diverged so far from Reptiles as to possess true wings, though the metatarsal bones had not lost their distinctness and become fused into the single bone so characteristic of existing Birds. The ancestral Penguin, Prof. Watson argues, must have had functional wings, the muscles of which, through atrophy, have been converted into non-contractile tendinous bands.

<sup>4</sup> The pterylographical characters of the Penguins are well described by Mr. Hyatt (*Proc. Boston Soc. Nat. History*, 1871). Mr. Bartlett has observed (*Proc. Zool. Society*, 1879, pp. 6-9) that, instead of moulting in the way that birds ordinarily do, Penguins, at least in passing from the immature to the adult dress, cast off the short scale-like feathers from their wings in a manner that he compares to "the shedding of the skin in a serpent."

<sup>5</sup> The three metatarsals in the Penguins are not, as in other birds, united for the whole of their length, but only at the extremities, thus preserving a portion of their originally distinct existence, a fact probably attributable to arrest of development, since the researches of Prof. Gegenbaur show that the embryos of all birds, so far as is known, possess these bones in an independent condition. More recently Prof. Marsh has found that in the Dinosaurian genus *Ceratoceras* the metatarsals acquire a condition very similar to that which they present in the Penguins (*Am. Journ. Science*, Aug. 1884).

<sup>6</sup> An interesting account of the Penguins of these islands is given by Capt. Abbott (*Ibis*, 1860, p. 336).



when they get the chance) to excite the wrath of their murderers, and this only brings upon them greater destruction, so that the interest of nearly all the numerous accounts of these "rookies" is spoilt by the disgusting details of the brutal havoc perpetrated upon them.

The *Spheniscids* have been divided into at least eight genera, but three, or at most four, seem to be all that are needed, and three can be well distinguished, as pointed out by Dr Coues in the Philadelphia *Proceedings* for 1872 (pp. 170-212), by anatomical as well as by external characters. They are (1) *Aptenodytes*, easily recognized by its long and thin bill, slightly decurved, from which *Pygoscelis*, as Prof. Watson has shewn, is hardly distinguishable; (2) *Eudyptes*, in which the bill is much shorter and somewhat broad; and (3) *Spheniscus*, in which the shortish bill is compressed and the maxilla ends in a conspicuous hook. *Aptenodytes* contains the largest species, among them those known as the "Emperor" and "King" Penguins, *A. patagonica* and *A. longirostris*.<sup>1</sup> Three others belong also to this genus, if *Pygoscelis* be not recognized, but they seem not to require any particular remark. *Eudyptes*, containing the crested Penguins, known to sailors as "Rock-hoppers" or "Macaronis," would appear to have five species, and *Spheniscus* four, among which *S. mendiculus*, which occurs in the Galapagos, and therefore has the most northerly range of the whole group, alone needs notice here. The generic and specific distribution of the Penguins is the subject of an excellent essay by Prof. Alphonse Milne-Edwards in the *Annales des Sciences Naturelles* for 1880 (vol. ix. art. 9, pp. 23-81), of which there is a German translation in the *Mittheilungen* of the Ornithological Union of Vienna for 1883 (pp. 179-186, 210-222, 238-241). (A. N.)

PENN, WILLIAM (1644-1718), the Quaker, was the son of Admiral William Penn and Margaret Jasper, a Dutch lady, and was born at Tower Hill, London, on 14th October 1644. During his father's absence at sea he lived at Wanstead in Essex, and went to school at Chigwell close by, in which places he was brought under strong Puritan influences. Like many children of sensitive temperament, he had times of spiritual excitement; when about twelve he was "suddenly surprised with an inward comfort, and, as he thought, an external glory in the room, which gave rise to religious emotions, during which he had the strongest conviction of the being of a God, and that the soul of man was capable of enjoying communication with Him. He believed also that the seal of divinity had been put upon him at this moment, or that he had been awakened or called upon to a holy life." It would indeed have been unnatural if a mind so disposed had not, when the time came, seized with avidity upon the distinctive doctrine of the Friends, that of the "inward light."

Upon the death of Cromwell, Penn's father, who, like Monk, was purely an adventurer, and had served the Protector because there was no other career open, and who, according to Clarendon, had previously offered to bring over the fleet to Charles, remained with his family on the Irish estates which Cromwell had given him, of the value of £300 a year. On the deposition of Richard Cromwell he at once declared for the king and went to the court at Holland, where he was received into favour and knighted; and at the elections for the Convention Parliament he was returned for Weymouth. During these events young Penn studied under a private tutor on Tower Hill until, in October 1660, he was entered as a gentleman commoner at Christ Church. He appears in the same year to have contributed to the *Threnodia*, a collection of elegies on the death of the young duke of Gloucester.

<sup>1</sup> An example, presumably of the former species, weighing 78 lb, was, according to Dr McCormick (*Voyages of Discovery*, i. p. 269), obtained by the "Terror" in January 1842.

The rigour with which the Anglican statutes were revived, and the Puritan heads of colleges supplanted, roused the spirit of resistance at Oxford to the uttermost. With this spirit Penn, who was on familiar terms with John Owen, and who had already fallen under the influence of Thomas Loe the Quaker, then at Oxford, actively sympathized. He and others refused to attend chapel and church service, and were fined in consequence. So far did the young enthusiasts proceed in the expression of their hatred to the Anglican regulations that it is said they fell upon the students who were clothed in surplices and violently tore the hated vestments from them. How far his leaving the university resulted from this cannot be clearly ascertained. Anthony Wood has nothing regarding the cause of his leaving, but says that he stayed at Oxford for two years, and that he was noted for proficiency in many sports. There is no doubt that in January 1662 his father was anxious to remove him to Cambridge, and consulted Pepys on the subject; and in later years he speaks of being "banned" the college, and of being whipped, beaten, and turned out of doors on his return to his father, in the anger of the latter at his avowed Quakerism. A reconciliation, however, was effected; and Penn was sent to France to forget this folly. The plan was for a time successful. Penn appears to have entered more or less into the gaieties of the court of Louis XIV., and while there to have become acquainted with Robert Spencer, afterwards earl of Sunderland, and with Dorothy, sister to Algernon Sidney. What, however, is more certain is that he somewhat later placed himself under the tuition of Moses Amyraut, the celebrated president of the Protestant college of Saumur, and at that time the exponent of liberal Calvinism, from whom he gained the patristic knowledge which is so prominent in his controversial writings, and whose example, doubtless, stimulated the tolerant views he already entertained. He afterwards travelled in Italy, returning to England in August 1664, with "a great deal, if not too much, of the vanity of the French garb and affected manner of speech and gait."<sup>2</sup>

Until the outbreak of the plague Penn was a student of Lincoln's Inn. For a few days also he served on the staff of his father—now great captain commander—and was by him sent back in April 1665 to Charles with despatches. It will be observed that his letters to his father even at this time are couched in quaintly devout phraseology. Returning after the naval victory off Lowestoft in June, Admiral Penn found that, probably from the effect upon his mind of the awful visitation of the plague, his son had again become settled in seriousness and Quakerism. To bring him once more to views of life not inconsistent with court preferment, the admiral sent him in February 1666 with introductions to Ormonde's pure but brilliant court in Ireland, and to manage his estate in Cork round Shannagarry Castle, his title to which was disputed. Penn appears also later in the year to have been "clerk of the cheques" at Kinsale, of the castle and fort of which his father had the command. When the mutiny broke out in Carrickfergus Penn volunteered for service, and acted under Arras so as to gain considerable reputation. The result was that in May 1666 Ormonde offered him his father's company of foot, but, for some unexplained reason, the admiral demurred to this arrangement. It was at this time that the well-known portrait was painted of the great Quaker in a suit of armour; and, strangely enough, it was at this time, too, that the conversion, begun when he was a boy, according to Penn's own account, by Thomas Loe in Ireland, was completed at the same place by the same agency.<sup>3</sup>

On 3d September 1667 Penn attended a meeting of

<sup>2</sup> Pepys, 30th August 1664.

<sup>3</sup> Webb, *The Penns and Penningtons*, 1867, p. 174.



Quakers in Cork, at which he assisted to expel a soldier who had disturbed the meeting. He was in consequence, with others present, sent to prison by the magistrates. From prison he wrote to Lord Orrery, the president of Munster, a letter, in which he first publicly makes a claim for perfect freedom of conscience. He was immediately released, and at once returned to his father in London, with the distinctive marks of Quakerism strong upon him—the use of the “thee” and “thou,” and the refusal to remove his hat. So staunch on the hat question was he that he could not accept even the compromise suggested by his father, viz., that he should uncover before the king, the duke of York, and himself.

Penn now became a minister of the denomination, and at once entered upon controversy and authorship. His first book, *Truth Exalted*, in which he summons to trial princes, priests, and people, was “a short but sure testimony against all those religions, faiths, and worships that have been formed and followed in the darkness of apostasy,” and declared Quakerism to be “the alone good way of life and salvation.” Its tone and language were violent and aggressive in the extreme. The same offensive personality is shown in *The Guide Mistaken*, a tract written in answer to John Clapham’s *Guide to the True Religion*. It was at this time, too, that he appealed, not unsuccessfully, to Buckingham, who on Clarendon’s fall was posing as the protector of the Dissenters, to use his efforts to procure parliamentary toleration.

Penn’s first public discussion was with Thomas Vincent, a London Presbyterian minister, who had reflected on the “damnable” doctrines of the Quakers. In this he appears to have acted as second to George Whitehead.<sup>1</sup> The discussion, which had turned chiefly upon the doctrine of the Trinity, ended uselessly, and Penn at once published *The Sandy Foundation Shaken*, a tract of ability sufficient to excite Pepys’s astonishment, in which orthodox views on the Trinity, plenary satisfaction, imputed righteousness, and other doctrinal points were so offensively attacked that, at the instance of the bishop of London, Penn was placed in the Tower, where he remained for nearly nine months. The imputations upon his opinions and good citizenship, made as well by Dissenters as by the church, he repelled in *Innocency with her Open Face*, in which he asserts his full belief in the divinity of Christ, the atonement, and justification through faith, though insisting on the necessity of good works. It was now, too, that he published the most important of his books, *No Cross, no Crown*, which, besides the lessons of constancy and resignation indicated by the title, contained an able defence of the Quaker doctrines and practices, and a scathing attack on the evils of the age, especially the loose and unchristian lives of the clergy.

While completely refusing to recant or to yield to the persuasions of Stillingfleet, who, it is stated on doubtful authority, was sent to argue with him, Penn addressed a letter to Arlington in July 1669, in which, on grounds of religious freedom, he asked him to interfere. It is noteworthy, as showing the views then predominant, that he was almost at once set at liberty.

An informal reconciliation now took place with his father, who had been impeached through the jealousy of Rupert and Monk (in April 1668), and whose conduct in the operations of 1666 he had publicly vindicated; and Penn was again sent on family business to Ireland. There is good reason for thinking that the extent of the differences between him and his father have been much exaggerated.<sup>2</sup> While there he regularly attended Quaker meetings, and was active in intercession for imprisoned Friends. At the desire of his father, whose health was fast failing, Penn

returned to London in 1670, and was immediately involved in fresh trouble. Having found the usual place of meeting in Gracechurch Street closed by soldiers, Penn, as a protest, preached to the people in the open street. With William Mead he was at once arrested and indicted at the Old Bailey on 1st September for preaching to an unlawful, seditious, and riotous assembly, which had met together with force and arms. The Conventicle Act not touching their case, the trial which followed, and which may be read at length in Penn’s *People’s Ancient and Just Liberties Asserted*, was a notable one in the history of trial by jury. The prisoners and the jury were alike brow-beaten and threatened by the bench, and particularly by the recorder. With extreme courage and skill Penn exposed the illegality of the prosecution, while the jury, for the first time, asserted the right of juries to decide in opposition to the ruling of the court. They brought in a verdict declaring Penn and Mead “guilty of speaking in Gracechurch Street,” but refused to add “to an unlawful assembly”; then, as the pressure upon them increased, and as they were sent back time after time without food, light, fire, or tobacco, they first acquitted Mead, while returning their original verdict upon Penn, and then, when that verdict was not admitted, returned their final answer “not guilty” for both. The court fined the jurymen 40 marks each for their contumacy, and, in default of payment, imprisoned them, whereupon they vindicated and established for ever the right they had claimed in an action before the Court of Common Pleas, when all twelve judges unanimously declared their imprisonment illegal.

Penn himself had been fined for not removing his hat in court, had been imprisoned on his refusal to pay, and had earnestly requested his family not to pay for him. The fine, however, was settled anonymously, and he was released in time to be present at his father’s death on 16th September 1670, at the early age of forty-nine. Penn now found himself in possession of a fortune of £1500 a year, and a claim on the crown for £15,000, lent to Charles II. by his father. The admiral appears, from a later statement of Penn, to have asked the king and James to become his son’s protectors, and James accepted and acted up to the engagement in a special manner. Upon his release Penn at once plunged into controversy, challenging a Baptist minister named Ives, at High Wycombe, to a public dispute and, according to the Quaker account, easily defeating him. No account is forthcoming from the other side. Hearing at Oxford that students who attended Friends’ meetings were rigorously used, he wrote a vehement and abusive remonstrance to the vice-chancellor in defence of religious freedom. This found still more remarkable expression in the *Seasonable Caveat against Popery* (January 1671), in which, while refuting the arguments of Roman Catholics, he urges, far in advance of his age and of all other sects, entire and unlimited toleration of faith and worship,—not, be it observed, on the grounds of expediency or of Scripture, but upon the distinctively Quaker doctrine of the “inward light.”

In the beginning of 1671 Penn was again arrested for preaching in Wheeler Street meeting-house by Sir J. Robinson, the lieutenant of the Tower, formerly lord mayor, and known as a brutal and bigoted churchman. Legal proof being wanting of any breach of the Conventicle Act, and the Oxford or Five Mile Act also proving inapplicable, Robinson, who had some special cause of enmity against Penn, urged upon him the oath of allegiance. This, of course, the Quaker would not take, and consequently was imprisoned for six months. A saying is recorded of Penn on this occasion worthy of remembrance. Robinson had ordered a corporal and some soldiers to take him to prison. “No, no,” said Penn, “send thy lacquey. I know the way

<sup>1</sup> Sewal’s *Hist. of Friends*, p. 172.

<sup>2</sup> Granville’s *Memoirs of Sir W. Penn*, vol. ii. p. 571.

to Newgate." During this imprisonment Penn wrote several works, the most important being *The Great Case of Liberty of Conscience* (February 1671), a noble defence of complete toleration. Upon his release he started upon a missionary journey through Holland and Germany; at Emden he founded a Quaker Society, and established an intimate friendship with the princess palatine Elizabeth. In his letters written during this journey will be found a full exposition of the doctrine of the "inward light."

Upon his return home in the spring of 1672 Penn married Gulielma Springett, daughter of Mary Pennington by her first husband, Sir William Springett; she appears to have been equally remarkable for beauty, devotion to her husband, and firmness to the religious principles which she had adopted when little more than a child.<sup>1</sup> He now settled at Rickmansworth in Hertfordshire, and gave himself up to controversial writing. To this year, 1672, belong the *Treatise on Oaths and England's Present Interest Considered*, in the latter of which, written immediately after the withdrawal of the Declaration of Indulgence, is contained an able statement of the arguments against comprehension and for toleration. It should not be omitted by any one who desires to understand the state of feeling on the subject. In the year 1673 Penn was still more active. He secured the release of George Fox, addressed the Quakers in Holland and Germany, carried on public controversies with Hicks, a Baptist, and Faldo, an Independent, and published his treatise on the *Christian Quaker and his Divine Testimony Vindicated, the Discourse of the General Rule of Faith and Practice*,<sup>2</sup> *Reasons against Railing* (in answer to Hicks), *Counterfeit Christianity Detected*, and a *Just Rebuke to One-and-twenty Learned Divines* (an answer to Faldo and to *Quakerism no Christianity*). His last public controversy was in 1675 with Richard Baxter, in which, of course, each party claimed the victory. During this year his active sympathies were enlisted on behalf of imprisoned Quakers at Aberdeen. At this point Penn's connexion with America begins.

The province of New Jersey, comprising the country between the Hudson and Delaware rivers on the east and west, had been granted in March 1663-64 by Charles II. to his brother; James in turn had in June of the same year leased it to Lord Berkeley and Sir G. Carteret in equal shares. By a deed, dated 18th March 1673/74, John Fenwick, a Quaker, bought one of the shares, that of Lord Berkeley (Stoughton erroneously says Carteret's) in trust for Edward Byllinge, also a Friend, for £1000. This sale was confirmed by James, after the second Dutch war, on 6th August 1680. Disputes having arisen between Fenwick and Byllinge, Penn acted as arbitrator; and then, Byllinge being in money difficulties, and being compelled to sell his interest in order to satisfy his creditors, Penn was added, at their request, to two of themselves, as trustee. The disputes were settled by Fenwick receiving ten out of the hundred parts into which the province was divided,<sup>3</sup> with a considerable sum of money, the remaining ninety parts being afterwards put up for sale. Fenwick sold his ten parts to two other Friends, Eldridge and Warner, who thus, with Penn and the other two, became masters of West Jersey, West New Jersey, or New West Jersey, as it was indifferently called.<sup>4</sup> The five proprietors appointed three commissioners, with instructions dated from London 6th August 1676, to settle disputes with Fenwick (who

had bought fresh land from the Indians, upon which Salem was built, Penn being himself one of the settlers there) and to purchase new territories. to survey and divide them, and to build a town,—New Beverley, or Burlington, being the result. For the new colony Penn drew up a constitution, under the title of "Concessions," which he himself thus describes: "There we lay a foundation for after ages to understand their liberty as men and Christians, that they may not be brought in bondage but by their own consent; for we put the power in the people." The greatest care is taken to make this constitution "as near as may be conveniently to the primitive, ancient, and fundamental laws of the nation of England." But a democratic element is introduced, and the new principle of perfect religious freedom—"that no men, nor numbers of men upon earth, hath power or authority to rule over men's consciences in religious matters"—stands in the first place (chap. xvi.). With regard to the liberty of the subject, no one might be condemned in life, liberty, or estate, except by a jury of twelve, and the right of challenging was granted to the uttermost (chap. xvii.). Imprisonment for debt was not abolished (as Dixon states), but was reduced to a minimum (chap. xviii.), while theft was punished by twofold restitution either in value or in labour to that amount (chap. xxviii.). The provisions of chap. xix., taking their rise doubtless in Penn's own trial at the Old Bailey in 1670, deserve special notice. All causes were to go before three justices, with a jury. "They, the said justices, shall pronounce such judgment as they shall receive from, and be directed by the said twelve men, in whom only the judgment resides, and not otherwise. And in case of their neglect and refusal, that then one of the twelve, by consent of the rest, pronounce their own judgment as the justices should have done." The justices and constables, moreover, were elected by the people, the former for two years only (chap. xli.). Suitors might plead in person, and the courts were public (chap. xxii.). Questions between Indians and settlers were to be arranged by a mixed jury (chap. xxv.).

An assembly was to meet yearly, consisting of a hundred persons, chosen by the inhabitants, freeholders, and proprietors, one for each division of the province. The election was to be by ballot, and each member was to receive a shilling a day from his division, "that thereby he may be known to be the servant of the people." The executive power was to be in the hands of ten commissioners<sup>5</sup> chosen by the assembly. Such a constitution, which is in marked contrast with Locke's aristocratic one for Carolina, settled eight years previously, soon attracted large numbers of Quakers to West Jersey.

It was shortly before these occurrences that Penn inherited through his wife the estate of Worminghurst in Sussex, whither he removed from Rickmansworth. He now (25th July 1677) undertook a second missionary journey to the Continent along with George Fox, Robert Barclay, and George Keith. Of this journey a full account, published seventeen years later, will be found in his selected works. He visited particularly Rotterdam and all the Holland towns, renewed his intimacy with the princess Elizabeth at Herwerden, and, under considerable privations, travelled through Hanover, Germany, the lower Rhine, and the electorate of Brandenburg, returning by Bremen and the Hague. It is worthy of recollection that the American settlers from Kirchheim, one of the places which responded in an especial degree to Penn's teaching, are noted as the first who declared it unlawful for Christians to hold slaves. Penn reached England again on 24th October.

<sup>1</sup> For a very charming account of her, and the whole Pennington connexion, see Maria Webb's *The Penns and Penningtons*.

<sup>2</sup> See on this Stoughton's *Penn*, p. 113.

<sup>3</sup> The deed by which Fenwick and Byllinge conveyed New West Jersey to Penn, Gawry, and Nicholas is dated 10th February 1674/75.

<sup>4</sup> The line of partition was "from the east side of Little Egg Harbour, straight north, through the country, to the utmost branch of Delaware river."

<sup>5</sup> Penn's letter of 26th August 1676 says twelve, and Clarkson has followed it; but the Concessions, which were not assented to by the inhabitants until 3d March 1676/77, say ten.

His attention was at once taken up both with the disputes which had arisen within the Quaker body itself on questions of discipline, and still more with an endeavour to secure some decent measure of toleration for the Friends. He tried to gain the insertion in the Bill for the relief of Protestant Dissenters of a clause enabling Friends to affirm instead of taking the oath, and twice addressed the House of Commons' committee with considerable eloquence and effect. The Bill, however, fell to the ground at the sudden prorogation.

In 1678 the Popish Terror came to a head, and to calm and guide Friends in the prevailing excitement Penn wrote his *Epistle to the Children of Light in this Generation*. A far more important publication was *An Address to Protestants of all Persuasions*, by William Penn, Protestant, in 1679. In the first part of this work he inveighs against the five crying evils of the time so far as they are "under the correction of the civil magistrates," with an address to the magistrates for redress of those evils; the second part deals similarly with "the five capital evils that relate to the ecclesiastical state of these kingdoms"; the whole work is a powerful exposition of the doctrine of pure toleration and a protest against the enforcement of opinions as articles of faith. This was succeeded, at the general election which followed the dissolution of the pensionary parliament, by an important political manifesto, *England's Great Interest in the Choice of this New Parliament*, in which he insisted on the following points:—the discovery and punishment of the plot, the impeachment of corrupt ministers and councillors, the punishment of "pensioners," the enactment of frequent parliaments, security from Popery and slavery, and ease for Protestant Dissenters. Next came *One Project for the Good of England*, perhaps the most pungent of all his political writings. A single sentence will show the homely style of illustration which Penn usually adopted. "But since the industry, rents, and taxes of the Dissenters are as current as their neighbours', who loses by such narrowness more than England, than the Government, and the magistracy? . . . Till it be the interest of the former to destroy his flock, to starve the horse he rides and the cow that gives him milk, it cannot be the interest of England to let a great part of her sober and useful inhabitants be destroyed for things that concern another world." But he was not merely active with his pen. He was at this time in close intimacy with Algernon Sidney, who stood successively for Guildford and Bamber. In each case, owing in a great degree to Penn's eager advocacy, Sidney was elected, only to have his elections annulled by court influence. Toleration for Dissenters seemed as far off as ever. The future of English politics must have appeared to Penn well-nigh hopeless. Encouraged by his success in the New Jersey provinces, he again turned his thoughts to America. In repayment of the debt mentioned above Penn now asked from the crown, at a council held on 24th June 1680, for "a tract of land in America north of Maryland, bounded on the east by the Delaware, on the west limited as Maryland [i.e., by New Jersey], northward as far as plantable"; this latter limit Penn explained to be "three degrees northwards." This formed a tract 300 miles by 160, of extreme fertility, mineral wealth, and richness of all kinds. Disputes with James, and with Lord Baltimore, who had rights over Maryland, delayed the matter until 24th March 1681, when the grant received the royal signature, and Penn was made master of the province of Pennsylvania. His own account of the name is that he suggested "Sylvania," that the king added the "Penn" in honour of his father, and that, although he strenuously objected and even tried to bribe the secretaries, he could not get the name altered. It should be added that early in 1682 Carteret, grandson of the original pro-

prietor, transferred his rights in East Jersey to Penn and eleven associates, who soon afterwards conveyed one-half of their interest to the earl of Perth and eleven others. It is uncertain to what extent Penn retained his interest in West and East Jersey, and when it ceased. The two provinces were united under one government in 1699, and Penn was a proprietor in 1700. In 1702 the government of New Jersey was surrendered to the crown.

By the charter for Pennsylvania Penn was made proprietary of the province. He was supreme governor; he had the power of making laws with the advice, assent, and approbation of the freemen, of appointing officers, and of granting pardons. The laws were to contain nothing contrary to English law with a saving to the crown and the English council in the case of appeals. Parliament was to be supreme in all questions of trade and commerce; the right to levy taxes and customs was reserved to England; an agent to represent Penn was to reside in London; neglect on the part of Penn was to lead to the passing of the government to the crown (which event actually took place in 1692); no correspondence might be carried on with countries at war with Great Britain. A clause added at the last moment illustrates curiously both the strength and the jealousy of the Anglican Church at the time. The impertunity of the bishop of London extorted the right to appoint Anglican ministers, should twenty members of the colony desire it, thus securing the very thing which Penn was anxious to avoid,—the recognition of the principle of an establishment.

Having appointed Colonel Markham, his cousin, as deputy, and having in October sent out three commissioners to manage affairs until his arrival, Penn proceeded to draw up proposals to adventurers, with an account of the resources of the colony. He negotiated, too, with James and Lord Baltimore with the view, ultimately successful, of freeing the mouth of the Delaware, wrote to the Indians in conciliatory terms, and encouraged the formation of companies to work the infant colony both in England and Germany, especially the "Free Society of Traders in Pennsylvania," to whom he sold 20,000 acres, absolutely refusing, however, to grant any monopolies. In July he drew up a body of "conditions and concessions." This constitution, savouring strongly of Harrington's *Oceana*, was framed in consultation with Sidney, though to what extent is doubtful. The inferences drawn by Hepworth Dixon from a single letter of Penn to Sidney, given at length by Stoughton, are quite unjustifiable. This sketch of a constitution was democratical in the purest sense. Until the council of seventy-two (chosen by universal suffrage every three years, twenty-four retiring each year) and the assembly (chosen annually) were duly elected, a body of provisional laws was added.

It was in the midst of this extreme activity that Penn was made a Fellow of the Royal Society. Leaving his family behind him, Penn sailed with a hundred comrades from Deal in the "Welcome" on 1st September 1682. His *Last Farewell to England* and his letter to his wife and children contain a beautiful expression of his pious and manly nature. He landed at Newcastle on the Delaware on 27th October, his company having lost one-third of their number by smallpox during the voyage. After receiving formal possession, and having visited New York, Penn ascended the Delaware to the Swedish settlement of Upland, to which he gave the name of Chester. The assembly at once met, and on the 7th December passed the "Great Law of Pennsylvania." The idea which informs this law is that Pennsylvania was to be a Christian state on a Quaker model. Only one condition is made necessary for office or citizenship, viz., Christianity. The constitution is purely democratic; all offices, for example, are elective. In many other provisions Penn showed him-

self far in advance of his time, but in none so much as where the penalty of death was abolished for all offences except murder. Lawsuits were to be superseded by arbitration, always a favourite idea with Penn. Philadelphia was now founded, and within two years contained 300 houses and a population of 2500. At the same time an Act was passed, uniting under the same government the territories which had been granted by feoffment by James in 1682. Realistic and entirely imaginative accounts (cf. Dixon, p. 270), inspired chiefly by Benjamin West's picture, have been given of the treaty which there seems no doubt Penn actually made in November 1682 with the Indians. His connexion with them was one of the most successful parts of his management, and he gained at once and retained through life their intense affection. At his death they sent to his widow a message of sorrow for the loss of their "brother Onas," with some-choice skins to form a cloak which might protect her "while passing through the thorny wilderness without her guide."

Penn now wrote an account of Pennsylvania from his own observation for the "Free Society of Traders," in which he shows considerable power of artistic description.

Tales of violent persecution of the Quakers, and the necessity of settling disputes which had arisen with Lord Baltimore, his neighbour in Maryland, brought Penn back to England (2d October 1684) after an absence of two years. In the spring of 1683 he had modified the original charter at the desire of the assembly, but without at all altering its democratic character.<sup>1</sup> He was, in reference to this alteration, charged with selfish and deceitful dealing by the assembly. Within five months after his arrival in England Charles II. died, and Penn found himself at once in a position of great influence. His close connexion with James, dating from the death of his father, was rendered doubly strong by the fact that, from different causes, each was sincerely anxious to establish complete liberty of conscience. Even before his coronation James had told Penn that "he desired not that peaceable men should be disturbed for their religion." Penn now took up his abode at Kensington in Holland House, so as to be near the court. His influence there was great enough to secure the pardon of John Locke, who had been dismissed from Oxford by Charles, and of 1200 Quakers who were in prison. At this time, too, he was busy with his pen once more, writing a further account of Pennsylvania, a pamphlet in defence of Buckingham's essay in favour of toleration, in which he is supposed to have had some share, and his *Persuasive to Moderation to Dissenting Christians*, very similar in tone to the *One Project for the Good of England*. When Monmouth's rebellion was suppressed he appears to have done his best to mitigate the horrors of the western commission, opposing Jeffreys to the uttermost;<sup>2</sup> and he stood by Cornish and Elizabeth Gaunt at their executions. He says himself in a letter dated 2d October 1685, "About 300 hanged in divers towns in the West, about 1000 to be transported. I begged twenty of the king."

Macaulay, the grotesqueness of whose blunders on this matter is equalled only by the animus that inspired them, and by the disingenuousness with which he defended them, has accused Penn of being concerned in some of the worst actions of the court at this time. His complete refutation by Forster, Paget, Dixon, and others renders it unnecessary to do more than allude to the cases of the Maids of Taunton, Alderman Kiffin, and Magdalen College (Oxford).

In 1686, when making a third missionary journey to Holland and Germany, Penn was charged by James with an informal mission to the prince of Orange to endeavour to gain his assent to the removal of religious tests. Here

he met Burnet, from whom, as from the prince, he gained no satisfaction, and who greatly disliked him. On his return he went on a preaching mission through England. His position with James was undoubtedly a compromising one, and it is not strange that, wishing to tolerate Papists, he should, in the prevailing temper of England, be once more accused of being a Jesuit, while he was in constant antagonism to their body. Even Tillotson took up this view strongly, though he at once accepted Penn's vehement disavowal. It was in reference to this that Penn wrote one of his pithy sentences: "I abhor two principles in religion, and pity them that own them; the first is obedience upon authority without conviction; and the other, destroying them that differ from me for God's sake. Such a religion is without judgment, though not without teeth."

In 1687 James published the Declaration of Indulgence, and Penn probably drew up the address of thanks on the part of the Quakers. It fully reflects his views, which are further ably put in the pamphlet *Good Advice to the Church of England, Roman Catholics, and Protestant Dissenters*, in which he showed the wisdom and duty of repealing the Test Acts and Penal Laws.

At the Revolution he behaved with courage. He was one of the few friends of the king who remained in London, and, when twice summoned before the council, spoke boldly in his behalf. He admitted that James had asked him to come to him in France; but at the same time he asserted his perfect loyalty. During the absence of William in 1690 he was proclaimed by Mary as a dangerous person, but no evidence of treason was forthcoming. It was now that he lost by death two of his dearest friends, Robert Barclay and George Fox. It was at the funeral of the latter that, upon the information of the notorious informer Fuller, an attempt was made to arrest him, but he had just left the ground; the fact that no further steps were then taken shows how little the Government believed in his guilt. He now lived in retirement in London, though his address was perfectly well known to his friends in the council. In 1691, again on Fuller's evidence, a proclamation was issued for the arrest of Penn and two others as being concerned in Preston's plot. He might, on the intercession of Locke, have obtained a pardon, but refused to do so. He appears to have especially felt the suspicions that fell upon him from the members of his own body. In 1692 he began to write again, both on questions of Quaker discipline and in defence of the sect. *Just Measures in an Epistle of Peace and Love, The New Athenians* (in reply to the attacks of the *Athenian Mercury*), and *A Key opening the Way to every Capacity* are the principal publications of this year.

Meantime matters had been going badly in Pennsylvania. Penn had, in 1687, been obliged to make changes in the composition of the executive body, though in 1689 it reverted to the original constitution; the legislative bodies had quarrelled; and Penn could not gain his rents. He was closely concerned also in this year with a dispute between East and West Jersey regarding the dividing line, in which he espoused the cause of the former (and richer) province. The chief difficulty, however, in Pennsylvania was the dispute between the province—i.e., the country given to Penn by the charter—and the "territories," or the lands granted to him by the duke of York by feoffment in August 1682, which were under the same Government but had differing interests. No sooner had Penn by a skilful compromise settled this matter than the colony was torn by the religious schism caused by George Keith. The difficulties which Quaker principles placed in the way of arming the colony—a matter of grave importance in the existing European complications—fought most hardly against Penn's power. On 21st October 1692 an order of

<sup>1</sup> Dixon, p. 276.

<sup>2</sup> Burnet, iii. 66; Dalrymple, i. 282.

council was issued depriving Penn of the governorship of Pennsylvania, and giving it to Colonel Fletcher, the governor of New York.<sup>1</sup> To this blow were added the illness of his wife and a fresh accusation of treasonable correspondence with James. In his enforced retirement he wrote the most devotional and the most charming of his works,—the collection of maxims of conduct and religion entitled *The Fruits of Solitude*. In December, thanks to the efforts of his friends at court, among whom were Buckingham, Somers, Rochester, and Henry Sidney, he received an intimation that no further steps would be taken against him. The accusation, however, had been public, and he insisted on the withdrawal being as public. He was therefore heard in full council before the king, and honourably acquitted of all charge of treason. It was now that he wrote an *Essay towards the Present and Future Peace of Europe*, in which he puts forth the idea of a great court of arbitration, a principle which he had already carried out in Pennsylvania.

In 1694 (23d February) his wife Gulielma died, leaving two sons, Springett and William, and a daughter Letitia, afterwards married to William Aubrey. Two other daughters, Mary and Hannah, died in infancy. He consoled himself by writing his *Account of the Rise and Progress of the People called Quakers*. The coldness and suspicion with which he had been regarded by his own denomination had now ceased, and he was once more regarded by the Quaker body as their leader. About the same time (20th August) he was restored to the governorship of Pennsylvania; and he promised to supply money and men for the defence of the frontiers. In 1695 he went on another preaching mission in the west, and sent a petition to parliament praying that affirmations might be substituted for oaths. This year and the next were busily occupied with preaching and writing, one of his auditors being no less a person than Peter the Great. In March 1696 he formed a second marriage, with Hannah Callowhill, his son Springett dying five weeks later. In this year he wrote his work *On Primitive Christianity*, in which he argues that the faith and practice of the Friends were those of the early church. In 1697 Penn removed to Bristol, and during the greater part of 1698 was preaching with great success against oppression in Ireland, whither he had gone to look after the property at Shannangarry.

In 1699 he was back in Pennsylvania, landing near Chester on 30th November, where the success of Colonel Quarry, judge of the admiralty in Pennsylvania, who was in the interests of those who wished to make the province an imperial colony, and the high-handed action of the deputy Markham in opposition to the crown, were causing great difficulties. Penn carried with him particular instructions to put down piracy, which the objections of the Quakers to the use of force had rendered audacious, and concerning which Quarry had made strong representations to the home Government, while Markham and the inhabitants apparently encouraged it. Penn and Quarry, however, came at once to a satisfactory understanding on this matter, and the illegal traffic was vigorously and successfully attacked. The next question he took up was slavery, and his attitude towards it is curious. In 1696 the Philadelphian yearly meeting had passed a resolution declaring it contrary to the first principles of the gospel. Penn, however, did not venture upon emancipation; but he insisted on the instruction of negroes, permission for them to marry,

repression of polygamy and adultery, and proposed regulations for their trial and punishment. The assembly, however, a very mixed body of all nations, now refused to accept any of these proposals except the last-named.

His great success was with the Indians; by their treaty with him in 1700 they promised not to help any enemy of England, to traffic only with those approved by the governor, and to sell furs or skins to none but inhabitants of the province. At the same time he showed his capacity for legislation by the share he took with Lord Bellomont at New York in the consolidation of the laws in use in the various parts of America.

Affairs now again demanded his presence in England. The king had in 1701 written to urge upon the Pennsylvania Government a union with other private colonies for defence, and had asked for money for fortifications. The difficulty felt by the crown in this matter was a natural one. A Bill was brought into the Lords to convert private into crown colonies. Penn's son appeared before the committee of the House and managed to delay the matter until his father's return. On 15th September Penn called the assembly together, in which the differences between the province and the territories again broke out. He succeeded, however, in calming them, appointed a council of ten to manage the province in his absence, and gave municipal institutions to Philadelphia. In May 1700, experience having shown that alterations in the charter were advisable, the assembly had, almost unanimously, requested Penn to revise it. On 28th October 1701 he handed it back to them in the form in which it afterwards remained. An assembly was to be chosen yearly, of four persons from each county, with all the self-governing privileges of the English House of Commons. Two-thirds were to form a quorum. The nomination of sheriffs, coroners, and magistrates for each county was given to the governor, who was to select from names handed in by the freemen. Moreover, the council was no longer elected by the people, but nominated by the governor, who was thus practically left single in the executive. The assembly, however, who, by the first charter, had not the right to propound laws, but might only amend or reject them, now acquired that privilege. In other respects the original charter remained, and the inviolability of conscience was again emphatically asserted. Penn reached England in December 1701. The accession of Anne appears to have put an end to the Bill in the Lords, and to his troubles on this score. He once more assumed the position of leader of the Dissenters and himself read the address of thanks for the promise from the throne to maintain the Act of Toleration. He now too took up his abode again at Kensington, and published while here his *More Fruits of Solitude*.

In 1703 he went to Knightbridge, where he remained until 1706, when he removed to Brentford, his final residence being taken up in 1710 at Field Ruscombe, near Twyford. In 1704 he wrote his *Life of Bulstrode Whitelocke*. He had now much trouble from America. The territorialists were openly rejecting his authority, and doing their best to obstruct all business in the assembly; and matters were further embarrassed by the injudicious conduct of Governor Evans in 1706. Moreover, pecuniary troubles came heavily upon him, while the conduct of his son William, who became the ringleader of all the dissolute characters in Philadelphia, was another and still more severe trial. This son was married, and had a son and daughter, but appears to have been left entirely out of account in the settlement of Penn's proprietary rights on his death.

Whatever were Penn's great qualities, he was deficient in judgment of character. This was especially shown in the choice of his steward Ford, from whom he had borrowed money, and who, by dexterous swindling, had managed, at the time of his death, to establish a claim for £14,000

<sup>1</sup> Colonel Fletcher's commission recites "that by reason of great neglect and miscarriage in the government of Pennsylvania Her Majesty found it necessary to take the government into her hands and under her immediate protection." The attorney-general and the solicitor-general were of opinion (on 12th July 1694) that, when the aforesaid reasons failed or ceased, the right of government belonged to the petitioner.

against Penn. Penn, however, refused to pay, and spent nine months in the Fleet rather than give way. He was released at length by his friends, who paid £7500 in composition of all claims. Difficulties with his government of Pennsylvania continued to harass him. Fresh disputes took place with Lord Baltimore, the owner of Maryland, and Penn also felt deeply what seemed to him the ungrateful treatment which he met with at the hands of the assembly. He therefore in 1710 wrote, in earnest and affectionate language, an address to his "old friends," setting forth his wrongs. So great was the effect which this produced that the assembly which met in October of that year was entirely in his interests; revenues were properly paid; the disaffected were silenced and complaints were hushed; while an advance in moral sense was shown by the fact that a Bill was passed prohibiting the importation of negroes. This, however, when submitted to the British parliament, was cancelled. Penn now, in February 1712, being in failing health, proposed to surrender his powers to the crown. He appears, from Dixon's work (p. 413), to have offered previously, just before he was arrested by the Fords, to give up his government for £20,000, but with stipulations which rendered the crown unwilling to take it. On the present occasion the commission of plantations recommended that Penn should receive £12,000 in four years from the time of surrender, Penn stipulating only that the queen should take the Quakers under her protection; and £1000 was given him in part payment. Before, however, the matter could go further he was seized with apoplectic fits, which shattered his understanding and memory. A second attack occurred in 1713, and from that time until his death his powers gradually failed, although at times his intellect was clear and vigorous. He died on 30th May 1718, leaving three sons by his second wife, John, Thomas, and Richard, and was buried along with his first and second wives at Jourdan's meeting-house, near Chalfont St Giles in Buckinghamshire. It has finally to be mentioned that in 1790 the proprietary rights of Penn's descendants were bought up for a pension of £4000 a year to the eldest male descendant by his second wife, and that this pension was commuted in 1884 for the sum of £87,000. (O. A.)

PENNANT, THOMAS (1726-1798), naturalist and antiquary, was descended from an old Welsh family, who for many generations had resided at Downing, Flintshire, where he was born 14th June 1726. He received his early education at Wrexham and Fulham, and afterwards attended Queen's and Oriel Colleges, Oxford, but did not take a degree. At twelve years of age he was inspired with a passion for natural history through obtaining a present of Willughby's *Ornithology*; and a tour in Cornwall in 1746-47 after leaving Oxford awakened his strong interest in minerals and fossils. In 1750 his account of an earthquake which he felt at Downing was inserted in the *Philosophical Transactions*, where there also appeared in 1756 a paper on several coralloid bodies he had collected at Coalbrook Dale, Shropshire. In the following year, at the instance of Linnæus, he was elected a member of the Royal Society of Upsala. In 1766 he published a folio volume entitled *British Zoology*. The work is meritorious rather as a laborious compilation than as an original contribution to science, but that it served a good purpose is evidenced by the number of editions (see ORNITHOLOGY, p. 9 above) through which it passed. During its progress he visited the Continent and made the acquaintance of Buffon, Voltaire, Haller, and Pallas. In 1771 was published his *Synopsis of Quadrupeds*, afterwards extended into a *History of Quadrupeds*. At the end of the same year he published *A Tour in Scotland in 1769*, which proving remarkably popular was followed in 1774 by an

account of another journey in Scotland published in two volumes, afterwards distinguished as the second and third *Tour*. In these works he manifested the rare faculty of investing with interest details of antiquarian lore, while they have also proved invaluable as preserving the record of important antiquarian relics which have now perished. In 1778 he brought out a similar *Tour in Wales*, which was followed by a *Journey to Snowdon* (part i. 1781, part ii. 1783), afterwards forming the second volume of the *Tour*. In 1783 he published a *Journey from Chester to London*. He brought out *Arctic Zoology* in 1785-87. In 1790 appeared his *Account of London*, which has gone through a large number of editions, and has justly been termed "the most popular book ever written on the subject." Three years later he published the *Literary Life of the late T. Pennant, written by himself*. In his later years he was engaged on a work entitled *Outlines of the Globe*, vols. i. and ii. of which appeared in 1798, and vols. iii. and iv., edited by his son David Pennant, in 1800. He was also the author of a number of minor works, some of which were published posthumously. He died at Downing 16th December 1798. Pennant was in 1767 elected a member of the Royal Society, and he was a member of many other learned societies, both home and foreign. In 1771 he received the degree of D.C.L. from the university of Oxford.

PENNI, GIANFRANCESCO (1488-1528), Italian painter, surnamed "Il Fattore," from the relation in which he stood to Raphael, whose favourite disciple he was after Giulio Romano, was a native of Florence, but spent the latter years of his life in Naples. He painted in oil as well as in fresco, but is chiefly known for his work in the Loggia of the Vatican.

PENNSYLVANIA, one of the original thirteen States of the North American Union, lying between 39° 43' and 42° 15' N. lat., and between 74° 40' and 80° 36' W. long., is 160 miles wide, and more than 300 miles long from east to west. Its northern, southern, and western border-lines were meant to be straight; the eastern follows the course of the Delaware river. It is bounded by the States of New York and New Jersey on the N. and E., by Ohio on the W., and by Delaware, Maryland, and West Virginia on the S. At its north-west corner a small triangular addition gives it a shore-line of 40 miles, with one good harbour, on Lake Erie. At its south-eastern corner, a circle of 10 miles radius (struck from the court-house at Newcastle) throws a small area into the State of Delaware. Its surface, subdivided into sixty-seven counties, measures nearly 28,800,000 acres or 45,000 square miles; less than one-half of its acreage is in cultivated farms, and only 1,000,000 of the people live in separate farm-houses. Out of a population of 4,283,000, nearly 2,000,000 lived in towns and cities in 1880, and more than 2,000,000 in country hamlets or factory villages, at iron mines and furnaces, at coal-mines and coke-ovens, at lumber-camps and oil-wells, or along the many lines of canal and railroad which traverse the State in all directions.

*Physical Features.*—Pennsylvania is topographically divisible into three parts: a south-east district, the open country between the South Mountains and the sea; a middle belt of parallel valleys separated by low parallel mountain-ridges; and a northern and western upland, behind the escarpment of the Alleghany Mountain. One and a half millions of its people inhabit the fertile and highly-cultivated south-eastern triangle, which is nowhere more than 600 or 700 feet above the level of the sea. One million inhabit the middle belt of higher-lying valleys, rich in iron ore and anthracite coal. One and a half millions occupy the great bituminous coal and oil regions of the northern and western counties, elevated from 1000 to 2500 feet above the sea,



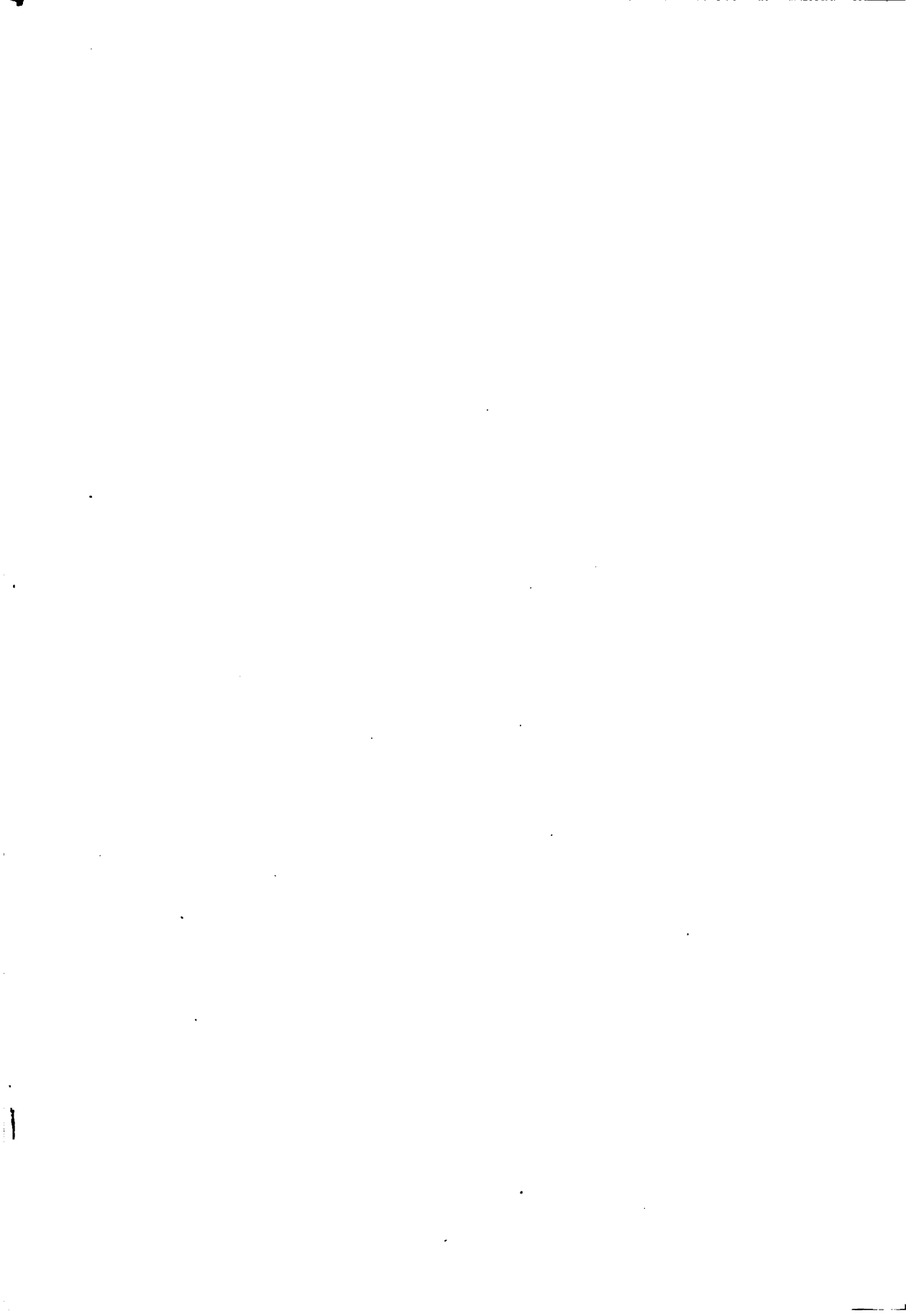



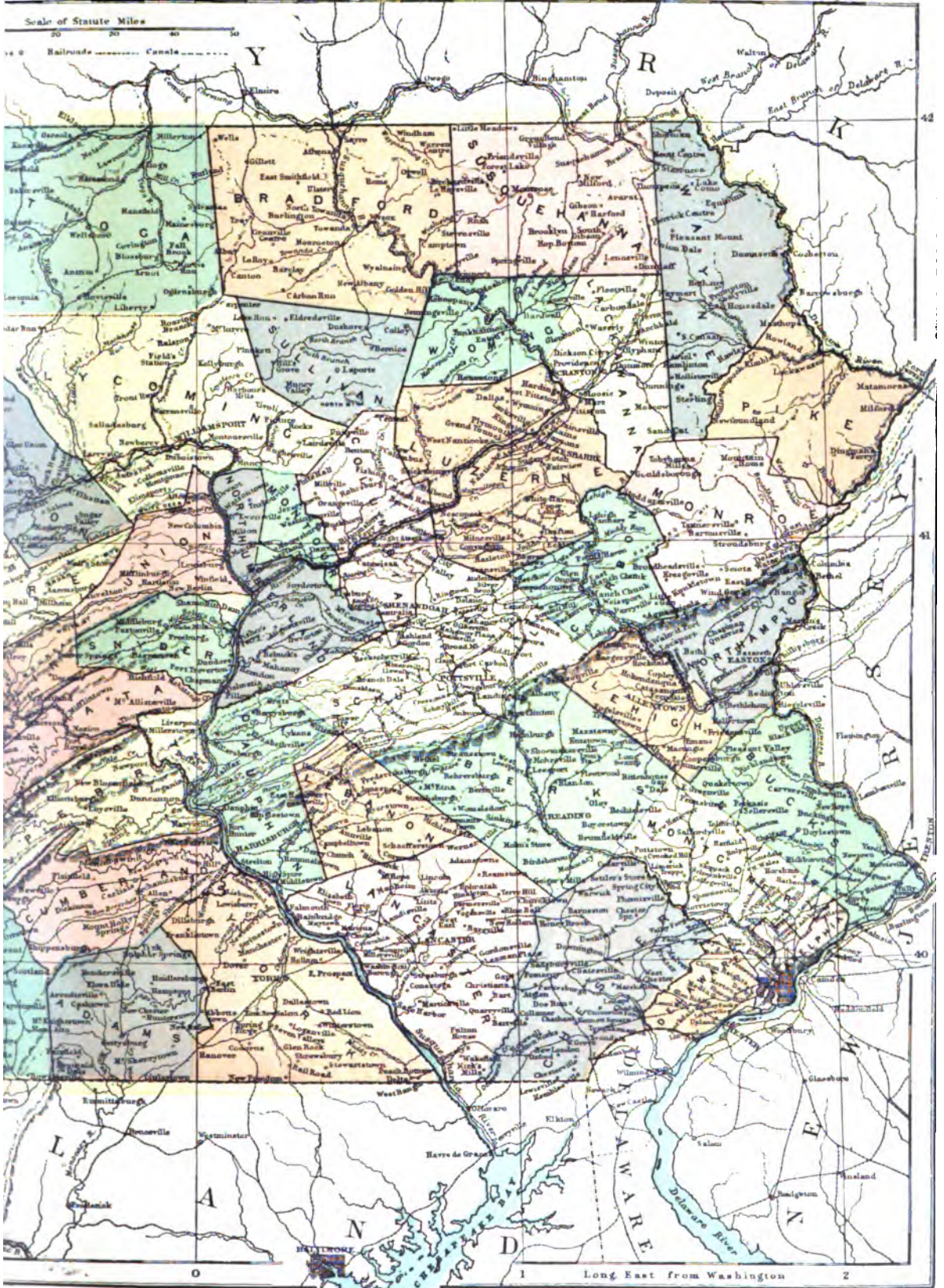

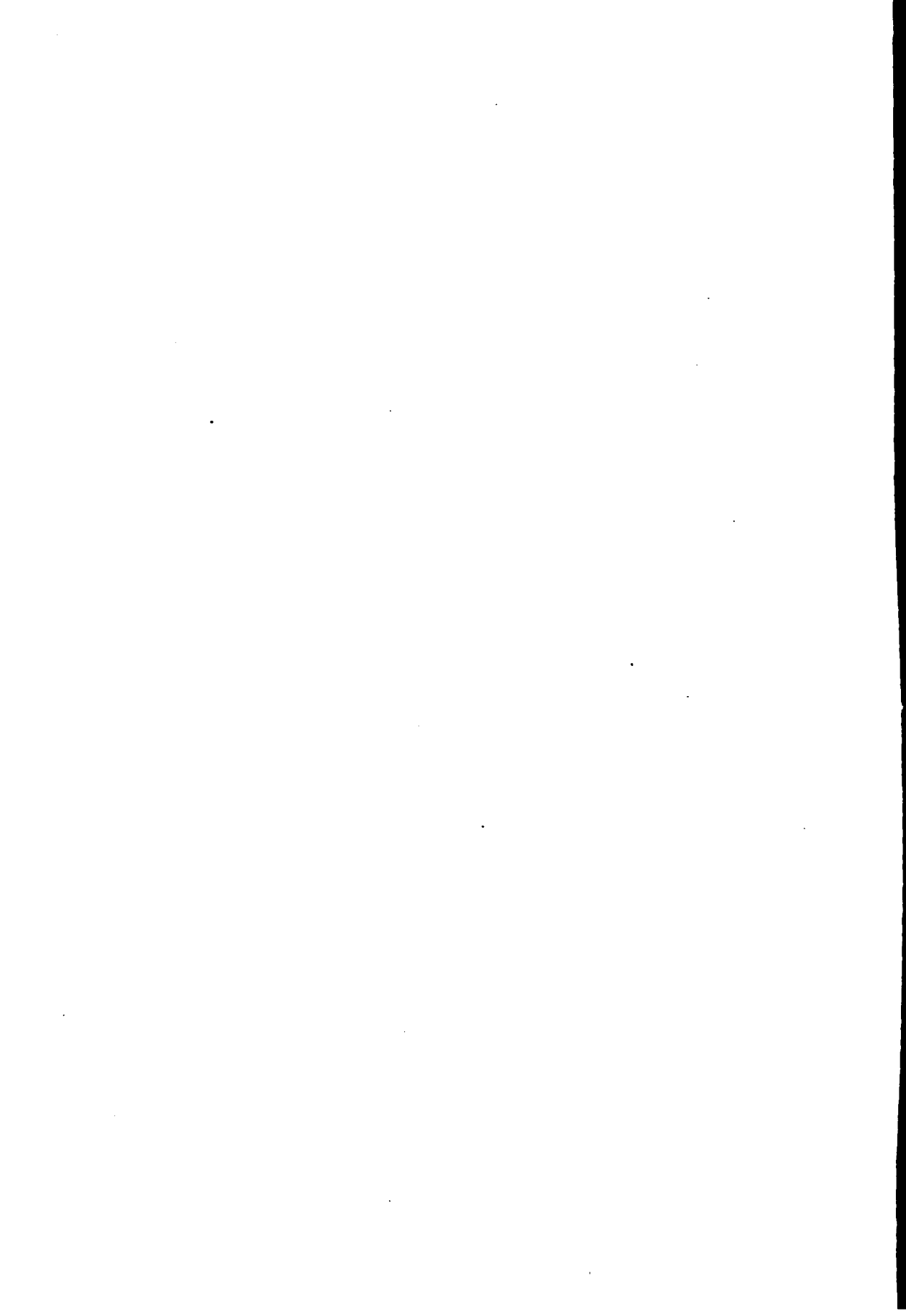



which constitute at least one-half of the State, and drain, not eastward into the Atlantic, but northward into the St Lawrence and westward into the Mississippi.

The valleys of the middle belt are of two characters, distinguished by the farming population of the Atlantic States as "rich valleys" and "poor valleys." The former, whether large or small, are completely enclosed and comparatively level arenas of limestone land, surrounded by rocky and wooded barriers, less than 1000 feet high, through narrow gaps in which streams enter or issue. A curiously sculptured slate-terrace, half the height of the encircling mountain, overlooks each of these secluded valleys. Their entire limestone floor has been under cultivation for a century, and the best iron-ore deposits of the State and its oldest mines are situated in them. They are gardens of fertility, yielding heavy crops of wheat, rye, and maize to the frugal, thrifty, and laborious descendants of their early settlers. Innumerable caverns ramify beneath the surface; sink-holes receive the drainage of the fields; many of the water-courses appear and disappear beneath sunken arches of limestone; and wells are the chief source of supply. Old orchards and great planted trees abound, and more picturesque landscapes cannot be found. Nittany, the largest of these isolated valleys, occupies the centre of the State. It is 60 miles long, but its greatest width is only 10 miles; and it is subdivided at its north-eastern end by long projecting mountain-spurs into narrow parallel coves, each of which is known by a special name, Brush valley, Penn's valley, &c. Sinking Spring valley is at its south-western end, and here it is traversed by the Little Juniata river, along the banks of which runs the Pennsylvania Railroad. A narrow valley, called Canoe valley, leads southward into Morrison's cove, which is half as large as Nittany valley. The next largest limestone valley is Kishicoquillus, 40 miles long by 5 miles wide, ending southward in a point, and split at its north-east end into three. German Amiah (Mennonite sect) and Scotch-Irish Presbyterian settlers, separated by an ideal cross line, have made this valley famous for its loveliness and wealth. Farther south is M'Connell's cove, west of this Friend's cove, and still farther west Millikin's cove. Two little oval holes in the mountains north-east of Nittany valley, Nippenose valley and Oval valley, and two long slit-like depressions in Tuscarora and Black Log Mountains conclude the short list of these remarkable limestone threshing-floors of Pennsylvania.

Across the whole State, however, stretches the Great Valley in a wide and gentle curve from east to south, one-half its surface covered with the soil of the terrace-slate, the other half with the same limestone soil which causes the exceptional fertility of the isolated valleys above enumerated. This very remarkable feature of the Atlantic side of the continent extends in an unbroken line for nearly 1000 miles, from eastern Canada to the lowlands of the Gulf of Mexico, only 150 miles of its length being in Pennsylvania, where its average width may be called 15 miles. Everywhere on its north-west side rises a sharp and regularly level-crested ridge, about 1000 feet high, heavily timbered. On its other or southern side a range of irregular mountain-land completely secludes the Great Valley from the seaboard, except for about 50 miles in Pennsylvania. This mountain-range is known in Vermont as the Green Mountains, in Massachusetts as the Taconic Mountains, in New York and New Jersey as the Highlands, in Pennsylvania and Maryland as the South Mountains, in Virginia as the Blue Ridge, in North Carolina as the Unaka or Smoky Mountains. In their northern extension they rise to heights of 3000 and 4000 feet; in the southern States they have summits from 4000 to 7000 feet above the sea. In Pennsylvania few parts of the range exceed 1500 feet; and at the broken

gap of 50 miles already mentioned the Great Valley limestone land protrudes southward through the interrupted range, to make of Lancaster the richest agricultural county in the State. Before the era of railways Lancaster county made the markets of Philadelphia the cheapest and most luxurious in the world. It was on this exceptional out-spread of the Great Valley limestone that the Germans of the first immigration settled. The limestone plain of Lancaster spreads west across the Susquehanna river into York county, and east into Berks and Chester counties to within 20 miles of Philadelphia. The whole plain swarms with life; the houses are small, but the stone barns are of colossal size, 100 and even 150 feet long and from 30 to 50 feet high, the barnyard-wall supported on ranges of heavy columns, while on the other side of the building an earthen slope ascends to the great barn door.

The eight counties which lie along the face of the South Mountains, in the south-eastern region of the State, are in the highest state of cultivation, and resemble the most picturesque rural districts of England,—a country of rolling hills and gently sloping vales, with occasional rocky dells of no great depth, and low cascades utilized for grist-mills, factories, and machine shops; a country of wheat, rye, maize, potatoes, tobacco, turnip-fields, orchards, meadows, and patches of woodland; a country of flowing water, salubrious, fertile, and wealthy; dotted with hamlets, villages, and towns, and with the country-seats of affluent citizens. But the region as a whole is divisible into at least four districts, differing as much in population as in soil and situation. The counties of York and Adams, lying west of the Susquehanna river along the Maryland line, are inhabited by Germans, who for the most part still use the patois of their fatherland, mixed with English words and phrases. The counties of Montgomery and Bucks, lying between the Schuylkill and Delaware rivers, have a mingled population of the descendants of Germans, Quakers, and French Huguenots. The hilly district of northern Chester is also partly German. Southern Lancaster, southern Chester, and Delaware counties support the most intelligent and virtuous population in the State, largely composed of the descendants of Penn's colonists, who have mostly escaped the narrowing and enervating influences of the city, and enjoy the mental and physical activity, the simplicity of manners, and the loyalty to truth, justice, and charity which characterized the Quakers at the origin of the sect in England. The district which they inhabit is a veritable fairyland, and its principal town, Westchester, has been for a long time one of the notable centres of scientific life in the State.

*Climate.*—The climate of so great a State is necessarily various, and is made more variable by its situation on the eastern side of the continent facing the Gulf Stream. The north-west wind is dry and cold in winter, the south-west wind always mild and rainy, and the south-east ocean wind wet and sultry in summer; but the dreaded north-easters of New England lose much of their rigour by the time they reach the Delaware. The northern highlands of the State are buried under 4 or 5 feet of snow four months of the year. The southern middle counties enjoy genial weather the whole year round, interrupted only by a few short intervals of intense heat or cold, never lasting more than three consecutive days. The midland valleys are very hot in midsummer and very cold in mid-winter, the thermometer ranging between 0° and 100°, with a not unfrequent sudden fall after a sultry week of 30° or 40° in a few hours, ending with thunderstorms, and followed by dry, clear, cool weather, with winds from the north-west. The climate of the south-western counties is comparatively dry and equable, but with a sufficient annual rainfall, and plenty of snow in winter, productive of great river-floods

in spring. The average annual rainfall ranges from 36 inches in the western counties to 42 inches at Philadelphia. Destructive "freshets" descend the eastern rivers when the ice breaks up; for the Delaware and Susquehanna rivers are almost every year frozen over from tide-water to their sources; thunderstorms happen in the midst of winter; the January thaw is always to be apprehended; and when heavy rains break up the ice and it accumulates in the gaps of the mountains, the main river-channels become scenes of inevitable disaster. In 1837 the valley of the Lehigh was swept clean for 60 miles, the dams and locks of the canal were all destroyed, and every bridge and mill disappeared. Along the lower Susquehanna the floating ice has often been piled upon the railroad embankment to the height of several yards. Even in midsummer a heavier downpour than usual in 1836 carried destruction through the valley of the Juniata. But the affluents of the Ohio river in the western part of the State are subject every year to this danger.

*Geology.*—For unknown geological reasons Pennsylvania is peculiar for exhibiting the Paleozoic system in its

maximum development, that is, from the Permian formation down to the base of Murchison's Lower Silurian, with a total thickness of more than 40,000 feet at the eastern outcrops, diminishing to half that amount in the western counties. As all the formations are thrown into great anticlinal and synclinal folds, and cut through transversely by the rivers, they can be measured along numerous continuous and conformable section lines. Near Harrisburg, at Pottsville, and at Mauch Chunk the Carboniferous, Devonian, and Upper Silurian rocks, standing vertical, show a cross section 5 miles thick. At the Delaware and Lehigh water-gaps the Lower Silurian slates are 6000 feet thick. In Canoe valley the underlying Lower Silurian limestones have been measured 6500 feet thick. In the south-western corner of the State about 1000 feet of Permian rocks overlie the Coal-measures proper. Thus the following Paleozoic column can be studied with peculiar advantages in Pennsylvania, many of its more important stages either becoming greatly attenuated or wholly disappearing when followed into the neighbouring States of New York, Ohio, and Virginia.

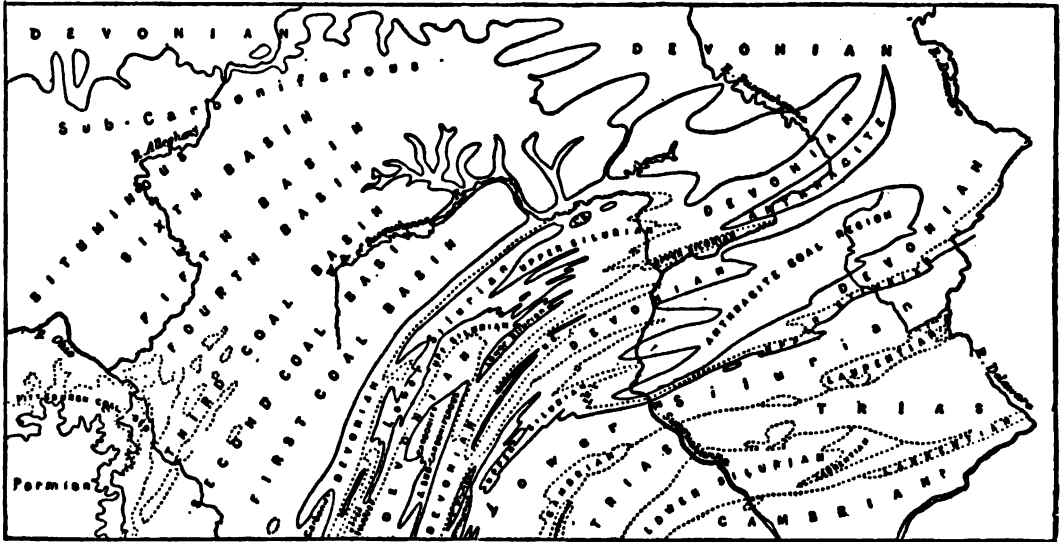

Geological Map of Pennsylvania.

- |     |   |                         |
|-----|---|-------------------------|
| 13. | Permian, or Upper Carboniferous.        |                         |
|     | Upper productive Coal-measures          |                         |
|     | Barron measures                         | } Middle Carboniferous. |
| 12. | Lower productive Coal-measures          |                         |
| 11. | Pottsville conglomerate                 | } Lower Carboniferous.  |
| 10. | Mauch Chunk red shale                   |                         |
| 9.  | Pocono grey sandstone                   | } Middle Devonian.      |
| 8.  | Catskill red sandstone; Upper Devonian. |                         |
| 7.  | Chemung and Portage shales              | } Lower Devonian.       |
| 6.  | Tennessee, Hamilton, and Marcellus      |                         |
| 5.  | Upper Helderberg limestone              | } Upper Silurian.       |
| 4.  | Oriskany sandstone.                     |                         |
| 3.  | Lower Helderberg limestones             | } Lower Silurian.       |
| 2.  | Clinton shales                          |                         |
| 1.  | Medina and Onondaga sandstones          |                         |
|     | Hudson river and Utica slates           |                         |
|     | Trenton and Great Valley limestones     |                         |
|     | Potadom sandstone.                      |                         |

The geology of south-eastern Pennsylvania is not understood. There can be no doubt that the copper-bearing porphyritic Huronian system is well represented in the South Mountains, south of the Chambersburg fault, on the borders of Maryland; but the systematic age of the gneisses, mica schists, garnetiferous schists, serpentine and chrome iron rocks, of the Philadelphia belt, commencing at Trenton,

crossing the Schuylkill river on a section line 15 miles wide, and extending through Delaware and Chester counties into Maryland, is still under discussion, some geologists considering them of pre-Cambrian age and others regarding them as metamorphosed Silurian rocks. They contain minute quantities of gold and are evidently a prolongation of the great gold-bearing belt of Virginia and the Carolinas.

*Minerals.*—The mineral resources of Pennsylvania have never been exaggerated except by those who compare its iron-mines with those of other States. It possesses a virtual monopoly of anthracite. The output of rock-oil is still amazing. The bituminous, coking, and block coal district is only one large part of an enormous area which includes eastern Ohio, West Virginia, middle Tennessee, and northern Alabama; and the ranges of iron-ores extend through New Jersey and New York into New England and Canada, and through Maryland, Virginia, North Carolina, and eastern Tennessee into Alabama, with no sensible difference of quantity or quality in either direction. But Pennsylvania has the advantage over other States of a first plant, both in iron-works and coal-mines, and in a consequent multiplication and concentration of capital for these industries, which must keep her *facile princeps* in this respect for a long time to come. Sooner or later she must take a second rank in iron, but never in coal and coke. It is possible that the oil-fields of the three States to the south and west of her may become as productive as her own, although no signs of such an event are visible yet to geologists; but no contingency of events can affect her absolute control of the anthracite market.



Three anthracite coal-regions in eastern Pennsylvania are recognized by railroad men, coal-dealers, and statisticians; but they do not exactly correspond to the three anthracite coal-fields of the geological survey reports. (1) By the Schuylkill region is meant all the surface of coal-land which is drained by that river, with two small additions from the upper water-basins of the Shamokin and Swatara rivers, affluents of the Susquehanna. In 1822 it supplied the Philadelphia market with 1480 tons of coal; in 1880 it distributed, in all directions along the lines of the Reading Railroad, 9,500,000 tons. (2) By the Lehigh region is meant all the coal-lands on that river, furnishing in 1821 1673 tons, and in 1882 5,700,000, chiefly to the city of New York. (3) By the Wyoming region is meant the isolated valley of the Susquehanna (north branch) and Lackawanna rivers, commencing its shipments in 1829 with 7000, and sending in 1882 14,000,000 tons of coal eastward, northward, and westward, to Boston, Montreal, and Chicago. In 1888 these three regions shipped a total of 31,800,000 tons.

The three anthracite coal-fields into which the region divides itself geologically—the southern, the middle, and the northern—are three groups of narrow parallel basins filled with crumpled Coal-measures. Each field has a characteristic grouping of its basins different from the other two: the southern in perfectly straight lines, except at its western end, which has a long fork or fish-tail; the middle in échelon; the northern in a long sweeping curve from west by east to north. The southern field has for its southern border a sharp low mountain-ridge, 62 miles long, bearing about N. by 60° E., and ending abruptly westward near the Susquehanna river and eastward at the Lehigh river. It is gapped in four places, by the Swatara, by the Schuylkill, and by its two principal branches, giving passage to three railways and two canals, one of which has been abandoned and the other is little used. In this mountain the lower Coal-measures descend vertically to a depth of 3000 feet below tide-level, and then rise again in a series of waves to the top of a much higher mountain which borders the field upon the north. From the top of this broad mountain the Coal-measures have been swept away. They are next seen descending steeply northward into the middle field, where they sink to various depths of 1000 or 2000 feet below sea-level, rolling six times so as to make that number of mining basins, and then rise into the air, along a bounding mountain at the northern edge of the field, not to descend again to the present surface of the earth for 40 miles. Only the lowest beds, however, appear there in narrow strips upon the highest plateau of the State, and not as anthracite, but as bituminous coal. This description, however, only applies to the western division of the middle field. Its eastern division has a very different character. On the broad rolling top of the Beaver Meadow Mountains, west of the Lehigh river, lie a group of closely-folded parallel troughs, in which the coal-beds descend steeply to depths of 1000 or 2000 feet, and rapidly rise again to the surface, each trough being pointed at both ends and disappearing on the summits of mountain-spurs, which look down upon deeply-indented red-shale valleys. The collieries of this eastern division of the middle field are all on very high land, from 1600 to 1800 feet above the sea; and branch railroads descend from them by steep gradients to the two rival main lines, which follow the banks of the Lehigh and Delaware rivers to the Atlantic coast.

The northern field corresponds exactly to the Wyoming region. It is a moon-shaped trough, 50 miles long by 6 miles wide, tapering to a point both ways. Its eastern half is drained by the Lackawanna river westward into the Susquehanna river, where the latter breaks through the northern mountain-wall and begins to meander westward through the Kingston flats in the centre of the coal-field made famous by the incidents of Indian warfare. A few miles farther on the river breaks half through the northern wall, splitting it lengthwise, and then cuts off the western point of the basin, leaving a little patch of it capping the isolated spur. This magnificent coal-field is traversed diagonally by anticlinal and synclinal folds in the Coal-measures in such a manner as to subdivide it into more than thirty small coal-basins, all connected underground, the deepest of which hold more than 8000 feet of Coal-measures; so that in a hilltop near Wilkesbarre fossil-shells of the Permian formation, the uppermost division of the Carboniferous system, have been collected.

Until the maps of the anthracite section of the State Geological Survey have been completed, the area of anthracite coal-land in all three fields cannot be accurately stated. The total number of coal-beds cannot be stated, because some are hardly noticeable; others are composed of several layers separated elsewhere by 50 or 100 feet of intervening rock. The identification of the beds across the intervals which separate the fields, and even from colliery to colliery, is not in all cases satisfactory. It may, however, be said generally that the whole column of Coal-measures contains more than a hundred coal-beds. Less than one-fourth of these have hitherto been considered of desirable size and quality for mining. Most of the output in past years and at present comes from five or six of them, from the Lykens valley bed, from the Buck Mountain bed, especially from the Mammoth bed—all of

them white ash—and from two or three red ash beds next higher in the series. The first quantities of coal which were sent to the market came from an open quarry on the summit of the mountain at Mouch Chunk, where the Mammoth bed is 60 feet thick. In subsequent years a long range of extensive collieries were created on the Mine Hill slope of the bed behind Pottsville. Later still the Mahanoy and Shenandoah collieries were established behind the Broad Mountain. From early years the great bed was worked in the Wyoming region by the Baltimore Company. Other corporations have extensively exploited it throughout the valley. Old mines in this bed are worked on a great scale also at Hazelton and Beaver Meadow, and later plants were made at Jeaneville, Clifton, and elsewhere. A choice though smaller bed, called the Buck Mountain vein, extends through all three fields, and is largely mined in many places, sometimes in tunnel-connection with the Mammoth and sometimes alone. The Lykens valley bed, holding 10 and 12 feet of exceedingly choice coal, lies near the bottom of the Millstone grit (the base of the Coal-measures), but is scarcely workable anywhere except at the western end of the southern field.

The waste in mining anthracite coal is enormous, although it has been somewhat diminished by the concentration of most of the coal-properties under the control of a few railway companies, who employ competent engineers and superintendents. But the markets demand the delivery of the coal in sizes. Iron furnaces alone accept the run of the mine. The "breaker," an anthracite invention, and a monster of destruction, is an edifice of wood and iron 100 feet high, furnished with slopes and lifts to take the mine-cars to the top, with rollers set with teeth to crush the larger lumps, with bolting screens to separate the sizes, with picking banks and boys to throw out slate descending the shoots, and with bays or pockets from which the coal is drawn at will to fill railway trains passing underneath. The waste is carted off to a neighbouring hillside. Hills of this "dust," 100 feet high and hundreds of feet long, encumber the country, and awaken the anxiety of proprietors respecting its future disposal. All plans for utilizing it cheaply on a large scale have as yet failed, and no serious change in the situation can take place until the supply in the earth begins to fail. The time for that is distant. The annual output can reach 50,000,000 tons, and, in spite of the waste, can continue at that figure for three centuries. An exact calculation of solid contents in the ground, of waste in mining and breaking, and of quantity sent to market has been made for only one division of one field.

At the eastern end of the southern field, for instance, six beds, as yet locally worked by only thirteen collieries (four of them now abandoned), contained originally 1,032,000,000 tons, of which only 54,000,000 have been extracted (between 1820 and 1882), leaving 979,000,000 tons still untouched. The output in 1820 was less than 400 tons, that of 1849 nearly 400,000 tons, that of 1882 838,000. In a few years it will reach 2,000,000, and might continue at that rate five centuries.

The number of working collieries in the anthracite region is constantly changing. The list for 1881-82, reported by the official mine inspectors, numbers 141 in the northern bed, 51 in the eastern middle, 91 in the western middle, and 70 in the southern field, 353 collieries in all. The fuel they send to market is both white coal from the lower and red-ash coal from the higher beds of the series, the market sizes being designated egg, stove, chestnut, pea, and buckwheat. By sampling carefully the contents of five cars from one colliery carrying each a different size of coal, and analysing the samples, it was found that, while there was little difference in the percentage of water (say 1.7), of sulphur (say 0.7), and of volatile matter (say 4.0), the percentage of ash regularly increased as the size diminished (egg 5.662, stove 10.174, chestnut 12.666, pea 14.664, buckwheat 16.620), showing the finer breakage of the slaty layers, and the mixture of slate-dust with the smaller sizes of coal. The percentage of solid carbon, of course, diminished directly with the size, from 88.5 in egg-coal to 76.9 in buckwheat. The coal-dust of the heaps about the mines, before alluded to, is, therefore, no doubt, still lower in solid carbon; yet Captain Wooten's dust-burning locomotives on the Reading Railroad have been a success; and the dust or "brass" of the Philadelphia coal-yards is sold for use in fire-boxes of suitable construction.

The bituminous coal-region of Pennsylvania covers the western third of the State, the greatest thickness of Coal-measures being in the south-western corner. Six wide parallel basins sweep round from the boundary-line with New York State south-westward into Ohio and West Virginia. The summit of the Alleghany Mountain, containing the lowest coals, limits the region towards the south-east; an irregular line parallel with and 30 miles distant from the shore of Lake Erie limits it on the north-west. The basins all gradually deepen going south-west, and are all subdivided into smaller local basins by gentle rolls. In one or two neighbourhoods the coal-beds dip as much as 30°; but over almost the entire area they are so nearly horizontal that a dip of 2° or 3° is exceptionally great. Over thousands of square miles they lie as flat as geological formations can ever lie, considering the accidents of original deposi-

tion in the quiet Carboniferous sea. There is a striking uniformity in the composition of the whole formation, which is naturally divisible into: (1) upper (Permian) barren-measures; (2) upper (Pittsburgh) productive Coal-measures; (3) lower barren-measures; (4) lower productive Coal-measures; (5) Millstone grit (Pottsville conglomerate); (6) Mauch Chunk shale and mountain limestones; (7) Pocono sandstone and lowest (worthless) coal-beds. These rest on more than 10,000 feet of Devonian rocks.

The area of the State actually covered by one or more workable bituminous coal-beds is about 9000 square miles. Dr H. M. Chance's calculation of area, thickness, content, &c. (in a paper read before the Am. Inst. Min. Eng., October 1881), is the most trustworthy yet made. He assumes sixteen important coal-beds, none workable over the whole area of thirty-one counties,—only the lowest beds being preserved in ten, and the principal upper beds only in seven of these counties. Beds less than 2 feet thick are ignored. Beds from 2 to 3 feet thick are estimated only from outcrop down to water-level; beds from 3 to 5, to 150 feet below water-level; beds over 5, to 400 feet below water-level. Allowing 1650 gross tons per foot to the acre (less 11 per cent. for slate, bone, and sulphur partings, say 1500 gross tons) the mass of beds over 6 feet is 11,000,000,000 tons; of beds between 6 and 3 feet, 19,500,000,000; and of beds under 3 feet, 3,000,000,000,—making a total of 33,500,000,000 gross tons, 75 per cent. of which can be mined, i. e., 25,000,000,000 tons; of this 10,500,000,000 are in the Pittsburgh bed. An exaggerated statement was current thirty years ago that the Pittsburgh coal-bed within the limits of the State of Pennsylvania would equal the whole annual British coal-trade (then 100,000,000 tons) for 2000 years. According to our present knowledge such an output would exhaust it in a single century.

The upper productive Coal-measures, about 300 feet thick, contain four workable beds, of which the lowest (Pittsburgh) is the mainstay of the coke and iron interests of the seven south-western counties, furnishing to 77 collieries in Allegheny county 4,000,000 tons, to 50 in Fayette county 1,566,000, to 46 in Westmoreland county 2,326,000, to 31 in Washington county 798,000, to 14 in Somerset county 300,000,—total nearly 9,000,000 tons mined out of 217 collieries, most of them mere adits into the hillsides, at various levels (from 30 to 300 feet) above the water-level of the Ohio river, or its main branch, the Monongahela river, and its branch the Youghueghy river. Along these streams railroad stations and slack water pools receive the coal let down by trestle-work slopes from the adits. A few shafts are sunk to the bed where, for short distances, it sinks a few yards beneath water-level.

The iron-ores of Pennsylvania formerly sufficed for stocking the furnaces of the State; but for more than twenty years past large outside supplies have been in demand,—the red hematites of Michigan, the magnetic ores of Canada, northern New York, and especially of northern New Jersey, and the limonites of Virginia, not to speak of numerous cargoes of Algerian ore. To understand the native ores it will be necessary to refer to the schedule of the geological formations of the State (see p. 500 above). The more recent formations—the Tertiary and the Cretaceous—poor in iron ores, are not found in Pennsylvania, being confined to the Atlantic seaboard. The next older formation—the Trias—also poor in iron ore, makes an independent belt across the State through Bucks, Montgomery, Chester, Lancaster, York, and Adams counties. Hence we have only to consider five sources of supply,—(a) the carbonate ores of the Coal-measures, with brown hematite outcrops; (b) the lower Devonian brown hematites; (c) the Upper Silurian red fossil-ore; (d) the Lower Silurian brown hematites; and (e) the Azoic magnetites, some of them apparently in Cambrian rocks, overlaid by Trias, and the rest of them interbedded with the oldest (Laurentian?) gneisses.

The ordinary ironstones of the Coal-measures occurs in all or parts layers throughout the bituminous coal-region, but is almost wanting in the anthracite region. Brown hematite deposits, always connected with the limestone beds in the Coal-measures, were formerly extensively mined, but the supplies of Carboniferous ore of both kinds are far from meeting the present demand, and the make of charcoal iron from them has been virtually abandoned. At the base of the Devonian series the Marcellus still yields considerable quantities of brown hematite from the outcrop of a ferruginous clay-bed, but only in two or three noteworthy localities. The Clinton beds of red fossil-ore (soft and rich at the outcrop, hard and lean lower down) at Danville and Bloomsbury, at Frankstown and Hollidaysburg, at Bloody Run and Bedford, kept furnaces going for a good many years, and are still used as mixtures at Johnstown and elsewhere. The Lower Silurian brown hematite mines, however, have been the chief dependence of the industry. They are very numerous in the isolated limestone valleys and along the whole course of the Great Valley. Some of these open quarries are of vast size, and between 100 and 200 feet deep; furnishing shot and ball and pipe ore of the finest quality, both cold-short and red-short; and the high reputation of American or Juniata iron is based upon the history first of the charcoal and then of the anthracite make of pig-metal from these special ores. Railroads now

carry them long distances to the present centres of the iron manufacture, in the heart of the bituminous coal-region, or in front of the anthracite region, on the Lehigh, Schuylkill, and Susquehanna rivers, where they can be mixed with the subcrystalline iron ores of the South Mountains or of the Highlands of New Jersey. The South Mountains of Pennsylvania, however, cannot be said to be rich in these last-mentioned deposits, a few of which are indeed mined to a considerable extent; but no thorough exploration of the range has yet been undertaken to see if the deep-lying strata contain the Canadian and New York magnetites which are to be expected. Some of the oldest and largest mines are situated at the edge of the Trias belt, and were formerly supposed to be of Trias age; but it seems now probable that they belong to a Cambrian slate formation covered by the Trias; and in all cases they are touched or surrounded by trap-dykes, which cut the Trias or trap-beds that interlie the Trias. The most remarkable of these mines is the "Cornwall" near Lebanon, where great quantities of cupriferrous magnetite are obtained by stoping the walls of a vast open quarry.

The iron industry of Pennsylvania has always competed with the cotton growth of the southern States and the cotton industry of the eastern States for political power in Congress, to save itself against a foreign importation of rolled iron. The iron-masters of Pennsylvania have led in every debate upon a protective tariff. Pennsylvania has always furnished one-half of the total amount of pig-iron cast in the United States. In 1883 it made 2,638,891 tons out of a total of 5,146,973 tons made in twenty-four States and one Territory. Of those 1,416,468 tons were anthracite pig, 1,184,108 coke and raw coal pig, and only 38,849 were charcoal pig; and the number of furnaces at the end of 1883 was 142 in blast and 129 out of blast. In like manner Pennsylvania has always rolled more than one-half of the iron and steel rails of American manufacture,—in 1883, for instance, 367,818 tons out of a total of 1,360,694, and of these 819,544 were Bessemer. So of crucible-steel ingots Pennsylvania in 1883 made 63,687 out of a total of 80,455; open-hearth steel ingots, 72,338 of a total of 133,679; in a word, of all kinds of rolled iron, 1,081,163 tons out of a total of 2,348,874. The petroleum statistics for 1882, partly mixed with those of an adjoining district in New York, show a product of 30,541,740 barrels (of 43 gallons).

**Vegetation.**—The vegetation of the State corresponds in variety with the variety of elevation and distance from the seaboard. The mountains are clad with forests of pine, hemlock, oak, beech, maple, walnut, wild cherry, cucumber, dogwood, and laurel, and cultivated apple, cherry, pear, and peach trees grow in the clearings. Wild grapes grow in sheltered places; wild huckleberries, strawberries, and blackberries flourish. Oats, barley, and timothy grass yield heavy crops. The original forest remains only here and there in secluded spots. All its white-pine timber has been cut, and none grows to replace it. The spruce-pine, hemlock, and oak woods have been girdled by settlers, or barked by tanners and left to die. Extensive iron-furnace tracts have been systematically cut several times; the deserted charcoal grounds in the anthracite and coke districts have become covered with a dense low growth of oak, maple, birch, dogwood, and other deciduous vegetation. Two other motives have co-operated for the destruction of the original forest,—the demand for railway sleepers and the still greater demand for timber and slabs in mines. The annual forest fires, sometimes of enormous magnitude, help to keep the size of forest-wood small, and to cover the uncultivated part of the State with brushwood. The early settlers of the low country also cut without mercy and without fear; no shadow was allowed to fall on a field. The traditional practice lasted long; but the scarcity of wood at length made itself felt. The last generation began to plant; the present cherishes and multiplies trees, in and around fields, along roads, and on rough ground. The old settled parts of the State are becoming again well wooded. The mountain-ridges will always remain so, for outcrops of sandstone make them rocky, and the terracing of their steep slopes is not yet to be thought of. In the north-western counties the discovery of petroleum in 1859 produced a great demand for derrick lumber, and the ephemeral wooden cities which sprang up during the succeeding twenty-five years caused a rapid bringing under cultivation of at least 5000 square miles, lying between 1000 and 2000 feet above the level of the sea.

Two hundred and eighty-four genera and 544 species of plants are enumerated as growing on the plateau of Wayne county, in the north-east corner of the State, a typical portion of the whole upland region, covered with glacial drift-sand and gravel, with innumerable lakes, ponds, and small swamps, lying at various elevations from 1100 to 2000 feet above the sea.

**Fauna.**—The zoology of Pennsylvania exhibits that transition stage of its history in which we live. The elk has disappeared; but the panther (puma) and the small wolf are occasionally met with. The black bear is not by any means extinct, and can always find its way anew into the State from West Virginia. The wild cat is common in the least settled counties. Hedgehogs, ground-hogs, weasels, polecats, squirrels of three species, mice of several

species, and musk-rats abound; but the beaver, which has given name to so many mountains, rivers, creeks, and swamps all over the State, no longer exists. The wild turkey is practically exterminated, but is occasionally shot on the mountains. Owls, wood-doves, thrushes, and other birds are abundant. Harmless snakes of various species are innumerable, especially a constrictor, the black snake, which grows to a length of 5 or 6 feet. Two venomous snakes are still numerous, the copper-head in the half-cultivated districts and the rattlesnake in the mountains. The latter, in spite of all efforts to exterminate it, breeds with incredible rapidity. In summer it descends into the valleys. But, while the more dreaded copper-head is active and malicious and bites without warning, the rattlesnake is always sluggish and timid, and takes so much time to get into coil, and is so noisy about it, that it is an object more of contempt than of apprehension. The black snake is its worst enemy and is always victorious; the deer also bounds around it, leaps upon it, and scatters it in pieces; the hog feeds upon it; and yet half the State is infested with it. Poisonous insects are almost unknown; but infinite swarms of gnats torment cattle and men in the forest countries. During a short season in summer mosquitoes abound along the tidal rivers, when the south wind blows. Fleas have only recently been imported; but ticks are common in the lowland woods, and the native bed-bug, which breeds under the bark of the hemlock, has become domiciled throughout the State, and is the curse not only of the traveller but of a large part of the resident population.

**Government.**—The constitution of 1874 gives the right to vote to every male citizen over twenty-one years of age who has been a citizen of the United States one month, resident in Pennsylvania one year, and in his election district two months; but, if over twenty-two years old, he must have paid a tax at least two months before the day of election. The legislative power is vested in a general assembly of two houses,—fifty senators elected by the people for four years and two hundred representatives for two years. There are strong constitutional guards against special legislation. The executive department consists of a governor, lieutenant-governor, and secretary of internal affairs, elected each for four years, an auditor for three, and a treasurer for two, together with a secretary of state, an attorney-general, and a superintendent of public instruction, each appointed for four years by the governor with consent of the senate. The judiciary consists of a supreme court of seven judges elected for twenty-one years; forty-three district courts of common pleas each with one or more judges elected for ten years, and exercising probate jurisdiction except in cities where there are orphan's courts; and local magistrates of minor jurisdiction. The State sends twenty-seven representatives to the national Congress; and federal courts for the eastern districts are held at Philadelphia, and for the western district at Pittsburgh, Williamsport, and Erie.

**Population.**—The population was estimated in 1755 at 200,000. The results of subsequent censuses are shown in the following table—

Census.	Males.	Females.	Total.	Density per square mile.
1790	222,810	211,563	434,373	9.6
1800	309,507	292,866	602,365	12.4
1810	418,875	396,516	815,391	18.0
1820	532,433	517,086	1,049,519	22.3
1830	684,378	664,465	1,348,843	30.0
1840	857,356	824,477	1,681,833	35.6
1850	1,108,103	1,148,683	2,256,786	51.4
1860	1,454,419	1,451,798	2,906,215	64.6
1870	1,768,499	1,765,453	3,533,952	78.2
1880	2,196,655	2,146,336	4,342,991	96.2

Of the last total 85,535 were colored; 587,829 were of foreign birth, including 80,102 English, 286,505 Irish, 20,735 Scotch, 29,447 Welsh, and 168,426 Germans.

**Education.**—In 1880 but 4.6 per cent of the population over ten years old were unable to read, and 7.1 per cent unable to write. The State is divided into 2315 districts, which hold school property valued at \$28,341,560, and maintain 19,183 schools, of which 7812 are graded. Directing boards elected by the people appoint county superintendents. The State superintendent has two deputies. The teachers number 21,289, of whom 12,778 are women, the average monthly wages for men being \$35.12, and for women \$28.89. There are fourteen normal schools, ten being under State patronage. The total school expenditure for 1882 was \$6,262,244, including \$1,000,000 of State aid, given every year. The schools are free to all persons from six to twenty-one years of age; and this "school population" in 1880 numbered 1,422,377. In 1883 there were 948,345 on the registers; the average attendance was 611,317. There are twenty-eight colleges giving four-year courses, but only five confine themselves strictly to college work, viz., university of Pennsylvania at Philadelphia, Lehigh university at South Bethlehem, Lafayette college at Easton, Haverford college at Haverford, and Dickinson college at Carlisle. The grounds, buildings, and apparatus of twenty institutions are valued at \$3,186,000, and they hold \$3,951,000 in productive funds. Swarthmore college and eight others admit both sexes to equal privileges. The peo-

ple industries of the State have led to extensive provisions for technical and scientific instruction. There are seventeen theological schools, a law department in the university of Pennsylvania, five medical colleges, all in Philadelphia, an academy of fine arts, and about two hundred academies of various grades.

**Prisons, &c.**—There are two penitentiaries, the Eastern, at Philadelphia, on the separate-cell system, with about 1000 convicts, and the Western, at Allegheny, on the congregate system, with about 650 convicts. The reform school at Morgans (cottage system) and the house of refuge at Philadelphia receive youthful offenders, who in both institutions average over 1000. An industrial reformatory at Huntingdon, with room for 500 youthful criminals sentenced for first offences, is near completion (1884). There are 69 county jails, costing annually \$750,000; the commitments for the year ending 30th September 1883 were 2323, and the inmates 1127.

**Pauperism, Insanity, &c.**—On 30th September 1883 there were 38 county almshouses, containing 8313 inmates, costing for the year \$1,296,945, to which add \$208,880 for township poor and \$226,000 for outdoor relief. A law of 1883 forbids the retention of children over two and under sixteen in almshouses with adult paupers for more than sixty days. Charitable institutions and societies are numerous. Since 1879 a society for organizing charity has been operating in Philadelphia to prevent indiscriminate and duplicate giving, and mendicancy. There are five State hospitals for insane,—at Harrisburg, Danville, Warren, Duxmont, and Norristown. These with three other prominent establishments had 3675 inmates on 1st October 1882, of whom 2220 were indigent. In one year 5107 cases were treated, 1552 newly admitted, 968 persons discharged, 368 died. In 1880 there were 3884 blind persons in the State; in January 1884 there were 378 in institutions assisted by the State. Of those discharged about two-thirds have a fair prospect of self-support. In institutions for deaf and dumb there were 331. Of 404 children in the institute for feeble-minded at Media only 100 were deemed incapable of improvement.

**Agriculture.**—By the census of 1880 there were 801,113 persons engaged in agriculture, and 1,154,955 in all other occupations. The number of farms was 213,542, averaging 93 acres each. There were under improvement 13,423,007 acres, an increase of 1,907,042 since 1870; the value of products was \$129,760,476. The principal crops are wheat, maize, hay, and tobacco, the cultivation of the last having greatly increased of late, so that Pennsylvania ranks third among the tobacco-raising States of the Union, its product in 1880 being 26,943,272 lb. It is most largely grown in Lancaster county. There is a large yield of honey and maple sugar, and the butter product of 1880 was 79,336,012 lb.

**Manufactures.**—The manufacturing industry has more than trebled since 1860. In 1880 the capital invested in 81,232 establishments was \$474,510,993, the cost of material used in a year \$465,020,563, the total sum paid in wages \$134,055,904,—the number of persons employed being 387,072, and the value of product \$744,618,445, or nearly one-seventh of the total product of manufactures in the United States (\$5,369,579,191). Iron and steel take the lead; textile fabrics, including carpets, cottons, woollens, silks, yarns, hosiery, and hats make a large item; 333 tanneries yield in leather \$6,785,814; flour and grist mills do a large business; the lumber interest centres at Williamsport and glass-making at Pittsburgh, and there are salt-wells at Allegheny.

**Communications.**—Connections between the navigable rivers were effected in former years at a cost of over \$60,000,000, by a system of canals now chiefly used for the carriage of coal, subordinate to the mining and railway corporations, which are closely related. There are about 5500 miles of railroad in the State belonging to numerous companies, but the Pennsylvania Railroad system and the Philadelphia and Reading system are by far the most important. The Pennsylvania has not only consolidated under its management many lines within the State but has gained control by purchase or lease of trunk lines and branches leading through other States, east, west, north, and south, including in all over 6000 miles of road. Of these 2655 belong to the Pennsylvania division, of which the gross earnings in 1883 were \$32,017,818, and the net earnings \$13,696,399. The Philadelphia and Reading owns or controls 1523 miles of road, and along with a heavy passenger business (18,195,264 carried in 1883) is largely occupied with transportation of coal from the mines to Philadelphia and New York. Its gross earnings in 1883 were \$29,797,927, its net earnings \$14,464,070, exclusive of rentals of leased lines and interest. In conjunction with the Reading Coal and Iron Company, a separate corporation, it controls seventy-four collieries, covering 163,817 acres of anthracite coal lands. The gross earnings of the Coal and Iron Company for 1883 were \$17,038,858, and the net earnings \$921,771. Other companies control lines leading from the coal and iron regions to New York city. The railroad interest gives employment to over 76,000 men, besides the 8000 employed by the Baldwin Locomotive Works in Philadelphia.

**Finance.**—For the year ending 30th November 1882 the State revenue, exclusive of a loan of \$9,360,120, was \$7,068,529, of which over \$4,000,000 came from taxes on corporations, and nearly all the

rest from various business licences. The State imposes no tax on real estate, but collects \$437,776 from taxes on money at interest, watches, and carriages. The expenditure, exclusive of payment on debt, was \$5,024,766. The debt was \$20,325,083, with \$7,992,983 of assets in the sinking fund. Thirty-eight counties report debts aggregating \$76,301,878, and there are heavy municipal debts. The value of real estate reported in 1882 was \$1,598,430,041, of which \$110,000,126 were legally exempt from taxation.

*Militia.*—Distributed over the State and organized into regiments and brigades are 137 volunteer companies, containing 8220 men and officers, and called collectively the "national guard." They include three batteries of artillery, three companies of cavalry, and 131 of infantry, and are armed, equipped, and supplied by the State at an annual expense of about \$242,000.

*History.*—The grant of the extensive territory called Pennsylvania, made by Charles II. in 1681 to William Penn (q.v.), carried with it full proprietorship and dominion, saving only the king's sovereignty. Penn at once created a quick market for lands by publishing in England and on the Continent his liberal scheme of government and his intention to try the "holy experiment" of "a free colony for all mankind." In 1682, when he crossed the sea to take possession, he found the western bank of the Delaware already occupied by nearly 6000 Swedes, Dutch, and English, the Swedes having begun a settlement in 1638. To these, as to settlers from all nations, he conceded equal liberties. The desire to escape from spiritual and temporal despotisms, and the chance of acquiring rich lands in a salubrious climate on easy terms, drew thousands of immigrants: English Quakers, Scottish and Irish Presbyterians, German Mennonites, French Huguenots, men of all religions, were alike welcome; the population increased for a few years at the rate of one thousand a year; then more rapidly, so that at the end of seventy-five years it exceeded 200,000. Penn twice visited Pennsylvania, staying each time two years. In December 1682 he summoned delegates to meet him at Upland (now Chester) to confer about government; the land was divided into counties, and in March following representatives chosen by the people of these districts agreed on a constitution, based upon popular suffrage, and guaranteeing liberty of conscience. All magistrates and officers were to be chosen by the people, Penn surrendering all claim for revenue by taxation, and retaining for himself and his deputies only the governorship. For his further connexion with Pennsylvania, see PENN. In 1683 PHILADELPHIA (q.v.) was founded. The failure to settle the boundary-line between Pennsylvania and Maryland, in dispute between Lord Baltimore and Penn, long caused great irritation among the settlers, who were liable to double taxation; but in 1750 Lord Hardwick's decree in Chancery confirmed the original claims of Penn, and in 1768-67 Mason and Dixon definitely fixed and marked 246 miles of the line, since made famous as the separation between free and slave States.

For over sixty years the predominance of the Quakers in the assembly had prevented any legislation for public defence,—of which, indeed, there was little need so long as Indians and whites kept their covenant. But in 1744 the Indians became allies of the French, then at war with Great Britain. French military posts established in western Pennsylvania not only violated the integrity of the province but threatened to confine the English to the east of the Alleghenies, and perhaps to crowd them off the continent. The party of non-resistance was overborne by a sense of public danger, which found strong expression in a pamphlet by Franklin; and in 1747 the assembly permitted volunteer organization. One hundred and twenty companies were soon enrolled, ten of them, of a hundred men each, in Philadelphia. But there was no efficient management nor hearty co-operation with adjacent colonies. Braddock's defeat in 1754 intensified the alarm; Fort Duquesne (site of Pittsburgh), which he aimed to reduce, was held by the French till 1758. The peace of Paris in 1763 did not quiet the Red Men. Pontiac, a famous sachem, united the western tribes in a war of extermination, only ended when the whites had proved their mastery. The royal council, displeased with self-governing tendencies, annulled the militia law of Pennsylvania; but the pressure of common danger and the dread of tomahawk and torch not only led to the offer of a bounty of \$130 for Indian scalps, but taught the lessons of comradeship and co-operation, and nourished the self-reliant courage of the generation which was to strike for independence. Though stout against the Stamp Act of 1765 and other parliamentary encroachments, Pennsylvania was not swift to move; the assembly sought to mediate between the parliament and the colonies, but the course of events soon made neutrality impossible. A long adjournment was construed as abjection; a committee of safety seized the reins till the people could speak through a representative convention. The convention espoused the revolution; in September 1776 a State constitution was promulgated; in 1778 the old charter was formally annulled and the Penn claims silenced by payment of £130,000. During the war Pennsylvania was the scene of important events,—the deliberations of the Congress and the Declaration of Independence in 1776; the battles of Brandywine and Germantown in 1777; the British occupation of Phil-

adelphia, and the encampment of Washington at Valley Forge, in 1777-78. A brief but violent mutiny of the unpaid soldiery of Pennsylvania in 1781 led Congress to adopt a better system of finance, under the wise guidance of Robert Morris of Philadelphia. In 1812, at the outbreak of war with Great Britain, Pennsylvania promptly furnished its quota of troops. At the opening of the war with the southern States in 1861, in response to the president's call for 14,000 men as the State's quota, Pennsylvania sent 25,975, and during the war furnished a total of 387,384. No other northern State was invaded. At Gettysburg, near the State border, a three days' battle was fought, 30th June to 3d July 1863, resulting in a decisive victory of the Federal forces. In 1864 Chambersburg was burned by the Confederates. For more than two centuries Penn's commonwealth has been advancing in population and prosperity, and the great body of the people have dwelt in peace. There have been five serious local disturbances. Between 1791 and 1794 there was organized resistance to the collection of a federal tax on distilled spirits, but a strong display of force quelled the insurrection without bloodshed. In 1844 there were riots in Kensington, a suburb of Philadelphia, between "native Americans" and Catholic Irish, resulting in the destruction of thirty dwellings, three churches, one convent, and many lives. Between 1835 and 1861 anti-slavery meetings in Philadelphia were often roughly interrupted, and in 1838 Pennsylvania Hall was burned by a pro-slavery mob. A criminal combination in the anthracite mining region, known as the "Molly Maguire," was broken up in 1876 by due course of law, twenty men being hanged for murder. In 1877 the "railroad riots," an outbreak of dissatisfied railway employes, caused a vast destruction of property at Pittsburgh and vicinity, but were quelled by the military. The constitution has been four times revised,—in 1838, 1860, 1867, 1874. (J. P. L.—C. G. A.)

PENRITH, a market-town of Cumberland, England, is situated near the river Eamont, and on the Lancaster and Carlisle section of the London and North-Western Railway, 18 miles south of Carlisle, and 5 north-east of Ullswater. The town consists chiefly of one long and wide street. To the west once stood an ancient castle, erected as a protection against the Scots, on the site of an old Roman encampment. But it was dismantled by Charles I.; the ruins still remain. The principal public buildings are the grammar-school, founded by Queen Elizabeth in 1566, the agricultural hall, the mechanics' institute, and the working-men's literary institute. There are breweries, tanneries, and saw-mills, but the town depends chiefly on agriculture. The population of the urban sanitary district in 1871 was 8317, and in 1881 it was 9268.

Old Penrith, the *Bremetnacum* of the Romans, was about 5 miles north by west of the present town. At the Conquest the honour of Penrith was a royal franchise; but it was alternately in the possession of the English and Scottish kings until given to Anthony Beck, bishop of Durham, by Edward I. The town more than once lapsed to the crown. In 1696 it was granted to William Bentinck, earl of Portland, and in 1738 it was sold by the duke of Portland to the duke of Devonshire.

PENSACOLA, a city of the United States, capital of Escambia county, Florida, on the north-west coast of Pensacola Bay. The harbour has recently been improved so as to secure a uniform depth of 24 feet. Pensacola is the terminus of three railway lines which connect it with Mobile, Montgomery, Jacksonville, and Millview, the starting-place of steamers plying to Cedar Keys, &c., and the seat of a large trade in lumber (mainly pitch pine), early vegetables, and winter fruits. About 7 miles west of Pensacola lies a United States navy-yard. The value of the exports to Great Britain and the British colonies in 1882 was \$1,481,702, to other foreign countries \$1,091,113, and to the United States \$535,225. The total imports were only \$169,082. In 1850 the population was 2164, in 1870 3347, and in 1880 6845; and it has since increased to upwards of 8000.

Pensacola Bay is said to have been discovered by Narvaez in 1528. French, and afterwards Spanish, colonists settled on the site of the town in the close of the 17th century. In 1719 it was captured by Bienville, in 1728 restored to the Spaniards, in 1763 occupied by the British, in 1781 captured by General Galvez, in 1814 taken from the British by the United States general Jackson, and again in 1818 taken by the same general from the Spaniards. In 1821, according to the treaty of 1819, it became, with the rest of Florida, part of the United States territory.

**PENTATEUCH AND JOSHUA.** The name Pentateuch, already found in Tertullian and Origen, corresponds to the Jewish חמשה חומשי תורה (the five-fifths of the Torah, or Law); the several books were named by the Jews from their initial words, though at least Leviticus, Numbers, and Deuteronomy had also titles corresponding to those we use, viz., תורה כהנים, תורה חקרים (Ἀμμοφοκωδευμ, Origen, in Eua., *H. E.*, vi. 25), and תורה ודבר. The Pentateuch, together with Joshua, Judges, and Ruth, with which it is usually united in Greek MSS., makes up the Octateuch; the Pentateuch and Joshua together have recently been named the Hexateuch. The date of the division of the Torah into five books cannot be made out; it is probably older than the Septuagint translation.

Moses is already taken for the author of the Pentateuch in 2 Chronicles xiv. 4, xxiv. 12 sq.; only the last eight verses of Deuteronomy are, according to the rabbins, not from his pen. From the synagogue belief in the Mosaic authorship passed to the church, and is still widely prevalent among Christians. At an early date, indeed, doubts suggested themselves as to the correctness of this view, but it was not till the 17th century that these became so strong that they could not be suppressed.<sup>1</sup> It was observed that Moses does not speak of himself in the first person, but that some other writer speaks of him in the third,—a writer, too, who lived long after. The expression of Gen. xii. 6, "the Canaanite was then in the land," is spoken to readers who had long forgotten that a different nation from Israel had once occupied the Holy Land; the words of Gen. xxxvi. 31, "these are the kings that reigned in Edom, before there reigned any king over the children of Israel," have no prophetic aspect; they point to an author who wrote under the Hebrew monarchy. Again, the "book of the wars of Jehovah" (Num. xxi. 14) cannot possibly be cited by Moses himself, as it contains a record of his own deeds; and, when Deut. xxxiv. 10 (comp. Num. xii.) says that "there arose not a prophet since in Israel unto Moses," the writer is necessarily one who looked back to Moses through a long series of later prophets.

At the same time attention was drawn to a variety of contradictions, inequalities, transpositions, and repetitions of events in the Pentateuch, such as excluded the idea that the whole came from a single pen. Thus Peyreriis remarked that Gen. xx. and xvi. stand in an impossible chronological context; and on the incongruity of Gen. i. and ii., which he pressed very strongly, he rested his hypothesis of the Preadamites. Such observations could not but grievously shake the persuasion that Moses was the author of the Pentateuch, while at the same time they directed criticism to a less negative task—viz., the analysis of the Pentateuch. For this, indeed, the 17th century did not effect anything considerable, but at least two conclusions came out with sufficient clearness. The first of these was the self-contained character of Deuteronomy, which in these days there was a disposition to regard as the oldest book of the Pentateuch, and that with the best claims to authenticity. And in the second place the Pentateuchal laws and the Pentateuchal history were sharply distinguished; the chief difficulties were felt to lie in the narrative, and there seemed to be less reason for questioning the Mosaic authorship of the laws.

Spinoza's bold conjecture that in their present form not only the Pentateuch but also the other historical books of the Old Testament were composed by Ezra ran far ahead of the laborious investigation of details necessary to solve

the previous question of the composition of the Pentateuch. Jean Astruc has the merit of opening the true path of this investigation. He recognized in Genesis two main sources, between which he divided the whole materials of the book, with some few exceptions, and these sources he distinguished by the mark that the one used for God the name Elohim (Gen. i., v.; comp. Exod. vi. 3) and the other the name Jehovah (Gen. ii.-iv.).<sup>2</sup> Astruc's hypothesis, fortified by the observation of other linguistic differences which regularly corresponded with the variation in the names of God, was introduced into Germany by Eichhorn's *Einführung in d. A. T.*, and proved there the fruitful and just point of departure for all further inquiry. At first, indeed, it was with but uncertain steps that critics advanced from the analysis of Genesis to that of the other books, where the simple criterion of the alternation of the divine names was no longer available. In the hands of the Scotman Geddes and the German Vater the Pentateuch resolved itself into an agglomeration of longer and shorter fragments, between which no threads of continuous connexion could be traced<sup>3</sup> ("Fragmentary Hypothesis"). The fragmentary hypothesis was mainly supported by arguments drawn from the middle books of the Pentateuch, and as limited to these it long found wide support. Even De Wette started from it in his investigations; but this was really an inconsistency, for his fundamental idea was to show throughout all parts of the Pentateuch traces of certain common tendencies, and even of one deliberate plan; nor was he far from recognizing the close relation between the Elohist of Genesis and the legislation of the middle books.

De Wette's chief concern, however, was not with the literary but with the historical criticism of the Pentateuch, and in the latter he made an epoch. In his *Diss. Critica* of 1805 (*Opusc. Theol.*, pp. 149-168) he placed the composition of Deuteronomy in the time of King Josiah (arguing from a comparison of 2 Kings xxii., xxiii., with Deut. xii.), and pronounced it to be the most recent stratum of the Pentateuch, not, as had previously been supposed, the oldest. In his *Critical Enquiry into the Credibility of the Books of Chronicles* (Halle, 1806) he showed that the laws of Moses are unknown to the post-Mosaic history; this he did by instituting a close comparison of Samuel and Kings with the Chronicles, from which it appeared that the variations of the latter are not to be explained by the use of other sources, but solely by the desire of the Jewish scribes to shape the history in conformity with the law, and to give the law that place in history which, to their surprise, had not been conceded to it by the older historical books. Finally, in his *Criticism of the Mosaic History* (Halle, 1807) De Wette attacked the method then prevalent in Germany of eliminating all miracles and prophecies from the Bible by explaining them away, and then rationalizing what remained into a dry prosaic pragmatism. De Wette refuses to find any history in the Pentateuch; all is legend and poetry. The Pentateuch is not an authority for the history of the time it deals with, but only for the time in which it was written; it is, he says, the conditions of this much later time which the author idealizes and throws back into the past, whether in the form of narrative or of law.

De Wette's brilliant *Essai*, which made his reputation for the rest of his life, exercised a powerful influence on his contemporaries. For several decades all who were open to critical ideas at all stood under his influence. Gramberg, Leo, and Von Bohlen wrote under this influence; Gesenius in Halle, the greatest Hebraist then living, taught under it; nay, Vatke and George were guided by De

<sup>1</sup> Hobbes, *Leviathan*, chap. xxxii.; Peyreriis, *Syst. theol. en Præadamitæren Hypothesi*, lv. 1, 2; Spinoza, *Tr. Theologico-pol.*, chap. vii.; E. Simon, *Hist. Crit. de V. T.*, l. 5-7; Le Clerc, *Sentimens de quelques Théologiens de Hollande* (Amst., 1686), lett. 6.

<sup>2</sup> *Conjectures sur les mémoires originaux, dont il paroît que Moïse s'est servi pour composer le livre de la Genèse* (Brussels, 1753). *Comp. Journ. des Savans*, October 1767, pp. 391-305.

<sup>3</sup> J. S. Vater, *Commentar über den Pentateuch*, Halle, 1802-1805.

Wette's ideas and started from the ground that he had conquered, although they advanced beyond him to a much more definite and better established position, and were also diametrically opposed to him in one most important point, of which we shall have more to say presently.<sup>1</sup>

But meantime a reaction was rising which sought to direct criticism towards positive rather than negative results. The chief representatives of this positive criticism, which now took up a distinct attitude of opposition to the negative criticism of De Wette, were Bleek, Ewald, and Movers. By giving up certain parts of the Pentateuch, especially Deuteronomy, they thought themselves able to vindicate certain other parts as beyond doubt genuinely Mosaic, just in the same way as they threw over the Davidic authorship of certain psalms in order to strengthen the claim of others to bear his name. The procedure by which particular ancient hymns or laws were sifted out from the Psalter or the Pentateuch had some resemblance to the *decretum absolutum* of theology; but up to a certain point the reaction was in the right. The youthful De Wette and his followers had really gone too far in applying the same measure to all parts of the Pentateuch, and had been satisfied with a very inadequate insight into its composition and the relation of its parts. Historical criticism had hurried on too fast, and literary criticism had now to overtake it. De Wette himself felt the necessity for this, and from the year 1817 onwards—the year of the first edition of his *Einführung*—he took an active and useful part in the solution of the problems of Pentateuchal analysis. The fragmentary hypothesis was now superseded; the connexion of the Elohist of Genesis with the legislation of the middle books was clearly recognized; and the book of Joshua was included as the conclusion of the Pentateuch. The closely-knit connexion and regular structure of the narrative of the Elohist impressed the critics; it seemed to supply the skeleton which had been clothed with flesh and blood by the Jehovist, in whose contributions there was no such obvious conformity to a plan. From all this it was naturally concluded that the Elohist had written the *Grundchrift* or primary narrative, which lay before the Jehovist and was supplemented by him ("Supplementary Hypothesis").<sup>2</sup>

This view remained dominant till Hupfeld in 1853 published his investigations on *The Sources of Genesis and the Method of their Composition*. Hupfeld denied that the Jehovist followed the context of the Elohist narrative, merely supplementing it by additions of his own. He pointed out that such Elohist passages in Genesis as clearly have undergone a Jehovistic redaction (e.g., chaps. xx., xxi., xxii.) belong to a different Elohist from the author of Gen. i. Thus he distinguished three independent sources in Genesis, and he assumed further, somewhat inconsequently, that no one of them had anything to do with the others till a fourth and later writer wove them all together into a single whole. This assumption was corrected by Nöldeke, who showed that the second Elohist is preserved only in extracts embodied in the Jehovistic book, that the Jehovist and second Elohist form one whole and the *Grundchrift* another, and that thus, in spite of Hupfeld's discovery, the Pentateuch (Deuteronomy being excluded) was still to be regarded as made up of two great layers. Nöldeke had also the honour of having been the first to

trace in detail how the Elohist *Grundchrift* runs through the whole Hexateuch, and of having described with masterly hand the peculiar and inflexible type of its ideas and language. In this task he was aided by the commentary of Knobel, whose industry furnished very valuable materials for men of judgment to work upon.<sup>3</sup>

Thus the investigation into the composition of the Pentateuch had reached a point of rest and a provisional conclusion. The results may be thus summarized. The five books of Moses with Joshua form one whole; and it is not the death of Moses but the conquest of the promised land which forms the true close of the history of the patriarchal age, the exodus, and the wanderings in the wilderness; it is therefore more correct to speak of the Hexateuch than of the Pentateuch. From this whole it is most easy to detach the book of Deuteronomy, and accordingly its independence was very early recognized. Of the other elements, that which has the most marked individuality is the work of the Elohist, which we shall in the sequel call the Priestly Code. This too, like Deuteronomy, is a law-book, but it has an historical setting. Its main stock is Leviticus, with the cognate parts of the adjacent books, Exod. xxv.-xl. (except chaps. xxxii.-xxxiv.) and Num. i.-x., xv.-xix., xxv.-xxxvi. (with some inconsiderable exceptions). This law-book does not, like Deuteronomy, embrace precepts for civil life, but is confined to affairs of worship, and mainly to the esoteric aspect of public worship, that is, to such points as belonged to the function of the priests as distinguished from the worshipping people. The legal contents of the Code are supported on a scaffolding of history, which, however, belongs to the literary form rather than to the substance of the work. It is only where some point of legal interest is involved that the narrative acquires any fulness, as it does in the book of Genesis in connexion with the three preparatory stages of the Mosaic covenant attached to the names of Adam, Noah, and Abraham. Generally speaking, the historical thread is very thin, and often (Gen. v., xi.) it becomes a mere genealogical line, on which is hung a continuous chronology carried on from the creation to the exodus. The Priestly Code is characterized by a marked predilection for numbers and measures, for arrangement (titles to sections) and formality of scheme, by the poverty and inflexibility of its language, by standing repetitions of certain expressions and phrases such as are not elsewhere found in old Hebrew. Thus its distinguishing marks are very pronounced, and can always be recognized without difficulty. If now Deuteronomy and the Priestly Code are successively subtracted from our present Pentateuch the Jehovistic history-book remains, distinguished from both the others by the fact that it is essentially narrative and not law, and by the pleasure it takes in bringing out details of the historical tradition, so that individual points of the story receive full justice and are not sacrificed to the interests of the general plan. The patriarchal history belongs almost entirely to this document, and forms the most characteristic part of it; here that history forms no mere epitomized introduction to more important matter, as in the Priestly Code, but is treated in all fulness as a subject of first-rate importance. Legislative elements are incorporated in the Jehovistic narrative only at one point, where they naturally fall into the historical context, viz., in connexion with the law-giving on Sinai (Exod. xx.-xxiii., xxxiv.).

These, then, are the three main component parts of the Hexateuch—Deuteronomy, the Priestly Code, and the Jehovist. But the Jehovist has woven together in his history-book two sources, one of which uses the name

<sup>1</sup> H. Leo, *Vorlesungen über die Geschichte des jüdischen Staats*, Berlin, 1828; C. P. W. Gramberg, *Kritische Geschichte der Religionsideen des A. T.*, Berlin, 1829-30; P. v. Bohlen, *Die Genesis*, Königsberg, 1835; W. Vatke, *Biblische Theologie*, Berlin, 1835; J. F. L. George, *Die älteren jüdischen Feste*, Berlin, 1835.

<sup>2</sup> Bleek, in Rosenmüller's *Repertorium*, 1822, and in *Stud. und Krit.*, 1831; Ewald, *Stud. u. Krit.*, 1831; Tuch, *Kommentar üb. d. Genesis*, Halle, 1838; especially De Wette in the various editions of his *Einführung*.

<sup>3</sup> Knobel, *Die Genesis erklärt* (Leipzig, 1852), *Exodus und Leviticus* (1857), *Numeri, Deuterom., und Josua* (1861); Nöldeke, *Untersuchungen zur Kritik des A. T.* (Kiel, 1860).



Elohim (Hupfeld's younger Elohist), while the other says *Iahwâ*, as does the Jehovist himself. So, too, the Priestly Code is not a perfectly incoherent structure; it has one main stock marked by a very definite historical arrangement and preserved with little admixture in the book of Genesis; but on the one hand some older elements have been incorporated in this stock, while on the other hand there have been engrafted on it quite a number of later *novellæ*, which in point of form are not absolutely homogeneous with the main body of the Code, but in point of substance are quite similar to it, reflecting the same tendencies and ideas and using the same expressions and mannerisms, so that the whole may be regarded as an historical unity though not strictly as a literary one.

The very name of Deuteronomy shows that from the earliest times it has been regarded as at least possessing a relative independence; the only difficulty is to determine where this section of the Pentateuch begins and ends. In recent times opinion has inclined more and more to the judgment of Hobbes and Vater, that the original Deuteronomy must be limited to the laws in chaps. xii. xxvi.

The reasons that compel us to distinguish the Priestly Code from the Jehovist, and the relation that subsists between these two elements, may be exemplified and illustrated by the first nine chapters of Genesis. We begin by comparing Gen. i. 1 to ii. 4c with Gen. ii. 4b to iii. 24. The history of the first man in paradise has nothing to do with the preceding record of the creation of the world in six days, which is neither referred to nor presupposed. "In the day that Jehovah made the earth there was as yet no plant of the field upon the earth, and no herb grew in the field; for Jehovah had not caused it to rain upon the earth, and there was not a man to till the ground. But a mist went up from the earth and watered the whole face of the ground. And Jehovah formed man of the dust of the ground and breathed into his nostrils the breath of life." It might be supposed that the picture drawn in chap. i. is here briefly referred to in order to add a particular feature which had not been fully brought out there. But there is no situation in chap. i. which this scene fits. There man is made last of all, but here first of all, before vegetation, and according to ii. 19 *sq.* also before the beasts. There man and woman are created together, here at first the man is alone. There vegetation and wet stand opposed, the plants spring up as soon as there is dry land; here the condition of vegetation is the moistening of the dry land—it must first rain; the earth, therefore, was originally not water but a parched desert,—the same conception as in the book of Job, where the sea bursts forth from the womb of the hard earth. The conceptions of the two narratives are different all through, as appears equally in what follows. "Jehovah planted a garden eastwards in Eden, at the place where the four chief rivers of the world are parted from a common source. Here among other goodly trees grew the tree of life and the tree of knowledge. In this garden Jehovah set the man, to dress it and to keep it, to eat of all the fruits save only that of the tree of knowledge." In chap. i. man receives from the first as his portion the whole great earth as he now occupies it, and his task is a purely natural one; "be fruitful and multiply, and fill the earth and subdue it." But in chap. ii. the first man is placed in a mysterious garden of God, with a very limited sphere, where all is supernatural and marvellous. To speak generally, the ideas of God and man in chap. i. are rational and enlightened, but bare and prosaic; in chaps. ii.-iii. they are childlike and primitive, but full of meaning. The point of the contrast is mainly this: in Gen. ii., iii., man is in fact forbidden to lift the veil of things and know the world, represented by the tree of knowledge; in Gen. i. this is his primary task, to rule over all the earth, for sovereignty and knowledge come to the same thing. There nature is to man altogether a marvel; here it is a mere thing, an object for him. There it is robbery for man to seek to be as God; here God from the first created man in His own image, after His likeness, and appointed him His viceroy on earth. With these incongruities in the substance and spirit of the two sections we must take also the differences of form and language observable alike in the whole manner of the narrative—which in Gen. i. is confined by a precise and formal scheme, while in Gen. ii., iii., it has a free poetic movement—and in individual expressions. Thus Gen. i. has Elohim, Gen. ii., iii., Jehovah;<sup>1</sup> Gen. i. has the technical word *בָּרָא*, "create," while the other narrative uses the ordinary words *עָשָׂה*, "make," *יָצַק*, "form;" and so forth.

The contrast between the two records appears in a somewhat different way when we go on to compare Gen. v. with Gen. iv. 17 *sq.* The elements of the genealogy of ten members in the Priestly Code

<sup>1</sup> The addition of Elohim, which produces the un-Hebrew form Jehovah Elohim, in Gen. ii., iii., is due to an editor who desired to soften the abrupt transition from the Elohim of the one narrator to the Jehovah of the other.

and that of seven members in the Jehovist correspond, save that the former adds Noah after Lamech, and that at the beginning Adam-Cain is doubled and becomes Adam-Seth-Enoch-Cainan. Adam and Enoch both mean "man," so that the latter series is equivalent to Adam-Seth-Adam-Cainan; in other words Enoch-Cainan is the beginning of a series corresponding to that in chap. iv., and Adam-Seth is a parallel and variation. Linguistically chap. v. is distinguished from chap. iv. by the use of *וַיִּלְד* in place of *וַיֵּלֶד*.

In Gen. i.-v. we find the two narratives lying side by side in continuous pieces and without intermixture; in Gen. vi.-ix., on the other hand, we have a kind of mosaic, in which elements taken from each are interwoven to form a single narrative. The narrative of the Priestly Code is preserved entire in vi. 9-22, vii. 11, 13-16 (except the last clause of ver. 16), 19-22, 24, viii. 1-5 (with one small exception), 13, 14, ix. 1-17. The Jehovistic narrative, on the other hand, is curtailed to prevent repetition; it would not have done to relate twice over the building of the ark and the divine command to do so, or to give the ordinance of the rainbow once after viii. 22, and then again in ix. 9 *sq.* The hand that fused the two sources together into one continuous account is very plainly recognized in vii. 8, 9, as compared on the one side with vi. 19, 20, and on the other with vii. 2.

The justice of Hupfeld's observation, that besides the first Elohist (our Priestly Code) there is a second author who uses the same name of God, can be best proved from Gen. xx.-xxii., where this second Elohist appears for the first time. According to the Priestly Code Ishmael was fourteen years old at the birth of Isaac, and thus would be seventeen when some three years later Isaac was weaned. But how does this accord with xxi. 9 *sq.*, where Ishmael appears not as a lad of seventeen but as a child at play (*פָּתַח*, ver. 9), who is laid on his mother's shoulder (ver. 14), and when thrown down by her in her despair (ver. 15) is quite unable to help himself? Similar inconsistencies appear if we attempt to place chap. xx. in the context of the Priestly Code; it was already observed by Peyrarius that it is "non vero simile, regem Gerarem voluisse Saram vetulam cui desiderat fieri mulieris." We come, then, to ask what is the relation between this second Elohist writing, from which the greater part of Gen. xx.-xxii. is derived, and the Jehovistic history. In their matter, their points of view, and also in language—apart from the names of God—the two are on the whole similar, as may be seen by comparing chap. xx. with chap. xxvi., or chap. xxi. with chap. xvi. Moreover, the Elohist history is preserved to us in a Jehovistic setting, as can be plainly discerned, partly by certain slight changes (xxi. 53, xxii. 11-14), partly by larger additions (xx. 18, xxi. 1, 32b, xxii. 15-18). But we cannot suppose that it was the principal narrator of the Jehovistic history—the author of the main mass of chaps. xii., xiii., xvi., xviii., xix., xxiv., xxvi.—who incorporated chaps. xx.-xxii. in his own book. For how can we imagine anything so absurd as that, before or after, he should have chosen to tell again in his own words and with full detail and important variations almost all the stories which he borrowed from another work? Rather must we conclude that the union of the Elohist work (E) with the main Jehovistic narrative (J) was accomplished by a third hand. This third author is most conveniently designated as the Jehovist, and his work is compendiously cited as JE; the authors of its two component parts are frequently called for distinction the Jahvist and the Elohist. The editorial hand of the Jehovist can be traced not only in E but in his main source J (the source which uses the name *Iahwâ*); compare, for example, Gen. xvi. 8-10 with Gen. xxv. 15, 18.

Still more complicated than the work of the Jehovist is the Priestly Code; at least in its main section, the ritual legislation of the middle books. It is conceded on all hands that the collection of laws in Lev. xvii.-xxvi. was originally a small independent code, though it has now been worked into the Priestly Code by the aid of very considerable editorial treatment. It is equally undeniable, though not as universally admitted, that—to take one example—Exod. xxx. and xxxi. cannot be placed in the same line with Exod. xxv.-xxix., but form a supplement to the last-named section. No reason can be assigned why the author of Exod. xxv.-xxix., if he intended to mention the golden altar of incense at all, should have failed to include it in the passage where he describes all the other furniture within the tabernacle,—the ark, mercy-seat, golden table, and candlestick; that the altar of incense is first mentioned in Exod. xxx. 1-10 is only to be understood on the assumption that chaps. xxx. and xxxi. were added by a later author.

Such are the main lines of the view now most prevalent as to the composition of the Hexateuch. We come next to consider the date and mutual relations of the several sources. As regards Deuteronomy and the Jehovist there is tolerably complete agreement among critics. Some, indeed, attempt to date Deuteronomy before the time of Josiah, in the age of Hezekiah (2 Kings xviii. 4, 22), or even still earlier; but on the whole the date originally

assigned by De Wette has held its ground. That the author of Deuteronomy had the Jehovistic work before him is also admitted; and it is pretty well agreed that the latter is referred, alike by the character of its language and the circle of its ideas and by express references (Gen. xii. 6, xxxvi. 31, xxxiv. 10; Num. xxii. sq.; Deut. xxxiv. 10), to the golden age of Hebrew literature, the same which has given us the finest parts of the books of Judges, Samuel, and Kings, and the oldest extant prophetic writings,—the age of the kings and prophets, before the dissolution of the sister states of Israel and Judah.

On the other hand, the date of the Priestly Code is disputed. Till pretty recently it was commonly regarded as the oldest part of the Hexateuch. The fact that it is mainly legal seemed to give it the priority over the history of the Jehovist; for Moses was a lawgiver, not a narrator. Again, the priestly legislation has reference to worship, and regulates all points of ritual with great exactness; and by the rule that the earliest forms of religion lay most weight on ceremonies of worship and all matters of form, this fact seemed to mark the Priestly Code as older than Deuteronomy, where affairs of ritual worship are less prominent than precepts of ethical conduct. Once more, the demands made by Deuteronomy for the maintenance of the priesthood and ritual services are much less heavy than the corresponding demands of the Priestly Code; and here again it was natural enough to argue that practical difficulties had led to the abolition or modification of the heavier burdens. And these conclusions were confirmed by the prevalent impression that the final redaction of the Pentateuch, and still more of the book of Joshua, was Deuteronomic, and that the same Deuteronomic redaction could be traced also in the other historical books. But even more weight than was laid on these really plausible arguments was held to attach to another point which seemed not merely to prove the priority of the Priestly Code but to indicate that it was at least partly of Mosaic origin. Alike in the Jehovistic Book of the Covenant and in Deuteronomy the legislation is expressly constructed on the supposition of a nation no longer nomadic but settled in the land of Canaan. The Priestly Code, on the contrary, is throughout directed to Israel as it lived encamped during the wilderness wanderings, and never makes anticipatory reference to later conditions. So also in Genesis the Priestly Code strictly observes the difference between the patriarchal age and later times, and is careful not to transfer Mosaic institutions to the times of the Hebrew forefathers. This air of antiquity, combined with a corresponding severe simplicity in the style and form, and a cast of language which differs profoundly from classical Hebrew, and was conjectured to be of an older mould, was the principal feature relied on as evidence that the Priestly Code deserved the title of the *Grundschrift*, the original and fundamental part of the Hexateuch.

But, in point of fact, it was none of these arguments which really gave rise to the doctrine of the priority of the Priestly Code; that doctrine had its veritable source in the supplementary hypothesis described above. After the supplementary hypothesis was given up, the inferences originally drawn from it continued to hold their ground; though it was made out that the Jehovist did not presuppose the existence of the Priestly Code, critics still assumed without question that the latter was the older work of the two. Critical analysis made steady progress, but the work of synthesis did not hold even pace with it; this part of the problem was treated rather slightly, and merely by the way. Indeed, the true scope of the problem was not realized; it was not seen that most important historical questions were involved as well as questions merely literary, and that to assign the true order of

the different strata of the Pentateuch was equivalent to a reconstruction of the history of Israel. As regards the narrative matter it was forgotten that, after the Jehovistic, Deuteronomic, and priestly versions of the history had been felicitously disentangled from one another, it was necessary to examine the mutual relations of the three, to consider them as marking so many stages of an historical tradition, which had passed through its successive phases under the action of living causes, and the growth of which could and must be traced and historically explained. Still greater faults of omission characterized the critical treatment of the legal parts of the Pentateuch. Bleek, the oracle in all such matters of the German school of "Vermittlungstheologen" (the theologians who tried to mediate between orthodoxy and criticism alike in doctrine and in history), never looked beyond the historical framework of the priestly laws, altogether shutting his eyes to their substance. He never thought of instituting an exact comparison between them and the Deuteronomic law, still less of examining their relation to the historical and prophetic books, with which, in truth, as appears from his *Introduction*, he had only a superficial acquaintance. Ewald, on the other hand, whose views as to the Priestly Code were cognate to those of Bleek, undoubtedly had an intimate acquaintance with Hebrew antiquity, and understood the prophets as no one else did. But he too neglected the task of a careful comparison between the different strata of the Pentateuchal legislation and the equally necessary task of determining how the several laws agreed with or differed from such definite data for the history of religion as could be collected from the historical and prophetic books. He had therefore no fixed measure to apply to the criticism of the laws, though his conception of the history suffered little, and his conception of prophecy still less, from the fact that in shaping them he left the law practically out of sight, or only called it in from time to time in an irregular and rather unnatural way.

Meanwhile, two Hegelian writers, starting from the original position of De Wette, and moving on lines apart from the beaten track of criticism, had actually effected the solution of the most important problem in the whole sphere of Old Testament study. Vatke and George have the honour of being the first by whom the question of the historical sequence of the several stages of the law was attacked on a sound method, with full mastery over the available evidence, and with a clear insight into the far-reaching scope of the problem. But their works made no permanent impression, and were neglected even by Reuss, although this scholar had fallen at the same time upon quite similar ideas, which he did not venture to publish.<sup>1</sup>

<sup>1</sup> The following propositions were formulated by Reuss in 1833 (or, as he elsewhere gives the date, in 1834), though they were not published till 1879. 1. L'élément historique du Pentateuque peut et doit être examiné à part et ne pas être confondu avec l'élément légal. 2. L'un et l'autre ont pu exister sans rédaction écrite. La mention, chez d'anciens écrivains, de certaines traditions patriarcales ou mosaïques, ne prouve pas l'existence du Pentateuque, et une nation peut avoir un droit coutumier sans code écrit. Les traditions nationales des Israélites remontent plus haut que les lois du Pentateuque et la rédaction des premières est antérieure à celle des secondes. 4. L'intérêt principal de l'historien doit porter sur la date des lois, parce que sur ce terrain il a plus de chance d'arriver à des résultats certains. Il faut en conséquence procéder à l'interrogatoire des témoins. 5. L'histoire racontée dans les livres des Juges et de Samuel, et même en partie celle comprise dans les livres des Rois, est en contradiction avec des lois dites mosaïques; donc celles-ci étaient inconnues à l'époque de la rédaction de ces livres, à plus forte raison elles n'ont pas existé dans les temps qui y sont décrits. 6. Les prophètes du 8<sup>e</sup> et du 7<sup>e</sup> siècle ne savent rien du code mosaïque. 7. Jérémie est le premier prophète qui connaisse une loi écrite et ses citations rapportent au Deutéronome. 8. Le Deutéronome (iv. 45-xxviii. 68) est le livre que les prêtres prétendaient avoir trouvé dans le temple, du temps du roi Josias. Ce code est la partie la plus ancienne de la législation (rédigée) comprise dans le Pentateuque. 9. L'histoire des Israélites,

The new ideas lay dormant for thirty years, when they were revived through a pupil of Reuss, K. H. Graf. He too was deemed at first to offer an easy victory to the weapons of "critical analysis," which found many vulnerable points in the original statement of his views. For, while Graf placed the legislation of the middle books very late, holding it to have been framed after the great captivity, he at first still held fast to the doctrine of the great antiquity of the so-called Elohist of Genesis (in the sense which that term bore before Hupfeld's discovery), thus violently rending the Priestly Code in twain, and separating its members by an interval of half a millennium. This he was compelled to do, because, for Genesis at least, he still adhered to the supplementary hypothesis, according to which the Jehovist worked on the basis laid by the (priestly) Elohist. Here, however, he was tying himself by bonds which had been already loosed by Hupfeld; and, as literary criticism actually stood, it could show no reason for holding that the Jehovist was necessarily later than the Elohist. In the end, therefore, literary criticism offered itself as Graf's auxiliary. Following a hint of Kuenen's, he embraced the proffered alliance, gave up the violent attempt to divide the Priestly Code, and proceeded without further obstacle to extend to the historical part of that code as found in Genesis those conclusions which he had already established for its main or legislative part. Graf himself did not live to see the victory of his cause. His *Goel*, to speak with the ancient Hebrews, was Professor A. Kuenen of Leyden, who has had the chief share in the task of developing and enforcing the hypothesis of Graf.<sup>1</sup>

The characteristic feature in the hypothesis of Graf is that the Priestly Code is placed later than Deuteronomy, so that the order is no longer Priestly Code, Jehovist, Deuteronomy, but Jehovist, Deuteronomy, Priestly Code. The method of inquiry has been already indicated; the three strata of the Pentateuch are compared with one another, and at the same time the investigator seeks to place them in their proper relation to the successive phases of Hebrew history as these are known to us from other and undisputed evidence. The process may be shortened if it be taken as agreed that the date of Deuteronomy is known from 2 Kings xxii.; for this gives us at starting a fixed point, to which the less certain points can be referred. The method can be applied alike to the historical and legal parts of the three strata of the Hexateuch. For the Jehovist has legislative matter in Exod. xx.-xxiii., xxxiv., and Deuteronomy and the Priestly Code embrace historical matters; moreover, we always find that the legal standpoint of each author influences his presentation of the history, and *vice versa*. The most important point, however, is the comparison of the laws, especially of the laws about worship, with corresponding statements in the historical and prophetic books.

The turning-point in the history of worship in Israel is the centralization of the cultus in Jerusalem by Josiah (2 Kings xxii., xxiii.). Till then there were in Judah, as there had been before in Samaria, a multitude of local

sanctuaries, the legitimacy of which no one dreamt of disputing. If Hezekiah made an attempt to abolish these local shrines, as we are told in 2 Kings xviii. 4, 22, it is yet plain that this attempt was not very serious, as it had been quite forgotten less than a hundred years later. Josiah's reforms were the first that went deep enough to leave a mark on history. Not, indeed, that the high places fell at one blow; they rose again after the king's death, and the attachment to them finally disappeared only when the Babylonian exile tore the nation from its ancestral soil and forcibly interrupted its traditional customs. The returning exiles were thoroughly imbued with the ideas of Josiah's reform, and had no thought of worshipping except in Jerusalem; it cost them no sacrifice of their feelings to leave the ruined high places unbuild. From this date all Jews understood as a matter of course that the one God had only one sanctuary. Thus we have three distinct historical periods,—(1) the period before Josiah, (2) the transition period introduced by Josiah's reforms, and (3) the period after the exile. Can we trace a correspondence between these three historical phases and the laws as to worship?

1. The principal law-book embodied by the Jehovist, the so-called Book of the Covenant, takes it for granted in Exod. xx. 24-26 that altars are many, not one. Here there is no idea of attaching value to the retention of a single place for the altar; earth and rough stones are to be found everywhere, and an altar of these materials falls into ruins as easily as it is built. Again, a choice of materials is given, presumably for the construction of different altars, and Jehovah proposes to come to His worshippers and bless them, not in the place where he causes His name to be celebrated, but at every such place. The Jehovistic law therefore agrees with the customary usage of the earlier period of Hebrew history; and so too does the Jehovistic story, according to which the patriarchs wherever they reside erect altars, set up cippi (*mazebot*), plant trees, and dig wells. The places of which these acts of the patriarchs are related are not fortuitous, they are the same places as were afterwards famous shrines. This is why the narrator speaks of them; his interest in the sites is not antiquarian, but corresponds to the practical importance they held in the worship of his own day. The altar which Abraham built at Shechem is the same on which sacrifices still continued to be offered; Jacob's anointed stone at Bethel was still anointed, and tithes were still offered at it in fulfilment of vows, in the writer's own generation. The things which a later generation deemed offensive and heathenish—high places, *mazebot*, sacred trees, and wells—all appear here as consecrated by patriarchal precedent, and the narrative can only be understood as a picture of what daily took place in the first century or thereabout after the division of the kingdoms, thrown back into the past and clothed with ancient authority.

2. The Deuteronomic legislation begins (Deut. xii.), just like the Book of the Covenant, with a law for the place of worship. But now there is a complete change; Jehovah is to be worshipped only in Jerusalem and nowhere else. The new law-book is never weary of repeating this command and developing its consequences in every direction. All this is directed against current usage, against "what we are accustomed to do at this day"; the law is polemical and aims at reformation. This law therefore belongs to the second period of the history, the time when the party of reform in Jerusalem was attacking the high places. When we read, then, that King Josiah was moved to destroy the local sanctuaries by the discovery of a law-book, this book, assuming it to be preserved in the Pentateuch, can be none other than the legislative part of Deuteronomy, which must once have had a separate exist-

en tant qu'il s'agit du développement national déterminé par des lois écrites, se divisera en deux périodes, avant et après Josias. 10. Échelon est antérieur à la rédaction du code rituel et des lois qui ont définitivement organisé la hiérarchie. 11. Le livre de Josué n'est pas, tant s'en faut, la partie la plus récente de l'ouvrage entier. 12. Le rédacteur du Pentateuque se distingue clairement de l'ancien prophète Moïse. (*L'histoire sainte et la loi*, Paris, 1879, pp. 23, 24.)

<sup>1</sup> K. H. Graf, *Die geschichtlichen Bücher des A. T.*, Leipzig, 1866; essays by Graf, in *Merr's Archiv*, i. 525 sq., 466 sq.; A. Kuenen, "De priesterlijke Bestanddeelen van Pentateuch en Jozua," in *Theol. Tijdschrift*, 1870, p. 391 sq., and *De Godsdienst van Israel*, 2 vols., Haarlem, 1869-70. See also J. Wellhausen, *Prolegomena zur Geschichte Israels*, 2d ed., Berlin, 1883 (Eng. tr., Edinburgh, A. & C. Black, 1885); the first edition appeared in 1878 as *Geschichte Israels*, vol. i.

once in a shorter form than the present book of Deuteronomy; this, too, is the inference to which we are led by the citations and references in Kings and Jeremiah.

8. In the Priestly Code all worship depends on the tabernacle, and would fall to nothing apart from it. The tabernacle is simply a means of putting the law of unity of worship in an historical form; it is the only legitimate sanctuary; there is no other spot where God dwells and shows Himself, no other where man can approach God and seek His face with sacrifice and gifts. But, while Deuteronomy demands, the Priestly Code presupposes, the limitation of worship to one sanctuary. This principle is tacitly assumed as the basis of everything else, but is never asserted in so many words; the principle, it appears, is now no novelty, but can be taken for granted. Hence we conclude that the Priestly Code builds on the realization of the object aimed at in Deuteronomy, and therefore belongs to the time after the exile, when this object had been fully secured. An institution which in its origin must necessarily have had a negative significance as an instrument in the hands of polemical reformers is here taken to have been from the first the only intelligible and legitimate form of worship. It is so taken because established customs always appear to be natural and to need no reason for their existence.

The abolition of the local shrines in favour of Jerusalem necessarily involved the deposition of the provincial priesthood in favour of the sons of Zadok in the temple of Solomon. The law of Deuteronomy tries to avoid this consequence by conceding the privilege of offering sacrifices at Jerusalem to the Levites from other places; Levites in Deuteronomy is the general name for priests whose right to officiate is hereditary. But this privilege was never realized, no doubt because the sons of Zadok opposed it. The latter, therefore, were now the only real priests, and the priests of the high places lost their office with the destruction of their altars; for the loss of their sacrificial dues they received a sort of eleemosynary compensation from their aristocratic brethren (2 Kings xxiii. 9). The displacing of the provincial priests, though practically almost inevitable, went against the law of Deuteronomy; but an argument to justify it was supplied by Ezekiel (Ezek. xliiv.). The other Levites, he says, forfeited their priesthood by abusing it in the service of the high places; and for this they shall be degraded to be mere servants of the Levites of Jerusalem, who have not been guilty of the offence of doing sacrifice in provincial shrines, and thus alone deserve to remain priests. If we start from Deuteronomy, where all Levites have equal priestly rights, this argument and ordinance are plain enough, but it is utterly impossible to understand them if the Priestly Code is taken as already existing. Ezekiel views the priesthood as originally the right of all Levites, while by the Priestly Code a Levite who claims this right is guilty of baseless and wicked presumption, such as once cost the lives of all the company of Korah. And the position of the Levites which Ezekiel qualifies as a punishment and a degradation appears to the Code as the natural position, which their ancestors from father to son had held from the first. The distinction between priest and Levite, which Ezekiel introduces expressly as an innovation, and which elsewhere in the Old Testament is known only to the author of Chronicles, is, according to the Code, a Mosaic institution fixed and settled from the beginning. Ezekiel's ideas and aims are entirely in the same direction as the Priestly Code, and yet he plainly does not know the Code itself. This can only mean that in his day it did not exist, and that his ordinances formed one of the steps that prepared the way for it.

The Priestly Code gives us an hierocracy fully developed, such as existed after the exile. Aaron stands above

his sons as the sons of Aaron stand above the Levites. He has not only the highest place, but a place quite unique, like that of the Roman pontiff; his sons minister under his superintendence (Num. iii. 4); he himself is the only priest with full rights; as such he wears the Urim and Thummim, and the golden ephod; and none but he can enter the holy of holies and offer incense there. Before the exile there were, of course, differences of rank among the priests, but the chief priest was only *primus inter pares*; even Ezekiel knows no high priest in the sense of the Priestly Code. The Urim and Thummim were the insignia of the Levites in general (Deut. xxxiii. 8), and the linen ephod was worn by them all, while the golden ephod was not a garment but a gold-plated image such as the greater sanctuaries used to possess (Judges viii. 27; Isa. xxx. 22). Moreover, up to the exile the temple at Jerusalem was the king's chapel, and the priests were his servants; even Ezekiel, who in most points aims at securing the independence of the priests, gives the prince a weighty part in matters of worship, for it is he who receives the dues of the people, and in return defrays the sacrificial service. In the Priestly Code, on the other hand, the dues are paid direct to the sanctuary, the ritual service has full autonomy, and it has its own head, who holds his place by divine right. Nay, the high priest represents more than the church's independence of the state; he exercises sovereignty over Israel. Though sceptre and sword are lacking to him, his spiritual dignity as high priest makes him the head of the theocracy. He alone is the responsible representative of the commonwealth; the names of the twelve tribes are written on his shoulders and his breast. Offence of his inculpates the whole people and demands the same expiation as a national sin, while the sin-offerings prescribed for the princes mark them out as mere private persons compared with him. His death makes an epoch; the fugitive manlayer is amnestied, not on the death of the king, but on the death of the high priest. On his investiture he receives a kingly unction (whence his name, "the anointed priest"); he wears the diadem and tiara of a monarch, and is clad in royal purple, the most unpriestly dress possible. When now we find that the head of the national worship is as such, and merely as such—for no political powers accompany the high priesthood—also the head of the nation, this can only mean that the nation is one which has been deprived of its civil autonomy, that it no longer enjoys political existence, but survives merely as a church. In truth the Priestly Code never contemplates Israel as a nation, but only as a religious community, the whole life of which is summed up in the service of the sanctuary. The community is that of the second temple, the Jewish hierocracy under that foreign dominion which alone made such an hierocracy possible. The pattern of the so-called Mosaic theocracy, which does not suit the conditions of any earlier age, and of which Hebrew prophecy knows nothing, even in its ideal descriptions of the commonwealth of Israel as it ought to be, fits post-exilic Judaism to a nicety, and was never an actual thing till then. After the exile the Jews were deprived by their foreign rulers of all the functions of public political life; they were thus able, and thus indeed compelled, to devote their whole energies to sacred things, in which full freedom was left them. So the temple became the one centre of national life, and the prince of the temple head of the spiritual commonwealth, while, at the same time, the administration of the few political affairs which were still left to the Jews themselves fell into his hands as a matter of course, because the nation had no other chief.

The material basis of the hierarchy was supplied by the sacred dues. In the Priestly Code the priests receive all

sin-offerings and guilt-offerings, the greater part of the cereal accompaniments of sacrifices, the skin of the burnt-offering, the breast and shoulder of thank-offerings. Further, they receive the male firstlings and the tithe of cattle, as also the firstfruits and tithes of the fruits of the land. Yet with all this they are not even obliged to support at their own cost the stated services and offerings of the temple, which are provided for by a poll-tax. The poll-tax is not ordained in the main body of the Code, but such a tax, of the amount of one-third of a shekel, began to be paid in the time of Nehemiah (Neh. x. 32), and in a novel of the law (Exod. xxx. 15) it is demanded at the higher rate of half a shekel per head. That these exorbitant taxes were paid to or claimed by the priests in the wilderness, or during the anarchy of the period of the judges, is inconceivable. Nor in the period of the kingship is it conceivable that the priests laid claim to contributions much in excess of what the king himself received from his subjects; certainly no such claim would have been supported by the royal authority. In 1 Sam. viii. 15 the tithes appear as paid to the king, and are viewed as an oppressive exaction, yet they form but a single element in the multiplicity of dues which the priests claim under the Priestly Code. But, above all, the fundamental principles of the system of priestly dues in the Code are absolutely irreconcilable with the fact that as long as Solomon's temple stood the king had the power to dispose of its revenues as he pleased. The sacred taxes are the financial expression of the hierocratic system; they accord with the condition of the Jews after the exile, and under the second temple they were actually paid according to the Code, or with only minor departures from its provisions.

Before the exile the sacred gifts were not paid to the priests at all but to Jehovah; they had no resemblance to taxes, and their religious meaning, which in the later system is hardly recognizable, was quite plainly marked. They were in fact identical with the great public festival offerings which the offerers consumed in solemn sacrificial meals before Jehovah, that is, at the sanctuary. The change of these offerings into a kind of tax was connected with an entire transformation of the old character of Israel's worship, which resulted from its centralization at Jerusalem. In the old days the public worship of the nation consisted essentially in the celebration of the yearly feasts; that this was so can be plainly seen from the prophets,—from Amos, but especially from Hosea. And accordingly the laws of worship are confined to this one point in the Jehovist, and even in Deuteronomy. After the exile the festival observances became much less important than the *tamid*, the regular daily and weekly offerings and services; and so we find it in the Priestly Code. But, apart from this, the feasts underwent a qualitative change, a sort of degeneration, which claims our special attention. Originally they were thanksgiving feasts in acknowledgment of Jehovah's goodness in the seasons of the year. The expression of thanks lay in the presentation of the firstlings and firstfruits, and these constituted the festival offerings. The chief feast, at the close of the old Hebrew year, was the autumn feast of ingathering (Feast of Tabernacles),—a thanksgiving for the whole produce of the winepress and the corn-flour, but especially for the vintage and the olive harvest. Then, at the beginning of the summer half-year, came the feast of unleavened bread (Maçôth, Easter), which in turn was followed by the harvest feast (Pentecost). Between the two last there was a definite interval of seven weeks; hence the name "Feast of Weeks" (Exod. xxiv.). In Deut. xvi. 9 the seven weeks are explained as "seven weeks from such time as thou beginnest to put the sickle to the corn." The Easter feast, therefore, is the commencement of the corn harvest, and this throws light

on its fixed relation to Pentecost. The one is the end of the harvest, the other its commencement in Abib (the month of "corn-ears"); between them lie the "determined weeks of harvest" (Jer. v. 24). The whole of this *tempus clavum* is one great time of gladness (Isa. ix. 3), bounded by the two feasts. According to Lev. xxiii. 9-22 the distinguishing ceremony at Easter is the presentation of a sheaf of barley, before which no one is allowed to taste the new corn; the corresponding rule at Pentecost is the presentation of leavened wheaten bread. The barley of course is the first and the wheat the last grain ripe; at the beginning of harvest the firstfruits are presented in the sheaf, and men also partake of the new growth in the shape of parched ears of corn (Lev. xxiii. 14; Josh. v. 11); at the end of harvest the firstfruits take the form of ordinary bread. We now see the meaning of the "unleavened bread." Unleavened cakes are quickly prepared, and were used when bread had to be furnished suddenly (1 Sam. xxviii. 24); here it is the new meal of the year which is hastily baked into a sort of bannock without waiting for the tedious process of leavening. The unleavened bread contrasts with the Pentecostal cake in the same way as the barley sheaf and the parched ears do, and so, as we see from Josh. v. 11, parched corn may be eaten instead of unleavened bread,—a point worthy of notice.

Thus the three feasts are all originally thanksgivings for the fruits of the ground, and in all of them the offering of firstfruits is the characteristic feature. Quite similarly the Passover, which was celebrated at the same season as the Easter feast of unleavened bread, is also a thanksgiving feast; but here the offerings are not taken from the fruits of the ground but from the male firstlings of the cattle (sheep and oxen). The Jehovistic tradition in Exodus still exhibits this original character of the Passover with perfect clearness. Jehovah demands that His people shall go forth and celebrate His feast in the wilderness with sacrifices of sheep and oxen; and, because Pharaoh refuses to allow the Hebrews to serve their God by offering the firstlings of cattle that are His due, He takes from the king the firstborn of his subjects. The feast, therefore, is older than the exodus, and the former is the occasion of the latter, not *vice versa*. In the Priestly Code the true significance of the feasts appears only dimly in particular details of ritual; their general character is entirely changed. They no longer rest on the seasons and the fruits of the season, and indeed have no basis in the nature of things. They are simply statutory ordinances resting on a positive divine command, which at most was issued in commemoration of some historical event. Their relation to the firstfruits and firstlings is quite gone; indeed these offerings have no longer any place in acts of worship, being transformed into a mere tax, which is holy only in name. This degeneration of the old feasts is carried furthest in the case of the Passover. An historical reason is assigned to the Passover as early as Deuteronomy and the Deuteronomic redaction of the Jehovist, but in these writings the real character of the feast remains so far unchanged that it is still celebrated by the sacrifice of the firstlings of oxen and of sheep. But in the Priestly Code the paschal sacrifice has quite lost its old character, and consists of a yearling sheep or goat, while the firstlings have no more connexion with the Passover, but are a mere due to the priests without any properly religious character. The other feasts have also lost their individuality by being divorced from the firstfruits and celebrated instead by stated sacrifices, which are merely the *tamid* on a larger scale, and have no individuality of meaning. All this is a consequence of the centralizing process which took the observances of worship away from their natural soil, spiritualized them, and gave them a stereotyped reference to

Jehovah's relation with Israel as a whole, and to the sacred history. This centralization, indeed, was not the work of the Priestly Code but of the prophets; but in the Code we find all its consequences fully developed, while even in Deuteronomy the process is still quite in an early stage. Jewish practice after the exile is guided by the Priestly Code, not in every detail, but quite unquestionably in its main features. In the time of Christ no one thought of any other kind of Passover than that prescribed in the Code; the paschal lamb had obliterated all recollection of the sacrifice of the firstlings.

The conclusions which we have reached by comparing the successive strata of the laws are confirmed by a comparison of the several stages of the historical tradition embodied in the Pentateuch. The several threads of narrative which run side by side in the Pentateuch are so distinct in point of form that critics were long disposed to assume that in point of substance also they are independent narratives, without mutual relation. This, however, is highly improbable on general considerations, and is seen to be quite impossible when regard is paid to the close correspondence of the several sources in regard to the arrangement of the historical matter they contain. It is because the arrangement is so similar in all the narratives that it was possible to weave them together into one book; and besides this we find a close agreement in many notable points of detail. Here too analysis does not exhaust the task of the critic; a subsequent synthesis is required. When he has separated out the individual documents the critic has still to examine their mutual relations, to comprehend them as phases in a living process, and in this way to trace the gradual development of the Hebrew historical tradition. In the present article, however, we cannot say anything of the way in which the Deuteronomist views the Hebrew history, nor shall we attempt to characterize the differences between the two sources of the Jehovist, but limit ourselves to a general comparison between the Jehovistic narrative and that of the Priestly Code.

Bleek and his school viewed it as a great merit of the latter narrative that it strictly observes the difference between various ages, mixes nothing Mosaic with the patriarchal period, and in the Mosaic history never forgets that the scene lies in the wilderness of wandering. They also took it as a mark of fidelity to authentic sources that the Code contains so many dry lists, such a mass of unimportant numbers and names, such exact technical descriptions of details which could have no interest for posterity. Against this view Colenso, in the first part of his *Pentateuch and Book of Joshua critically examined* (Lond., 1862), proved that just those parts of the Hexateuch which contain the most precise details, and so have the air of authentic documents, are least consistent with the laws of possibility. Colenso, when he wrote, had no thought of the several sources of the Hexateuch, but this only makes it the more remarkable that his criticisms mainly affect the Priestly Code. Noldeke followed Colenso with clearer insight, and determined the character and value of the priestly narrative by tracing all through it an artificial construction and a fictitious character. In fact the supposed marks of historical accuracy and dependence on authentic records are quite out of place in such a narrative as that of the Pentateuch, the substance of which is not historical but legendary. This legendary character is always manifest both in the form and in the substance of the narrative of the Jehovist; his stories of the patriarchs and of Moses are just such as might have been gathered from popular tradition. With him the general plan of the history is still quite loose; the individual stories are the important thing, and they have a truly living

individuality. They have always a local connexion, and we can still often see what motives lie at the root of them; but even when we do not understand these legends they lose none of their charm; for they breathe a sweet poetic fragrance, and in them heaven and earth are magically blended into one. The Priestly Code, on the other hand, dwells as little as possible on the details of the several stories; the pearls are stripped off in order that the thread on which they were strung may be properly seen. Love and hate and all the passions, angels, miracles, and theophanies, local and historical allusions, disappear; the old narrative shrivels into a sort of genealogical scheme,—a bare scaffolding to support a pragmatic construction of the connexion and progress of the sacred history. But in legendary narrative connexion is a very secondary matter; indeed it is only brought in when the several legends are collected and written down. When, therefore, the Priestly Code makes the connexion the chief thing, it is clear that it has lost all touch of the original sources and starting-points of the legends. It does not, therefore, draw from oral tradition but from books; its dry excerpts can have no other source than a tradition already fixed in writing. In point of fact it simply draws on the Jehovistic narrative. The order in which that narrative disposed the popular legends is here made the essential thing; the arrangement, which in the Jehovist was still quite subordinate to the details, is here brought into the foreground; the old order of events is strictly adhered to, but is so emphasized as to become the one important thing in the history. It obviously was the intention of the priestly narrator to give by this treatment the historical quaintness of his materials, freed of all superfluous additions. At the same time, he has used all means to dress up the old naive traditions into a learned history. Sorely against its real character, he forces it into a chronological system, which he carries through without a break from Adam to Joshua. Whenever he can he patches the story with things that have the air of authoritative documents, great lists of subjects without predicates, of numbers and names which could never have been handed down orally without being put in writing, and introduces a spurious air of learned research in the most unsuitable places. Finally, he rationalizes the history after the standard of his own religious ideas and general culture; above all, he shapes it so that it forms a framework, and at the same time a gradual preparation for the Mosaic law. With the spirit of the legend, in which the Jehovist still lives, he has nothing in common, and so he forces it into conformity with a point of view entirely different from its own.

The greater part of the narratives of the Pentateuch cannot be measured by an historical standard; but within certain limits that standard can be applied to the epical age of Moses and Joshua. Thus we can apply historical criticism to the several versions of the way in which the tribes of Israel got possession of the land of Canaan. The priestly narrator represents all Canaan as reduced to a *tabula rasa*, and then makes the masterless and unpeopled land be divided by lot. The first lot falls to Judah, then come Manasseh and Ephraim, then Benjamin and Simeon, and lastly the five northerly tribes, Zabulon, Issachar, Asher, Naphtali, Dan. "These are the inheritances which Eleazar the priest and Joshua the son of Nun and the heads of the tribes of Israel apportioned by lot at Shiloh before Jehovah at the door of the tabernacle." According to the Jehovist (Josh. xiv. 6) Judah and Joseph seem to have had their portions assigned to them while the Israelite headquarters were still at Gilgal—but not by lot—and to have gone forth from Gilgal to take possession of them. A good deal later the rest of the land was divided by lot to the remaining tribes at Shiloh, or perhaps, in the original form of the narrative, at Shechem (Josh. xviii. 2-10); Joshua casts the lots and makes the assignments alone, Eleazar is not associated with him. The absolute uniformity in the method of the division of the land to all the tribes is in some degree given up in this account; it is still more strongly contradicted by the important chapter, Judges i. Fragments of this chapter are found also in the book of Joshua, and there is no doubt that it belongs to the Jehovistic group of narra-



tives, in common with which it speaks of the Angel of Jehovah. It is in truth not a continuation of but a parallel to the book of Joshua, presupposing the conquest of the lands east of the Jordan, but not of western Canaan. The latter conquest is what it relates, and in a way quite different from the book of Joshua. From Gilgal, where the Angel of Jehovah first set up his camp, the tribes go forth singly each to conquer a land for itself, Judah going first and Joseph following. It is only of the movements of these two tribes that we have a regular narrative, and for Joseph this is limited to the first beginnings of his conquests. There is no mention of Joshua; a commander-in-chief of all Israel would indeed be out of place in this record of the conquest, but Joshua might have appeared in it as commander of his own tribe. The incompleteness of the conquest is frankly admitted; the Canaanites continued to hold undisturbed the cities of the plain, and it was only in the time of the kingship, when Israel was waxen strong, that they became subject and tributary. From all that we know of the subsequent history there can be no doubt that this account of the conquest is vastly nearer to the facts than that which prevails in the book of Joshua, where everything is done with systematic completeness, and the whole land dispeopled and then divided by lot. This latter and less historical view is most consistently carried through in the priestly narrative, which accordingly must be the narrative most remote from the origin of the Hebrew tradition. The same conclusion may be drawn from the fact that the priestly writer never names the tribe of Joseph, but always the two tribes of Ephraim and Manasseh, which, moreover, do not receive nearly so much notice as Judah, although Joshua, the leader of Ephraim, is retained in the character of leader of all Israel from an old and originally Ephraïtic tradition.

The middle position which the legal part of Deuteronomy holds between the Jehovist and the Priestly Code is also characteristic of the Deuteronomic narrative, which is founded throughout on the narrative of the Jehovist, but from time to time shows a certain leaning to the points of view characteristic of the priestly narrator. The order of the several parts of the Hexateuch to which we have been led by all these arguments is confirmed by an examination of the other historical books and the books of Chronicles. The original sources of the books of Judges, Samuel, and Kings stand on the same platform with the Jehovist; the editing they received in the exile presupposes Deuteronomy; and the latest construction of the history as contained in Chronicles rests on the Priestly Code. This is admitted and need not be proved in detail; the conclusion to be drawn is obvious.

We have now indicated the chief lines on which criticism must proceed in determining the order of the sources of the Hexateuch, and the age of the Priestly Code in particular,—though, of course, it has not been possible at all to exhaust the argument. The objections that have been taken to Graf's hypothesis partly rest on misunderstanding. It is asked, for example, what is left for Moses if he was not the author of the Torah. But Moses may have been the founder of the Torah though the Pentateuchal legislation was codified almost a thousand years later; for the Torah was originally not a written law but the oral decisions of the priests at the sanctuary—case-law, in short, by which they decided all manner of questions and controversies that were brought before their tribunal; their Torah was the instruction to others that came from their lips, not at all a written document in their hands guaranteeing their own status, and instructing themselves how to proceed in the sacrificial ritual. Questions of clean and unclean belonged to the Torah, because these were matters on which the laity required to be directed; but, speaking generally, the ritual, so far as it consisted in ceremonies performed by the priests themselves, was no part of the Torah. But, while it was only at a late date that the ritual appeared as Torah as it does in the Priestly Code, its usages and traditions are exceedingly ancient, going back, in fact, to pre-Mosaic and heathenish times. It is absurd to speak as if Graf's hypothesis meant that the whole ritual is the invention of the Priestly Code, first put into practice after the exile; all that is affirmed by

the advocates of that hypothesis is that in earlier times the ritual was not the substructure of an hierocracy, that there was in fact no hierocracy before the exile, but that Jehovah's sovereignty was an ideal thing and not visibly embodied in an organization of the commonwealth under the forms of a specifically spiritual power. The theocracy was the state; the old Israelites regarded their civil constitution as a divine miracle. The later Jews assumed the existence of the state as a natural thing that required no explanation, and built the theocracy over it as a special divine institution.

There are, however, some more serious objections taken to the Grafian hypothesis. It is, indeed, simply a misstatement of facts to say that the language of the Priestly Code forbids us to date it so late as post-exilic times. On the other hand, a real difficulty lies in the fact that, while the priestly redaction extends to Deuteronomy (Deut. i. 3), it is also true that the Deuteronomic redaction extends to the Priestly Code (Josh. xx.). The way out of this dilemma is to be found by recognizing that the so-called Deuteronomic redaction was not a single and final act, that the characteristic phrases of Deuteronomy became household words to subsequent generations, and were still current and found application centuries after the time of Josiah. Thus, for example, the traces of Deuteronomic redaction in Josh. xx. are still lacking in the Septuagint; the canonical text, we see, was retouched at a very late date indeed. Of the other objections taken to the Grafian hypothesis only one need be mentioned here, viz., that the Persians are not named in the list of nations in Gen. x. This is certainly hard to understand if the passage was written in the Persian period. But the difficulty is not insuperable; the Persians, for example, may have been held to be included in the mention of the Medians, and this also would give the list the archaic air which the priestly writer affects. At any rate, a residue of minute difficulties not yet thoroughly explained cannot outweigh the decisive arguments that support the view that the Priestly Code originated in and after the exile. Knenon observes with justice that "it is absolutely necessary to start with the plain and unambiguous facts, and to allow them to guide our judgment on questionable points. The study of details is not superfluous in laying down the main lines of the critical construction, but, as soon as our studies have supplied us with some really fixed points, further progress must proceed from them, and we must first gain a general view of the whole field instead of always working away at details, and then coming out with a rounded theory which lacks nothing but a foundation."

Finally, it is a pure *petitio principii*, and nothing more, to say that the post-exilic age was not equal to the task of producing a work like the Priestly Code. The position of the Jews after the exile made it imperative on them to reorganize themselves in conformity with the entire change in their situation, and the Priestly Code corresponds to all that we should expect to find in a constitution for the Jews after the exile as completely as it fails to correspond with the conditions which a law-book older than the exile would have had to satisfy. After the final destruction of the kingdom by Nebuchadnezzar, they found in the ritual and *personnel* of the temple at Jerusalem the elements out of which a new commonwealth could be built, in conformity with the circumstances and needs of the time. The community of Judæa raised itself from the dust by holding on to its ruined sanctuary. The old usages and ordinances were reshaped in detail, but as a whole they were not replaced by new creations; the novelty lay in their being worked into a system and applied as a means to organize the "remnant" of Israel. This was the origin of the sacred constitution of Judaism. Religion

in old Israel had been a faith which gave its support to the natural ordinances of human society; it was now set forth in external and visible form as a special institution, within an artificial sphere peculiar to itself, which rose far above the level of common life. The necessary presupposition of this kind of theocracy is service to a foreign empire, and so the theocracy is essentially the same thing as hierocracy. Its finished picture is drawn in the Priestly Code, the product of the labours of learned priests during the exile. When the temple was destroyed and the ritual interrupted, the old practices were written down that they might not be lost. Thus in the exile the ritual became matter of teaching, of Torah; the first who took this step, a step prescribed by the circumstances of the time, was the priest and prophet Ezekiel. In the last part of his book Ezekiel began the literary record of the customary ritual of the temple; other priests followed in his footsteps (Lev. xvii.-xxvi.); and so there arose during the captivity a school of men who wrote down and systematized what they had formerly practised. When the temple was restored this theocratic zeal still went on and produced further ritual developments, in action and reaction with the actual practice of the new temple; the final result of the long-continued process was the Priestly Code.

This Code, incorporated in the Pentateuch and forming the normative part of its legislation, became the definitive Mosaic law. As such it was published and put in action in 444 B.C. by the Babylonian priest and scribe Ezra. Ezra had come to Jerusalem as early as 458, at the head of a considerable body of zealous Jews, with full authority from Artaxerxes Longimanus to reform the community of the second temple in accordance with the law of God in his hand. But Ezra did not introduce this law immediately on his arrival; it took him fourteen years to effect his purpose. The external circumstances of the young community, which were exceedingly unfavourable, made it at first undesirable to introduce legislative innovations; perhaps, also, Ezra needed time to correct the product of Babylonian learning by the light of Judean practice, and wished, moreover, to train assistants for his task. The chief reason of the delay seems, however, to have been that, in spite of the royal favour, he could not get any energetic support from the local representatives of the Persian Government, and without this he could not have given authority to his new law. But in 445 a kindred spirit, Nehemiah b. Hakkeleiah, came to Jerusalem as Persian governor of Judæa. Ezra's opportunity had now arrived, and he was able to introduce the Pentateuch in agreement with the governor. The record of this step is contained in Neh. viii.-x.; it is closely analogous to the narrative of the introduction of the Deuteronomic law under Josiah in 2 Kings xxii. Just as we are told there that Deuteronomy became known in 621 B.C., having been unknown previously, so we are told here that the Torah in the rest of the Pentateuch became known in 444, and was unknown till that date. This shows us, in the first place, that Deuteronomy contains an earlier stage of the law than the priestly Torah. And further, as the date of Deuteronomy can be inferred from the date of its publication and introduction under Josiah, so in like manner the date of the composition of the Priestly Code can be inferred from its publication and enforcement by Ezra and Nehemiah.

The establishment of the right date for the written law is of the highest importance for our understanding of the prophets, and for our whole conception of the history of Israel. See the articles ISRAEL and PROPHET. (J. W.)

**PENTECOST**, a feast of the Jews, was in its original meaning, as has been explained in *PENTATEUCH* (*supra*, p. 511), the closing feast of the harvest gladness, at which,

according to Lev. xxiii. 17, leavened bread was presented at the sanctuary as the firstfruits of the new cereal store. Hence the names "Feast of Harvest" (Exod. xxiii. 16), "Day of Firstfruits" (Num. xxviii. 26); but the commoner Old Testament name (Exod. xxxiv. 22; Deut. xvi. 10, 16; 2 Chron. viii. 13) is "Feast of Weeks," because it fell exactly seven weeks (Deut. xvi. 9), or, on the Jewish way of reckoning an interval by counting in both termini, just fifty days (Lev. xxiii. 16) after the offering of the first sheaf of the harvest at the Feast of Unleavened Bread. Pentecost or "Fiftieth" day is only a Greek equivalent of the last name (*πεντηκοστή* in the Apocrypha and New Testament). The orthodox later Jews reckoned the fifty days from the sixteenth of Nisan, cutting the ritual sheaf on the night of (that is, on our division of days, the night preceding) that day (see *PASSOVER*). In Deuteronomy Pentecost, like the other two great annual feasts, is a pilgrimage feast (Deut. xvi. 16), and so it was observed in later times; but, unlike the others, it lasts but one day, agreeably to its character (expressed in the name ΠΝΥΨ, Ἄσραφά, given to it by Josephus and the later Jews) as merely the solemn closing day of harvest-time. Like the other great feasts, it came to be celebrated by fixed special sacrifices. The amount of these is differently expressed in the earlier and later priestly law (Lev. xxiii. 18 sq.; Num. xxviii. 26 sq.); the discrepancy was met by adding the two lists. The later Jews also extended the one day of the feast to two. Further, in accordance with the tendency to substitute historical for economic explanations of the great feasts, Pentecost came to be regarded as the feast commemorative of the Sinaitic legislation.

To the Christian church Pentecost acquired a new significance through the outpouring of the Spirit (Acts ii.). See *WHITSUNDAY*.

**PENZA**, a government of eastern Russia, bounded on the N. by Nijni Novgorod, on the E. by Simbirak, and on the S. and W. by Saratoff and Tamboff, and having an area of 15,000 square miles. The surface is undulating, with deep valleys and ravines, but even in its highest parts it does not reach more than 600 to 900 feet above sea-level. It is chiefly made up of Cretaceous sandstones, sands, marls, and chalk, covered in the east by Eocene deposits. Chalk, potter's clay, peat, and iron are the chief mineral products, in the north. The soil is a black earth, more or less mixed with clay and sand; the only marshes of any extent occur in the Krasnolobodak district; and considerable sand-areas appear in the broad valleys of the larger rivers. There are extensive forests in the north, but the south shows the characteristic features of a steppe-land. The government is watered by the Moksha, the Sura (both navigable), and the Khoper, belonging respectively to the Oka, Volga, and Don systems. Timber is floated down several smaller streams, while the Moksha and Sura are important means of conveyance for grain, spirits, timber, metals, and oils. The climate is harsh and continental, the average temperature at Penza being only 39°·8 (12°·2 in January and 68°·5 in July).

The population—1,356,600 in 1881, and in 1884 estimated at about 1,465,000—consists principally of Russians, mixed to some extent with Mordvinians; there are also about 150,000 Mordvinians who are to a large extent Russified; some 40,000 Mescheryaks, who have undergone the same process still more fully; and 60,000 Tatars, who still keep their own religion, language, and customs. The Russians profess the Greek faith, and very many, especially in the north, are Beakolnicks. Somewhat less than 10 per cent. of the population (133,250 in 1881) live in towns; the chief occupation of the inhabitants is agriculture, 61 per cent. of the soil being arable. Wheat and rye are raised only to a limited extent, the chief crops being rice, oats, buckwheat, hemp, potatoes, and beetroots. The averages for 1870-77 were 3,900,000 quarters of corn and 1,779,200 bushels of potatoes. The chief centres of corn export are Penza, Narovtshat, and Golovinahtchina. Market-gardening is successfully

carried on in several districts, and improved varieties of fruit-trees are being introduced through the imperial botanical garden at Penza and a private school of gardening in the Gorodiatshche district. Fourteen per cent. of the area is under meadows or grazing land; and in 1881 there were within the government 244,000 head of cattle, 383,000 horses, and 235,000 pigs. Sheep-breeding is especially developed in Tchambar and Insar (670,000 sheep, including 72,000 of finer breeds, in 1881). The Mordvinians are very partial to bee-keeping. The forests (620,000 acres) are a considerable source of wealth, especially in Krasnolobodak and Gorodiatshche, whence timber, a variety of wooden wares, and also pitch and tar are exported to the south. As many as 30 per cent. of the adult male population leave the government in search of employment, either on the Volga or in southern Russia.

The manufactures are few, employing only 13,300 hands. The yearly returns in 1879 did not exceed 13,325,000 roubles (£1,332,500). The distilleries come first (£973,200), followed by the woollen cloth industry (£227,000), the paper industry (£37,200), tanneries, soap-works, glass-works, machine-works, iron-works, and beetroot-sugar factories. Trade, which has been favoured by the completion of the railway from Tula to Samara, is still limited to the export of corn, spirits, timber, hemp-seed oil, tallow, hides, honey, wax, some woollen cloth, potash, and cattle, the chief centres for trade being Penza, Nijni Lomoff, Mokshan, Saransk, Krasnolobodak, and Golovinshchina.

The government is divided into ten districts, the chief towns of which are—Penza (41,650), Gorodiatshche (3200), Insar (5230), Kerenak (12,450), Krasnolobodak (7000), Mokshan (13,050), Narovtchat (5150), Nijni Lomoff (10,500), Saransk (13,450), and Tchambar (6320). Troitak (5700), Verkhni Lomoff (7300), and Shehkeeff (3500) also have municipal institutions.

The present government of Penza was formerly inhabited by Mordvinians, who had the Mescheryaks in the west, the Bulgars in the north, and the Burtases in the south. In the 13th century these populations fell under the dominion of the Tatars, with whom they fought against Moscow. As early as the 14th century they possessed the town of Narovtchat. The Russians penetrated into the country in the 16th century, founding the town of Mokshan in 1535, and several others in the course of that and the following centuries. Penza was founded in the beginning of the 17th century, the permanent Russian settlement dating as far back as 1666. Its wooden fort, on the site of the present cathedral of the Saviour, protected the neighbourhood against risings of the Mordvinians and Mescheryaks. In 1776 it was taken by Pugatcheff. The town was almost totally destroyed by the great conflagrations of 1836, 1839, and 1858.

**PENZA**, capital of the above province, is situated 440 miles by rail south-east from Moscow. It is mostly built of wood, on the slopes of a plateau 730 feet above the sea, at the confluence of the little Penza with the navigable Sura. The Spasoprebrazheny cathedral was built in the end of the 17th century, the monastery of the same name, which formerly adjoined it, being now in the suburbs. A few educational and philanthropic institutions, a theatre which has played some part in the history of the Russian stage, and a municipal bank are the chief buildings of Penza, which derives its importance chiefly from its being the seat of the provincial authorities and the see of a bishop. The great bulk of the inhabitants are peasants, who support themselves by agriculture or fishing in the Sura, some artisans, and a few merchants. An imperial botanical garden is situated within 2 miles of the town. Apart from a paper-mill and two steam flour-mills, the manufacturing establishments (producing soap, candles, wax-candles, cosmetics, machinery), distilleries, breweries, and saw-mills are small. Trade in corn, oil, tallow, and spirits is on the increase. There are two fairs where cattle and horses are sold for export, grocery and manufactured wares being the corresponding imports. The population in 1881 had reached 41,650.

**PENZANCE**, a seaport and municipal borough of Cornwall, and the westernmost borough of England, is finely situated on gently rising ground on the north-western shore of Mount Bay, at the terminus of the Great Western Railway, 10 miles east-north-east of Land's End and 20 west-south-west of Truro. It is the nearest port to the Scilly Isles, which are about 40 miles distant to the west-south-west. The market-place is in the centre of the town, and near it the four principal streets intersect each other at

right angles. The southern arm of the pier was built in 1772, the Albert or new pier on the east in 1845. The piers are connected by a wharf, viaduct, and swing-bridge (1832); and a dock is being at present constructed at a cost of £60,000, which will extend to about 3 acres. The limits of the port have lately (1884) been extended. The churches are St Mary's, constructed of cut granite, in the Perpendicular style, with lofty pinnacled tower and peal of eight bells; St Paul's, of cut and rubble granite, in the style of the 13th century (1843); and St John's, of stone, Early English (1881). The public buildings, erected of granite in the Italian style in 1867, include the town-hall and council-chambers, St John's Hall for public meetings, the lecture-hall, the public library (upwards of 16,000 volumes), the news-rooms, the masonic hall, the museum of the Penzance Natural History and Antiquarian Society, and the museum and other rooms of the Geological Society of Cornwall. The market-house (1837), in the Grecian style, with a central dome, includes a meat-market on the ground-floor with a corn-market above, and in the east end of the building is the grammar-school, founded in 1789. In front of the east end is a marble statue of Davy. Somewhat east of the market-house are the post and telegraph offices, completed in 1883. Among the benevolent institutions is the West Cornwall Infirmary (1874), which includes the dispensary (1809). The town has a considerable shipping trade, the total number of vessels which entered the port in 1882 being 1829 of 197,933 tons burden, the number which cleared 1774 of 187,569 tons. The exports include tin, copper, granite, serpentine, and fish, and the imports coal, timber, and provisions. Large quantities of pilchard are annually exported to Italy. Fruits, flowers, and vegetables are grown in the neighbourhood for the London market. On account of its sheltered situation and its remarkably mild and equable climate, the town has a high repute as a winter residence for persons suffering from pulmonary complaints; and on account of its fine scenery it is also becoming a favourite watering-place. The population of the municipal borough in 1871 was 10,414, and in 1881 it was 12,409.

Penzance is said to mean "holy head," the name being derived from a chapel dedicated to St Anthony, formerly situated on a head-land now forming the base of the old pier, around which a few fishermen built their huts and thus originated the town. A castle built by the Tyes, possessors of the manor of Alwerton or Alverton, is supposed to have occupied the present site of St Mary's Church. Alice de Liale, sister and heiress of the last Baron Tyes, obtained for the town the grant of a weekly market from Edward III. In the 15th century Penzance was known as a "place of ships and merchandise;" and on the 16th March 1513 it received from Henry VIII a charter granting to the inhabitants all profits arising from ships visiting the harbour upon condition that the quays and bulwarks of the town were kept in repair. In 1595 the town was burned and pillaged by the Spaniards, and in 1644 sacked by Fairfax. In 1614 it was incorporated by James I.; and in 1668 it obtained a coinage charter,—a privilege it retained till 1838. On account of the usurpation of its chief magistracy its municipal charter was forfeited in the beginning of the reign of Queen Anne, but was restored in 1706. By the Municipal Act of 1835 the government was made to consist of a mayor, six aldermen, and eighteen councillors.

Lech-Sayma, History of Penzance, 1878; Millett, Penzance Past and Present, 1876-1880.

**PEONY.** See **PEONY.**

**PEORIA**, a city of the United States, capital of Peoria county, Illinois, lies on the edge of a rolling prairie at the lower end of the so-called Lake Peoria, an expansion of the Illinois river, and is connected by the Michigan Canal with Chicago. It is a flourishing place, the meeting-point of nine railway lines, the trading centre for an extensive district, and the seat of a large grain traffic and of various manufactures; 117,158,670 proof gallons of high wines were made in 1883. From 5095 in 1850 its population increased to 14,045 in 1860, 22,849 in 1870, and 29,259 in 1880. Though its permanent settlement dates

only from 1811 and its city charter from 1844, Peoria was one of the trading ports established by La Salle (1690), and was long known as a point of some importance on the route between Canada and Louisiana.

PEPPER, a name applied to several pungent spices known respectively as Black, White, Long, Red or Cayenne, Ashantea, Jamaica, and Melegueta Pepper, but derived from at least three different natural orders of plants.

*Black pepper* is the dried fruit of *Piper nigrum*, L., a perennial climbing shrub indigenous to the forests of Travancore and Malabar, from whence it has been introduced into Java, Sumatra, Borneo, the Malay Peninsula, Siam, the Philippines, and the West Indies. It is one of the earliest spices known to mankind, and for many ages formed a staple article of commerce between India and Europe,—Venice, Genoa, and the commercial cities of central Europe being indebted to it for a large portion of their wealth. Tribute has been levied in pepper; one of the articles demanded in 408 by Alaric as part of the ransom of Rome was 3000 lb of pepper. Pepper-corn rents prevailed during the Middle Ages, and consisted of an obligation to supply a certain quantity of pepper, usually 1 lb, at stated times; and the term still lingers in use at the present day. The price of the spice during the Middle Ages was exorbitantly high, and its excessive cost was one of the inducements which led the Portuguese to seek a sea-route to India. The discovery of the passage round the Cape of Good Hope led (1498) to a considerable fall in the price, and about the same time the cultivation of the plant was extended to the western islands of the Malay Archipelago.

Pepper, however, remained a monopoly of the Portuguese crown as late as the 18th century. In Great Britain it was formerly taxed very heavily, the impost in 1623 amounting to 5s., and as late as 1823 to 2s. 6d. per lb.

The largest quantities of pepper are produced in Penang, the island of Rhio, and Johore near Singapore,—Penang affording on an average about half of the entire crop. Singapore is the great emporium for this spice in the East, the largest proportion being shipped thence to Great Britain. In 1880 the imports into England from Singapore amounted to 21,179,059 lb, valued at £385,108, and from other countries 559,909 lb, valued at £12,979, the re-exports being 12,925,886 lb, chiefly to Germany, Italy, Russia, Holland, and Spain. The varieties of black pepper met with in commerce are known as Malabar, Aleppy or Tellicherry, Cochin, Penang, Singapore, and Siam. The average market value in the London market is—Malabar, 3½d to 5½d per lb; Penang, 2½d to 4½d; Singapore, 3½d to 4½d.

Pepper owes its pungency to a resin, and its flavour to a volatile oil, of which it yields from 1·6 to 2·2 per cent. The oil agrees with oil of turpentine in composition as well as

in specific gravity and boiling point. In polarized light it deviates the ray, in a column 50 mm. long, 1°·2 to 3°·4 to the left. Pepper also contains a neutral crystalline substance, called piperin, to the extent of 2 to 8 per cent. This substance has the same empirical formula as morphia,  $C_{17}H_{19}NO_9$ , but differs in constitution and properties. It is insoluble in water when pure, is devoid of colour, flavour, and odour, and may be resolved into piperic acid,  $C_{17}H_{10}O_9$ , and piperidin,  $C_8H_{11}N$ . The latter is a liquid colourless alkaloid, boiling at 106° C., has an odour of pepper and ammonia, and yields crystallizable salts. A fatty oil is found in the pericarp of pepper, and the berries yield on incineration from 4·1 to 5·7 of ash. The only use of pepper is as a condiment. Notwithstanding its low price and the penalty of £100 to which the manufacturer, possessor, or seller of the adulterated article is liable, powdered pepper is frequently diluted with starch, sago, meal, and other substances, which can be readily detected under the microscope.<sup>1</sup>

In the south-west of India, where the pepper-plant grows wild, it is found in rich, moist, leafy soil, in narrow valleys, propagating itself by running along the ground and giving off roots into the soil. The only method of cultivation adopted by the natives is to tie up the end of the vines to the neighbouring trees at distances of at least 6 feet, especially to those having a rough bark, in order that the roots may easily attach themselves to the surface. The underwood is then cleared away, leaving only sufficient trees to provide shade and permit free ventilation. The roots are manured with a heap of leaves, and the shoots are trained twice a year. In localities where the pepper does not grow wild, ground is selected which permits of free drainage, but which is not too dry nor liable to inundation, and cuttings are planted at about a foot from the trees either in the rainy season in June or in the dry season in February. Sometimes several cuttings about 18 inches long are placed in a basket and buried at the root of the tree, the cuttings being made to slope towards the trunk. In October or November the young plants are manured with a mixture of leaves and cow-dung. On dry soils the young plants require watering every other day during the dry season for the first three years. The plants bear in the fourth or fifth year, and if raised from cuttings are fruitful for seven years, if from seed for fourteen years. The pepper from plants raised from cuttings is said to be superior in quantity and quality, and this method is in consequence most frequently adopted. Where there are no trees the ground is made into terraces and enclosed by a mud-wall, and branches of *Erythrina indica* are put into the ground in the rainy season and in the course of a year are capable of supporting the young pepper plants. In the meantime mango trees are planted, these being preferred as supports, since their fruit is not injured by the pepper plant, while the *Erythrina* is killed by it in fourteen or fifteen years.

In Sumatra the ground is cleared, ploughed, and sown with rice, and cuttings of the vine are planted in September 5 feet apart each way, together with a sapling of quick growth and rough bark. The plants are now left for twelve or eighteen months and then entirely buried except a small piece of bent stem, whence new shoots arise, three or four of which are allowed to climb the tree near which they are planted. These shoots generally yield flowers and fruits the next year. Two crops are collected every year, the principal one being in December and January and the other in July and August, the latter yielding pepper of inferior quality and in less quantity. Two or three varieties are met with in cultivation; that yielding the best kinds has broadly ovate leaves, five to seven in number, nerved and stalked. The flower-spikes are opposite the leaves, stalked and from 3 to 6 inches long; the fruits are sessile and fleshy. A single stem will bear from twenty to thirty of these spikes. The harvest commences as soon as one or two berries at the base of the spikes begin to turn red, and before the fruit is mature, but when full-grown and still hard; if allowed to ripen, the berries lose pungency, and ultimately fall off and are lost. The spikes are collected in bags or baskets and dried in the sun, on mats or hard ground, for two or three days. When dry the pepper is put into bags containing from 64 to 128 lb, and is then ready for the market. The yield varies in different localities. In Sumatra it is estimated at about 1½ lb per plant per annum. In Malabar each vine gives 2 lb a year up to the fifteenth or twentieth year, or about 24 lb from each tree, a single tree sometimes supporting eight or twelve vines: an acre is calculated to bear 2500 plants, to cost about £4 in outlay to bring it into bearing, and to yield a produce of £80 when in its best condition.

<sup>1</sup> Hassall, *Food and its Adulteration* (1855), p. 42, and Evans, *Pharm. Journ.*, [2] i. p. 605.



*Piper nigrum*. a, Twig with fruit; b, longitudinal section of flower; c, section of fruit.

*White pepper* is obtained from the same plant as the black, and differs only in being prepared from the ripe fruits. These, after collection, are kept in the house three days and then bruised and washed in a basket with the hand until the stalks and pulpy matter are removed, after which the seeds are dried. It is, however, sometimes prepared from the dried black pepper by removing the dark outer layer. It is less pungent than the black but possesses a finer flavour. It is chiefly prepared at the island of Rhio, but the finest comes from Tellicherry. The Chinese are the largest consumers. In 1877 Singapore exported 48,461 piculs (a picul = 133½ lb) to that country. The London market value is about 4½d to 7d per lb. White pepper affords on an average not more than 1·9 per cent. of essential oil; but, according to Cazeneuve, as much as 9 per cent. of piperin, and of ash not more than 1·1 per cent.

*Long pepper* is the fruit-spike of *Piper officinarum*, C. DC., and *P. longum*, L., gathered shortly before it reaches maturity and dried. The former is a native of the Indian Archipelago, occurring in Java, Sumatra, Celebes, and Timor. It has oblong, ovate, acuminate leaves, attenuated to the base, which are pinnate and veined. The latter is indigenous to Ceylon, Malabar, eastern Bengal, Timor, and the Philippines; it is distinguished from *P. officinarum* by the leaves being cordate at the base and five-veined. Long pepper appears to have been known to the ancient Greeks and Romans under the name of *πέπερι μακρόν*; and in the 10th century mention is made of long pepper, or macropiper, in conjunction with black and white peppers. The spice consists of a dense spike of minute baccate fruits closely packed around the central axis, the spike being about 1½ inch long and ¼ inch thick; as met with in commerce they have the appearance of having been limed. In Bengal the plants are cultivated by suckers, which are planted about 5 feet apart on dry rich soil on high ground. An English acre will yield about 3 maunds (80 lb) the first year, 12 the second, and 18 the third year; after this time the yield decreases, and the roots are therefore grubbed up and sold as *pipi's mul*, under which name they are much used as a medicine in India. After the fruit is collected, which is usually in January, the stem and leaves die down to the ground. Long pepper contains piperin, resin, and volatile oil, and yields about 8 per cent. of ash. Penang and Singapore are the principal centres in the East for its sale. In 1871 Singapore shipped 3366 cwt., of which 447 were sent to Great Britain. Penang exports annually about 2000 to 3000 piculs. The value in the London market is from 37s. to 45s. a cwt.

*Ashantee* or *West African pepper* is the dried fruit of *Piper Clusii*, C. DC., a plant widely distributed in tropical Africa, occurring most abundantly in the country of the Niam-niam. It differs from black pepper in being rather smaller, less wrinkled, and in being attenuated into a stalk, like cubebs, to which it bears considerable resemblance externally. The taste, however, is pungent, exactly like that of pepper, and the fruit contains piperin. It was imported from the Grain Coast by the merchants of Rouen and Dieppe as early as 1364, and was exported from Benin by the Portuguese in 1485; but, according to Clusius, its importation was forbidden by the king of Portugal for fear it should depreciate the value of the pepper from India. In tropical Africa it is extensively used as a condiment, and it could easily be collected in large quantities if a demand for it should arise.

*Jamaica pepper* is the fruit of *Pimenta officinalis*, Lindl., an evergreen tree of the Myrtle family. It is more correctly termed "pimento," or "allspice," as it is not a true pepper.

*Melegueta pepper*, known also as "Guinea grains," "grains of paradise," or "alligator pepper," is the seed of

*Anomum Melegueta*, Roscoe, a plant of the Ginger family; the seeds are exceedingly pungent, and are used as a spice throughout central and northern Africa. See vol. vi. p. 36.

For *Cayenne pepper*, see vol. v. p. 280. (E. M. H.)

PEPPERMINT, an indigenous perennial herb of the natural order *Labiatae*, and genus *Mentha*, the specific name being *Mentha Piperita*, Huds., is distinguished from other species of the genus by its stalked leaves and oblong-ovate spike-like heads of flowers. It is met with, near streams and in wet places, in several parts of England and on the Continent, and is also extensively cultivated for the sake of its essential oil in England,<sup>1</sup> in several parts of continental Europe, and in the United States. Yet it was only recognized as a distinct species late in the 17th century, when Dr Eales discovered it in Hertfordshire and pointed it out to Ray, who published it in the second edition of his *Synopsis Stirpium Britannicarum* (1696). The medicinal properties of the plant were speedily recognized, and it was admitted into the *London Pharmacopœia* in 1721, under the name of *Mentha piperitis sapor.*

Two varieties are recognized by growers, the one being known as white and the other as black mint. The former has purplish and the latter green stems; the leaves are more coarsely serrated in the white. The black is the variety more generally cultivated, probably because it is found to yield more oil, but that of the green variety is considered to have a more delicate odour, and obtains a higher price. The green is the kind chiefly dried for herbalists; it is said to be of less vigorous growth than the black. The annual yield of peppermint oil from all parts of the world has been estimated at 90,000 lb, but this is probably much below the mark, without taking into consideration the Chinese and Japanese oils of peppermint, which, however, are obtained from a different species of mint.

Peppermint oil varies considerably in commercial value, that of Mitcham commanding nearly three times the price of the finest American. The flavour varies to a slight extent even with particular plots of land, badly drained ground being known to give unfavourable results both as to the quantity and quality of the oil. That of the Japanese and Chinese oil also differs slightly from the English, and is thus distinguishable by experts. In America the oil is liable to be injured in flavour by aromatic weeds which grow freely among the crop, the most troublesome of these being *Erigeron canadense*, L., and *Erechtithis hieracifolia*, Raf. When pure the oil is nearly colourless and has an agreeable odour and powerful aromatic taste, followed by a sensation of cold when air is drawn into the mouth. It has a specific gravity of 0·84 to 0·92, and boils at 365° Fahr. Mitcham oil, when examined by polarized light in a column 50 mm. long, deviates from 14° 2' to 10° 7'



FIG. 1.—*Mentha Piperita*. a, Flowering branch; b, flower showing form of calyx teeth.

<sup>1</sup> Near Mitcham in Surrey (219 acres in 1864), Wisbech in Cambridgeshire, Market Deeping in Lincolnshire (150 acres in 1881), and Hitchin in Hertfordshire.



to the left, the American 4°3. When oil of peppermint is cooled to 4° C. it sometimes deposits colourless hexagonal prisms of menthol,  $C_{10}H_{20}O$ , which are soluble in alcohol and ether, almost insoluble in water, and fusible at 92° Fahr. The liquid portion of the oil appears to consist chiefly of the compound  $C_{10}H_{18}O$ , but it has not been thoroughly investigated. Oil of peppermint is often adulterated with a third part of rectified spirit, which may be detected by the milkiness produced when the oil is agitated with water. Oil of rosemary and rectified oil of turpentine are sometimes used for the same purpose. If the oil contains turpentine it will explode with iodine. If quite pure it dissolves in its own weight of rectified spirits of wine.

Peppermint oil is largely distilled at Canton, a considerable quantity (about 300 cattiees annually) being sent to Bombay, also about 600 cattiees of menthol. The exports from Canton in 1883 amounted to about 1200 lb. The species cultivated in the neighbourhood of Canton, and probably at Shanghai also, is *Mentha arvensis*, var. *glabrata*. Peppermint is chiefly cultivated in the province of Keang-se; and according to native statements as much as 40 piculs of oil of peppermint are sent annually to ports on the coast. In Japan also the distillation of oil of peppermint forms a considerable industry, the plant cultivated being *M. arvensis*, var. *piperascens* (see *Ph. Journ.* [3] vol. ii. p. 324), of which both a purplish and a white form appear to be grown. The oil, under the name of *hakka no abura*, is exported from Hiogo and Ozaka, but is said to be frequently adulterated. Since 1872 the peppermint camphor or menthol has been largely exported in the separate state from Japan to Germany and Great Britain. The menthol is obtained by subjecting the oil to a low temperature, when it crystallizes out and is separated. The two varieties of *M. arvensis* just named yield much more menthol than *M. Piperita*. It is remarkable, however, that the *M. arvensis*, var. *javanica*, Blume, growing in Ceylon, has not the flavour of peppermint but that of garden mint, while the typical form of *M. arvensis* grown in Great Britain has an odour so different from peppermint that it has to be carefully removed from the field lest it should spoil the flavour of the peppermint oil when the herb is distilled. *M. incana*, Willd., cultivated near Bombay as a herb, also possesses the flavour of peppermint. In the form in which menthol is imported it bears some resemblance to Epsom salts, with which it is said to be sometimes adulterated. It is usually not entirely free from the essential oil, and consequently undergoes purification and recrystallization in England and on the Continent. The amount of menthol imported by a large firm at Leipsic between September 1883 and April 1884 is stated by them to have been 6380 lb, while it is certain that at least an equal quantity is imported into England from Yokohama. Although the Japanese peppermint plant has been imported by a London merchant, no attempt has as yet been made to cultivate the plant in order to manufacture menthol in England. Menthol is now (1884), however, manufactured from *M. Piperita* in the United States, where also *M. arvensis*, var. *piperascens*, is cultivated.



FIG. 2.—*Mentha arvensis*, var. *piperascens*. a, Flowering branch; b, calyx showing form of teeth.

Oil of peppermint is used in medicine as an antispasmodic for the relief of griping pains in the alimentary canal, to expel flatulence, to relieve nausea, to hide the taste of other medicines, and to act as an adjunct to purgatives. The dose is usually from one to three minima. It forms a most valuable remedy in diarrhoea, acting as an antiseptic, and as a stimulant to the circulation, and as an anodyne. The oil rubbed over the head is used in China to cure sunstroke. Menthol has lately come largely into use as a remedy for neuralgia, being moulded by heat into the form of small cones, which are rubbed over the part affected. A small portion placed on the tongue frequently relieves headache, and catarrh and coryza if placed in the nostril. The largest consumption of the oil is in the manufacture of peppermint lozenges.

The following mode of cultivation is adopted by Mr Holland, at Market Deeping. A rich friable soil, retentive of moisture, is selected, and the ground is well tilled 8 to 10 inches deep. The plants are propagated in the spring, usually in April and May. When the young shoots from the crop of the previous year have attained a height of about 4 inches they are pulled up and transplanted into new soil. They grow vigorously the first year, and throw out numerous stolons on the surface of the ground. After the crop has been removed these are allowed to harden or become woody, and then farmyard manure is scattered over the field and ploughed in. In this way the stolons are divided into numerous pieces, and covered with soil before the frost sets in. If the autumn is wet they are liable to become sodden, and rot, and the next crop fails. In the spring the fields are dressed with Peruvian guano. In new ground the peppermint requires hand-weeding two or three times, as the hoe cannot be used without injury to the plants. Moist heavy weather in August is apt to cause the foliage to drop off and leave the stems almost bare. Under these circumstances rust (*Puccinia Menthae*) also is liable to attack the plants. This is prevented to a certain extent by a rope being drawn across the plants, by two men walking in the furrows, so as to remove excessive moisture. The average yield of peppermint is about 165 cwt. per acre. The first year's crop is always cut with the sickle to prevent injury to the stolons. The herb of the second and third year is cut with scythes, and then raked by women into loose heaps ready for carting. The field is then gleaned by boys, who add what they collect to the heaps. The plants rarely yield a fourth crop on the same land. The harvest usually commences in the beginning or middle of August, or as soon as the plants begin to flower, and lasts for six weeks, the stills being kept going night and day. The herb is carted direct from the field to the stills, which are made of copper, and contain about 5 cwt. of the herb. Before putting the peppermint into the still water is poured in to a depth of about 2 feet, at which height a false bottom is placed, and on this the herb is thrown and trodden down by men. The lid, which fits into a water-joint, is then let down by pulleys and fastened by two bars, any excess of pressure or temperature being indicated by the water that is ejected at the joint. The distillation is conducted by the application of direct heat at the lowest possible temperature, and is continued for about four and a half hours. When this operation is completed, the lid is removed and a rope is attached to a hook on the false bottom, which, as well as the herb resting on it, is raised bodily by a windlass and the peppermint carried away in the empty carts on their return journey to the fields, where it is placed in heaps and allowed to rot, being subsequently mixed with the manure applied in the autumn as above stated.

At Mitcham extra payment is given to the reapers to induce them to keep the mint free from corn mint (*Mentha cretica*) and other herbs, which would injure or spoil the flavour of the oil if not removed before distillation. The usual yield of oil, if the season be warm and dry, is said to be 1 oz. from 5 lb of the fresh flowering herb, but, if wet and unfavourable, the product is barely half that quantity. Mr Holland estimates the yield of a charge of the still at from 1 lb 12 oz. to 5 lb. The oil improves in mellowness even if kept as long as ten or fourteen years. The green colour sometimes present in the oil is stated to be due to a quantity of water larger than necessary having been used in the distillation; on the other hand, if the herb be left in the still from Saturday to Monday, the oil assumes a brown tint.

In France peppermint is cultivated on damp rich ground at Sens, in the department of the Yonne. In Germany it is grown in the neighbourhood of Leipsic, where the little town of Colleda produces annually as much as 40,000 cwt. of the herb. In the United States peppermint is cultivated on a most extensive scale, chiefly in southern Michigan, the west districts of New York State, and Ohio. The amount of peppermint oil now produced in the United States has been estimated at 70,000 lb annually, of which 30,000 lb are exported, about two-thirds of this quantity being produced in



New York State and the remaining one-third in Michigan. The yield averages from 10 to 30 lb per acre. The cultivation of peppermint has recently been extended to the southern States. In Michigan the plant was introduced in 1855, and in 1858 there were about 2100 acres under cultivation, and 100 distilleries yielding 15,000 lb of oil. In 1870 one of the best-known growers of New York State is said to have sent out as much as 57,865 lb. In 1876 the United States exported to Hamburg 25,840 lb of peppermint oil against 14,890 lb sent by Great Britain to the same port. (R. M. H.)

**PEPPER TREE.** The tree usually so called has no real consanguinity with the true pepper (*Piper*), but is a member of the Anacard family known botanically as *Schinus Mollis* or *Mulli*, the latter epithet representing, it is said, the Peruvian name of the plant. It is a small tree with unequally pinnate leaves, the segments linear, entire or finely saw-toothed, the terminal one longer than the rest, and all filled with volatile oil stored in large cells or cysts, which are visible to the naked eye and appear like holes when the leaf is held up to the light. When the leaves are thrown upon the surface of water the resinous or oily fluid escapes with such force as violently to agitate them. The flowers are small, whitish, arranged in terminal clusters, and polygamous or unisexual, with five sepals, as many petals, ten stamens (as large as the petals in the case of the male flower, very small in the female flower, but in both springing from a cushion-like disk surrounding the base of the three-celled ovary). The style is simple or three-cleft, and the fruit a small, globose, pea-like drupe with a bony kernel enclosing a single seed. The fleshy portion of the fruit has a hot aromatic flavour from the abundance of the resin it contains, and to this circumstance the tree probably owes its popular name. The resin is used for medicinal purposes by the Peruvians, and has similar properties to mastic. The Japan pepper tree is *Xanthoxylum piperitum*, the fruits of which have also a hot taste. Along the Riviera the tree known as *Melia Azedarach*, or the "Pride of India," a very ornamental tree with elegant foliage and dense clusters of fragrant lilac flowers, is also incorrectly called the pepper tree by visitors.

**PEPSIN.** See NUTRITION, vol. xvii. p. 675 *sq.*

**PEPYS, SAMUEL** (1633-1703), was the fifth child of John Pepys and Margaret (Perkins) *Diary*, 17th September 1663, and was born on 23d February 1632/3. His family was of the middle class, and at this time was in humble circumstances, his father being a tailor in London, while an uncle and an aunt, named Perkins, lived in poverty in the Fens near Wisbeach. His father's elder brother Robert had a small property at Brampton in Huntingdonshire, and Samuel was at school at Huntingdon about 1644. Thence he went to St Paul's, London, and on 21st June 1650 was entered as a sizar at Trinity College, Cambridge, but was transferred on 1st October in the same year to Magdalene, where he became pensioner on 4th March following. On 3d April 1651 he was elected scholar on the Spendluffe foundation, and on 4th October 1653 on that of Dr John Smith. Exactly a fortnight afterwards he was admonished by the registrar before all the fellows in residence for being "scandalously overserved with drink the night before." His love of drink, so constantly illustrated in the early pages of his *Diary*, would have been a serious drawback to his advancement, had not his love of work and order been a still stronger impulse. The crisis was reached on Sunday, 29th September 1661, when he was too drunk to trust himself to read prayers to the household. After that he makes resolute vows against wine, which he often breaks, and with regard to which he displays curious powers of self-deception.

Nothing more is known of Pepys's college career, though he tells us that he was addicted to writing romances. He became a moderate classical scholar; it is, however, a curious commentary upon the university training of those

days that, after his appointment to the navy board, he is found busy with the multiplication table, which he speaks of as entirely new to him, and of his daily progress in which he is not a little proud. After this he becomes enamoured of arithmetic and teaches his wife the science also.

In October<sup>1</sup> 1655 Pepys married Elizabeth St Michel, a girl of fifteen, of great beauty, whose father, a Huguenot refugee in England, was at this time in very poor circumstances. She was a good cook and a good house-keeper, and was both clever and warm-tempered; Pepys, vain, quarrelsome, fussy, and pedantic, was unfitted, save by a general goodness of heart, to manage a high-spirited girl; and the pages of the *Diary* are full of bickerings and downright quarrels arising out of trifles, the entries of which, though often amusing, are as often extremely pathetic. Pepys and his wife, who were destitute of funds, were received by Sir Edward Montagu, afterwards earl of Sandwich, whose mother had married Pepys's grandfather. Pepys probably acted as Montagu's secretary. He was successfully cut for the stone on 26th March 1657/8, an anniversary which he always notes with gratitude. In March 1658/9 he accompanied Montagu and Algernon Sidney to the Sound on board the "Naseby" (afterwards the "Charles"). To this he more than once refers as the beginning of his fortunes. On his return he was employed as a clerk in the army pay-office of the exchequer under Downing, afterwards Sir George Downing.

In January 1659/60 Pepys began to keep his *Diary*. He was at this time living in Axe Yard, Westminster, in a small house with one servant, on straitened means. On 29th January he can count but £40; his great object is to get on and to "put money in his purse;" and by 24th May 1661 he is worth £500. Political principles he had none, though his personal attachment to James (II.) makes him call himself a Tory; but it is noticeable that even before the Restoration he regularly attended the Church of England service carried on by Peter Gunning, afterwards successively bishop of Chester and of Ely. Of active religious convictions Pepys leaves no trace, but he was ever a steady church-goer; and the epithets he applies to the sermons are very happy in their causticity. In February he went to Cambridge to settle his brother in his old college. One side of what was distinctly a coarse-grained nature is exhibited in an entry during this week, where he describes himself (as on many other occasions) as "playing the fool with the lass of the house." His views of women, indeed, are almost always vulgar; he was given to clumsy gallantry, and he was certainly unfaithful to his wife. In March Montagu gave Pepys the post of secretary to the generals at sea. While the fleet lay off the Dutch coast he made a short journey into Holland. At this time he secured the favour of the duke of York; and he retained it through life. On 28th June he became clerk of the acts of the navy, an office which Montagu had procured for him against powerful competition. A salary of a little over £100 a year, afterwards increased to £350, was attached to the post, but Pepys had to pay an annuity of £100 to his predecessor in office. On 23d July he became clerk of the privy seal, the fees from which, at any rate for a time, brought him in an additional £3 a day (*Diary*, 10th August 1660). In this month he took his M.A. degree. On 24th September he was sworn in as J.P. for Middlesex, Essex, Kent, and Southampton. He now lived in Seething Lane, in front of the navy office, Crutched Friars. In July 1661, on the death of his uncle, the Brampton estate, worth £80 a year, came to his father, and on the latter's

<sup>1</sup> Pepys himself gives 10th October as the date; the registers of St Margaret's church (Westminster) say that the banns were published on 19th, 22d, and 29th October, and that he was married on 1st December. See *Notes and Queries*, 30th August 1884.

death in 1680 to Pepys himself. In July 1662 he was made a younger brother of the Trinity House.

Pepys's untiring industry in office, his prudence, his unflinching usefulness, his knowledge of business, which he was ever diligent to increase, and his general integrity secured him the greatest confidence at headquarters. As early as August 1662, when placed on the Tangier commission, he had found himself "a very rising man." In March 1664/5 he was made treasurer to the commission, and received also the contract for victualling the garrison, both lucrative appointments; and in October, through the influence of Sir W. Coventry, he was further made surveyor-general of the victualling office, a post which he resigned at the conclusion of the peace. His conduct during the Great Plague, when, alone of all the navy board, he stayed in the city of the dead and carried on the whole administration of the navy, was admirable. During the Fire also his readiness and presence of mind were of the greatest service in staying the conflagration.

In the spring of 1667/8, in the blind rage at the national disgrace generally termed the miscarriage of Chatham, the whole navy board were summoned before the House of Commons to give an account of their conduct. Pepys was deputed by his colleagues to conduct the defence, and he did so with complete success on 5th March in a speech of three hours' duration, which gained him great reputation.

In 1669 the increasing weakness of his eyesight compelled him to discontinue the *Diary*, his last entry being on 31st May. What was to us an irremediable misfortune was to Pepys "almost as much as to see myself go into the grave." He now took leave of absence and spent some months in travelling through France and in revisiting Holland. On the day of his return his wife fell ill, and died in the early spring, before 3d March 1669/70. In July 1669 Pepys stood as the duke of York's nominee, backed by the Howard influence, for the borough of Aldborough in Suffolk, but was defeated. In November 1670 we find him engaged in a quarrel with the Swedish resident, which was likely to have been followed by a duel, as Pepys, doubtless to his exceeding comfort (for he was a great coward), received an order from the king neither to send nor accept a challenge. In 1672 he was promoted to the secretaryship of the admiralty; and, when James resigned his office of lord high admiral, Pepys did all the work until the commission was appointed. He was placed also upon the new commission for Tangier.

In June 1673 he was chosen at a by-election, again as James's nominee, for Castle Rising, a Howard borough, but a vote of the committee of privileges declared the election void. Pepys, on the authority of Sir J. Banks and the earl of Shaftesbury, was denounced before the House of Commons as being a Papist; but, when these persons were called upon, they denied any definite knowledge of the altar and crucifix which he was charged with having in his house. The parliament being prorogued, he retained his seat, and is recorded as speaking on 17th May and 26th October 1675, on the latter occasion against the proposal made, in distrust of the crown, to lodge the money for the ships in the chamber of London instead of in the exchequer; and again on 11th May 1678, in the debate on the king's message to quicken supply for the navy, when he was sharply reproved by Sir R. Howard for speaking "rather like an admiral than a secretary, 'I' and 'we,'" an amusing instance of how completely Pepys had obtained control of the business of the navy and had identified himself with the work. He was afterwards, in 1678/9, returned for Harwich (see a note on p. 122 of vol. vi. of Bright's edition of the *Diary*). In the list, however, of members of the parliament which met on 6th

March in that year, which is given by the *Parliamentary History* (vol. iv. p. 1082), the members for Harwich are recorded as being Sir Anthony Deane and Sir Thomas Pepys. An investigation of the records of Harwich leaves no doubt that the *Parliamentary History* is wrong upon this point, and that Pepys did sit for the borough during this parliament.

On 7th August 1677 Pepys was elected master of the Clothworkers' Company, who still possess the silver cup he gave them on the occasion. He continued to hold the secretaryship until 1679, when fresh complaints of miscarriages in the navy were made before the House. The country was then in the throes of the popish terror. Pepys was accused, on the evidence of one Colonel Scott, an infamous character, "a very great vindicator of the Salamanca doctor" (*Intelligencer*, 20th May 1681), of sending secret information regarding the English navy to France (*Intelligencer*, 23d May 1681), and was again charged with being a Papist. On 22d May he was sent, nominally on the first charge, though really on the second, to the Tower, with his colleague Sir Anthony Deane. As he himself wrote to James on 6th May, "a papist I must be, whether I will or no, because favoured by your royal highness." On 2d June he appeared before the King's Bench, and was remanded three times, bail being refused by Jones, the attorney-general. At length Pepys was allowed out on bail for £30,000. The trial was four times postponed, in the hope that evidence would be obtained, and at last on 12th February 1680 he was released only because Scott refused to swear to his depositions, and no prosecutor appeared, and because his old servant, who had given evidence against him, being now on his deathbed, confessed that it was utterly false. This illustrates admirably the wild injustice that prevailed during that feverish time.

In April 1680 Pepys attended the king by command to Newmarket, and there took down in shorthand from his own mouth the narrative of his escape from Worcester. His post had meantime been abolished, or at any rate the constitution of the navy board changed. We find him writing to James on 6th May 1679, asking leave to lay down "this odious secretaryship," and to be placed on the commission of the navy. James urged his claims upon Charles, but the imprisonment in the Tower probably put an end to the affair. In May 1682 Pepys accompanied James when he took the government of Scotland, and while there made with Colonel Legge a tour of the chief towns. In the autumn of 1683 he sailed with the same Colonel Legge, then Lord Dartmouth, on the expedition to destroy the fortifications of Tangier, though not aware when he started of the object of the expedition. The ships reached Tangier on Friday, 14th September. Here he stayed, with the exception of a short visit to Spain, until 5th March, and arrived in London on 6th April.

On his return Pepys was again made secretary to the admiralty. In this same year (1684) he was elected president of the Royal Society. At the coronation of James II. he figured as one of the barons of the Cinque Ports; and he sat in James's parliament for his old seat of Harwich along with his former colleague Sir Anthony Deane,—a fact which illustrates how completely the crown had regained possession of political power in the boroughs. He lost both his seat and his secretaryship at the Revolution, though he was consulted on navy matters to the time of his death. Having been rejected at Harwich in the new elections, he tried in vain to find another seat. His well-known intimacy with and regard for James made him a special object of suspicion to the Government, and in 1690, in common with others suspected for similar reasons, though without cause, he was suddenly arrested and sent to the Gate House, but was almost immediately released,

15th October, on bail (see his letter, Bright, vol. vi. p. 169). He was, however, afraid of fresh attacks as late as Easter 1692 (letter to Evelyn, Bright, vi. p. 173). It was about this time that he published his long-intended *Memoirs of the Navy*. He gave, as in former years, great attention to the government of Christ's Hospital, and especially to the mathematical foundation; and he was concerned with the establishment of Sir William Boreman's mathematical school at Greenwich. He was, too, a benefactor of his old school of St Paul's, and of Magdalene College.

In the spring of 1700, being very ill with the breaking out of the wound caused by the operation of 1658, he removed to the house of his old clerk William Hewer, at Clapham, and, against the urgent advice of his doctors (Bright, Preface), gave himself up to indefatigable study, feeling that his health was restored by the change. He himself, however, on 7th August 1700, wrote in a charming letter<sup>1</sup> that he was doing "nothing that will bear naming, and yet I am not, I think, idle; for who can, that has so much of past and to come to think on as I have!—And thinking, I take it, is working." And he speaks of himself in September as making several country excursions. He was, immediately after this, confined entirely to the house with his old disease of stone, and gradually failed. He bore his long and acute sufferings with extreme fortitude, and died, in reduced circumstances (though he claimed a balance of £28,007 2s 1½d against the crown), on 26th May 1708. He was buried by the side of his wife in St Olave's, Crutched Friars, London, on 5th June. His library of 3000 volumes, which he had collected with much labour and sacrifice, and which he would not allow to be divided, was bequeathed to Magdalene College.

The last fact to be recorded of Pepys is that on 18th March 1884, two centuries after his official employment, a monument was unveiled in the church where he was buried to the "Clerk of the Acts and Secretary to the Admiralty" (*Times*, 19th March 1884).

The importance of Pepys's *Diary*, historically speaking, may be summed up by saying that without it the history of the court of Charles II. could not have been written. We do not, it is true, gain from it any information as to what was going on in the country. Utterly destitute of imagination or political knowledge, Pepys could only record the sights and the gossip that were evident to all. It is because he did record these, without hesitation or concealment, that from his *Diary* we can understand the brilliancy and wickedness of the court, as well as the social state and daily life of the bourgeois class. Viewed in another light, it is unique as the record of a mind formed of inconsistencies. To him especially would his own motto apply, "Mens cunisque, is est quisque." Probity in word and integrity in office, along with self-confessed mendacity and fraud; modesty, with inordinate self-conceit; independence of mind, with the vulgarest striving after and exultation at the marks of respect which he receives as he rises in the world, and at little advantages gained over others; high-mindedness, with sordid spite; dignity, with buffoonery; strong common sense, with great superstition; kindness, with brutality; the eager pursuit of money, with liberality in spending it,—such are a few of the more obvious contrasts. He gained his reputation by fair means, and yet was willing enough to lie in order to increase it; he practised extreme respectability of deportment before the world, while he worshipped the most abandoned of Charles's mistresses, and now and again gave loose rein to his own very indifferent morals; and he combined with courage amid difficulties and devotion to duty in the face of almost certain death a personal poltroonery to which few men would care to confess. The best tribute to him as a man is that in his later years Evelyn became his firm and intimate friend, and that he died amid universal respect.

*Authorities*.—*Diary* (Bright's edition; compared with which other editions are of slight value); Rev. J. Smith, *Life, Journals, and Correspondence of Pepys* (1841); *Parliamentary History*, vol. iv.; *Journals of the House of Commons*; Evelyn, *Diary*; Wheatley, *Samuel Pepys and the World he Lived in* (1880); and articles in various magazines and reviews. (O. A.)

PERA. See CONSTANTINOPLE, vol. vi. p. 306.

PERÆA. See GILEAD, vol. x. p. 595.

PERAK. See MALAY PENINSULA, vol. xv. p. 320 *sq.*, and STRAITS SETTLEMENTS.

<sup>1</sup> He carried on an active correspondence with literary friends, among them being Dryden, Sloane, and Evelyn.

PERCEVAL, AMAND-PIERRE CAUSSIN DE (1795-1871), Orientalist, was born at Paris, where his father was professor of Arabic in the Collège de France, on 13th January 1795. In 1814 he went to Constantinople as a student interpreter, and afterwards travelled in Asiatic Turkey, spending a year with the Maronites in the Lebanon, and finally becoming dragoman at Aleppo. Returning to Paris, he became professor of vulgar Arabic in the school of living Oriental languages in 1821, and also professor of Arabic in the Collège de France in 1833. In 1849 he was elected to the Academy of Inscriptions. He died at Paris during the siege, 15th January 1871, regretted not only for his ripe scholarship but for the gentleness and modesty of a character which represented the best features of the old school of French savants.

Caussin de Perceval published a useful *Grammaire Arabe vulgaire*, which passed through several editions (4th ed. 1858), and edited and enlarged Boithor's *Dictionnaire Français-Arabe* (3d ed. 1864); but his great reputation rests almost entirely on one book, the *Essai sur l'histoire des Arabes* (3 vols., Paris, 1847-48), in which the native traditions as to the early history of the Arabs, down to the death of Mohammed and the complete subjection of all the tribes to Islam, are brought together with wonderful industry and set forth with much learning and lucidity. One of the principal MS. sources used is the great *Kutab al-Aghany*, which has since been published in Egypt; but no publication of texts can deprive the *Essai*, which is now unhappily very scarce, of its value as a trustworthy guide through a tangled mass of tradition.

PERCEVAL, SPENCER (1762-1812), prime minister of England from 1809 to 1812, was the second son of John, second earl of Egmont, and was born in Audley Square, London, in November 1762. He was educated at Harrow and at Trinity College, Cambridge, where he graduated M.A. in 1781. He was called to the bar at Lincoln's Inn in 1786. A very able speech in connexion with a famous forgery case having drawn attention to his talents, his success was from that time rapid, and he was soon regarded as the leading counsel on the Midland circuit. Entering parliament for Northampton in April 1796, he distinguished himself by his speeches in support of the administration of Pitt. In 1801, on the formation of the Addington administration, he was appointed solicitor-general, and in 1802 he became attorney-general. An ardent opponent of Catholic emancipation, he delivered in 1807 a speech on the subject which helped to give the deathblow to the Grenville administration, upon which he became chancellor of the exchequer under the duke of Portland, whom in 1809 he succeeded in the premiership. Notwithstanding that he had the assistance in the cabinet of no statesman of the first rank, he succeeded in retaining office till he was shot by an assassin, perhaps a madman, named Bellingham, in the lobby of the House of Commons, 11th May 1812. Perceval will be chiefly remembered for his strenuous opposition to Catholic emancipation, an opposition due to a conscientious dread of the political evils that might result from it. He was a vigorous debater, specially excelling in replies, in which his thorough mastery of all the details of his subject gave him a great advantage.

PERCH (*Perca fluviatilis*), a freshwater fish generally distributed over Europe, northern Asia, and North America, and so well known as to have been selected for the type of an entire family of spiny-rayed fishes, the *Percidae*, which is represented in European freshwaters by several other fishes such as the pike (*Esox lucius*) and the pike-perch (*Lucioperca*). It inhabits rivers as well as lakes, but thrives best in waters with a depth of not less than 3 feet; in large deep lakes it frequently descends to depths of 50 fathoms and more. It occurs in Scandinavia as far north as the 69th parallel, but does not extend to Iceland or any of the islands north of Europe. In the Alps it ascends to an altitude of 4000 feet.

The shape of its body is well proportioned, but many

variations occur, some specimens being singularly high-backed, others low and long-bodied; sometimes such variations are local, and Agassiz and other naturalists at one time thought it possible to distinguish two species of the common perch of Europe; there are not even sufficient grounds, however, for separating specifically the North-American form, which in the majority of ichthyological works is described as *Perca flavescens*. The brilliant and



The Perch, *Perca fluviatilis*.

striking colours of the perch render it easily recognizable even at a distance. A rich greenish-brown with golden reflexions covers the back and sides, which are ornamented with five or seven dark cross-bands. A large black spot occupies the membrane between the last spines of the dorsal fin; and the ventral, anal, and lower part of the caudal are bright vermilion. In the large peaty lakes of north Germany a beautiful variety is not uncommon, in which the golden tinge prevails, as in a gold-fish.

The perch is strictly carnivorous and most voracious; it wanders about in small shoals within a certain district, playing sad havoc among small fishes, and is therefore not to be tolerated in waters where valuable fry is cultivated. Perch of three pounds in weight are not unfrequently caught in suitable localities; one of five would now be regarded as an extraordinarily large specimen, although in older works we read of individuals exceeding even that weight.

Perch are good wholesome food, and highly esteemed in inland countries where marine fish can be obtained only with difficulty. The nearly allied pike-perch is one of the best European food-fishes. The perch is exceedingly prolific; it begins to spawn when three years old, in April or in the first half of May, depositing the ova, which are united by a viscid matter in lengthened or net-shaped bands, on water plants.

PERCIVAL, JAMES GATES (1795-1856), an American writer of many-sided activity, but chiefly remembered by his verses, was born at Berlin, Connecticut, on 15th September 1795, and studied at Yale, graduating in 1815, and taking a medical degree in 1820. His life was straitened by poverty and divided among a variety of occupations. He was by turns an army surgeon, professor of chemistry at West Point, a recruiting surgeon at Boston, geological surveyor of Connecticut (writing a *Report* published in 1842), and State geologist of Wisconsin, where he died at Hazel Green, 2d May 1856. The intervals of these employments were filled up with literary work of a miscellaneous kind. An edition of his collected poems appeared at Boston in 1859 (2 vols. 8vo). Some of his miscellaneous and patriotic verses hold a high place in American poetry.

PERCY. This family, whose deeds are so prominent in English history, claimed descent from one Manfred de Percy, who was said to have come out of Denmark into Normandy before the adventure of the famous Rollo. But it is more certain that two brothers, William and Serlo de Percy, came into England with William the Conqueror, who endowed his namesake the elder with vast possessions in Hampshire, Lincolnshire, and Yorkshire, among which were Topcliffe in the North Riding and Spofforth in the

West Riding, the principal seats of the family for many ages afterwards. This William deserves special notice besides, since he refounded the noble abbey of Whitby, which had been destroyed by the Danes,—obtaining a grant of the lordship from Hugh, earl of Chester. Yet his piety would seem to have been of a rather unsteadfast character, for, having endowed the abbey with certain lands, he resumed them in order to reward a faithful dependant, till his brother Serlo, the abbot, complained to King William, and caused him to make restitution.

The family, however, did not really descend in a direct male line from this William; for in the reign of Henry II. his male descendants became extinct, and the inheritance was divided for a time between two sisters, though by failure of issue of one of them it was reunited in the next generation. Agnes, the sister from whom all the subsequent Percies were descended, accepted as her husband Joceline, a son of Geoffrey, duke of Louvain, on the express condition that he and his posterity should bear the surname of Percy, and assume the arms of her family, relinquishing their own. This Joceline was a brother of Adalais or Alice of Louvain, the second queen of Henry I., and by an arrangement with his sister, confirmed by Henry II. when duke of Normandy, he became possessed of the honour of Petworth in Sussex. He was also castellan at Arundel, and held several other important posts in the south of England. His son Richard and Richard's son William were among the barons who rose in arms against John and Henry III. respectively; but the grandson made his peace with his sovereign, and had his lands restored to him. It should be remarked, however, as a feature of the times, that Richard de Percy was not the eldest but the youngest son of Joceline, and that, according to modern notions, he was really a usurper, who occupied the inheritance of a nephew; his right, however, passed undisputed. He was one of the twenty-five barons appointed to enforce the observance of Magna Charta.

The next important member of the family is Henry de Percy, whom Edward I., after the deposition of John Balliol, appointed governor of Galloway, and who was one of his most active agents in the subjugation of Scotland, till the success of Robert Bruce drove him out of Turnberry Castle, and made him withdraw into England. He was rewarded by Edward II. with the barren title of earl of Carrick, declared to be forfeited by the Scottish hero; and the same king appointed him governor of the castles of Bamborough and Scarborough. But he himself made his position strong in the north of England by purchasing lands from Anthony Beck, bishop of Durham, among which was the honour of Alnwick, the principal seat of the family ever since. His son, another Henry, took part in the league against Edward II.'s favourites the Despencers, was in favour with Edward III., and obtained from Edward Balliol as king of Scotland grants of Lochmaben, Annandale, and Moffatdale, which he surrendered to the English king for the castle and constablership of Jedburgh or Jedworth, with the forest of Jedworth and some neighbouring towns. A few years later, in fuller recompense of the unprofitable gift of Balliol, a grant of 500 marks a year was made to him out of the old customs at Berwick; and in 1346 he did splendid service to his sovereign by defeating and taking prisoner David, king of Scotland, at the battle of Neville's Cross.

To him succeeded another Henry Percy, a feudal baron like his predecessors, who fought at Crécy during his father's lifetime; and to him another Henry, who was made earl of Northumberland at the coronation of Richard II. It may be remarked incidentally that the succession of the name of Henry in this family is altogether extraordinary. For three generations before this first earl of

Northumberland, and for five different descents after him (making altogether a period of 238 years), the head of the house invariably was a Henry. Such a remarkable continuance of a single Christian name would have been less surprising in later and more peaceful times, when we might reasonably have expected the eldest born to succeed his father quietly through many generations. But the first four earls of this family were all slain in battle or in civil tumult, and the heir-apparent of the first, a Henry like the rest, was cut off in the same way during his father's lifetime. Was it that the incessant activity due to Border raids and moonlight expeditions created in these men a physical vigour of constitution which protected them to a large extent against disease and infirmity?

The first earl of Northumberland, certainly, had led a busy life enough, not only on the Borders but elsewhere. He had been in the French wars of Edward III.; he had been at times a warden of the marches against Scotland, or a commissioner to treat for peace with that country. He had ravaged the lands of the earl of Dunbar and had won Berwick. Powerful in the south as well as in the north, he was the Lord Henry Percy who protected Wickliffe when cited before the archbishop at St Paul's. As earl of Northumberland he exhibited his independence of Richard II. in a way characteristic of a northern baron. Sent for to court, he neglected to come, was disgraced and banished, and thereupon fled to Scotland. He repaired to Henry of Lancaster soon after his landing at Ravenspur, and helped treacherously to decoy Richard II. into his hands at Conway. Naturally he received great honour from Henry after he had become king. He was made constable of England for life, and received a gift of the Isle of Man and a number of important offices in Cheshire, Wales, and the borders of Scotland. He was even appointed one of the commissioners for the marriage of the king's daughter Blanche with Louis, duke of Bavaria; and for the first three years of the reign both he and his family seemed faithful to the new dynasty which they had greatly helped to establish. In 1402 he and his brave son Henry, the celebrated Hotspur, won the battle of Homildon Hill and took the earl of Douglas prisoner. But immediately afterwards Harry Hotspur, whose character is so well known through Shakespeare's play of *Henry the Fourth*, resenting the king's injustice to his brother-in-law, Sir Edmund Mortimer, who had been taken prisoner by the Welsh, and whom Henry, for reasons of policy, declined to ransom, entered into a league with Owen Glendower, in whose custody Mortimer was, for a combined war against the king.

The whole family of the Percies seem to have felt that their services to Henry of Lancaster were ill requited. The earl himself joined the conspiracy. His brother Thomas Percy, earl of Worcester (so created by Richard II.), stood also to all appearance in high favour with the king, who had entrusted him with the care of his son Henry, prince of Wales. But he suddenly left the court and joined his nephew in the north, both sending forth proclamations and raising the country. The rebellion was crushed in the battle of Shrewsbury (1403), in which Hotspur was slain, and the earl of Worcester was beheaded just after the fight, while Northumberland was marching southwards to join with them. Having taken no active part in the movement, the earl pretended that he had really been going to assist the king, and had wished to avert hostilities. He afterwards went peaceably to the king at York, and was placed in custody; but such was his power and influence that next year he was acquitted of treason in full parliament, and had all his honours and possessions restored to him. All confidence, however, between him and the king was at an end, and in 1405 he joined the insurrection of Arch-

bishop Scrope, who, after being beheaded as a rebel, was venerated as a martyr over the whole north of England. Then he fled to Scotland, afterwards to Wales, and in the end, returning to his own country, perished in a new rebellion at Bramham Moor.

The title and estates were thus forfeited. But, by an act no less gracious than politic, Henry V. restored them to this earl's grandson, then a prisoner with the Scots, whose liberation he had no difficulty in procuring from the duke of Albany during the time of James I.'s captivity. From that day the loyalty of the family to the house of Lancaster was steadfast and undeviating. The second earl died fighting for Henry VI. at the first battle of St Albans (1455); the third was slain in the bloody field of Towton (1461); the fourth was killed in quelling an insurrection in the time of Henry VII. So strong was the Lancastrian feeling of the family that even Sir Ralph Percy, a brother of the earl who fell at Towton, though he had actually submitted once to Edward IV., turned again, and when he fell at Hedgley Moor consoled himself with the thought that he had, as he phrased it, "saved the bird in his bosom."

No wonder, then, that in Edward IV.'s days the title and estates of the family were for a time taken away and given to Lord Montagu, brother of Warwick the king-maker. But the north was so accustomed to the rule of the Percies that in a few years Edward saw the necessity of restoring them, and did so even at the cost of alienating still further the powerful family of the Nevilles, who were then already on the point of rebellion.

A crisis occurred in the fortunes of the family in the reign of Henry VIII. on the death of the sixth earl, whose two brothers, much against his will, had taken part in the great insurrection called the "Pilgrimage of Grace." A thriftless man, of whom it is recorded that in his youth he was smitten with the charms of Anne Boleyn, but was forced to give her up and marry a woman he did not love, he died childless, after selling many of the family estates and granting the others to the king. The title was forfeited, and was granted by Edward VI. to the ambitious Dudley, earl of Warwick, who was attainted in the succeeding reign. It was restored in the days of Queen Elizabeth to Thomas Percy, who, being a staunch Catholic, was one of the three earls who took the lead in the celebrated "Rising in the North," and was beheaded at York. His brother Henry, who succeeded him, was no less unhappy. Involved in Throgmorton's conspiracy, he was committed to the Tower, and was supposed to have shot himself in bed with a pistol found beside him; but there were grave suspicions that it had been discharged by another hand. His son, the next earl, suffered like his two predecessors for his attachment to the religion of his forefathers. The crown lawyers sought in vain to implicate him in the Gunpowder Plot; but he was imprisoned for fifteen years in the Tower and compelled to pay a fine of £30,000. The son who next succeeded was a Parliamentary general in the Civil War. At length, in 1670, the male line of this illustrious family became extinct, just five hundred years after the marriage of Agnes de Percy with Joceline of Louvain.

Not one of the English noble houses is so distinguished as the Percies throughout the whole range of English history. It is remarkable alike for its long unbroken line, its high achievements, its general culture of arts and of letters. Pre-eminent also, as remarked by Sir Harris Nicolas, for its alliances among the peerage, it continues to this day, though represented once more by a female branch. The present dukedom of Northumberland was created in 1766 in the family of Smithson, who assumed the name of Percy and have borne it ever since. Sir Hugh Smithson, who became the first duke, married a granddaughter of a daughter of the last earl. (J. G.A.)

**PERCY, THOMAS** (1729-1811), bishop of Dromore, the editor of the *Percy Reliques*, was born at Bridgnorth 13th April 1729 and baptised at St Leonard's Church 29th April. His father, Arthur Lowe Percy, a grocer by trade, lived in a large house at the bottom of the street called "The Cartway," and acquired sufficient means to send his son, who had received the rudiments of his education at Bridgnorth grammar-school, to Christ Church, Oxford, in 1746. He graduated in 1750 and proceeded M.A. in 1753. In the latter year he was appointed to the vicarage of Easton Maudit, Northamptonshire, and three years later instituted to the rectory of Wilby in the same county, benefices which he retained until 1782. On the 24th of April 1759 Percy was married at Desborough, Northamptonshire, to Anne, daughter of Barton Gutteridge. During his residence in the delightful but secluded neighbourhood of Easton Maudit most of the literary work for which he is now remembered—including the *Reliques*—was completed. When his name became famous through his publications he complied with the request of the duke and duchess of Northumberland that he would reside with them as their domestic chaplain, and was tempted into the belief that he belonged to the illustrious house of Percy. Through this connexion he became dean of Carlisle in 1778 and bishop of Dromore in Ireland in 1782, from which date he was a constant resident in his adopted country. His wife predeceased him at Dromore Palace, 30th December 1806; the good bishop, blind but otherwise in sound health, lived until 30th September 1811; both of them were buried in the transept which he added to Dromore Cathedral.

For many years Dr Percy enthusiastically laboured in the fields of literature. He translated the Song of Solomon and published a key to the New Testament, a work often reprinted; he edited poetry from the Icelandic language and translated Mallet's *Northern Antiquities*. His reprint of *The Household Book of the Earl of Northumberland in 1512* is of the greatest value for the illustrations of domestic life in England at that period. But all of these works are of little estimation when compared with the *Reliques of Ancient English Poetry*, a publication which has entranced successive generations of schoolboys and students since its first appearance in February 1765. It was based on an old manuscript collection of poetry, but, unfortunately for the editor's peace of mind, it was modernized in style, a circumstance which exposed him to the sneers and suspicions of Ritson. The work as originally issued by Percy has been re-edited by many British antiquaries, whilst selections have been issued for boys and girls, and the manuscript on which he worked has been edited in its complete form by J. W. Hales and F. J. Furnivall. The bishop was possessed of great poetic feeling. His ballad of "The Hermit of Warkworth" was too simple for the austere taste of Dr Johnson, but it has always and deservedly been popular; and his song now generally known as "O Nanny, wilt thou gang wi' me!" is a universal favourite, from its own merits as well as from the musical setting of an Irishman called Thomas Carter. The greater part of the seventh volume of Nichols's *Illustrations of the Literary History of the 18th Century* is filled with Bishop Percy's correspondence.

**PERDICCAS**, son of Orontes, a distinguished Macedonian general under Philip and Alexander the Great, and regent of the empire from the death of the latter till he perished in a mutiny in 321 B.C. See *MACEDONIAN EMPIRE*, vol. xv. p. 142, and *PERSIA*, *infra*, p. 585.

The same name was borne by three kings of Macedonia: **PERDICCAS I.**, whom Herodotus calls the founder of the monarchy of Macedon; **PERDICCAS II.**, the enemy of Athens in the Peloponnesian War (died c. 414 B.C.); and **PERDICCAS III.** (died 359 B.C.).

**PEREKOP**, a town of European Russia, in the Crimea, 60 miles south-east of Kherson on the isthmus which connects the peninsula with the continent, and, as its name (*perekop*, a cutting) indicates, commanding the once defensive ditch and dyke which cross from the Black Sea to the Sivasah lagoon. It was formerly an important place, with a great transit trade in salt (obtained from the great salt lakes of the immediate neighbourhood), which occupied

so large a place in popular estimation that the Tatars of the Crimea were usually styled the "Perekop horde" and their khans the "Perekop khans." Since the opening of the railway route to the Crimea it has greatly declined. In 1865 the population of Perekop and its mercantile suburb (Armyanskii Bazar, 3 miles to the south) was only 4927, and the number has slightly decreased since.

In ancient times the isthmus was crossed (about 1½ miles south of the present town) by a ditch which gave the name of Taphros to a Greek settlement. This line of defence having fallen into decay, a fort was erected and a new ditch and dyke constructed in the 15th century by Mengli Girai and his son and successor Sahib Girai. The fort, known as Kapu or Or-Kapu, became the nucleus of the town. In 1786 Perekop was captured by Field-Marshal Münnich, and in 1788 by Field-Marshal Lasey, who blew up the fort and destroyed a great part of the dyke. In 1754 the fort was rebuilt by Krim Girai; but the Greek and Armenian inhabitants of Perekop preferred to form a new settlement at Armyanskii Bazar (Armenian Market). Captured by the Russians in 1771, the town passed into Russian possession with the rest of the Crimea in 1783.

**PEREYASLAF**, a town of European Russia, in the Poltava government, 175 miles west-north-west of Poltava, at the junction of the Trubezh and the Alta, which reach the Dnieper 5 miles lower down at the town's port, the village of Andrushki. Besides the town proper there are three considerable suburbs. Though founded in 993 (by Vladimir Svyatoslavitch in memory of his signal success over the Petchenegs), Pereyaslaff has now few remains of antiquity; while the original erection of some of the churches goes back for many hundred years (that of the Assumption, e.g., to 1010), the actual buildings are not older than the 17th century. The town has trade in grain, salt, cattle, and horses, and some manufactures—tallow, wax, tobacco, &c. The population was 10,835 in 1865 and 9300 in 1870.

From 1054 Pereyaslaff was the chief town of a principality which passed from one prince to another of the Mstislavitches, Vladimirovitches, and Olgovitches. As a southern outpost it often figures in the 11th, 12th, and 13th centuries; in later times it was one of the great centres of the Cossack movement; and in 1628 the neighbourhood of the town was the scene of the extermination of the Polish forces known as "Taras's Night." It was by the treaty of Pereyaslaff that in 1654 Bogdan Khmyelnitskii and the Cossacks acknowledged the supremacy of Alexis. At that time the town contained from 25,000 to 30,000 inhabitants.

**PEREYASLAVL**, or **PERESLAVL** (called Zalyesskii, or "Beyond the Forest," to distinguish it from the older town in Poltava after which it was named), is one of the earliest and most interesting cities in north-west Russia, situated in Vladimir government, 87 miles east of Moscow on the road to Yaroslavl, and on both banks of the Trubezh near its entrance into Lake Plestchevo. Pereyaslavl was formerly remarkable for the number and importance of its ecclesiastical foundations (there were in 1764 no fewer than eleven monasteries in the town and neighbourhood, and the churches about the same period numbered thirty-seven). Among those still standing are the 12th-century cathedral of the Transfiguration (with ancient wall-paintings and the graves of Demetrius, son of Alexander Nevskii, and other princes), and the church of the Birth of John the Baptist, founded by Euphrosyne, wife of Demetrius Donskii, in the close of the 14th century. It is by its extensive cotton manufactures (the spinning factory alone employing 1700 hands and producing to the annual value of £195,000) that Pereyaslavl is now best known throughout Russia; and it also manufactures linen, leather, and tobacco. The fisheries on the lake (20 square miles in extent and 175 feet deep) have long been of great value. The population was 6253 in 1864, 7210 in 1870, and 8700 in 1880.

Founded in 1152 by Yurgh (George) Vladimirovitch Dolgoruki, prince of Suzdal, Pereyaslavl soon began to play a considerable part in the history of the country. From 1195 till 1802 it had princes of its own; and the princes of Moscow, to whom it was then bequeathed, kept it (apart from some temporary alienations



in the 14th century) as part of their patrimony throughout the 15th and 16th centuries. The town enjoyed a great many privileges, and in return was bound to furnish the court with fish. Its earthen walls, from 20 to 50 feet in height and 7260 feet in circuit, remained till 1759. Lake Flehtchevo was the scene of Peter the Great's first attempts at creating a fleet.

PEREZ, ANTONIO (c. 1540-1611), for some years the favourite minister of Philip II of Spain and afterwards for many more the object of his unrelenting hostility, was by birth an Aragonese. His reputed father, Gonzalo Perez, an ecclesiastic, has some place in history as having been secretary both to Charles V. and to Philip II., and in literature as author of a Spanish translation of the *Odyssey* (*La Ulyxea de Homero*, Antwerp, 1556). Antonio Perez, who was legitimated by an imperial diploma issued at Valladolid in 1542, was, however, believed by many to be in reality the son of the well-known Ruy Gomez, prince of Eboli, to whom, on the completion of a liberal education at home and abroad, he appears at least to have owed his first introduction to a diplomatic career. In 1567 he became one of the secretaries of state, receiving also about the same time the lucrative appointment of protonotary of Sicily, and in 1573 the death of Ruy Gomez himself made room for Perez's promotion to be head of the "despacho universal," or private bureau, from which Philip attempted to govern by assiduous correspondence the affairs of his vast dominions. Another of the king's secretaries at this time, though in a less confidential relation, was a friend and contemporary of Perez, named Juan de Escovedo, who, however, after the fall of Tunis in 1574, was sent off to supersede Juan de Soto as secretary and adviser of Don John of Austria, thus leaving Perez without a rival. Some time after Don John's appointment to the governorship of the Netherlands Perez accidentally became cognizant of his inconveniently ambitious "empresa de Inglaterra," in which he was to rescue Mary queen of Scots, marry her, and so ascend the throne of England. This secret scheme the faithful secretary at once carried to Philip, who characteristically resolved to meet it by quietly removing his brother's aider and abettor. With the king's full cognizance, accordingly, Perez, after several unsuccessful attempts to poison Escovedo, succeeded in procuring his assassination in a street of Madrid on 31st March 1578. The immediate effect was to raise Perez higher than ever in the royal confidence and favour, but, wary though the secretary had been, he had not succeeded in obliterating all trace of his connexion with the crime, and very soon a prosecution was set on foot by the representatives of the murdered man. For a time Philip was both willing and able to protect his accomplice, but ultimately he appears to have listened to those who, whether truly or falsely, were continually suggesting that Perez had had motives of his own, arising out of his relations with the princess of Eboli, for compassing the assassination of Don John's secretary; be this as it may, from trying to screen Perez the king came to be the secret instigator of those who sought his ruin. The process, as such matters often are in Spain, was a slow one, and it was not until 1589 that Perez, after more than one arrest and imprisonment on a variety of charges, seemed on the eve of being convicted and condemned as the murderer of Escovedo. At this juncture he succeeded in making his escape from prison in Castile into Aragon, where, under the ancient "fueros" of the kingdom he could claim a public trial in open court, and so bring into requisition the documentary evidence he possessed of the king's complicity in the deed. This did not suit Philip, who, although he instituted a process in the supreme tribunal of Aragon, speedily abandoned it and caused Perez to be attacked from another side, the charge of heresy being now preferred, arising out of certain reckless and even blasphemous expressions Perez had used in connexion with

his troubles in Castile. But all attempts to remove the accused from the civil prison in Saragossa to that of the Inquisition raised popular tumults, which in the end led to Perez's escape across the Pyrenees, but unfortunately also furnished Philip with a pretext for sending an army into Aragon and suppressing the ancient "fueros" altogether (1591). From the court of Catherine de Bourbon, at Pau, where he was well received, Perez passed to that of Henry IV. of France, and both there and in England his talents and diplomatic experience, as well as his well-grounded enmity to Philip, secured him much popularity. While in England he became the "intimate coach-companion and bed-companion" of Francis Bacon, and was also much in the society of the earl of Essex. The peace of Vervins in 1598 greatly reduced his apparent importance abroad, and Perez now tried to obtain the pardon of Philip III., that he might return to his native country. His efforts, however, proved vain, and he died in comparative obscurity in Paris on 3d November 1611. Some years afterwards his wife and family were relieved from the ban of the Inquisition, under which, along with himself, they had been laid.

Perez's earliest publication was a small quarto, dedicated to the earl of Essex, written and apparently printed in England about 1594, entitled *Pedaxos de Historia*, and professedly published at Leon. A Dutch translation appeared in 1594, and in 1598 he published his *Relaciones*, including the *Memorial del Hecho de su Causa*, drawn up in 1590, and many of his letters. The Paris edition is dedicated to Henry IV., but apparently another issue was inscribed to the pope. Both dedications are given in the fullest reprint, that of Geneva (1654), which includes a collection of "aphorisms" culled from the author's writings. The literary performances of Perez owe their importance almost exclusively to the fascination of his personal narrative, which, however, gives no great impression of simplicity and straightforwardness; the letters, though admittedly models of idiomatically Castilian, are somewhat tedious reading. Much has recently been done, by Mignet (*Antonio Perez et Philippe II.*, 1845, 4th ed., 1874) and by Froude ("An Unsolved Historical Riddle," *Nineteenth Cent.*, 1883) among others, towards the elucidation of various difficult points in Perez's somewhat perplexing story.

PERFUMERY is the art of manipulating odouriferous substances for the gratification of the sense of smell. Perfumes may be divided into two classes, the first, of which includes all primitive or simple odouriferous bodies derived from the animal or vegetable kingdom, as well as the definite chemical compounds specially manufactured, while the second comprises the various "bouquets" or "mélanges" made by blending two or more of the foregoing in varying proportions,—toilet powders, dentifrices, sachets, and the like. To the former class belong (1) the animal products, ambergris, castor, civet, musk; (2) essential oils (more properly called attars), mostly procured by distillation; (3) the phyllocome butters or oils, which are either solid or liquid fats charged with odours by the processes of inflorescence or maceration; (4) the odouriferous gum-resins or balsams which exude naturally or from wounds in the trunks of various trees and shrubs, such as benzoin, opopanax, peru, tolu, storax, myrrh; (5) a few chemical bodies, similar in odour to or identical in odouriferous active principle with certain plants, e.g., nitrobenzol, called attar of mirbane or false almond, vanillin or methyl-protocatechuic aldehyde, coumarin or coumaric anhydride, and a few others. Ammonia and acetic acid are used respectively as smelling salts and in the preparation of aromatic vinegar, but can scarcely be considered as perfumes. The second class contains the endless combination of tinctures for scenting the handkerchief sold under fancy names which may or may not afford a clue to their composition, such as "comédie française," "eau de senteur," "eau de Cologne," "lavendre ambrée," "blumengeist." These are sometimes made upon a quasi-scientific basis, namely, that of the odophone or gamut of odours of the late Dr Septimus Piesse. Their numbers may be almost

minutes; one large firm in London is known to manufacture several hundreds.

**Source and Commercial Value.**—For the sources of the various animal perfumes the reader is referred to the articles *AMBERGROS*<sup>1</sup> (vol. i. p. 660), *BEAVER*<sup>2</sup> (vol. iii. p. 476), *CIVER*<sup>3</sup> (vol. v. p. 796), and *MUSK*<sup>4</sup> (vol. xvii. p. 106). The sources of the attars are the different parts of the plants which yield them,—the wood (lign aloe, santal, cedar), the bark (cinnamon, cascarilla), the leaves (patchouli, bay, thyme), the flowers (rose, lavender, orange-blossom), the fruit (nutmeg, citron), or the seeds (cataway, almond). Some plants yield more than one, such as lemon and bergamot. They are mostly obtained by distilling with water that part of the plant in which they are contained; but some few, as those from the rind of bergamot (from *Citrus bergamia*), lemon (citron zeste, from *C. Limonum*), lime (*C. Limetta*), by "expression." The outer layer of the cortex is rasped off from the unripe fruits, the raspings placed in a canvas bag, and squeezed in a screw or hydraulic press. The attars so obtained are separated from the admixed water by a tap-funnel, and are then filtered (see *OILS ESSENTIAL*, vol. xvii. p. 748). Certain flowers, such as jessamine, tuberose, violet, camia, either do not yield their attars by distillation at all, or do it so sparingly as not to admit of its collection for commercial purposes; and sometimes the attar, as in the case of orange (neroli), has an odour quite different from that of the fresh blossoms. In these cases the odours are secured by the processes of inflowering (*enfleurage*), or by maceration. Both depend upon the remarkable property which fats and oils possess of absorbing odours. The former process has already been described in the article *JASMINE* (vol. xiii. p. 595). Maceration consists in soaking the flowers in heated fat; in due time they are strained off and replaced by fresh ones, as in the *enfleurage* process. The whole of the necessary meltings and heatings of the perfumed greases are effected by means of water-baths, whereby the temperature is kept from rising too high. For the manufacture of perfumes for the handkerchief the greases now known as pomades, butters, or philocomes are treated with rectified spirit of wine 60° overproof, i.e., containing as much as 95 per cent. of absolute alcohol by volume, which practically completely abstracts the odour.

The gum-resins have been employed as perfumes from the earliest ages; many are referred to in the Old Testament; see *INCENSE* (vol. xii. p. 718) and *FRANKINCENSE* (vol. ix. p. 709). They are largely used in the manufacture of perfumes, both for burning as pastilles, ribbon of Bruges, incenses, &c., and in tinctures, to which they impart their characteristic odours, affording, at the same time, a certain fixity to other perfumes of a more fleeting nature when mixed with them. The chemical perfumes are relatively new. Vanillin, the odoriferous principle of vanilla (*V. planifolia*), was first artificially prepared by Tielman and Hermann in Germany; who obtained it from the sap of certain kinds of fir, and established its composition. Their research was afterwards remarkably verified by Dr. C. R. Alder Wright, who prepared it from crude opium. It is a pale straw-yellow crystalline substance, smelling exactly like vanilla, and said to be forty times stronger. Its value commercially is about 23s. per oz. Coumarin, the odoriferous principle of Tonquin beans (*Dipteris odorata*), is also artificially prepared. In appearance it resembles vanillin, and is valued at 9s. per oz. Some similar bodies with fancy names, such as "hemercalle," "bromelia," "aubépine," are in the market, but have scarcely yet found

their way into the perfume manufactory. Nitro-benzol, before mentioned, is employed only for imparting an almond-like odour to inferior soaps. The various compound ethers called artificial fruit essences, from their resemblance to the odours of certain fruits (bergamotte pear, pine-apple, plum, &c.), find no place in perfumery, though largely used in confectionery for flavouring.

As before stated, the bouquets constituting the second class of perfumes are but alcoholic solutions, i.e., tinctures of some of the foregoing blebbed together in various proportions, of which the following well-known recipes are examples:—

"Rondeletia."		"Bouquet du Roi."	
Krt. Vanilla	..... 2 pint.	Krt. Neroli	..... 2 pint.
" Musk	..... 1 "	" Rose	..... 2 "
" Civet	..... 1 "	" Musk	..... 1 "
Attar Rose	..... 1 oz.	" Vanilla	..... 1 "
" Mitcham Lavender	1 "	Attar Rose	..... 1 dram.

**The Odophone.**—The late Dr. Septimus Piesse endeavoured to show that a certain scale or gamut existed amongst odours as amongst sounds, taking the sharp smells to correspond with high notes and the heavy smells with low. He illustrated the idea by classifying some fifty odours in this manner, making each to correspond with a certain note, one-half in each clef, and extending above and below the lines. For example, treble clef note E (4th space) corresponds with Portugal (orange), note D (1st space below clef) with violet, note F (4th space above clef) with ambergris. It is readily noticed in practice that ambergris is much sharper in smell (higher) than violet, while Portugal is intermediate. He asserted that properly to constitute a bouquet the odours to be taken should correspond in the gamut like the notes of a musical chord,—one false note among the odours as among the music destroying the harmony. Thus on his odophone, santal, geranium, scasia, orange-flower, camphor, corresponding with G (2nd line below), C (2nd space), E (treble 1st line), G (treble 2d line), C (treble 3d space), constitute the bouquet of chord G.

**Other Branches of Perfumery.**—For the preparation of soaps two methods are in use; both start with a basis either of fine yellow soap (which owes its odour and colour to the presence of resin), or of curd soap (which is hard, white, and odourless, and is prepared without resin). In one process the soap is melted by superheated steam, and while still hot and semi-fluid mixed by means of a T-shaped stirrer of wood with iron cross-bar, technically called a "crutch," with the attars and colouring matter. It is then removed from the melting pan to a rectangular iron mould or box, the sides of which can be removed by unscrewing the tie-rods which hold them in position; when cold the mass is cut into slabs and bars with a thin brass wire. In the other or cold process the soap is first cut into chips or shavings by a plane or "chipping machine," then the colouring matters are added and thoroughly incorporated by passing the soap between granite rollers driven by steam-power; the tinted soap emerges in a continuous sheet but little thicker than paper. The attars are then added, and after standing for about twelve hours the soap is again sent through the rolling machine. It is next transferred to a bar-forming machine, which consists of an Archimedean screw with tapering thread revolving in a box; the soap in sheets is roughly squeezed through a hopper over the widest threads of the screw and is forced, as this revolves, towards the distant end of the box, to an opening of the required size, through which it emerges in a continuous bar almost as hard as wood. Soap thus worked contains less than 10 per cent. of water; that prepared by melting contains 20 and even 30 per cent. The amount of attars added depends upon the nature of the perfume, and amounts usually to about 7 or 8 per cent. The finest soaps are always manufactured by the cold process. **Toilet powders** are of various sorts. They consist of rice-starch or wheat-starch, with powdered orris-root in varying proportions, and with or without the addition of oxide of zinc, oxide of bismuth, or French chalk. The constituent powders, after the addition of the attars, are thoroughly incorporated and mixed by sifting through a fine sieve. Violet powder for the nursery should consist entirely of powdered violet root (*Spis forrestiana*), from the odour of which the powder is named. It is of a yellowish tint, soft, and pleasant to the touch. The white common so-called "violet powders" consist of starch only scented with attar of bergamot, and are in every sense inferior. **Toilet powders** consist for the most part of mixtures of powdered orris-root with precipitated chalk, and some other constituent destined to particularize it as to properties or flavour, such as charcoal, finely-pulverized pumice, quassia, sugar, camphor, &c. The perfume of the contained orris-root is modified, if required, by the addition of a little of some attar. **Toilet pastes** are not much in vogue; they are formed of the same constituents as the powders, and are worked into a paste by the addition of a little honey or glucose

<sup>1</sup> The present (1884) value of ambergris is about 90s. per oz.

<sup>2</sup> The present value of castoreum is about 32s. per lb.

<sup>3</sup> Its price is about 9s. per oz.

<sup>4</sup> Average value about 2½ per oz.

symp, which substances are usually believed ultimately to have an injurious effect on the teeth. *Perfume sachets* consist either of a powder composed of a mixture of vanilla, musk, Tonquin beans, &c., one or other predominating as required, contained in an ornamental silk sac; or of some of the foregoing substances spread upon card or chamois leather or flannel after being made into a paste with mucilage and a little glycerin. When dry the card so prepared is daintily covered with various party-coloured silks for sale. Where the ingredients employed in their manufacture are of good quality these cards, known as "peau d'Espagne" sachets, retain their odour unimpaired for years.

*Adulterations.*—There is, as might be expected, considerable scope for the adulteration of the "matières premières" employed in perfumery, and it is to be stated with regret that many unscrupulous dealers avail themselves of the facilities offered for this dishonourable practice. Thus, in the case of musk, the "pods" are frequently found to be partially emptied of the grain, which has been replaced by hide or skin, while the weight has been increased by the introduction of lead, &c. In other instances the fraud consists in the admixture of refuse grain, from which the odour has been exhausted with spirit, with dried blood, and similar substances, whilst pungency is secured by the addition of carbonate of ammonia. Attar of rose is diluted down with attar of *Palma roea*, a variety of geranium of only a quarter or a fifth of the value. The main adulterant of all the attars, however, is castor oil. This is a bland neutral body, practically odourless, and completely soluble in alcohol; it therefore presents all the requisites for the purpose. Its detection is difficult even by chemical analysis, which is obviously inapplicable in most instances; the safeguard of the purchaser is the knowledge resulting from experience.

*Statistics.*—In Europe, flower-farming for perfumery purposes is almost exclusively confined to that triangular portion of the valley of the Var (France) which has Grasse for its apex and the Mediterranean shore between Nice and Cannes for its base, with an area of about 115,000 English acres. It is here that the jasmine, tuberose, cassia, rose, and violet grew to such perfection, and that the processes of enfleurage and maceration are commercially worked. Subjoined is an estimate<sup>1</sup> of the weight of flowers annually employed.

	Tons.	Harvest Time.
Orange blossoms .....	1800	30th April to 31st May.
Roses .....	980	May.
Violets .....	147	15th January to 15th April.
Jasmine .....	147	30th July to 10th October.
Tuberose .....	74	August, September, and October.
Cassia .....	40	October, November, and December.
Jonquil .....	18	February and March.

Great praise is due to the pioneers of flower-farming in the British colonies of South Africa and Australia, and especially to Colonel Talbot in Jamaica, whose efforts in this direction bid fair to meet with complete commercial success.

The attars from peppermint (*Mentha Piperita*), thyme (*T. vulgaris*), and lavender (*Lavandula vera*), the finest in the world, are distilled from plants grown in the neighbourhood of Mitcham in Surrey. It is estimated that between 8000 and 10,000 ounces of musk are annually imported from all sources, while the quantity of alcohol employed in the manufacture of perfumes is calculated to exceed 60,000 gallons.

See *Flower's Art of Perfumery*, 4th ed., 1880.

(C. H. F.)

**PERGAMUM**, an important city of Teuthrania, a district in Mysia; it is usually named Πέργαμον by Greek writers, but Ptolemy has the form Πέργαμος. The name, which is related to the German *berg*, is appropriate to the situation on a lofty isolated hill in the broad and fertile valley of the Caicus, about 120 stadia, less than 15 miles, from its mouth. According to the belief of its inhabitants, the town was founded by Arcadian colonists, led by Telephus, son of Heracles. Auge, the mother of Telephus, was priestess of Athena Alca at Tegea, and daughter of Aleus; fleeing from Tegea, she became the wife of Teuthras, the eponymous king of Teuthrania, and her son Telephus succeeded him. Athena Polias was the patron-goddess of Pergamum, and the legend combines the ethnological record of the connexion claimed between Arcadia and Pergamum with the usual belief that the hero of the city was son of its guardian deity, or at least of the priestess who represented her. Nothing more is recorded of the city till the time of Xenophon, when it was a small fortified town on the summit of the hill. Its importance began under

Lysimachus, who deposited his treasures, 9000 talents, in this strong fortress under the charge of a eunuch Philetærus of Tium. In 283 a.c. Philetærus rebelled, Lysimachus died without being able to put down the revolt, and Pergamum became the capital of a little principality. Partly by clever diplomacy, partly through the troubles caused by the Gaulish invasion and by the dissensions among the rival kings, Philetærus contrived to keep on good terms with his neighbours on all sides (283-263 a.c.). His nephew Eumenes (263-241) succeeded him, increased his power, and even defeated Antiochus of Syria in a pitched battle near Sardis. His successor Attalus I. (241-197) won a great battle over the Gauls, and assumed the title of king. The other Greek kings who aimed at power in Asia Minor were his natural enemies. On the other hand, the influence of the Romans was beginning to make itself felt in the East. Attalus perceived the advantage of their alliance against his Greek rivals, connected himself with them from the first, and shared in their continuous success. Under the reign of Attalus Pergamum became the capital of a considerable territory and a centre of art and regal magnificence. Sculptors were attracted by the wealth of the state and the king's desire to celebrate his victories by monuments of art, and thus arose the so-called "Pergamian school" in sculpture. The Pergamian kings appear to have been far more truly Hellenic, and to have admitted far less of the "barbarian" Oriental character to their court, than the other Hellenistic sovereigns, whose habits and surroundings were those of Eastern sultans with a thin surface-gloss of Greek manners. We hear more of the munificence of Attalus towards Athens, then the educational centre of Greece, than to his own capital. The splendour of Pergamum was at its height under Eumenes II. (197-159). He continued true to the Romans during their wars with Antiochus and Perseus, and his kingdom spread over the greater part of western Asia Minor, including Mysia, Lydia, great part of Phrygia and Caria. To celebrate the great achievement of his race, the defeat of the barbarian Gauls, he built in the agora a vast altar to Zeus Soter, adorned with sculptures and especially with a gigantic frieze, in which the symbolic theme of the defeat of the barbarian giants by the gods was treated on such a scale, and with such wealth of detail and perfection of technical skill, as made the monument one of the marvels of the ancient world. He devoted great care to the improvement and embellishment of the city. It is not certain when the old Doric temple of Athena Polias and Nicephorus on the Acropolis was replaced by a more magnificent marble temple, but Eumenes planted a grove in the Nicephorion, the sacred precinct of the goddess, and established libraries and other great works in the city. He left an infant son, Attalus (III.), and a brother, Attalus II. (Philadelphus), who ruled 159-138, and was succeeded by his nephew, Attalus III. (Philometor). The latter died in 133, and bequeathed his kingdom to the Romans, who erected it into a province under the name of Asia. Pergamum continued to rank, with Ephesus and Smyrna, as one of the three great cities of the province, and the devotion of its former kings to the Roman cause was continued by its citizens, who erected on the acropolis a magnificent temple to Augustus. It was the seat of a *consensus*, including the cities of the Caicus valley and some of those in the northern part of the Hermus valley. Under the Roman empire Pergamum was one of the chief seats of the worship of Asclepius; invalids came from distant parts of the country to ask advice from the god and his priests. The temple and the curative establishment of the god were situated outside the city. Pergamum was one of the early seats of Christianity, and one of the seven churches enumerated in the Revelation was situated

<sup>1</sup> Kindly furnished by M. Bruno Court, head of the well-known house of Notre Dame des Fleurs of Grasse.

there. Two tributaries of the Caius, named Selinus and Cotius, flowed through or near the city. The ancient name is still preserved under the form "Bergamo."

The excavations conducted by the Prussian Government at Pergamum under the direction of Humann and Bohn have disclosed many of the buildings with which the acropolis was adorned, the temples of Athena and Augustus, the Stoa, &c., have recovered great part of the frieze on the altar of Zeus, and have given materials of every kind for the elucidation of Pergamian history and Greek antiquities generally, which it will take years to classify and place before the public (see the preliminary reports published by Conze, Bohn, and Humann).

**PERGOLESI (or PERGOLESE), GIOVANNI BATTISTA (1710-1736)**, Italian musical composer, was born at Jesi, Ancona, 3d January 1710, and educated at Naples in the Conservatorio dei Poveri di Gesu Cristo, where he studied the violin under Domenico de Matteis, and counterpoint under Gaetano Greco, Durante, and Francesco Feo. While learning all he could from these great teachers he struck out from the very first a style of his own, and brought it prominently forward in his earliest known composition, an oratorio, called *La Conversione di S. Guglielmo*, performed in the church of S. Agnello in 1731, in which year he also produced his first opera, *Sallustia*, at the Teatro Fiorentino. After receiving further instruction from Vinci he produced another opera, *Recimiro*, which failed lamentably. This disappointment led him to devote his chief attention to church music; and his next great works—two masses, one for two and the other for four choirs, with double orchestra—established his reputation as a genius of the highest order, and proved that he was at least as great in his newly-adopted style as in his dramatic pieces. Nevertheless, the greatest success that he was ever destined to attain was reserved for his celebrated intermezzo<sup>1</sup>—or, as we should now call it, operetta—*La Serva Padrona*. This delightful work, fairly successful on the occasion of its first production in 1731 or 1733, became after Pergolese's death a recognized favourite at every theatre of importance in Europe. In 1746 it found its way to Paris, and had a long run at the Théâtre Italien, followed in 1752 by an equally successful one at the Académie. Two years later it was translated into French, and ran for 150 successive nights. As late as 1867 it was revived in this form at the Opéra Comique; and in 1873 it was revived in London at the Royalty Theatre. The libretto by Nelli is unusually bright and sparkling; and so fresh is the music that it still sounds as if composed but yesterday. In this characteristic, indeed, lies the secret of its extraordinary success, for the scale on which it is written is of the smallest imaginable dimensions. The dramatic persons consist of three characters only, one of them being mute, and the orchestra is limited entirely to the stringed band, unrelieved by a single wind instrument. But the fire of genius breathes in every bar, and the whole work has the character of a continuous inspiration.

In 1734 Pergolese was appointed maestro di cappella at Loreto. Soon after this his health began to fail rapidly, but he worked on incessantly to the end. His last compositions were a cantata for a single voice, *Orfeo ed Euridice*; a lovely *Salve Regina*, also for a single voice; and his famous *Stabat Mater*, for two female voices. For this last-named work—the best known of all his sacred compositions—he received in advance ten ducats (£1 15s.), and thought the price enormous. He was barely able to finish it before his death, which took place at Pozzuoli, 16th March 1736.

Pergolese's works comprise fourteen operas and intermezzi, nineteen sacred compositions, and many charming pieces of chamber music,—a long list, when one remembers that he died at the age of 26 years and 3 months. The purity of his style has not been ex-

ceeded by any composer of the Italian school; and in his orchestral effects and other points of little less importance he shows himself immensely in advance of all his predecessors.

**PERIANDER** was born about 665 B.C. and succeeded his father Cypselus as despot of Corinth in 625 B.C. His rule appears to have been at first mild and beneficent, but evil advice or domestic calamity converted him into a cruel tyrant. There runs a well-known story that he sent to ask the advice of Thrasylus, tyrant of Miletus, who, instead of replying, walked with the messenger through a cornfield and struck off as he walked the tallest and fairest of the ears. Periander took the hint, and proceeded to exterminate the most eminent of his subjects.<sup>1</sup> Whatever the cause, there seems no reason to doubt that the latter part of the despot's life was darkened by crime. Goaded by the slanders of concubines, he murdered his beloved wife Melissa, daughter of Procles, tyrant of Epidaurus, and then, in a fit of remorse, burned the slanders alive.<sup>2</sup> The murder of his wife alienated from the tyrant the affection of his favourite son Lycophron, whom, failing to move either by rigour or blandishments, he banished to Corcyra, then a dependency of Corinth. At last, enfeebled by age, Periander offered, to resign the tyranny to his son and to retire himself to Corcyra; but the prospect alarmed the Corcyreans, and they put Lycophron to death. The tyrant took his revenge by sending three hundred of the noblest Corcyrean youths to Alyattes, king of Lydia, to be made eunuchs of; they were rescued, however, by the Samians. Periander did not long survive his son; he fell into a deep dependency, and died either of grief or by violence voluntarily incurred in 585 B.C., at the age of eighty.

The accounts of Periander's character are at first sight unrepentant. One writer (Heraclides) describes him as just and moderate, an enemy of vice and luxury, which he severely repressed. But more commonly he appears as cruel and oppressive. He surrounded himself with a body-guard, and, according to Aristotle, reduced tyranny to a system by putting down eminent and aspiring citizens, impoverishing the rich, maintaining spies, and sowing distrust between classes and individuals. His costly offerings to the gods drained the resources, while his public works and constant wars taxed the energies and distracted the attention of the citizens. The privilege of settling in Corinth was placed by him under certain restrictions. On the other hand, he not only patronised literature in the person of the poet Arion but was himself the author of a collection of moral maxims in 2000 verses. His reputation for wisdom stood so high that he was commonly reckoned amongst the seven wise men, though some, as Plato, denied his claim. Amongst the wars to which he owed his military fame were successful expeditions against Epidaurus and Corcyra. He built a fleet and scoured the seas on both sides of the Isthmus, through which it is said that he meditated cutting a canal. To him were due the Greek colonies of Apollonia, Anactorium, and Leucas. On the whole, Periander would appear to have been one of those brilliant despots whose personal vices have not destroyed their literary and artistic sense, and who by their abilities have raised the states which they governed to a high pitch of outward prosperity and power. Certain it is that with the close of his dynasty, which happened a few years after his death, when his successor Pammenichus perished in a popular rising, the golden age of Corinthian history came to an end.

There was another Periander, tyrant of Ambracia, said to have been a relative of the tyrant of Corinth. He was deposed by the people, probably not long after the death of the latter.

<sup>1</sup> The chief authorities for the life of Periander are Herodotus (ii. 42-52; v. 59), Aristotle (Pol., v. 11, 12), Heraclides Ponticus (v.), Nicol. Damasc. (58, 60), Diog. Laert. (l. 7). The letters in Diogenes ascribed to Periander are no doubt spurious.

<sup>2</sup> In Aristotle's version of the story the rôles of Periander and Thrasylus are reversed.

<sup>3</sup> The relations of Periander to his dead wife form the subject of a curious tale. It is said that he got a necromancer to call up the spirit of Melissa (as Saul called up Samuel), in order to question her about a hidden treasure, just as people in Württemberg used to call up ghosts in churchyards for a similar purpose. But the ghost refused to answer. "For," said she, "I am cold; I cannot wear the garments laid in my grave, because they have not been burned." So Periander called together all the women of Corinth in their best attire as for a festival, stripped them, and burned their garments on the grave of his wife, that her ghost might not go naked. Similar to this is the story in Lucian of the ghost of a dead wife appearing to her husband and begging him to find and burn one of her golden sandals which had fallen underneath the chest and so had not been burned with the other.

<sup>1</sup> A light buffo piece, the acts of which were interpolated, for the sake of relief, between those of a serious opera.

PERICLES, a great Athenian statesman, and one of the most remarkable men of antiquity, was the son of Xanthippus, who commanded the Greeks at the battle of Mycale in 479 B.C. By his mother Agariste, niece of Cleisthenes, who reformed the democracy at Athens after the expulsion of the Pisistratids, he was connected both with the old princely line of Sicyon and with the great but unfortunate house of the Alcmeonidae.<sup>1</sup> The date of his birth is unknown, but his youth must have fallen in the stirring times of the great Persian war. From his friendship with the poet Anacreon, his father would seem to have been a man of taste, and as he stood in relations of hospitality to the Spartan kings his house was no doubt a political as well as literary centre. Pericles received the best education which the age could supply. For masters he had Pythocides and the distinguished musician Damon, who infused into his music lessons a tincture of philosophy, whereby he incurred the suspicions of the vulgar, and received the honour of ostracism.<sup>2</sup> Pericles listened also to the subtle dialectics of the Eleatic Zeno. But the man who swayed him most deeply and permanently was the philosopher Anaxagoras. The influence of the speculative genius and dignified and gentle character of the philosopher who resigned his property that he might turn his thoughts more steadily to heaven, which he called his home, and who begged as his last honour that the school-children might have a holiday on the day he died, can be traced alike in the intellectual breadth and the elevated moral tone of the pupil, in his superiority to vulgar superstitions, and in the unruffled serenity which he preserved throughout the storms of political life.<sup>3</sup> It was probably the grand manner of Pericles even more than his eloquence that won him the surname of Olympian Zeus.<sup>4</sup> In his youth he distinguished himself in the field, but eschewed politics, fearing, it is said, the suspicions which might be excited in the populace not only by his wealth, high birth, and powerful friends, but by the striking resemblance to the tyrant Pisistratus which old men traced in his personal appearance, musical voice, and flowing speech. But, when the banishment of Themistocles<sup>5</sup> and the death of Aristides had somewhat cleared the political stage, Pericles came forward as the champion of the democratic or progressive party, in opposition to Cimon, the leader of the aristocratic or conservative party. The two leaders differed hardly less than their policies. Both indeed were men of aristocratic birth and temper, honourable, brave, and generous, faithful and laborious in the service of Athens. But Cimon was a true sailor, blunt, jovial, freehanded, who sang a capital song, and was always equally ready to drink or fight, to whose artless mind (he was innocent of even a smattering of letters<sup>6</sup>) the barrack-room life of the barbarous Spartans seemed the type of human perfectibility, and whose simple programme was summed up in the

maxim "fight the Persians." Naturally the new ideas of political progress and intellectual development had no place in his honest head; naturally he was a sturdy supporter of the good old times of which, to the popular mind, he was the best embodiment. Pericles, grave, studious, reserved, was himself penetrated by those ideas of progress and culture which he undertook to convert into political and social realities; philosophy was his recreation; during the whole course of his political career he never accepted but once an invitation to dinner, and he was never to be seen walking except between his house and the popular assembly and senate-house. He husbanded his patrimony and regulated his domestic affairs with rigid economy that he might escape both the temptation and suspicion of enriching himself at the public expense.

The steps by which he rose to the commanding position which he occupied in later life cannot be traced with certainty. According to Plutarch, Pericles, whose fortune did not allow him to imitate the profuse hospitality by which Cimon endeared himself to the people, sought to outbid him by a lavish distribution of the public moneys among the poorer classes; this device was suggested to him by Damonides, says Plutarch on the authority of Aristotle. We may doubt the motive alleged by Plutarch, but we cannot doubt the fact that Pericles did extend, if not originate, the practice of distributing large sums among the citizens either as gratuities or as payment for services rendered,—a practice which afterwards attained most mischievous proportions. According to Plato (*Gorgias*, 515 E), it was a common saying that Pericles, by the system of payments which he introduced, had corrupted the Athenians, rendering them idle, cowardly, talkative, and avaricious. It was Pericles who introduced the payment of jurymen, and, as there were 6000 of them told off annually for duty, of whom a great part sat daily, the disbursement from the treasury was great, while the poor and idle were encouraged to live at the public expense. But the payment for attendance on the public assembly or parliament (of which all citizens of mature age were members), though probably suggested by the payment of the jurymen, was not introduced by Pericles, and indeed does not seem to have existed during his lifetime.<sup>7</sup> It was he who instituted the payment of the citizens for military service,<sup>8</sup>—a measure but for which the Athenians would probably not have prolonged the Peloponnesian War as they did, and in particular would not have been so ready to embark on the fatal Sicilian expedition. There was more justification, perhaps, for the practice, originated by Pericles, of supplying the poorer citizens from the public treasury with the price of admission to the theatre. For in an age when the study of the poets formed a chief element of education, and when the great dramas of *Æschylus*, *Sophocles*, and *Euripides* were being put on the stage in all their freshness, such a measure may almost be regarded as a state provision for the education of the citizens. It was part of the policy of Pericles at once to educate and delight the people by numerous and splendid festivals, processions, and shows. But the good was mixed with seeds of evil, which took root and spread, till, in the days of Demosthenes, the money which should have been spent in fighting the enemies of Athens was squandered in spectacles and pageants. The Spectacular Fund or *Theorikon* has been called the cancer of Athens. Vast sums were further spent by Pericles in adorning the city with those buildings which even in their ruins are the wonder of the world. Amongst these were the Parthenon, or Temple of the Virgin (Athens), and the Erechtheum,

<sup>1</sup> Herod., vi. 131.

<sup>2</sup> *Plut., Per.*, 4; cp. *Plato, Laches*, pp. 180, 197, 200, and *Rep.*, 400, 424.

<sup>3</sup> If the statement reported by Diogenes Laertius (ii. 3, 7), that Anaxagoras spent thirty years at Athens, is correct, he probably arrived there about 462, and Pericles must have reached maturity before he met him (see Zeller, *Die Philosophie der Griechen*, i. p. 865 sq.).

<sup>4</sup> It is said that once, when Pericles was transacting business in public, a low fellow railed at him all day long, and at nightfall dogged him to his house, reviling him in the foulest language. Pericles took no notice of him till he reached his own door, when he bade one of the servants take a torch and light the man home.

<sup>5</sup> Various dates are given in 476 (Krtiger), 471 (Clinton), and 470 (Curtius). Considerable divergence of opinion prevails as to the dates of the most events between the Second Persian War and the outbreak of the Peloponnesian War (see Pierson, in *Philologus*, 1869; Classen's *Thucydides*, book i. Anh.). Pericles, who died in 429, is said to have had a public life of forty years; hence he probably began to take part in politics about 469.

<sup>6</sup> *Plut., Cimon*, 4. It is amusing to read of this stout old salt sitting in judgment on the respective merits of *Æschylus* and *Sophocles* (ib., 8).

<sup>7</sup> See Boeckh, *Staatsverwaltung der Athener*, i. p. 320; Curtius, *Griech. Gesch.*, ii. pp. 227, 342.

<sup>8</sup> Ulpian on *Demosth.*, *repl. euvrdē.*, 50 A, sp. Boeckh, i. 377.

both on the Acropolis, the former completed in 438,<sup>1</sup> the latter left unfinished at Pericles's death; the magnificent Propylæa or vestibule to the Acropolis, built 437-432; and the Odeum or music-hall, on the south-eastern slope of the Acropolis, completed before 444. The musical contests instituted by Pericles, and for which he himself laid down the rules and acted as judge, took place in the Odeum. Many artists and architects were entrusted with the execution of these great works, but under the direction of the master-mind of Phidias, sculptor, architect, painter,—the Michelangelo of antiquity. But Pericles fortified as well as beautified Athens. It had been the policy of Themistocles to make her primarily a naval and commercial power, and to do so he strengthened the marine, and gave to the city as far as possible the advantages of an insular situation by means of fortifications, which rendered both it and its port (the Piræus) impregnable on the land side. By thus basing the Athenian state on commerce instead of, like Solon, on agriculture,<sup>2</sup> he at the same time transferred the political predominance to the democratic or progressive party, which is as naturally recruited from a commercial as a conservative or aristocratic party is from an agricultural population. This policy was fully accepted and carried out by Pericles. It was in his time and probably by his advice that the Long Walls were built, which, connecting Athens with Piræus, converted the capital and its seaport into one vast fortress.<sup>3</sup> Further, in order to train the Athenians in seamanship, he kept a fleet of sixty ships at sea eight months out of every year. The expenses entailed by these great schemes were chiefly defrayed by the annual tribute, which the confederates of Athens originally furnished for the purpose of waging war against Persia, but which Athens, as head of the league, subsequently applied to her own purposes. If, as seems probable, the transference of the treasury of the league from Delos to Athens, which sealed the conversion of the Athenian headship into an empire, took place between 460 and 454, the step was probably suggested or supported by Pericles, and at all events he managed the fund after its transference.<sup>4</sup> But, though the diversion of the fund from its original purpose probably did not begin with Pericles, yet, once established, he maintained it unwaveringly. The Athenians, he held, fulfilled the trust committed to them by defending their allies against all comers, and the tribute (increased during his administration from 460 to 600 talents annually) was their wages, which it was their right and privilege to expend in works which by employing labour and stimulating commerce were a present benefit, and by their beauty would be "a joy for ever." That Athens ruled by force, that her empire was in fact a

tyranny, he fully admitted, but he justified that tyranny by the high and glorious ends which it subserved.<sup>5</sup>

The rise of Pericles to power, though it cannot be followed step by step, has an obvious and sufficient explanation in his combined wisdom and eloquence. Plato traces his eloquence largely to the influence of Anaxagoras; intercourse with that philosopher (he says) filled the mind of Pericles with lofty speculations and a true conception of the nature of intelligence, and hence his oratory possessed the intellectual grandeur and artistic finish characteristic of the highest eloquence (*Phædrus*, 270 A). The range and compass of his rhetoric were wonderful, extending from the most winning persuasion to the most overwhelming denunciation. The comic poets of the day, in general very unfriendly to him, speak with admiration of his oratory; "greatest of Grecian tongues," says Cratinus; "persuasion sat on his lips, such was his charm," and "he alone of the orators left his sting in his hearers," says Eupolis; "he lightened, he thundered," says Aristophanes. His speeches were prepared with conscientious care; before rising to speak he used to pray that no inappropriate word might fall from his lips.<sup>6</sup> He left no written speeches,<sup>7</sup> but the few sayings of his which have come down to us reveal a passionate imagination such as breathes in the fragments of Sappho. Thus, in speaking of those who had died in war, he said that the youth had perished from the city like the spring from the year.<sup>8</sup> He called the hostile island of Ægina "the eye-sore of the Piræus," and declared that he saw war "lowering from Peloponnesus." Three of his speeches have been reported by Thucydides, who may have heard them, but, though their substance may be correctly recorded, in passing through the medium of the historian's dispassionate mind they have been shorn of the orator's imaginative glow, and in their cold iron logic are hardly to be distinguished from the other speeches in Thucydides. An exception to this is the speech which Thucydides reports as having been delivered by Pericles over the slain in the first year of the Peloponnesian War. This speech stands quite apart from the others; and as well in particular touches (*e.g.*, the saying that "the grave of great men is the world") as in its whole tenor we catch the ring of a great orator, such as Thucydides with all his genius was not. It is probably a fairly close report of the speech actually delivered by Pericles.

The first public appearance of Pericles of which we have record probably fell about 463. When Cimon, on his return from the expedition to Thasos, was tried on the utterly improbable charge of having been bribed by the Macedonian king to betray the interests of Athens, Pericles was appointed by the people to assist in conducting the prosecution; but, more perhaps from a conviction of the innocence of the accused than, as was said, in compliance with the entreaties of Cimon's sister Elpinice, he did not press the charge, and Cimon was acquitted. Not long afterwards Pericles struck a blow at the conservative

<sup>1</sup> The date of the commencement of the Parthenon is variously put at 444 (Leake), 454 (Michælis), and 460 (Wachsmuth). From an inscription it would seem that the building of the temple extended at least as far back as 447. See Curtius, *Gr. Gesch.*, ii. p. 852.

<sup>2</sup> Solon's classification of the citizens for political purposes rested exclusively on the possession of cultivated land.

<sup>3</sup> There were three of these walls, of which the northern (to Piræus) and the southern (to Phalerum) were completed after the battle of Cnophyta (Thucyd., i. 108) in 456. The foundation of these two walls seems to have been laid by Cimon (Plut., *Cim.*, 13) about 462. See Leake's *Topography of Athens*, i. p. 424. Some scholars, relying on an interpretation of Thucydides (i. 107, 108), suppose that these walls were begun in one year and finished in the next. But considering the length of the walls (8 miles) and their massiveness (as shown by their remains) this seems quite impossible. The middle wall, which ran parallel to the northern wall and at no great distance from it, was built later (it was not begun before 449, Antiochides, *De pace cum Laced.*, 7, and the progress was slow, Plut., *Per.*, 13), and there is no doubt that Pericles advised its construction (Plato, *Gorgias*, 455 E). The wall to Phalerum seems afterwards to have fallen into decay, and the middle wall then went by the name of the southern, and it and the northern were known as the Long Walls (Harpocration, *s.v. δὲ μέγας τοίχος*; Leake, i. p. 427).

<sup>4</sup> Justin, iii. 6, 4; Diod., xii. 28; Curtius, *Gr. Gesch.*, ii. 168, 837.

<sup>5</sup> Cp. Thucyd., i. 143, and ii. 63, 64; Plut., *Per.*, 12.

<sup>6</sup> Compare the story in Plutarch (*De educ. puer.*, 9), that on one occasion, though repeatedly called on by the people to speak, he declined to do so, saying that he was unprepared.

<sup>7</sup> Plut., *Per.*, 8. In the time of Cicero there were some writings bearing his name (*Brutus*, 7, 27; *De Or.*, ii. 22, 93), but they were no doubt spurious. Cp. Quirtilian, iii. 1, 12; xii. 2, 23 and 10, 49.

<sup>8</sup> Cope (on Aristotle, *Rhetoric*, i. 7, 34) denies that Pericles was the author of the saying. His only plausible ground is that a similar saying is attributed to Gelon by Herodotus (vii. 162). But from the clumsy way in which the simile is there applied it has all the appearance of being borrowed, and Herodotus, who long survived Pericles, may have borrowed it from him. It is more open to question whether the simile occurred in the funeral speech delivered at the close of the Samian War, or in that during the Peloponnesian War, but the former is more probable. In Thucydides's report of the latter speech the simile does not occur.



party by attacking the Areopagus, a council composed of life-members who had worthily discharged the duties of archon. The nature of the functions of the Areopagus at this period is but little known; it seems to have had a general supervision over the magistrates, the popular assembly, and the citizens, and to have exercised this supervision in an eminently conservative spirit. It sat also as a court for the trial of certain crimes, especially murder. Pericles seems to have deprived it of nearly all its functions, except its jurisdiction in cases of murder.<sup>1</sup> The poet Æschylus composed his *Eumenides* in vindication of the ancient privileges of the Areopagus. Though Pericles was the real author of the attack on the Areopagus, the measure was nominally carried by Ephialtes. It was, indeed, part of Pericles's policy to keep in the background, and to act as far as possible through agents, reserving himself for great occasions. Ephialtes, a friend of Pericles, and a patriot of inflexible integrity, paid dearly for the distinction; he fell by the hand of an assassin employed by the oligarchical party,—an event the more striking from the rarity of political assassinations in Greek history. The popular party seems to have immediately followed up its victory over the Areopagus by procuring the ostracism of Cimon,<sup>2</sup> which strengthened the hands of Pericles by removing his most influential opponent (461). Pericles took part in the battle of Tanagra (457) and bore himself with desperate bravery. After the battle Cimon was recalled from banishment, and it was Pericles who proposed and carried the decree for his recall. In 454 Pericles led an Athenian squadron from the port of Pegæ on the Corinthian Gulf, landed at Sicyon, and defeated the inhabitants who ventured to oppose him; then, taking with him a body of Achæans, he crossed to Acarnania, and besieged the town of CEniadae, but had to return home without capturing it. Not long afterwards<sup>3</sup> Pericles conducted a successful expedition to the Thracian Chersonese, where he not only strengthened the Greek cities by the addition of 1000 Athenian colonists, but also protected them against the incursions of the barbarians by fortifying the isthmus from sea to sea. This was only one of Pericles's many measures for extending and strengthening the naval empire of Athens. Colonies were established by him at various times in Naxos, Andros, Oreus in Eubœa (in 446), Brea in Macedonia (about 443), and Ægina (in 431). They served the double purpose of establishing the Athenian power in distant parts and of relieving the pressure of population at Athens by providing the poorer citizens with lands. Somewhat different were the famous colonies established under Pericles's influence at Thurii in Italy, on the site of the ancient Sybaris (in 443), and at Amphipolis on the Strymon (in 437), for, though planted under the conduct of Athens, they were not exclusively Athenian colonies, other Greeks being allowed, and even invited, to take part in them. This was especially true of Thurii, which was in a manner a national Greek colony, and never stood in a relation of subjection to Athens. On one occasion (some time apparently between 454 and 449),<sup>4</sup>

Pericles sailed at the head of a splendid armament to the Black Sea, where he helped and encouraged the Greek cities and overawed the barbarians. At Sinope he left a force of ships and men under the gallant Lamachus, to co-operate with the inhabitants against the tyrant Timæstæus, and on the expulsion of the tyrant and his party he carried a decree for the despatch of 600 Athenian colonists to Sinope, to occupy the lands vacated by the exiles. But, with the sober wisdom which characterized him, Pericles never allowed his plans to exceed the bounds of the possible; he was no political dreamer like Alcibiades, to be dazzled with the vision of a universal Athenian empire in Greece, Italy, and Africa, such as floated before the minds of many in that and the following generations.<sup>5</sup> The disastrous expedition which the Athenians sent to Egypt, to support the rebel Inarus against Persia (460-455), received no countenance from Pericles.

When Cimon died in 449 the aristocratic party sought to counterbalance the power of Pericles by putting forward Thucydides, son of Melesias, as the new head of the party. He seems to have been an honest patriot, but, as the event proved, he was no match for Pericles. The Sacred War in 448 showed once more that Pericles knew how to defend the interests of Athens. The Phocians, under the protection of Athens, had wrested the control of the Delphic oracle from their enemies the Delphians. The latter were friendly to Sparta, and accordingly the Spartans marched into Phocis and restored the oracle to the Delphians. When they had departed, Pericles, at the head of an Athenian force, placed the oracle once more in the hands of the Phocians. As the seat of the great oracle, Delphi was to ancient Greece much what Rome was to mediæval Europe, and the friendship of the god, or of his priests, was no small political advantage. When the Athenians despatched a small force under Tolmides to crush a rising in Bœotia, they did so in spite of the warnings of Pericles. These warnings were soon justified by the unfortunate battle of Coronea (447), which deprived Athens at a blow of the continental dominion she had acquired a few years before by the battle of CEnophyta (456). The island of Eubœa now revolted from Athens, and hardly had Pericles crossed over with an army to reduce it when word came that the Megarians had massacred the Athenian garrison, and, in league with Corinth, Sicyon, and Epidaurus, were up in arms, while a Peloponnesian army under King Plistoanax was on the point of invading Attica. Pericles recrossed in haste to Attica. The Peloponnesians returned home, having advanced no farther than Eleusis and Thria. It was said that Pericles had bribed Cleandridas; certain it is that both Cleandridas and Plistoanax were charged at Sparta with having misconducted the expedition and were found guilty. Having saved Attica, Pericles returned to Eubœa, reduced it to subjection, expelled the Histæans, and settled the Athenian colony of Oreus (446) on their lands. The thirty years' peace, concluded soon afterwards (445) with Sparta, was probably in large measure the work of Pericles. The Athenians had evacuated Bœotia immediately after the battle of Coronea, and by the terms of the peace they now renounced their other continental possessions,—Achæa, Trœzen, Nisæa, and Pegæ. The peace left Pericles at liberty to develop his schemes for promoting the internal welfare of Athens, and for making it the centre of the intellectual and artistic life of Greece. But first he had to settle accounts with his political rival Thucydides; the struggle was soon decided by the ostracism of the latter in 444. Thenceforward to the end of his life Pericles

mentioned by him immediately after the expedition against CEniadae (454) and before the Sacred War (449).

<sup>1</sup> Thucyd., vi. 15, 90; Diod., xii. 54; Plut., *Per.*, 20, and *Alcib.*, 17; Pausan., i. 11. 7.

<sup>1</sup> Cp. Philochorus, 141 b, in Müller's *Fragm. Hist. Græc.*, vol. i.; Plut., *Per.*, 9, and *Cim.*, 15; Aristotle, *Pol.*, 1274 a, 7; Thirlwall's *Hist. of Greece*, ii. pp. 458, 459.

<sup>2</sup> The ostracism of Cimon lasted between four and five years (Theopompus, 92, in *Fr. Hist. Gr.*; cp. Corn. Nep., *Cimon*, 8). Hence, if his recall took place shortly after the battle of Tanagra (Plut., *Cim.*, 17, and *Per.*, 10), say at the beginning of 456, he must have been ostracized about the middle or latter part of 461. Diodorus (xi. 77) places the attack on the Areopagus in 460; but, if that attack preceded (as Plutarch implies) the banishment of Cimon, it would be necessary, in order to harmonize Diodorus and Theopompus, to place the recall of Cimon in 455 or 454—i.e., between one and two years after the battle of Tanagra—and this seems forbidden by Plutarch's narrative.

<sup>3</sup> In 453, according to Diod., xi. 88.

<sup>4</sup> The expedition is only recorded by Plutarch (*Per.*, 20), and is

guided the destinies of Athens alone; in the words of the historian Thucydides, the government was in name a democracy, but in fact it was the rule of the first citizen. The unparalleled ascendancy which he wielded so long over the fickle people is one of the best proofs of his extraordinary genius. He owed it entirely to his personal character, and he used it for the wisest and purest purposes. He was neither a vulgar demagogue to truckle to the passions and caprices of the mob, nor a vulgar despot to cow it by a hireling soldiery; he was a citizen among citizens, who obeyed him because they trusted him, because they knew that in his hands the honour and interests of Athens were safe. The period during which he ruled Athens was the happiest and greatest in her history, as it was one of the greatest ages of the world. Other ages have had their bright particular stars; the age of Pericles is the Milky Way of great men. In his lifetime there lived and worked at Athens the poets Æschylus, Sophocles, Euripides, Cratinus, Crates, the philosophers Anaxagoras, Zeno, Protagoras, Socrates, the astronomer Meton, the painter Polygnotus, and the sculptors Myron and Phidias. Contemporary with these, though not resident at Athens, were Herodotus, the father of history; Hippocrates, the father of medicine; Pindar, "the Theban eagle"; the sculptor Polyclitus; and the philosophers Empedocles and Democritus, the latter joint author with Leucippus of the atomic theory. When Pericles died other stars were rising or soon to rise above the horizon,—the historians Thucydides and Xenophon, the poets Eupolis and Aristophanes, the orators Lysias and Isocrates, and the gifted but unscrupulous Alcibiades. Plato was born shortly before or after the death of Pericles. Of this brilliant circle Pericles was the centre. His generous and richly-endowed nature responded to all that was beautiful and noble not only in literature and art but in life, and it is with justice that the age of Pericles has received its name from the man in whom, more than in any other, all the various lines of Greek culture met and were harmonized. In this perfect harmony and completeness of nature, and in the classic calm which was the fruit of it, Pericles is the type of the ideal spirit, not of his own age only, but of antiquity.

It seems to have been shortly after the ostracism of Thucydides that Pericles conceived the plan of summoning a general congress of all the Greek states to be held at Athens. Its objects were the restoration of the temples which the Persians had destroyed, the fulfilment of the vows made during the war, and the establishment of a general peace and the security of the sea. Invitations were sent to the Greeks of Asia, the islands from Lesbos to Rhodes, the Hellespont, Thrace, Byzantium, Bœotia, Phocia, Peloponnesus, Locris, Acarnania, Ambracia, and Thessaly. The aim of Pericles seems to have been to draw the bonds of union closer between the Greeks and to form a national federation. The beneficent project was defeated by the short-sighted opposition of the Spartans. But, if in this scheme Pericles rose above the petty jealousies of Greek politics, another of his measures proves that he shared the Greek prejudices as to birth. At an early period of his career (apparently about 460) he enacted, or perhaps only revived,<sup>1</sup> a law confining the rights of Athenian citizenship to persons both of whose parents were Athenian citizens. In the year 444, on the occasion of a scrutiny of the list of citizens, nearly 5000 persons claiming to be citizens were proved to be aliens under this law, and were ruthlessly sold into slavery.

The period of the thirty years' peace was not one of uninterrupted tranquillity for Athens. In 440 a war broke out between the island of Samos (a leading member

of the Athenian confederacy) and Miletus. Athens sided with Miletus; Pericles sailed to Samos with an Athenian squadron, and established a democracy in place of the previous oligarchy. After his departure, however, some of the exiled oligarchs, in league with Pisistratus, satrap of Sardis, collected troops and, crossing over to Samos, overpowered the popular party and revolted from Athens. In this revolt they were joined by Byzantium. The situation was critical; the example set by Samos and Byzantium might be followed by the other confederates. Pericles discerned the danger and met it promptly. He led a squadron of sixty ships against Samos; and, after detaching some vessels to summon reinforcements from Chios and Lesbos, and others to look out for the Phœnician fleet which the Persians were expected to send to the help of Samos, he gave battle with forty-four ships to the Samian fleet of seventy sail and defeated it. Having received reinforcements of sixty-five ships, he landed in Samos and laid siege to the capital. But, when he sailed with sixty ships to meet the Phœnician vessels which were reported to be near, the Samians sallied out with their vessels, defeated the besiegers, and remained masters of the sea for fourteen days. On his return; however, they were again blockaded, and were compelled to surrender, nine months after the outbreak of the war (spring of 439).

Though Pericles enjoyed the confidence of the people as a whole, his policy and opinions could not fail to rouse the dislike and suspicions of many, and in the last years of his life his enemies combined to assail him. Two points in particular were singled out for attack, his administration of the public moneys and his religious opinions. With regard to the former there must always be a certain number of persons who will not believe that others can resist and despise a temptation which to themselves would be irresistible; with regard to the latter, the suspicion that Pericles held heretical views on the national religion was doubtless well grounded. At first, however, his enemies did not venture to impeach himself, but struck at him in the persons of his friends. In 432<sup>2</sup> Phidias was accused of having appropriated some of the gold destined for the adornment of the statue of Athene in the Parthenon. But by the prudent advice of Pericles the golden ornaments had been so attached that they could be taken off and weighed, and when Pericles challenged the accusers to have recourse to this test the accusation fell to the ground. More dangerous, for more true, was the charge against Phidias of having introduced portraits of himself and Pericles into the battle of the Amazons, depicted on the shield of the goddess: the sculptor appeared as a bald old man lifting a stone, while Pericles was represented as fighting an Amazon, his face partly concealed by his raised spear. To the pious Athenians this seemed a desecration of the temple, and accordingly Phidias was clapped into gaol. Whether he died there or at Elis is uncertain.<sup>3</sup> Even more deeply was Pericles wounded by the accusation levelled at the woman he loved. This was the famous Aspasia, a native of Miletus, whose talents won for her general admiration at Athens. Pericles divorced his wife, a lady of good birth who had borne him two sons, Xanthippus and Paralus, but with whom he was unhappy, and attached himself to Aspasia. With her he lived on terms of devoted affection to the end of his life, though, as she was a foreigner, their union was not a legal marriage. She enjoyed a high reputation as a teacher of rhetoric, and

<sup>1</sup> A scholiast on Aristoph., *Paz.* 606, places the condemnation of Phidias seven years before the outbreak of the Peloponnesian War, or in 438 (according to Palmer's correction); see Müller *ad l.*, in *Frug. Hist. Gr.*, v. p. 18.

<sup>2</sup> Different views of the fate of Phidias are taken by scholars. See PHIDIAS.

<sup>3</sup> See Schömann's *Antiquities of Greece*, p. 357, Eng. tr.; Hermann's *Staatsalterthümer*, § 118.

seems to have been the centre of a brilliant intellectual society, which included Socrates and his friends. The comic poet, Hermippus, brought her to trial on the double charge of impiety and of corrupting Athenian women for the gratification of Pericles. A decree was further carried by a religious fanatic named Diopithes, whereby all who denied the existence of the gods or discussed the nature of the heavenly bodies were to be tried as criminals. This blow was aimed directly at the aged philosopher Anaxagoras, but indirectly at his pupil Pericles as well as at Aspasia. When this decree was passed, and apparently while the trial of Aspasia was still pending, Pericles himself was called upon by a decree of the people to render an account of the money which had passed through his hands. The result is not mentioned, but we cannot doubt that the matter either was dropped or ended in an acquittal. The perfect integrity of Pericles is proved by the unimpeachable evidence of his contemporary, the historian Thucydides. Aspasia was acquitted, but not before Pericles had exerted all his eloquence in her behalf. Anaxagoras, tried on the charge of impiety, was obliged to quit the city.<sup>1</sup>

It was in the same year (432) that the great contest between Athens and Sparta, known as the Peloponnesian War, broke out. We may dismiss as a vulgar calumny the statement, often repeated in antiquity,<sup>2</sup> but quite unsupported by Thucydides, that the war was brought about by Pericles for the purpose of avoiding a prosecution. The war was in truth inevitable; its real cause was Sparta's jealousy of the growing power of Athens; its immediate occasion was the help lent by Athens to Corcyra in its war with Corinth. At first, with a hypocritical regard for religion, the Spartans demanded as a condition of peace that the Athenians should expel the race of the Alcmaeonidae (including, of course, Pericles), whose ancestors had been guilty of sacrilege about two centuries before. The Athenians retorted in kind, and, after a little more diplomatic fencing, the Spartans were constrained to show their hand by demanding bluntly that Athens should give back to the Greeks their independence,—in other words, renounce her empire and abandon herself to the tender mercies of Sparta. Pericles encouraged the Athenians to reject the demand. He pointed out that Athens possessed advantages over the Peloponnesians in superior wealth and greater unity of counsels. He advised the Athenians, in case of war, not to take the field against the numerically superior forces of the Peloponnesians, but to allow the enemy to ravage Attica at will, while they confined themselves to the defence of the city. Through their fleet they would maintain communication with their island empire, procure supplies, and harass the enemy by sudden descents on his coasts. By pursuing this defensive policy without attempting to extend their empire, he predicted that they would be victorious. The people hearkened to him and replied to the Spartan ultimatum by counter-demands, which they knew would not be accepted. Pericles had not neglected in time of peace to prepare for war, and Athens was now well equipped with men, money, and ships. In June of the following summer (431) a Peloponnesian army invaded Attica. By the advice of Pericles the rural population, with their movables, had taken refuge in the city, while the cattle had been sent for safety to the neighbouring islands. The sight of their country ravaged under their eyes excited in the Athenians a longing to march out and meet the enemy, but in the teeth of popular clamour and obloquy Pericles steadily adhered to

his defensive policy, content to protect the suburbs of Athens with cavalry. Meanwhile, Athenian fleets retaliated upon the enemy's coasts. About the same time, as a punishment for the share that they were supposed to have had in bringing on the war, the whole population of Ægina was expelled from their island to make room for Athenian colonists. This measure, directed by Pericles, relieved to some extent the pressure in the overcrowded capital, and secured a strong outpost on the side of the Peloponnesus. In the autumn, after the Peloponnesian army had been obliged by want of provisions to quit Attica and disband, Pericles conducted the whole available army of Athens into the territory of Megara, and laid it waste.

It was a custom with the Athenians that at the end of a campaign the bones of those who had fallen in battle should be buried with public honours in the beautiful suburb of Ceramicus, the Westminster of Athens, and the vast crowd of mourners and spectators gathered about the grave was addressed by a citizen chosen for his character and abilities to pay the last tribute of a grateful country to its departed brave. On the present occasion the choice fell on Pericles. Once before, at the close of the Samian War, it had been his lot to discharge a similar duty. The speech which he now delivered, as reported to us by Thucydides, is one of the noblest monuments of antiquity. It is indeed the creed of Athens and of Greece. In its aristocratic republicanism—recognizing at once the equal legal rights and the unequal intrinsic merits of individuals—it differs alike from the monarchical spirit of mediæval and modern Europe, with its artificial class distinctions, and from that reactionary communism which preaches the natural as well as the legal equality of men. In its frank admiration of art and letters and all the social festivals which humanize and cheer life it is as far from the sullen asceticism and the wild debauchery of the East, as the grave and manly simplicity of its style is removed from the fanciful luxuriance of Oriental rhetoric. Finally, in the words of comfort and exhortation addressed to the bereaved, the speech—to adopt Thirlwall's description of another great effort of Athenian oratory<sup>3</sup>—"breathes the spirit of that high philosophy which, whether learnt in the schools or from life, has consoled the noblest of our kind in prisons, and on scaffolds, and under every persecution of adverse fortune."

The fortitude of the Athenians was put to a still severer test in the following summer (430), when to the horrors of war (the Peloponnesians had again invaded Attica) were added the horrors of the plague, which spread havoc in the crowded city. Pericles himself escaped the scourge,<sup>4</sup> but many of his relations and best friends, amongst them his sister and his two sons Xanthippus and Paralus, were struck down. With the elder of his sons, Xanthippus, a worthless young man, the father had been on bad terms, but the death of his surviving son, at an interval of a few days, affected him deeply, and, when he came to lay the wreath upon the corpse, though he struggled hard to maintain his habitual calm, he broke down, and for the first time in his public life burst into a passion of weeping.<sup>5</sup> But neither private grief nor public calamity shook for a moment the lofty courage and resolution with which he continued to the last to oppose a firm front alike to enemies without and to cravens within. While refusing as before to risk a battle in Attica, which he allowed the Peloponnesians

<sup>1</sup> The speech of Demosthenes "On the Crown."

<sup>2</sup> Plutarch, admitting that Pericles was not attacked by the plague in its acute form, believes that it so far affected him as to throw him into a lingering decline. But we do not gather from Thucydides's description of the plague that it ever had this effect.

<sup>3</sup> Not inconsistent with this are the accounts of the general fortitude with which he bore his bereavement (Plut., *Consol. ad Apoll.*, 33; Ælian, *Var. Hist.*, ix. 6; Val. Max., v. 10).

<sup>1</sup> The accounts of the issue of the trial are somewhat discrepant; see Zeller, *Die Philosophie der Griechen*, I. p. 872.

<sup>2</sup> Aristophanes, *Pax*, 605 *sq.*, with schol. *ad l.*; Diod., xii. 38-40; Plut., *Per.*, 31, 32; Aristodemus, xvi.; Suidas, s. v. "Φειδίας."

to devastate at pleasure, he led in person a powerful fleet against Peloponnesus, ravaged the coast, and destroyed the town of Prasias in Laconia. But the Athenians were greatly disheartened; they sued for peace, and when their suit was rejected by Sparta they vented their ill-humour on Pericles, as the author of the war, by subjecting him to a fine. However, they soon repented of this burst of petulance, and atoned for it by re-electing him general<sup>1</sup> and placing the government once more in his hands. Further, they allowed him to legitimate his son by Aspasia, that his house might not be without an heir. He survived this reconciliation about a year, but his name is not again mentioned in connexion with public affairs. In the autumn of 429 he died. We may well believe that the philosophy which had been the recreation of his happier days supported and consoled him in the clouded evening of his life. To his clement nature it was a peculiar consolation to reflect that he had never carried political differences to the shedding of blood. Indeed, his extraordinary, almost fatherly, tenderness for the life of every Athenian citizen is attested by various of his sayings.<sup>2</sup> On his deathbed, when the friends about him were telling his long roll of glory, rousing himself from a lethargy into which he had fallen, he reminded them of his fairest title to honour: "No Athenian," he said, "ever put on black through me."

He was buried amongst the great dead in the Ceramicus, and in after years Phormio, Thrasybulus, and Chabrias slept beside him.<sup>3</sup> In person he was graceful and well made, save for an unusual height of head, which the comic poets were never weary of ridiculing. In the busts of him which we possess, his regular features, with the straight Greek nose and full lips, still preserve an expression of Olympian repose.

The chief, perhaps the only trustworthy, authority for the life of Pericles is the history of his contemporary Thucydides. The biography by Plutarch is compiled from Thucydides, Ephorus, Ion, Stesimbrotus, Duris of Samos, Aristotle, Idomeneus, Eschines, and Heraclides Ponticus, together with the comic poets Cratinus, Teleclides, Hermippus, Plato, Eupolis, and Aristophanes. Ephorus, a pupil of Isocrates, must have had plenty of means of ascertaining the facts, but how little his judgment is to be trusted is shown by his account of the origin of the Peloponnesian War,—an account also followed by Diodorus Siculus, whose history adds nothing of importance to the narratives of Thucydides and Plutarch. Ion and Stesimbrotus were contemporaries of Pericles, but, as both were admirers of Cimon and opposed to the policy of Pericles, their accounts have to be received with caution. (J. G. FR.)

PERIDOTE, a name applied by jewellers to the green transparent varieties of olivine. When yellow, or yellowish-green, the stone is generally known as "chrysolite." The colour of the peridot is never vivid, like that of emerald, but is usually some shade of olive, pistachio, or leek-green. Although sometimes cut in rose-forms and *en cabochon*, the stone displays its colour most advantageously when it is worked in small steps. Unfortunately the peridot is the very softest of gem-stones, its hardness being only about 6·5, or but little above that of glass; hence the stone, when polished, rapidly loses its lustre, and readily suffers abrasion by wear. There is considerable difficulty in polishing the peridot; the final touch is given on a copper wheel moistened with sulphuric acid, yet, curiously enough, the mineral is soluble in this medium. The peridot is a silicate of magnesium and iron, having a specific gravity of about 3·4, and crystallizing in the orthorhombic system (see fig. 468, MINERALOGY, vol. xvi. p. 410). Good crystals,

however, are extremely rare, the mineral being usually found as rolled fragments. The localities for peridote and chrysolite are Egypt, Ceylon, Pegu, and Brazil, while the dull varieties of olivine enjoy a world-wide distribution in various eruptive rocks and in serpentine. Olivine is found also in meteorites.

There can be little doubt that the ancient "topazion" was our peridote or chrysolite, and that the mineral now called topaz was unknown to ancient and mediæval writers. The earliest mention of the word "peridote" is said to occur in the Wardrobe Book of 27 Edward I, where, among the jewels of the bishop of Bath and Wells which had escheated to the crown, mention is made of "unus annulus auri cum *peredita*." The origin of the word has given rise to much speculation, some authorities deriving it from *peridoros*, "a wager," and others from *perideros*, "banded," while others, again, refer it to an Arabic origin.

For the history of the stone see King's *Natural History, Ancient and Modern, of Precious Stones*, 1865.

PÉRIGORD, an old province of France which formed part of the military government of Guienne and Gascony, and was bounded N. by Angoumois, E. by Limousin and Quercy, S. by Agenais and Bazadais, and W. by Bordelais and Saintonge. It is now represented by Dordogne and part of Lot-et-Garonne. The capital was PÉRIGUEUX (*q.v.*).

PÉRIGUEUX, formerly capital of Périgord, now chief town of the department of the Dordogne, France, situated on the slope of an eminence commanding the right bank of the Isle, one of the tributaries of the Dordogne. It is 310 miles by rail south-south-west of Paris and 79 miles east-north-east of Bordeaux. Périgueux is divided into three distinct parts. In the middle, on the slope of the hill, is the town of the Middle Ages, with narrow, crooked, and dirty streets, above which rises the cathedral of St Front; higher up comes the modern town, its houses separated by gardens and public walks; and at the foot of the hill and lying along the Isle are small houses of modern construction, built on the fine ruins of the Roman town. Three bridges connect Périgueux with the left bank of the Isle, where stood Vesunna, the capital of the Petrocorii. Hardly a trace of this old Gallic oppidum remains, but not far off, on the Plateau de la Boissière, the rampart of the old Roman camp, 1970 feet long and half as wide, is still to be recognized. On the right bank of the Isle, in the Roman city, there have been discovered some baths of the 1st or 2d century, which had a frontage of 200 feet, and were supplied by an aqueduct 4 miles long, which spanned the Isle. In several places numerous mosaics have been found, some of which have been placed in the museum. A circular building, called the "Tower of Vesunna," 68 feet in diameter and 89 feet in height, stands at what was formerly the centre of the city, where all the chief streets met. It is believed to have been originally the cella or main part of a temple, of which the peristyle has disappeared, probably dedicated to the tutelary deities of Vesunna. Of the amphitheatre there still remain huge fragments of wall built of pebbles and cement, staircases, vomitories, and partly uncovered vaults. The building, which held 40,000 spectators, had a diameter of 1312 feet, that of the arena being 876 feet; judging from its construction it must be as old as the 3d or even the 2d century. The counts of Périgueux used it for their château, and lived in it from the 12th to the end of the 14th century. In 1644 it was given over by the town to the Order of the Visitation, and the sisters took from it the stones required for the construction of their nunnery. At present it is private property. The most remarkable, however, of the ruins of old Vesunna is the Château Barrière. It rests on stones of great size, and dates in part from a very remote period. Two towers date from the 3d or 4th century, and formed part

<sup>1</sup> There were ten generals at Athens annually elected by the votes of the people. They seem to have had civil as well as military duties, and the importance of the office must have increased in proportion to the degradation of the offices which were filled by lot. After the ostracism of Thucydides Pericles was elected to the office again and again.

<sup>2</sup> Plut., *Per.*, 18, 33, 38; *Reg. et imp. Apoph.*; *Præcept. ger. Resp.*, xvii. 4.

<sup>3</sup> Pausan., i. 29, 3; cp. Cic., *De Fin.*, v. 2.

of the fortified enceinte; the highest tower is of the 10th century; and the part now inhabited is of the 11th or 12th century, and was formerly used as a burial chapel. The bulk of the château is of the 12th, and some of the windows of the 16th century. Lastly, there are still to be traced the two tiers of wall of the enceinte, built round the city in the 5th century; but these are partly hidden by restorations of a later date. Numerous courses of stone are also to be seen, shafts of columns, and marbles of various shapes and sizes. Of the mediæval town the feature most worthy of notice is the cathedral of St Front, which is indeed (or rather was) one of the most interesting of sacred buildings. It bears a striking resemblance to the Byzantine churches and to St Mark's at Venice, and was built from 984 to 1047, contemporaneously with the latter (977-1085). It consists of five great cupolas, arranged in the form of a Greek cross, and conspicuous from the outside. The arms of the cross are 69 feet in width, and the whole is 184 feet long. These cupolas, 89 feet high from the keystone to the ground, and supported on a vaulted roof with pointed arches after the manner characteristic of Byzantine architecture, served as models for many other churches in Aquitania; thus St Front is entitled to a prominent place in the history of art. The pointed arches imitated from it prepared the way for the introduction of the Gothic style. The restoration of the edifice, begun in 1865, resulted, unfortunately, in an almost complete reconstruction, in which the old features have been largely lost. The belfry of St Front is the only one in the Byzantine style now extant; it dates from the 11th century, and is composed of two massive cubes, placed the one above the other in retreat, with a circular colonnade surmounted by a dome. The interior of the church has a fine altar-screen of carved oak. Near St Front are the ruins of the old basilica built in the 6th century. The bishop's palace, in the grounds of the ancient abbey, has a curious subterranean cloister of the 12th, 13th, and 14th centuries. Périgueux has several old and curious houses of the mediæval and Renaissance periods; a large prefecture of some architectural merit, built at great expense a few years ago in the style of the Renaissance

and of the 18th century; a museum which is singularly rich in Roman, Frank, Egyptian, and pre-Celtic antiquities; and a library of 30,000 volumes. In the squares are statues of Montaigne, Fénelon, General Daumesnil, the defender of Vincennes (1814-15), and Marshal Bugeaud. The town has iron and copper foundries, serge and bombasin factories, tanneries, and dye-works. It does a large trade in flour, wine, brandy, hides, poultry, and in the celebrated patés du Périgord. It is the junction of the railway from Paris to Agen with that from Bordeaux to Lyons via Clermont. The population in 1881 was 25,036.

Vesunna, as has already been said, was the capital of the Petrocorii, allies of Vercingetorix when Cesar invaded Gaul. The country was afterwards occupied by the Romans, who built a second city of Vesunna on the right bank of the Isle opposite the site of the Gallic oppidum. It contained public buildings, and Roman roads led from it to Limoges, Agen, Bordeaux, and Saintes. The barbarian invasion brought this prosperity to a close. In the 6th century St Front preached Christianity here, and over his tomb there was raised in the 10th century an abbey, which became the centre of the new town, called Puy St Front. The latter soon began to rival the old city in importance, and it was not until 1269 that they were united by a solemn treaty. After the time of Charlemagne Périgord was governed by a line of counts. During the Hundred Years' War Périgueux was twice attacked by the English, who took the fortified town in 1356; and the town was ceded to them by the treaty of Bretigny, but returned to the French crown in the reign of Charles V. The county passed by marriage into the hands of Anthony of Bourbon, father of Henry IV., and was converted by the latter into royal domain. During the Huguenot wars Périgueux was frequently a Calvinist stronghold, and it also suffered during the troubles of the Fronde.

PERINTHUS, a town of Thrace, on the Propontis, 22 miles to the west of Selymbria, strongly situated on a small peninsula on the Bay of Perinthus, on the site of the modern Eski Ereğli. It is said to have been a Samian colony, and to have been founded about 599 B.C. According to Tzetzes, its original name was Mygdonia; later it was called Heraclea (Heraclea Thracia, Heraclea Perinthus). It figures in history chiefly by its stubborn and successful resistance to Philip of Macedon in 340, at which period it seems to have been even more important than Byzantium itself. A number of extant coins of Perinthus show that it was the seat of large and celebrated festivals.

## PERIODICALS

PERIODICALS may be broadly divided into two classes, the one chiefly devoted to general literature, apart from political and social news (a subject dealt with under the heading of NEWSPAPERS), and the other more exclusively to science and art, or to particular branches of knowledge or trade. The former class, and those of general interest only, will be principally dealt with in this article, where an endeavour is made to trace briefly the history of the rise and progress of that vast and increasing body of printed matter which, under the different names of reviews, magazines, &c., forms so large a part of current literature.

### BRITISH.

The first literary periodical in English was the *Mercurius Librarius*, or a Faithful Account of all Books and Pamphlets (1680), a mere catalogue, followed by *Weekly Memorials for the Ingenious* (16th January 1681/82 to 15th January 1683), which was more of the type of the *Journal des Savants*, whence it borrowed many contributions, and by the *Bibliothèque Universelle et Historique* (January 1686-93), begun by Jean Leclerc, continued with the assistance of J. de la Crosse, and carried on during the last six years of its existence by J. Bernard. Of the *History of Learning* (1691; another with the same title in 1694) only a few

numbers appeared, as the conductor, De la Crosse, started the *Works of the Learned* (August 1691 to April 1692), devoted principally to Continental scholarship. The *Complete Library* (1692 to December 1693) was a venture of John Dunton; the *Memoirs for the Ingenious* (1693) ran to six monthly numbers, and another with the same title appeared in the following year, only to enjoy an equally brief career. The first periodical of merit and influence was the *History of the Works of the Learned* (1699-1712), largely consisting of descriptions of foreign books. The *Memoirs of Literature*, the first English review consisting entirely of original matter, published in London from 1710 to 1714, had for editor Michel de la Roche, a French Protestant refugee, who also edited at Amsterdam the *Bibliothèque Angloise* (1717-19), and subsequently *Mémoires Littéraires de la Grande Bretagne* (1720-24). Returning to England in 1725, he recommended his *New Memoirs of Literature* (1725-28), and in 1730 a *Literary Journal*. Dr Samuel Jebb started *Bibliotheca Literaria* (1722-24), which dealt with medals and antiquities as well as with literature, but only ten numbers appeared. The *Present State of the Republic of Letters* was commenced by Andrew Reid in January 1728, and completed in December 1736. It contained not only excellent reviews of English books but papers from the works of foreigners, and, as well as the *Historia Literaria*

(1730-34) of Archibald Bower,<sup>1</sup> was very successful. The *Bee* (1733-34) of the unfortunate Eustace Budgell, and the *Literary Magazine* (1735-36), with which Ephraim Chambers had much to do, were very short-lived. In 1737 the *History of the Works of the Learned* appeared again, and was continued without intermission until 1743, when its place was taken by *A Literary Journal* (Dublin, 1744-49), the first review published in Ireland. The *Museum* (1746) of R. Dodsley united the character of a review of books with that of a literary magazine. Although England can show nothing like the *Journal des Savants*, which has flourished almost without a break for 220 years, a nearly complete series of reviews of English literature may be made up from 1681 to the present day.

After the close of the first quarter of the 18th century the literary journal began to assume more of the style of the modern review, and in 1749 the title and the chief features were united in the *Monthly Review*, established by Ralph Griffiths,<sup>2</sup> who conducted it until 1803, whence it was edited by his son down to 1825. It came to an end in 1845. From its commencement the *Review* dealt with science and literature, as well as with literary criticism. It was Whig in politics and Nonconformist in theology. The Tory party and the established church were defended in the *Critical Review* (1756-1817), founded by Archibald Hamilton and supported by Smollett, Johnson, and Robertson. Johnson took a considerable part in the *Literary Magazine* (1756-58). The reviews rapidly increased in number towards the end of the century. Among the principal were the *London Review* (1775-80), *A New Review* (1782-86), the *English Review* (1783-96), incorporated in 1797 with the *Analytical Review* (1788-99), the *Anti-Jacobin Review and Magazine* (1798-1821), and the *British Critic* (1793-1843), the organ of the High Church party, and first edited by Archdeacon Nares and Beloe.

These periodicals had now become extremely numerous, and many of the leading London publishers found it convenient to maintain their own particular organs. It is not a matter of surprise, therefore, that the authority of the reviews should have fallen somewhat in public estimation. The time was ripe for one which should be quite independent of the booksellers, and which should also aim at a higher standard of excellence. As far back as 1755 Adam Smith, Blair, and others had endeavoured to carry on such a quarterly without achieving success, and in 1773 Gilbert Stuart and William Smellie issued during three years an *Edinburgh Magazine and Review*. To the northern capital is also due the first high-class critical journal which has kept up its reputation to the present day. The *Edinburgh Review* was established in 1802 by Jeffrey, Scott, Horner, Brougham, and Sydney Smith. It created a new era in periodical criticism, and assumed from the commencement a wider range and more elevated tone than any of its predecessors. The first editor was Sydney Smith, then Jeffrey for many years, and afterwards Macvey Napier. At one time 20,000 copies are said to have been published, but the circulation declined in 1832 to less than 9000. Scott, being dissatisfied with the new review, persuaded John Murray to start its brilliant Tory competitor, the *Quarterly Review* (1809), first edited by William Gifford, then by Sir J. T. Coleridge, and subsequently by J. G. Lockhart. The *Westminster Review* (1824), established by the disciples of Jeremy Bentham, advocated radical reforms

in church, state, and legislation. In 1836 it was joined to the *London Review* (1829), founded by Sir William Molesworth, and then bore the name of the *London and Westminster Review* till 1851, when it returned to the original title. The other quarterly reviews are the *Eclectic Review* (1805-68), edited down to 1834 by Josiah Conder and supported by the Dissenters; the *British Review* (1811-25); the *Christian Remembrancer* (1819-68); the *Retrospective Review* (1820-26, 1828, 1853-54), for old books; the *Foreign Quarterly Review* (1827-46), afterwards incorporated with the *Westminster*; the *Foreign Review* (1828-29); the *Dublin Review* (1836), still continued as the organ of the Roman Catholics; the *Foreign and Colonial Quarterly Review* (1843-47); the *Prospective Review* (1845-55), given up to theology and literature, previously the *Christian Teacher* (1835-44); the *North British Review* (1841-71); the *British Quarterly Review* (1845), successor to the *British and Foreign Review* (1835-44); the *New Quarterly Review* (1852-61); the *Scottish Review* (1853-62), published at Glasgow; the *Wealeyan London Quarterly Review* (1853); the *National Review* (1855-64); the *Diplomatic Review* (1855-81); the *Irish Quarterly Review* (1851-59), brought out in Dublin; the *Home and Foreign Review* (1862-64); the *Fine Arts Quarterly Review* (1863-65); the *New Quarterly Magazine* (1873-80); the *Catholic Union Review* (1863-74); the *Anglican Church Quarterly Review* (1875); *Mind* (1876), dealing with mental philosophy; the *Modern Review* (1880); and the *Scottish Review* (1882).

The monthly reviews include the *Christian Observer* (1802-57), conducted by members of the established church upon evangelical principles, with Zachary Macaulay as the first editor; and the *Monthly Repository* (1806-37), originally purely theological, but after coming into the hands of the Rev. W. J. Fox made entirely literary and political. The *Fortnightly Review* (1865) was intended as a kind of English *Revue des Deux Mondes*. Since 1866 it has appeared monthly. The *Contemporary Review* (1866) and the *Nineteenth Century* (1877) are similar in character, consisting of signed articles by men of mark of all opinions upon questions of the day. The *National Review* (1883) was brought out to supply the demand for an exclusively Conservative review, and *Modern Thought* (1879) for the free discussion of political, religious, and social subjects.

The weekly reviews dealing generally with literature, science, and art are the *Literary Gazette* (1817-62), first edited by William Jerdan, which had for many years a circulation of 6000 copies; the *Athenaeum* (1828), established by Silk Buckingham, but which was not very successful until it was taken over by C. W. Dilke; and the *Academy* (1869), founded, and at first edited, by Dr Appleton. Those which also include political and social topics are the *Examiner* (1808-81), the *Spectator* (1828), the *Saturday Review* (1855), and the *Chronicle* (1867-68). The reviews in the *Academy* are signed.

Soon after the introduction of the literary journal in England, one of a more familiar tone was started by the eccentric John Dunton in the *Athenian Gazette*, or *Casualty Mercury*, resolving all the most Nice and Curious Questions (1689/90 to 1695/96), a kind of forerunner of *Notes and Queries*, being a penny weekly sheet, with a quarterly critical supplement. In the last part the publisher announces that it will be continued "as soon as ever the glut of news is a little over." Defoe's *Review* (1704-13) dealt chiefly with politics and commerce, but the introduction in it of what its editor fittingly termed the "scandalous club" was another step nearer the papers of Steele and the periodical essayists, the first attempts to create an organized popular opinion in matters of taste and manners. These little papers, rapidly thrown off for a temporary purpose, were destined to form a very important part of

<sup>1</sup> Archibald Bower (1686-1766) was educated at Douai, and became a Jesuit. He subsequently professed himself a convert to the Anglican Church, and published a number of works, but was more esteemed for his ability than for his moral character.

<sup>2</sup> The biographers of Goldsmith have made us familiar with the name of Griffiths, the prosperous publisher, with his diploma of LL.D. granted by an American university, and with the quarrels between him and the poet.



the literature of the 18th century, and in some respects its most marked feature. Although the frequenters of the clubs and coffee-houses were the persons for whom the essay-papers were mainly written, a proof of the increasing refinement of the age is to be found in the fact that now for the first time were women specially addressed as part of the reading public. The *Tatler* was commenced by Richard Steele in 1709, and issued thrice a week until 1711. The idea was at once extremely popular, and a dozen similar papers were started within the year, at least one half bearing colourable imitations of the title. Addison contributed to the *Tatler*, and together with Steele established and carried on the *Spectator* (1710-14), and subsequently the *Guardian* (1713). The newspaper tax enforced in 1712 was a sore blow. Before this time the daily issue of the *Spectator* had reached 3000 copies; it then fell to 1600; the price was raised from a penny to twopenny, but the paper came to an end in 1714. Dr Drake (*Essays illustr. of the Rambler*, &c., ii. 490) drew up an imperfect list of the essayists, and reckoned that from the *Tatler* to Johnson's *Rambler*, during a period of forty-one years, 106 papers of this description were published. Dr Drake continued the list down to 1809, and described altogether 921 which had appeared within a hundred years. The following is a list of the most considerable, with their dates, founders, and chief contributors.

*Tatler* (12th April 1709 to 2d January 1710/11), Steele, Addison, Swift, Hughes, &c.; *Spectator* (1st March 1710/11 to 20th December 1714), Addison, Steele, Budgell, Hughes, Grove, Pope, Parnell, Swift, &c.; *Guardian* (12th March 1713 to 1st October 1713), Steele, Addison, Berkeley, Pope, Tickell, Budgell, &c.; *Rambler* (20th March 1750 to 14th March 1752), Johnson; *Adventurer* (7th November 1752 to 9th March 1754), Hawkesworth, Johnson, Bathurst, Warton, Chapone; *World* (4th January 1753 to 30th December 1756), E. Moore, earl of Chesterfield, R. O. Cambridge, earl of Orford, Soame Jenyns, &c.; *Connoisseur* (31st January 1754 to 30th September 1756), Colman, Thornton, Warton, earl of Cork, &c.; *Idler* (15th April 1758 to 5th April 1760), Johnson, Sir J. Reynolds, and Bennett Langton; *Bee* (6th October 1759 to 24th November 1759), O. Goldsmith; *Mirror* (28d January 1779 to 27th May 1780), Mackenzie, Craig, Abercromby, Home, Bannatyne, &c.; *Lounger*, (5th February 1785 to 6th January 1787), Mackenzie, Craig, Abercromby, Tytler; *Observer* (1785 to 1790), Cumberland; *Looker-on* (10th March 1792 to 1st February 1794), W. Roberts, Beresford, Chalmers.

As from the "pamphlet of news" arose the weekly paper wholly devoted to the circulation of news, so from the general newspaper was specialized the weekly or monthly review of literature, antiquities, and science, which, when it included essay-papers, made up the magazine or miscellaneous repository of matter for information and amusement. Several monthly publications had come into existence since 1681, but perhaps the first germ of the magazine is to be found in the *Gentleman's Journal* (1691-94) of Peter Motteux, which, besides the news of the month, contained miscellaneous prose and poetry. In 1722 Dr Samuel Jebb included antiquarian notices as well as literary reviews in his *Bibliotheca Litteraria* (1722-24), but the *Gentleman's Magazine*, founded in 1731, fully established, through the tact and energy of the publisher Edward Cave, the type of the magazine, from that time so marked a feature of English periodical literature. This magazine, so long a source of fortune to its successive owners, was vainly offered during four years to different publishers before Cave was able to start it himself. The first idea is due to Motteux, from whom the title, motto, and general plan were borrowed. The chief feature in the new venture at first consisted of the analysis of the journals, which Cave undertook personally. Prizes were offered for poetry. In April 1732 the leading metropolitan publishers, jealous of the interloper Cave, started the *London Magazine*; or *Gentleman's Monthly Intelligencer* (1732-84), which

had a long and prosperous career. The new magazine closely copied Cave's title, plan, and aspect, and bitter war was long waged between the two. The rivalry was not without benefit to the literary public, as the conductors of each used every effort to improve their own review. Cave introduced the practice of giving engravings, maps, and portraits, but his greatest success was the addition of Johnson to the regular staff. This took place in 1738, when the latter wrote the preface to the volume for that year, observing that the magazine had "given rise to almost twenty imitations of it, which are either all dead or very little regarded." The plan was also imitated in Denmark, Sweden, and Germany. Cave edited his magazine down to his death in 1754, when it was continued by his brother-in-law David Henry, afterwards by John Nichols and his son. The specially antiquarian and historical features were dropped in 1868, and it was changed to a miscellany of light literature.

Many other magazines were produced in consequence of the success of these two. It will be sufficient to mention the following. The *Scots Magazine* (1739-1817) was the first published in Scotland; from 1817 to 1826 it was styled the *Edinburgh Magazine*. The *Universal Magazine* (1747) had a short, if brilliant, career; but the *European Magazine*, founded by James Perry in 1782, lasted down to 1826. Of more importance than these, or than the *Royal Magazine* (1759-71), was the *Monthly Magazine* (1796-1843), with which Priestley and Godwin were originally connected. During thirty years the *Monthly* was conducted by Sir Richard Phillips, under whom it became more statistical and scientific than literary. Class magazines were represented by the *Edinburgh Farmer's Magazine* (1800-25) and the *Philosophical Magazine* (1798), established in London by Alexander Tilloch; the latter at first consisted chiefly of translations of scientific articles from the French. The following periodicals, all of which date from the 18th century, are still published:—the *Gentleman's Magazine* (1731), the *Gospel Magazine* (1768),  *Wesleyan Methodist Magazine* (1778), *Curtis's Botanical Magazine* (1786), *Evangelical Magazine* (1793), *Methodist New Connexion Magazine* (1797), *Philosophical Magazine* (1798).

The increased influence of this class of periodical upon the public opinion of our own era was first apparent in *Blackwood's Edinburgh Magazine*, founded in 1817 by the publisher of that name, and carried to a high degree of excellence by the contributions of Scott, Lockhart, Hogg, Maginn, Syme, and John Wilson, the editor. It is still issued, and has always remained Liberal in literature and Conservative in politics. The *New Monthly Magazine* is somewhat earlier in date. It was founded in 1814 by the London publisher Colburn, and was edited in turns by Campbell, Theodore Hook, Bulwer Lytton, and Ainsworth. Many of Carlyle's and Thackeray's pieces first appeared in *Fraser's Magazine* (1830), long famous for its personalities and its gallery of literary portraits. The *Metropolitan Magazine* was started in opposition to *Fraser*, and was first edited by Campbell, who had left its rival. It subsequently came into the hands of Captain Marryatt, who printed in it many of his sea-tales. The *British Magazine* (1832-49) included religious and ecclesiastical information. From Ireland came the *Dublin University Magazine* (1833). The regular price of these magazines was half a crown; the first of the cheaper ones was *Tait's Edinburgh Magazine* (1832-61) at a shilling. It was Radical in politics, and had Roebuck as one of its founders. *Bentley's Miscellany* (1837-68) was exclusively devoted to novels, light literature, and travels. Several of Ainsworth's romances, illustrated by Cruikshank, first saw the light in *Bentley's*. The *Nautical Magazine* (1832) was addressed specially to

sailors, and Colburn's *United Service Journal* (1829) to both services. The *Asiatic Journal* (1816) dealt with Oriental subjects.

From 1815 to 1820 a number of low-priced and unwholesome periodicals flourished. The *Mirror* (1823-49), a two-penny illustrated magazine, begun by John Limbird,<sup>1</sup> and the *Mechanics Magazine* (1823) were steps in a better direction. The political agitation of 1831 led to a further popular demand, and a supply of cheap and healthy serials for the reading multitude commenced with *Chambers's Edinburgh Journal* (1832), the *Penny Magazine* (1832-45) of Charles Knight, issued under the patronage of the Society for the Diffusion of Useful Knowledge, and the *Saturday Magazine* (1832-44), begun by the Society for Promoting Christian Knowledge. The first was published at 1½d. and the last two at 1d. Knight secured the best authors and artists of the day to write for and illustrate his magazine, which, though at first a commercial success, may have had the reason of its subsequent discontinuance in its literary excellence. At the end of 1832 it had reached a sale of 200,000 in weekly numbers and monthly parts. It came to an end in 1845 and was succeeded by *Knight's Penny Magazine* (1845), which was stopped after six monthly parts. These periodicals were followed by a number of penny weeklies of a lower tone, such as the *Family Herald* (1843), the *London Journal* (1845), and *Lloyd's Miscellany*; the two former are still thriving. In 1850 the sale of the first of them was placed at 175,000 copies, the second at 170,000, and *Lloyd's* at 35,000. In 1848 fourteen penny and three halfpenny magazines, twelve social journals, and thirty-seven book-serials were produced every week in London. A further and permanent improvement in cheap weeklies for home reading may be traced from the foundation of *Howitt's Journal* (1847-49), and more especially *Household Words* (1850), conducted by Charles Dickens, *All the Year Round* (1859), by the same editor, and afterwards by his son, *Once a Week* (1859), and the *Leisure Hour* (1852). The plan of *Notes and Queries* (1849), for the purpose of intercommunication among those interested in special points of literary and antiquarian character, has led to the adoption of similar departments in a great number of newspapers and periodicals, and, besides several imitators in England, there are now parallel journals in Holland, France, and It'y.

Recent shilling monthlies began with *Macmillan* (1859), the *Cornhill* (1860), and *Temple Bar* (1860). The *Cornhill*, first edited by Thackeray, was known for its specially literary tone down to 1883. *St James's Magazine* (1861), *Belgravia* (1866), *St Paul's* (1867-74), *London Society* (1862), and *Tinsley's* (1867) are devoted chiefly to novels and light reading. The sixpenny illustrated magazines commenced with *Good Words* (1860) and the *Quiver* (1861), both religious in tendency. In 1882 *Fraser* changed its name to *Longman's Magazine*, and was entirely popularized and reduced to sixpence. The *Cornhill* followed the same example in 1883, reducing its price to sixpence and devoting its pages to light reading. The *English Illustrated Magazine* (1883) was brought out in competition with the American *Harper and Country*. Of the artistic periodicals we may signalize the *Art Journal* (1849), long known for its line engravings, the *Portfolio* (1870), which has done much to popularize etching, and the *Magazine of Art* (1878).

The following statistics furnish an idea of the marvelous increase in the number of periodicals issued at different times during the last fifty years. In figures submitted

<sup>1</sup> John Limbird, to whom even before Chambers or Knight is due the carrying out the idea of a cheap and good periodical for the people, died so recently as 31st October 1883, without having achieved the worldly prosperity of his two followers.

to the House of Commons in 1884 Sir Edward Baines estimated the circulation of the monthly magazines in 1831 at no more than 125,000 copies; when he spoke the number had increased to 3,609,350. The weeklies might be reckoned in 1831 at about equal to the monthlies in circulation, and the miscellaneous serials at 120,000, amounting altogether to 420,000 copies. In 1864 the circulation of weeklies and monthlies reached a total of 6,094,950 (*Journal of Statist. Soc.*, 1864, pp. 410-412). Concurrently with this increase in the whole number published there may be observed an equally regular decrease in the average cost of each. In 1831 there were issued in London alone 177 monthlies, costing £17, 12s. 6d., or an average of 2s. apiece. At the end of 1833 there were 236 of the same class, costing £23, 3s. 6d., and the average price had decreased to 1s. 11½d. Twenty years later, in 1853, there were 362 monthlies, costing £14, 17s. 6d., the average cost of each being now only 9½d. (*Knight's Old Printer and Modern Press*, 263).

In London itself the increase of the weeklies, monthlies, and quarterlies at different periods has been as follows:—

	Weekly.	Monthly.	Quarterly.	Total.
1833	21	226	25	272
1837	59	156	24	239
1844	69	227	22	318
1853	58	262	59	409
1868	{ Included in }	463	75	538
	{ monthlies }			
1874	50	463	84	597
1884	110	609	125	844

Extending the inquiry to the whole of the United Kingdom, and including every description of periodical, with the exception of annuals and newspapers, *May's British and Irish Press Guide* for the years 1874 and 1884 supplies this comparison:—

	1874.	1884.		1874.	1884.
Metropolis .....	541	771	Daily .....	1	13
England .....	66	154	Three times a week .....	..	2
Wales .....	15	36	Weekly .....	58	114
Scotland .....	27	61	Twice a month .....	5	13
Ireland .....	11	26	Monthly .....	622	699
Channel Isles, &c. ....	2	2	Bi-monthly .....	5	9
			Quarterly .....	84	129
Total .....	662	1041	Half-yearly .....	4	6
			Irregular .....	28	47
			Total .....	662	1041

The chief classes into which the same periodicals may be divided are:—

	Religious.	Illustrated.	Juvenile.	Trade-organs.
1838	196	175	59	64
1874	297	223	100	67
1884	280	223	100	127

Among the different periodicals issued in 1884 there were also 73 advocating temperance, 28 devoted to agriculture, 57 family magazines, 31 financial, 15 insurance, 18 medical, 7 secularist, 9 tailoring, and 7 bicycling.

*Indexes to English Periodicals.*—Lists of the separate indexes to particular series are given in H. B. Wheatley's *What is an Index?* 1879, and *List of Bibliographies in the Reading Room of the British Museum*, 1881. The valuable and elaborate work of W. F. Poole, *Index to Periodical Lit.*, Boston (Massachusetts), 1882, supplies an exhaustive alphabetical index to the titles of articles in 6205 volumes of English and American serials of the present century. Monthly supplements appear in the *Library Journal*.

*Authorities.*—"Periodicals." in the British Museum catalogue; *Louvain, Bibliographer's Manual*, by Hy. G. Bohn, 1864; *Cat. of Periodicals in the Bodl. Lib.*, part I., "English Periodicals," 1878; *Cat. of the Hope Collection of Early Newspapers and Tracts in the Bodl. Lib.*, 1865; *Scrivener, Cat. of Scientific Serials*, 1879; *Andrews, Hist. of Brit. Journalism*, 1869; *Cochran, Hist. of the Press in Angleterre et aux Etats Unis*, 1867; *Madden, Hist. of Irish Period. Lit.*, 1867; J. Grant, *The Great Metropolitan*, II. pp. 229-237; "Periodical Essays of the Age of Anne," in *N. American Rev.*, xlv., *Drake, Essays on the "Spectator," "Tatler," &c.*, 1810-14; *Courthope, Address*, ("Engl. Men of Letters"), 1864; "Forgotten Periodical Publications," in *Notes and Queries*, ser. III., vol. IX. 33; "Account of Periodical Literary Journals from 1681 to 1749," by A. Parkes, in *Quart. Journ. of Sc., Lit., &c.*, xiii. 26, 269; "Last Century Magazine," in *Fraser's*

Mag. Sept. 1876, 325; "Periodicals during 1712-32," in *Notes and Queries*, ser. II, vol. IX, 73, &c., x, 184; "Catholic Period. Lit.," *ib.*, ser. V, vol. XI, 47, 48; "Early Roman Catholic Magazines" *ib.*, ser. VI, vol. III, 48, &c., IV, 11; Timperley, *Encyc. of Lit. Assoc.*, 1842; C. Knight, *The Old Printer and the Modern Press*, 1854, and *Passages of a Working Life*, 1864-65; *Memoir of Robert Chambers*, 1872; *The London Cat. of Periodicals, Newspapers, &c.*, 1844-84; Mitchell, *Newspaper Press Directory*, 1846-84; May, *British and Irish Press Guide*, 1874-84; *The Bookseller*, Feb. 1867, June and July 1868, Aug. 1874, July 1879.

**India and the British Colonies.**—The first Indian periodical was the *Calcutta Monthly Register* (1790), which lasted but a short time. A *Calcutta Literary Gazette* came out in 1830. In 1844 appeared the first number of the *Calcutta Review* (1844), which is still the most important serial of the Indian empire. The *Bombay Quarterly Review* was founded in 1855. Madras had a *Journal of Literature and Science* and the *Oriental Magazine and Indian Hurkuru* (1819). The *Religious and Theological Magazine* was produced at Colombo in 1833. The *Christian College Magazine* was commenced in 1833. At Singapore the *Journal of the Indian Archipelago* appeared from 1847 to 1855. The *Chinese Repository* (1832), edited at Canton by Morrison, dealt with the farther East. See "Periodical Literature in India" in *Dark Blue*, 1873-74.

Hubbard (*Newspaper Directory*) estimates the existing periodicals (omitting newspapers) of British North America at 652.

The number of weekly, monthly, and quarterly publications of Australia, Tasmania, and New Zealand is placed by the same authority at 570. The *Melbourne Review* (1876) deserves special mention.

FOREIGN.

**France.**—We owe the literary journal to France, where it soon attained to a degree of importance unapproached in any other country. The first idea may be traced in the *Bureau d'Adresses* of Théophraste Renaudot, giving the proceedings of his conferences upon literary and scientific matters (1638-42). About the year 1683 Mézeray obtained a privilege for a regular literary periodical, which came to nothing, and it was left to Denis de Sallo, counsellor of the parliament of Paris and a man of rare merit and learning, to actually carry the project into effect. The first number of the *Journal des Savants* appeared on 5th January 1665, under the assumed name of the sieur d'Hérouville. The prospectus promised to give an account of the chief books published throughout Europe, obituary notices, a review of the progress of science, besides legal and ecclesiastical information and other matters of interest to cultivated persons. The criticisms, however, wounded alike authors and the clergy, and the journal was suppressed after a career of three months. Colbert, seeing the public utility of such a periodical, ordered the abbé Gallois, a contributor of De Sallo's, to re-establish it, an event which took place on 4th January 1666. It lingered nine years under the new editor, who was replaced in 1675 by the abbé de la Roque, and the latter in his turn by the president Cousin in 1686. From 1701 commenced a new era for the *Journal*, which was then acquired by the chancellor de Pontchartrain for the state and placed under the direction of a commission of learned men. Just before the Revolution it developed fresh activity, but the troubles of 1792 caused it to be discontinued until 1796, when it again failed to appear after twelve numbers had been issued. In 1816 it was definitively re-established and replaced under Government patronage, remaining subject to the chancellor or garde-des-sceaux until 1857, when it was transferred to the control of the minister of public instruction. The present organization much resembles that of an academy. The members of the commission are elected, approved of by the minister, and divided into assistants and authors, the latter furnishing at least three articles per annum at a fixed and modest rate of payment. All communications are discussed at fortnightly conferences.

Louis Auguste de Bourbon, sovereign prince of Dombes, having transferred his parliament to Trévoux, set up a printing press, and was persuaded by two Jesuits, Michel le Tellier and Philippe Lalleman, to establish the *Mémoires pour servir à l'Histoire des Sciences et des Arts* (1701-67), more familiarly known as the *Journal de Trévoux*, long the best-informed and best-written journal in France. One feature of its career was its constant appeal for the literary assistance of outsiders. It was continued in a more popular style as *Journal des Sciences et des Beaux-Arts* (1768-75) by the abbé Aubert and by the brothers Castillon (1776-78), and as *Journal de Littérature, des Sciences, et des Arts* (1779-82) by the abbé Grosier.

The first legal periodical was the *Journal du Palais* (1672) of Blondan and Guéret, and the first devoted to medicine the *Nouvelles Découvertes dans toutes les Parties de la Médecine* (1679) of Nicolas du Blégné, frequently spoken of as a charlatan, a term which sometimes means simply a man of many ideas. Religious periodicals date from 1680 and the *Journal Ecclésiastique* of the abbé de la Roque. The prototype of the historico-literary periodical may be discovered in *La Clef du Cabinet des Princes de l'Europe* (1704-8), familiarly known as *Journal de Verdun*, and carried on under various titles down to 1794.

Literary criticism was no more free than political discussion, and

no person was allowed to trespass either upon the domain of the *Journal des Savants* or that of the *Mercur de France* without the payment of heavy subsidies. This was the origin of the clandestine press of Holland, and it was that country which for the next hundred years supplied the ablest periodical criticism from the pens of French Protestant refugees. During that period thirty-one journals of the first class proceeded from these sources. From its commencement the *Journal des Savants* was pirated in Holland, and for ten years a kind of joint issue made up with the *Journal des Trévoux* appeared at Amsterdam. From 1764 to 1775 miscellaneous articles from different French and English reviews were added to this reprint. Bayle, a born journalist and the most able critic of the day, conceived the plan of the *Nouvelles de la République des Lettres* (1684-1718), which at once became entirely successful and obtained for him during the three years of his control the dictatorship of the world of letters. He was succeeded as editor by La Roque, Barrin, Bernard, and Leclerc. Bayle's method was followed in an equally meritorious periodical, the *Histoire des Ouvrages des Savants* (1687-1704) of H. Beaune de Beauval. Another continuator of Bayle was Jean Leclerc, one of the most learned and acute critics of the 18th century, who carried on three reviews, the *Bibliothèque Universelle et Historique* (1686-93), the *Bibliothèque Choisie* (1703-13), and the *Bibliothèque Ancienne et Moderne* (1714-27). They form one series, and, besides valuable estimates of new books, include original dissertations, articles, and biographies like our modern learned magazines. The *Journal Littéraire* (1713-22, 1729-36) was founded by a society of young men, who made it a rule to discuss their contributions in common. Specially devoted to English literature were the *Bibliothèque Angloise* (1716-28), the *Mémoires Littéraires de la Grande Bretagne* (1720-24), the *Bibliothèque Britannique* (1733-34), and the *Journal Britannique* (1750-57) of Maty,<sup>1</sup> who took for his principle, "pour penser avec liberté il faut penser seul." One of these Dutch-printed reviews was *L'Europé Savants* (1718-20), founded chiefly by Themiseul de Saint-Hyacinthe, with the intention of placing each separate department under the care of a specialist. The *Bibliothèque Germanique* (1720-40) was established by Jacques Lenfant to do for northern Europe what the *Bibliothèque Britannique* did for England. It was followed by the *Nouvelles Bibliothèques Germaniques* (1746-59). The *Bibliothèque Raisonnée des Ouvrages des Savants* (1728-58) was supplementary to Leclerc, and was succeeded by the *Bibliothèque des Sciences et des Beaux-Arts* (1764-80). Nearly all of the preceding were produced either at Amsterdam or Rotterdam, and, although out of place in a precise geographical arrangement, really belong to France by the close ties of language and of blood.

Taking up the exact chronological order again, we find the success of the English essay-papers led to their prompt introduction to the Continent. An incomplete translation of the *Spectator* was published at Amsterdam in 1714, and many volumes of extracts from the *Talier*, *Spectator*, and *Guardian* were issued in France early in the 18th century. Marivaux brought out a *Spectateur Français* (1722), which was coldly received; it was followed by fourteen or fifteen others under the titles of *La Spectatrice* (1728-30), *Le Radoteur* (1778), *Le Babillard* (1778-79), &c. Of a similar character was *Le Poux et le Contre* (1723-40) of the abbé Prévost, which contained anecdotes and criticism, with special reference to Great Britain. Throughout the 18th century, in France as in England, a favourite literary method was to write of social subjects under the assumed character of a foreigner, generally an Oriental, with the title of *Turkish Spy*, *Lettres Chinoises*, &c. These productions were usually issued in periodical form, and, besides an immense amount of worthless tittle-tattle, contain some valuable matter.

During the first half of the century France has little of importance to show in periodical literature. The *Nouvelles Ecclésiastiques* (1728-1808) were first printed and circulated secretly by the Jansenists in opposition to the *Constitution Unigenitus*. The Jesuits retaliated with the *Supplément des Nouvelles Ecclésiastiques* (1734-48). The promising title may have had something to do with the temporary success of the *Mémoires Secrets de la République des Lettres* (1744-48) of the marquis d'Argens. In the *Observations sur les Ecrits Modernes* (1735-43) Desfontaines held the gates of Philistia for eight years against the Encyclopedists and even the redoubtable Voltaire himself. It was continued by the *Jugements sur quelques Ouvrages nouveaux* (1744-46). The name of Fréron, perhaps the most vigorous enemy Voltaire ever encountered, was long connected with *Lettres sur quelques Ecrits de ce Temps* (1749-54), followed by *L'Année Littéraire* (1754-90). Among the contributors of Fréron was another manufacturer of criticism, the abbé de la Porte, who, having quarrelled with his confrère, founded *Observations sur la Littérature Moderne* (1749-52) and *L'Observateur Littéraire* (1758-61).

A number of special organs came into existence about this period. The first treating of agriculture and domestic economy was the *Journal Economique* (1761-72); a *Journal de Commerce* was founded

<sup>1</sup> Matthew Maty, M.D., born in Holland, 1718, died principal librarian of the British Museum, 1776. He settled in England in 1749, published several books, and wrote the preface to Gibbon's first work, *Essai de Littérature*.

in 1759; periodical biography may be first seen in the *Nécrologe des Hommes Célèbres de France* (1764-82); the political economists established the *Éphémérides du Citoyen* in 1765; the first *Journal d'Éducation* was founded in 1768, and the *Courrier de la Mode* in the same year; the theatre had its first organ in the *Journal des Théâtres* (1770); in the same year were produced a *Journal de Musique* and the *Encyclopédie Militaire*; the sister service was supplied with a *Journal de Marine* in 1778. We have already noticed several journals specially devoted to one or other foreign literature. It was left to Fréron, Grimm, Prévost, and others in 1784 to extend the idea to all foreign productions, and the *Journal Étranger* (1784-82) was founded for this purpose. The *Gazette Littéraire* (1764-66), which had Voltaire, Diderot, and Saint-Lambert among its editors, was intended to swamp the small fry of criticism; the *Journal des Dames* (1759-78) was of a light magazine class; and the *Journal de Monsieur* (1776-83) had three phases of existence, and died after extending to thirty volumes. The *Mémoires Secrets pour servir à l'Histoire de la République des Lettres* (1762-87), better known as *Mémoires de Bachaumont*, from the name of their founder, furnish a minute account of the social and literary history for a period of twenty-six years. Of a similar character was the *Correspondance Littéraire Secrète* (1774-93), to which Métra was the chief contributor. *L'Esprit des Journaux* (1772-1818) forms an important literary and historical collection, which is rarely to be found complete.

The movement of ideas at the close of the century may best be traced in the *Annales Politiques, Civiles, et Littéraires* (1777-92) of Linguet. The *Décade Philo-sophique* (year V. or 1796/97), founded by Ginguené, is the first periodical of the magazine class which appeared after the storms of the Revolution. It was a kind of resurrection of good taste; under the empire it formed the sole refuge of the opposition. By a decree of 17th January 1800 the consulate reduced the number of Parisian journals to thirteen, of which the *Décade* was one; and all the others, with the exception of those dealing solely with science, art, commerce, and advertisements, were suppressed. A report addressed to Bonaparte by Flévois<sup>1</sup> in the year XI. (1802/3) furnishes a list of fifty-one of these periodicals. In the year XIII. (1804/5) only seven non-political serials were permitted to appear.

Between 1815 and 1819 there was a constant struggle between freedom of thought on the one hand and the censure, the police, and the law-officers on the other. This oppression led to the device of "semi-periodical" publications, of which *La Minerve Française* (1818-20) is an instance. It was the *Satire Ménippée* of the Restoration, and was brought out four times a year at irregular intervals. Of the same class was the *Bibliothèque Historique* (1818-20), another anti-royalist organ. The censure was re-established in 1820 and abolished in 1828 with the monopoly. It has always seemed impossible to carry on successfully in France a review upon the lines of those which have become so numerous and important in England. The short-lived *Revue Française* (1828-30), founded by Guizot, Rémusat, De Broglie, and the doctrinaires, was an attempt in this direction. The well-known *Revue des Deux Mondes* was established in 1829 by Ségur-Dupeyron and Mauroy, but it ceased to appear at the end of the year, and its actual existence dates from its acquisition in 1831 by François Buloz,<sup>2</sup> a masterful editor, under whose energetic management it soon achieved a world-wide reputation. The most distinguished names in French literature have been among its contributors, for whom it has been styled the "vestibule of the Academy." It was preceded by a few months by the *Revue de Paris* (1829-45), founded by Yéron, who introduced the novel to periodical literature. In 1834 this was purchased by Buloz, and brought out concurrently with his other *Revue*. While the former was exclusively literary and artistic, the latter dealt more with philosophy. The *Revue Indépendante* (1841-48) was founded by Pierre Leroux, George Sand, and Viardot for the democracy. The times of the consulate and the empire were the subjects dealt with by the *Revue de l'Empire* (1842-48). In *Le Correspondant* (1848), established by Montalembert and De Falloux, the Catholics and Legitimists had a valuable supporter. The *Revue Contemporaine* (1852), founded by the comte de Belval as a royalist organ, had joined to it in 1856 the *Athenæum Français*. The *Revue Germanique* (1858) exchanged its exclusive name and character in 1865 to the *Revue Moderne*. The *Revue Européenne* (1859) was at first subvented like the *Revue Contemporaine*, from which it soon withdrew Government favour. The *Revue Nationale* (1860) appeared quarterly, and succeeded to the *Magasin de Librairie* (1858).

The list of current periodicals, to which should be added the

<sup>1</sup> The novelist and publicist Joseph Flévois (1767-1839). Known for his relations with Napoleon I., has been made the subject for a study by Sainte-Beuve (*Cronique*, v. 172).

<sup>2</sup> This remarkable man (1804-1877) began life as a shepherd. Educated through the charity of M. Naville, he came to Paris as a compositor, and by translating from the English earned sufficient to purchase the moribund *Revue des Deux Mondes*, which acquired its subsequent position in spite of the tyrannical editorial behaviour of the proprietor. M. Monod (*Academy*, 30th Jan. 1877) states that latterly Buloz enjoyed an income of 365,000 francs from the *Revue*.

*Revue des Deux Mondes* and the *Correspondant*, include the following. Among those devoted to literature and criticism may be mentioned the *Revue Britannique* (1825); the *Revue Critique d'Histoire et de Littérature* (1856), one of the first of European weekly reviews; *Revue Politique et Littéraire*, successor to the *Revue des Cours Littéraires* (1863), also weekly; *Le Livre* (1880), confined to bibliography and literary history, monthly; and the *Nouvelle Revue* (1879), already a serious rival of the *Revue des Deux Mondes*, which it resembles in character and mode of publication, although distinctly Republican in politics. History and archaeology are represented by the *Bibliothèque de l'École des Chartes* (1839), which deals especially with the Middle Ages, and is published every two months; the *Cabinet Historique* (1855), a monthly, devoted to MSS. and unpublished documents; the *Revue Historique* (1876), two-monthly; and the monthly *Revue Archéologique* (1860). The fine arts are cared for by the *Gazette des Beaux-Arts* (1859), monthly, and *L'Art* (1875), published weekly. We may also mention the *Revue Philologique* (1876), monthly, and *Le Tour du Monde* (1860), an illustrated weekly, consisting entirely of voyages and travels.

In 1883, apart from political newspapers, there were published in Paris 1379 periodicals of all kinds. They may be classified in the following order:—theology 96, jurisprudence 130, reviews 75, popular reading 169, history and geography 37, political economy and finance 243, sciences generally 26, mathematics 6, medicine 101, natural science 21, military 14, naval 12, fine arts 75, fashion 81, education 46, technology 137, agriculture 46, sport 24, miscellaneous 40.

*Authorities.*—The subject of French periodicals has been exhaustively treated in the valuable works of Eugène Hatin, *Histoire de la Presse en France, 1559-61*, 8 vols.; *Les Gazette de Hollande et la Presse Claudienne aux 17<sup>e</sup> et 18<sup>e</sup> Siècles*, 1865; and *Bibliographie de la Presse Périodique Française, 1664. See also Catalogue de l'Histoire de France, 1855-79*, 11 vols.; Y. Gédé, *Catalogue des Journaux*, etc., publié à Paris, 1879; Brunet, *Manuel du Libraire, avec Supplément*, 1800-80, 6 vols.; H. Le Boudier, *Catologue-Index des Journaux, Revues, et Publications Périodiques parus en Paris jusqu'en 1883*, 1883; F. Häge, *Les Journaux et Ecriis Périodiques de la Basse Autvergne*, 1866.

*Germany.*—The earliest trace of the literary journal in Germany is to be found in the *Erbauliche Monatsunterredungen* (1663) of the poet Johann Rist and in the *Miscellanea curiosa medico-physica* (1670-1704) of the Academia naturæ curiosorum Leopoldina-Carolina, the first scientific annual, uniting the features of the *Journal des Savants* and of the *Philosophical Transactions*. D. G. Morhof, the author of the well-known *Polylotus*, conceived the idea of a monthly serial to be devoted to the history of modern books and learning, which came to nothing. While professor of morals at Leipzig, Otto Mencke planned the *Acta Eruditorum*, with a view to make known, by means of analyses, extracts, and reviews, the new works produced throughout Europe. In 1680 he travelled in England and Holland in order to obtain literary assistance, and the first number appeared in 1682, under the title of *Acta Eruditorum Lipsicium*, and, like its successors, was written in Latin. Among the contributors to subsequent numbers were Leibnitz, Sockendorf, and Cellarius. A volume came out each year, with supplements. After editing about 80 volumes Mencke died, leaving the publication to his son, and the *Acta* remained in the possession of the family down to 1745, when they extended to 117 volumes, which form an extremely valuable history of the learning of the period. A selection of the dissertations and articles was published at Venice in 7 vols. 4to, 1740. The *Acta* soon had imitators. The *Ephemerides Literariæ* (1686) came out at Hamburg in Latin and French. The *Novæ Litterariæ variæ Bibliothecæ et Septentrionis* (1698-1708) was more especially devoted to north Germany and the universities of Kiel, Rostock, and Dorpat. Supplementary to the preceding was the *Novæ Litterariæ Germanicæ collecta Hamburgi* (1703-9), which from 1707 widened its field of view to the whole of Europe. At Leipzig was produced the *Teutsche Acta Eruditorum* (1712), an excellent periodical, edited by J. G. Rabener and C. G. Jöcher, and continued from 1740 to 1768 as *Zweckmäßige Nachrichten*. It included portraits.

The brilliant and enterprising Christian Thomassius brought out periodically, in dialogue form, his *Monatgespräche* (1683-90), written by himself in the vernacular, to defend his novel theories against the alarmed pedantry of Germany, and, together with Strahl, Buddens, and others, *Observationes selectæ ad rem litterariam spectantes* (1700), written in Latin. W. E. Tenzel also published *Monatliche Unterredungen* (1689-98), continued from 1704 as *Curiosæ Bibliothecæ*, and treating various subjects in dialogue form. After the death of Tenzel the *Bibliothecæ* was carried on under different titles by C. Wolterrock, J. G. Krause, and others, down to 1721. Of much greater importance than these was the *Monatlicher Aeuung* (1701), supported by J. G. Eccard and Leibnitz. Another periodical on Thomassius's plan was *Neue Unterredungen* (1702), edited by N. H. Gundling. The *Gundlingiana* of the latter person, published at Halle (1715-32), and written partly in Latin and partly in German by the editor, contained a miscellaneous collection of juridical, historical, and theological observations and dissertations.

Nearly all departments of learning possessed their several special periodical organs about the close of the 17th or the beginning of the 18th century. The *Annæ Franciscanorum* (1680) was edited by the Jesuit Stiller; and J. S. Adami published, between 1690 and 1713, certain theological repertoires under the name of *Deliciae*.

Historical journalism was first represented by *Acta Juris Publici* (1709), philology by *Neus Aevora Philologica* (1715-23), philosophy by the *Acta Philosophorum* (1715-27), medicine by *Der patriotische Medikus* (1726), music by *Der musikalische Patriot* (1726), and education by *Die Matrone* (1728). Reference has already been made to the *Miscellanea curiosa medico-physica* (1670-1704); the *Monatliche Erzählungen* (1689) was also devoted to natural science.

Down to the early part of the 18th century Halle and Leipzig were the headquarters of literary journalism in Germany. Other centres began to feel the need of similar organs of opinion. Hamburg had its *Niederdeutsche neue Zeitungen*, styled from 1731 *Niederdeutsche Nachrichten*, which came to an end in 1736, and Mecklenburg owned in 1710 its *Neuer Vorrath*, besides others brought out at Rostock. Prussia owes the foundation of its literary periodicals to G. P. Schulze and M. Lillenthal, the former of whom began with *Gelahrtes Preussen* (1722), continued under different titles down to 1729; the latter helped with the *Erleuchtetes Preussen* (1724), and was the sole editor of the *Acta Borussiae* (1730-32). Pomerania and Silesia also had their special periodicals in the first quarter of the 18th century. Franconia commenced with *Neue Litteraria*, and Hesse with the *Kurs Historie*, both in 1725. In south Germany appeared the *Württembergische Nebenstunden* (1718), and the *Paronensis Boicus*, first published at Munich in 1722. The *Frankfurter gelehrte Zeitung* was founded in 1736 by S. T. Hoeker, and existed down to 1790. Austria owned *Das merkwürdige Wien*.

In 1715 the *Neue Zeitungen von gelehrten Sachen* was founded by J. G. Krause at Leipzig and carried on by various editors down to 1797. It was the first attempt to apply the form of the weekly political journal to learned subjects, and was imitated in the *Vermischte Bibliothek* (1718-30), and the *Bibliotheca Novissima* (1718-21), both founded by J. G. Francke in Halle. Shortly after the foundation of the university of Göttingen appeared *Zeitung von gelehrten Sachen* (1739), still famous as the *Göttingische gelehrte Anzeigen*, which during its long and influential career has been conducted by professors of that university, and among others by Haller, Heyne, and Eichhorn.

Influenced by a close study of English writers, the two Swiss Bodmer and Breitinger established *Die Discurs der Maler* (1721), and, by paying more attention to the matter of works reviewed than to their manner, commenced a critical method new to Germany. The system was attacked by Gottschall, who, educated in the French school, erred in the opposite direction. The war between the two parties gave fresh life to the literature of the country, but German criticism of the higher sort can only be said really to begin with Lessing. The Berlin publisher Nicolai founded the *Bibliothek der schönen Wissenschaften*, and afterwards handed it over to G. F. Waiss in order to give his whole energy to the *Briefe, die neueste Literatur betreffend* (1760-65), carried on by the help of Lessing, Mendelssohn, and Abbt. To Nicolai is also due the *Allgemeine deutsche Bibliothek* (1765-1806), which embraced a much wider field and soon became extremely influential. Herder founded the *Kritische Wälder* in 1766. *Der deutsche Merkur* (1778-89, revived 1790-1810) of Wieland was the solitary representative of the French school of criticism. A new era in German periodical literature began when Bertuch brought out at Jena in 1785 the *Allgemeine Literaturzeitung*, to which the leading writers of the country were contributors. On being transferred to Halle in 1804 it was replaced by the *Jenaische allgemeine Literaturzeitung*, founded by Eichstädt. Both reviews enjoyed a prosperous career down to the year 1848.

At the commencement of the present century we find the *Brieger Literaturzeitung* (1799-1810), which had replaced a *Gelahrte Zeitung* (1746); the *Leipziger Literaturzeitung* (1800-34); the *Heidelbergische Jahrbücher der Literatur* (1808); and the *Wiener Literaturzeitung* (1813-16), followed by the *Wiener Jahrbücher der Literatur* (1818-48), both of which received Government support and were like the *Quarterly Review* in their conservative politics and high literary tone. *Hermes*, founded at Leipzig in 1819 by W. T. Krug, was distinguished for its erudition, and came out down to 1831. One of the most remarkable periodicals of this class was the *Jahrbücher für wissenschaftliche Kritik* (1827-46), first published by Cotta. The *Halleische Jahrbücher* (1838-42) was founded by Enge and Echtermeyer, and supported by the Government. The *Repertorium der germanischen deutschen Literatur*, established by Gersdorf in 1834, and known after 1843 as the *Leipziger Repertorium der deutschen und ausländischen Literatur*, existed to 1860. Buchner founded the *Literarische Zeitung* at Berlin in 1834. It was continued by Brandes down to 1849. The political troubles of 1848 and 1849 were most disastrous to the welfare of the literary and miscellaneous periodicals. Gersdorf's *Repertorium*, the *Gelahrte Anzeigen* of Göttingen and of Munich, and the *Heidelberg Jahrbücher* were the sole survivors. The *Allgemeine Monatschrift für Literatur* (1850), conducted after 1851 by Droyen, Nitzsch, and others, continued only down to 1854; the *Literarisches Centralblatt* (1850) had a longer existence. The *Blätter für literarische Unterhaltung* sprang out of the *Literarisches Wochenblatt* (1818), founded by Kotzebue; since 1865 it has been edited by R. Gottschall with considerable

success. Many of the literary journals did not disdain to occupy themselves with the fashions, but the first periodical of any merit specially devoted to the subject was the *Bazar* (1856). The first to popularize science was *Natur* (1852). The *Hausblätter* (1855), a bi-monthly magazine, was extremely successful. The *Salon* (1868) followed more closely the type of the English magazine.

About this period arose a great number of serials for popular reading, known as "Sontagsblätter," of which the *Gartenlaube* (1858) and *Daheim* are examples. Of a more solid character are the *Deutsches Museum* (1851-57) of Frutz and Frenzel; the *Grenobler*; the *Preussische Jahrbücher* (1858); the *Berliner Bevue* (1855); *Unsere Zeit* (1857), at first only a kind of supplement to Brockhaus's *Conversationslexikon*, but now an important review of matters of contemporary interest; *Die Gegenwart* (1872); the new *Literaturzeitung* (1874) of Jena; and the *Deutsche Rundschau* (1874), conducted upon the method of the *Bevue des Deux Mondes*; and many others.

Periodicals have been specialised in Germany to an extent perhaps unequalled in any other country. Those of a really high class have become so numerous and form so marked a feature in the current literature that it may be useful to give a classified list of the chief of them, including the many *Jahresberichte* which supply summaries of the works published annually in particular departments. BIBLIOGRAPHICAL AND LITERARY:—*Petold's neuer Anzeiger*; *Centralblatt für Bibliotekwissenschaft*; *Allgemeine Bibliographie für Deutschland*; *Bibliographie und literarische Chronik der Schweiz*; *Polytechnische Bibliothek*; *Blätter für literarische Unterhaltung*, ed. by Rud. von Gottschall; *Literarisches Centralblatt für Deutschland*; *Die Gegenwart*; *Die Grenobler*; *Deutsche Rundschau*; *Im neuen Reich*; *Preussische Jahrbücher*; *Magazin für die Literatur des In- und Auslandes*; *Die neue Zeit*; *Archiv f. Literaturgeschichte*; *Westermann's illustrierte deutsche Monatshefte*.

THEOLOGY:—*Der Katholik*; *Theologische Literaturzeitung*; *Theologische Studien und Kritiken*; *Theologische Studien aus Württemberg*; *Theologische Quartalschrift*; *Zeitschrift für Kirchengeschichte*; *Neue evangelische Kirchen-Zeitung*; *Protestantische Kirchen-Zeitung*; *Monatschrift für Geschichte d. Judenthums*. LAW, POLITICAL ECONOMY, &c.:—*Jahrbuch f. Gesetzgebung*; *Jahrbuch der deutschen Gerichtsverfassung*; *Zeitschrift für Rechtsgeschichte*; *Jahrbuch der preussischen Gerichtsverfassung*; *Annalen d. Reichsgerichte*; *Souffroy's Archiv für Entscheidung der oberen Gerichte*; *Souffroy's Blätter f. Rechtsanwendung*; *Jahrbuch für das deutsche Versicherungswesen*; *Jahrbücher für Nationalökonomie und Statistik*; *Zeitschrift f. gesamte Staatswissenschaft*; *Vierteljahrsschrift für Volkswirtschaft*; *Statistische Monatschrift*. MEDICINE AND SURGERY:—*Archiv für Anthropologie*; *Archiv f. experimentelle Pathologie*; *Schmid's Jahrbücher der in- und ausländischen ges. Medicin*; *Zeitschrift f. klin. Medicin*; *Archiv für Anatomie und Physiologie*; *Morphologisches Jahrbuch*; *Archiv für Gynäkologie*; *Deutsche Zeitschrift für Chirurgie*; *Archiv f. klin. Chirurgie*; *Graef's Archiv*; *Vierteljahrsschrift für gerichtl. Medicin*. NATURAL SCIENCE:—*Archiv für Anatomie u. Physiologie*; *Archiv für Naturgeschichte*; *Annalen der Physik und Chemie*; *Annalen der Mathematik und Physik*; *Botanischer Jahresbericht*; *Botan. Jahrbücher*; *Flora*; *Botanische Zeitung*; *Zoologischer Jahresbericht*; *Zeitschrift für wissenschaftl. Zoologie*; *Jahresbericht über d. Fortschritte d. Chemie*; *Liebig's Annalen d. Chemie*. PHILOLOGY:—*Philosophische Monatshefte*; *Zeitschrift für Philologie*. EDUCATION:—*Rheinische Blätter*; *Neue Jahrbücher für Philologie*; *Pädagogischer Jahresbericht*.

JUVENILE LITERATURE:—*Herzblütchen Zeitvertreib*; *Deutsche Jugend*. CLASSICAL ARCHEOLOGY AND PHILOLOGY:—*Jahrbücher für class. Philologie*; *Hermes*; *Rheinisches Museum*; *Philologus*; *Archäologische Zeitung*; *Jahresberichte üb. d. Fortschritte d. class. Alterthumswissenschaft*. ORIENTAL LITERATURE:—*Zeitschrift d. deutschen morgenländischen Gesellschaft*; *Zeitschrift f. Volkpsychologie*. MODERN LANGUAGES:—*Anglia*; *Archiv f. d. Studium d. neueren Sprachen*; *Germania*; *Zeitschrift f. deut. Alterthum*. HISTORY, &c.:—*Sybel's hist. Zeitschrift*; *Jahresberichte der Geschichtswissenschaft*; *Archiv f. Anthropologie*; *Archiv f. osterr. Geschichte*; *Das Staatsarchiv*; *Forschungen u. deut. Geschichte*; *Baltische Studien*; *Zeits. f. Museologie*; *Zeits. f. Numismatik*. GEOGRAPHY:—*Geogr. Jahrbuch*; *Globus*; *Das Ausland*; *Petermann's Mitteilungen*; *Zeitschrift f. Ethnologie*. MATHEMATICS AND ASTRONOMY:—*Jahrbuch üb. d. Fortschritte d. Mathematik*; *Archiv d. Mathematik u. Physik*; *Journal f. d. reine u. angewandte Math.*; *Zeitschrift f. Mathematik*; *Astronomische Nachrichten*. ARMY AND NAVY:—*Jahresberichte üb. d. Veränderungen im Militärrwesen*; *Deutsche Heeres-Zeitung*; *Jahrbücher f. d. deut. Armee u. Marine*; *Militär-Literaturzeitung*; *Militär-Wochenblatt*; *Streifzüge osterr. Militär-Zeitschrift*. TRADE ORGAN, &c.:—*Börsenblatt f. d. deut. Buchhandel*; *Deutsches Handelsarchiv*; *Stamper, Jahresberichte u. d. Zuckerfabrikation*; *Gewerbehalle*; *Polytechn. Notizblatt*. ARCHITECTURE, ENGINEERING, &c.:—*Allgemeine Bauzeitung*; *Der Civilingenieur*; *Dingler's polytechnisches Journal*; *Zeitschrift f. Bauwesen*; *Osterr. Zeitschrift f. Berg- u. Hüttenwesen*; *Jahrbuch der Erfindungen auf d. Gebieten der Physik u. Chemie, der Technologie, u. s. w.* RAILWAYS, TELEGRAPHY, SHIPPING, &c.:—*Hann. u. Mitteilungen aus d. Gebiete d. Seewesens*; *Elektrotechnische Zeitschrift*;

*Natürliches Jahrbuch; Der Maschinenbauer.* FORESTRY AND SPORTING:—*Fürstliche Blätter; Allg. Forst- u. Jagdzeitung; Zeitschrift f. Forst- u. Jagdwesen.* AGRICULTURE, GARDENING, &c.:—*Bienenzeitung; Forschungen auf d. Gebiete d. Agriculturnphysik; Landwirtschaftliche Jahrbücher; Allg. Zeitung für deut. Land- u. Forstwirthe; Gartenflora; Neubert's deut. Gartenmagazin; Deut. allg. Zeitung f. Landwirtschaft, u. s. v.* THEATRE:—*Neuer Theaterdiener; Münchener Theater-Journal.* FINE ARTS:—*Jahrbuch d. k. preuss. Kunstsammlungen; Die graphischen Künste; Zeitschrift f. Kunst- und Antiquitätenl. MUSIC:—Neu Berliner Musikzeitung; Neue Zeitschrift f. Musik.* FICTION:—*Deut. Romanezeitung.* STENOGRAPHY:—*Jahrbuch d. Schule Gabelbergers; Allg. deutsche Stenografenzeitung.* POPULAR READING:—*Daheim; Die Gartenlaube; Ueber Land und Meer; Vom Fels zum Meer.* FREEMASONRY:—*Freimaurerzeitung.* HUMOROUS:—*Fliegende Blätter; Kladderadatsch.* CHESS:—*Deutsche Schachzeitung.* MISCELL. ILLUSTRATED:—*Illustrirte Zeitung.*

There were in Austria in 1848 22 literary and 41 special periodicals, and in 1873 110 literary and 418 special periodicals (see the extremely valuable statistical inquiry of Dr Johann Winckler, *Die period. Press Oesterreichs*, 1875). Germany possessed in 1848 about 947 periodicals (*Deutscher Zeitungs-Katalog*, 1848), and in 1884 1550 (*Gracklauer's Deutscher Journal-Katalog für 1884*). According to the *Deutscher Zeitschriften-Katalog*, 1874, there were published in Austria, Germany, and Switzerland in 1874 2219 periodicals in the German language.

*Authorities.*—For the general history of the subject consult G. Juncos, *Schöpfung des epikurischen Realismus*, Leipzig, 1899; H. Kurz, *Geschichte der deutschen Literatur*, Leipzig, 1885; R. Fritz, *Geschichte des deutschen Journalismus*, vol. I., 1845—unfortunately it does not go beyond 1718; H. Wutke, *Die deutschen Zeitschriften*, 1875; and F. E. Richter, *Vorlesungen der Periodika im Besitze der k. Hof. Bibl. zu Dresden*, 1880.

*Switzerland.*—The *Nova Litteraria Helvetica* (1708-15) of Zurich is the earliest literary periodical which Switzerland can show. From 1728 to 1784 a *Bibliothèque Italique*, and towards the end of the century the *Bibliothèque Britannique* (1796-1815), dealing with agriculture, literature, and science, in three separate series, were published at Geneva. The latter was followed by what still remains the leading periodical of French-speaking Switzerland, the *Bibliothèque Universelle* (1816), which also has a scientific and a literary series. The *Revue Suisse* (1838) was produced at Neuchâtel.

*Italy.*—Prompted by M. A. Ricci, Francesco Nazzari, the future cardinal, established in 1688 the *Giornale de' Letterati* upon the plan of the *Journal des Savants*. His collaborateurs each agreed to undertake the criticism of a separate literature, while Nazzari retained the general editorship and the analysis of the French books. The journal was continued to 1675, and another series was carried on to 1769. Bacchini brought out at Parma (1688-90) and at Modena (1692-97) a periodical with a similar title. A much better known *Giornale* was that of Apostolo Zeno, founded with the help of Maffei and Muratori (1710), continued after 1718 by Pietro Zeno, and after 1728 by Mastracci and Paitoni. Another *Giornale*, to which Fabroni contributed, was published at Pisa in 1771; it has been continued almost down to our own times. The *Galleria di Minerva* was first published at Venice in 1696. One of the many merits of the antiquary Lami was his connexion with the *Novelle Letterarie* (1740-70), founded by him, and after the first two years almost entirely written by him. Its learning and impartiality gave it much authority. The *Frusta Letteraria* (1763-65) was brought out at Venice by Giuseppe Baretti under the pseudonym of Aristarco Scannabue. The next that deserve mention are the *Giornale Enciclopedico* (1806) of Naples, followed by the *Progresso delle Scienze* (1833-48) and the *Museo di Scienze e Letteratura* of the same city, and the *Giornale Arcadico* (1819) of Rome. Among the contributors to the *Poligrafo* (1811) of Milan were Monti, Perticari, and some of the first names in Italian literature. The *Biblioteca Italiana* (1816-40) was founded at Milan by the favour of the Austrian Government, and the editorship was offered to and declined by Ugo Foscolo. It rendered service to Italian literature by its opposition to the Della-Cruscan tyranny. Another Milanese serial was the *Conciliatore* (1818-20), which, although it only lived two years, will be remembered for the endeavours made by Silvio Pellico, Camillo Ugolini, and its other contributors to introduce a more dignified and courageous method of criticism. After its suppression and the falling off in interest of the *Biblioteca Italiana* the next of any merit to appear was the *Antologia*, a monthly periodical brought out at Florence in 1820 by Gino Capponi and Giampetro Vissieux, but suppressed in 1833 on account of an epigram of Tommaseo, a principal writer. Some striking papers were contributed by Giuseppe Mazzini. Naples had in 1832 *Il Progresso* of Carlo Troya, helped by Tommaseo and Contofanti, and Palermo owned the *Giornale di Statistica* (1834), suppressed eight years later. The *Archivio Storico*, consisting of reprints of documents with historical dissertations, dates from 1842, and was founded by Vissieux and Gino Capponi. The *Civiltà Cattolica* (1850) is still the organ of the Jesuits. The *Rivista Contemporanea* (1853) was founded at Turin in emulation of the *Revue des Deux Mondes*, which has been the type followed by so many Continental periodicals; it still appears. The *Politecnico*

(1839) of Milan was suppressed in 1844 and revived in 1858. The *Nuova Antologia* (1866) has already acquired a well-deserved reputation as a high-class review and magazine. Its rival, the *Rivista Europea*, is now considered the special organ of the Florentine men of letters. The *Rassegna Settimanale* was a weekly political and literary review, which after eight years of existence gave place to a daily newspaper, the *Rassegna*. The *Archivio Trentino* (1882) is the organ of "Italia Irredenta." The *Rassegna Nazionale*, conducted by the marchese Manfredi di Passano, a chief of the moderate clerical party, the *Nuova Rivista* of Turin, the *Fanfulla della Domenica*, and the *Gazzetta Letteraria* may also be mentioned. During the last few years Italy has been showing such vigour in her periodical literature that it may be worth while to append the titles of the chief of those which are now appearing: *Annali di Matematica* (1867); *Anuario di Giurisprudenza* (1883); *Archivio di Statistica* (1876); *Archivio storico Lombardo* (1874); *Archivio Veneto* (1871); *Archivio per lo Studio della Tradizioni popolari*; *Archivio per la Zoologia*; *Il Bibliofilo*; *Bollettino di Archeologia cristiana*; *Il Filangieri* (1870); *La Natura* (1884); *Nuovo Giornale botanico* (1869); *Giornale degli Eruditi* (1883); *Giornale di Filologia Romana*; *Giornale storico della Letteratura Italiana* (1883); *Nuova Rivista internazionale* (1879); *Il Politecnico* (1853); *La Rassegna Italiana* (1881); *Rivista storica Italiana* (1884); *Revue Internationale* (1883).

Not counting political newspapers, there were published in Italy in the year 1871 133 literary periodicals, 43 devoted to the fine arts, 192 commercial, 49 scientific, 19 administrative, 20 humorous, &c. amounting to a total of 416. Ten years later, in 1881, the number had increased to 892, of which 46 were religious, 23 administrative, 114 scientific, 52 agricultural, 36 humorous, &c.

*Authorities.*—See G. Ottino, *La Stampa periodica in Italia*, Milan, 1875; *Bocconi dei periodici presentati all'Esposizione in Milano, 1881*; A. Roux, *La Littérature contemporaine en Italie* (1873-83), Paris, 1883.

*Belgium.*—The *Journal Encyclopédique* (1756-93), founded by P. Rousseau, made Liège a propagandist centre for the philosophical party. In the same city was also first established *L'Esprit des Journaux* (1779-1816), styled by Sainte-Beuve "cette considérable et excellente collection," but "journal veuleur et complaisant." The *Journal historique et littéraire* (1783-90) was founded at Luxembourg by the Jesuit De Feller; having been suppressed there, it was transferred to Liège, and subsequently to Maastricht. It is one of the most curious of the Belgian periodicals of the 18th century, and contains most precious materials for the national history. A complete set is very rare and much sought after. The *Revue Belge* (1835-43), in spite of the support of the best writers of the kingdom, its successor the *Revue de Liège* (1844-47), the *Tresor National* (1842-48), published at Brussels, and the *Revue de Belgique* (1846-51) were all shortlived. The *Revue de Bruxelles* (1837-48), supported by the nobility and the clergy, had a longer career. The *Revue Nationale* was the champion of Liberalism, and came to an end in 1847. The *Messenger des Sciences historiques* (1833), which still comes out at Ghent, has been much more successful, and is in repute on account of its historical and antiquarian character. The *Revue Catholique* is also still published by the professors of the university of Louvain. In 1846 it began a controversy with the *Journal historique et littéraire* of Kersten (1834) upon the origin of human knowledge, which lasted for many years and excited great attention. The *Revue Trimestrielle* was founded at Brussels by Van Bommel in 1854. The *Athenaeum Belge* (1868) did not last long.

Among Flemish serials may be mentioned the *Nederlandsche Letteroefeningen* (1834); the *Belgiëch Museum* (1836-46), edited by Willems; the *Broederhand*, which did not appear after 1846; the *Taalverbond* of Antwerp; the *Kunst- en Letterblad* (1840-43); and the *Vlaemsche Rederyker* (1844).

The *Annales des Travaux Publics* (1843), the *Bulletin de l'Industrie* (1842), the *Journal des Beaux-Arts* (1858), the *Catholic Précis Historiques* (1853), the *Protestant Chrétien Belge* (1850), Van Beneden's *Archives de Biologie*, the *Revue de Belgique* (1866), and the *Revue de Droit international* are representative of their several respective classes.

It has been calculated that in 1860 there were 51 periodicals published in Belgium. In 1884 the number had increased to 412. See U. Capitaine, *Recherches sur les journaux et les écrits périodiques Littéraires, 1850; Relevé de tous les écrits périodiques qui se publient dans le royaume de Belgique, 1875; Catalogue des journaux, revues et publications périodiques de Belgique, 1888; Annuaire de la Librairie Belge, 1884.*

*Holland.*—This country occupies a distinguished position in the history of the periodical literature of the 18th century, from the labours of the French refugees already referred to (see p. 539). The first serial written in Dutch was the *Beekmaas van Europa* (1692-1708, and 1715-48), which had several changes of name during its long life. The next of any note was the *Republiek der Geleerden* (1710-48). The English *Spectator* was imitated by J. van Elken in his *Misanthropie* (1711-12), written in French, and in the *Hollandische Spectator* (1781-36), in Dutch. An important serial was the long-lived *Vaderlandsche Letteroefeningen* (1761). The *Algemeene Kunst- en Letterbode* (1788) was long the leading review of Holland; in



1860 it was joined to the *Nederlandsch Spectator* (1855). Of those founded in the present century may be mentioned the *Recessant* (1803) and *Nieuwe Reccensant*; the *Nederlandsch Museum* (1835); and the *Gids* (1837); the *Tijdsroom* (1857); the *Tijdspiegel*, a literary journal of Protestant tendency; the *Theologisch Tijdschrift* (1867), the organ of the Leyden school of theology; and the *Dietsche Warande*, a Roman Catholic review devoted to the national antiquity. Colonial interests have been cared for by the *Tijdschrift voor Nederlandsch Indië* (1848). The *Nederlandsch Magazin* and *Minerva* are still published.

*Es Alphabetsche Naamlijst van Boeken* (1790-1875), Amsterdam, 1835-78.  
*Scandinavia*.—Early in the 18th century Denmark had the *Nye Tidender* (1720), continued down to 1836 under the name of *Dansk-litteraturlidende*. The *Minerva* (1785) of Rahbek was carried on to 1819, and the *Skandinaviske Museum* (1798-1803) was revived by the *Litteratur-Selskabs Skrifter* (1805). These were followed by the *Lærdes Efterretninger* (1799-1810), afterwards styled *Litteratur-Tidende* (1811-36), the *Athens* (1818-17), and *Historisk Tidsskrift* (1840). In more modern times appeared *Tidskrift for Litteratur og Kritik* (1832-42, 1843); *Maanedskrift for Litteratur* (1829-38); *Nord og Syd* (1848-49) of Goldschmidt, succeeded by *Uda og Hjemme*, still published; and the *Dansk Maanedskrift* (1858) of Stoenstrup, with signed historical and literary articles. One of the most noteworthy Scandinavian periodicals has been the *Nordisk Universitets Tidsskrift* (1854-64), a bond of union between the universities of Christiania, Upsala, Lund, and Copenhagen.

See *Revue des Deux Mondes*, 1st August 1861.  
 Iceland has had the *Islensk Sagablad* (1817-26), *Skrisar* (1827), still published, *Ný Fylgjar* (1841-73), and *Gefn* (1870-73).

See T. Mobbis, *Cent. 11th. Island. et Norvegiarum*, Leipzig, 1856-60.

The first trace of the serial form of publication to be found in Norway is in the *Ugenlige korte Afsendinger* (1760-61), "Weekly Short Treatises," of Bishop Fr. Nannestad, consisting of moral and theological essays. The *Maanedslige Afsendinger* (1762), "Monthly Treatises," was supported by several writers and devoted chiefly to rural economy. These two were followed by *Politisk og Historisk* (1807-10); *Saga* (1816-20), a quarterly review edited by J. S. Munch; *Den Norske Tilvæser* (1817-21), a miscellany brought out at Bergen; *Hermoder* (1821-27), a weekly æsthetic journal; *Jæna*, (1822-23), of the same kind but of less value; *Vidar* (1832-34), a weekly scientific and literary review; *Nor* (1840-46), of the same type; *Norsk Tidsskrift for Videnskab og Litteratur* (1847-55); *Illustreret Nyhedsblad* (1851-66), "Illustrated News"; *Norsk Maanedskrift* (1856-60), "Monthly Review for Norway," devoted to literature and philology; and *Norden* (1866), a literary and scientific review. Popular serials date from the *Skilling Magazin* (1835), which first introduced wood-engraving, and is still published. The *Norsk Familjeblad* is a current weekly of the same class.

See P. Boten-Hansen, *La Norvège Littéraire*, Christiania, 1868; *Norsk Bog-Fortegnelse* (1814-72).

The *Svenska Argus* (1733-34) of Olof Dalin is the first contribution of Sweden to this subject. The next were the *Tidningar om den Lärads Arbeten* (1742) and the *Lärda Tidningar*. The patriotic journalist C. C. Gjörvell established about twenty literary periodicals, of which the most important was the *Svenska Mercurius* (1755-89). Atterbom and some fellow-students founded about 1810 a society for the deliverance of the country from French pedantry, which with this end carried on a periodical entitled *Phosphoros* (1810-18), to propagate the opinions of Schlegel and Schelling. The *Svensk Litteratur-Tidning* (1818-25) of Palmblad and the *Polyfem* (1810-12) had the same objects. Among more recent periodicals we may mention *Skandia* (1833-37); *Literaturbladet* (1838-40); *Ställningar och Förhållanden* (1838) of Crusenstolpe, a monthly review of Scandinavian history; *Tidskrift för Litteratur* (1850); *Norsk Tidsskrift* (1852), weekly, still published; *Förr och Nu*; and the *Revue Suédoise* (1858) of Kramer, written in French. The *Ny illustrerad Tidning* and *Hemvännen* are current illustrated weeklies; the *Svenska Veckoblad* is also weekly.

See *Revue des Deux Mondes*, 1st August 1861.

*Spain and Portugal*.—Spain owes her intellectual emancipation to the monk Benito Feijóo, who in 1726 produced a volume of dissertations somewhat after the fashion of the *Spectator*, but on graver subjects, entitled *Teatro Critico*, which was continued down to 1739. His *Cartas Eruditas* (1742-60) were also issued periodically. The earliest critical serial, the *Diario de los Literatos* (1737-42), kept up at the expense of Philip V., did not long survive court favour. Other periodicals which appeared in the 18th century were Mañer's *Mercurio* (1738); the *Diario Noticioso* (1758-81); *El Pensador* (1762-67) of Joseph Clavijo y Fajardo; *El Beltanico Literario* (1765), satirical in character; the *Semanario Erudito* (1778-91), a clumsy collection of documents; *El Correo Literario de la Europa* (1781-82); *El Censor* (1781); the valuable *Memorial Literario* (1784-1808); *El Correo Literario* (1786-91), devoted to literature and science; and the special organs *El Correo Mercantil* (1792-98) and *El Semanario de Agricultura* (1797-1805). In the present century we have *Variedades de Ciencias, Literatura, y Artes* (1803-5), among whose contributors have been the distinguished names of Quintana, Moratin, and Antillon; *Miscelánea de*

*Comercio* (1819); and *Diario general de las Ciencias Médicas*. The Spanish refugees in London published *Ocios de Españoles Refugiados* (1823-26) and *Miscelánea hispano-americana* (1824-28), and at Paris *Miscelánea escocia americana* (1826). The *Crónica científica y literaria* (1817-20) was afterwards transformed into a daily newspaper. Subsequently to the extinction of *El Censor* (1820-23) there was nothing of any value until the *Cartas Españolas* (1832), since known as the *Revista Española* (1832-36) and as the *Revista de Madrid* (1838). Upon the death of Ferdinand VII. periodicals had a new opening; in 1836 there were published sixteen journals devoted to science and art. The fashion of illustrated serials was introduced in the *Semanario pitagorico Español* (1836-57), noticeable for its biographies and descriptions of Spanish monuments. *El Panorama* (1839-41) was another literary periodical with engravings. Of more recent date have been the *Revista Ibérica* (1861-68), conducted by Sans del Río; *La America* (1857-70), specially devoted to American subjects and edited by the brothers Asquerino; and the *Revista de Cataluña*, published at Barcelona. The chief of those published at the present time are the *Revista de España*, the *Revista Contemporánea*, the *Revista Europea*, and the *Revista de Archivos*.

Apart from newspapers, there were issued at Madrid in 1867 47 periodicals, of which 10 were religious, 32 literary, 17 official, 7 satirical, &c. In 1882 the number of periodicals issued in Spain was 377—24 legal, 24 agricultural, 35 commercial, 15 army and navy, 14 theatrical, 45 illustrated, 36 literature and science, 52 medical, 11 fashions, 51 education, 44 religion, 26 miscellaneous.

See G. Ticknor, *History of Spanish Literature*, New York, 1875; G. Hubbard, *Histoire de la littérature contemporaine en Espagne*, Paris, 1876; E. Hartzenbusch, *Periodicos de Madrid*, 1876; Laeyre, *Catalogo-tarifa de los periodicos, revistas, y ilustraciones en España*, 1882.

Portugal could long boast of only one review, the *Jornal Enciclopedico* (1779-1806), which had many interruptions; then came the *Jornal de Coimbra* (1812-20); the *Panorama* (1836-57), founded by Herculanio; the *Revista Universal Lisbonense* (1841-53), established by Castilho; the *Instituto* (1853) of Coimbra; the *Arquivo Pitagorico* (1857) of Lisbon; and the *Jornal da Sociedade dos Amigos das Lettras*. In 1868 a review called *Vos Feminina*, and conducted by women, was established at Lisbon.

I. F. De Silva, *Diccionario Bibl. Portuguez*, 1858.

*Greece*.—The periodical literature of modern Greece commences with 'O *Abvros Epagg*, brought out at Vienna in 1811 by Anthimos Gezi and continued to 1821. A philological serial with the same title is still published. In *Agina* the *Alvraia* appeared in 1831, edited by Mustoxidis; and at Corfu, in Greek, Italian, and English, the *Avθολογία* (1834). After the return of King Otho in 1833 a literary review called 'Ios was commenced. *Le Spectateur de l'Orient*, in French, pleaded the national cause before Europe for three years from 1855. A military journal was published at Athens in 1855, and two years later the archaeological periodical conducted by Pittakis and Rangavi. For many years *Λεβωπία* (1850-72), edited by Rangavi and Paparrigopoulos, was the leading serial. Among existing periodicals *Φόβος* deals with natural science, the *Γεωργικόν* with agriculture, and the *Ιεποποιήσιον* with theology.

See A. R. Rangabé, *Hist. littéraire de la Grèce Moderne*, Paris, 1877; B. Nicolai, *Geschichte der neuere griechischen Literatur*, 1878.

*Russia*.—The historian Müller made the first attempt to establish periodical literature in Russia in his *Uczem yestvatcheniya Sotchinieniya* (1755-64), or "Monthly Works." In 1759 Sumarokoff founded the *Trudolyubivaya Pchelá*, or "Industrious Bee," giving translations from the *Spectator*, and, for the first time, critical essays. Karamzin brought out in 1802 the *V'estnik Evropi*, an important review with Liberal tendencies, which is still appearing. The Conservative *Russkoi V'estnik* (1808) was revived at Moscow in 1856 by Katkoff, and is also published now. The romantic school was supported by *Sin Otchestva* (1812), "Son of the Fatherland," united in 1825 to the *Svernoi Arkhis* (1822), which dwindled and came to an end soon after 1839. One of the most successful Russian reviews has been the *Biblioteka d'lya Tchleniya* (1854), or "Library of Reading." The Slavophile party is represented by the *Russkaya Mysl*, "Russian Thought," published in Moscow.

Finland has had *Suomi* (1841), written in Swedish.

See C. Courrière, *Histoire de la littérature contemporaine en Russie*, Paris, 1875, and the bibliographical works of Májof.

*Slavonic Countries*.—Bohemia has had the *Cesko Muzium* (1827), founded by Palacky; *Ziva* (1853), a review of natural history; and the *Samalky Archeologika*.

Hungary can show the *Ungriaches Magazin* (1781-87, 1791), published at Pressburg, and the *Magyar Muzium* (1788). The *Tudományos gyűjtemény* (1817-41) and the *Figyelmész* (1837-43) deserve mention. *Uj Magyar Muzium* was a scientific magazine, and the *Budapesti Szemle* (1857) of a more general character.

Before the revolution of 1830 Poland had the *Pamiętnik Warszawski* of Lach Szymbra. Among other reviews may be mentioned the *Dziennik Literacki* of Leimborg, the *Biblioteka Warszawska* of Warsaw, and the *Przegląd Polski* of Cracow.

Roumania commenced with the *Magazinet istorica pentru Dacia* (1845), containing valuable historical documents, and Moldavia with *Dacia Literaria* (1840) and *Arhivea Romaneca* (1841).

The best literary review Servia has had was the *Wila*, edited by Novakovic.

See A. Bourguain, *Histoire des Littératures étrangères*, 1876, 3 vols.; D. Izson, *Bibliographia chronologica romana*, 1872.

## UNITED STATES.

Spurred by the success of the *Gentleman's Magazine* in England, Benjamin Franklin printed and published the earliest miscellany in America, under the title of the *General Magazine* (1741), at Philadelphia, which, owing to want of support, expired after six monthly numbers had appeared. Franklin's rival, John Webbe, brought out in opposition the *American Magazine* (1741), which ran only to two numbers. Further attempts at Philadelphia in 1757 and 1769 to revive periodicals with the same name were both fruitless. The other pre-revolutionary magazines were the *Boston American Magazine* (1743-47), in imitation of the *London Magazine*; the *Boston Weekly Magazine* (1748); the *Christian History* (1743-44); the *New York Independent Reflector* (1753-54); the *New England Magazine* (1758-60), a collection of fugitive pieces; the *Boston Royal American Magazine* (1774-75); and the *Pennsylvania Magazine* (1775-76), which, founded by E. Aitken, with the help of Thomas Paine, came to an untimely end upon the commencement of the war. The *Columbian Magazine* (1786-90) was continued as the *Universal Asylum* (1790-92). Matthew Carey brought out the *American Museum* in 1787, and it lasted until 1792. Five or six more magazines ran out a brief existence before the end of the century. One of the most successful of them was the *Farmer's Museum* (1793-99), supported by perhaps the most brilliant staff of writers American periodical literature had yet been able to show, and edited by Dennis, who in 1801 commenced the publication of the *Portfolio*, carried on to 1827 at Philadelphia. For five years it was a weekly miscellany in quarto, and afterwards an octavo monthly; it was the first American serial which could boast of so long an existence. The *Literary Magazine* (1803-8) was established at Philadelphia by C. B. Brown, who, with Dennis, may be considered as having been the first American professional man of letters. The Anthology Club was founded at Boston in 1803 by Phineas Adams for the cultivation of literature and the discussion of philosophy. Ticknor, Everett, and Bigelow were among the members, and were contributors to the organ of the club, the *Monthly Anthology* (1803-11), the forerunner of the *North American Review*. In the year 1810 Thomas (Printing in America, ii. 292) informs us that 27 periodicals were issued in the United States. The first serious rival of the *Portfolio* was the *Analectic Magazine* (1813-20), founded at Philadelphia by Moses Thomas, with the literary assistance of W. Irving (for some time the editor), Paulding, and the ornithologist Wilson. In spite of a large subscription list it came to an end on account of the costly style of its production. The first southern serial was the *Monthly Register* (1805) of Charleston. New York possessed no periodical worthy of the city until 1824, when the *Atlantic Magazine* appeared, which changed its name shortly afterwards to the *New York Monthly Review*, and was supported by E. O. Sands and W. C. Bryant. For many years *Grassman's Magazine* was the leading popular miscellany in the country, reaching at one time a circulation of about 85,000 copies. The first western periodical was the *Illinois Monthly Magazine* (1830-32), published, owned, edited, and almost entirely written by James Hall, who followed with his *Western Monthly Magazine* (1833-36), produced in a similar manner. In 1833 the novelist C. F. Hoffman founded at New York *The Knickerbocker* (1833-60), which soon passed under the control of Timothy Flint and became extremely successful, most of the leading native writers of the next twenty years having been contributors. Equally popular was *Putnam's Monthly Magazine* (1833-57, 1867-69). *The Dial* (1841-44), Boston, the organ of the transcendentalists, was first edited by Margaret Fuller, and subsequently by E. W. Emerson and G. Ripley. Among other extinct magazines may be mentioned the *American Monthly Magazine* (1833-38), the *Southern Literary Messenger* (1834), Richmond, the *Gentleman's Magazine* (1837-40), and the *International Magazine* (1850-52), edited by E. W. Griewold. The *Yale Literary Magazine* dates from 1836. The *Merchant's Magazine* was united in 1871 with the *Commercial and Financial Chronicle*. Foremost among existing magazines come *Harpur's Monthly Magazine* (1850) and *Scribner's Monthly* (1870), now *The Century*, both famous for their unrivalled wood-engraving and literary excellence. Within the last few years the circulation of these two periodicals has increased to a remarkable degree both at home and abroad. Not less admirable in their way are the *Atlantic Monthly* (1857), *Lippincott's Magazine*, and the *Manhattan*.

The first attempt to carry on an American review was made by Robert Walsh in 1811 at Philadelphia with the *American Review of History and Politics*, which lasted only a couple of years. Still more brief was the existence of the *General Repository and Review* (1812), brought out at Cambridge by Andrews Norton with the help of the professors of the university, but of which only four numbers appeared. Niles's *Weekly Register* (1811-48) was political, historical, and literary. The *North American Review*, the oldest and most prosperous of all the American reviews, dates from 1815,

and was founded by William Tudor, a member of the previously-mentioned Anthology Club. After two years' central Tudor headed over the review to the club, then styled the North American Club, whose most active members were E. T. Channing, R. H. Dana, and Jared Sparks. On his return from Europe in 1819 E. Everett became the editor; and his elder brother Alexander acquired the property in 1829. The roll of the contributors to this review number almost every American writer of note. Since January 1879 it has been published monthly. The *American Quarterly Review* (1827-57), established at Philadelphia by Robert Walsh, came to an end on his departure for Europe. The *Southern Review* (1828-32), conducted by H. Legaré, S. Elliott, and G. W. Simms in defence of the politics and finance of the South, enjoyed a shorter career. It was resuscitated in 1842, and lived another ten years. The two were followed by the *Democratic Review* (1833-52), the *American Review*, afterwards the *American Whig Review* (1845-52), the *Massachusetts Quarterly Review* (1847-50), and a few more. The *New Englander* (1845), the *Biblical Repository* and *Princeton Review* (1825), and the *National Quarterly Review* (1860) are still published. The critical weeklies of the past include the *New York Literary Gazette* (1834-35, 1839), *De Bow's Review* (1845), the *Literary World* (1847-73), the *Criterion* (1855-56), the *Bound Table* (1864-64), the *Citizen* (1864-73), and *Appleton's Journal* (1869). The leading weeklies of the day include the *Nation* (1865), the *Literary World* (1870), and the *Critic* (1881).

Religious periodicals have been extremely numerous in the United States during the last hundred years. The earliest was the *Theological Magazine* (1796-98). The *Christian Examiner* dates from 1824 and lasted down to 1876. The *Penologist* (1806), changed to the *Missionary Herald*, still represents the American Board of Missions. The *Methodist Magazine* dates from 1818 and the *Christian Disciple* from 1813. The *American Biblical Repository* (1831-50), a quarterly, was united with the *Andover Biblical Society* (1843) and with the *Theological Eclectic* (1845). *Brownson's Quarterly Review* began as the *Boston Quarterly Review* in 1834, and did much to introduce to American readers the works of the modern French philosophical school. Among more recent serials of this class we may notice the *Protestant Episcopal Quarterly Review* (1854), the *Presbyterian Magazine* (1851-60), the *Catholic World* (1865), the *Southern Review* (1867), the *New Jerusalem Magazine* (1827), the *American Baptist Magazine* (1817), the *Church Review* (1848), the *Christian Review* (1836), the *Universalist Quarterly* (1844). Among historical periodicals may be named the *American Register* (1806-11), *Stryker's American Register* (1848-51), *Edwards's American Quarterly Register* (1829-43), the *New England Historical and Genealogical Register* (1847), *Folsom's Historical Magazine* (1857), the *New York Genealogical Record* (1869), and the *Magazine of American History* (1877).

For many years the leading English periodicals have been regularly reprinted in the United States, and many serial publications have been almost entirely made up of extracts from English sources. Perhaps the earliest example is to be found in *Saint Fines's Literature* (1811-12). The *Eclectic Magazine* (1844) and *Littell's Living Age* (1844) are still published.

In 1817 America possessed only one scientific periodical, the *Journal of Mineralogy*. Professor Silliman established the journal known by his name in 1818. Since that time the *American Journal of Science* has enjoyed unswerving favour. Among other special periodicals of the day may be mentioned the *American Naturalist*, the *American Journal of the Medical Sciences*, the *American Journal of Speculative Philosophy*, the *American Journal of Philosophy*, the *American Railroad Journal*, the *Banker's Magazine*, the *Index Medicus*, and the *Journal of the Franklin Institute*.

The number of periodicals devoted to light literature and to female readers has been, and still remains, extremely large. The earliest in the latter class was the *Lady's Magazine* (1792) of Philadelphia. The name of the *Lowell Offering* (1841), written chiefly by factory girls, is well known in England. *Godoy's Ladies Book* is still issued. Children's magazines originated with the *Young Misses Magazine* (1806) of Brooklyn; *St Nicholas* is a modern high-class representative of this kind; and another current example is the *Child's Paper* (1852).

The following estimate of the number of periodicals now appearing in the United States is taken from G. P. Rowell and Co's *American Newspaper Record* (1885). Weeklies, and those published more frequently than once a week, are omitted on account of the difficulty of distinguishing them from newspapers. The numbers given are—bi-monthlies 47, semi-monthlies 176, monthlies 1034, bi-monthlies 13, quarterlies 59; total 1327.

See an excellent article on the subject in Ripley and Dana's *American Cyclopædia*; Orcheval Clarigny, *Histoire de la presse en Angleterre et aux États-Unis*, 1857; H. Stevens, *Catalogue of American Books in the Library of the British Museum*, 1866, and *American Books with Titles to 'em*, 1873; L. Thomas, *History of Printing in America*, Albany, 1874; J. Nichol, *American Literature* (1850-1880), 1883; Pettengill's *Newspaper Directory for 1878*; G. P. Rowell and Co's *American Newspaper Directory*, New York, 1869-83; Hubbard's *Newspaper Directory of the World*, New York, 1883-84. The leading periodicals of the United States are indexed in W. F. Foose's *Index*, Boston, 1868, and *Literary Journal*. (E. R. T.)

PERIPATETICS was the name given in antiquity to the followers of Aristotle, from their master's habit of walking up and down as he lectured conversationally to his pupils. Others derive the name from the *peripátratos*, or covered walk of the Lyceum. An account of the Aristotelian philosophy will be found in the articles ARISTOTLE, ETHICS, LOGIC, and METAPHYSIC. Here it must suffice to recall those features of the system which mainly conditioned the development of the school. Aristotle's central conception is the correlative opposition of form and matter. This may be called the supreme category under which he views the world; it is the point where, as Zeller puts it, Aristotle's system at once refutes and completes the Platonic doctrine of the "idea" in its relation to phenomena. But Aristotle did not succeed in expelling the dualism which he blamed in Plato. His deity is pure form, and dwells in abstract self-contemplation withdrawn from the actual life of the world. The development of the world remains, therefore, unrelated to the divine subject. In Aristotle's doctrine of man, precisely the same difficulty is experienced in connecting the active or passionless reason with the individual life, the latter being a process of development bound up with sense, imagination, and desire. The soul is originally defined as the entelechy of the body, and, moreover, not of body in general but of its particular body. It is impossible, therefore, from this point of view to speak of soul and body as separate entities. Yet Aristotle holds that besides the individual mind, which is all things potentially—which becomes all things—there is superinduced upon the process of development the active or creative reason, the pure actuality (*éivpyeia*) which the development presupposes as its necessary *præ*, just as the world-process presupposes God. This reason is "separable," and is said to enter "from without" when it unites itself to the process of individual life. It must therefore exist before the individual, and it alone outlasts the death of the body; to it alone properly belong the titles of "immortal" and "divine." But its relation to the universal divine reason was not handled by Aristotle at all. The question was destined to become the *crux* of his commentators. In general it is evident that, if reason in man be identified with the process of natural development (and there is Aristotelian warrant for declaring these to be simply two aspects of the same thing), we drift into a purely naturalistic or materialistic doctrine. On the other hand, the doctrine of the "active reason" may be maintained, but what Aristotle left vague may be further defined. The rational soul of each individual may be explicitly identified with the divine reason. This leads to the denial of individual immortality and the doctrine of one immortal impersonal reason, such as we find, for example, in the rationalistic pantheism of Averroes. A third position is possible, if the statements of Aristotle be left in their original vagueness. Aristotle may then be interpreted as supporting monotheism and the immortality of separate rational souls. This was the reading adopted by the orthodox scholastic Aristotelians, as well as by those early Peripatetics who contented themselves with paraphrasing their master's doctrine.

Aristotle's immediate successors, Theophrastus, who presided over the Lyceum from 322 to 288 B.C., and Eudemus of Rhodes, were distinguished by a learned diligence rather than by original speculative power. They made no innovations upon the main doctrines of their master, and their industry is chiefly directed to supplementing his works in minor particulars. Thus they amplified the Aristotelian logic by the theory of the hypothetical and disjunctive syllogism, and added to the first figure of the categorical syllogism the five moods out of which the fourth figure was afterwards constructed. The impulse towards natural science and the systematizing of empirical details which

distinguished Aristotle from Plato was shared by Theophrastus. His two works on the *History of Plants* and *Causes of Plants* prove him to have been a careful and acute observer. The same turn for detail is observable in his ethics, where, to judge from the imperfect evidence of the *Characters*, he elaborated still further Aristotle's portraiture of the virtues and their relative vices. In his doctrine of virtue the distinctive Peripatetic position regarding the importance of external goods was defended by him with emphasis against the assaults of the Stoics. He appears to have laid even more stress on this point than Aristotle himself, being doubtless led to do so, partly by the heat of controversy and partly by the importance which leisure and freedom from harassing cares naturally assumed to a man of his studious temperament. The metaphysical *dropia* of Theophrastus which have come down to us show that he was fully alive to the difficulties that start up round many of the Aristotelian definitions. But we are ignorant how he proposed to meet his own criticisms; and they do not appear to have suggested to him an actual departure from his master's doctrine, much less any radical transformation of it. In the difficulties which he raises with reference to the relation of the active and the passive reason, as well as in his ascription of the physical predicate of motion to the activity of the soul, we may perhaps detect a leaning towards a naturalistic interpretation. The tendency of Eudemus, on the other hand, is more towards the theological or Platonic side of Aristotle's philosophy. The *Eudemian Ethics* (which, with the possible exception of the three books common to this treatise and the *Nicomachean Ethics*, there need be no hesitation in ascribing to Eudemus) expressly identify Aristotle's ultimate ethical ideal of *θεωρία* with the knowledge and contemplation of God. And this supplies Eudemus with a standard for the determination of the mean by reason, which Aristotle demanded, but himself left vague. Whatever furthers us in our progress towards a knowledge of God is good; every hindrance is evil. The same spirit may be traced in the author of the chapters which appear as an appendix to book i. of Aristotle's *Metaphysics*. They have been attributed to Pasicles, the nephew of Eudemus. For the rest, Eudemus shows even less philosophical independence than Theophrastus. Among the Peripatetics of the first generation who had been personal disciples of Aristotle, the other chief names are those of Aristoxenus of Tarentum and Dicaearchus of Messene. Aristoxenus, "the musician," who had formerly belonged to the Pythagorean school, maintained the position, already combated by Plato in the *Phædo*, that the soul is to be regarded as nothing more than the harmony of the body. Dicaearchus agreed with his friend in this naturalistic rendering of the Aristotelian entelechy, and is recorded to have argued formally against the immortality of the soul.

The naturalistic tendency of the school reached its full expression in Strato of Lampascus, who succeeded Theophrastus as head of the Lyceum, and occupied that position for eighteen years (287-269 B.C.). His predilection for natural science earned for him in antiquity the title of "the physicist." He is the most independent, and was probably the ablest, of the earlier Peripatetics. His system is based upon the formal denial of a transcendent deity. Cicero attributes to him the saying that he did not require the aid of the gods in the construction of the universe; in other words, he reduced the formation of the world to the operation of natural forces. We have evidence that he did not substitute an immanent world-soul for Aristotle's extra-mundane deity; he recognized nothing beyond natural necessity. He was at issue, however, with the atomistic materialism of Democritus in regard to its twin assumption

tions of absolute atoms and infinite space. His own speculations led him rather to lay stress on the qualitative aspect of the world. The true explanation of things was to be found, according to Strato, in the forces which produced their attributes, and he followed Aristotle in deducing all phenomena from the fundamental attributes or elements of heat and cold. His psychological doctrine explained all the functions of the soul as modes of motion, and denied any separation of the reason from the faculties of sense-perception. He appealed in this connexion to the statement of Aristotle that we are unable to think without a sense-image.

The successors of Strato in the headship of the Lyceum were Lyco, Aristo of Ceos, Critolaus (who, with Carneades the Academic and Diogenes the Stoic, undertook in 155 B.C. the famous embassy to Rome, more important in its philosophical than in its political bearings), Diodorus of Tyre, and Erymneus, who brings the philosophic succession down to about the year 100 B.C. Other Peripatetics belonging to this period are Hieronymus of Rhodes, Prytanis, and Phormio, the *delirius senex* who attempted to instruct Hannibal in the art of war. Sotion, Hermippus, and Satyrus were historians rather than philosophers. Heraclides Lembus, Agatharchides, and Antisthenes of Rhodes are names to us and nothing more. The philosophic unfruitfulness of the school during this whole period is expressly charged against it by Strabo, who explains it by his well-known story of the disappearance of Aristotle's writings after the death of Theophrastus. But it is impossible that this story should be true in the shape in which it is told by Strabo; and a sufficient explanation of the barrenness of the school may be found in the general circumstances of the time. From the outset the characteristic of the Aristotelian philosophy had been its disinterested scientific character; but the age was one for which speculation as such had lost its attractiveness. At such a time it was natural, therefore, that the Peripatetic school should suffer more than the others. It had also in practical matters taken up a mediating position, so that it lacked the attractions which, in the case of extreme views, enlist supporters and inspire them with propagandist zeal. The fact, at all events, is not to be denied that, after Strato, the Peripatetic school has no thinker of any note to show for about 200 years. With Strato, moreover, the scientific activity of the school has an end; when it received a new infusion of life its activity took another direction. Strato accuses the Peripatetics of this period of devoting themselves to the tricking out of commonplaces. This seems in great measure true of those who still occupied themselves with philosophy; they cultivated ethics and rhetoric, and were noted for the elegance of their style. But the majority followed the current of the time, and gave themselves up to the historical, philological, and grammatical studies which mark the Alexandrian age.

Early in the 1st century B.C. all the philosophic schools began to be invaded by a spirit of eclecticism. This was partly the natural result of the decay of speculative interest and partly due to the unconscious influence of Rome upon the philosophers. The Roman mind measured philosophy, like other things, by the standard of practical utility. As an instrument of education, and especially as the inculcator of moral principles, the Roman welcomed and appreciated philosophy; but his general point of view was naively put by the proconsul Gallius (about 70 B.C.), who proposed to the representatives of the schools in Athens that they should settle their differences amicably, at the same time offering his personal services as mediator. Though the well-meant proposal was not accepted, this atmosphere of indifference imperceptibly influenced the attitude of the

contending schools to one another. Thus Boethus the Stoic deserted the pantheism of his school and assigned the deity, as Aristotle had done, to the highest sphere. He likewise embraced the Peripatetic doctrine of the eternity of the world. A similar approximation to Peripateticism is seen in Panætius. About the same time, Antiochus of Ascalon, founder of the so-called fifth Academy, tried to combine Plato, Aristotle, and Zeno, asserting that they differed only in words. Meanwhile the Peripatetic school may be said to have taken a new departure and a new lease of life. The impulse was due to Andronicus of Rhodes, the well-known editor of Aristotle's works, who presided over the Lyceum towards the middle of the 1st century B.C. His critical edition indicated to the later Peripatetics the direction in which they could profitably work, and the school devoted itself henceforth almost exclusively to the writing of commentaries on Aristotle. Boethus of Sidon and Aristo of Alexandria carried on the work of interpretation begun by Andronicus. Boethus appears, like many of his predecessors, to have taken the naturalistic view of Aristotle's doctrines, and even in some respects to have approximated to the Stoic materialism. Staseas, Cratippus, and Nicolaus of Damascus need only be named as belonging to this century. The most interesting Peripatetic work of the period is the treatise *De Mundo*, which has come down to us under Aristotle's name, but which internal evidence obliges us to assign to a date later than the writings of the Stoic Posidonius. The interest of the treatise lies in the evidence it affords within the Peripatetic school of the eclectic tendency which was then in the air. The admixture of Stoic elements is so great that some critics have attributed the work to a Stoic author; but the writer's Peripateticism seems to be the more fundamental constituent of his doctrine.

Our knowledge of the Peripatetic school during the first two centuries of the Christian era is very fragmentary; but those of its representatives of whom anything is known confined themselves entirely to commenting upon the different treatises of Aristotle. Thus Alexander of *Ege*, the teacher of Nero, commented on the *Categories* and the *De Caelo*. In the 2d century Aspasius and Adrastus wrote numerous commentaries. The latter also treated of the order of the Aristotelian writings in a separate work. Somewhat later, Herminius, Achaicus, and Sosigenes commented on the logical treatises. Aristocles of Messena, the teacher of Alexander of Aphrodisias, was the author of a complete critical history of Greek philosophy. This second phase of the activity of the school closes with the comprehensive labours of Alexander of Aphrodisias, the exegete *par excellence*, called sometimes the second Aristotle. He became head of the Lyceum during the reign of Septimius Severus, some time between 198 and 211 A.D. Alexander's interpretation proceeds throughout upon the naturalistic lines which have already become familiar to us. Aristotle had maintained that the individual alone is real, and had nevertheless asserted that the universal is the proper object of knowledge. Alexander seeks consistency by holding to the first position alone. The individual is prior to the universal, he says, not only "for us," but also in itself, and universals are abstractions which have merely a subjective existence in the intelligence which abstracts them. Even the deity must be brought under the conception of individual substance. Such an interpretation enables us to understand how it was possible, at a later date, for Aristotle to be regarded as the father of Nominalism. Form, Alexander proceeds, is everywhere indivisible from matter. Hence the soul is inseparable from the body whose soul or form it is. Reason or intellect is bound up with the other faculties. It exists primarily in man only as a disposition or capacity—*νοῦς ὑλικός καὶ φωνικός*—and

is afterwards developed into actual intelligence—*voûs êπίκτητος*—the *intellectus acquisitivus* of the Scholastica. The active reason—*voûs ποιητικός*—which effects this development is, according to Alexander, no part of the soul, but simply the divine reason acting upon it. The influence of God upon nature is elsewhere reduced by Alexander, as far as possible, to a mechanical process. Aristotle's ethico-mystical conception of God as the ultimate and transcendent object of desire is set aside; and the influence of the deity is represented simply as a diffusion of force, first into the heavens and thence downwards, each lower element receiving less according to its greater distance from the source. The commentaries of the Aphrodisian formed the foundation of the Arabian and Scholastic study of Aristotle. Soon after Alexander's death the Peripatetic school was merged, like all others, in the Neoplatonic. Neoplatonists like Porphyry, Iamblichus, Themistius, Dexippus, Syrianus, Ammonius, Simplicius, and Philoponus carried on the work of commenting on Aristotle till the final disappearance of Greek philosophy. For the further history of Aristotelianism, see ARABIAN PHILOSOPHY and SCHOLASTICISM.

The authorities on whom we depend for our knowledge of the Peripatetics are collected and sifted with exhaustive care by Zeller in the relative sections of his *Philosophie der Griechen* (ii. 2 and iii. 1). (A. SE.)

PERIPATUS. See MYRIAPODA, vol. xvii. p. 116.

PERITONITIS, inflammation of the peritoneum or membrane investing the abdominal and pelvic cavities and their contained viscera. It may exist in an acute or a chronic form, and may be either localized in one part or generally diffused.

*Acute peritonitis* may attack persons of both sexes and of any age. It is sometimes brought on, like other inflammations, by exposure to cold, but it would appear to arise quite as frequently in connexion with some antecedent injury or disease in some of the abdominal organs, or with depraved conditions of the general health. It is an occasional result of hernia and obstructions of the bowels, of wounds penetrating into the abdomen, of the perforation of viscera by disease (e.g., in ulcer of the stomach and in typhoid fever), of the bursting of abscesses or cysts into the abdominal cavity, and also of the extension of inflammatory action from some of the abdominal or pelvic organs. Not unfrequently it is at first localized, and then, spreading onwards, becomes general.

The changes which take place in the peritoneum are similar to those undergone by other serous membranes when inflamed, viz., (1) congestion; (2) exudation of lymph in greater or less abundance, at first greyish in colour and soft, thereafter yellow and becoming tough in consistence, causing the folds of intestine to adhere together; (3) effusion of fluid, either clear, turbid, bloody, or purulent; (4) absorption more or less complete of the fluid and lymph. Occasionally shreds or bands of unabsorbed lymph remain, constituting a subsequent danger of strangulation of the bowel. The symptoms usually begin by a rigor, together with vomiting and pain in the abdomen of a peculiarly severe and sickening character, accompanied with extreme tenderness, so that the slightest pressure causes a great aggravation of suffering. The patient lies on the back with the knees drawn up, and it will be noticed that the breathing is rapid and shallow and performed by movements of the chest only, the abdominal muscles remaining quiescent, unlike what takes place in healthy respiration. The abdomen becomes swollen by flatulent distension of the intestines, which increases the patient's distress. There is usually constipation. The skin is hot, although there may be perspiration; the pulse is small, hard, and wiry; the urine is scanty and high-coloured, and passed with pain. The patient's aspect is

one of anxiety and suffering. These symptoms may subside in a day or two, but if they do not the case is apt to go on rapidly to a fatal termination. In such an event the pain and tenderness subside, the abdomen becomes more distended, hiccough and vomiting of brown or blood-coloured matter occur, the temperature falls, the face becomes pinched, cold, and clammy, the pulse exceedingly rapid and feeble, and death takes place from collapse, the patient's mental faculties generally remaining clear till the close. When the peritonitis is due to perforation, as may happen in the case of the gastric ulcer, or the ulcers of typhoid fever, the above-mentioned symptoms and the fatal collapse may all take place in from twelve to twenty-four hours. Further, the puerperal form of this disease, which comes on within a day or two after parturition, is always very serious and is often rapidly fatal. The symptoms are similar to those already described, but in addition there are generally superadded those of septicæmia (blood-poisoning).

*Chronic peritonitis* occurs in two forms—(1) as a result of the acute attack; (2) as a tubercular disease. In the former case, the acute symptoms having subsided, abdominal pain to some extent continues, and along with this there is considerable swelling of the abdomen, corresponding to a thickening of the peritoneum, and it may be also to fluid in the peritoneal cavity. Occasionally a condition of this kind appears to develop slowly without there having been any preceding acute attack. In this form of peritonitis there is considerable constitutional disturbance, together with loss of strength and flesh; nevertheless, although the disease is essentially a chronic one, it is often recovered from. The tubercular form of peritonitis occurs either alone or associated with tuberculous disease of the lungs or other organs. The chief symptoms are abdominal pain and distension, along with disturbance of the functions of the bowels, there being either constipation or diarrhoea, or each alternately. Along with these local manifestations there exist the usual phenomena of tuberculous disease, viz., high fever, with rapid emaciation and loss of strength. Cases of this kind are of grave import, and their tendency is to a fatal termination.

In the treatment of acute peritonitis the remedy upon which most reliance is to be placed is opium, which affords relief to the pain, and appears to exercise a certain controlling influence upon the inflammatory process. It requires to be given in considerable quantity, yet with due care, so as to avoid its narcotic action. The old plan of covering the abdomen with leeches is now seldom resorted to; nevertheless a moderate abstraction of blood by this means in a previously healthy person may contribute to the relief of the pain. Hot fomentations with turpentine or opium applied over the abdomen are of value. The strength must be maintained by milk, soups, and other light forms of nourishment. It is not in general desirable that the bowels should act, and this is one of the benefits obtained by the internal administration of opium. In the simple chronic form the use of iodine externally and of tonics with cod-liver oil internally will be found of service; while in the tubercular form remedies are as a rule of little value, but such symptoms as pain, fever, diarrhoea, &c., must be dealt with by palliative measures appropriate to these conditions.

PERIZONIUS, JACOB (1651-1715), classical scholar, the most distinguished member of a learned Dutch family of that name (Voorbroek in the vernacular), was the eldest son of Anton Perizonius, author of a once well-known treatise, *De ratione studii theologici*, and was born at Dam in Groningen on 26th October 1651. He received his school education at Dam and Deventer, and afterwards studied in the university of Utrecht, where he came under the influence of Grævius and abandoned theology for pure literature. The death of his father and other untoward circumstances involved him in a struggle with various outward difficulties, but the influence of Heinsius and Grævius, who already appreciated him highly, and expected great things from him, ultimately procured for

him in 1682 the appointment to the chair of eloquence and history at Franeker, where his expositions of Cicero, Terence, Florus, and Suetonius, as well as his lectures on general history, attracted a large and increasing number of hearers. In 1693 he was promoted to the corresponding chair at Leyden, where he succeeded F. Spanheim in 1701. His death took place in that city on 6th April 1715.

The works of Perizonius both as an author and as an editor were very numerous, and by universal consent entitle him to a place of the highest rank among the scholars of his age. Special interest attaches to his edition of the *Minerva* of Sanctius or Sanchez (1st ed. 1687, 4th ed. 1714), which may be said to be one of the last developments of the study of Latin grammar while in its prescientific stage, when the phenomena of language had not yet ceased to be regarded as for the most part disconnected, conventional, or fortuitous. Mention must also be made of his *Animadvertiones Historice, in quibus quam plurima in praelectis Romanorum rerum ac utriusque linguae auctoribus notantur, multa etiam illustrantur atque emendantur, varia denique antiquorum rituum eruntur et uberior explicantur* (1685), a work which Bayle has characterized as deserving to be entitled "The *Errata* of scholars and critics," and of his *Dissertationes duas de Republica Romana*, alluded to with honour by Niebuhr in the preface to his *Roman History* (4th ed., 1833) as marking the beginning of that new era of classical study with which his own name is so closely associated.

PERJURY is an assertion upon an oath duly administered in a judicial proceeding, before a competent court, of the truth of some matter of fact, material to the question depending in that proceeding, which assertion the assessor does not believe to be true when he makes it, or on which he knows himself to be ignorant (Stephen, *Digest of the Criminal Law*, Art. 135). In the early stages of legal history perjury seems to have been regarded rather as a sin than as a crime, and so subject only to supernatural penalties. The injury caused by a false oath was supposed to be done not so much to society as to the Divine Being in whose name the oath was taken (see OATH). One of the practical effects of this view was to make perjury so common in the Middle Ages that the probable reason for preserving trial by combat was the difficulty of securing a just case against the perjury of witnesses (Hallam, *Middle Ages*, ch. ix. pt. 1). The almost universal existence of compurgation was no doubt another explanation of the frequency of perjury. In cases of compurgation, or in cases where wager of law was allowed, it is difficult to imagine that the defence could as a rule have been an honest one. In Roman law, even in the time of the empire, the perjurer fell simply under divine reprobation, and was not dealt with as a criminal, except where he had been bribed to withhold true or give false evidence, or where the oath was by the genius of the emperor. In the latter case punishment was no doubt inflicted more for the insult to the emperor than for the perjury. False testimony leading to the conviction of a person for a crime punishable with death constituted the offence of homicide rather than of perjury. In England, perjury, as being a sin, was originally a matter of ecclesiastical cognizance. At a later period, when it had become a crime, the jurisdiction of the spiritual courts became gradually confined to such perjury as was committed in ecclesiastical proceedings, and did not extend to perjury committed in a temporal court. The only perjury which was for a long time noticed at common law was the perjury of jurors. Attain of jurors (who were originally rather in the position of witnesses than of judges of fact) incidentally subjected them to punishment for perjury. Criminal jurisdiction over perjury by persons other than jurors seems to have been first assumed by the Star Chamber, acting under the powers supposed to have been conferred by 3 Hen. VII. ch. 1. After the abolition of the Star Chamber by the Long Parliament in 1641 and the gradual diminution of the authority of the spiritual courts, perjury (whether in the strict sense of the word or the taking of a false oath in non-judicial

proceedings) practically fell entirely within the jurisdiction of the ordinary criminal tribunals. The jurisdiction of the spiritual courts over perjury may now be considered obsolete. An unsuccessful attempt was made as lately as 1876 to induce the Court of Arches to entertain a criminal suit against a layman for a false oath taken before a surrogate (*Phillimore v. Machon*, *Law Rep.*, 1 Prob. Div., 481). See further, for the history of the law of perjury, Stephen, *History of the Criminal Law*, vol. ii. p. 408; vol. iii. p. 240. At common law only a false oath in judicial proceedings is perjury. But by statute the penalties of perjury have been extended to extra-judicial matters, e.g., false declarations made for the purpose of procuring marriage (19 and 20 Vict. c. 119, s. 18), and false affidavits under the Bills of Sale Act, 1878 (41 and 42 Vict. c. 31, s. 17). False affirmation by a person permitted by law to affirm is perjury (32 and 33 Vict. c. 68, s. 4; 33 and 34 Vict. c. 49). In order to support an indictment for perjury the prosecution must prove the authority to administer the oath, the occasion of administering it, the taking of the oath, the substance of the oath, the materiality of the matter sworn, the falsity of the matter sworn, and the corrupt intention of the defendant. The indictment must allege that the perjury was wilful and corrupt, and must set out the false statement or statements on which perjury is assigned, subject to the provisions of 23 Geo. II. c. 11 (which also applies to subornation of perjury). By that Act it is sufficient to set out the substance of the offence, without setting forth the bill, answer, &c., or any part of the record, and without setting forth the commission or authority of the court before whom the perjury was committed. The matter sworn to must be one of fact and not of mere belief or opinion. It is not homicide, as in Roman law, to procure the death of another by false evidence, but the Criminal Code, ss. 118, 164, proposes to make such an offence a substantive crime of greater gravity than ordinary perjury, and punishable by penal servitude for life. It is a rule of evidence, founded upon obvious reasons, that the testimony of a single witness is insufficient to convict on a charge of perjury. There must be corroboration of his evidence in some material particular. Perjury is a common law misdemeanour, not triable at quarter-sessions. Proceedings may also be taken under 5 Eliz. c. 9, but this Act is of little practical importance, as the common law is more extensive than the statute. Most persons in a judicial position have the right of directing the prosecution of any witness, if it appears to them that he has been guilty of perjury (14 and 15 Vict. c. 100, s. 19). The provisions of the Vexatious Indictments Act (23 and 25 Vict. c. 17) extend to perjury and subornation of perjury. By that Act no indictment for either of such offences can be preferred unless the prosecutor or accused is bound by recognition, or the accused is in custody, or the consent of a judge is obtained, or (in the case of perjury) a prosecution is directed under 14 and 15 Vict. c. 100.

Subornation of perjury is procuring a person to commit a perjury which he actually commits in consequence of such procurement. If the person attempted to be suborned do not take the oath, the person inciting him, though not guilty of subornation, is liable to fine and corporal punishment. Perjury and subornation of perjury are punishable at common law with fine and imprisonment. By the combined operation of 2 Geo. II. c. 25 and later statutes, the punishment at present appears to be penal servitude for any term, or imprisonment with or without hard labour for a term not exceeding seven years (see Stephen, *Digest*, Art. 137). Perjury or prevarication committed before a committee of either House of Parliament may be dealt with as a contempt or breach of privilege as well as by prosecution. As to false oaths not perjury, it is a



misemeanor at common law, punishable by fine and imprisonment, to swear falsely before any person authorized to administer an oath upon a matter of common concern, under such circumstances that the false swearing, if committed in judicial proceedings, would have amounted to perjury. There are some cases of making false declarations which are punishable on summary conviction, *e.g.*, certain declarations under the Registration of Births and Deaths Act, 1874, and the Customs Consolidation Act, 1876. A conviction for perjury subjects the person convicted to certain disqualifications. He cannot hold a parish office (4 and 5 Will. IV. c. 76, s. 48). If a solicitor, and he attempt to practise after conviction, he is liable on summary conviction by a judge to seven years' penal servitude (12 Geo. I. c. 29, s. 4). If the prosecution be under the statute of Elizabeth, the person convicted is disabled from giving evidence for the future (5 Eliz. c. 9, s. 2). The provisions of the last two Acts may, however, be regarded as virtually obsolete. The perjury of a witness may be a ground for pardon where the perjury has taken place in a criminal trial in which accused was convicted, or for a new trial in a civil action. In order to procure a pardon or a new trial it is generally necessary to show that the witness was a material one, and also that the perjurer has been prosecuted to conviction.

In Scotland the law, as a general rule, agrees with that of England. Perjury may be committed by a party on reference to oath as well as by a witness. A witness making a false affirmation is guilty of perjury (28 Vict. c. 9). The Acts 14 and 15 Vict. c. 100 and 23 and 24 Vict. c. 17 do not extend to Scotland. The trial, though usually by the Court of Justiciary, may be by the Court of Session if the perjury is committed in the course of an action before that court. The punishment is penal servitude or imprisonment at the discretion of the court. Formerly a person convicted of perjury was disabled from giving evidence in future; this disability was abolished by 15 Vict. c. 27, s. 1.

In the United States the common law has been extended by most States to embrace false affirmations and false evidence in proceedings not judicial. Perjury in the United States courts is dealt with by an Act of Congress of 8d March 1825, by which the maximum punishment for perjury or subornation of perjury is a fine of \$2000 or imprisonment for five years. The jurisdiction of the States to punish perjury committed in the State courts is specially preserved by the same Act. Statutory provisions founded upon 28 Geo. II. c. 11 have been adopted in some States, but not in others. In the States which have not adopted such provisions, the indictment must set out the offence with the particularity necessary at common law. (J. Wt.)

**PERKINS, JACOB** (1766-1849), inventor and physicist, was born at Newburyport, Massachusetts, in 1766, and apprenticed to a goldsmith. He soon made himself known by a variety of useful mechanical inventions, and in 1818 came over to England with a plan for engraving bank-notes on steel, which, though it did not find acceptance at once, ultimately proved a signal success, and was carried out by Perkins in partnership with the English engraver Heath during the rest of his long business life. Perkins continued to be fertile of inventions, and his steam-gun, exhibited in 1824, attracted much attention, though the danger attending the use of highly-compressed steam prevented its practical adoption. His chief contribution to physics lay in the experiments by which he proved the compressibility of water and measured it by a piezometer of his own invention; see vol. vii. p. 801, and *Phil. Trans.*, 1820, 1826. He retired in 1834, and died in London, 30th July 1849.

**PERM**, a government of Russia, on both slopes of the Ural Mountains, with an area of 128,250 square miles. Though Perm administratively belongs entirely to Russia in Europe, its eastern part (about 57,000 square miles) is situated in Siberia, in the basin of the Obi. It is traversed from north to south by the Ural range, a low ridge, from 30 to 45 miles in width, thickly covered with forests, and deeply excavated by rivers. The highest summits do not

rise above 3600 feet in the northern section of the range (the Vogulian Ural); in the central portion, between 59° and 60° 30' N. lat., they once or twice exceed 5000 feet (Deneshkin, 5027 feet, and Konzhakovskii Kamen, 5135 feet); but the chain soon sinks towards the south, where it barely attains an elevation of 3000 feet. Where the great Siberian road crosses the ridge the highest point is 1400 feet. Westward the plain of the river Kama is still 500 feet above sea-level at a distance of 120 miles from the main watershed, but to the east the secondary ridges and spurs of the central chain fall away somewhat more rapidly,—Kamyahloff, 100 miles distant, being situated amidst the lowlands of the Obi at an altitude of less than 200 feet.

The geology of Perm has been the subject of very many investigations since the journeys of Humboldt and Murchison; but several parts of the government still remain unexplored. Granites, diorites, porphyries, serpentines, and Laurentian gneisses and limestones, containing iron, copper, and zinc ores, constitute the main axis of the Ural chain; their western slope is covered by a narrow strip of Huronian crystalline slates, which disappear in the east under the Post-Tertiary deposits of the Siberian lowlands, while on the west narrow strips of Silurian limestones, quartzites, and slates, and separate islands of Devonian deposits appear on the surface. These in their turn are covered with Carboniferous clays and sandstones, containing Coal-measures in several isolated basins. The Permian deposits extend as a regular strip, parallel to the main ridge, over these last, and are covered with the so-called "variegated marls," which are now considered as Triassic, and which appear only in the western corner of the territory. Perm is the chief mining region of Russia, owing to its wealth in iron, silver, platinum, copper, nickel, lead, chrome ore, and auriferous alluvial deposits. Many rare metals, besides, such as iridium, osmium, rhodium, and ruthenium, are found along with the above, as also a great variety of precious stones, such as sapphires, jacinths, beryls, phenacites, chrysoberyls, emeralds, aquamarines, topazes, amethysts, jades, malachite. Salt-springs appear in the west; and the mineral waters, though still little known, are also worthy of mention.

The government is very well watered by rivers belonging to the Petchora, Tobol (affluent of the Obi), and Kama systems. The Petchora itself rises in the northern corner of the government, and its tributary the Volosmita is separated by a distance of only 4900 yards from the navigable Vogulka, a tributary of the Kama,—a circumstance of some commercial importance. The tributaries of the Tobol (Soeva, Tura, Isset, and Ui) are far more important. Their sources, which approach those of the tributaries of the Kama very closely, early became a link between Russia and Siberia, and the first section of the Siberian railway (completed for 312 miles from Perm to Ekaterinburg) has been planned to connect the Kama at Perm with the Tura at Tumen, whence there is a navigable route by the Siberian rivers to the very heart of western Siberia at Tomak. The chief river of Perm is, however, the Kama, whose great navigable tributaries the Tchusovaya, Sylva, and Kolva are important channels for the export of the heavy iron goods to Russia,—5,000,000 cwts., valued at upwards of £2,000,000, being annually shipped on these rivers to the Volga. Timber also is floated down many of the smaller streams. Altogether, the rivers supply to some extent the want of roads or the defects of those which exist, the great Siberian highway even (*via* Kasan, Okhansk, Perm, Ekaterinburg, and Tumen) being usually in a bad state.

The government is dotted with a great number of lakes of comparatively trifling size, and marshes also are extensive

in the hilly tracts of the north. No less than 45,750,000 acres are forest; of this large area only 2,175,600 acres are under proper forest administration. The forests are distributed very unequally, covering 95 per cent. of the area in the north, and only 25 per cent. in the south-east. Fir (*Abies sibirica*, *Picea obovata*), pine (*Pinus sylvestris*), cedar (*Pinus Comora*), larch (*L. sibirica*), birch, alder (*Alnus*), and lime are the most common woods; the oak appears only in the south-west. The flora of Perm (956 Phanerogams) presents a mixture of Siberian and Russian species, several of which have their north-eastern or south-western limits within the government. The climate is severe, the average temperature at different places being as follows:—

	Lat. N.	Altitude.	Yearly average.		July average.	
			Feet.	Fahr.	Fahr.	Fahr.
Bogolovak .....	59° 45'	630	29° 3	3° 0	62° 6	
Usole (Kama)....	59° 25'	300	34° 0	4° 5	63° 3	
Nijne-Taghilsk	57° 55'	590	35° 1	3° 0	64° 9	
Ekaterinburg ...	56° 48'	890	32° 9	2° 5	63° 5	

The population in 1881 amounted to 2,520,100, of which number 106,500 lived in towns. It consisted chiefly of Great Russians, Bashkirs (about 100,000, including Mascheryaks and Teptyars), about 65,000 Permyaks or Permians, 25,000 Tatars, 8000 Tcheremisses, and some 2500 Vogla. More than a million of the Great Russians are Nonconformists, their number having rapidly increased within the last twenty years. Except in the northern districts, which are covered with marshes and tundras, and in a some 70 miles wide, which includes the higher and stony parts of the Ural Mountains to the north of the 58th parallel, agriculture is the general occupation of the inhabitants, who are favoured with a very fertile soil in the southern districts. Nevertheless, only 8,000,000 acres are under crops, the proportion of arable land ranging from 2 to 84 per cent. of the area in different districts. Rye, oats, barley, and hemp are raised in all parts, and wheat, millet, buckwheat, and flax in the south. The average crops in recent years have been 4,198,000 quarters of grain and 1,866,400 bushels of potatoes.

Cattle-breeding is specially developed in the south-east among the Bashkirs, who have large numbers of horses, but is at present decreasing. In 1881 there were 837,000 horses, 820,000 horned cattle, 1,055,000 sheep, and 267,000 pigs. These figures vary, however, from year to year, in consequence of the murrains that periodically destroy great numbers of horses and cattle. Agriculture is widely spread among the Bashkirs, Teptyars, and Tcheremisses, and the chase is still a source of wealth, especially among the Vogla. Shipbuilding is developed on the Kama, Vishera (a tributary of the Kama), Sylva, and Tuhosovaya; and large amounts of timber, pitch, and tar, as also wooden implements, are exported to the Volga. Some 100,000 hands find occupation in connexion with the mining industry, and a number are engaged in the transport trade to and from Siberia, or in shipping. Mining increases every year, especially since private enterprise has been allowed to develop freely. In 1879 the total production of metals on the mining-works of the crown and of private individuals was (in cwts.)—gold, 102·7; copper, 12,913; pig-iron, 4,487,000; iron, 2,704,000; steel, 599,600; salt, 3,750,000. The working of coal, although recent, promises to be most valuable. In 1865 the aggregate of all manufactures connected with mining hardly exceeded 18,000,000 roubles (£1,500,000) in value. In 1879 it was—copper, 879,800 roubles; pig-iron, 14,076,000; iron, 9,077,900; and steel, 2,318,000. The aggregate of other manufactures, employing 7400 hands, in the same year reached 20,962,000 roubles, against 5,802,000 in 1865. The first place is taken by flour-mills (£273,500), followed by distilleries (£566,500) and tanneries (£212,300); next in order come the manufactures of spirits, saddlery, woollen cloth, ropes, oils, cakes, paper, chemicals, candles, tallow, soap, matches, wax-candles, glass, pottery, &c. The cutting of precious stones is extensively carried on throughout the villages on the eastern slope of the Ural Mountains, the chief market for them being at Ekaterinburg. Besides, a variety of petty trades are carried on, the manufacture of carpets in the south-east (Tumen carpets), as also that of boots at Kungur, being especially worthy of mention.

An active trade, greatly favoured by the easy communication of the chief centres of the mining industry with the great market of Nijni Novgorod on the one side and with the great network of Siberian rivers on the other, is carried on in metals and metal wares, minerals, timber and wooden wares, tallow, skins, cattle, furs, corn, and linseed. Large caravans descend the affluents of the Kama every spring, and reach the great fairs of Latsheff and Nijni Novgorod, or descend the Volga to Samara and Astrakhan; while Ekaterinburg is an important centre for the trade with

Siberia. The fair at Irbit, second in importance only to that of Nijni Novgorod, is a great centre for supplying Siberia with grocery and manufactured wares, as also for the purchase of tea, of furs for Russia, and of corn and cattle for the mining districts. About 180 other fairs are held every year within the government. The chief commercial centres are Ekaterinburg, Irbit, Perm, Kamyahloff, Shadrinsk, Toberdyn, and several iron-works (seeedy).

Perm is more largely provided with educational institutions and primary schools than most of the governments of central Russia. Besides the usual lyceum and ecclesiastical seminary at Perm, there are a mining school at Ekaterinburg and lower mining schools at Bogolovak and Kushva, and two lyceums for women at Perm and Ekaterinburg. The number of primary schools in 1881 was 621 (39,773 scholars, including about 8000 girls). The Nonconformists are very diligent in teaching reading (in Old Slavonian) to their girls. The Ural Society of Naturalists, at Ekaterinburg, issues valuable scientific serials, and there are within the government two first-rate meteorological and magnetic observatories, at Ekaterinburg and Bogolovak.

Perm is divided into twelve districts having for their chief towns (with populations in 1879)—Perm (32,350), Kungur (14,000), Krasnoufimsk (3700), Okhanak (1650), Osa (2850), Solikamsk (16,900), and Tcherdyna (3260) in Europe; Ekaterinburg (25,150), Irbit (4250), Kamyahloff (2160), Shadrinsk (11,550), and Verkhoturle (8600) in Asia. Alapavek (5450), Dalmatoff (4350), and Dedyukhin (3900, with important salt-works) have also municipal institutions. The iron-works form the following important towns:—Nijne-Taghilsk (30,000 in 1881), Neviansk (14,000), Kyshty (12,350), Revdinsk (9950), Upper and Lower Turinsk (9750), Nyazepetrovsk (9000), Verkh-Issetskii (7000), Nijne-Issetskii, Syvertskii (5900), Bogolovak (4500), Verkhne-Taghilsk (2350), and Sukunak (3150). The salt-works of Usole (7700) and Lanva (3250) may also be mentioned.

*History.*—Remains of Paleolithic man, everywhere very scarce in Russia, have not yet been discovered in the upper basins of the Kama and Obi, with the exception, perhaps, of a single human skull found in a cavern on the Tchanva (basin of Kama), together with a skull of *Ursus spelæus*. Neolithic remains, on the other hand, are met with in immense quantities on both Ural slopes throughout the territory of Perm. Still larger quantities of implements belonging to an early Finnish, or rather Ugrian, civilization are found everywhere in the basin of the Kama, even in its northern parts, the present district of Tcherdyn. Even Herodotus speaks of the richness of this country inhabited by the Ugrians, who kept up a brisk traffic with the Greek colony of Olbia, and with the Bosphorus by way of the Sea of Azoff and the Volga. The precise period at which the Ugrians left the district for the southern steppes of Russia (the "Lebedia" of Constantine Porphyrogenitus) is not known. In the 9th century the Scandinavians were acquainted with the country as Biarmia, and Byzantine annalists knew it as Permia. Nestor describes it as a territory of the Perm, a Finnish people, some 50,000 of whom still remain, and whose name seems to have been derived from *parma*, a Finnish word denoting hilly tracts thickly covered with forests.

The Russians penetrated into this region at an early date. In the 11th century Novgorod levied tribute from the Finnish inhabitants, and undertook the colonization of the country, which in the treaties of the 13th century is dealt with as a separate territory of Novgorod. In 1471, after the fall of Novgorod, Perm was annexed to Moscow, which in the following year erected a fort to protect Russian settlers and tradesmen from the Vogla, Otsyga, and Samoyedes. Toberdyn, the oldest town of Perm, was already in existence in the 15th century. The mineral wealth of the country soon attracted the attention of the Moscow princes, and Ivan III. sent two Germans to search for ores; these they succeeded in finding south of the upper Petchora. A great impulse to colonization and mining was given by the Strogonoffs, when in the 16th century they received immense tracts of land on the Kama and Tuhosovaya. They founded the first salt and iron works, built forts, and colonized the Ural region. Solikamak, Osa, Okhanak, and Verkhoturle were founded during this century. By the latter part of the century the Russian colonies had spread beyond the Ural Mountains; and in this direction the Strogonoffs continued to extend their mining operations. The rapidly-growing trade with Siberia gave a new impulse to the development of the country. This trade had its centres at Perm and Solikamak, where merchandise brought up the Kama was unshipped and transported by land to Verkhoturle, at that time the first Siberian town and custom-house on the great highway. Kungur, too, attained some commercial importance. The fair of Irbit in the 17th century became the chief seat of the trade in merchandises, brought both from Russia to Siberia and from Siberia and Bokhara to Russia. Communication with Siberia having taken a northern route, the southern parts of the territory were not colonized until the next century, when Ekaterinburg, Krasnoufimsk, and Alapavek were founded. In 1780 the provinces of Perm and Ekaterinburg were instituted, but were soon united into one. (P. A. K.)

PERM, capital of the above government, stands on the left bank of the Kama, on the great highway to Siberia, 930 miles north-east from Moscow. During summer it has regular steam communication with Kasan, 685 miles distant, and it is connected by rail with Ekaterinburg. The town is mostly built of wood, with broad streets and wide squares, and has a somewhat poor aspect, especially when compared with Ekaterinburg. It is the see of a bishop, and has an ecclesiastical seminary and a military school. The manufactures are few; the Government manufactory of steel guns and munitions of war, in the immediate neighbourhood of the town, turns out about 1600 tons of guns annually. The aggregate production of the private manufactories of all kinds did not exceed £165,000 in 1879; they included tanneries (£78,600), distilleries (£61,000), rope-works (£9500), brick-works, breweries, soap and candle works, iron-wire and copper-ware works. Numerous flour-mills and several oil-works occur within the district. The town derives its commercial importance as being the chief place of storage for merchandises to and from Siberia (tea, metals and metal-wares, skins, leather, butter, wool, bristles, tallow, cedar nuts, linseed, &c.), which is unshipped here from the steamers coming up the Kama, and despatched by rail or on cars and sledges to Siberia, or *vice versa*. The trade is chiefly in the hands of Nijni Novgorod, Kazan, Ekaterinburg, and Siberian merchants. The population of Perm in 1879 was 32,350.

The present site of Perm was occupied, as early as the year 1668, by a settlement named Brukhanovo, founded by one of the Strogoffs; this settlement seems to have received the name of Perm in the 17th century. The Yagohikhinaky copper-work was founded in the immediate neighbourhood in 1723, and in 1781 it received officially the name of Perm, and became an administrative centre both for the country and for the mining region. The mining authorities left Perm for Ekaterinburg in 1830.

PERMUTATIONS. See ALGEBRA, vol. i. p. 560.

PERNAMBUCO, or RECIFE, a city and seaport of Brazil and the chief town of the extensive province of Pernambuco. As it is situated on the coast in 8° 3' 27" S. lat. and 34° 50' 14" W. long. (Fort Picao), not far from the point where the continent begins to trend towards the south-west, it is naturally the first port visited by steamers from Lisbon to Brazil. The reef, which can be traced more or less distinctly along the Brazilian seaboard for several hundred miles, rises at Pernambuco into a perfectly straight artificial-looking wall, 3½ miles long, with even

duced by the successive growth and death of the small shells of *Serpulus* with some few barnacles and nullipores, proves so effectual a protection of the outer surface that though it is exposed to the full force of the waves of the open Atlantic the oldest pilots know of no tradition of change in its appearance.<sup>1</sup> The belt of water within the reef is about a mile in width and forms a safe but rather shallow harbour; vessels drawing 19½ feet can enter, and there is abundant room for mooring along the shore and reef, but mail-steamers usually anchor in the roads and discharge by means of lighters. Sir John Hawkshaw's scheme for the improvement of the harbour (1874) was rejected by the Government as too costly; but extensive dredging operations are being prosecuted. The city of Pernambuco lies low, and is surrounded by a swampy stretch of country, with no high ground nearer than the hill on which Olinda is built, 8 miles to the north. It used to be considered the most pestilential of Brazilian seaports; but its sanitary condition has greatly improved, partly owing to drainage-works executed by an English company. There are three natural divisions in the city—Recife ("the Reef"), situated not on the reef proper but on an island forming the southern end of a sandbank that stretches north towards Olinda; Sant' Antonio, on a peninsula separated from the inland by the united waters of the Capibaribe and the Biberibe; and Boa Vista, the fashionable residential district on the mainland opposite Sant' Antonio. In Recife the streets are narrow and crooked and many of the houses are of great age and present Dutch characteristics; but Sant' Antonio has broad straight streets, with well-paved side-walks, tramways (worked by mules), and modern-looking houses. Among the public buildings in Pernambuco it is enough to mention the governor's palace, the episcopal palace, the hospital of Pedro II. (5000 patients per annum, with French sisters of mercy as nurses), the founding hospital, the poorhouse, the new lunatic asylum (1881), the university (18 professors and 530 students in 1879), the normal school, and the provincial library (13,000 vols., 11,581 readers, in 1880). The great commercial staple is sugar, and the brown sticky mud of the streets owes its peculiar character to the juice of the cane; 825,711 bags of sugar were brought to the market in 1875-76 and 1,715,637 bags in 1879-80. Cotton, which was first exported in 1778 and continued a small item till 1781, now holds the second place,—130,925 bales in 1875-76 and 60,117 in 1879-80. Coal began to be imported in 1834,—25,314 tons in 1879-80. The total value of the exports and imports has greatly increased.

	1816.	1866.	1886.	1870.	1880.
Imports .....	£196,928	£954,180	£1,517,498	£1,921,104	£2,478,828
Exports .....	£689,794	£947,028	£1,507,019	£1,508,968	£2,921,618

The port was opened to British vessels in 1808, and goods, which formerly had to pass through Portugal, began to be brought to England direct. A cemetery for British subjects was opened in 1814, a British hospital in 1821, and a British chapel in 1836. In 1880, out of a total of 1047 vessels (674,227 tons) calling at Pernambuco 451 (249,912 tons) were British. Pernambuco is connected with Olinda by a steam-tramway line and with Caxanga (8½ miles) by a mule-tramway; the Recife and San Francisco Railway (1856-62) runs 78 miles to Una, and is continued by a narrow-gauge line to Garanhuns; and another narrow line strikes up the Capibaribe 52 miles to Limoeiro. In 1878 the population of the town and immediate suburbs was 94,498.

The name of Pernambuco (*pera*, "a stone," *nambuco*, "pierced") appears to have been originally applied to Itamaracá (a town in

<sup>1</sup> See Darwin's account in *London, Edinburgh, and Dublin Phil. Mag.*, vol. xix., 1841, p. 257; and *Naturalist's Voyage*, p. 498.

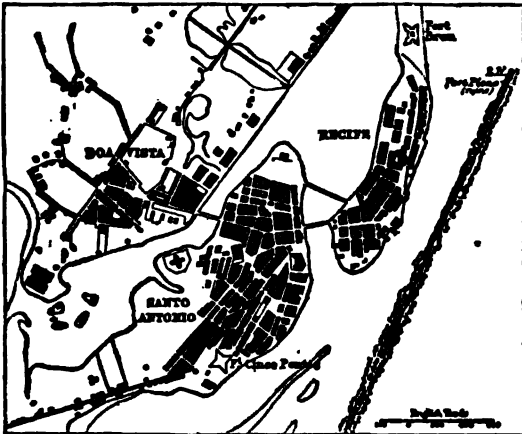

Plan of Pernambuco.

sides and a smooth and almost level top from 30 to 60 yards in width. It is of a hard pale-coloured sandstone, breaking with a very smooth fracture; and a tough layer of calcareous matter, generally several inches thick, pro-

7° 44' S. lat., now decayed, but formerly the capital of an independent captaincy, where also there is an opening in the reef. In 1532 Duarte Coelho founded the city of Olinda, which continued to be the capital of the captaincy of Pernambuco till 1710. When in 1580 the country passed into the hands of Spain it had 700 stone houses, 4000 to 5000 negro slaves were employed in its sugar-plantations, and from 40 to 50 vessels came annually to load with sugar and Brazil wood, often called simply Pernambuco or Fernambuk. Recife, which was a mere collection of fishers' huts when occupied by the French under Villegagnon in 1561, shortly afterwards began to attract attention as a port. It was captured and held for thirty-four days in 1595 by Sir James Lancaster (q.v.), who did not, however, succeed in his attack on Olinda. In the 17th century this part of Brazil was the scene of a great struggle between the Spaniards and the Dutch. Olinda and Recife were captured by the Dutch under Admiral Loenoq in 1630, and in the following year, when they were obliged to retreat to the reef, they left Olinda in flames. Fort Brun was built in 1631. In 1639 (Recife already containing 2000 houses) Count Maurice laid out a new town (Mauritstad) on the island of Antonio Vas, and built himself a palace (Vrijburg or Sans Souci) of materials obtained by the demolition of Olinda. A bridge was thrown across from Recife to Mauritstad, and another from Mauritstad to the mainland, where the count had his summer palace of Schoonsigt or Boa Vista. An observatory was erected under Margraf and De Laet. In 1654 the Dutch garrison, neglected by the authorities at home, who were at war with Cromwell, was obliged to capitulate to the Portuguese (26th January).

See J. B. Fernandes Gama, *Mem. Hist. do Prov. de Pernambuco* (Pernambuco, 1844); Barboza, *Resum. in Brasilia gestorum historia* (1690); and Metacher, "Les Hollandais au Brésil," in *Le Moniteur des Indes Orient. et Occid.* (1848-49).

**PERNAU**, in Russian **PERNOFF**, a seaport town and watering-place of European Russia, in the government of Livonia, is situated in 58° 23' N. lat. and 24° 30' E. long., 155 miles north of Riga, on the left bank of the Pernau or Pernova, which about half a mile farther down enters the Bay of Pernau, the northern arm of the Gulf of Riga. The town proper is well and regularly built, and contains two public gardens and two public parks (Salon Park and Bade Park), a town-house, a hospital, and a public library. On the right side of the river lies the suburb of Bremerseite. The harbour is small, and the depth of water on the bar under 10 feet. The exports, which consist mainly of flax (to Great Britain, France, and Portugal), lineded (to Germany), mats, and cereals, had a value of 8,220,421 silver roubles in 1880, and of 5,427,465 in 1881 (a bad year). The population was 6690 in 1863, 9525 in 1867, and 12,918 in 1881.

Founded on the right side of the river in 1255 by one of the bishops of Oesel, Pernau, with its walls and castle, soon became a flourishing place. In the 16th century it was occupied in succession by the Swedes, the Poles, and the knights of the Teutonic order. After 1599 the Poles transferred the town to the left side of the river; and in 1642 the Swedes, who had been in possession since 1617, strengthened it with regular fortifications. In 1710 it was besieged and taken by the Russians, and the fortress is now demolished.

**PERNE**, **ANDREW** (1519-1589), a notable character in 16th-century history, was born at East Bilney in Norfolk in 1519. He received his education at St John's College, Cambridge, was afterwards a fellow of Queens' College, and finally master of Peterhouse in the same university. He is best known as a remarkable example of the tergiversation in reference to religious profession which, owing to the sudden changes in the prescribed theological belief of the state, was only too common in his age. In the reign of Henry VIII. he defended the adoration of saints, but subsequently abandoned this doctrine in the reign of Edward VI., and became distinguished as an active promulgator of Reformation tenets. In the reign of Mary he subscribed the Roman Catholic articles, and when the remains of Martin Bucer and Paulus Fagius, —two Protestant professors in the university—were exhumed and burnt, he preached on the occasion. He was rewarded for his subservience by being promoted to the deanery of Ely. Notwithstanding this discreditable compliance, he succeeded in gaining Elizabeth's favour on her accession; he signed the grace for restoring the names of Bucer and Fagius in the lists of honours and dignities

from which they had been expunged; and he was elected by the university to the office of vice-chancellor. He thus, like Symond Symonda, the vicar of Bray, was twice a Papist and twice a Protestant. During the remainder of his career he was known as a moderate supporter of Church of England doctrine against the Puritan party. "What bishop or politician in England," asks Gabriel Harvey, "was so great a temporizer as he!" The wags of the university invented a verb, *perno*, which, they declared, meant, "I rat," "I change often." Yet the satirist, notwithstanding, admits his many excellent qualities and eulogizes him for his urbanity and singular tact in his intercourse with men of every class and shade of opinion. To this latter characteristic we must attribute the fact that, while, throughout his life, Perne preserved the friendship of austere churchmen like Whitgift, he was popular with critics of a very different stamp, such as the dissolute Thomas Nash, who declares that "few men lived better." It is not a little to Perne's credit that the social influence which he thus acquired was uniformly exerted to bring about the ends which he had in view as a philanthropist and a true lover of learning. He was a distinguished benefactor of the university in which his life was mainly passed, and its library was restored chiefly through his efforts. His own library at Peterhouse was said to be the best at that time in England. Dr Perne died in 1589 while on a visit to Archbishop Whitgift, on whose gratitude he had established a lasting claim by the protection he accorded him during the persecution under Mary. He belongs to the class of men whose influence during their lives is felt rather than seen; and the services he rendered to his generation become increasingly apparent in proportion as this period of English history is more closely studied.

**PÉRONNE**, chief town of an arrondissement of the department of the Somme, France, and a fortified place on the right bank of that river at its confluence with the stream called the Doingt or Cologne, lies 9½ miles north-north-east of Paris on the railway from Paris to Cambrai. Wet moats surround the ramparts, which are built of brick. The church of St Jean (1509-1535) was greatly damaged during the bombardment of 1870-71, but has since been restored. The castle of Péronne, in one of the bastions of the enceinte, was partially destroyed by fire in 1877; it still retains four large conical-roofed towers dating from the Middle Ages, one of which is said to have been the prison of Louis XI., when he had his famous encounter with Charles the Bold (1468). The town-hall, which was built in the 16th century, has an elegant campanile of modern construction. The population of Péronne in 1881 was 4696.

The Frankish kings had a villa at Péronne, which Clovis II. gave to Erchinoaldus, mayor of the palace. The latter founded a monastery here, and raised in honour of St Furey a collegiate church, which was a wealthy establishment until the Revolution; it is the burial-place of Charles the Simple, who died of starvation in a dungeon in Péronne, into which he had been thrown by the count of Vermandois (929). After the death of Philip of Alsace Péronne, which he had inherited through his wife, escheated to the French crown (1199), and in 1209 received a charter with municipal privileges from Philip Augustus. By the treaty of Arras (1435) it was given to the Burgundians; bought back by Louis XI., it passed again into the hands of Charles the Bold in 1465. On the death of Charles, however, in 1477, Louis XI. resumed possession. In 1588 the emperor Charles V. besieged Péronne, but without success; in its defence a woman called Marie Fourré greatly distinguished herself, and the anniversary of the raising of the siege was celebrated at Péronne for many years. It was the first town after Paris at which the League was proclaimed in 1577. Péronne's greatest misfortunes occurred during the late Franco-German war. It was invested on 27th December 1870, and bombarded from the 28th to the 9th of the following January, upon which date, on account of the sufferings of the civil population, among whom smallpox had broken out, it was compelled to capitulate. Out of 700 houses 600 were

score or less injured and eighty-two buildings set on fire; the tower of the church of St Jean was also burnt, its roofing and timber-work destroyed, and the bells melted by the flames. This damage has since been repaired.

PÉROUSE. See LA PÉROUSE, vol. xiv. p. 298.

PERPETUAL MOTION, or PERPETUUM MOBILE, in its usual significance does not mean simply a machine which will go on moving for ever, but a machine which, once set in motion, will go on doing useful work without drawing on any external source of energy, or a machine which in every complete cycle of its operation will give forth more energy than it has absorbed. Briefly, a perpetual motion usually means a machine which will create energy.

The earlier seekers after the "perpetuum mobile" did not always appreciate the exact nature of their quest; for we find among their ideals a clock that would periodically rewind itself, and thus go without human interference as long as its machinery would last. The energy created by such a machine would simply be the work done in overcoming the friction of its parts, so that its projectors might be held merely to have been ignorant of the laws of friction and of the dynamic theory of heat. Most of the perpetual motionists, however, had more practical views, and explicitly declared the object of their inventions to be the doing of useful work, such as raising water, grinding corn, and so on. Like the exact quadrature of the circle, the transmutation of metals, and other famous problems of antiquity, the perpetual motion has now become a venerable paradox. Still, like these others, it retains a great historical interest. Just as some of the most interesting branches of modern pure mathematics sprang from the problem of squaring the circle, as the researches of the alchemists developed into the science of modern chemistry, so, as the result of the vain search after the perpetual motion, there grew up the greatest of all the generalizations of physical science, the principle of the conservation of energy.

There was a time when the problem of the perpetual motion was one worthy of the attention of a philosopher. Before that analysis of the action of ordinary machines which led to the laws of dynamics, and the discussion of the dynamical interdependence of natural phenomena which accompanied the establishment of the dynamical theory of heat, there was nothing plainly unreasonable in the idea that work might be done by the mere concatenation of machinery. It had not then been proved that energy is uncreatable and indestructible in the ordinary course of nature; even now that proof has only been given by induction from long observation of facts. There was a time when wise men believed that a spirit, whose maintenance would cost nothing, could by magic art be summoned from the deep to do his master's work; and it was just as reasonable to suppose that a structure of wood, brass, and iron could be found to work under like conditions. The disproof is in both cases alike. No such spirit has ever existed, save in the imagination of his describer, and no such machine has ever been known to act, save in the fancy of its inventor.

The principle of the conservation of energy, which in one sense is simply a denial of the possibility of a perpetual motion, rests on facts drawn from every branch of physical science; and, although its full establishment is not half a century old, yet so numerous are the cases in which it has been tested, so various the deductions from it that have been proved to accord with experience, that it is now regarded as one of the best-established laws of nature. Consequently, on any one who calls it in question is thrown the burden of proving his case. If any machine were produced whose source of energy could not at once be traced, a man of science (complete freedom of investigation being supposed) would in the first place try to

trace its power to some hidden source of a kind already known; or in the last resort he would seek for a source of energy of a new kind and give it a new name. Any assertion of creation of energy by means of a mere machine would have to be authenticated in many instances, and established by long investigation, before it could be received in modern science. The case is precisely as with the law of gravitation; if any apparent exception to this were observed in the case of some heavenly body, astronomers, instead of denying the law, would immediately seek to explain the occurrence by a wider application of it, say by including in their calculations the effect of some disturbing body hitherto neglected. If a man likes to indulge the notion that, after all, an exception to the law of the conservation of energy may be found, and, provided he submits his idea to the test of experiment at his own charges without annoying his neighbours, all that can be said is that he is engaged in an unpromising enterprise. The case is otherwise with the projector who comes forward with some machine which claims by the mere ingenuity of its contrivance to multiply the energy supplied to it from some of the ordinary sources of nature and sets to work to pester scientific men to examine his supposed discovery, or attempts therewith to induce the credulous to waste their money. This is by far the largest class of perpetual-motion-mongers nowadays. The interest of such cases is that attaching to the morbid anatomy of the human mind. Perhaps the most striking feature about them is the woful sameness of the symptoms of their madness. As a body perpetual-motion seekers are ambitious, lovers of the short path to wealth and fame, but wholly superficial. Their inventions are very rarely characterized even by mechanical ingenuity. Sometimes indeed the inventor has simply bewildered himself by the complexity of his device; but in most cases the machines of the perpetual motionist are of child-like simplicity, remarkable only for the extraordinary assertions of the inventor concerning them. Wealth of ideas there is none; simply assertions that such and such a machine solves the problem, although an identical contrivance has been shown to do no such thing by the brutal test of standing still in the hands of many previous inventors. Hosts of the seekers for the perpetual motion have attacked their insoluble problem with less than a schoolboy's share of the requisite knowledge; and their confidence as a rule is in proportion to their ignorance. Very often they get no farther than a mere prospectus, on the strength of which they claim some imaginary reward, or offer their precious discovery for sale; sometimes they get the length of a model which wants only the last perfection (already in the inventor's brain) to solve the great problem; sometimes fraud is made to supply the motive-power which their real or pretended efforts have failed to discover.

It was no doubt the barefaced fallacy of most of the plans for perpetual motion that led the majority of scientific men to conclude at a very early date that the "perpetuum mobile" was an impossibility. We find the Parisian Academy of Sciences refusing, as early as 1775, to receive schemes for the perpetual motion, which they class with solutions of the duplication of the cube, the trisection of an angle, and the quadrature of the circle. Stevinus and Leibnitz seem to have regarded its impossibility as axiomatic; and Newton at the beginning of his *Principia* states, so far as ordinary mechanics are concerned, a principle which virtually amounts to the same thing (see MECHANICS, vol. xv. p. 715).

The famous proof of De la Hire simply refers to some of the more common gravitational perpetual motions, to which we shall refer shortly. The truth is, as we have said already, that, if proof is to be given, or considered

necessary, it must proceed by induction from all physical phenomena.

It would serve no useful purpose here to give an exhaustive historical account of the vagaries of mankind in pursuit of the "perpetuum mobile." The reader may consult on this subject the two volumes by Henry Dircks, C.E., published by E. and F. N. Spon, London, 1861 and 1870, from which, for the most part, we select the following facts to give the reader some idea of this department of the history of human fallibility.

By far the most numerous class of perpetual motions is that which seeks to utilize the action of gravity upon rigid solids. We have not read of any actual proposal of the kind, but the most obvious thing to imagine in this way would be to procure some substance which intercepts gravitational attraction. If this could be had, then, by introducing a plate of it underneath a body while it was raised, we could elevate the body without doing work; then, removing the plate, we could allow the body to fall and do work; eccentrics or other imposing devices being added to move the gravitation intercepter, behold a perpetual motion complete! The great difficulty is that no one has found the proper material for an intercepter.

Fig. 1 represents one of the most ancient and oftener-repeated of gravitational perpetual motions. The idea is that the balls rolling in the compartments between the felloe and the rim of the wheel will, on the whole, so comport themselves that the moment about the centre of those on the descending side exceeds the moment of those on the ascending side. Endless devices, such as curved spokes, levers with elbow-joints, eccentrics, &c., have been proposed for effecting this impossibility. The modern student of dynamics at once convinces himself that no machinery can effect any such result; because, if we give the wheel a complete turn, so that each ball returns to its original position, the whole work done by the ball will, at the most, equal that done on it. If we were to start the wheel and balls in the most general way possible, we should doubtless have a very pretty problem to solve; but we know that, if the laws of motion be true, in each step the kinetic energy given to the whole system of wheel and balls is equal to that taken from the potential energy of the balls less what is dissipated in the form of heat by frictional forces, or *vice versa*, if the wheel and balls be losing kinetic energy,—save that the friction in both cases leads to dissipation. So that, whatever the system may lose, it can, after it is left to itself, never gain energy during its motion.

The two most famous perpetual motions of history, viz., the wheels of the marquis of Worcester and of Councillor Orffyreus were probably of this type. The marquis of Worcester gives the following account of his machine in his *Century of Inventions* (art. 56).

"To provide and make that all the Weights of the descending side of a Wheel shall be perpetually further from the Centre than those of the mounting side, and yet equal in number and heft to the one side as the other. A most incredible thing, if not seen, but tried before the late king (of blessed memory) in the *Tower*, by my directions, two Extraordinary Embassadors accompanying His Majesty, and the Duke of Richmond, and Duke Hamilton, with most of the Court, attending Him. The Wheel was 14. Foot over, and 40. Weights of 50. pounds apiece. Sir William Balfour, then Lieutenant of the *Tower*, can justify it, with several others. They all saw, that notsooner these great Weights passed the Diameter-

line of the lower side, but they hung a foot further from the Centre, nor no sooner passed the Diameter-line of the upper side but they hung a foot nearer. Be pleased to judge the consequence."

Orffyreus (whose real name was Bessler) also obtained distinguished patronage for his invention. His last wheel for he appears to have constructed more than one, was 12 feet in diameter and 1 foot 2 inches broad; it consisted of a light framework of wood covered in with oil-cloth so that the interior was concealed, and was mounted on an axle which had no visible connexion with any external mover. It was examined and approved of by the landgrave of Hesse-Cassel, in whose castle at Weissenstein it is said to have gone for eight weeks in a sealed room. The most remarkable thing about this machine is that it evidently imposed upon the mathematician's Gravesande, who wrote a letter to Newton giving an account of his examination of Orffyreus's wheel undertaken at the request of the landgrave, wherein he professes himself dissatisfied with the proofs theretofore given of the impossibility of perpetual motion, and indicates his opinion that the invention of Orffyreus is worthy of investigation. He himself, however, was not allowed to examine the interior of the wheel. The inventor seems to have destroyed it himself. One story is that he did so on account of difficulties with the landgrave's Government as to a licence for it; another that he was annoyed at the examination by Gravesande, and wrote on the wall of the room containing the fragments of his model that he had destroyed it because of the impertinent curiosity of Professor's Gravesande.

The history of this case is noteworthy, because it contains all the characters that usually appear in such comedies even now,—the fraudulent paradoxer, the illustrious and intelligent patron, the simple-minded, unbiassed, scientific witness.

It is worthy of remark that the overbalancing-wheel perpetual motion seems to be as old as the 13th century. In his second series Dircks quotes an account of an invention by Wilars de Honecort, an architect whose sketch-book is still preserved in the *Ecoles des Chartes* at Paris. De Honecort says, "Many a time have skilful workmen tried to contrive a wheel that shall turn of itself; here is a way to do it by means of an uneven number of mallets, or by quicksilver." He thereupon gives a rude sketch of a wheel with mallets jointed to its circumference. It would appear from some of the manuscripts of Leonardo da Vinci that he had worked with similar notions.

Another scheme of the perpetual motionist is a water-wheel which shall feed its own mill-stream. This notion is probably as old as the first miller who experienced the difficulty of a dry season. One form is figured in the *Mathematical Magic* of Bishop Wilkins (1614-1672); the essential part of it is the water-screw of Archimedes, which appears in many of the earlier machines of this class. Some of the later ones dispense with even the subtlety of the water-screw, and boldly represent a water-wheel pumping the water upon its own buckets.

Perpetual motions founded on the hydrostatical paradox are not uncommon; Papin, the well-known inventor of the digester, exposes one of these in the *Philosophical Transactions* for 1685. The most naive of these devices is that illustrated in fig. 2, the idea of which is that the larger quantity of water in the wider part of the vessel weighing more will overbalance the smaller quantity in the narrower part, so that the water will run over at C, and so on continually.

Capillary attraction has also been a favourite field for

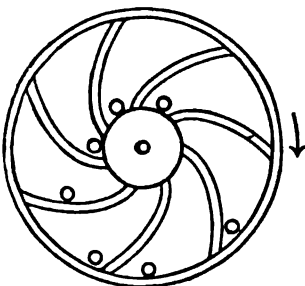

Fig. 1.

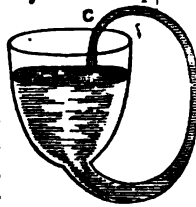

Fig. 2.



the vain quest; for, if by capillary action fluids can be made to disobey the law of never rising above their own level, what so easy as thus to produce a continual ascent and overflow, and thus perpetual motion? Various schemes of this kind, involving an endless band which should raise more water by its capillary action on one side than on the other, have been proposed. The most celebrated is that of Sir William Congreve, who invented the rockets that bear his name. EFG (fig. 3) is an inclined plane over pulleys; at the top and bottom travels an endless band of sponge, *abcd*, and over this again an endless band of heavy weights jointed together. The whole stands over the surface of still water. The capillary action raises the water in *ab*, whereas the same thing cannot happen in the part *cd*, since the weights squeeze the water out. Hence, inch for inch, *ab* is heavier than *cd*; but we know that if *ab* were only just as heavy inch for inch as *cd* there would be equilibrium, if the heavy chain be also uniform; therefore the extra weight of *ab* will cause the chain to move round in the direction of the arrow, and this will go on continually.

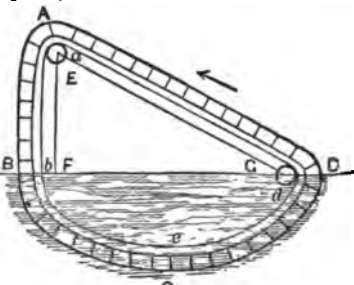

Fig. 3.

The more recondite vehicles of energy, such as electricity and magnetism, are more seldom drawn upon by perpetual-motion inventors than might perhaps be expected. Instances do occur, but devices of this kind have not become a common part of the folklore of nations like the overbalancing wheel and the self-sufficient water-mill. Gilbert, in his treatise *De Magnete*, alludes to some of them, and Bishop Wilkins mentions among others a machine "wherein a loadstone is so disposed that it shall draw unto it on a reclined plane a bullet of steel, which, still as it ascends near to the loadstone, may be contrived to fall through some hole in the plane and so to return unto the place whence at first it began to move, and being there, the loadstone will again attract it upwards, till, coming to this hole, it will fall down again, and so the motion shall be perpetual." The fact that screens do exist whereby electrical and magnetic action can be cut off would seem to open a door for the perpetual-motion seeker. Unfortunately the bringing up and removing of these screens involves in all cases just that gain or loss of work which is demanded by the inexorable law of the conservation of energy. A shoemaker of Linlithgow called Spence pretended that he had found a black substance which intercepted magnetic attraction and repulsion, and he produced two machines which were moved, as he asserted, by the agency of permanent magnets, thanks to the black substance. The fraud was speedily exposed, but it is worthy of remark that Sir David Brewster thought the thing worth mentioning in a letter to the *Annales de Chimie*, 1818, wherein he states "that Mr Playfair and Captain Kater have inspected both of these machines and are satisfied that they resolve the problem of perpetual motion."

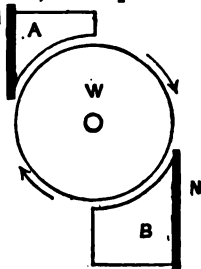

Fig. 4.

Not very long ago the writer of this article received by post an elaborate drawing of a locomotive engine which

was to be worked by the agency of permanent magnets. He forgets the details, but it was not so simple as the plan represented in fig. 4, where M and N are permanent magnets, whose attraction is "screened" by the wooden blocks A and B from the upper left and lower right quadrants of the soft iron wheel W, which consequently is attracted round in the same direction by both M and N, and thus goes on for ever.

One more page from this chapter of the book of human folly; the author is the famous John Bernoulli. We translate his Latin, as far as possible, into modern phraseology.

In the first place we must premise the following (see fig. 5).

1. If there be two fluids of different densities whose densities are in the ratio of G to L, the height of equiponderating cylinders on equal bases will be in the inverse ratio of L to G.
2. Accordingly, if the height AC of one fluid, contained in the vase AD, be in this ratio to the height EF of the other liquid, which is in a tube open at both ends, the liquids so placed will remain at rest.
3. Wherefore, if AC be to EF in a greater ratio than L to G, the liquid in the tube will ascend; or if the tube be not sufficiently long the liquid will overflow at the orifice E (this follows from hydrostatic principles).
4. It is possible to have two liquids of different density that will mix.
5. It is possible to have a filter, colander, or other separator, by means of which the lighter liquid mixed with the heavier may be separated again therefrom.

*Construction.*—These things being presupposed, I thus construct a perpetual motion. Let there be taken in any (if you please, in equal) quantities two liquids of different densities mixed together (which may be had by Hyp. 4), and let the ratio of their densities be first determined, and be the heavier to the lighter as G to L, then with the mixture let the vase AD be filled up to A. This done, let the tube EF, open at both ends, be taken of such a length that AC:EF > 2L:G+L; let the lower orifice F of this tube be stopped, or rather covered with the filter or other material separating the lighter liquid from the heavier (which may also be had by Hyp. 5); now let the tube thus prepared be immersed to the bottom of the vessel CD; I say that the liquid will continually ascend through the orifice F of the tube and overflow by the orifice E upon the liquid below.

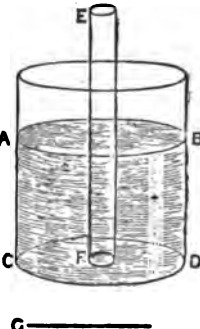

Fig. 5.

*Demonstration.*—Because the orifice F of the tube is covered by the filter (by constr.) which separates the lighter liquid from the heavier, it follows that, if the tube be immersed to the bottom of the vessel, the lighter liquid alone which is mixed with the heavier ought to rise through the filter into the tube, and that, too, higher than the surface of the surrounding liquid (by Hyp. 2), so that AC:EF = 2L:G+L; but since (by constr.) AC:EF > 2L:G+L it necessarily follows (by Hyp. 3) that the lighter liquid will flow over by the orifice E into the vessel below, and there will meet the heavier and be again mixed with it; and it will then penetrate the filter, again ascend the tube, and be a second time driven through the upper orifice. Thus, therefore, will the flow be continued for ever. Q. E. D.

He then proceeds to apply this theory to explain the perpetual rise of water to the mountains, and its flow in rivers to the sea, which others had falsely attributed to capillary action,—his idea being that it was an effect of the different densities of salt and fresh water.

One really is at a loss with Bernoulli's wonderful theory, whether to admire most the conscientious statement of the hypothesis, the prim logic of the demonstration, so carefully cut according to the pattern of the ancients, or the weighty superstructure built on so frail a foundation. Most of our perpetual motions were clearly the result of too little learning; surely this one was the product of too much.

(G. CH.)

PERPIGNAN (Spanish, Perpiñan), the ancient capital of Roussillon, and now the chief town of the department of Pyrénées Orientales, France, and a first-class fortress,

stands about 66 feet above sea-level, on the right bank of the Tet, 7 miles above the point where it falls into the Mediterranean. The streets of Perpignan are narrow and crooked, and the houses have no architectural pretensions. The cathedral of St Jean, in the Third Pointed style, was commenced in 1324 by the bishop of Elne, and carried on by Sancho II., king of Majorca. The chancel, built when Louis XI. was master of Roussillon, bears the arms of France. The nave is 259 feet long, 64 wide, and 89 high. The most noteworthy feature in the building is an immense reredos of white marble, begun in 1618 by Bartholomew Soler of Barcelona. The tomb of Louis de Montmor, first French bishop of Elne after the annexation of Roussillon to France, is also worthy of notice; the black marble sarcophagus is supported by four white marble lions, and surmounted by the recumbent figure of the bishop. The bede-tower, built over a small Romanesque chapel, is crowned by an iron cage which dates from 1742. The Place de la Loge, which derives its name from the Spanish word *lonja* (market or bazaar), was built in 1396 in a Pointed style suggestive of the Moorish, and was in-

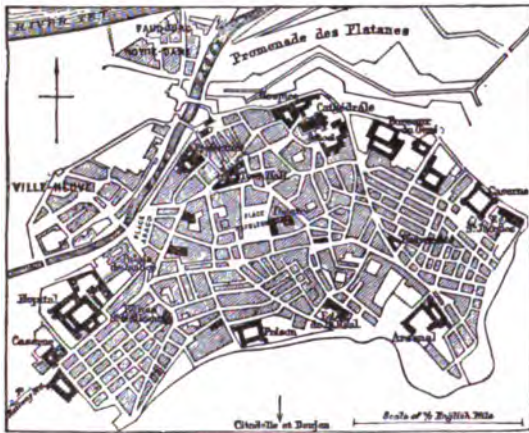

Plan of Perpignan.

tended for a cloth-exchange. The gate-house adjoining the Narbonne road, built in the time of Louis XI., has elegant turrets. The fortifications of the citadel, which is large enough to contain 2000 men, are of various times. The kings of Majorca had a castle on the terrace commanding the town, of which all that now remains is the keep. The chapel is remarkable as being a mixture of the Romanesque, Pointed, and Moorish styles; the top of its tower commands a view of the whole plain of Roussillon, with its flourishing market-gardens and vineyards, overhung on the south-west by Mount Canigou, and bounded by the Corbières on the north, the Albères on the south, and the Mediterranean on the east. The ramparts surrounding the citadel are the work of Louis XI., Charles V., and Vauban. The sculptures and caryatides still to be seen on the gateway were placed there by the duke of Alva. Perpignan was the seat of a university founded by the kings of Aragon, and the town still possesses an interesting museum of sculptures and pictures, where are to be seen the first photographic proofs produced by Daguerre, a natural history collection, and a library containing 30,000 volumes. In one of the squares of the town is the statue of Arago, unveiled in 1879. The manufactures of Perpignan are cloth-making, cork-cutting, tanning, and cooperage, and it has a large trade in wine, brandy, honey, fine wool, fruit, and vegetables. The population in 1881 was 31,735.

Perpignan had its origin in a Benedictine monastery, and its name first appears in charters of the 10th century. The place had

already grown into a town when Philip the Bold, king of France, died there in 1285, as he was returning from an unsuccessful expedition into Aragon. At that time it belonged to the kingdom of Majorca, which was created in 1262, and its sovereigns resided there until, in 1344, that small state reverted to the possession of the kings of Aragon. When Louis XI. occupied Roussillon as security for money advanced by him to the king of Aragon, Perpignan resisted the French arms for a considerable time, and only yielded through stress of famine (15th March 1475). Roussillon was restored to Aragon by Charles VIII., and Perpignan was again besieged in 1542 by Francis I., but without success. Later on, however, the inhabitants, angered by the tyranny and cruelty of the Spanish governor, surrendered the town to Louis XIII. The citadel held out until the 9th of September 1642, and the place has ever since belonged to France, to which it was formally ceded by the treaty of the Pyrenees.

PERRAULT, CHARLES (1628-1703), the most prominent author of France in a specially French kind of literature—the fairy tale—and one of the chief actors in the famous literary quarrel of ancients and moderns, was born at Paris on 12th January 1628. His father, Pierre Perrault, was a barrister, all whose four sons were men of some distinction,—Claude, the second, who was first a physician and then an architect, being the best known next to Charles the youngest. The latter was brought up at the Collège de Beauvais, until he chose to quarrel with his masters, after which (an incident rather rare at the time when patriarchal government of families was in full fashion) he was allowed to follow his own bent in the way of study. He took his degree of "licencié en droit" at Orleans in 1651, and was almost immediately called to the Paris bar, where, however, he practised for a very short time. In 1654 his father bought himself the post of receiver-general at Paris, and made Charles his clerk. After nearly ten years of this employment he was, in 1663, chosen by Colbert as his secretary in a curious and not easily describable office. Put shortly, Perrault's duties were to assist and advise the minister in matters relating to the arts and sciences, not forgetting literature. The protection of Colbert procured a place in the Académie Française for his protégé in 1671, and Perrault justified his election in several ways. One was the orderly arrangement of the business affairs of the Academy, another was the suggestion of the custom (which more than anything else has given the institution a hold on the French public) of holding public *séances* for the reception of candidates. Colbert's death in 1683 put an end to Perrault's official career, but even before that event he had experienced the morose and ungenerous temper which was the great drawback of that very capable statesman. He now gave himself up to literature, in which, like most men of his time, he had made some experiments already. The famous dispute of ancients and moderns is said to have arisen in consequence of some words used by Perrault in one of the regular academic discourses, on which Boileau, with his usual rudeness, commented in violent terms. Perrault, though a very good-natured man, had ideas and a will of his own, and the *Parallèle des Anciens et des Modernes*, which appeared between 1688 and 1696, was the result. The well-known controversy that followed in its train raged hotly in France, passed thence to England, and in the days of La Motte and Fénelon broke out again in the country of its origin. As far as Perrault is concerned, he was inferior to his adversaries in learning, but decidedly superior to them in wit. It is not known what, except the general popularity of the fairy tale in the last decade of the century, drew Perrault to the composition of the only works of his which are still read. The first of them, *Grisélidis*, which is in verse, appeared in 1691, *Peau d'Âne* and *Les Souhaits Ridicules*, also in verse, in 1694. But Perrault was no poet, and the merit of these pieces is entirely obscured by that of the prose tales, *La Belle au Bois Dormant*, *Petit Chaperon Rouge*, *La Barbe Bleue*, *La*

*Chat Botté, Les Fées, Cendrillon, Riquet à la Houppe*, which, after being published in a miscellany during 1696 and 1697, appeared in a volume with the last-named year on the title-page, and with the general title of *Histoires des Temps Passés*. No criticism of these famous productions is necessary, and it is scarcely less superfluous to observe that Perrault has no claim to the invention of the subjects. His merit is that he has treated them with a literary skill in adapting style to matter which cannot possibly be exceeded. Of his other work some *Mémoires* and academic *Éloges* need alone be mentioned. He died on 16th May 1703.

Except the tales, Perrault's works have not recently been reprinted. Of the tales the best recent editions are those of Giraud (Lyons, 1865) and Lefèvre (Paris, 1875).

PERRONE, GIOVANNI (1794-1876), Roman Catholic theologian, was born at Chieri (Piedmont) in 1794, studied theology at Turin, and in his twenty-first year went to Rome, where he joined the Society of Jesus, and, after his ordination to the priesthood, became a teacher in the Collegium Romanum. From Ferrara, where he was rector of the Jesuit college after 1830, he returned to his teaching work in Rome, being made head of his old college in 1850. He died on 26th August 1876. He was the author of numerous dogmatic works, which, as clearly and faithfully reflecting the prevailing tendencies of Roman theology, obtained wide currency and were extensively translated. They may still be regarded as representing most nearly the modern orthodoxy of his church. The *Prælectiones Theologicae* may be specially named (1st ed. 1835, 31st ed. 1866).

PERRY, an alcoholic beverage, obtained by the fermentation of the juice of pears. The manufacture is in all essentials identical with that of CIDER (*q.v.*), though there are some variations in detail arising from the more abundant mucilage of the pear. The clearest and most concise account of making cider and perry is contained in the fourth part of the *Herefordshire Pomona* for 1881 (p. 133 *sq.*). The fruits are either taken at once to the crushing mill or allowed, like apples, to remain in heaps so as to ripen uniformly; they are then crushed between rollers of granite or millstone grit, and the must or juice poured into casks. In making the better kinds of perry only the best sorts of pears are used without admixture; but for ordinary purposes pears of various kinds are mixed indiscriminately, although, as in the case of the apple, the fruits used for the manufacture of perry are not those which are the most suitable for dessert. It is considered better not to crush the pips, as the flavour of the perry is thereby deteriorated. The most scrupulous cleanliness is absolutely requisite, and all the metal-work of the machinery should be sedulously kept bright, otherwise the acids of the juice dissolve the oxides, and, in the case of lead, produce poisonous salts. Pear-juice contains grape-sugar, tannic, malic, and tartaric acids, albumen, lime, pectin, mucilage, and other ingredients. The quantity of potash and phosphoric acid in the juice is relatively large. At a temperature ranging from 50° to 80° the juice undergoes natural fermentation without the addition of yeast. This fermentation, however, is brought about by the agency of a "ferment" (saccharomyces), which feeds on the grape-sugar of the juice, decomposing it, and causing the rearrangement of its constituents in the form of alcohol, carbonic-acid gas, glycerin, &c. The saccharomyces ferments in the first instance absorb oxygen and liberate carbonic acid, as in the process of respiration, but the air of the fluid in which they live speedily becomes exhausted of its oxygen, and then the ferments obtain further supplies from the glucose, in effecting the decomposition of which they set free more oxygen than they require, and this,

uniting with the hydrogen and the carbon, forms the products of fermentation.

In practice the pulp is removed from the mill and placed in open vats for forty-eight hours or longer. Gentle fermentation sets in, as shown by the formation of froth and bubbles of carbonic-acid gas. The pulp is then placed in layers separated by hair-cloths, which act as sieves or filters when the mass is placed in a press like a cheese-press. The pressure is gradual at first and afterwards increased. The juice or must is poured into hogsheads, leaving an unfilled space as "ullage." The hogsheads are placed in a cool cellar, when fermentation begins as above explained, and a thick scum forms on the surface called the "upper lees." At the same time mucilage and ferment-cells with the more solid particles sink to the bottom and form the "lower lees" at the bottom of the barrel. When the fermentation has subsided the liquor between the upper and lower lees should be bright, but in the case of perry, owing to the large quantity of mucilage, the juice has to be filtered through filters of Forfar linen,—a tedious process. The clear liquor is now racked off into clean casks, not quite filled, but leaving space for "ullage," and kept uncorked at a low temperature. A better practice is to close the cask with a bung, through which a curved siphon-like tube is passed, one end of it being in the "ullage" and the portion of it outside the cask being bent downwards and then upwards; then either the bend of the tube may be filled with one or two tablespoonfuls of water, or the outer end of the bent tube may be plunged in a cup of water,—the object in all cases being to provide for the escape of gas from the cask and to prevent the passage of air into it. In a week or so the fermentation ceases or nearly so, the liquor becomes clear and quiet, when isinglass is added in the proportion of one ounce to a hogshead of 100 to 115 gallons. (In Devonshire, the hogshead contains uniformly fifty gallons.) In January or February the bungs are driven in firmly. While fermentation is going on, a temperature of 50° to 70° is most propitious, but after the liquor has been racked off it should be kept in a uniformly cool cellar as near to 40° Fahr. as can be done. When it is desirable to restrain over-violent or hasty fermentation, sulphur or salicylic acid is employed. The latter, being the simpler and cleaner, is the better agent to be adopted. An ounce or an ounce and a half to a hundred gallons should be poured into the fermenting liquor immediately after it has been racked. It is very effectual, and leaves no sensible effects on the liquor if carefully used, being tasteless and free from smell. Great care should be taken, however, not to allow the acid to come into contact with any metal such as iron, or a black colour will result. Perry contains about 7 per cent. of alcohol, and will keep in casks if well made for three or four years, or longer if in bottle. It does not, however, travel well.

PERSEPHONE. See PROSERPINE.

PERSEPOLIS. In the interior of Persia proper, some 40 miles north-east of Shiráz, and not far from where the small river Pulwár flows into the Kur (Kyrus), there is a large terrace with its east side leaning on Kúhi Rahmet ("the Mount of Grace"). The other three sides are formed by a retaining wall, varying in height with the slope of the ground from 14 to 41 feet; and on the west side a magnificent double stair, of very easy steps, leads to the top. On this terrace, which is not perfectly level, stand and lie the ruins of a number of colossal buildings, all constructed of exquisite dark-grey marble from the adjacent mountain. The stones were laid without mortar, and many of them are still *in situ*, although the iron clamps by which they were fastened together have been stolen or destroyed by rust. The mason-work is excellent, and the



style of the lofty palaces, colonnades, and vestibules most imposing. Especially striking are the huge pillars, of which a number still stand erect. No traveller can escape the spell of these majestic ruins.<sup>1</sup> It is impossible to give a minute account of them here; the reader must refer to the numerous descriptions and illustrations in the works of ancient and modern travellers.<sup>2</sup> It is to be observed that several of the buildings were never finished. Stolze has shown that in some cases even the mason's rubbish has not been removed, and remarks accordingly that in those early times, just as at the present day, an Oriental prince would rather commence a new building of his own than complete the unfinished work of his predecessor.

These ruins, for which the name *Chihil menâr* or "the forty minarets"<sup>3</sup> can be traced back to the 13th century,<sup>4</sup> are now known as *Takhti Jamahid*, "the throne of Jamahid" (a mythical king). That they represent the Persepolis captured and partly destroyed by Alexander the Great has been beyond dispute, at least since the time of Pietro della Valle.<sup>5</sup> Amongst the earlier scholars the fanciful notions of the Persians, who are utterly ignorant of the real history of their country before Alexander, often received too much attention; hence many of them were of opinion that the buildings were of much higher antiquity than the time of Cyrus; and even those who rightly regarded them as the works of the Achæmenians were unable to support their theory by conclusive evidence.<sup>6</sup> The decipherment of the cuneiform Persian inscriptions found on the ruins and in the neighbourhood has put an end to all doubt on this point. We now read with absolute certainty that some of the edifices are the work of Darius I., Xerxes, and Artaxerxes III. (Ochus), and with equal certainty we may conclude that all the others were built under the Achæmenian dynasty.

Behind Takhti Jamahid are three sepulchres hewn out of the rock in the hillside, the façades, one of which is incomplete, being richly ornamented with reliefs. About 8 miles to the north-north-east, on the opposite side of the Pulwâr, rises a perpendicular wall of rock, in which four similar tombs are cut, at a considerable height from the bottom of the valley. The modern Persians call this place *Nakshi Rustam* ("the picture of Rustam") from the Sasanian reliefs beneath the opening, which they take to be a representation of the mythical hero Rustam. That the occupants of these seven tombs were kings might be inferred from the sculptures, and one of those at Nakshi Rustam is expressly declared in its inscription to be the tomb of the great Darius, concerning whom Ctesias relates

that his grave was in the face of a rock, and could be reached only by means of an apparatus of ropes. Ctesias mentions further, with regard to a number of Persian kings, either that their remains were brought ἐκ Πέρσας, "to the Persians," or that they died there.<sup>7</sup> Now we know that Cyrus was buried at Pasargade, the modern Murgâb, two days' journey north-east from Persepolis,<sup>8</sup> and if there is any truth in the statement that the body of Cambyses was brought home "to the Persians" his burying-place must be sought somewhere beside that of his father. In order to identify the graves of Persepolis we must bear in mind that Ctesias assumes that it was the custom for a king to prepare his own tomb during his lifetime. Hence the kings buried at Nakahi Rustam are probably, besides Darius, Xerxes I., Artaxerxes I., and Darius II. Xerxes II., who reigned for a very short time, could scarcely have obtained so splendid a monument, and still less could the usurper Sogdianus. The two completed graves behind Takhti Jamahid would then belong to Artaxerxes II. and Artaxerxes III. The unfinished one is perhaps that of Arses, who reigned at the longest two years, or, if not his, then that of Darius III. (Codomannus), who is one of those whose bodies are said to have been brought "to the Persians."<sup>9</sup>

Another small group of ruins in the same style is found at the village of Hâjî Âbâd, on the Pulwâr, a good hour's walk above Takhti Jamahid. These formed a single building, which was still intact 900 years ago, and was used as the mosque of the then existing city of Ištakâr. For there is no other place that can have answered to the description of the eminent geographer Makdisi, who was himself in this neighbourhood, when he says: "The chief mosque (*ǰams'*) of Ištakhr is situated beside the bazaars. It is built after the fashion of the principal mosques in Syria,<sup>10</sup> with round pillars. On the top of each pillar is a cow.<sup>11</sup> Formerly it is said to have been a fire-temple. The bazaars surround it on three sides" (p. 436).

In the time of its greatest prosperity the Persian metropolis must undoubtedly have covered a great part of the extremely fertile valley of the Pulwâr. It is not at all necessary to suppose that its limits are determined by the two heaps of ruins. The great bulk of the houses would, of course, be built in the wretched manner which is all but universal in the East.

Since Cyrus was buried in Pasargade, which moreover is mentioned in Ctesias as his own city,<sup>12</sup> and since, to judge from the inscriptions, the buildings at Persepolis commenced with Darius I., it was probably under this king, with whom the sceptre passed to a new branch of the royal house, that Persepolis became the capital.<sup>13</sup> At least it is probable that the great city, in the original home of the dynasty, with its lordly palaces and royal sepulchres, was theoretically considered the metropolis of the whole empire. But certainly, as a residence for the rulers of such extensive territories, a remote place in a

<sup>1</sup> See the description of Mas'ûdi (ed. Barbier de Meynard, iv. 76 *sq.*), written 944 A. D.; and that of Makdisi (Mokaddas, ed. De Goeje, p. 444), written forty years later.

<sup>2</sup> See especially Charlin, Kœmpfer, Niebuhr, and Ouseley. Niebuhr's drawings, though good, are, for the purposes of the architectural student, inferior to the great work of Texier, and still far more to that of Flindin and Coste. Good sketches, chiefly after Flindin, are given by Kossowicz, *Inscriptiones palæo-persicæ*, St Petersburg, 1872. In addition to these we have now the photographic plates in Stolze's *Persepolis* (2 vols., Berlin, 1882). Stolze's "photogrammetric" plan surpasses all previous attempts in accuracy. The numerous reliefs found in this group of ruins (especially on the great double stair), executed in a very remarkable style of art, were first brought within the scope of accurate examination by these works, since, with some individual exceptions (as in Ouseley), the drawings of the figures in the older works were quite inadequate.

<sup>3</sup> Neither "the forty towers" nor "the forty pillars" is a correct rendering of the expression. The round pillars with their heavy capitals have a much closer resemblance to the turrets of the Mohammedan mosques than to our church towers. An older name for all the splendid ruins through the Pulwâr valley is *hasâr-e sulṭān*, "the thousand pillars" (Haruzi *isp.*, ed. Gottwaldt, p. 38). A thousand is, of course, like forty, a round number.

<sup>4</sup> Sir W. Ouseley, *Travels*, ii. 369.

<sup>5</sup> Letter x. (ed. Brighton, 1843, ii. 246 *sq.*).

<sup>6</sup> See the discussion of this question in Ouseley.

<sup>7</sup> This statement is not made in Ctesias (or rather in the extracts of Photius) about Darius II., which is probably accidental; in the case of Sogdianus (Sekydianus), who as a usurper was not deemed worthy of honourable burial, there is good reason for the omission.

<sup>8</sup> See art. PERSIA (p. 567 below). The complete proof will be found in Stolze's work already mentioned, and in his paper cited below.

<sup>9</sup> Arrian, iii. 22, 1.

<sup>10</sup> This refers only to its solidity and magnificence, and perhaps also to some of its minor features, but not to its general style. These Moslems had no great discernment in matters of style. For instance, Makdisi and others compare the ruins of Takhti Jamahid to those of Palmyra and Bealbek.

<sup>11</sup> Capitals formed of recumbent animal figures are peculiar to the buildings of the Achæmenians.

<sup>12</sup> Cf. also in particular, Plutarch, *Artax.*, iii., where Pasargade is distinctly looked on as the sacred cradle of the dynasty.

<sup>13</sup> The story of *Ælian* (*H. A.*, i. 59), who makes Cyrus build his royal palace in Persepolis, deserves no attention.

difficult alpine region was far from convenient. The practical capitals were Susa, Babylon, and Ecbatana.

This, at the same time, accounts for the fact that the Greeks were not really acquainted with the city until it was taken by Alexander.<sup>1</sup> Ctesias must certainly have known of it, and it is possible that he may have named it simply Πέρσας,<sup>2</sup> after the people, as is undoubtedly done by certain writers of a somewhat later date.<sup>3</sup> But whether the city really bore the name of the people and the country is another question. And it is extremely hazardous to assume, with Sir H. Rawlinson and Oppert, that the words *and Ébrâs*, "in this Persia," which occur in an inscription on the gateway built by Xerxes (D. lin. 14), signify "in this city of Pârsâ," and consequently prove that the name of the city is identical with the name of the country.

The name Persepolis appears to have been first used by Clitarchus, one of the earliest, but unfortunately one of the most imaginative annalists of the exploits of Alexander. The word was no doubt meant to allude to the "Persians," but apparently he preferred this extraordinary form<sup>4</sup> to the regular "Persopolis"<sup>5</sup> for the sake of a play on the destruction (πέρις) which he relates. Later writers have followed him in the use of the name Persepolis.<sup>6</sup> For information about the capture and treatment of the city by Alexander we are almost entirely dependent on narratives which are based on Clitarchus, since Arrian unfortunately disposes of this episode in a very summary fashion. The course of events may be traced somewhat as follows.

Alexander, having crushed the resistance of the Persian army under Ariobarzanes at the "Persian Gates,"<sup>7</sup> marched rapidly on the capital. Ariobarzanes had made his way thither with a few followers, but was refused admission by Tiridates, the commandant of the citadel, who had already commenced negotiations with Alexander, and at last surrendered the place with its immense treasures to the conqueror. In a subsequent battle Ariobarzanes was killed.<sup>8</sup> Alexander then ordered a general massacre, and gave up the city to be plundered. In the citadel he placed a garrison of 3000 men under Nicarchides,<sup>9</sup> and then caused

<sup>1</sup> Eechylus, whose knowledge of the world is certainly not very extensive, takes the "city of the Persians" to be Susa. Cf. especially *Pers.*, v. 15 with v. 761 (*πόλις ἑρρα Ζοδωρα*). Herodotus does not mention the capital of Persia at all.

<sup>2</sup> The only expression that could be interpreted in this sense is *ἡ Πέρσας*, "to the Persians." But perhaps *ἡ Πέρσας*, with him, means only "to the land of Persia." No doubt, when he says that the body of Cyrus was conveyed *ἑς Πέρσας*, this might be explained on the supposition that he wrongly imagined that Cyrus was buried in Persepolis. Xenophon, who knew of Pasargadae from Ctesias, calls it *Πέρσας* (*Cyr.*, viii. 5, 21); but, as he was not acquainted with the country, this goes for nothing. Of more importance is the fact that Plutarch, *Artax.*, iii. (probably after Dinon), places Pasargadae *ἑς Πέρσας*, where the expression applies to the country and not to the city.

<sup>3</sup> So undoubtedly Arrian (iii. 18, 1, 10), or rather his best authority, King Ptolemy. So, again, the Babylonian Berossus, shortly after Alexander. See Clemens Alex., *Admon. ad gentes*, c. 5, where, with Georg Hoffmann (*Pers. Märtyrer*, 187), *καὶ* is to be inserted before *Πέρσας*, and this is to be understood as the name of the metropolis.

<sup>4</sup> *Περσέπολις* means strictly "city-destroying." *Περσείπολις*, a well-authenticated reading in Strabo and *Ælian* (l. c.), is no improvement.

<sup>5</sup> This form is actually restored by later scholars, and seems to have been used by the geographer Ptolemy (vi. 4).

<sup>6</sup> Besides the historians who draw upon Clitarchus (Diodorus, Curtius, Justin, Plutarch in *Alexander*), Strabo (79 sq., 727 sq.), Pliny (vi. 115, 218), and several others. Justin (l. 6, 2) introduces the name *Persepolis* in an account which is based on Ctesias, just as Arrian (vii. 1, 1) once employs it, although he can scarcely have got it from his excellent sources.

<sup>7</sup> On this locality, see the paper of Fr. Stolze in the *Verhandlungen der Gesellschaft für Erdkunde in Berlin*, 1883, Nos. 3 and 6.

<sup>8</sup> This is mentioned by Curtius only, but it has great intrinsic probability. The massacre at the taking of the city appears to be confirmed by Plutarch (*Alex.*, 37) from the letters of the king.

<sup>9</sup> This again is only found in Curtius. Alexander was in the heart of a country which he had laid waste, but by no means thoroughly subdued, which hated him bitterly, and which was the native land of the dynasty; he was amongst a people who still felt themselves to be

the royal palaces to be set on fire,—certainly not in a drunken freak, but apparently with deliberate calculation on the effect it would produce on the minds of the Asiatics.<sup>10</sup>

Now it has hitherto been universally admitted that "the palaces" or "the palace" (*τὰ βασιλῆα*) burned down by Alexander are those now in ruins at Takhti Jamahid, as already described. From Stolze's investigations it appears that at least one of these, the castle built by Xerxes, bears evident traces of having been destroyed by fire.<sup>11</sup> The locality described by Diodorus after Clitarchus corresponds in important particulars with Takhti Jamahid, for example, in being supported by the mountain on the east.<sup>12</sup> And, if there are other details, such as the triple wall, which it is difficult to reconcile with the existing state of things, we must bear in mind on the one hand the great destruction that must have been wrought in the course of thousands of years, and on the other that small inaccuracies are not to be wondered at in a writer like Clitarchus, who is constantly straining after effect. There is, however, one formidable difficulty. Diodorus says that the rock at the back of the palace containing the royal sepulchres rises so steep that the bodies could be raised to their last resting-place only by mechanical appliances. This is not true of the graves behind Takhti Jamahid, to which, as Stolze expressly observes, one can easily ride up; on the other hand, it is strictly true of the graves at Nakahi Rustam. Stolze has accordingly started the theory that the royal castle of Persepolis stood close by Nakahi Rustam, and has sunk in course of time to shapeless heaps of earth, under which the remains may be concealed. He and Andreas, our highest authorities on the topography of this district,<sup>13</sup> consider this spot peculiarly adapted for the site of a citadel, while the water-supply would suffice for a numerous court-retinue and garrison, and for a royal residence with its palaces and gardens. Nevertheless we are unable to adopt this suggestion. The vast ruins of Takhti Jamahid, and the terrace constructed with so much labour, appear to us of more importance than any number of doubts and conjectures. These remains can hardly be anything else than the ruins of palaces and the other belongings of a kingly residence; as for temples, the Persians had no such thing, at least in the time of Darius and Xerxes. And it can hardly be supposed that such solid structures were much more numerous in former times, and that these alone have survived owing to their peculiar situation on the terrace. For, in the first place, it is evident at a glance that the situation itself is of an exceptional kind. Moreover, Persian tradition at a very remote period knew of only three architectural wonders in that region, which it attributed to the fabulous queen Humâi (*Khumâi*)—the grave of Cyrus at Murgâb, the building at Hâjî âbâd, and those on the great terrace.<sup>14</sup> It is safest therefore to identify these last with the royal palaces destroyed by Alexander. Clitarchus, who can scarcely have visited the place himself, has simply, with his usual

the dominant race, and knew that their king was still alive. That in these circumstances he should have a strong garrison under a trustworthy Macedonian was simply a matter of course. Nicarchides afterwards commanded a trireme in the fleet that sailed from the Indus to the Tigris (Arrian, *Indica*, xix. 5; after Nearchus).

<sup>10</sup> See art. PERSIA (p. 583 below).

<sup>11</sup> Dr Stolze has kindly explained to the writer of this article that the layer of charcoal in the "hall of a hundred pillars" is apparently the result not of a conflagration but of gradual decomposition.

<sup>12</sup> The name of this mountain too, *βασιλικὸν ὄρος*, is identical with *Šâhâhâ*, which is at least tolerably well established by Ouseley (ii. 417) as a synonym of *Kâhî rahmet*.

<sup>13</sup> We are here again indebted to private communications from Stolze, as well as to his published papers.

<sup>14</sup> See especially Hamza Isp., 88; Tabari, l. 690, 816 (cf. Nöldeke, *Geschichte der Perser . . . aus . . . Tabari*, p. 8). The ruins at Takhti Jamahid are alluded to as the work of Humâi, in connexion with an event which occurred shortly after 200 A.D.

recklessness of statement, confounded the tombs behind the palaces with those of Nakhi Rustam; indeed he appears to imagine that all the royal sepulchres were at the same place. It is possible, however, that the discrepancy originated with Diodorus, who often makes his extracts in a very perfunctory manner.<sup>1</sup>

If it should prove that, after all, the terrace is not large enough to have contained the treasure-houses and the barracks of the garrison, in addition to the palaces, or that Alexander could not have set fire to the latter without endangering the former and the safety of the whole fortress, then we should have to assume that a separate citadel (*ἀκρόπολις*) stood somewhere outside of the terrace with the palaces. There are many positions naturally adapted for defence in the vicinity. But, as far as yet appears, such an assumption is scarcely required. Of course we need not suppose that the number 3000 represents the actual strength of Alexander's garrison; and we must consider that, when Darius, in the height of his power, laid out this place in the heart of his empire, he was thinking more of regal magnificence than of security. A high wall and a guard of 200 men would suffice for the protection of the treasures at a time when battering engines were unknown.

In 316 B.C. Persepolis is still the capital of Persia as a province of the great Macedonian empire (see Diod., 19, 21 *sq.*, 46; probably after Hieronymus of Cardia, who was living about 316). The city must have gradually declined in the course of time; but the ruins of the Achemenians remained as a witness to its ancient glory.

It is probable that the principal town of the country, or at least of the district, was always in this neighbourhood. About 200 A.D. we find there the city Istakhr<sup>2</sup> as the seat of the local governors. There the foundations of the second great Persian empire were laid, and once more there arose round the tombs of the Achemenians what was for centuries the theoretical metropolis of a great monarchy whose administrative capitals lay far to the west. Istakhr acquired special importance as the centre of priestly wisdom and orthodoxy. In its most flourishing days it was probably as large as Persepolis had been, whose ruins undoubtedly furnished much of the material for its houses. The peaceable resident, intent on building his house or hut, has too often proved more destructive to ancient buildings than a foreign invader or even the disintegrating forces of nature. The Sasanian kings have covered the face of the rocks in this neighbourhood, and in part even the Achemenian ruins, with their sculptures and inscriptions, and must themselves have built largely here, although never on the same scale of magnificence as their ancient predecessors. The Romans knew as little about Istakhr as the Greeks had done about Persepolis, and this in spite of the fact that for four hundred years they maintained relations, friendly or hostile, with the empire, while their own sway extended far into the heart of Asia. So remote is Persia!

At the time of the Arabian conquest Istakhr offered a desperate resistance, which was renewed again and again before the place was finally subdued. Blood flowed like water in these struggles for religion and liberty. Nevertheless the city was still a place of considerable importance in the first century of Islam, although its greatness was speedily eclipsed by the new metropolis Shiráz. In the 10th century Istakhr had become an utterly insignificant place, as may be seen from the descriptions of Istakhr, a native (c. 950), and of Makdisi (c. 985). At this time the little town occupied approximately the site assigned to it on Flaudin's map, near the present village of Háji Ábd, surrounding the ruined structure of the Achemenians, and principally on the left side of the stream. During the following centuries Istakhr gradually declined, until, as a city, it ceased to exist. This fruitful region, however, was covered with villages till the frightful devastations of last century; and even now it is, comparatively speaking, well cultivated.

The "castle of Istakhr" played a conspicuous part several times during the Mohammedan period as a strong fortress. It was the middlemost and the highest of the three steep crags which rise from the valley of the Kur, at some distance to the west or north-west of Nakhi Rustam.<sup>3</sup> We learn from Oriental writers that one

<sup>1</sup> Curtius repeatedly confounds the palace with the metropolis (both being *τὰ βασίλειά*), and so speaks of the city being set on fire.

<sup>2</sup> Properly *Stakhr*, as written in Pahlavi; on the coins of the Sasanids "στ" stands as an abbreviation for the name. The Armenians write *Stakhr*. The form with the prosthetic vowel *Istakhr* is New Persian; the Syrians used at a still earlier time the form *Istakhr* or *Istakhr*.

<sup>3</sup> This height is now called, from its situation, *Miyánkala* (middle fortress). Older writers and travellers give other names, the nomenclature of all this part of Persia having greatly altered; but the name "castle" or "hill of Istakhr" appears not to have entirely disappeared.

of the Buwaihid sultans in the 10th century, of the flight constructed the great cisterns, which may yet be seen, and have been visited, amongst others, by James Morier and Flaudin.<sup>4</sup> Ouseley, who has extracted a vast amount of information from Persian authors about the ruins of Persepolis and about Istakhr,<sup>5</sup> points out that this castle was still used in the 16th century, at least as a state prison. But when Della Valle was there in 1621 it was already in ruins. (TH. N.)

PERSEUS, a hero of Grecian fable, son of DANÆ (*g.v.*) and Zeus. When Perseus was grown to manhood Polydectes, the wicked king of Seriphus, cast his eye on Danae; and, that he might rid himself of the son, he exacted of him a promise that he would bring him the head of the Gorgon Medusa. Now the dreadful GORGONS (*g.v.*) dwelt with their sisters the GRÆÆ (the Gray Women) by the great ocean, far away in the west. Guided by Hermes and Athene, Perseus came to the Grææ. They were three hags, with but one eye and one tooth between them, which they handed one to the other. Perseus stole the eye and tooth, and would not restore them till the Grææ had guided him to the Nymphs, from whom he received the winged sandals, the wallet (*κίβιστος*), and the cap of invisibility. These he put on, and, being armed by Hermes with a scimitar (*ἀρμαγήνη*), came upon the Gorgons as they slept and cut off Medusa's head, while with averted eyes he looked at her image on his brazen shield lest he should be turned to stone. Perseus put the Gorgon's head in his wallet and fled. Coming to Æthiopia he delivered and married ANDROMEDA (*g.v.*). With her he returned to Seriphus in time to rescue his mother and Dictys from Polydectes, whom he turned to stone along with all his court by showing them the Gorgon's head. The island itself was turned to stone, and was still and lonely ever after; the very frogs of Seriphus (so ran the proverb) were dumb. Perseus then gave the head of Medusa to Athene, who put it on her shield, and, with Danae and Andromeda, he hastened to Argos to see his grandfather, Acrisius, once more. But he, fearing the oracle, had gone to Larissa in Thessaly. Thither his grandson followed him, but at some games given by Teutamias, king of Larissa, he threw a quoit which lighted on his grandfather's foot and caused his death. Ashamed to return to Argos, Perseus gave his kingdom to Megapenthes, and received from him Tiryns in return. There he reigned and founded Midea and the famed Mycenæ, and became the ancestor of the Perseids, amongst whom were Eurystheus and Heracles.

The legend of Perseus was a favourite theme of Greek poetry and art. Sophocles and Euripides had each several dramas on the subject, and sculptor and painter vied with each other in depicting the rescue of Andromeda from the sea-monster. The story was localised in various places. Italy claimed that the ark with Danae and Perseus had drifted to the Latin coast (Servius on Virg., *Æn.*, vii. 372, and viii. 345). The Persian kings were said to have sprung from a son of Perseus (Apollod., ii. 4, 5; Herod., vii. 61); and, according to Pausanias Damascenus, Perseus taught the Persians to worship fire, and founded the Magian priesthood. The tale of the rescue of Andromeda by Perseus from the sea-beast is akin to that of Heracles and Hesione. Both have been interpreted of the sun slaying the darkness, Andromeda or Hesione being the moon, whom the darkness is about to devour. According to one version Heracles rescued Hesione from the sea-beast by leaping into its mouth, from which he came forth after three days spent in the belly of the beast. This points to a connexion with the Semitic story of Jonah and the fish. Greek sculptures of Andromeda's monster were the models for Jonah's fish in early Christian art, and on a rock at Joppa they showed the chains which had bound Andromeda, and the bones of the sea-beast (Pliny, *H. N.*, v. 13; Meib., l. 11). Tarsus in Cilicia was said to have been founded by Perseus, who appears on coins of the city, as well as on coins of Pontus and Cappadocia.

<sup>4</sup> See the plans and sketches in Flaudin, to whom it was stated that the castle-rock was called *Kalais sarv*, "castle of the cypress," from a solitary cypress growing there. It is unfortunate that for this particular locality the newest map of Haucknecht (Berlin, 1882) is quite unreliable.

<sup>5</sup> These references are still very useful, although we have now the advantage of knowing the extremely valuable Arabian sources of many of his Persian narratives from printed texts.



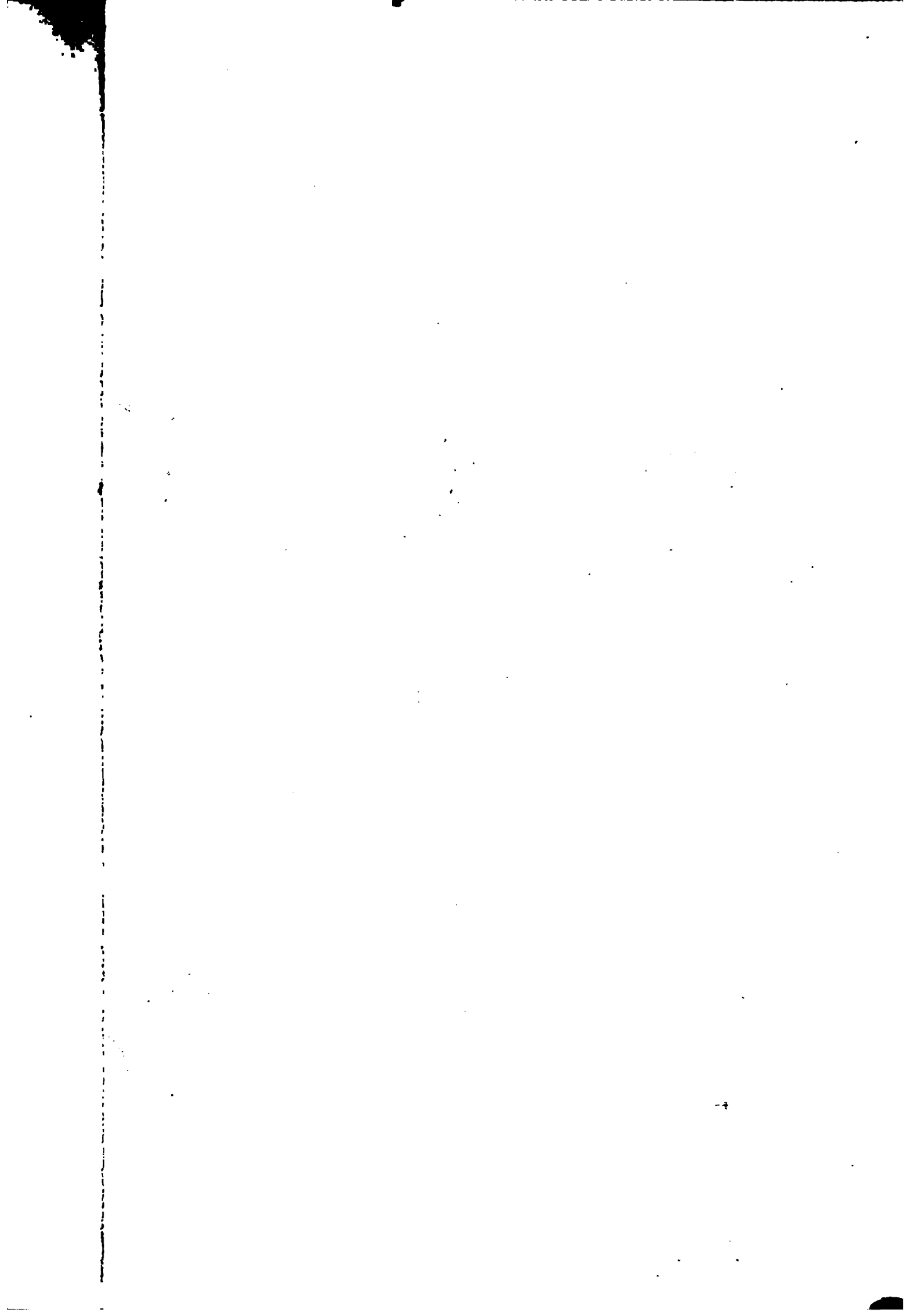

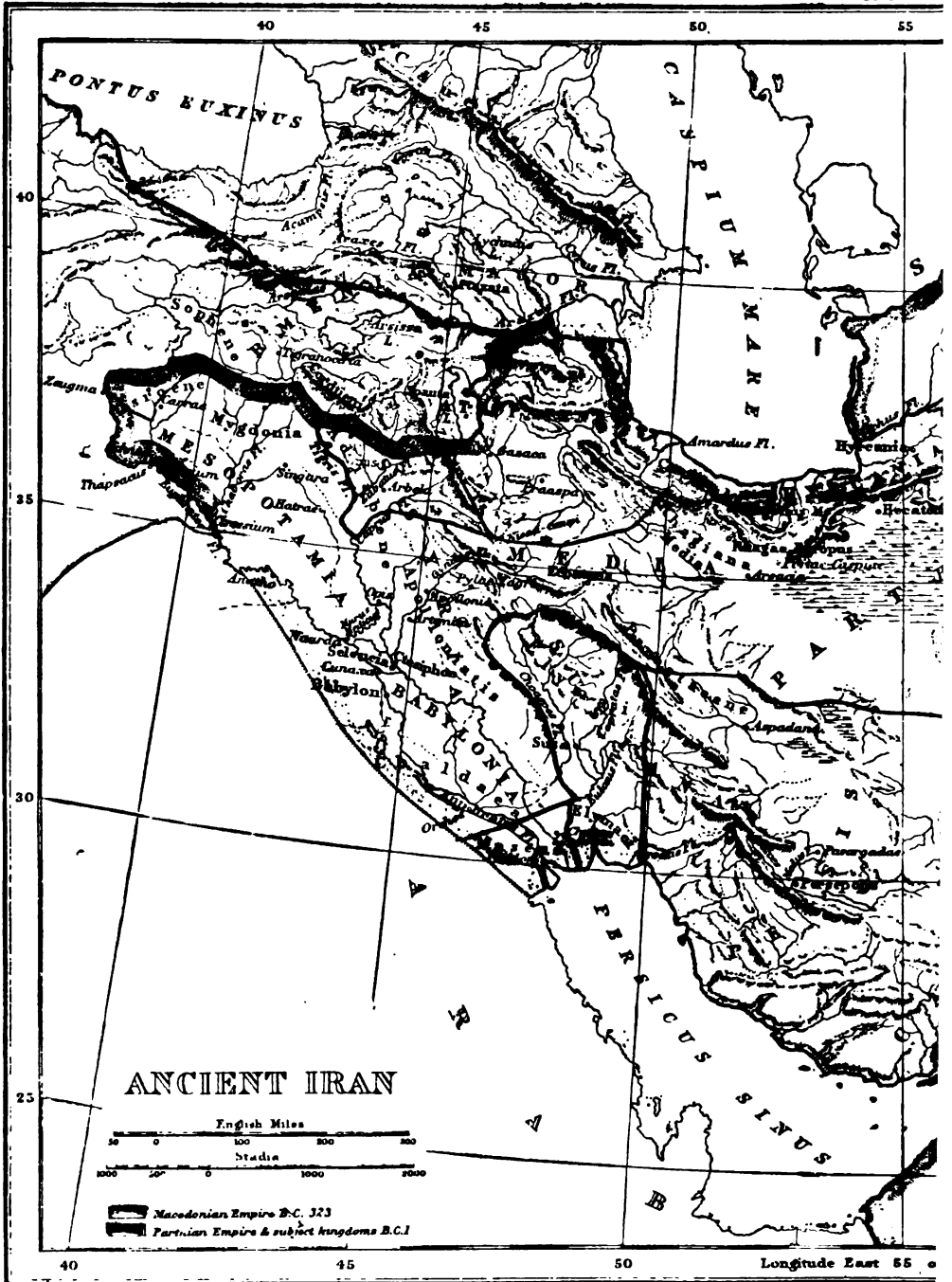

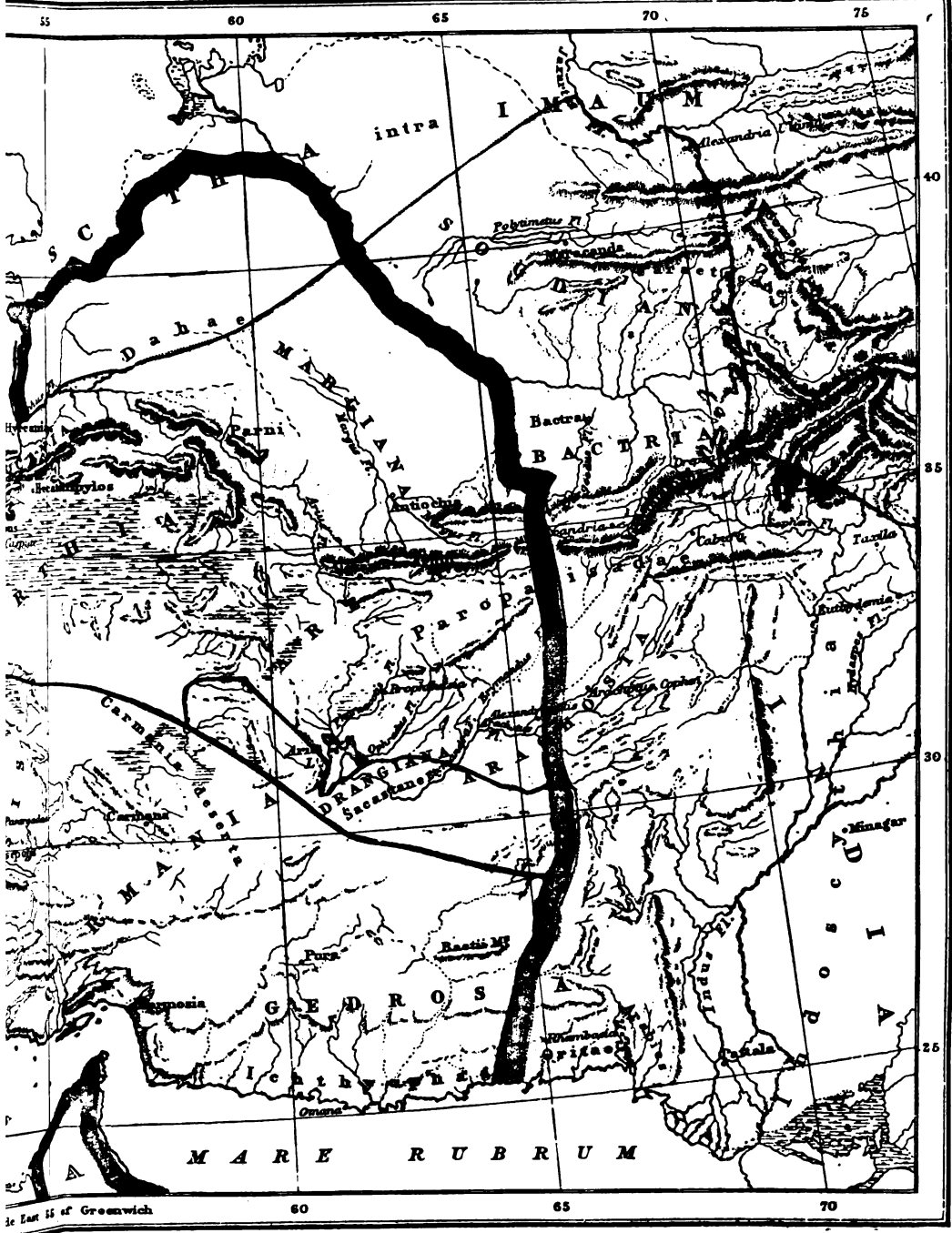

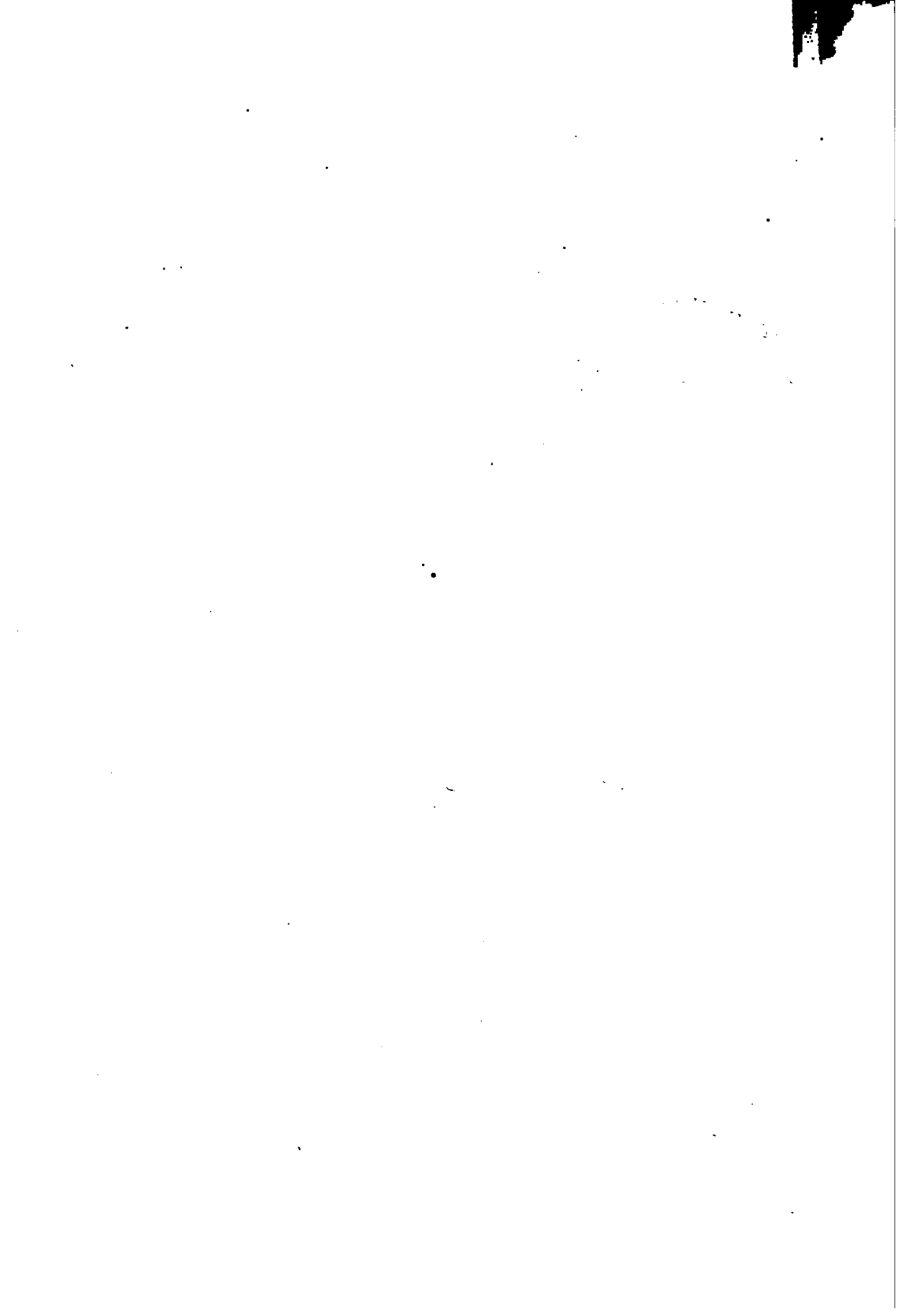

## P E R S I A

**PERSIA**, or **ÍRÁN**. In modern political geography these two terms are synonymous; the kingdom which we call Persia the Persians themselves call Írán. But each of the words has a somewhat complicated history, a brief sketch of which will best explain the connexion between the several subjects which, in an encyclopædic treatment, naturally demand notice under one or other of the names which head this article.

Persia, or rather Persis (Greek exclusively Περσίς), is the Latinized form of a name which originally and strictly designated only the country bounded on the N. by Media and on the N.W. by Susiana, which of old had its capital at Persepolis or Istakhr, and for almost twelve centuries since has had it at Shíráz. This country and its people were anciently called Pársá (now Párs or Fárs). The oldest certain use of the name is in Ezekiel (xxvii. 10, xxxviii. 5). The Greek form Πέρσα, with *θ* for *δ*, which all European languages follow, seems to have come from the Ionians, who disliked to pronounce *δ* even in foreign words. Thus Πέρσα would stand for Πήρσα, which in turn stands to Pársá as Μήσοι to Μίδα.

The name of Persia was naturally extended to the great monarchy of the Achæmenians who came forth from Persis; and so again, when a second great empire, that of the Sásánians, arose from the same land, all its subjects began to be called Persians, and Persis or Persia was sometimes used of the whole Sásánian lands (Ammianus, xxiii. 6, 1). The prevalent language of this empire (see Pahlavi) had a still better right to be called Persian, for it seems to have had its basis in the language of the old Persia. The same thing is true of the so-called New Persian, which has been a literary language for the last thousand years.

Historically, then, the term Persian is fitly applied to the two great empires which rose in Párs or Persis—the form Persis will be used in this restricted sense throughout the present article—and not unfitly to the modern state which embraces Persis and its sister lands, and in which a descendant of the ancient tongue of Persis is still the official and literary language.

The name Írán, on the other hand, was originally of much wider signification than Persia, and the whole upland country from Kurdistan to Afghánistán may, in accordance with the native use of its ancient inhabitants, be called the Iranian upland. The inhabitants of this upland, together with certain tribes of the same race in adjacent lands, shared with their near kinsmen in India the name of Aryans (Ariya, Airya of the *Avesta*; Sk. *Árya*). King Darius calls himself "Persian son of a Persian, Aryan son of an Aryan," and Herodotus (vii. 62) knows *Ἄριοι* as an old name of the Medes. The ancient nobles affected names compounded with *Arya*,—Ariyarámna (*Ἀριαράνης*), Ariobarzanes, and the like. The lands of the Aryans, as a whole, were called Ariyána (Airiya of the *Avesta*); Eratosthenes and after him Strabo and others are certainly wrong in limiting *Ἀριάρη*, *Ἀριάρη*, to eastern Írán (Afghánistán, Baluchistán, &c.).<sup>1</sup>

Ardaahír, the first Sásánian, is called on coins and inscriptions "king of the kings of Érán," his son Shápúr or Sapor is "king of the kings of Érán and not-Érán." Now Ardaahír, as well as his son, had non-Aryan subjects, the main population of Babylonia and other provinces being of Semitic race; Érán and not-Érán therefore must here be used not ethnographically but in a definite politico-geographical sense. The official name of the empire, however, was always Érán, and the great officers of state had such titles as Érán-Spáhpát, "general of Érán," Érán-Anbárakpát, "store-master of Érán."<sup>2</sup>

For the last 500 years most Persians have pronounced Írán instead of Érán (more recently also Írón, Írín), and this is the official title of the kingdom which once had Ispahán, and now has Teherán, as capital. Modern Írán, or Persia, does not embrace nearly the whole Iranian upland, still less all men of Iranian nationality, that is, all who speak an Iranian dialect akin to Persian. On the other hand, the modern kingdom of Írán has many subjects who are not Iranians ethnographically, but come originally from Central Asia or Arabia, and speak Turkish or Arabic.

## PART I.—ANCIENT IRAN.

## SECTION I.—MEDO-PERSIAN EMPIRE.

The Babylonian Berosus, writing soon after Alexander the Great, states that at a very early time, which we must place somewhat over two thousand years before Christ, the Medes conquered Babylonia, and that eight Median kings reigned thereafter in Babylonia for a space of 224 years.<sup>3</sup> This is an early instance of the occupation of the rich lowlands by warlike tribes of the neighbouring highlands; and indeed the contrast between the plain of the Euphrates and Tigris, peopled mainly by Semites, and the tableland of the Iranians, surrounded by lofty mountains, is a very important factor in the whole history of wide regions of Asia. But it is, to say the least, not certain whether Berosus means the Iranian people afterwards called Medes. The expression might have a merely geographical signification, and it is at all events possible that at that distant period tribes of different descent dwelt in the land. In any case, we have here no Iranian empire, but only a Babylonian dynasty founded by foreigners.

Be this as it may, it is certain that at an early period there were regular monarchies of some size even in the distant Iranian lands. Unmistakable traces lead us to

assume an old empire in Bactria—the Iranian land far to the east, in the region of the Oxus, beyond the great tableland—which must have developed a tolerably high civilization. But we have no exact information about it.

The series of the great Iranian monarchies begins for us with the Median empire of Ecbatana. Unfortunately we possess but little trustworthy information about its history, being almost wholly dependent on what two Greeks, Herodotus and Ctesias, who wrote long after the fall of the kingdom, report from the mouths of Orientals. These two authorities differ so widely that their statements are to a great extent mutually exclusive. Nevertheless careful investigation has shown that many of the statements of Ctesias (which are only preserved through the medium of later writers, like Diodorus) rest on the same basis as those of Herodotus. This common basis included an artificially arranged chronology.<sup>4</sup> According to Herod-

<sup>3</sup> Sásánian inscriptions in Chaldaic Pahlavi still show the ancient form *Arián* (𐎠𐎼𐎷𐎡𐎴), and Greek inscriptions of the older kings have the genitive pl. *Ἀριάρηων*. But the corresponding common Pahlavi inscriptions and the coins already show the form *Érán* (𐎠𐎼𐎷𐎡𐎴), following an established law of phonetic decay.

<sup>4</sup> The information is preserved by Eusebius, who took it from Alexander Polyhistor; see Eusebius, *Chronicon*, ed. Schoene, 25.

<sup>5</sup> See Hupfeld, *Excursiones Herodotæ Spec. II.: sive de veteri Medorum regno*, Bielefeld, 1842.

<sup>1</sup> Less careful writers, like Pliay, confuse Ariana with Aria, properly Haris, the land of Haraita, the later Haráv, Hará, Harí; Arabic Harát.

otus the Medes freed themselves from the Assyrians, and lived for a time without a master till Deioeces obtained the kingly power by stratagem. There reigned then

Deioeces 58 years	} 75 years	} 150 years.
Phraortes 22 "		
Cyaxares 40 "	} 75 "	
Astyages 35 "		

The totals show how the figures are arranged on an artificial system. The duration of the kingdom is exactly a century and a half, divided into two exactly equal portions, each of which is occupied by the reigns of two kings. But further, according to Herodotus, the rule of the Medes over Upper Asia, *i.e.*, the land east of the Halys, lasted 128 years, save only (*ἄρα*) the twenty-eight years during which the Scythians ruled. It is easy to see that "save only" means "minus," and that thus the foreign supremacy of the Medes is reckoned at exactly 100 years, or two-thirds of the total duration of the kingdom. Obviously such figures can at most be only approximately correct. Now the number 128 is got by adding the reigns of the first king and the last two. This number is certainly due to an error on the part of Herodotus, who has committed similar mistakes in arithmetic elsewhere; in adding up he took the reign of Deioeces for that of Phraortes. We may conjecture that the original statement received by Herodotus was that the supremacy, represented by the last three reigns, lasted a century, a round number being put for 97 (22 + 40 + 35). With regard to the individual items, it is somewhat suspicious that the second half (75 years) is divided into its two most convenient fractions, 40 and 35. Consequently we cannot place much reliance on the figures representing the reigns of the first two rulers either, especially as it can be made probable that they also rest on an artificial basis.

Now it can be proved that Ctesias's list of nine or properly ten kings was based on that of Herodotus, but with all the numbers doubled. Probably this list of Ctesias assigned 350 years as the total duration of the empire, which is the number given in Justin, i. 6, 17. The Mede from whom Ctesias derived his information, or the Median source on which his informant drew (there is no mistaking the Median colouring which pervades Ctesias's narrative), wished to glorify the empire of his people by the length of its duration, hence the doubling. The source from which the names of the Median kings in Ctesias are derived is still a mystery; they are quite different from those of Herodotus. Even Oppert's hypothesis, that the names of the last four kings in Ctesias are the Iranian translation of the non-Iranian names in Herodotus and belong to the language of the second kind of cuneiform writing, though perhaps plausible at first sight, is on close examination untenable. In general there is no warrant for the assumption that as late as the time of the Median and Persian empires there was a large non-Iranian population in Media,—an assumption which conflicts with all tradition and originates solely in the difficulty of finding a home for the second kind of cuneiform writing. But the names of the kings in Herodotus are now all authenticated, directly or indirectly, by the inscriptions lately discovered. Probably too the reckoning of the total duration of the empire at a century and a half is about right. Indeed such chronological systems sometimes correspond better, on the whole, with the facts than their artificiality would lead us to expect.

Ctesias's narrative opens with a nighly-coloured description of a real event, namely, the destruction of Nineveh by the leader of the Medes, called by him Arbaces, with the help of the Babylonian Belshazzar (the historical Nabopolassar). But the fact that by this event the position of Media as a great power was for the first time assured is mixed up by

Ctesias with the beginning of the monarchy itself. In addition, he grossly exaggerates the duration of the empire; so that we arrive at the monstrous result that between 606 or 607, the real date of the destruction of Nineveh, and 550, the year of the fall of the Median supremacy, more than 300 years are supposed to have elapsed.

Down to the destruction of Nineveh we must ignore Ctesias almost completely and follow Herodotus alone.

We will not repeat Herodotus's naïve story of the foundation of the Median kingdom by Deioeces, son of Phraortes, a story in which Greek and Oriental colours are charmingly blended. We may assume as certain that Deioeces possessed a principality, the central point of which was Ecbatana (or Agbatana; Old Persian *Hagmatāna*, now Hamadān), a place which for thousands of years has held the rank of a capital. This principality probably never embraced the whole of Media (*i.e.*, nearly the present provinces of Irak Adjemi and Azerbājan with a portion of Turkish Kurdistan), but by his successors it was enlarged into the great Median empire. Of course there was no smooth and formal constitution, no fixed frontier, no exact determination of the prerogatives of different chiefs in the particular districts. From of old the Assyrians had made frequent attempts to subjugate the country of the Medes, but perhaps never quite possessed the whole land with its numerous inaccessible mountains and warlike robber tribes. Nevertheless they made successful expeditions into the interior of Media even down to the time at which Herodotus regards Media as independent.<sup>1</sup> Neither the liberation of Media nor the foundation of the monarchy is an event which can be limited to a particular year, the thing took place gradually. In the period not long before Deioeces, according to Herodotus's reckoning, very many tributary Median chieftains are mentioned in the Assyrian inscriptions; this confirms, in some measure at least, the statement that "anarchy" then prevailed.<sup>2</sup> In 715 B.C. there was carried off as prisoner one Dajaukku; this is certainly the same name, perhaps the same person (for his captivity may have been brief), as Dāiōkka, which appears in Herodotus in the Ionic form Dēiōkka. We can certainly identify Herodotus's first king with the prince whose land, called Bit Dajaukku, *i.e.*, land of Dajaukku, King Sargon of Assyria conquered in 713 B.C. The man who thus gave his name to the land must have occupied a high station. The date is not very remote from that assigned by Herodotus to Deioeces; for we get from Herodotus as the date of Deioeces 709-656, or, if we correct his error in dating the end of the empire, 700-647. Deioeces was not a king of kings; he was forced to bow to the Assyrians repeatedly, but he was the founder of the empire. Three kings followed him. It is possible that there were really more, and that in the summary list the shorter reigns are passed over. Nor can we place much reliance on Herodotus's assertion that each successive ruler was the son of his predecessor.

In perfect harmony with the conditions of development of a small state into a great power is the statement of Herodotus that the second king of the Medes, Phraortes (*Fravartī*; according to Herodotus's reckoning 656-634 [647-625]), extended his sway beyond the limits of Media and first of all subjugated Persia, or Persia proper, the secluded mountain-land south-east of Media. During all this time indeed, as we learn from Darius's great inscription, Persia had kings of its own; but these were simply vassals of the sultan

<sup>1</sup> For this and what follows compare, besides the works of the Assyriologists, A. v. Gutschmid, *Neue Beiträge zur Geschichte des alten Orients*, 87 ff.

<sup>2</sup> That parts at least of Media were subject to Assyria at that period is further shown by 2 Kings xvii. 6, xviii. 11—sure evidence that that of the inscriptions, which may not always be rightly interpreted, and contain, besides, many exaggerations.



who had his seat in Ecbatana. After conquering the Persian, Phraortes, says Herodotus, subjugated piece after piece of Asia, until he was discomfited and slain in the attempt to conquer the Assyrians in Nineveh, whose empire was by that time completely lost. Allowing for some exaggerations with respect to the extent of the empire, there is nothing in these statements that need excite suspicion. Independent evidence seems to show that towards the middle of the 7th century the Assyrian empire had fallen very low;<sup>1</sup> and that the inhabitants of the cluster of vast cities to which Nineveh belonged were able to repel the first attack of an enemy who could hardly have been their match in the art of siege-warfare is perfectly natural. Besides, the stability of the Median military, political, and court institutions, which were afterwards taken over unaltered by the Persians, must surely have required for its development a longer time than some modern inquirers, following exclusively the cuneiform inscriptions, have assumed for the actual duration of the Median empire.

Phraortes's successor Cyaxares (*Huwakhshatara*; according to Herodotus's reckoning 634-594 [625-585]) brought the empire to the highest pitch of power. He is said to have introduced fixed tactical arrangements into the army. It was to him that the pretenders whom Darius had to overcome traced their descent, as he tells us himself. Cyaxares, according to Herodotus, took the field successfully against Nineveh, but as he was besieging the city the inroad of the "Scythians" compelled him to forego for a time all the fruits of victory. Who these Scythians were is unknown. Herodotus took them for the people tolerably familiar to the Greeks, whose true name was Scolotæ; but his evidence does not go for much, since he often falls into the popular misuse of the term "Scythian" as a name for all the peoples of the steppes, and brings the inroad of these Scythians into a most unlikely connexion with the desolating raids of Thracian tribes (the Treres or Terres, commonly called Cimmericians) in Asia Minor. We must content ourselves with assuming that we have here one of those irruptions of northern barbarians into Iran of which we hear so often in later times. Probably these nomads came, as Herodotus indicates, through the natural gate between the Caucasus and the Caspian Sea, the pass of Derbend, though it is quite possible that they came from the east of the Caspian, from the steppes of Turkestan. Whether these Scythians are really the same people who made their way as far as Palestine and Egypt<sup>2</sup> is, indeed, far from being as certain as is commonly supposed, nor can the date of the irruption into these countries be determined. At any rate, the barbarians overthrew the Medes and flooded the whole empire. From what we know of the doings of Huns, Khazars, Turks, and Mongols in later times we can infer how these Scythians behaved in Iran. Cyaxares must have come to some sort of terms with them; and at last he rid himself of them in a truly Eastern fashion, by inviting most of them—i.e., of their chiefs—to a feast, where he made them drunk and slew them at their wine.<sup>3</sup> It is not in the least surprising that Cyaxares afterwards had Scythians in his service; savages like these have no steady national feeling, and serve any potentate for pay.

With the Scythian disorders we might combine the contests which, according to Ctesias, the Parthians and Sacæ (i.e., the inhabitants of the Turkoman desert, who are also called "Scythians" by the Greeks) waged with

Cyaxares or Astibaras, as Ctesias calls him.<sup>4</sup> But it is not safe to do so, as the whole narrative is only the framework for a pretty romance.

Cyaxares marched a second time against Nineveh and destroyed it about 607. Not only Ctesias but also Berosus<sup>5</sup> asserts that the king of the Medes achieved this great success in league with the king of Babylon. That the Median tradition represented the Mede and the Babylonian tradition the Babylonian as suzerain, and the other king as a vassal, is not surprising. The more powerful of the two was doubtless the Median, the richer the Babylonian. Unfortunately Herodotus's work does not include the "Assyrian memoirs," in which he intended to give a fuller account of the fall of Nineveh,—probably because he died before completing the task. In order to protect himself against his ally, who by the fall of the Assyrian empire had grown too powerful, the Chaldean king had recourse to a double precaution: he married his son, afterwards the potent Nebuchadnezzar, to Amytis or Amyntia, daughter of the Median king; but he also erected extensive fortifications. After the fall of Nineveh, Nebuchadnezzar made himself master of Syria and Palestine, and Cyaxares acquired most of the rest of the Assyrian territory. Probably Assyria proper belonged to him also, and we can thus explain Xenophon's error that the Assyrian cities before their destruction belonged to the Medes (*Anab.*, iii. 4, 7-10). When Cyaxares afterwards began the war with the Lydians he was already master of Armenia and Cappadocia, though he probably did not acquire them until after he had got rid of the Scythians and destroyed Nineveh. The pretext for the war was afforded by the flight of some Scythians in Cyaxares's service to Alyattes,<sup>6</sup> king of Lydia; but the real cause was doubtless thirst of conquest. The war lasted for five years with varying fortune, and was ended by the battle during which the eclipse of the sun, said to have been predicted by Thales, took place. The terrified combatants saw in this a divine warning and hastily concluded peace. An impression so profound could be produced by nothing short of a total eclipse. Now, according to Airy's calculation, of all the eclipses of that period the only one which was total in the east of Asia Minor (where we must necessarily look for the seat of war) was that of 28th May 585. Ancient writers<sup>7</sup> also place the eclipse in this year. But this only proves that learned Greeks of a much later age calculated the year of an eclipse which they took to be that of Thales; yet in this case they have hit the truth. More exact calculations have shown that the eclipse of 30th September 610, formerly regarded as that mentioned by Herodotus, was total only to the north of the Black Sea. Besides, it is inconceivable that this war and the new grouping of states which it involved should have taken place before the destruction of Nineveh. The 28th of May 585 is perhaps the oldest date of a great event which can be fixed with perfect certainty down to the day of the month. The conclusion of peace which followed affords us a remarkable instance of diplomatic mediation in

<sup>4</sup> See Diod., ii. 34; Nicol. Dam., 6; Anonymus de mulieribus.

<sup>5</sup> See Euseb., *Chronicon*, pp. 30, 35, 37, and Syncellus, 210 B. The first passage refers to Abydennus, who made use of Berosus. He names the Median king 'Αστυάγης, which Guttschmid regards as a corruption of 'Αστυδάγης = 'Αστυδάγης. This is acute, but it seems better to suppose that Abydennus or an excerptor confused Cyaxares with the last king of the Medes.

<sup>6</sup> He reigned, according to Herodotus's reckoning, from 618 to 561. As this is narrated by Herodotus in his history of Lydia, he probably has it from Lydian sources, and we may regard this as a welcome confirmation of what we are told on Median authority about the destruction of the Scythians.

<sup>7</sup> Pliny, *H. N.*, ii. § 58, and other passages; compare Gelsner, in *Rhein. Museum für Philologie*, N. F., xxx. 264 sq. An astronomer, a friend of the writer of this article, has by independent calculations confirmed the dates assigned in the text for both eclipses.

<sup>1</sup> The Assyrian inscriptions break off abruptly with the year 644; Guttschmid, *op. cit.*, 89.

<sup>2</sup> Herod., i. 105; compare Trogus, in Justin, ii. 3, and Jordanes, *De orig. Get.*, 6, whose account perhaps goes back to Dion.

<sup>3</sup> Between the years 1080 and 1040 A.D. we know three cases where princes of Iranian lands despatched inconvenient Turkomans in exactly similar fashion; see Ibn Athir, ix. 266 sq., 272.

very ancient times. The peace was brought about by Syennesis, prince of Cilicia, and Nebuchadnezzar, king of Babylon.<sup>1</sup> Astyages, son of Cyaxares, married Aryenis, daughter of Alyattes. But according to Herodotus's calculation the above date does not fall within the time of Cyaxares; and even with the necessary correction (of nine years; see below) Astyages ascended the throne in this same year. We might suppose that the battle fell in the father's, the peace in the son's time. But, as we saw above, the dates of these reigns are not of a sort in which we can place much confidence, and it is more likely that the reign of Astyages did not last so long as tradition asserts. Thus Cyaxares probably died after 585.

Of the reign of his son Astyages (in Ctesias *Astygas*, in a Babylonian inscription *Ishwiga*) we have no particulars. It is not even certain that he was cruel, for Herodotus's account of him and of the revolt of Cyrus is not impartial, based as it is on the narratives of the descendants of Harpagus, who had an interest in portraying in unfavourable colours the prince whom their ancestor had betrayed. On the other hand, Ctesias's Median authority (Nicolaus Dam., 64 sq.), which sets Astyages in a very favourable light, has no better claim to credence on this point.

The Median empire must at this time have reached a tolerably high degree of civilization. As remarked above, the political and military institutions of the Persians are substantially those of the Medes; even the dress (of the Persian troops) was borrowed from the Medes.<sup>2</sup> Of buildings erected by the Median kings there are, so far as we know, no remains. The colossal lion, still to be seen, though in a sadly mutilated state, at Hamadán, and about which Arabian writers have all sorts of wonderful tales, is perhaps a monument of the Median age. The fortifications of Ecbatana must certainly have been magnificent; according to Herodotus's description, they showed strong traces of the influence of the star-worship practised by the neighbouring Babylonians, whose civilization was of a much earlier date.<sup>3</sup> It may be that careful explorations in the neighbourhood of Hamadán or excavations will one day bring to light traces of that distant age, perhaps even some distinct inscriptions of Median kings. Such inscriptions would be of the highest value; and we might almost conjecture that the language and writing would be identical with those of the Persian kings. Since the Magi are expressly described by Herodotus as a Median tribe, and since in the age of the Achæmenians the Persian priests were drawn as exclusively from the Magi as in later times, it is highly probable that the Median kings established the Zoroastrian religion as the state religion, and appointed this Median tribe to be the priests. The religion itself arose in the far east, probably in Bactria. It is often assumed nowadays to have originated in Media, but the fact that its sacred books know nothing of the Magi tells particularly against this view. How firmly the Median Magi were in possession of the priesthood in Persia proper (Persis) about the year 522 we learn from the circumstance that they maintained their position in spite of the catastrophe of the false Smerdis. They must therefore have already held it for some time, and this carries us back almost necessarily to the influence of the Median empire. If this is correct, the Median empire has an extraordinary importance in the history of religions. The consideration enjoyed by the Median monarchy is proved by the fact that in Western lands which never came in contact with it at all its name

was so familiar that more than a hundred years after its fall the Persians were still mostly called Medes by the Greeks; in particular the wars of independence with the Persians still went at a much later date simply by the name *τὰ Μηδικά*.<sup>4</sup>

Nor was the Median empire properly destroyed by Cyrus; it was only transformed. Another race of the Iranian people and another dynasty stood at the head of the Iranian empire and carried out, as far as it was at all possible, Cyaxares's scheme for the conquest of Asia and the border-lands. That the Persian empire was the direct heir of the Median was known both to the Greeks—for only on this supposition were the above-mentioned expressions possible—and to the Hebrews (*Isa. xiii. 17*; *Ezra i. 3, &c.*).

We possess three accounts of the mode in which the transition was effected, that of Herodotus, that of Ctesias, (of which that of Dinon, preserved only in some fragments and vestiges, is merely a variation), and that of Xenophon in the *Cyropædia*. Though Xenophon had before him the works of both Herodotus and Ctesias, we must, with Niebuhr,<sup>5</sup> regard his book as nothing more than an extremely silly romance; the attempts to employ it as an independent historical source have always failed. Herodotus probably got his charming narrative directly or indirectly from the descendants of Harpagus, a man who undoubtedly played a chief part in transferring the supremacy from the Medes to the Persians. Ctesias's narrative, which we are obliged to piece together from Nicolaus Damascenus, Photinus, Justin, Polyænus, and Diodorus, is highly coloured, but in parts very pretty, and has, in contradistinction to Xenophon's romance, a genuinely Oriental stamp. It appears to be based on the account of a Mede, who gave a marked preference to his own people, and represented the founder of the Persian empire in as unfavourable a light as it was possible for a Persian subject (and probably an official) to do. There was no denying the fact of Cyrus's final victory, but in Ctesias's narrative he achieves his greatest successes by cunning and deceit. He is a genuine herdsman's son, takes early to robbery, and discharges menial services, in the course of which, significantly enough, he gets plenty of hard knocks. His accomplice Cebares is a cowardly rascal. Astyages defeats Cyrus in Persis itself and pursues him to his home, Pasargadæ; he is only saved by the intervention of the women. On the other hand, Astyages magnanimously spares Cyrus's father, who had fallen into his power. It is particularly significant that over the corpse of Astyages, who had been left by stratagem to pine in the wilderness, a royal guard of lions kept watch and ward. Of course all this does not exclude the supposition that this partisan narrative is founded on a genuine Persian legend. For the rest, the narrative of Ctesias agrees in some particulars, and even in some names, with that of Herodotus.

That Cyrus (*Kuru*, nominative *Kuruah*, or rather *Kûru*, *Kûruah*<sup>6</sup>) was not of lowly descent but of a princely house was long ago seen to be a necessary supposition. Popular legend loves the elevation of sons of the people to the throne, but as a matter of fact national kingdoms are not easily founded anywhere, and least of all amongst primitive peoples, except by persons of distinguished birth. A knowledge of the Persian inscriptions has put it beyond a doubt

<sup>4</sup> It is noteworthy, however, that Æschylus in the *Perseus* says "Persians" almost exclusively, but "Medes" only exceptionally (*ver. 286, 791*, and so in his epitaph); perhaps the poet chose "Persians" as the less usual expression.

<sup>5</sup> *Lectures on Ancient History*, i. 96, Eng. tr.

<sup>6</sup> The *u* is long, as is shown by the agreement of *Κύρος*, Æschyl., *Perseus*, 768, and *כורש* of the Old Testament. The long *u* makes it impossible to identify the name with the Indian *Kürü*, as Spiegel proposes.

<sup>1</sup> For the latter Herodotus wrongly substitutes his successor Labynetus (Nabunaid; Persian *Nabonaisia*).

<sup>2</sup> Herod., vii. 62.

<sup>3</sup> See Sir H. Rawlinson, in G. Rawlinson's *Herodotus*, i. 98, and Joh. Brandis, in *Hermes*, ii. 264.



when he offered battle, and captured his capital Sardis after a short siege. Not only Herodotus but also apparently his contemporary Xanthus the Lydian, quite independently of Herodotus, told how Cyrus would have burned Croesus alive.<sup>1</sup> The statements of Ctesias and Xenophon to the same effect are borrowed from Herodotus. But there is also a vase of the time of Pericles representing Croesus seated on a pyre and majestically pouring out a libation.<sup>2</sup> We may not of course infer from this that Croesus offered himself as a willing sacrifice; but it certainly shows that a hundred years later there was a general belief that Croesus had stood upon the pyre. And it is by no means inconceivable that Cyrus, whom we must picture to ourselves, not as the chivalrous and sentimental hero of Xenophon, but as a savage conqueror, should have destined such a punishment for a vanquished foe, against whom he may personally have been especially embittered. No doubt to pollute the fire with a corpse was even in those days an impiety in the eyes of the Persians, but who knows whether Cyrus in his wrath paid much heed to such religious maxims than did his son Cambyses? However, Croesus was pardoned, after all, perhaps because some external circumstance interposed (because a sudden shower prevented the fire from burning?), or because the conqueror changed his mind before it was too late. The pious and believing saw in the event a direct intervention of Apollo on behalf of the man who had honoured the Delphic shrine so highly.<sup>3</sup>

The date of Croesus's fall is not quite certain. It may have been 547 or 546. When Cyrus had marched away, the Lydian Pactyas, whom Cyrus had appointed guardian of the treasures, raised a revolt, but it was speedily put down by the king's generals. From that time forwards the Lydians never made the slightest attempt to shake off the Persian rule.

But now began that struggle of the Persians with the Greeks which has had so much importance for the history of the world. The Lydian kings had subdued a number of Greek cities in Asia Minor; but even these latter shrank from submitting to the still barbarous Persians, whose rule was far more oppressive, inasmuch as they ruthlessly required military service. But Harpagus and other Persian leaders quickly took one Greek town after the other; some, like Priene, were razed to the ground. Some of the Ionians, such as the Teians, and most of the Phocæans, avoided slavery by emigrating. Miletus alone, the most flourishing of all these cities, had early come to an understanding with Cyrus, and the latter pledged himself to lay no heavier burden on it than Croesus had before him. In most of the cities the Persians seem to have set up tyrants, who gave them a better guarantee of obedience than democratic or aristocratic governments. In other respects they left the Greeks alone, just as they left their other subjects alone, not meddling with their internal affairs so long as they paid the necessary contributions, and supplied men and ships for their wars. Most of the other peoples in the west of Asia Minor submitted without much resistance, except the freedom-loving Lycians. Driven into Xanthus, the capital, they perished in a body rather than surrender.<sup>4</sup> Some Carian cities also defended themselves stoutly. This

may have given a Persian here and there an inkling even then that the little peoples on the western sea were, after all, harder to manage than the nations of slaves in the interior of Asia. Sardis became and remained the mainstay of the Persian rule in western Asia Minor. The governorship was one of the most influential posts in the empire, and the governor seems to have exercised a certain supremacy over some neighbouring governorships.

Though Cyrus had made, and continued to make, conquests in the interior of Asia, he was still without the true capital of Asia, Babylon, the seat of primeval civilization, together with the rich country in which it lay, and the wide districts of Mesopotamia,<sup>5</sup> Syria, and the borderlands over which it ruled. Now that we know the two Babylonian memorials mentioned above we can dispense with most of the various, often very fabulous, accounts which Greek writers give of the conquest of Babylon; but when these documents are rightly understood the divergence between them and the account of Berosus<sup>6</sup> is, on the main points, not very great. Before the capture of the city, in the summer of 539, a great battle took place, in consequence of which Cyrus occupied the capital without any further serious fighting, since the Babylonian troops had mutinied against their king. Late in the autumn of 539<sup>7</sup> Cyrus marched into Babylon, Nabunaid, the king, having previously surrendered himself. According to Berosus, Cyrus appointed Nabunaid governor of Carmania, east of Persia<sup>8</sup>; but in the annals inscribed on the tablet it is said to be recorded that Nabunaid died when the city was taken. If both memorials represent Cyrus as a pious worshipper of the Babylonian gods, if, according to the cylinder, the Babylonian god Merodakh, wroth with the king of Babylon because he had not served him aright, actually himself led and guided Cyrus, such a piece of priestly diplomacy ought not to impose on any student of history. The priests turned to the rising sun, whether they had been on good or bad terms with Nabunaid. Cyrus certainly did not put down the Babylonian worship, as the Hebrew prophets expected; he must even have been impressed by the magnificence of the service in the richest city of the world, and by the vast antiquity of the rites. But he was no more an adherent of the Babylonian religion, because the priests said he was, than Cambyses and the Roman emperors were worshippers of the Egyptian gods, because Egyptian monuments represent them as doing reverence to the gods exactly in the style of Egyptian kings. Sayce doubts whether Cyrus could read their documents; we doubt whether Cyrus understood their language at all, and regard it as inconceivable that he learned their complicated writing; indeed, on the strength of all analogies, we may regard it as scarcely probable that he could read and write at all.<sup>9</sup> The countries subject to

<sup>5</sup> We always use "Mesopotamia" in the sense in which alone this geographical conception ought to be used, viz., as equivalent to the Arabic *Jazira*, i. e., to denote the cultivated land between the middle Euphrates and the Tigris, which is separated by the Mesopotamian desert from the totally different Irâk (Babylonia).

<sup>6</sup> In Josephus, c. *Ap.*, l. 20. On many particular points in these memorials the Assyriologists themselves hold different opinions; but the part which concerns us most seems to be free from doubt.

<sup>7</sup> On 3d Marcheshwan, which month corresponds nearly to our November. The year which begins with 5th January 538 is, in the astronomical canon, the first year of Cyrus as king of Babylon. If, as the strict rule requires, we make the small remainder of the year after the taking of the city to be the first year of Cyrus's reign, then the events in the text fall in 538. But probably the remainder of the year was not reckoned in, and for this there are analogies. (See below.)

<sup>8</sup> This statement is further supported by that of Abydenna, doubtless taken from Berosus, that Darius drove Nabunaid out of Carmania (Euseb., *Chron.*, p. 41). This is certainly not an invention. At the most, the former king of Babylon might have been confounded with another Babylonian prince.

<sup>1</sup> See Nicolaus Dam., 67 (apparently put together from Herodotus and Xanthus).

<sup>2</sup> *Mon. de l'Inst. Arch.*, l. 54.

<sup>3</sup> Croesus's good repute amongst the Greeks of the mainland (see Pindar, *Pyth.*, l. 184 [94]) was due to his liberality to the Delphians. Even 400 years afterwards the Delphians appealed to their old friendship with the people of Sardis (i. e., with Croesus). *Bulletin de corresp. hellénique*, v. 383, 389 sq. That Croesus could also be inhuman enough is shown by Herod., l. 92.

<sup>4</sup> About 500 years later the inhabitants of Xanthus followed their example in the struggle with that champion of freedom, Brutus.

<sup>9</sup> Even the comparatively simple Persian cuneiform writing was certainly always the secret of a few; otherwise it could not have

Babylon seem to have submitted without resistance to the Persians. The fortress of Gaza alone, in the land of the Philistines, perhaps defended itself for a time.<sup>1</sup> On the other hand, the Phœnician cities, some of which offered a sturdy resistance to other conquerors, submitted immediately, and remained steadily obedient to the Persians down almost to the end of the empire. It seems, however, that, as the real prop of the naval power of Persia, they were almost always treated with special consideration by the latter. In the very first year of his reign in Babylon<sup>2</sup> (538) Cyrus gave the Jewish exiles in Babylon leave to return home (2 Chron. xxxvi. 23 sq. = Ezra i: 1 sq.). Comparatively few availed themselves of this permission, but these few formed the starting-point of a development which has been of infinite importance for the history of the world.

How far to the east Cyrus extended his dominion we do not know, but it is probable that all the countries to the east which are mentioned in the older inscriptions of Darius as in subjection or rebellion were already subject in the time of Cyrus. In this case Chorasmia (Khârezm; the modern Khîva) and Sogdiana (Samarkand and Bokhâra) belonged to him. Agreeably with this, Alexander found a city of Cyrus (Cyropolis)<sup>3</sup> on the Jaxartes, in the neighbourhood of the modern Khokand. He doubtless ruled also over large portions of the modern Afghânistân, though it is hardly likely that he ever made his way into the land of the Indus. The story of his unsuccessful march on India<sup>4</sup> seems to have been invented by way of contrast to Alexander's fortunate expedition.

Different accounts of Cyrus's death were early current. Herodotus gives the well-known didactic story of the battle with Tomyris, queen of the Massagætæ, as the most probable of many which were told. If we accept Herodotus's statements, we must look for the Massagætæ beyond the Jaxartes. In Ctesias Cyrus is mortally wounded in battle with the Derbices, who probably dwelt near the middle or upper Oxus. A fragment of Berossus<sup>5</sup> says that Cyrus fell in the land of the Dai (Dâhæ), i.e., in the modern Turkoman desert, perhaps in the southern or south-western portion of it; this account may very well be derived from contemporary Babylonian records. Be that as it may, Cyrus met his death in battle with a savage tribe of the north-east. The battle was probably lost, but the Persians rescued his body, which was buried at Pasargadæ in the ancient land of his race. To this day there is to be seen at Murghâb, north of Persepolis (on the telegraph line from Abûshehr to Teherân), the empty tomb and other remains of the great mausoleum, which Aristobulus, a companion of Alexander, described from his own observation<sup>6</sup>; and on some pillars there the inscription is to be read: "I am Cyrus, the king, the Achæmenian." Till lately the same inscription was also to be found high on the pillar which bears in bas-relief a winged figure of a king. This figure is furnished with a "pahent," i.e., such an ornamented crown as is worn by kings and gods on Egyptian monuments.<sup>7</sup> This was no

doubt meant by Cambyses as a special mark of honour to his father, whose monument must have required years to finish. It is quite natural that the ancient art of Egypt should have made a deep impression even upon those of its conquerors who in other respects had little liking for Egyptian ways.

If one could accept without question the judgment of the Persians as recorded by Herodotus (iii. 89, 160), expanded by Xenophon, and repeated by later writers (from Plato downwards), Cyrus must have been the most perfect model of a ruler. But we must view with great suspicion a tribute of praise like this paid to the founder of an empire by those who reaped the fruits of his labours. The founder of the Sâsânian empire is also described as a paragon of wisdom and virtue, though his deeds strikingly belie such an estimate. We must be content to know that we are no better informed about the character of many other great men of the past than about that of Cyrus. That he was a very remarkable man and a great king is a matter of course. Whether he deserves the reputation of a great statesman, which even in modern times has been accorded to him, we cannot say. Certain it is he left the empire still in a very unformed condition. To expend the immense treasures of Ecbatana, Sardis, and Babylon for the benefit of the empire was to be sure an idea which certainly would never have entered into the head of any Eastern conqueror. The treasures simply became the property of the king, though of course a large part went to the leading Persians and Medes who filled the most important offices.

Cyrus died in the beginning of the year 529. He left behind him two sons, Smerdis<sup>8</sup> (Persian *Bardiya*) and Cambyses (*Kambûjiya*); their common mother was according to Herodotus an Achæmenian, according to Ctesias the daughter of the Median king. The great inscription of Darius states that Cambyses caused Smerdis to be put to death without the people being aware of it. From this it follows that the partition of the kingdom between the two brothers, of which Ctesias speaks, can hardly have taken place; for the murder of a king or consort could not have remained concealed. Besides, in both the Babylonian inscriptions, of which mention has been frequently made, Cambyses is spoken of in a way which distinctly shows him to have been heir-apparent. This fratricide, the true motives of which we do not know, was the forerunner of many similar horrors in the dynasty. The inscription proves, as against Herodotus, that the deed was done before the expedition to Egypt. Nothing else is told us about the earlier part of the reign of Cambyses. It is only when we come to his conquest of Egypt that we have more exact information. The pretexts for the Egyptian war need not detain us. The riches of Egypt had from of old allured the lords of the neighbouring lands, and Herodotus takes it for a matter of course that Cyrus had occupied himself with plans against Egypt. According to the statements of Manetho<sup>9</sup> and of the Egyptian monuments, the conquest of Egypt took place in the spring of 525. Vast warlike preparations preceded the expedition. The Greeks of Asia Minor, the Cyprians, who had just submitted, and the Phœnicians had to furnish the fleet. A countryman of Herodotus, the mercenary captain Phanes of Halicarnassus, deserted from the Egyptians to the

happened that, e.g., the Behistûn inscriptions of Darius should have been described to Ctesias as those of Semiramis (Diod., ii. 13).

<sup>1</sup> According to the conjecture of Valesius in Polyb., xvi. 40, τῆς Περσῶν, which, though not absolutely certain, is still the best emendation of the passage.

<sup>2</sup> This statement goes to show that the small remainder of the year after the taking of Babylon was not reckoned in Cyrus's first year. For he had at that time something more important to do than to trouble himself straightway about the Israelites.

<sup>3</sup> Arrian, iv. 2 sq.; Curtius, vii. 6, 16, vii. 6, 20; Strabo, 517; Ptol., vi. 12; Steph. Byz.; Plin., vi. 49; Solinus, xlix. 4.

<sup>4</sup> Nearchus, in Arrian, vi. 24, 2; Strabo, 636, 742.

<sup>5</sup> Ensch., Chron., p. 29.

<sup>6</sup> See Strabo, 730; Arrian, vi. 29, 4 sq.

<sup>7</sup> See the copies in the great works of Texier and of Flandin and Costa. The most exact representations are those from photographs in Stolze, *Persepolis* (Berlin, 1852), tab. 128 sq., 182 sq. The proof that this is really the grave of Cyrus is given in Stolze's Introduction, as

well as in his paper in the *Verhandl. der Gesellschaft für Erdkunde zu Berlin*, 1853, Nos. 5 and 6 (p. 19 sq. of the separate edition).

<sup>8</sup> So Herodotus (the name being assimilated to a genuine Greek name Smerdis, Smerdes). Æschyl., *Pers.*, 774, has Μαρδίας; Justin, l. 9, 9 sq., Mergis; the scholium on Æsch., l. c., Μερδίας.

<sup>9</sup> See Wiedemann, *Geschichte Ägyptens von Psammethich I. bis auf Alexander den Grossen*, p. 218 sq.; comp. too Diod., l. 62. For what follows, and for all that concerns the relations between Egypt and Persia, the work of Wiedemann is to be consulted. At the same time the assumption of the year 525 as the date of the conquest is open to some objections; there are many arguments in favour of 527.

Persians and made himself very useful in the conquest. It seems that only one great battle was fought, at Pelusium, the gateway of Egypt. The Egyptians, utterly beaten, fled to Memphis, which soon fell into the enemy's hands. Thus Egypt became a province of Persia; and a pretext was soon found for executing the captured king Psammetichus. This was followed by the submission of the neighbouring Libyans and the princes of the Greek cities of Cyrene and Barca. The peculiar religious feelings of the Egyptians were almost as easily wounded as those of the Jews were in later times. The Persians, flushed with victory, recked little of Egyptian wisdom or folly, least of all recked the brutal king. It is true that even Egyptian inscriptions represent him as a pious worshipper of the Egyptian gods, but this is only the courtly ecclesiastical style, which the Egyptians, partly from servility, partly from long habit, can never drop. And, even if Cambyses did once in a way gratify a pious Egyptian, e.g., by ordering his troops to quit a temple which they had occupied as a barrack, no great importance is to be attached to the fact. No doubt the Egyptian priests grossly exaggerated the king's wickednesses, but enough remains after all deductions. The dreadful hate which again and again goaded the naturally patient and slavish nation into revolt against the Persians dates from this time; Darius could not atone for the guilt of Cambyses. The brutality of the latter began with maltreating and burning the mummy of the former king Amasis, who had personally insulted him or his father; to the Persians, as Herodotus expressly says, the burning of the body was no less an impiety than to the Egyptians. From Egypt he sent an expedition to the shrine of Ammon in the Libyan Desert, but, caught presumably in a simoom, it was never heard of again. He led in person a great expedition to Nubia ("Æthiopia"). It does not seem to have been such an utter failure as one might at first infer from Herodotus's narrative, for some districts to the south of Egypt were conquered; but the results purchased by hecatombs of men who perished by fatigue or were buried in the sands were far from contenting the king. Returning to Memphis, he found the people exulting over the discovery of a new Apis. Their joy did not fall in with his mood. In a fury, or perhaps out of a tyrant's caprice, he inflicted with his own hand a mortal wound on the sacred steer and instituted a massacre among its worshippers. We may well believe Herodotus that from that time his barbarity to the Egyptians showed itself in ever darker colours. He spared not even the Persians. Ctesias too calls him bloodthirsty. Added to this was his drunkenness. But his marriage with one or two sisters, at which Herodotus takes offence, was really, according to Persian notions, an act of piety.<sup>1</sup> Similarly, when he put to death a corrupt judge of the highest family and caused his akin to be made into a covering for the seat on which his son was to sit and administer justice, the act was one which all Orientals recognized as truly kingly (Herod., v. 25).

The empire was extended in another direction, when Polycrates, the powerful tyrant of Samos and the neighbouring islands, sought safety in submission to the great king.

Suddenly, however, the empire rang with the news that the king's brother Smerdis had seized the crown in Persia. We are now in possession of Darius's own account of these events, and can fairly dispense with the Greek narratives; but we may note that here again, in spite of his poetical colouring, Herodotus stands the test much better than Ctesias.<sup>2</sup> Gaumátá (in Ionic form *Gómátá*, Justin, i. 9), a

Magian, gave himself out as Smerdis (spring of 522) and formally assumed the government. Even Darius's account lets us see that Cambyses was very unpopular, and the same thing appears from the fact that everybody sided with the new king. Cambyses seems to have marched against him as far as Syria, but there he put an end to himself,—an end plainly affirmed by the great inscription, and quite in keeping with the wildly passionate nature of the man. Gaumátá reigned, universally acknowledged, and, as it seems, beloved, because he granted extensive remissions of taxes. He appeared in the character of Smerdis, son of Cyrus, and therefore as Persian king. This is enough to show that there can be here no question of a political opposition of the Medes to the Persians, such as Herodotus imagines, nor yet of a religious opposition to the Persians by the Magians. The changes for the worse now introduced, and abolished again by Darius when he ascended the throne,<sup>3</sup> seem to imply no more than a very intelligible disregard of the leading Persian families, whom Gaumátá could not but fear, since they knew much better than the people that he was an impostor. He fell, not through the patriotic indignation of the Persian people, but through the enmity of these families. Seven persons conspired against him; their names, each with that of his father, are given by Darius in full agreement with Herodotus, while the list of Ctesias presents somewhat more divergence.<sup>4</sup> No doubt they were members of the seven most illustrious houses, but certainly not the actual heads of these houses; for such a life-and-death enterprise, where all depended upon energy and silence, could not be entrusted to persons who happened to be heads of families and some of them perhaps old men. Moreover, Darius himself, who was undoubtedly from the outset the real leader, was certainly not the head of his house, for his father Hystaspes (*Vishtáspa*) was still alive and in full vigour, since he afterwards governed a province and fought the rebels. But the ring-leaders would choose one out of each of the seven families in order to commit the families themselves. The conspiracy was completely successful; and the seven killed Gaumátá in the fortress *Sikathahuvati* near *Ecabatana*, in the land of *Nisa* in *Media*. This happened in the beginning of 521. Darius was then made king. He was probably the only one of the seven who was qualified to be so, for he alone belonged to the royal family, of which, it is true, there may have been many members more nearly related to Cambyses. At any rate there was hardly another candidate for the crown as able as he.

Darius (*Dárayaváhú*, in the nominative *Dárayaváhushá*) was then, according to Herodotus (i. 209), about thirty years of age. Amongst other measures for securing himself and adding to his dignity he took to wife *Atossa*, daughter of Cyrus, who had already been married to her brother Cambyses and to the false Smerdis. He soon showed that his six comrades were not his peers by executing *Intaphernes*, who had forgotten the respect due to the king, together with his whole family. That at first his seat on the throne was far from firm is intimated by Herodotus (iii. 127), who also mentions cursorily an insurrection of the Medes against him (i. 130), but it is only from the king's great inscription that we learn the gigantic nature of the task he undertook when he ascended the throne. He had first to unite the empire again; one province after the other was in insurrection; the west alone remained quiet, but it was partly in the hands of governors of

<sup>1</sup> Herodotus's Persian informants told him much of the real or pretended virtues of their people, but concealed things which would have offended him.

<sup>2</sup> Small remains of another ancient and trustworthy account are to be found in Justin.

<sup>3</sup> Unfortunately in this interesting passage of the great Behistun inscription the particulars are very obscure.

<sup>4</sup> In Ctesias the name of a son is twice given for that of the father. It is obvious that we are here dealing with the ancestors of the seven great families, and one generation could very easily be named by mistake for another.



doubtful loyalty. Darius gives the day of the month for the most important events, but unfortunately not the year. Moreover, in consequence of the mutilation of the Babylonian text it is only of some of the Persian months that we can say with certainty to what parts of the year they roughly correspond.<sup>1</sup> Thus the particular chronology of these insurrections remains in many points quite uncertain, especially as it can be seen that many events narrated as successive were contemporaneous. In any case Darius acted very energetically and promptly; and the chief provinces were undoubtedly again reduced to subjection in the first three years of his reign. The insurrection of Athrina in Susiana was promptly suppressed by a Persian army. More dangerous was the revolt in Babylon of Nidintubel (*Nadintabairu*), a real or pretended member of the Babylonian royal house who assumed the august name of Nabukadrezzar (Nebuchadnezzar). Darius hastened thither and defeated him in several battles. But the long siege after which, according to Herodotus, the rebel city fell into the hands of Darius, cannot have taken place then.<sup>2</sup> While Darius was in Babylon a whole series of revolts broke out. That of Martiya in Susiana, who called himself Imani, and appeared in the character of king of that country, was indeed soon put down with the help of the people of Susiana themselves, but in Media, the heart of the monarchy, the situation was much more grave. Phraortes (*Φραορτης*), who gave himself out to be a scion of the old royal house of Media, was made king of Media, and the Parthians and Hyrcanians to the eastward, whose satrap was Hystaspes, father of Darius, sided with him. The king's generals could effect nothing decisive against Phraortes; at last he was overthrown by the king in person. Like all rebels who deduced their descent rightly or wrongly from the old dynasties, he was put to death with circumstances of especial cruelty. In the meantime one of Darius's generals had put down a second false Nebuchadnezzar in Babylon; others had to suppress insurrections in two regions of Armenia, which were, perhaps, connected with the revolt of Phraortes, and a rising in the distant Margiana (the district of Merv). Even Persis had risen. Another false Smerdis, Vahyazdāta, appeared in the east while Darius was in Babylon, and crowds flocked to him. His power increased so much that he was even able to send an army to Arachosia (a part of western Afghanistan). While Darius in person took the field against Phraortes, he despatched against Vahyazdāta a general who at last overthrew the rebel. Arachosia, too, was reduced to subjection. So, too, was the nomad tribe of the Sagartii (perhaps on the northern or north-eastern frontier of Persis), with Chitratama at their head, who also claimed to be of the royal house of Media. Afterwards Gobryas (*Γαβρυα*), one of the seven, suppressed a third revolt in Persis. The king in person reconquered the Sacæ, who had been in subjection before. The generals employed by Darius were Persians and Medes; but there was one Armenian among them. His faithful army was composed of Persians and Medes, but his adversaries were also supported in part by Persians and Medes. Darius must have been a great ruler to conquer them all. Picture his position when he took

the field against Phraortes; Babylonia was his once more, and its wealth must have supplied him with the means of war, but almost the whole of Iran and Armenia was in the hands of men whom he calls rebels and liars, but some of whom, at least, had perhaps more right than he to the sovereignty, and whose people were devoted to them. No sooner had he reached Media than Babylon was again in arms. Nothing but great energy and circumspection could have carried him safely through all his difficulties.

The satrap of Sardia, Orotes, had not revolted, but his conduct was that of an independent prince. Him Darius put out of the way by stratagem (Herod., iii. 120 sq.). At the same time Samos became definitively a Persian province, after a royal army had, with much bloodshed, set up as tyrant Syloson, brother of Polycrates, whom Orotes had put to death. The removal of Aryandes,<sup>3</sup> governor of Egypt, who assumed, even at that date, the royal privilege of minting money, seems to have followed not long afterwards.<sup>4</sup> He had extended his power westwards. But we see from Herodotus that to the west of the last mouth of the Nile the Persian rule was always precarious; and that he can have conquered Carthage, whose naval power was perhaps a match for that of the whole Persian empire, is quite incredible. At the most it is possible that the prudent leaders of that commercial state may in negotiations and treaties have occasionally recognized the king in ambiguous phrases as their lord.

The experience gained by Darius in the first unsettled years of his reign must have been in part the occasion of his introducing numerous improvements into the organization of the empire. Governors with the title of satraps (*κβαθηρωπδων*, i.e., land-rulers) there had been before, but Darius determined their rights and duties. Vassal princes of dangerous power were tolerated only with reluctance. The satrap had indeed the power and splendour of a king, but he was nevertheless under regular control. The court received from special-officials direct reports of the conduct of the governors, and from time to time royal commissioners appeared with troops to hold an inspection. The satrap commanded the army of his province, but the fortresses he was obliged to leave in the hands of troops directly under the king. But the most important part of the reform was this: Darius regulated the taxes and imposed a fixed sum upon each province, with the exception of the land of his fathers, which enjoyed immunity. The Persians were discontented at this, and dubbed Darius in consequence "higgler" (*κἀπηλος*); but this is doubtless only the cry of high officials, to whom any regulated fiscal system was objectionable, as making it somewhat more difficult for them to fleece their subordinates. It is not at all to be supposed that the irregular contributions ("presents," Herod., iii. 89) previously levied were less burdensome to the subjects. However imperfect the Persian state system was, and however illusory the measures of control may often have been, still the organization introduced by Darius marks a great step in advance over the thoroughly rude old Asiatic system.

In the Behistun inscription, which is placed not long after the conclusion of the great revolts, India does not as yet appear as a province, though it does in the later inscriptions of Persepolis, and in the epitaph of Darius. Herodotus says that Darius caused the Indus to be explored from the land of the Pactyans (Pakhtu, Afghans) to its mouth by Scylax, a Greek or rather Carian, and then conquered the country. But in any case this Persian "India" was only one portion of the region of the Indus. If this conquest was somewhat adventurous, much more so was

<sup>3</sup> Polyænus, vii. 10, 7, calls him Oryandres.

<sup>4</sup> Wiedemann, *op. cit.*, p. 236, fixes as the date the year 517; but his grounds are not conclusive.

<sup>1</sup> The obvious assumption that the strange name *Anāmaka*, i.e., "anonymous," for a month means an intercalary month would compel us to infer that all the events falling in this month belonged to one and the same year, for two successive years or every other year cannot each have an intercalary month. But a careful consideration of the particulars shows that all these events could not fall in the same year. Another obstacle to regarding *Anāmaka* as an intercalary month is the circumstance that it corresponds to the tenth Babylonian month Tebet, i.e., probably to December or January, whereas intercalary months usually follow the twelfth or sixth month.

<sup>2</sup> See below under Xerxes.

the enterprise against the Scythians. Profound motives for this expedition have been sought for, but it no doubt sprang simply from the longing to conquer unknown lands. That Darius, an energetic and valiant Eastern prince, always hitherto favoured by fortune, should have been free from lust of conquest is in itself very unlikely. The expedition against the Scythians falls about 515. With regard to the preparations and the beginning of the expedition up to the crossing of the Danube we are well informed. The Greek subjects, of whom even by this time there were many on the European (Thracian) side—such as the inhabitants of Byzantium and the Thracian Chersonese—were obliged to supply the fleet. Mandrocles of Samos built a bridge over the Bosphorus. The Persians must soon have found how useful the skill of the Greeks might be to them, without suspecting the dangers with which the Greek spirit threatened them. The king's march may be followed as far as the Danube; it lay pretty nearly due north, the warlike Gætæ, a Thracian people, being subdued on the way. With the entry into the Scythian country itself Herodotus's narrative becomes completely fabulous. His chief error is in leaving out of sight the enormous distances in these regions (the southern part of modern Russia) and the great rivers. Hence he represents the native tribes and Darius as marching the distance between the Danube and the Don, or even the Volga, twice in not more than two months, as if the distances were as in Greece. Darius, who passed the Danube by a bridge in the neighbourhood, perhaps, of Isaktchi, can hardly have crossed even the Dniester. Strabo, who either possessed more exact accounts of the expedition, or drew correct inferences from the disaster which afterwards overtook King Lysimachus in this neighbourhood, forms a very intelligent judgment on these matters. The expedition failed, not through the superior tactics of the Scythians, who behaved just as might be expected of such nomads, with a mixture of timidity and audacious greed of booty, but through the impassable and inhospitable nature of the country, through hunger and thirst, through exhaustion and disease. After sustaining heavy losses Darius was obliged to retreat across the Danube. The king, or at all events his army, was saved by the Greek tyrants, especially Histæus of Miletus, who refused to follow the advice of their colleague Miltiades to break down the bridge. But the damage to the prestige of the empire was great; the Greeks had seen their lord and master in distress. Nevertheless the district south of the Danube was retained. That the Scythians immediately followed up their enemy, or that they even opened negotiations with the Spartans, as Herodotus states,<sup>1</sup> is not to be supposed. Moreover, Megabyzus, whom Darius on his return left behind in Europe, subdued great districts of Thrace along with the Greek cities on the coast. The king of Macedonia also acknowledged the great king as his liege lord. The cities on the Hellespont,<sup>2</sup> which after the failure of the expedition made no secret of their feeling towards the Persians, and in part expressed their hostility in overt acts against them, received sharp punishment. The islands of Lemnos and Imbros were occupied. At the mouth of the Hebrus (Maritza) Doriscus was converted into a fortress with a standing garrison.<sup>3</sup>

<sup>1</sup> The story of the dealings of King Cleomenes with the Scythians (Herod., vi. 84) rests on a joke,—he drank immoderately, "like a Scythian."

<sup>2</sup> This expression is used to designate the towns lying on the Hellespont, Propontis, and Bosphorus.

<sup>3</sup> To the same time may be referred the foundation on the Asiatic side of Darcium, named after Darius, just as Harpagium probably has its name from Harpagus. It is to be observed that in the district of Old Phrygia such towns called after persons are found from old, as "Idæum, Gordæum, Dascylium, and others.

The eyes of the Persians were now turned towards Greece proper. While the Greek coast of Asia Minor was indispensable to the power which held the interior, the possession of the mother-country of Hellas was, as we can easily see, not only unnecessary but positively dangerous to the Persians, especially as they were themselves absolutely unfitted for the sea. But to the Persians of those days, absorbed in schemes of universal empire, considerations such as these could not present themselves. Besides, the enterprises of the Persians against the Greeks were to a large extent suggested and furthered by the Greeks themselves. Repressed factions, tyrants in exile or in danger, were but too ready to invoke the help of the foreigner at the price of slavery. When the Persians attacked a Greek state there was always another at enmity with it which at once took their side. Even the inconsiderable enterprise which was the outward occasion of the Ionian revolt, namely, the attack of the Persians on Naxos, was brought about by the banished aristocrats of the island, who applied to Aristagoras, lord of Miletus, and hence to his superior, Artaphernes, the king's brother and satrap of Sardis. The enterprise failed, and in his embarrassment Aristagoras gave the signal for the revolt which he and his father-in-law Histæus, the proper tyrant of Miletus, who was detained at the court of Susa, had planned long before.

The great rising of the Ionians and other Greeks and non-Greeks shows a vigorous love of freedom, and much individual boldness and skill on the side of the insurgents; but, quite apart from the vast odds against them and the unfavourableness of their geographical situation, their enterprise was from the outset doomed to failure, because they did not form a compact party, because not even the Ionian cities practised that discipline and subordination which for war are indispensable, and lastly because Aristagoras and Histæus were adventurous intriguers and tyrants, but without the gifts of rulers or generals. Of the history of the revolt, in addition to the excellent accounts which he derived from Hecæus of Miletus, a contemporary and actor in the events he describes, Herodotus has all sorts of popular fables to tell. The chronology is uncertain; probably the revolt began in 500 or 499, and was substantially ended by the capture of Miletus in 495 or 494 (six years later, Herod., vi. 18). Aristagoras made himself master of the fleet on its return from Naxos, took prisoner the tyrants on board at the head of the contingents of their cities, and restored the republic in Miletus, only of course with the view of thereby ruling the confederacy. The Spartans, admittedly at that time the first power of Greece, were sober enough to refuse the help requested. But the Athenians, who had already excited the wrath of the Persians by refusing to comply with the demand of Artaphernes that they should receive back Hippias as tyrant, had the courage or rather the foolishness to despatch twenty ships to the help of the Ionians. They thus mortally insulted the Persians without really benefiting their friends. The Athenians shared in the march on Sardis. The confederates burned the city, but could not capture the citadel; on the contrary, they were obliged to beat a hasty retreat, and were after all routed at Ephesus. However, the Persian army did not as yet permanently take up quarters in Ephesus. The Athenians, who may have dreamed of pressing forward into the interior of Asia, returned home with their illusion dispelled, and Athens took no further part in the war. But the impression produced by this unsuccessful expedition upon a modern critic is very different from that which it produced upon the Asiatics of those times. They said: "The Ionians have risen against the king; the Ionians from beyond the sea have come to their help; they have

burned the king's capital," and many added, "It is all over with the king's supremacy!" Not only did the Hellepontine cities, with Byzantium at their head, join the Ionians, but also a great part of the Carians, the Greeks in the Troad, and almost the whole of the very flourishing island of Cyprus. By this time the possession of these lands was really endangered by the revolt. But now the Persians came with a great fleet to Cyprus. The Ionians sailed to meet them, beat them at sea off Salamis in Cyprus, but were beaten by the Persians on land. After great struggles, which are described in an almost epic style, befitting the primitive state of the island, Cyprus came once more under the power of the Persians, after being free only one year. This was the first heavy blow to the insurrection. Much fighting took place on the mainland; and most of the Persian enterprises were successful, but not all. In particular the Carians, who in general displayed great gallantry in this war, annihilated a whole Persian army under a son-in-law of Darius. But the longer the war lasted, the more marked became the progress made by the Persians. Aristagoras left the seat of war, and withdrew to his possessions of Myrcinus on the Lake of Prasias in the south of Thrace, near what was afterwards Amphipolis, but was there slain by natives as early as 497.<sup>1</sup> Darius then despatched Histieus, whom he still continued to believe faithful, to Ionia, probably in order to open negotiations. He availed himself of the opportunity to seek to regain the lordship of Miletus and put himself at the head of the whole revolt, but the Milesians would have nothing more to do with him or with Aristagoras. The great intriguer had connexions on all sides, but no one trusted him in the long run. He became at last a pirate on his own account; and after many adventures he fell into the hands of the Persians and was crucified. It is a noteworthy fact that Histieus had actually concerted a conspiracy with the Persians in Sardis, against Artaphernes and Darius, the discovery of which cost many their head. Fidelity has never been an Iranian virtue.

The decisive struggle was concentrated about Miletus. There, at the little island of Lade, as Grote points out, the odds against the Greek fleet (600 triremes against 353) were not so unfavourable as they were at Salamis, and the want of unity of leadership was not much greater than it was there; but the Ionians and Lesbians were not, or were no longer, the equals of the European Greeks in bravery and warlike skill. A complete overthrow was the result, in which treachery on the Greek side had its share. Miletus long defended itself by sea and land, but was at last taken and destroyed; the women and children were sold as slaves. The captured Milesians were carried off into the heart of Asia and settled at Susa. Miletus, up to that time by far the most important of all Greek cities in Asia, though it afterwards recovered, still never regained its old position. The most important city of the coast was henceforward Ephesus, which took no part in the battle of Lade, and perhaps had at that time already submitted amicably to the Persians.

The subjugation of the rest of the Greeks of the mainland and islands, as well as of the Carians, now rapidly followed, not without dreadful massacres and devastations. The Phœnicians, who formed the main body of the Persian fleet, seem to have been especially zealous in the work of destruction. The old bitterness between the Canaanites and the Hellenes, so vividly shown during these centuries in Sicily, cannot have died out in the east. In ruined Ionia a frightful state of things must have prevailed, so that at last Artaphernes saw himself obliged to undertake a regular organization to ensure the peace of the country. At

the same time he caused the land to be surveyed and established fixed imposts.<sup>2</sup> These were not higher than before the war, but naturally they now pressed much harder on the impoverished Ionians. Thereupon the young Mardonius, son of the Gobryas who has been mentioned before, and brother-in-law and son-in-law of the king, established democracies in all Ionian cities. The weakened communities might well seem to the Persians at that time less dangerous than ambitious tyrants. However, this measure apparently applied only to the Ionians of the mainland, not to the islanders nor to the other Greeks of the mainland.

Mardonius cherished great designs. He wished to conquer Greece itself. He did actually conquer Greeks and non-Greeks in the north-west of the Archipelago, but at the promontory of Athos his fleet was shattered by a storm.

The second expedition against Greece was on a greater scale. Under the conduct of the Mede Datis and the younger Artaphernes, son of Darius's brother of the same name, the Persians took Naxos, and destroyed Eretria in Eubœa, the inhabitants of which had sent five ships to help the Ionians at the beginning of the revolt. But at Marathon they were utterly defeated by the Athenians and Plataeans (September or October 490). They quickly renounced the project of subjecting Athens to Hippias as tyrant and to Darius as suzerain, and departed home. Miltiades, who, as lord of the Thracian Chersonese, had once been the king's vassal and had afterwards been obliged to fly, had taken the measure of the Persian. By his victory Athens had rendered immortal service to Europe and the cause of civilization. It was the first great victory of the Greeks over the Persians in the open field; the moral impression had an immense effect in the sequel, when the danger was much greater.

The south-west of the empire alone had hitherto remained free from rebellion against Darius. Darius, who had been with Cambyses in Egypt (Herod., iii. 139), treated the Egyptians with forbearance, and in return loyal priests praised him to fellow-countrymen and Greeks. If a notice of Polyænus is to be trusted, he must have gone in person to Egypt in the year 517,<sup>3</sup> in order to lighten the burdens of the people. Amongst other measures which promoted the material wellbeing of the land, he made a canal from the Nile to the Red Sea, as an inscription of the king himself testifies to this day. But the hatred of the Egyptians to the Persians was too great. In the year 486 (Herod., vii. 1, 4) the first great insurrection of the Egyptians against the Persians took place. From an inscription we know that during it Khabbash or Khabeah was king of Egypt. Darius did not live to see the revolt put down, for he died in the following year, 485.

Darius is the most remarkable king of the dynasty of the Achemenians, and perhaps the most remarkable of all the native kings of Iran. So far as we know, only the Sasanid Khosrau I. in the 6th and the Safavid Abbas the Great in the 17th century A.D. can be compared with him. He was as energetic as he was prudent. He was of course a despot, and could be ruthless and even cruel, but on the whole he was inclined to be mild. We lay especial weight on the testimony of Æschylus, who had himself fought at Marathon against the army of Darius, and who shared the exasperation of the Athenians against the Persians, but nevertheless in his *Persæ* expresses very high respect for the king. This, then, was the judgment of educated Greeks on the prince who had brought such untold misery upon their nation. To such a judgment great weight is to be attached. In harmony with it are the particulars which we know of the doings and ordi-

<sup>1</sup> Herod., vi. 42; Diod., x. 59.

<sup>2</sup> See Wiedemann, *op. cit.*, p. 287.

<sup>3</sup> Thuc., iv. 102.

nances of Darius. He seems, too, to have shown a correct insight in his choice of the persons to whom he entrusted important positions.

He succeeded, apparently without any disturbance, by his son Xerxes (*Kshayarshah*) I, who, as son of Atossa, elder daughter of Cyrus, had probably always been regarded as heir-apparent.<sup>1</sup> The time was not yet come when claimants to the throne and suspects were assassinated. On the contrary, the king's blood-relations played under Xerxes as under Darius a great rôle as leaders and counsellors. But the whole generation was probably deeply degenerate, though the difference could hardly anywhere have been so great as that between Darius and Xerxes, who begins the series of weak and unworthy kings.

The subjugation of Egypt was effected in 484 (Herod., vii. 7). The measures taken by Khabbeah to protect the mouths of the Nile against the "fleet of the Asiatics" had thus been unsuccessful. According to Herodotus a much harder yoke was laid on Egypt than before. The king's own brother Achæmenes was made satrap of the country.

Babylon too seems to have again risen in revolt. Ctesias assigns to this date the revolt with which the well-known story of Zopyrus<sup>2</sup> is connected, naming instead of Zopyrus his son Megabyzus. The long siege of which Herodotus speaks does not, as we saw, fit in with the revolt under Darius; it belongs, perhaps, to the time of Xerxes. Ctesias gives us to understand that Xerxes wounded the religious feelings of the Babylonians, and Herodotus speaks expressly of the desecration of their sanctuaries by the same king (i. 183). To the victorious Macedonians, who emphatically asserted that they were come to avenge the destruction of Greek temples by Xerxes, the Babylonian priests afterwards told many tales of the outrages he perpetrated on their sanctuaries.<sup>3</sup> Doubtless they grossly exaggerated, but they did not invent everything. Of course such sacrileges may equally well have taken place when the city was reconquered, or have been the occasion of a revolt.

Darius was firmly resolved to wipe out the disgrace of Marathon, and to bring the whole of Greece under the yoke. His mighty preparations for the march thither had been interrupted by the revolt of Egypt, and, if our conjecture is right, of Babylon. They were now vigorously recommenced; and provision was made for the maintenance of the army, at least within the limits of the Persian domain. Xerxes himself went to Sardis, the first great rendezvous. From there he set forward in the spring of 480. We will not further describe the great expedition, which, after the dearly-bought successes at Thermopylae and Artemisium, ended with the defeats of Salamis (September 480) and Platea (479)—all this belongs rather to the history of Greece—but we will briefly discuss the causes which procured for the disunited and far from numerous Greeks a victory over the mighty power of the great empire. It may very well be said that it would have been possible to subdue even Hellas, and to put an incalculable check upon the Greek spirit, if the great enterprise had been conducted with more sagacity. There was no lack of Greek traitors, nor even of traitor states, from which the king might have learned how to set about the business. But the blind arrogance of the Asiatic king was bent on bearing down everything by the sheer weight of his masses, and when he failed in this his arrogance passed at once into childish cowardice. The fleet certainly mustered over 1200 sail at the beginning of the war, and even

after the heavy losses by storms at Euboea, losses, however which the Greeks no doubt exaggerated, it must with reinforcements have numbered fully 1000 ships of war,—a force too large to operate, at least in a single mass, in the narrow Greek seas. Moreover, it was without an able head. If the ships furnished by the Phœnicians and the subject Greeks were fairly a match for those of the free Greeks, on the other hand the Persians, Medes, and Sæces who manned the fleet as soldiers probably cut but a sorry figure, and the Persian officers associated with the native ship captains cannot have contributed to the more efficient working of these powerful engines of war. Again, the army, which in any case numbered over a million men, was far too numerous to find sufficient sustenance for any length of time, in spite of the frugal habits which mostly characterize Asiatics. To this must be added the circumstance that the levies were drawn from peoples many of whom were totally unused to the Greek climate. Famine and pestilence must have wrought dreadful havoc among the soldiers. By far the most of them were a useless rabble. Of the Asiatics proper probably only some Persian and Median regiments of guards were well armed, but even they were not to be compared, man for man, with the heavy-armed soldier-citizens of Greece. Moreover, in the use of their weapons on land the Greeks, and above all the Spartans, were far superior to all the Persians. Even the Greeks on the Persian side were no match for the Greeks of Europe; some of them fought half-heartedly, and an anxious watch was kept on them, so that they were more a hindrance than a help. If the Persians were kept well informed of the enemy's affairs by means of traitorous Greeks, much more so were the Greeks through deserters and friends in the enemy's camp. Even when the Persians were driven by necessity to take the resolution of sending back all worthless troops, and when the king had fled, Greece was still in great danger, for an able man, Mardonius, now stood with the best part of the army in the heart of the country. But even with a defeat at Platea all would not have been over, for the enemy was without his fleet. Add to all this the excellent bearing of those Greeks who remained faithful to their fatherland. Exemplary above all was the conduct of Athens; she durst not allow the laurels won at Marathon to wither. The Spartans, too, with their morbidly exaggerated sense of military honour, earned immortal renown. Even petty Greek communities like Thespia, Tegea, and Ægina came gloriously to the front. At the head of the Greeks stood many distinguished men, above all Themistocles. On the whole, we may say that here Greek intellect, Greek valour, and Greek virtue triumphed over the spiritless and helpless hordes of Asiatic slaves.

Here and there a modern<sup>4</sup> has expressed the opinion that the conquest of the Greeks by the Persians would have been no such great misfortune after all, inasmuch as the intellectual superiority of the former would have asserted itself even under a foreign dominion, especially as the Persians were not regular barbarians; but this opinion is entirely false. Only in a free country could the Greek spirit fully unfold itself, only in democratic Athens could it accomplish its highest work and achieve imperishable results for all time. In the externals of civilization the Asiatics might, in some respects, be actually the superiors of the Greeks; but genuine free human culture first arose among the latter, and if there was one pride that was justified it was that of the cultivated Greeks as against all barbarians. The Greeks themselves had no inkling of the high sense in which the watchword at Salamis, "All is at stake" (*Æschyl., Pers., 405*), was applicable to the whole of human culture.

<sup>1</sup> In spite of the anecdote in Herod., vii. 2-4; Justin, ii. 10; Plut., *De frat. amore*, p. 483, and *Reg. apophth.*, p. 178.

<sup>2</sup> This story, with all sorts of variations, is very widely spread in the East, but it can hardly rest on an historical fact.

<sup>3</sup> Arrian, vii. 17, 2; Strabo, 738.

<sup>4</sup> E.g., Maspero, *Hist. ancienne des peuples de l'Orient*, chap. xiv.

King Xerxes had shown himself in the war a thoroughly commonplace Eastern despot, as boastful as he was effeminate. The dreadful sacrifice described by Herodotus (vii. 114) may be excused on the ground of religious superstition, but the mutilation of the corpse of Leonidas and the decapitation of the Phœnicians who commanded the fleet show the spirit of the man. His disgraceful flight must have been welcome to Mardonius. The latter fell like a man at Plataea; indeed the battle of Plataea did honour to a large part of the vanquished. Of course great masses of the vast army returned to Asia, several doubtless still in good order, but many, very many, must have perished in Greece, and in Thrace, where the savage Thracians cut off large numbers of the fugitives.

The Greek fleet did not at first venture to pursue the Persians to Asia, but afterwards it crossed at the request of the Greek islanders. At the headland of Mycale, not far from Miletus, the remainder of the Persian fleet was annihilated just about the time of the battle of Plataea. The liberation of the islands and of the greater part of the Greek cities on the coast of Thrace followed. Thrace and Macedonia regained their independence without any effort of their own. The whole of the islands were permanently wrested from the Persians, and the liberation of the Asiatic coast was already begun.

We stand here at the decisive turning-point of Persian history. Henceforward Greece might be coveted and designs against it cherished, but no enterprises were undertaken. The Persians were thrown back upon the defensive. Though they often afterwards exercised an influence on the history of Hellas by means of money or diplomacy, still the respect for their fighting power was gone, and so far it is possible to regard Alexander's expedition as a result and continuation of the old struggles, and the saying of Æschylus, "In Salamis the power of the Persians lies buried," may be called prophetic.<sup>1</sup>

Xerxes was still in Sardis when his full brother Masistes came thither with the beaten forces from Mycale. Disquieted probably by the neighbourhood of the victors, the king retired into the depths of Asia. About the same time he deeply offended Masistes on a point of family honour; in revenge Masistes intended to go to his province of Bactria and there raise a revolt, but was cut down by horsemen despatched after him (Herod., vii. 108 sq.). This story (like that told by Herodotus in iv. 13) exhibits all those horrors of a later age which Ctesias loves to paint. The idea of a revolt, moreover, was not far to seek after the profound humiliation inflicted by the Greek war and the dreadful losses of men—how many Sogdians, Indians, and Nubians can have returned to their homes? The inhabitants of distant frontier lands may even then have severed their connexion with Persia, and even then mountain and desert tribes in the very heart of the empire may have regained their full independence.

Unfortunately the work of Herodotus breaks off abruptly with the battle of Mycale, and with it our only continuous ancient history of the empire comes to an end. The fragments of Ctesias and the occasional statements of other writers can only, to a small extent, supply the deficiency. Henceforward we possess tolerable information on the shifting relations between the Persian empire and the Greek states, but on little else.

Under the conduct of Pausanias, the victor of Plataea, the Greeks sailed (477) first to Cyprus and then to Byzantium. At the capture of the latter many distinguished Persians fell into their hands, and Pausanias, who must have appeared to Xerxes as a sort of king of Greece, took advantage of this opportunity to open a correspondence with

the Persian monarch. Artabazus, son of the Pharnaces who had held a command under Mardonius, received the satrapy of Hellespontine Phrygia (where his family retained the power thenceforward down to the fall of the empire), for the purpose of conducting the negotiations. The definite statements of Thucydides leave no doubt as to Pausanias's guilt. In particular the king's letter (i. 129) bears every mark of genuineness. Happily he proved himself a clumsy intriguer, and when long afterwards in Sparta retribution at last overtook him he had ceased to be dangerous, at least for the freedom of Greece as a whole. The conduct of Pausanias, together with a want of inclination and capacity for distant naval expeditions, caused the Spartans to resign the conduct of the maritime war against Persia. They withdrew, and the command passed into the hands of the Athenians (476). The naval power of Sparta was quite insignificant, and was certainly surpassed by that of some of her allies, such as Ægina and Corinth; and the advantage to Persia of the absence of the Peloponnesian fleet was far more than counter-balanced by the circumstance that the Greek naval forces were now under a single energetic leadership, which aimed at nothing less than the exclusion of the enemy from all Greek seas and coasts. The war lasted for a long time, but few of its details are known to us, though the scanty statements of the Greek writers are partly illustrated by Attic inscriptions. The European coast was soon completely cleared. Eion fell after an arduous siege (about 470). Doriscus alone continued for long to be a Persian possession. The most brilliant episode of this period of the war is the great naval expedition of Cimon.<sup>2</sup> He liberated the Greek cities of the Carian and Lycian coast, and took the bilingual towns, which were occupied by a Persian force; all were incorporated in an Attic maritime league. The important Phaselis on the borders of Lycia and Pamphylia also fell into his hands. At the mouth of the Eurymedon the Persian fleet, under a son and a nephew of Xerxes, was defeated and destroyed, and a land-victory for the Greeks followed immediately. Upon this Cimon sailed hastily for Cyprus, where he captured eighty ships. Here for once the Greeks were numerically superior, but nevertheless it was a great exploit to have advanced victoriously so far beyond their own waters.

About this time Xerxes was assassinated. From various writers we can piece together an account of this event by Ctesias, and another by Dinon,<sup>3</sup> which differ from each other in numerous particulars; a third version is given by Aristotle (*Pol.*, p. 1311 b). For such scenes, occurring in the interior of the seraglio, an outsider is not a trustworthy authority, but this much is clear: Xerxes was killed by Artabanus, captain of the body-guard; his youngest son Artaxerxes, in league with the murderer, put to death his elder brother Darius, who had a better title to the throne. It does not, however, follow with certainty that Artaxerxes was a parricide. We have here a change of sovereign of the sort which abounds in Oriental history. Artabanus was soon afterwards put out of the way by Artaxerxes. Later chronologists represent him as actually reigning for seven months, but this is probably a mistaken interpretation of expressions used by Dinon.

Artaxerxes (*Artakshathra*<sup>4</sup>) I came to the throne in 464. His surname "Longhand" (*Μακρόχειρ*), which seems to have been first mentioned by Dinon, has no doubt a symbolical meaning, "of far-reaching power," but later Greek writers took it literally. Ctesias tells of a

<sup>1</sup> About 465. Perhaps it falls within the reign of Artaxerxes.

<sup>2</sup> He wrote in the time of Alexander.

<sup>4</sup> A second form, *Artakshasth*, is represented by Hebrew and Egyptian forms, and by *Artakshasth* on a Greek inscription (Le Bas and Waddington, No. 1651).

<sup>1</sup> Æschyl., *Pers.*, 596 sq. The brevity and simplicity of the expression *ἔχει τὴν ἡγεμονίαν* cannot be rendered in any modern language.

rising of the Bactrians immediately after his accession to the throne, which may have been instigated by Hystaspes, the king's elder brother, who was then in his satrapy of Bactria (Diod., xi. 69). Two battles took place, the second of which ended in a decisive victory for the royalists, so that Bactria was once more reduced to subjection.

In the early part of the reign of Artaxerxes falls the appearance of Themistocles at the Persian court; so say the contemporary Charon of Lampascus (Plut., *Themist.*, 27), and also Thucydides (i. 137); to their authority that of all later writers, who here mention Xerxes, must give way. On calmly weighing the trustworthy accounts and taking into consideration the circumstance that even at a later time Themistocles as a "traitor" was refused a grave in Attic earth, we can hardly avoid concluding that the gifted saviour of Greece, the founder of the Attic seapower, a man far superior intellectually to Pausanias, but of boundless ambition, and with a strong propensity to intrigue, was really guilty of entering into traitorous communication with the Persians in his own interest. Certainly he knew admirably how to give himself out as an old friend of the Persians,<sup>1</sup> and to hold out to them the prospect of still doing them valuable service against his countrymen. The king gave him Magnesia on the Mæander in Lydia and two other towns; as the tyrant of these places under Persian supremacy the victor of Salamis lived some time longer.<sup>2</sup> Like this illustrious fugitive, other Greek exiles or adventurers came to the Persian court from time to time, and played there occasionally a certain rôle.

Hardly was Artaxerxes seated on the throne when the second great revolt of Egypt broke out. Inarus, son of Psammethichus, a Libyan prince, placed himself at the head of the Egyptians and was made king of the whole country. The satrap Achæmenes, son of Darius, fell in battle. Inarus summoned to his aid the Athenians, who were still at war with the Persians, and the Athenians were rash enough to involve themselves in the struggle (about 460). They had just come once more to Cyprus with 200 ships. They sailed to Egypt, and with the help of the Egyptians shut up the Persians and the Egyptians who sided with them in the castle of Memphis. Persia had recourse to diplomacy: an embassy was sent to Sparta in order to stir up the Spartans to make a vigorous diversion against Athens. When this attempt failed, a large army was at last despatched under Megabyzus, son of Zopyrus, which subdued the country after hard fighting; for, with all their hatred of the Persians, the Egyptians were no match for them in battle. The Athenians in Egypt were annihilated (probably 455); the same fate befell a reinforcement of fifty ships. Inarus fell by treachery into the hands of the Persians and was crucified. His son Thannyras, however, received (Herod., iii. 15) his original province (probably the Libyan nome), which points to the war having been concluded by a treaty, of which Ctesias also makes mention. In the swamps of the Delta Amyrtæus (Amun-art-rut) maintained himself as an independent king; and by him the Athenians were once more invited to Egypt (450 or 449). Cimon, who was again at Cyprus with 200 ships, despatched sixty to his help, but they soon returned, probably without accomplishing much. Cimon died during the siege of Citium, one of the most important cities of Cyprus, and the mainstay of the Phœnician nationality on

that island. The Athenians raised the siege, but achieved on their retreat once more a brilliant victory by sea and land.<sup>3</sup>

These are the last contests of the Athenians and their allies with the Persians. Peace must have been concluded shortly afterwards. We cannot here enumerate and criticize the arguments which have often been adduced for and against the supposition that a regular peace (though not a "peace of Cimon") was concluded. No one probably would have questioned the reality of such a peace were it not that the Attic orators of the 4th century, by grossly exaggerating the terms of a treaty which in their time had long been a dead letter, had rendered the very existence of the treaty open to suspicion, and that the able historian Theopompus, moved apparently by dislike of the Athenian democracy and a desire to gratify his powerful patron, King Alexander, had attempted by false though learned arguments to disprove the genuineness of the original treaty of peace, of which only a copy was extant in his time. The text of the original document was given by the best authority on Attic decrees, Craterus.<sup>4</sup> It is hardly conceivable that the great war should have died out of itself without the Athenians getting some security that their possessions and their widely ramifying commerce would be left unmolested. Moreover, all that we are told or can infer as to the contents of the treaty agrees perfectly with the political relations of the time. The treaty was not at all in the spirit of the high-flying plans of Cimon's party; for, while the Persians acknowledged the independence of the Greek towns on the west coast, including the Lycian, and pledged themselves to send no ships of war into Greek waters, the Athenians in return renounced all rights in the eastern sea. The most sagacious of the Athenians had perceived that Cyprus, and much more Egypt and Phœnicia, lay outside the natural sphere of Athenian power. We can understand, however, that Callias, the author of the treaty, earned the dislike of the Athenians for his pains. The balance of advantages secured by the peace was on the side of Athens, but the Persians resigned nothing which they actually possessed, and they were now secured against Athenian raids. It was certainly anomalous that the great empire which owned the rest of Asia Minor should have no rights over the narrow strip of coast, which could everywhere be overlooked from the interior. Even the capital of the Hellespontine-Phrygian satrapy, Dascylium, from which that province is sometimes called Dascylium, was now a member of the Attic naval confederacy. The satraps were still obliged as before to pay to the king the taxes due from the coast-lands, and this must have been a constant incitement to them to reconquer those lands. There was no Persian fleet in the Black Sea. The Greek towns on its coast were free, and some of them belonged to the Athenian league and were occasionally visited by Athenian war-ships. At most a portion of the natives of the countries round about the Black Sea were in a state of loose dependence on the Persian empire. In Lycia and Caria there were districts which obeyed neither the king nor Athens, or at least were not closely dependent on any foreign power.<sup>5</sup>

The condition of Egypt at this time is very obscure. Amyrtæus had no doubt been finally overthrown by the Persians, but his son Pausiris was left by them in possession of his father's kingdom. In the year 445 we find an Egyptian or Libyan king, Psammethichus, who presented the Athenians with a great quantity of corn.<sup>6</sup> This was

<sup>1</sup> But the letter in Thuc., i. 137, cannot be regarded as an authentic document.

<sup>2</sup> Here, too, he coined money. Of the two specimens known to us, one is plated, "which seems to show that with the coinage the cunning Athenian combined a financial speculation," Brandis, *Münz-, Med.-, und Geschichtsw. Vorträge*, p. 459.

<sup>3</sup> The epigram which Diodorus (xi. 62) wrongly applies to the battle of the Eurymedon refers to this battle.

<sup>4</sup> Shortly after Alexander. <sup>5</sup> Compare Thuc., ii. 69; Hl. 18. <sup>6</sup> Philochorus, in schol. Aristoph. *Vesp.*, 716; schol. Aristoph. *Plut.* 178; Plut., *Pericles*, 37.



perhaps another son of Inarus. But we know nothing more of him and his reign.

The conclusion of peace did not prevent the Persians, or at least individual satraps, from occasionally supporting enemies of Athens. Samian oligarchs, with the help of Pisuthnes, satrap of Sardis, made themselves masters of the island (440 or 439), and estranged it from Athens. The Athenians feared that a Phœnician fleet might come to the help of the oligarchs, but not a Persian interfered when they reduced the island once more to subjection. About 430 Colophon was made over to Itamenes (no doubt a Persian general or governor) and the barbarians by a party among the inhabitants favourable to Persia, and thereupon Notium,<sup>1</sup> a dependency of Colophon, was also occupied by the royalists, for thither also Pisuthnes despatched Persian troops, who entrenched themselves in the town. Amongst these troops were Arcadian mercenaries. This is the first undoubted mention of Greek mercenaries in Persian pay; henceforward they play a very great part in the history of the empire. The Persian rulers had observed how far superior the Greeks were to the Asiatics, and in Greece there were always plenty of stout fellows who were impelled by political events, the love of adventure, or poverty to enter foreign service as soldiers of fortune. Most of them came from the Peloponnesus, presumably from the mountains of Arcadia, which yielded but a scanty subsistence to its inhabitants. The Athenian party in Notium called in the Athenian admiral Paches; by shameful perfidy he made himself master of the entrenchments, and put the garrison to the sword. With Notium, Colophon was now once more a member of the Athenian league. No further consequences followed from these hostilities.

During the early years of the Peloponnesian War the Spartans repeatedly held communications with the Persians, whose assistance they desired against Athens. These negotiations were, for the time being, without result. The Spartan diplomatists were unskilful, and the Persian authorities were cowardly, indolent, ignorant, and selfish.<sup>2</sup> The impecunious Peloponnesians wished above all for Persian gold, and, moreover, for the Phœnician war-ships. The Athenians also tried to tap the inexhaustible source of wealth for their own benefit, but of course in vain.<sup>3</sup>

Of the internal state of the empire during the long reign of Artaxerxes I. we know very little. Ctesias, or rather the extract of him made, not always carefully, by Photius, tells us indeed various stories, but he jumbles together fact and fiction, history and anecdote. Of most importance is the quarrel of Megabyzus, conqueror of Egypt, with the Persian court; he maintained a rebellion for several years in Syria, till at last, after several conflicts, a full pardon was assured him by treaty. It is not improbable that this war was the occasion of the destruction of the walls and gates of Jerusalem lamented by Nehemiah (in the year 445). According to Ctesias, Megabyzus afterwards fell into disgrace again, but was again taken into favour. In all these complications an important part is played by those cruel, intriguing, dissolute women, the queen-mother Amestris, daughter of Otanes, of whose character we get a very unpleasant view from Herodotus (vii. 114; ix. 109 *sq.*), and her daughter Amytis, wife of Megabyzus. Even without an exact knowledge of the circumstances, we can well understand how it was that Zopyrus, son of Megabyzus, came to take refuge in Athens. He fell while attempting, in company with the Athenians,

to capture Caunus (in Caria), which had revolted. His grandmother Amestris got the Carian who had killed him into her power and had him crucified.

From Nehemiah's memoirs we see that in those days one who was not a Persian might not only fill the tolerably high office of cupbearer<sup>4</sup> in the royal household, but might also become deputy-governor over his fellow-countrymen.

The history of Ctesias, untrustworthy as it is in particulars, shows us the manner of life at court. Artaxerxes I. was a very weak man, and women and favourites took the government out of his hands. Still, he may have deserved the praise, often bestowed on him, of good-nature. He may also have been of stately presence; as an Iranian chief he was doubtless an excellent huntsman<sup>5</sup>; but his "incredibilia virtus belli" (Nepos, *De regibus*, 1) is precisely "incredibilia." In reading the eulogies of Persian kings we must always remember that the ultimate sources of writers like Ctesias and Dinon are court news, wherein even the deceased kings are spoken of in a courtly tone.

Artaxerxes died in 424. His successor, Xerxes II., the only one of his eighteen sons who was legitimate,<sup>6</sup> was murdered after a month and a half by his brother Secydianus or Sogdianus. But after six and a half months<sup>7</sup> the murderer was in his turn overthrown by his brother Ochus, satrap of Hyrcania, and, in violation of solemn oath, put to death.<sup>8</sup> Ochus assumed the name of Darius, ascending the throne about the beginning of the year 422.<sup>9</sup> Darius II. is called Nothus or Syrus,<sup>10</sup> because his mother was a Babylonian concubine. From the first mention of him by Ctesias his wife and sister Parysatis appears as the prompter of all his acts and all his crimes; and this mischievous woman possessed the greatest influence for many years. The king's full brother Arsites, in conjunction with another son of Megabyzus, Artyphius, raised the standard of revolt, probably in Syria. But his Greek soldiers were bribed, and thus he fell into the hands of the royalists, and, in violation of the oath, was put to death at the instigation of Parysatis. The same fate befell some of those who had taken part in the murder of Xerxes II. Darius had presumably come forward from the beginning as his avenger. Soon after 410 the great revolt of the Egyptians was successfully accomplished. The first independent king was called Amyrtæus, and was presumably a grandson or other relative of the former Amyrtæus. The deep decay of the Persian military power is proved by the fact that for sixty years it failed to reduce the unwarlike Egyptians, though the latter were frequently divided amongst themselves by internal dissension and double rulers.

The above-mentioned Pisuthnes, satrap of Sardis, had also revolted. Timaphernes, who here appears for the first time, put down the rebellion by the usual means of bribery and perjury; the Athenian Lycon, leader of Pisuthnes's Greek mercenaries, plays a far from honourable part in the affair. The events fall after 424, and at least some years before 412. But Pisuthnes's son Amorges continued

<sup>4</sup> Cp. Herod., iii. 84, and Nicol. Damasc. (i. e., Ctesias), 64.

<sup>5</sup> Cp. the anecdote of Ctesias in Photius about his lion hunt.

<sup>6</sup> This probably means that the wife who bore him was of a noble Persian family.

<sup>7</sup> No reliance is to be placed on these numbers in Ctesias. Others assign to the two monarchs two and seven months respectively. In any case they did not together reign a full year, since the astronomical canon ignores them.

<sup>8</sup> Cp. also Pausanias, vi. 5, 3, where probably we should read *Zōpyrus* with Bekker.

<sup>9</sup> The beginning of 411 falls according to the document in Thuc., viii. 53, in his thirteenth year; this is probably a reckoning which begins the year with the spring, and accordingly reckons his first year (or rather the year in which he came to the throne) from the spring of 424 to 423. The astronomical canon begins the year of his accession with 7th December 424.

<sup>10</sup> Hypothesis of *Æschyl.*, *Pers.*, and schol. on v. 6.

<sup>1</sup> In addition to purely political opposition, the local jealousy between Notium and its "superior town" Colophon had its share in the matter. See Aristot., *Pol.*, p. 1303 b.

<sup>2</sup> See Thuc., ii. 67; iii. 81; iv. 50.

<sup>3</sup> Aristophanes, in the *Acharians* (represented Junius? R.G.), ridicules these long and fruitless negotiations of the Greeks with the Persian king.

the revolt in Caria, and was supported therein by the Athenians, perhaps because they already knew for certain that Tissaphernes was preparing to help the Spartans.<sup>1</sup>

When the power of Athens seemed annihilated by the dreadful catastrophe in Sicily, the Persians expected to regain the whole sea-coast. Tissaphernes, satrap of Sardis, and his rival Pharnabazus, satrap of Hellespontine Phrygia, vied with each other in invoking the help of the Spartans. The party hostile to Athens in the cities of the mainland and in the islands displayed great zeal in bringing about the alliance. Moreover, the no less able than infamous Alcibiades strained every nerve to secure so favourable an opportunity of distinguishing himself personally and injuring his native city. Not without reluctance the Spartans resolved on a decisive step. They might have known beforehand that they would only receive real support from the Persians on condition of surrendering to them a great portion of the Greek cities which had once been freed by Athens, though now mostly hostile to her. They chose to attach themselves to the more powerful but, as it soon appeared, wholly untrustworthy Tissaphernes rather than to Pharnabazus. Of course the confederates did the Athenians much damage, and wrested from them a great part of their domain. The Lacedæmonians actually served the satrap as catchpolls against Amorges, who resided in Iassus near Miletus, and so he could be taken captive and carried alive to the king. But the Athenians still exhibited astonishing endurance and resource. It is true that neither of the confederates meant honestly by the other. Whether from avarice or mere whim, Tissaphernes supplied the Peloponnesians in insufficient measure with money and stores, and without these they were not in a position to wage war in Asia. The intrigues of Alcibiades contributed to sow mistrust and confusion. The Spartan leaders repeatedly concluded treaties with the satrap, but they were not ratified. At last it was agreed that the whole mainland of Asia, and therefore all the Greek cities there, should belong to the king, but that in return for this the Persians should give the Spartans effective help. If Tissaphernes had rapidly and energetically carried out the terms of this treaty, the war might perhaps have been ended quickly enough. But to keep faith was contrary to the nature of the man. Moreover, he had probably promised more than he could perform: to bring up the great Phœnician fleet was not quite in his power. The Phœnicians themselves, and perhaps high Persian lords also, had certainly little desire to engage again the Attic galleys which had handled them so roughly at the Eurymedon and at Cyprus. Pharnabazus supported the Spartans much more honourably and effectively. This he showed especially when the Athenians were again making steady progress (410) under the leadership of Alcibiades after his return. The Athenians now devastated the king's territory in various places, and Pharnabazus had at length to engage to forward Athenian envoys to the king for the purpose of conducting negotiations for a peace (409) at the court itself. But events now took a decisive turn. Cyrus, the king's son, was made satrap of Lydia, Great Phrygia, and Cappadocia, and commander-in-chief of all the troops in Asia Minor, Tissaphernes retaining only the coast-cities (408). Cyrus possessed burning ambition, and longed to avenge the defeats which his house had experienced at the hands of the Athenians. Hence he sought to unite himself closely with the Spartans. Just at this time the command fell to the cunning, energetic, and unscrupulous Lysander. These two men were the ruin of Athens. Cyrus granted Lysander, who had

completely won his affection, all the money he wanted, and when after Lysander's temporary recall the relations with Sparta were disturbed, because the noble Callicratidas did not care to play the courtier to the barbarians, the return of Lysander sufficed to put everything on its former footing. When Cyrus was summoned to the bedside of Darius (either really ill or pretending to be so), he left his Spartan friend the most abundant resources and the fullest authority. With this help Lysander succeeded in at last compelling Athens, now completely isolated, to accept the melancholy peace of March 404. Even after all the misfortunes of Athens it was only Persian gold which enabled the Spartans to humble her.

According to Ctesias, Teritichmes revolted against King Darius, caused his wife Amestris, daughter of the king and Parysatis, to be put to death, but was himself slain by treachery. This event, garished in the usual manner with a full measure of perfidy and cruelty, is perhaps to be connected with the unsuccessful revolt of the Medes mentioned by Xenophon (*Hell.*, i. 2, 19) under the year 410/409. In the fall of Teritichmes his sister Statira, wife of the king's eldest son Arsicas,<sup>2</sup> was nearly involved; thenceforward the bitterest hatred subsisted between Parysatis and her daughter-in-law Statira.

About the time of the conclusion of peace between Athens and Sparta Darius II. died. Arsicas ascended the throne under the name of Artaxerxes (II).<sup>3</sup> The surname "Mnemon" (the mindful) seems again to have been first mentioned by Dinon.<sup>4</sup> The younger and much abler son Cyrus, preferred by Parysatis, came with 300 Greek mercenaries, no doubt to seize the throne, but he was too late. Tissaphernes, professedly the friend of Cyrus, warned the king against him, and with good reason. Cyrus was arrested, but at the instance of Parysatis he was released and sent back to his satrapy,—a very unwise measure, for his ambition was only inflamed by his imprisonment and by his exasperation against Tissaphernes.

Meantime Lysander lorded it over the Greeks. He even possessed sufficient influence to induce Pharnabazus, who in other respects was remarkably respectable<sup>5</sup> for a satrap, to violate the law of hospitality by causing Alcibiades to be put to death. But even the patience of Pharnabazus was at last worn out by Lysander; he urgently demanded the recall of the latter, and the Spartans, who had allowed the atrocities of Lysander towards the Greeks to pass unnoticed, respected the satrap's demand, and recalled their admiral (402 or 401).

No sooner was Cyrus in his satrapy again than he began to make great encroachments. He gained over the Ionian cities which belonged to the province of Tissaphernes and laid siege to Miletus, which adhered to Tissaphernes. On Orontes, a partisan of the latter, he made open war. Meantime he collected under false pretexts an army of Greek mercenaries, and in 401 set out with the real purpose of seizing the throne. He had with him nearly 13,000 Greek mercenaries commanded by Clearchus, a Spartan exile, and a vast host of Asiatics. But Tissaphernes hastened into the interior before him to carry the tidings. Of this expedition we have the well-known account by Xenophon, who took part in it.<sup>6</sup> The Spartans favoured

<sup>1</sup> Arsicas is the form in Ctesias; *Plut., Art.*, l. 1. From this Photius has wrongly made Araksas. Dinon called him Oarses. The initial sound was perhaps *o*.

<sup>2</sup> At the very beginning of the new reign Ctesias has again some dreadful stories of murder and intrigue to tell. As court physician of Parysatis he had seen only too much of such things, which are characteristic of the Persian court.

<sup>3</sup> See *Plut.*, l. c.

<sup>4</sup> But the worth of his character has been often over-estimated; the contrast with the baseness of Tissaphernes is apt to place Pharnabazus in too favourable a light.

<sup>5</sup> Good supplementary information is given by Diodorus, who has

<sup>1</sup> On the other hand, Andocides (*De pace*, p. 27), twenty years later, it is true, represents the support given to Amorges rather as the cause of the king's enmity to the Athenians.

the enterprises of their friend, but without openly breaking with the king. Cyrus advanced boldly, confident in the military superiority of the Greeks; but he had some trouble in carrying them with him as far as Syria and Babylonia, for they were not engaged for so distant a goal. He made his way without difficulty into the heart of the empire. Neither the passes of the Taurus leading from Cappadocia into Cilicia nor those of the Amanus from Cilicia into Syria were blocked. The vassal-prince of Cilicia, Syennesis, put a good face on a bad business and let him through. Even the line of defence between Babylonia and the Mesopotamian desert was unoccupied. At Cunaxa, 500 stadia from Babylon,<sup>1</sup> they came upon the mighty royalist army. The Greeks carried everything before them; the king proved a miserable coward and fled. But, in fighting the Asiatic rabble, Clearchus seems to have adhered too pedantically to the cautious Spartan tactics, and not to have dashed with sufficient rapidity at the enemy's centre. Cyrus, however, rushed foolhardily into the mêlée and there fell.

Even if we deduct much from Xenophon's idealistic portrait, we must still admit that Cyrus was a very able and in many respects honourable man, far worthier of the throne than his brother. From his grim mother he probably inherited his spirit and energy. Certainly none of the kings after Darius I. can be compared with him, except perhaps Artaxerxes III. But for Greece, as Grote shows, it was very fortunate that at that time the kingdom of Persia did not fall to a man whose most ardent endeavour it would have been to bring the Greeks into subjugation to himself, and who had learned in the school of Lysander and elsewhere the best means of accomplishing that object.

Cyrus's Greeks were an object of terror to the king's troops. All the deception and crimes employed against them had their source in cowardice. The king's hosts were reinforced by the army of Cyrus, which after their leader's fall passed over to the enemy; but all these Asiatics trembled before the dauntless Greek mercenaries, comparatively few in number as they were and strangers to the country. It is characteristic of the state of the empire that Tissaphernes allowed the Greeks to plunder the villages which were the special property of Parysatis; he probably thought that with the death of her favourite son her power was broken, while he himself had succeeded in appearing as the deliverer of the empire. After electing fresh leaders in place of those who were foully assassinated, the "ten thousand" made themselves a way through wild mountains and wild peoples; they had to endure a thousand dangers and hardships, but from the king's forces they experienced no serious hindrance.

This expedition revealed to the Greeks the weakness of the empire and the cowardice of its rulers and defenders. Cyrus had penetrated to its centre without striking a blow, and an army of ordinary Greek mercenaries proved itself more than a match for the power of the whole empire. It was perceived how helpless the colossus was; it was perceived that great territories, which had been regarded as royal provinces, were completely independent.<sup>2</sup> Independent at that time were the predatory Mysians (in Olympus), Pisidians, and Lycionians;<sup>3</sup> the Lycians (entirely!) and the Bithynians and Paphlagonians half and half,—the last two peoples had kings of their own; further, the Greek

cities on the Euxine; finally, the Carduchi and other wild peoples in the south and north-west of Armenia.

The death of Cyrus widened the breach between Parysatis and Statira. The former could not forget her darling, and succeeded in bringing to a cruel end one after another all who had participated in his death. Statira was exultant; but she was eventually poisoned by her mother-in-law. Artaxerxes was indignant at this deed and banished Parysatis for ever from his sight; but he could not live without the firm guidance of his mother, and soon recalled her.

Tissaphernes succeeded to all the privileges of the post which Cyrus had occupied. This could not but hasten the inevitable conflict with Sparta, which now, at the height of her power, could not bring herself to fulfil the treaty and resign to the Persians all the Greek cities of Asia Minor. The Greeks expected to be protected by Sparta against Tissaphernes, who was already enforcing his rights with the strong arm, and the war which the Spartans began in 401 against the Persians in Asia Minor was no doubt popular, but as a land-power with limited resources they were not in a position to conduct much more than a purely predatory war. The state of Ionia and Eolis must have changed very much for the worse since the termination of the Attic supremacy, and the Asiatic Greeks were now perhaps for the most part unworthy of the blood that ran in streams on their behalf. Tissaphernes and Pharnabazus sought each to shift upon the other the burden of the war, the conduct of which was not essentially altered when the command of the Spartans devolved on Agesilaus (396), who strove in vain to give the struggle the prestige of a Pan-hellenic enterprise. But, when Agesilaus had gained a great victory close to Sardis, Tissaphernes, who had meantime, more from cowardice than treachery, remained inactive in Sardis, was quietly displaced by a successor in the person of Tithraustes, who succeeded in seizing and executing him.<sup>4</sup> The real cause of his fall was the hatred of Parysatis. The game of treaties, which neither side meant to keep, and the efforts of the one satrap to thrust the Spartans upon the other, began afresh. In course of time Agesilaus certainly gained ground rapidly. But his successes were in part much exaggerated even by contemporaries.<sup>5</sup> On the whole, they were predatory expeditions on a large scale, which showed with ever greater clearness the weakness of the empire, but did not directly affect its stability. Even after his great victory, Agesilaus did not venture to attack Sardis—a striking contrast to the speed and thoroughness with which Alexander took possession of these lands. In 394 Agesilaus was recalled, for Sparta needed him in Europe more than in Asia; the intolerable nature of the Spartan supremacy had done more than Persian gold to rouse even the proved allies of Sparta, such as the Thebans and Corinthians, into leaguering themselves with Athens in revolt. When Agesilaus reached the frontier of Boeotia he heard the dreadful tidings of Cnidus.

After the decisive defeat at Ægospotami the admiral of the Athenian fleet, Conon, had fled to Evagoras, prince of Salamis in Cyprus. Evagoras, a tyrant of the "grand" type like Pisistratus or Gelo, favoured Conon's efforts to enter into relations with the Persian king with a view to raise Athens from her fall. When the war between Persia and Sparta broke out, Pharnabazus had made it clear to the court that it was absolutely necessary to raise a fleet, and that no better commander could be found for it than the tried sailor-hero of Athens. Under the leadership of such a man the Persians actually dared to send Phœnician ships once more into those Greek waters which they had long anxiously avoided. But Conon's successes, such especially as the revolt of Rhodes from Sparta (probably in 396),

indirectly made use of the narrative of another writer who shared in the expedition.

<sup>1</sup> So says Ctæstas, who knew the country. Xenophon says 360 stadia. These figures are equal to nearly 58 and 42 English miles respectively,—about 93 and 67 kilometres.

<sup>2</sup> On the effect produced by the expedition, see Xenophon, *Hell.*, vi. 1, 12; Isocrates, *passim*.

<sup>3</sup> At least in part; such mountain peoples did not, of course, form integral wholes, and, if one tribe was independent, another may have obeyed the satrap.

<sup>4</sup> See Diod., xiv. 80; Plut., *Art.*, § 23; Polyanius, vii. 16, 1.  
<sup>5</sup> Isocrates, *Paneg.*, 70.

were crippled by the miserable Oriental administration, e.g., the tardiness in paying the men. Hereupon Conon went himself to the king at Babylon, obtained a grant of the necessary money and powers and the king's consent to bestow the nominal command of the fleet upon the trust-worthy Pharnabazus. Then at the head of the Persian fleet the Athenian admiral utterly defeated the Spartans at Cnidus (beginning of August 394). In a short time nearly all the islands and cities on the Asiatic coast were freed from the Spartan prefects ("harposts"), and Conon carried his point of nowhere occupying the citadels with Persian garrisons. The Spartan sovereignty of the seas, after lasting ten years, was over for ever. Pharnabazus sailed to the Peloponnesus (393), and at Corinth was joyfully greeted by the Greeks gathered for the war with Sparta. He supplied them liberally with money and then returned home, while Conon restored the marine fortifications of Athens. Thus as a matter of fact a Persian fleet now ruled the Archipelago, but it was a menace and danger to Greek freedom no more. It was only with Greek help, under the leadership of a man like Conon, that the king's ships could still achieve much.

As the land-war in Greece dragged on for a long time, the Spartans had again recourse to diplomacy. The new satrap in Sardis, Tiribazus, who in some measure revived the vacillating policy of Tissaphernes, met their advances. He overthrew Conon, who escaped death at his hands only with extreme difficulty and fled to Evagoras, at whose court he must have died soon afterwards.<sup>1</sup> But Tiribazus soon received in the person of Struthas a successor more favourably disposed to Athens. Many conflicts of Greeks against Greeks still took place by land and sea, but all the belligerents were exhausted, at least financially. So, when the Spartans at last succeeded through their ambassador Antalcidas and through Tiribazus in bringing about a peace, all the more important states of Greece found themselves obliged to accede to it, however unwillingly. This is the notorious peace of Antalcidas, which Tiribazus laid before the delegates of the Greeks at Sardis or Ephesus in 387. It is not a mutual compact but a simple edict of the king. It sets forth that in the king's opinion all cities of the Asiatic mainland, as well as the islands of Clazomenæ and Cyprus, ought to belong to him; that, on the other hand, all other Greek states, even the petty ones, ought to be independent, with the single exception of Lemnos, Imbros, and Scyros, which should continue as of old to belong to Athens. If any one refused to accept this decision, upon him the king and his allies (particularly the Spartans) would wage war with all their power.

It is hardly likely that the true import of this document was understood at the Persian court. That the great king should issue a simple order was there regarded as a matter of course, but the Persian statesmen, who really knew the state of affairs, may have had trouble in securing the acknowledgment of the freedom of the islands. By this peace the Spartans personally gained a great success; for they gave up nothing which they still possessed, while by the declaration of the independence of even the petty communities they secured this advantage, that the cities which had hitherto ruled over wider areas were restricted to their own special domain, that, e.g., Thebes, hitherto head of Boeotia, now remained only one of many independent Boeotian cities. Thus Greece was split up into a thousand petty communities, which Sparta, who did not dream of extending the independence to her own subjects, could with ease dominate collectively. Through this peace the Spartans gained for about sixteen years a much greater

power over the Greek mainland than they had ever possessed before, and they ruthlessly turned it to account. Athens, slowly regaining her strength, was appeased by the three islands, but nowhere was "the peace sent down by the king" felt to be a disgrace more keenly than at Athens. In that peace the king issued orders to the Greeks as to his subjects, and the express and definitive surrender of all the Greeks on the Asiatic coasts was felt all the more bitterly in the intellectual capital of Greece because there was no prospect of ever again freeing them as in the days of Xanthippus and Cimón. And yet it was known that the Persian empire was now much weaker than it had been then, and that it was only maintained by Greek mercenaries.<sup>2</sup> The real gain to Persia by the peace was a firm hold on the sea-coast. The domineering attitude towards the other Greeks was a mere appearance. In the following decades the king repeatedly commanded peace, even after Thebes had completely broken the power of Sparta (371). The powers for the time being employed Persian intervention as a means to their own ends, and there were plenty of diplomatic negotiations with the king, but Persia had no advantage from them. Moreover, now one, now another Greek state supported rebel satraps and vassals. They all, the king as well as the rebels, procured mercenaries from Greece.<sup>3</sup>

Meantime another enemy had arisen to the Persian supremacy in the west—an enemy who, if Athens, his friend and sympathizer, had at that time been once more a great naval power with an aggressive policy, might perhaps have excluded the Persians from all the western seas. Evagoras of Salamis had made himself the almost independent lord of Cyprus, relying on the ancestral antagonism of the Greek to the Phœnician element in the island. As early as 390 forces were levied against him. Athens, under obligations to him on Conon's account, supported him openly, although she was at that time still formally leagued with the Persians against Sparta. After the peace of Antalcidas Persia made great efforts to reduce Evagoras again to subjection. He was in league with Egypt, scoured the seas far and wide, and had even for some time maintained a siege of Tyre. The cunning Cypriot also kept up a secret correspondence with the vassal princes of Caria. After a ten years' struggle he had to yield to superior force, but by skilful negotiation with the satraps he was able to procure a tolerable peace. Soon afterwards he was murdered, but his descendants long continued to be princes of different towns in Cyprus.

About this time probably the expedition of Artaxerxes against the Cadusians took place, of which Plutarch, after Dinon, has given us a detailed account.<sup>4</sup> The Cadusians are the inhabitants of the modern Gilán, who were probably never completely subdued, and who certainly by their raids inflicted much annoyance on the neighbouring territory of the king. Darius II. had taken the field against them shortly before his death,<sup>5</sup> and the repeated mention in the fragments of Ctesias of the Cadusians at the time of the Median empire is presumably a reflex of the state of things in his own day. Artaxerxes's campaign turned out disastrously. The king probably thought to crush the wild mountain tribes—who, however, are only to be caught by small and skilfully led armies—by masses of troops; but he fell into an ambush, from which he was only saved by

<sup>1</sup> Compare many passages in the orators and Plato. Especially interesting is the passage in Isocr., *Epist. ad Archid.*, p. 436, on the wild doings of the Greek mercenaries, who were specially burdensome to the Greek cities under Persian rule.

<sup>2</sup> We are told that the king desired the internal peace of Greece, because he hoped thereby to procure mercenaries all the more easily from that country (Diod., xv. 38).

<sup>3</sup> *Artax.*; 24; cp. Diod., xv. 3, 10.

<sup>4</sup> Xenophon, *Hell.*, ii. 1, 13.

<sup>1</sup> This follows, in opposition to other statements, from Lydis, *Pro locis Aristoph.*, p. 155; cp. Isocr., *Paneg.*, 78, and Dinon in Nepes's *Conon*, at the end.

the negotiations which Tiribazus astutely opened with the rebel chieftains. No doubt he had to pay a large sum for his liberation.

Meanwhile the war with Egypt was never quite at a standstill. Even before the subjugation of Evagoras much fighting took place, but without result. Our knowledge of the particulars, even of the chronology, is very inexact. After the conquest of Cyprus the war was renewed. The Egyptian king invited the Athenian Chabrias to take the command, but Pharnabazus contrived that the Athenians should recall him (376/375). Pharnabazus, who by this time must have been about seventy years old, was placed at the head of the army which was being mustered at Aecho on the Phœnician coast. The Athenian mercenaries were commanded by Iphicrates, who had been sent from Athens. The campaign opened successfully, but dissensions arose between Iphicrates and Pharnabazus, whose proceedings were much too slow to suit the dashing freelance, for Pharnabazus had to report everything to court and to ask instructions from the same quarter. This, along with other circumstances, saved Egypt once more (374). There is the old story, too, of the difficulties of the wars of this period—a mutiny amongst the mercenaries for arrears of pay. The third of the great Athenian condottieri, Timotheus, son of Conon, who fought in the king's service against Egypt in 372, seems also to have been unable to effect anything.

The last part of the reign of Artaxerxes II. is filled with revolts of the satraps and chiefs of Asia Minor, of which we have numerous but mostly isolated and, to a large extent, inexact accounts. It is impossible to determine the connexion of events. We do not even know in all cases whether the same names designate the same persons; and we are nowhere exactly informed of the motives which induced the individuals to revolt. It is the more difficult to form a judgment on the events because sometimes the same persons side now with, now against the king. These revolts, which lasted in part into the reign of Artaxerxes III., must have weakened immensely the imperial power in the western provinces, and prepared the way for the Macedonians. Rich Greek cities and energetic tyrants probably won for themselves at that time a tolerably independent position. At the head of those who remained faithful to the king we find Autophradates, satrap of Lydia. He fought the rebels repeatedly. Nevertheless Diodorus (xv. 90) names him among the rebels; and it is, after all, possible that there is here no confusion, but that Autophradates was also a rebel for a time. If we omit some smaller risings, such as that of Tachos, who established himself in a fortress on the Ionian coast (after 380), the series begins with Ariobarzanes, successor of Pharnabazus in the Hellespontine satrapy, and no doubt a near relative. Before the beginning of the revolt (about 367) he had formed connexions with Sparta and with Athens, which again stood at the head of a naval confederacy, and he was supported, at least indirectly, by both states. Accordingly, by the diplomatic intervention of Sparta, Autophradates and Mausolus of Caria were induced to raise the siege of Assus (in the Troad), into which Ariobarzanes had thrown himself. The satrap fell by the treachery of his own son Mithradates into the hands of the royalists and was crucified (probably about 365).<sup>1</sup>

Mausolus (or rather, according to the inscriptions and coins, *Mausollos*, *Μαύσσωλλος*), a native hereditary prince of part of Caria (probably 375-351<sup>2</sup>), had extended his

power tolerably far. These Carian potentates, who bore the title of satraps, were in point of fact but little dependent on Persia, and were watched by the Persians with great mistrust. In their cunning and in the sagacity with which they profited by circumstances they recall the Macedonian kings of that period, whom they also resemble in their patronage—often perhaps ostentatious—of Greek art and manners. Mausolus appears to have once been in open conflict with his suzerain; but, though nothing definite is known on the subject, there is no doubt that he came off without serious harm.

Datames, satrap of Cappadocia, of Carian race, had rendered many good services; in particular he had reduced the nearly independent Paphlagonians once more to subjection to the great king.<sup>3</sup> But at last he also revolted in league with Ariobarzanes. He was a man of great shrewdness and versatility, whose stratagems and adventures afforded much entertainment even to later generations. He long kept the king's troops in check, till he was at last treacherously murdered by Mithradates, son of Ariobarzanes,—the same Mithradates probably whom we found above betraying his father.

The command of the rebel forces was entrusted to Orontes, satrap of Mysia.<sup>4</sup> From the confused accounts it is unfortunately impossible to determine whether he is identical with one or other of the persons of that name who are elsewhere mentioned. Further, we have no clear conception of the position which he occupied in the revolt, nor of the way in which he came to betray his comrades. We read, moreover, of the treachery of a less conspicuous confederate. The rebels had despatched Rheomithres to Tachos, king of Egypt, who sent them fifty war-ships and much money. Rheomithres summoned the commanders to a rocky fortress on the northern coast of Ionia, bound them, and delivered them up to the king.

In the year 361 Tachos actually assumed the offensive against the Persians. On his side he had once more Chabrias as leader of mercenaries, and the aged Agesilaus, officially sent by the Spartans, who were bitterly enraged at the Persians because they had now, after the destruction of the Spartan power by Epaminondas, recognized the independence of Messenia, though in doing so they only carried out the letter of the peace of Antalcidas. But, when Tachos was engaged in Phœnicia, his nephew Nectanebus set himself up as rival king, and Tachos was obliged to take refuge with the Persians. If the Persians had been still energetic they would have used the opportunity, when the legitimate king of Egypt had fled to them and two claimants were struggling for the throne, to subjugate the country. But they did nothing of the kind, even when Chabrias had returned to Athens and Agesilaus had died on the way home (probably 360).

At the instigation of Parysatis Artaxerxes had married his own daughter Atossa. She used her interest to secure the succession for the energetic and violent Ochus, who is said to have promised to marry her; the Persian religion approved marriage not only with a sister but also with a daughter, and even with a mother. The elder son Darius was already invested with the succession and the royal title, but having engaged in a conspiracy against his father he was tried and executed, and Ochus, it is said, found means of getting rid of his other brothers, who stood in his way. Soon afterwards the aged Artaxerxes died after a reign of forty-six years (in the course of the year 358). Many stories are told of his mildness

<sup>1</sup> Xen., *Cyrop.*, viii. 8, 4; Aristot., *Pol.*, 1812a; Harpocration, s. v. *Ἀυτοφραδίδης*. He is to be distinguished from Ariobarzanes (about 362-357), ancestor of the kings of Pontus, who, however, seems to have belonged to the same house, and was probably heir to a district on the Propontis.

<sup>2</sup> See Pliny, xxxvi. 30, 47.

<sup>3</sup> The Greek cities on the southern coast of the Buxine, which Xenophon about 400 found quite free, were again subjugated at this time. Datames coined money in Sinope, as did also his (probably indirect) successor Ariarathes.

<sup>4</sup> Diod., xv. 91. Mysia is not otherwise known as a satrapy proper. But at any rate Asia Minor was the scene of his exploits.

and affability, but, even if they are true, they have little significance. The contempt for his brother which Cyrus exhibited was perfectly justified; under the effeminate king the empire gradually fell to pieces.

But his successor, Ochus, who took the title of Artaxerxes (III.), was of a different stamp. True, it is not perfectly certain that the great restoration of the empire is to be ascribed to his personal influence; it may be that the whole merit belongs to some of his officials, and that he only lent it his name, but it is much more probable that the initiative was his. He was, it appears, one of those great despots who can raise up again for a time a decayed Oriental empire, who shed blood without scruple and are not nice in the choice of means, but who in the actual position of affairs do usually contribute to the welfare of the state as a whole. At the very beginning of his reign he secured himself on the throne by a massacre of his nearest relatives, though no doubt the statement of Curtius (x. 5, 23) is exaggerated.<sup>1</sup> The judgment of the Greek writers on Artaxerxes III. was too much influenced by such deeds as found an historian in Dinon, as well as by the hatred of the Egyptians, whom he humbled and mortally offended; hence it was one-sided and unjustly unfavourable.

But for a while the empire was in a state of absolute dissolution. Artabazus, satrap of the Hellespontine Phrygia, very probably a son of Pharnabazus and immediate successor of Ariobarzanes, had fought against Antophradates as early as 365 and been taken prisoner by him. At that time the Athenians had acted against him openly enough, at least towards the end.<sup>2</sup> But it is not clear how far Artabazus then rebelled against the king, who was father to his mother, Apama. But at the time of the so-called Social War (about 355) he fought against the king's satraps and was powerfully supported by the Athenians. Chares won for him a great victory over Tithraustes. And, when, at the king's threats, Athens left him in the lurch, he was able, being well furnished with money, to procure the services of the Theban Pammenes, and maintained himself for a long time. The turn in his fortune seems to have come from the Thebans also entering into an understanding with the king. About 350 we find Artabazus a fugitive at the court of Philip of Macedonia, and with him his brother-in-law, the Rhodian Memnon. However, after the subjugation of Egypt, Memnon's brother Mentor, who, like Memnon, was one of the most distinguished generals of his time, succeeded in procuring pardon for both, and thenceforward Artabazus remained loyal down to the overthrow of the empire.

The revolt of Orontes (or Orontas) fell somewhat later. Probably he is the same whom we found above betraying his comrades. He may very well have received the rule over a wide coast district<sup>3</sup> as the price of his treachery (see Diod., xv. 92). He is mentioned in 354 by Demosthenes

<sup>1</sup> More distant relatives were left alive, as he who was afterwards Darius III. and his brother, Oxyathres. A son of the Darius who was executed appears in Arrian, I. 16, § (384 n.c.). Thus the king did not extirpate even the branch that was most dangerous to him. It is to be remembered that even Alexander the Great, after ascending the throne, put several near relatives out of the way.

<sup>2</sup> Owing to the inconstant nature of the foreign policy of Athens at that time—a policy too often influenced by the personal interests of the great captains of mercenaries—as well as to the shifting attitude of the satraps, it is impossible for us to form a clear conception of these events from the isolated statements of contemporaries (like Demosthenes and Ænes Tacticus) and later writers. It is to be observed that in these decades violent revolutions took place in some Greek cities under Persian supremacy, and that they even made war on each other. With the restless character of the Greeks such things were not to be averted unless each town was occupied by a Persian garrison, which was certainly not the case.

<sup>3</sup> There are coins ascribed to Lampascus and to Clascosm bearing the name of an Orontes.

(*De symmoris*, 186) as an enemy of the king. In 349/348 the Athenians formed an alliance with him. From the fragmentary inscription in which this is recorded it does not follow with certainty that at that time he was still in rebellion. About his end we know nothing, but perhaps he was removed after the restoration of Artabazus.

That from the outset Artaxerxes III. was believed to be a person of greater activity than his father may perhaps be inferred from the rumour current in 354/353 that the king was preparing a great expedition against Athens and Greece. Many Greek states may certainly have had a guilty conscience towards the king on account of their wavering policy and the purely mercenary support which they had repeatedly lent to rebellious satraps. Demosthenes warned the Athenians against taking up a hostile attitude to the king on the ground of mere rumours.<sup>4</sup>

The war in Egypt still went on. And now the cities of Phœnicia, previously so trustworthy, also revolted, and so did the kings of Cyprus. Even in Judæa there must have been an insurrectionary movement. The revolted Sidonians showed such exasperation that we can hardly avoid the supposition that Persian rulers had wounded their religious feelings,—the sensitive side of Semitic peoples. The satraps Mazæus (Mazdai) of Cilicia and Belesays of Syria were driven back by Mentor, whom Nectanebus, king of Egypt, had sent to the help of Tennes, king of Sidon. But, when the great king himself took the field at the head of a powerful army, which included 10,000 Greek mercenaries,<sup>5</sup> Tennes and Mentor made terms. Sidon surrendered—though probably only after a severe siege—and was fearfully punished. More than 400,000 men are said to have burned themselves in Sidon on this occasion. The fate of the first-born of Canaan quickly brought the rest of the Phœnicians to their knees. At this time much blood was shed in Judæa also, though we have only scattered notices of the fact.<sup>6</sup> Mentor now went over to the king's side and fought against his former employers. It was to him and not to the Persian eunuch Bagoas that the king chiefly owed his success; but undoubtedly the royal presence contributed much to the result by facilitating rapid decisions and preventing dangerous jars. Mentor succeeded in everywhere sowing dissension between the Greek mercenaries of the Egyptian king and the Persians; and even more by intimidation than by the sword Egypt was, after long independence, again made a Persian province (344).<sup>7</sup> Artaxerxes seems to have made the "va victis" thoroughly clear to the Egyptians, and to have treated even their religion with little more respect than Cambyses before him: temples were desecrated and sacred animals slaughtered. For a time the Egyptians had to satisfy their rage with nicknaming the king, after the unclean Typhonian beast, "asa." Cyprus, too, was again reduced. The enterprise was conducted by the prince of Caria, Idrieus. The Greek mercenaries were led by the well-known

<sup>4</sup> In the speech *De symmoris*. Similarly in the speech *De Rhodiensibus libertatis* (191 sq.) he advises the Athenians not to offend the king frivolously (351 n.c.).

<sup>5</sup> Through Diodorus and some statements of others we possess by exception fairly good information about these struggles.

<sup>6</sup> Josephus, *Ant.*, xi. 7, 1; by Eusebius's canon 1657 from Abr., and his copiers; Solinus, xxv. 4. The king at that time settled a number of Jews in Hyrcania. Judæa was forcibly pacified, perhaps by Orophernes (or Olophernes), brother of the then satrap of Cappadocia. Orophernes distinguished himself in this war (Diod., xxii. 28); the assumption that it was he who reduced Judæa would explain why in the book of Judith—mere romance though it is—an Olophernes appears as the wicked commander who fights against the Jews.

<sup>7</sup> So Manetho, who makes Ochus reign six years in Egypt. In harmony with this we learn from Isocrates (*Phil.*, 102) that in 347/346 Egypt was not yet subdued, while according to the letter of King Philip (Demosth., p. 160) in 340 the reduction of Egypt and Phœnicia had long been effected.



Athenian Phocion,<sup>1</sup> and with him was a pretender Evagoras, of the family of the famous Cyprian prince of that name.

Thus by force and policy the old state of the monarchy was restored in all the western lands. Mentor, the real conqueror of Egypt, was splendidly rewarded. He received the satrapy of the west coast of Asia Minor, and quickly removed by cunning and treachery Hermias, tyrant of Atarneus and the friend of Aristotle, who had concluded treaties like an independent prince<sup>2</sup> and stood in suspicious relations to King Philip of Macedonia. It has been already mentioned that Mentor procured the pardon of his brother-in-law Artabazus and his brother Memnon. It is not improbable that the bestowal of this province on the skillful general and diplomatist, and the restoration of Artabazus to his hereditary satrapy, may be connected with the attention which the king paid to the plans of the Macedonian, which were gradually disclosing themselves more and more. Of course no one thought of danger to Asia Minor, much less to the whole empire, but Philip's efforts to secure the mastery of the Bosphorus and Hellespont were enough in themselves to excite grave anxiety.

As early as 350 the story went that Philip had sent an embassy to the king,<sup>3</sup> and it is definitely stated that he concluded a treaty with Ochus.<sup>4</sup> The pacific intentions of the Persians, at least for the moment, were no doubt sincere; not so those of Philip, who had to subdue Greece before he could put into execution his designs on Asia Minor, a circumstance overlooked by the honest but politically short-sighted Isocrates in his exhortation to Philip to attack Persia (347/346). Probably Demosthenes was not alone in perceiving that the safety of Greece now lay in an alliance with the Persians against Philip. Negotiations went on busily between Athens and the king, who at all events sent subsidies repeatedly for the conflict with Macedonia. In the year 340 Persia interfered actively by rescuing, in conjunction with Athens, the town of Perinthus on the Propontis (and therefore close to Persian territory), which was besieged by Philip; and the Macedonians could perhaps with some right assert that with this step the war between the Persians and them had begun.<sup>5</sup> But the Persians did not see, what to us is obvious from the result, that it was necessary for them to prevent the subjugation of Greece; or, if they saw it, they lacked the energy to act.

Artaxerxes probably did not reach the battle of Cheronea (August 338), which made Philip master of Greece. So far as we can judge, however, it was a great misfortune for the empire that this king, the first since Darius I. who had in person energetically conducted a great expedition and restored the empire, died just at this critical moment. Probably he was murdered by Bagoas, who placed Arses, the youngest of the sons of Artaxerxes, on the throne.<sup>6</sup> But, when Arses was preparing (so it is said) to punish Bagoas, the latter put him and his children to death (335). We know nothing further of this king. Under his reign (spring 336) a Macedonian army first crossed into Asia, after Philip had previously caused himself to be nominated general of the Greeks against the Persians. The Macedonians gained some not unimportant successes, but the undertaking was checked in the very same year by the assassination of Philip. The commander Parmenio returned to Europe, and Memnon, who after Mentor's death commanded in these regions, probably won back from the

Macedonians nearly all their conquests in Asia, though it is likely that Abydus, commanding the passage of the Hellespont, and perhaps one or two more strong places, remained in their hands.

In order to rule securely Bagoas placed on the throne, not a near relation of the murdered man,<sup>7</sup> but Codomannus,<sup>8</sup> who reigned as Darius (III.), a great-grandson of Darius II., and a man of about forty-five years of age.<sup>9</sup> But the king-maker was caught in his own snare, for Darius soon put him out of the way.

Over the last of the Achæmenians misfortune has thrown a halo of romance, but sober criticism can see in him only an incapable despot like so many whom the East has produced. It may be true that in earlier life, under Artaxerxes III., he once proved his personal bravery in the war against the Cadusians, and was rewarded with the satrapy of Armenia;<sup>10</sup> as a king he always behaved like a coward in the moment of danger. Vast attempts and a shameful flight, feeble or rather effeminate behaviour combined with braggart pride, lack of intelligence, especially in the conduct of war,—these are features which fully justify Grote in comparing him with Xerxes. It is no reproach that he was not a match for perhaps the greatest general in history, but an Ochus would doubtless have made the task a somewhat harder one, and would scarcely have been guilty of the folly of beheading, in a fit of bad temper, so useful a man as the old condottiere Charidemus, who thoroughly understood the mode of fighting the Macedonians.

The history of Alexander the Great is given under the articles ALEXANDER THE GREAT and MACEDONIAN EMPIRE; here we can only enumerate the chief steps in the downfall of the Persian empire. We see how great is the force of cohesion in such an empire, even after all the shocks it has received, and under an incapable ruler. What the giant powers of Alexander achieved in a few years might never have been accomplished at all by the qualities and resources of an Agesilaus.

After placing a terrible curb on the Greek love of freedom by the destruction of Thebes, Alexander crossed the Hellespont in the beginning of spring 334. A few weeks later, on the Granicus, he annihilated the great Persian army which should have barred his onward march. Sardis, the capital, at once fell into his hands. Here, for the first time, we see the miserable spectacle of a high Persian officer going over to the enemy and surrendering to him the town or district committed by his king to his charge. At the beginning of winter the whole coast as far as Pamphylia was Alexander's; Miletus and Halicarnassus were the only places which he had had seriously to besiege, and it was only the narrowly-enclosed citadel of the latter town which yet withstood all attacks. But there was still a great danger. The Rhodian Memnon, who had been joint-commander at the Granicus, undertook with all his might to kindle a conflagration in Alexander's rear, and to force the king to cross over to Greece. The Persian fleet, which he commanded, ruled the sea; several of the most important islands were occupied; and from the Greek mainland thousands of patriots were looking for Memnon's arrival in order to rise against the Macedonians. But Memnon died suddenly. The death of this man, his only worthy adversary, is perhaps the greatest of those pieces of luck which so highly favoured the great Alexander. His successor Pharnabazus, son of Artabazus, continued, it is true, the naval operations, but he was not able to carry out Memnon's plans. Meanwhile Alexander secured

<sup>1</sup> Diod., xvi. 42; the sources from which our biographers of Phocion (Plutarch and Nepos) draw did not mention this fact, which does not accord very well with the pattern of philosophic virtue which they made out Phocion to be.

<sup>2</sup> Cp. the treaty with Erythra, Le Bas and Waddington, No. 1585.

<sup>3</sup> Demosth., *Phil. I.*, p. 54.

<sup>4</sup> Arrian, ii. 14, 2.

<sup>5</sup> Arrian, ii. 14, 5.

<sup>6</sup> In Plut., *De fort. Alex.*, p. 386 sq., he is called Carres. The Persian form of the name is not known.

<sup>7</sup> We read of a son of Ochus in 380 (Arrian, iii. 19, 4). We had above a grandson of Artaxerxes II. Thus Bagoas had not killed all "the brothers" of Arses, and the king's family was not extinct, as Diodorus asserts (xvii. 5).

<sup>8</sup> The name is given only by Justin (from Dinon), x. 8.

<sup>9</sup> Arrian, iii. 22, 6.

<sup>10</sup> Justin, l.c.; Diod., xvii. 6.

the most important parts of Asia Minor, and then set out on his forward march. At the farthest extremity of Cilicia Darius in person met him at the head of a huge army, but the field of battle was so badly chosen that the numerical superiority of the Persians did not come into full play. The brilliant victory of Issus (about November 333) and the flight of Darius threw wide regions into the power of Alexander, who, with all his daring, was also cautious, and did not follow the Persian king in his flight into the interior. He sought first to make himself master of the whole Phœnician coast, in order to cut off from the Persians every possibility of annoying him any longer at sea. And in reality the fleet, which was chiefly furnished by the Phœnicians, melted away when Alexander had taken possession of their country. The Cyprian ships, too, returned home, and Cyprus also submitted. But Tyre withstood the great conqueror for seven months<sup>1</sup> (332), and had to pay a dreadful penalty for its resistance. Gaza, too, defended itself bravely. Egypt welcomed exultingly the Macedonian who freed them from the hated Persians. After the acquisition of Egypt Alexander possessed a territory large and strong enough to be able to survive, if need be, a reverse. In the spring of 331 he left Egypt and marched through Syria and Mesopotamia to Assyria proper, where Darius awaited him at the head of vast masses of troops, and this time in a favourable position. But on 1st October 331 Alexander defeated the king at Gaugamela so decisively that henceforward the Persian empire, as such, was shattered. Darius fled to Media. Without striking another blow Alexander captured the capitals, Babylon and Susa, with their vast treasures. In vain the wild independent Uxians (better "Huxians") barred a difficult mountain-pass against him, in vain did a Persian army do the same; he quickly forced a passage through the mountains and marched into Persia proper. Pasargadæ and Persepolis, the cradle of the monarchy, were his. Persepolis, in the immediate neighbourhood of which another conflict took place, was given up by him to his soldiers to plunder; the royal palace he caused to be burned.<sup>2</sup> In this act we discern, in opposition to the usual view, a well-considered measure, excellently calculated to work upon the Asiatic mind. The burning of the royal castle was meant to show the Asiatics that their empire was utterly overthrown, and that Alexander was their only lord. Besides the Greeks might see in the step an act of vengeance for the destruction of the Greek temples by Xerxes, as the official phrase ran.

Thereupon Alexander hastened to Media in pursuit, once for all, of Darius. The latter fled eastwards. He had still a considerable army with him, but only the Greek mercenaries were absolutely true to him, like the Swiss guard to Louis XVI. At last Bessus, satrap of Bactria (and Sogdiana apparently), seized the person of the king, in order either to make use of him for his own ambitious purposes or to put him out of the way. As a matter of fact, he murdered him in Parthia, just when the pursuing Alexander had nearly overtaken him (July or August 330). Such was the melancholy end of the last of the Achemænian great kings.

Bessus thereupon hastened into his satrapy and assumed the title of king and the name of Artaxerxes (IV.). We know that he was a "kinsman" of Darius; perhaps in his case this means more than that he was merely connected with him by marriage, and this satrap of Bactria

<sup>1</sup> The resistance of the Tyrians is certainly not explained by their attachment to the Persians, scarcely either by their love of freedom. We suspect here again a religious motive. Alexander desired to offer sacrifice in the temple of Hercules, and probably the pious Canaanites would as little allow this as the Jews would have permitted any foreign ruler to enter their temple.

<sup>2</sup> Cp. the article ΠΑΣΑΡΓΑΔΑΙ.

may have actually belonged to the race of the Achemæniens, like his predecessors the princes Masiates and Hystaspes. It would thus be more easy to explain why various grandees favoured his undertaking, and why he was recognized as king, e.g., by the satrap of Aria (the district of Herât), and vigorously supported. That he enjoyed the royal title for some time is due only to the circumstance that Alexander first made himself securely master of eastern Iran before he marched into Bactria and Sogdiana. After many adventures Bessus fell into Alexander's power on the farther side of the Oxus, and was put to death.

After the return from India the satrap of Media conducted in chains to Alexander a certain Baryaxes, who during Alexander's absence had declared himself king of the Persians and Medes. Of course he was executed. He is said to have been a Mede, not a Persian. Certainly his movement had never even a momentary importance; he is only once mentioned (Arrian, vi. 29, 3). But such last throes of a mighty monarchy are, after all, worthy of attention.

*Literature.*—Rawlinson, *The Five Great Monarchies*, vol. ii., iii. (2d ed., London, 1871), gives a useful account of the Medo-Persian history down to Alexander, as does also vol. ii. of Fr. Spiegel's *Erstliche Alterthumskunde* (Leipzig, 1873). Neither work is exhaustive, and in both we frequently miss true historical criticism. For the time down to Xerxes Dancker's *Geschichte des Alterthums*, vol. iv. (6th ed., Berlin, 1880; Eng. tr. by Abbot, 1877-88), is recommended by its very careful use of all the sources and its acute mode of combining them, though the latter quality often leads to somewhat arbitrary construction. Owing to the close contact between Persian and Greek history the larger works on the latter are obliged to cover much of the same ground as the former. In this department Grote's *ἱστορία* is to be named above all; unfortunately at the time he wrote it was not in his power to make use of the important Persian inscriptions. (TH. N.)

## SECTION II.—GREEK AND PARTHIAN EMPIRES.

After the decisive battle of Gaugamela (331 B.C.) Alexander proclaimed himself king of Asia.<sup>3</sup> He never accepted the compromise recommended by Parmenio, which would have left to the Persians the upper satrapies east of Mount Zagrus, and established a sharply-marked natural and ethnographic frontier. Soon a symbolic act, the burning of the palace of Persepolis, announced to the Asiatics that the Achemænian monarchy was dead, and that Alexander claimed its whole inheritance. The punishment of Bessus, exactly modelled on that inflicted on pretenders by Darius I., showed that Alexander claimed to be the legal heir of the Achemæniens. Bessus's ears and nose were cut off, and he was brought to Ecbatana for execution before the assembled Medes and Persians, for "this Bessus lied and said, I am Artaxerxes king of Persia."

After Alexander had by his rapid and effective movements taken actual possession of the whole empire, Media was swiftly traversed, but the eastern frontier was not subdued and secured so easily. Crossing the mountain-wall that separates the southern margin of the Caspian from the rest of Iran, Alexander received in person the homage of the coast-lands. Khorâsân and the region of the Oxus were traversed by his armies in all directions; from Bactria the march was obliquely through Sogdiana to the Jaxartes on the farthest limits of the empire, and an onslaught was even made on the Scythians beyond that river.<sup>4</sup> Alexander was determined to secure a frontier so important for the trade of Central Asia, and to free the peaceful industry of Iran from the incursions of its here-

<sup>3</sup> Plut., *Alex.*, 34, 37, does not prove that there was another, still less a preferable account of the date of this occurrence.

<sup>4</sup> Here perhaps occurs the first trace in history of the Turkish race. Carthasis, the brother of the Scythian king in Curtius (vii. 7, 1), may be, as Nöldake observes, Turkish *hardakay*, "his brother," from *dañ*, of which *dañ* is the older form.

ditary enemies the Turanian nomada. Prestige rather than material advantage was gained by the rapid fall of the supposed impregnable rocky nests of Arimazes in Sogdiana, of Chorienes or Sisimithres in the mountain region of the upper Oxus,<sup>1</sup> and, above all, of the Indian fortress Aornus. Though usually clement to the conquered, Alexander was terrible to those who rose against him—to the Ariana, for example, and to the strong cities that headed the insurrection in Sogdiana; when the movement was crushed, he laid the land waste far and wide and slew all the males; 120,000 Sogdians are said to have thus lost their lives. Alexander too, like Cæsar, did not shrink from a breach of faith if it served his purpose; this was seen in the massacre of the Indian mercenaries who had defended Massaga, which was meant to spread terror before him as he entered India.<sup>2</sup> The Achæmænian power at its climax had never crossed the Indus; Alexander passed the river and pushed into India proper. This adventurous march was undertaken wholly for the sake of prestige, and was specially meant to impress the imagination of the Greeks, to whom India was a land of marvels. Alexander proposed to reach the Ganges and the ends of the habitable earth; and it was sorely against his will that his own soldiers forced him to confine his plans to the rational scope of securing the Indus as his frontier and adding to his realm its commercially important delta.<sup>3</sup> Alexander had now accomplished what, in the eyes of the Arian peoples, was necessary to give the last stamp of legitimacy to the new empire; he had led his armies round all the frontiers and taken personal possession of his lands. To close the circle he had still to march back through Gedrosia and Carmania. But it may well be doubted if he would have faced this last exploit had he known beforehand the full terrors of the burning desert; not a fourth part of the forces that began the march from India survived a journey which has been fitly compared with the retreat from Moscow.

A series of minor expeditions completed the work of the great campaigns by reducing a number of mountain tribes, which had shaken off the weak yoke of the Achæmænians, exacted tribute at the chief passes, and in their irreclaimable savage habits of plunder were like the modern Kurds, the born foes of the Iranian peasant. Such were the Uxians, the Mardians in Persia, and the people of the same name to the south of the Caspian, and finally the Cossæans, whom Alexander disposed of in his last campaign in forty mid-winter days. The future obedience of these brigands was secured by planting fortresses at the most difficult points of the roads, and they were compelled to settle down and take to husbandry.<sup>4</sup>

These vast results were only obtained by the aid of continual fresh levies in Europe, and strong garrisons had to be left in the conquered lands. Alexander's work could not last unless the European occupation became permanent; and therefore he planned a great network of new cities, in which colonies of Greek or Macedonian soldiers were planted. According to Plutarch (*De Alex. fort.*, i. 5, p. 328 F) more than seventy cities owed their origin to Alexander; some forty of these can still be traced.<sup>5</sup> In Media, in the Cossæan neighbourhood, and in Carmania we

<sup>1</sup> The last two places are identical. All the sources know only two fortresses taken by Alexander in these regions: those which mention Sisimithres omit Chorienes and *vice versa*; and the essential points are the same in Arrian (iv. 21) and Curtius (viii. 2, 19-33).

<sup>2</sup> Diod., xvii. 84. The official Macedonian account in Arrian (iv. 27) ignores the treachery.

<sup>3</sup> As the Greeks then knew India only from Otesias, whose geography is of the vaguest, Alexander probably under-estimated the vast size of the peninsula.

<sup>4</sup> Arrian, *Ind.*, 40, 8.

<sup>5</sup> See the careful enumeration in Droysen, *Gesch. d. Hellenismus*, 2d ed., vol. iii. pt. 2, p. 187 *sq.*

know only two by name, though we are told that in the first two districts there were really a large number of such towns, seemingly inconsiderable places. In the east of Iran the settlements were more important, and twenty-six can be enumerated in Aria, the country of the Paropanisus, Bactria, Sogdiana, India, and the land of the Orïtes,—Bactria and Sogdiana alone claiming eight of these.<sup>6</sup> The composition of these settlements is illustrated by the details given for Alexandria in the Indian Caucasus; according to Diodorus, the city and one or more minor settlements within a day's journey of it received 7000 barbarians, 3000 camp-followers, and as many of the mercenaries as volunteered to stay; but Curtius, who certainly reproduces the common source more accurately than Diodorus, names 7000 Macedonian veterans and a number of mercenaries whose engagement had expired. The Greek element in this colony must have been large, for the town still keeps its Greek name (Alasadda) in an Indian book of the 4th century A.D. Alexandria on the Tanais (Jaxartes), again, was partly peopled by Sogdian insurgents, forcibly transplanted from their homes, which the conqueror had destroyed. Some of Alexander's last orders refer to the founding of cities and the transplanting of Europeans to Asia and Asiatics to Europe, a measure designed to promote the assimilation of all parts of the empire. Macedonia alone did not suffice for this gigantic scheme of colonization, and it was chiefly Greeks who were planted in the most eastern satrapies, in Bactria and Sogdiana. At such a distance from home the Greeks could have no other interest than loyalty to Macedon; it was the same policy as dictated to the Romans the establishment of Latin colonies in their new conquests. But the antagonism between Greeks and Macedonians was too great to allow the former to forget that they were, after all, really men deported by the great king (*ἀνάρκατοι*); and so even from the first there were seeds of discord between them and the rest of the empire.

Alexander's capital was Babylon, the natural centre of an empire that embraced both Iran and the West, and recommended also by its command of the great lines of international traffic, and by its historical traditions of empire. The Achæmænian system of satrapies was retained; kingships were left only in the exceptional case of India.<sup>7</sup> The satrapies of the upper country seem to have been fourteen: Persia, Parætacene, Carmania, Media, Tapuria with the Mardian country, Parthia with Hyrcania, Bactria, Aria with Drangiana, Gedrosia with the Orïtes,<sup>8</sup> Arachosia, the Paropanisus country (which probably was quite independent under the later Achæmænians, and was first placed under a satrap by Alexander), India on this side the Indus, India beyond the Indus (from the Bactrian frontier to the confluence of the Indus and the Acesines), and beyond this the province of the lower Indus extending to the sea. The last three satrapies were also new. Alexander retained the old satraps of Darius in three provinces; in Parætacene and Tapuria it would have been impossible to drive the old rulers from their mountains without a tedious campaign, and in Aria Satibarzanes was confirmed in his post to detach him from Bessus. But in all three

<sup>6</sup> Strabo, xi. p. 517. Alexandria on the Tanais and twelve other towns are spoken of by Justin (xii. 5, 16), but xii. is perhaps a corruption of vii.

<sup>7</sup> Oxyartes is sometimes called king by a mere inaccuracy. Dexippus, *sp. Phot.*, cod. 82, p. 64, b. xxii. (Bekker), makes Alexander give Oropius the *Ζογδιανῶν βασιλείαν*. The geographical order, and the fact that Sogdiana has been mentioned before, demand the correction *Σουγδιανῶν*, and for *κωυῶν* we must read *κῶυον*; see Justin, xiii. 4, 14. Oropius was the successor of Abulites. The province seems to have been officially designated a kingdom, but that does not make its governor a king.

<sup>8</sup> This province was perhaps formed by Alexander; it was afterwards joined to Arachosia.

cases the old satraps were superseded on the first opportunity. Most new appointments, however, were given to Persians; at first there were Macedonian satraps only in rebellious Arachosia, Gedrosia, and the three new Indian provinces. This policy helped the subjects to fall in with the new rule; but on second appointments Macedonians generally took the place of Persians, and at Alexander's death there were Persians only in Media (from which Atropates, as the sequel proved, could not have been removed without a fight), in Parthia, and in the Paropanisus, which was held by Alexander's father-in-law. The power of the satraps was considerably reduced; in Parthia, Aria, and the Paropanisus there seems to have always been a Macedonian resident (*ἐπίσκοπος*) beside the satrap, with the control of the military. Indeed in all the provinces the command of the forces seems to have been separated from the office of satrap, though it was not always entrusted to a single officer. The satraps also lost the right to engage mercenaries and to coin; and in the western countries, of which we know most, a single officer—always a Macedonian—was sometimes charged with the tribute of several provinces. Perfect order and an exact definition of the functions of every officer could not be attained from the very first; yet even in this period of transition the finances of the empire improved. At Alexander's death 50,000 talents (£11,288,515) lay in the treasury, and the annual tribute was 30,000 talents, or six and three-quarters millions sterling. What was of more consequence, the treasures of the East were no longer hoarded in the old Oriental fashion, but put in circulation and applied to a number of great and useful enterprises. Such were the exploration of the course and mouths of the Indus; the voyage of Nearchus, which opened the sea-road between the Indus and the Euphrates; the restoration of the trade of Babylon by removing the weirs which obstructed navigation, and by works on the canals and the Pallacopas; the attempt to discover a sea-way round Arabia, in which Hiero of Soli explored the east coast of the peninsula; and the commission given to Heraclides for exploration of the Caspian.

Alexander sought to assure the permanence of the empire by fusing Greeks and Persians into one mass. Thirty thousand Persians, the so-called *ἐπίγονοι*, were armed and disciplined like Macedonians, and Persians were received on equal footing in the Macedonian corps and even, to the disgust of the Macedonian nobles, in the *corps d'élite* of the cavalry, in which the latter served. Macedonia, in truth, was not populous enough to keep the *cadres* full. Alexander adopted the regal robes of Persia and the regal state. The court was served by eunuchs, and men kissed the ground before the great king. It was a strange sight for Hellenes when a poor wretch from Messene was ordered to execution because he had inadvertently sat on the king's throne.<sup>1</sup>

To the Greeks a union with a barbarian was no regular marriage; but the Bactrian Roxana was Alexander's queen. His friends were urged to follow his example; eighty of his courtiers married Persians on the occasion of the great wedding at Susa, and 10,000 soldiers who had chosen Asiatic wives received gifts on the occasion. Still more startling was the introduction of polygamy; the king took a second wife, Statira, daughter of Darius, and a third, Parysatis, daughter of Ochus.

All this was Persian fashion; but when Alexander claimed divine honours as the son of Jupiter Ammon he asked both Persians and Macedonians to adopt from the Egyptians the most perfect model of devout submission to their sovereign. Could this compound of nationalities prove more than a kingdom of iron and clay? The answer

lay in the attitude of that part of its subjects which still retained a vigorous life. The western nations, long schooled to slavery, were passive under the change of rule. The Persians, too, and all western Iran acquiesced after the first conflict was decided. In the east it was not so. Here the northern province of Chorasmia had been independent of the later Achæmenians, and its kings had ruled the great plains as far as the north-east slopes of the Caucasus.<sup>2</sup> Bactria, Sogdiana, Aria, Arachosia, Drangiana, and the borderlands towards India had obeyed Persian satraps, but Bessus and his partisans did not forfeit their allegiance by the murder of Darius. These eastern Iranians, who had no close connexion with Persia, opposed the most obstinate resistance to the conqueror: the Arians rose again and again; and an energetic chief like Spitamenes could always stir up a party in Sogdiana. These risings began in the castles of the numerous chieftains (*ἄρχοι*), but it was a national spirit that made them so obstinate and bloody; the Iranians of Sogdiana and Bactria had acquired in their constant wars with the Turanians a sense of self-respect which the effeminate Medes and Persians wanted. Their situation, too, favoured their resistance; for their ancient enemies in the desert had a common interest with them in opposing a strong central government, and were easily persuaded to lend them succour or shelter. Sacæ and Dahæ fought for Bessus, and Spitamenes found refuge with the Massagætæ; the wilderness offered a retreat where regular troops could not follow, and from which a petty warfare could always be renewed. In India the Brâhmins had been the soul of a still more vigorous resistance; they preached revolt to the rajahs of the lower Indus, and were the object of Alexander's special severity. Eastern Iran was the cradle and always remained the chief support of Zoroastrianism,<sup>3</sup> and religion must have had its part in the patriotic resistance of Bactria and Sogdiana. Alexander forbade the practice of throwing the dying to the dogs (Onesicritus, ap. Strabo, xi. p. 517), which the Bactrians certainly took from the *Avesta*; and this was just the kind of decree which drives an Oriental people to desperation. The Macedonians did pay some attention to Iranian thought; a magian Osthanes is said to have been in the train of Alexander, and Theopompus, a contemporary of the conqueror, shows the first traces of acquaintance with the *Avesta*. The Persian tradition that Alexander burned the twenty-one *books* of the original *Avesta*, and that only one part of the holy book was subsequently recovered from memory, is of course not historical, but it rests on a very true feeling that the new order of things was at irreconcilable war with the old faith.<sup>4</sup>

Alexander desired to fuse the Greeks and barbarians together, but the practical means directed to this ideal aim were such as brought him into conflict with the natural leaders of the new state. By asking the Greeks as well as the barbarians to worship him as divine he destroyed the whole effect of the theatrical arts in which he was a master, and by which he hoped to recommend his mission as an eminently Hellenic one to the masses; even Callisthenes, the enthusiastic herald of the new era, was bitterly undecieved, and, turning against Alexander, fell a victim to the despotism of the man who had been his idol. But, what was still more fatal, the net result of his efforts at a fusion of races was not to Hellenize the Persians but to teach the Macedonians to exchange their old virtues for the effeminacy and vices of the East. It is not fair to say that if the Macedonians had possessed a riper civilization they

<sup>2</sup> So in the Middle Ages Khârezm and Kipchak stood under the same sovereignty, and were not included in the realm of Jagatai.

<sup>3</sup> Bismithres's wife was his own mother, a union which the *Avesta* specially approves.

<sup>4</sup> See Spiegel, *Z. D. N. O.*, ix. 174.

might have resisted the foreign influence; their numbers were too small, and Alexander pushed his plans too hastily and with too exclusive regard to surface-effect, to make any other issue possible. Nay, Alexander wished to have it so, and there was no surer path to his favour than to wear a Persian coat and talk broken Persian like the scheming Peucestas. Alexander liked Oriental splendour and the Oriental ceremony which placed an infinite distance between the king and his highest subjects; great statesmen generally love to be absolute, and Alexander enjoyed Oriental despotism and mechanical obedience much more than councils of state and discussions of policy with the Macedonian soldier-nobility, whose sturdy independence was always asserting itself, and whose kings, unless in virtue of great personal qualities, had never been more than *primi inter pares*. Then, too, Alexander, in the splendour and magnitude of his conquests, lost touch of the movements that were going on at home. The true task of Macedonia in the world's history was to unite Greece under its hegemony,—a task clearly marked out, and one which Philip had pursued with masterly skill. But the completion of this task called for a modest and unsensational line of action quite foreign to Alexander's spirit; Antipater's hard-won victory at Megalopolis, but for which his father's work would have fallen to pieces behind him, was received with a characteristic sneer on the war of mice which seemed to be going on in Arcadia.<sup>1</sup> Philip's old generals judged otherwise and judged better; it was not blindness to the conqueror's genius, but a just perception of what was practicable and desirable, and an instinctive dread of the unknown issues of the king's plans, which gradually estranged from him his truest councillors; and it was an evil sign that his only close friend was a poor creature like Hephæstion, who could not boast of a single service. Then came the first conspiracy and the murder of the aged Parmenio, whose son Philotas was mixed up with it,—a crime to which Alexander was led simply through fear. The wild extravagances of grief that marked the death of Hephæstion, and of which a pyre worth two and a half millions sterling was the least, show how Alexander lost himself more and more as he broke with the Macedonian character. His last orders, cancelled at his death by Perdicas, included an invasion of Carthage by land and sea, with a further view to Spain, and the erection to King Philip of a tomb surpassing the Great Pyramid. The extravagance of these plans was as palpable to the Macedonian soldiery as to their leaders, and they too shared the growing alienation from the monarch. There were mutinies as well as conspiracies; the soldiers were tired of following from adventure to adventure, and at the Hyphasis they had their way. In his later days Alexander was repeatedly wounded, a fact significant of a change in the spirit of the troops, for no great general would expose himself as Alexander did—for example, in storming the city of the Malli—unless his men required this stimulus.

The want of coherence in the empire was seen even while Alexander was in India. Many satraps broke all restraint, renewed the old oppressions of the Persian time, hired mercenaries again, and only awaited a fit moment for open rebellion; the generals of the army that lay in Media committed sacrilege and crimes of every kind; the treasurer Harpalus violated his trust and escaped with his plunder. Alexander, on his return, soon restored order with terrible severity, but the ferment was still at work, especially in the west, and was increased through the disbanded mercenaries of the satraps who returned to the coast. There is one event of the time of anarchy when Alexander was in India which, though passed over in the official sources of Arrian, deserves special notice as a pre-

lude of what was to come (326 B.C.). The Greeks settled in Bactria and Sogdiana rose against the Macedonians on a false rumour of Alexander's death. Three thousand of them seized the citadel of Bactra, gained the support of the natives, and, crowning their leader Athenodorus, proposed to make their way home. Athenodorus was assassinated, but his followers remained unmolested, and joined the mass of their countrymen in the general rising of the Greek military stations after Alexander's death.

One Macedonian custom Alexander had retained, that of carousing with his generals. A series of debauches in the malarious climate of Babylon brought on a violent fever, which ended in his death (13th June 323).<sup>2</sup> The object of his life, the fusion of Macedonians and Persians, was not attained. The Persians still felt themselves subject to a foreign power, and in eastern Iran this feeling was bitter. The Macedonians again had been carried by Alexander's genius far out of their true path of development into a giddy career, in which a capable and valiant nation found its ruin. Alexander did not die too soon, if he was not to see the collapse of his work.

Terrible civil wars broke out at once on Alexander's death, and lasted almost unbroken for forty-two years, tearing his work to pieces, and scattering to the winds Macedonia's claims to universal empire. There was no legitimate heir, but the name of "king" was borne by Philip (323-317), a bastard of the elder Philip, and by Alexander II., Alexander's posthumous son by Roxana (323-311). The real power lay at first with Perdicas, who as regent governed the whole empire from Babylon, and, after Perdicas was killed in a mutiny in the Egyptian campaign of 321, passed for the moment to Pitho and Arrhidæus, till in the same year the regency fell to Antipater. As he ruled from Macedonia, the eastern satrapies were pretty much left to themselves, but Pitho, who held the chief of these—that of Media—took the first place, and soon appears as strategus of all the upper satrapies. But his ambition united the satraps against him, and he was driven not only out of Parthia, which he had occupied after murdering the satrap Philip, but out of Media too. The satraps now joined hands with Eumenes and placed themselves under his leadership when he came to Susa in 316 as the king's strategus at the head of the argyraspida. Pitho had meantime fled to Seleucus, satrap of Babylon, and with him sought help from Eumenes's great enemy, Antigonus.

A war in Media and Susiana ensued, and Eumenes, whose military successes were constantly frustrated by disobedience and treason in his followers, was betrayed to Antigonus and put to death in 315. Antigonus, already furnished with a commission as strategus from Antipater, now lorded it over all. Pitho, still greedy of power, and thinking of conspiracies to recover it, was executed; the Persian satrap, Peucestas, who had led the allies against Pitho, was superseded, and Seleucus fled to Ptolemy. Soon, however, the other potentates united against the threatening power of Antigonus, and in the war that followed Seleucus, with some help from Ptolemy's soldiers, repossessed himself of his satrapy of Babylon,—an important event, which forms the epoch of the Seleucid era (1 Sel. = 312/311 B.C.). Presently a victory over Nicanor, who held Media for Antigonus, made Seleucus master of Media and the adjoining provinces. Antigonus had still some temporary successes, but at the end of the war Seleucus was acknowledged lord of Bablyonia and the upper satrapies.

In these conflicts we can distinguish two main interests, represented by the cavalry and the infantry, or, what is

<sup>2</sup> The exact date in our calendar, which cannot be calculated from the Macedonian date 27 or 29 Dæsius, is found by the aid of Pseudo-Callisthenes (Cod. A in C. Müller's ed., p. 151; Arm. Tr. to Zacher, *Pseudo-Cal.*, p. 100).

<sup>1</sup> Plat., *Agess.*, 15.

the same thing, by the higher and lower nobility respectively. The former fought for the unity of the realm of Alexander, the latter for the national traditions of Macedon. In the first years the mass of the army made its wishes very distinctly felt, e.g., in the rising against Perdicas; even the *esprit de corps* of a single body like the argyraspids had often a decisive influence on general politics. The fall of Perdicas was really the end of the Perso-Macedonian empire founded by Alexander, as was made manifest by the fact that Babylon ceased to be the capital, and Antipater with the kings passed into Europe. On the ruin of Alexander's political structure the ruin of his house directly followed; all the political and military talent of Eumenes, its one sincere defender, could not avert the catastrophe, for Eumenes, who as a Greek was always looked on with suspicion, soon fell a victim to Macedonian jealousy. With him the kingship really came to an end, though the empty name of it lasted a little longer. The later conflicts have a different character; a certain number of leaders had risen gradually above the mass of the officers, attaching to their parties the less prominent men, and it was the conflicting interests of these leaders which were now represented in politics and war. Last of all, the particular interests of the subject provinces came to find expression in the conflicts of their chiefs, and the signal was given for the formation of distinct kingdoms. In the wild struggles for supremacy the last remains of Macedonian loyalty disappeared; when we are told that the strategoi and satraps of the upper provinces were still faithful to the royal house, and that Antigonos, as late as 315, counted on it in making war against Cassander, the loyalty can hardly be regarded as a genuine sentiment, but was merely a cover for the pride of chieftains who were willing to acknowledge a distant and merely nominal sovereign, but not to obey men who had lately been their equals. And in truth the sentiments of the upper satrapies were of little consequence. The power to give them effectual expression was lacking, and these lands, till much later, received all their political impulses from the west.

To make up for this, Iran was little touched by the civil wars; only Media and Parthia were seats of war, and that for a short time. Among the satraps Peucestas of Persia, Tlepolemus of Carmania, and Stasanor of Bactria are represented as good rulers, beloved by the natives; when Antigonos deposed Peucestas, a Persian notable told him to his face that the Persians would obey no one else, and lost his life for his frankness. Antigonos's realm was less than Alexander's by Egypt, Syria, Thrace, and Macedonia, and the tribute from it was 11,000 talents (two and a half millions sterling). The ordinary taxes, therefore, had not been raised; but Antigonos raised special war-taxes also, 5000 talents at one time in Susiana and as much in Media.

The list of satrapies at this period is known from the records of the partitions of Babylon (323), Tripardisus (321), and Persepolis (315). There were twelve upper satrapies, Persia, Carmania, Great Media, Lesser Media, Parthia with Hyrcania, Bactria with Sogdiana, Aria with Drangiana, Arachosia with Gedrosia, the Paropanisadae, India from the Paropanisadae to the Indus, India between the Indus and Hydaspes, India on the lower Indus with Pattala. Of Alexander's satrapies we miss Parthacoene, included in Persia, and Tapuria, which Alexander himself seems to have joined to Parthia. The only new satrapy is Lesser Media. It was thought proper to place Media, the most important Iranian province, in the surer hands of the Macedonian Pitho, son of Cratesus, but the north-west part of the province was left to the old satrap Atropates, whom Alexander had sent to Media in 328. He was father-in-law of Perdicas, and so claimed consideration, but probably he could not have been displaced if it had been tried.<sup>1</sup> At the new division on

<sup>1</sup> On Atropates see Arrian, iv. 18, 3, and Pseudo-Cal. in C. Müller, p. 149, where after Πλευκότρης read Ἀρπασίδης Ὀφθαλμῶν περσικῶν ἀδελφῶν τῶν Μυθίας. His connexions in north-east Media are illustrated by the fact that he had with him at Gattagamales Cadusians, Albanians, and Sacaeans.

the death of Perdicas (321) Pitho was confirmed in Media as far as the Caspian Gates, but nothing is said of Lesser Media, which was really no longer part of the empire. Thus Atropates was the founder of a small separate kingdom, which thenceforth continued to bear his name, in Greek Atropatene, in Arabic and Persian Adharbaján, and in Armenian (more nearly conformed to the original) Atrpatakan. It was never a very important state, but is worth notice as the first new native realm within the empire of Alexander and the first symptom of the Iranian reaction against Hellenism.<sup>2</sup>

Except in the case of Media the partition of Babylon made no change in the holders of the upper satrapies. So we are expressly told (Curt., x. 10, 4, and Just., xiii. 4, 19, where for *ulterioris* read *ulterioris*), and the apparent exceptions to the principle are perhaps merely due to our ignorance of previous changes. The most remarkable of these is that Pitho, son of Agenor, who under Alexander shared with a Persian the satrapy of the lower Indus, is now found in India Citerior in room of Nicanor, while his old satrapy has fallen to no other than King Porus.<sup>3</sup> We may be sure that the Macedonians sanctioned this extension of the power of the Indian king only because they could not help it, and it is probable that Porus had usurped the province in the troubles that broke out in India as soon as Alexander left it in 328 (Arr., vi. 27, 2). Thus one more province was now only nominally attached to the empire. Porus, indeed, was assassinated through Macedonian intrigue between 321 and 315, but the country never again came permanently under their power.

The partition of 321 was less conservative. Nicanor was removed from Aria to Bactria, and Philip from Bactria to Parthia, superseding Phrataphernes. These changes had probably some connexion with the rising of the Greeks in Bactria and Sogdiana after Alexander's death. No Persian satraps now remained except Atropates and Orxyartes, who had connexions by marriage with the conquerors. Antigonos, to please the natives, changed this policy, and even put the Mede Orontobates in the great province of Media, but he returned at the same time to Alexander's policy of limiting the satraps' power. We hear nothing of strategoi in the satrapies from 321 to 315, so it is probable that Perdicas and his immediate successors had allowed the satraps to hold also the military command in their provinces. Antigonos again appointed strategoi, who were always Macedonians.

In a time of civil war it is not surprising that the old disorders of the Achaemenian period reappeared. During the wars of Eumenes and Antigonos the Uxians and Cosseans again appear as independent, and as plundering travellers. But a much more serious outbreak was that of the Greek settlers in the north-east against the Macedonians. On the news of Alexander's death in 323 the military colonies rose under Philo, the Ænian, and with 20,000 foot and 3000 horse attempted to fight their way home. They were met by Pitho, governor of Media, and defeated by an inferior force through the treachery of one of their chiefs. Pitho granted them terms if they would lay down their arms and return home, but the Macedonians refused to respect the convention; they knew Perdicas had ordered the extermination of the rebels, and, falling on the disarmed foe, they massacred them and divided their spoil.

Such a catastrophe could not fail to embitter the relations between eastern and western Iran, between Greeks and Macedonians. It is hardly accidental that the only notice we have as to how Seleucus Nicator (reigned 312-280) came into possession of the upper satrapies is that he subdued Bactria by force of arms. To his Asiatic subjects Seleucus appeared as a king from the first; officially, and among the Greeks, he received this title only in 306. His first care was directed to India, where, probably during the wars of Eumenes and Antigonos, the Macedonian officials had been slain and obedience transferred to Chandragupta, founder of the Maurya kingdom. Seleucus crossed the Indus, but Chandragupta obtained peace on favourable terms, giving Seleucus five hundred war-elephants, but increasing his dominions by the parts of the Paropanisadae, Arachosia, and Gedrosia that lay towards

<sup>2</sup> The hypothesis that Atropatene was an important place as a refuge for the fire-worshippers has no other basis than a false etymology, Adharbaján = Fíreland. It became important politically only in the later Middle Ages, when it was the gateway of the Turkish migration westward and received a Turkish population.

<sup>3</sup> This is certain from Arrian, ap. Phot., cod. 92, p. 71, b. xl. (Bakker), where Pattala is said to have obeyed Porus.



the Indus. The kings swore to this treaty and became lasting allies.

Instead of the twenty-one Asiatic satrapies of the partitions Seleucus divided his empire into seventy-two, thus diminishing the dangerous strength of the individual governors. But the old arrangement was restored later, and at the beginning of the reign of Antiochus III. we find Media, Persia, Susiana, and the district of the Erythraean Sea (separated off from Babylonia) standing each under one head (Polyb., v. 40-54). Apparently an satrap came to be appointed with military command over all the sections of each old satrapy, and gradually drew to himself all the functions of the satraps in the old régime, so that he could be spoken of indifferently as satrap or strategus.

Seleucus had built for himself a new capital, Seleucia on the Tigris, but in process of time his chief attention came to be more and more engrossed by the affairs of the west, and the seat of power was shifted to Antioch in Syria. A kingdom like that of Seleucus could hardly be governed from Syria, which lay so far from its natural centre, and about 293 or a little later Seleucus found it advisable to make over the upper satrapies to Antiochus, his son by his first marriage with Apama, daughter of Spitamenes, giving him Seleucia as his capital and his stepmother Stratonice as wife. Seleucus, like Antigonus, dreamed of regaining the whole monarchy of Alexander, and fancied himself within reach of his goal after the fall of Lysimachus, when he was himself removed by assassination. Antiochus Soter (280-261) was prudent enough to be content with what he possessed and acquiesce in the actual division of the empire into three realms, practically corresponding to the three continents.

No one had been so zealous as Seleucus in extending Alexander's schemes of colonisation; he is said to have founded seventy-five cities. Among such of these as we know an unusual proportion lies in Media—the breast of Iran, as the Orientals call it—where it was doubly important to strengthen the Macedonian element. A Greek settlement in Kebabana and the cities of Laodicea, Apamea near Rhage, and Europus were his foundations; Alexandria Eschate, in the extreme north-east, was strengthened by new recruits; and even beyond this city, as it seems, in the land of the Scythians, an Antioch was founded. These last undertakings probably came after the association in the empire of Antiochus, who, through his grandfather Spitamenes, had special reasons for interest in these parts. It was then that Demodamas crossed the Jaxartes and raised altars beyond it to the Apollo of Didyma, the patron god of the dynasty. Then, too, Alexander's plan of exploring the Caspian was resumed; the admiral Patrocles made a voyage of discovery, and got only just far enough to be confirmed in the false notion of a north-east passage to India,—probably, therefore, to the extremity of the peninsula of Mangishlak. It was seen, on the other hand, that the Caspian was not connected with the Mesotis; but Seleucus shortly before his death still entertained a plan for a canal from the Caspian to the Cimmerian Bosphorus. Antiochus carried on his father's work of founding cities, and built Laodicea in the east of Persia; but he gave more attention to eastern Iran. A wall of 1500 stadia (about 172 miles) was carried round the oasis of Merv, and there, at the confluence of the Margus and the Zothales, the ruined city Syriana was rebuilt as Antioch, with a circuit of 8 miles. In Aria Antiochus Soter founded Sotira, his general Achaus Achaia; the older chief towns Artacabane and Alexandria on the Arius received new walls, the latter with a circuit of from 3 to 6 miles. Alexandropolis in Arachosia had been similarly strengthened by Seleucus. With all these efforts, however, Hellenism made no such deep impression on Iran as on the west, nor did the loosely-jointed

empire attain to anything higher than a Hellenistic reproduction of the kingdom of the Achæmenians. Even in the fragmentary records that we possess we hear from the first of rebellions little favourable to consolidation of the realm; Seleucus, like Alexander, still had an army of Macedonians and Persians together, while the later Seleucids, at least in their western wars, used natives sparingly and only as bowmen, slingers, or the like, and preferred for these services the wild desert and mountain tribes of Iran.<sup>1</sup> Of the Persian troops of Seleucus we read that 3000 rebelled, and were mastered and destroyed only by treachery; another and seemingly connected story speaks of a rising of 3000 Macedonians (Polyænus, vii. 39, 40). Antiochus himself executed his eldest son, Seleucus, on suspicion of conspiracy against his life; the heir of the kingdom was his second son, Antiochus II. Theos (261-246), a drunken and dissolute prince, who neglected his realm in the society of unworthy favourites.

This king is mentioned in a remarkable contemporary Indian inscription. The Seleucids were constant allies of the great Maura (Magadha) kingdom. Between 311 and 302 Megasthenes repeatedly went as ambassador from Seleucus to Chandragupta, and Daimachus went in like manner from Antiochus to the court of Chandragupta's successor, Amitrâghata (280-276). The next king, Asoka, became a Buddhist about 263. He then founded hospitals for men and beasts throughout his realm, planted places where nothing had grown before, and provided wells and grew trees along the roads for the refreshment of man and beast. Further, he tells us, he caused his example in these things to be followed by his neighbours, whether southern or western. Among the latter Antiochus, king of the Greeks, has the first place.

Under the weak Antiochus II. north-eastern Iran was lost to the empire. While the Seleucids were busy elsewhere, probably in the long war with Ptolemy Philadelphus, which occupied Antiochus's later years, Diodotus, viceroy of Bactria, took the title of king. The new kingdom included Sogdiana and Margiana from the first, while the rest of the East, with a single exception scarcely noticed at the time, adhered to the Seleucids.<sup>2</sup> Now the formation of a strong local kingdom, heartily supported by the Greek colonies, and likely to control the neighbouring nomads and protect its own frontiers with strictness, was by no means agreeable to the chiefs of the desert tribes who, like the modern Turcomans, had been wont to pillage the settled lands, and raise blackmail with little hindrance from the weak and distant central authority at Antioch.<sup>3</sup> Accordingly two brothers, Arsaces and Tiridates, whose tribe, the Parnians, a subdivision of the Dahæ, had hitherto pastured their flocks in Bactria, on the banks of the Oxus, moved west into Seleucid territory near Parthia. An insult offered to the younger brother by the satrap Pherecles moved them to revolt; Pherecles was slain, and Parthia freed from the Macedonians. Arsaces was then proclaimed first king of Parthia (250 B.C.). Such is the later official tradition, and we possess no other account of the beginnings of the Arsacid dynasty. But when the official account transforms Arsaces, who, according to genuine tradition, was the leader of a robber horde and of uncertain descent, into a Bactrian, the descendant of Phriapites, son of Artaxerxes II. (who was called Arsaces before his accession), and makes him conspire with his brother and five others, like the seven

<sup>1</sup> See the accounts of the army of Antiochus III. in Polyb., v. 72; and Livy, xxxvii. 40.

<sup>2</sup> Justin, xli. 4, 5, exaggerates rhetorically, on the basis of some such expression as that used by Strabo, in speaking of the event.

<sup>3</sup> These brigands had destroyed two of Alexander's cities, Alexandria in Margiana and Heraclea in Media, before the time of Antiochus I.; Pliny, *N. H.*, vi. 47, 48.

who slew the false Smerdis, we detect the inventions of a period when the Arsacids had entered on the inheritance of the Achæmenians, and imitated the order of their court. The seven conspirators are the heads of the seven leading noble houses to whom, beyond doubt, the Karen, the Suren, and the Aspahapet belonged.<sup>1</sup> And further, genuine tradition does not know the first Arsaces as king of Parthia at all, and as late as 105 B.C. the Parthians themselves reckoned the year (autumn) 248/247 as the first of their empire.<sup>2</sup> But 248 is the year in which Arsaces I. is said to have been killed, after a reign of two years, and succeeded by his brother, who, like all subsequent kings of the line, took the throne-name of Arsaces. The first Arsaces must have existed, for he appears as deified on the reverse of his brother's drachms, but he was not king of Parthia. Nay, we have authentic record that even in the epoch-year 248/247, the year of the accession of Tiridates, Parthia was still under the Seleucids. These contradictions are solved by a notice of Isidore of Charax (*Geog. Gr. Mss.*, i. 251), which names a city Asaak, not in Parthia, but north-west from it, in the neighbouring Astauene, where Arsaces was proclaimed king, and where an everlasting fire was kept burning. This, therefore, was the first seat of the monarchy, and Pherecles was presumably satrap of Astauene. not eparch of Parthia.

The times were not favourable for the reduction of the rebels. When Antiochus II. died, the horrors that accompanied the succession of his son Seleucus II. Callinicus (246-226) gave the king of Egypt the pretext for a war, in which he overran almost the whole lands of the Seleucids as far as Bactria. Meantime a civil war was raging between Seleucus and his brother Antiochus Hierax, for whom the Galatians held, and at the great battle of Ancyra in 242 or 241 Seleucus was totally defeated and thought to be slain. At this news Arsaces Tiridates, whom the genuine tradition still represents as a brave robber-chief, broke into Parthia at the head of his Parnians, slew the Macedonian eparch Andragoras, and took possession of the province.<sup>3</sup> These Parnian Dahæ were a branch of the Dahæ who lived beyond the Sir Darys and the Sea of Aral (the Tanais and Mæotis of Strabo, xi. p. 515, and Curt., vi. 2, 13, 14), and were called Xandians or Parnians; but, in consequence of internal dissensions, they had migrated at a remote date to Hyrcania and the desert adjoining the Caspian.<sup>4</sup> Here, and in great measure even after they conquered Parthia, they retained the peculiarities of Scythian nomads. The Parthian language is described as a sort of compound between Median and Scythian; and, since the name of the Dahæ and those of their tribes (Strabo, xi. p. 511) show that they belonged to the nomads of Iranian kin, who in antiquity were widely spread from the Jaxartes as far as the steppes of south Russia, we must conclude that the mixed language arose by the action and reaction of two Iranian dialects, that of the Parthians and that of their masters.<sup>5</sup> Their nomad costume the Parnians in Parthia gradually gave up for the Median dress, but they kept their old war-dress, the characteristic scale-armour, com-

pletely covering man and horse. The founder of the empire appears on coins in this dress, with the addition of a short mantle, and so again does Mithradates II. The hands and feet alone are unprotected by mail; shoes with laces, and a conical helmet with flaps, to protect the neck and ears, complete the costume.<sup>6</sup> The conquerors of Parthia continued to be a nation of cavalry; to walk on foot was a shame for a free man; the national weapon was the bow, and their way of fighting was to make a series of attacks, separated by a simulated flight, in which the rider discharged his shafts backwards. Many habits of the life they had led in the desert were retained, and the Parthian rulers never lost connexion with the nomad tribes on their frontiers, among whom several Arsacids found temporary refuge. Gradually, of course, the rulers were assimilated to their subjects; the habitual faithlessness and other qualities ascribed to the Parthians by the Romans are such as are common to all Iranians. The origin of the Parthian power naturally produced a rigid aristocratic system: a few freemen governed a vast population of bondsmen; manumission was forbidden, or rather was impossible, since social condition was fixed by descent; the 10,000 horsemen who followed Surenas into battle were all his serfs or slaves, and of the 60,000 cavalry who fought against Antony only 400 were freemen.

Arsaces Tiridates soon added Hyrcania to his realm and raised a great host to maintain himself against Seleucus, but still more against a nearer enemy, Diodotus of Bactria. On the death of the latter, however, the common interests of the Parthians and Bactrians as against the Seleucids brought about an alliance between Arsaces Tiridates and Diodotus II. With much ado, Seleucus had got the better of his foreign and intestine foes and kept his kingdom together, and in 238 or a little later, having made peace with Egypt and silenced his brother, he marched from Babylon into the upper satrapies. Tiridates at first retired and took shelter with the nomadic Apasiacæ, but he advanced again and gained a victory, which the Parthians continued to commemorate as the birthday of their independence. Seleucus was unable to avenge his defeat, being presently called back by the rebellion stirred up by his aunt Stratonice at Antioch. This gave the great Hellenic kingdom in Bactria and the small native state in Parthia time to consolidate themselves. Tiridates used the respite to strengthen his army, to fortify towns and castles, and to found the city of Dara or Dareium in the smiling landscape of Abévard. Tiridates, who on his coins appears first merely as Arsaces, then as King Arsaces, and finally as "great king" (probably in imitation of Antiochus Magnus), reigned thirty-seven years, dying in 211 B.C. His nation ever held his memory in almost divine honour.

Seleucus III. Soter (226-223) died early, and was followed by Antiochus III. Magnus (223-187), who in his brother's lifetime had ruled from Babylon over the upper satrapies. Molon, governor of Media, supported by his brother Alexander in Persia, rose against him in 222 and assumed the diadem.<sup>7</sup> The great resources of his province, which followed him devotedly, enabled Molon to take the offensive and even to occupy Seleucia after a decisive battle with the royal general Xenetas. Babylonia, the Erythraean district, all Susiana except the fortress of Susa, Parapotamia as far as Europus, and Mesopotamia as far as Dura were successively reduced. But the young king soon turned the fortunes of the war. Crossing the Tigris in person, he

<sup>1</sup> Moses of Chorene (II. 28) knows only these three lines besides the Arsacids. Other Armenian historians, however (Langlois, I. 109, 199), know four lines of Arsacids which may have taken the place of lost families.

<sup>2</sup> See the cuneiform tablet in G. Smith, *Assyrian Discoveries*, p. 389, which agrees with Euseb., *Chron.*, p. 299 (Aucher).

<sup>3</sup> Justin, xii. 4, 2. What is said of Andragoras in xii. 4, 12, rests on a slip of the memory.

<sup>4</sup> The common tradition connects the migration with the conquests of the Scythian king Iandyses, a contemporary of Sesostris. It adds that Parthian means "fugitive" or "exile" (Zend, *parthwa*). But the name Parthava is found on the inscriptions of Darius long before the immigration of the Parnians.

<sup>5</sup> An idea of the difference between the two may be got from the fragments of Khârezmian, preserved by Bérûni.

<sup>6</sup> Mithradates I. was the first to adopt the robes of a Persian great king.

<sup>7</sup> The coins of "King Molon" show that his rebellion has nothing to do with the King Antiochus of C. I. G., 4458. The latter, appearing in a list of deified kings arranged in the order of their dedication or death, is the eldest son of Antiochus III., who died in 198.

penetrated into Apolloniatis and cut off Molon's retreat. Molon was forced to accept battle near Apollonia; his left wing passed over to the enemy, and, after a crushing defeat, he and all his kinsmen and chief followers died by their own hands (220). Antiochus now marched to Seleucia to regulate the affairs of the East. He used his victory with moderation, mitigating the severities of his minister Hermias; but he had effectually prevented the rise of a new kingdom in the most important province of Iran. In the same year, before he returned to Syria, he marched across Mount Zagrus against the aged Artabazanes, the most powerful of the native princes, who ruled not only Atropatene but the neighbouring lands, especially east Armenia (Polyb., v. 55, 7), and by the terror of his approach extorted an advantageous treaty.

A period followed in which the king was fully occupied in the west, but after this he began a campaign of several years in the upper satrapies, to which his contemporary renown was mainly due. First he regulated the affairs of the Armenian kingdom of Arsamosata, whose king, Xerxes, had fallen by the intrigues of his own wife, a sister of Antiochus.<sup>1</sup> Then, descending the Euphrates by ship to Seleucia, he appeared in Media in 209, hardly as an enemy, though he seized the gold and silver decorations of the temple of the goddess Aene in Ecbatana. Thence with 100,000 foot and 20,000 horse he marched against the new Parthian king, Arsaces II.,<sup>2</sup> son and successor of Tiridates. Crossing the desert obliquely to Hecatompylus, he forced his way into Hyrcania over Mount Labus (the eastern part of the Elburz mountains), defeating the Parthians on the summit, and besieged the fugitives in Sirynca. The Parthians planned an escape by night, and massacred the Greek residents to prevent its betrayal; but the plan failed. The city yielded, and the war ended in a treaty which left Arsaces his kingdom, but beyond question reduced him to a vassal. In 208 began the much more serious war with Bactria. Here the successors of Diodotus had been dethroned by a usurper, Euthydemus of Magnesia, whose coins indicate a long reign. Euthydemus tried to defend the line of the Arius (Herirud), but Antiochus effected a passage a little west of the city Guriana,<sup>3</sup> inflicted a decisive defeat on the hostile cavalry, and forced Euthydemus to retreat to Zariaspa. But the siege of Bactra, the capital, proved tedious, and the war made little progress. Antiochus himself opened negotiations and was impressed by the declaration of the Bactrian king, that if he were reduced to extremities he must call in the help of the nomads, which would be fatal to the Greek civilization of the land. At length, in 206, a peace was arranged, and Antiochus was visited in his camp by Demetrius, the youthful son of Euthydemus, who pleased the king so well that he betrothed to him his daughter; Euthydemus was left on his throne, and the two powers swore an alliance offensive and defensive, which cost Bactria no more than certain payments of money, the victualling of the Macedonian troops, and the surrender of the war-elephants. The Bactrian Greeks were grateful for this moderation; their memorial coins place Antiochus Nicator with Euthydemus Theos, Diodotus Soter, and Alexander Philippi among the founders of their political existence.<sup>4</sup> Antiochus next

crossed the Paropamisus into the valley of Cabul, renewing the friendly relations of his dynasty with the Indian king Subhagasaena, and receiving from him 150 war-elephants. The return march was through Arachosia and Drangiana, the winter being spent in Carmania. Thus it appears that south of the Paropamisus political relations had remained unchanged for a hundred years, and the successes of Antiochus in Upper Asia, together with the prudent limitation of his schemes to what was practicable, did much to give permanence to the empire in the East, notwithstanding its many points of weakness. The series of victorious campaigns was concluded by a maritime excursion in 205 against the rich merchant-community of Gerrha on the Arabian shore of the Persian Gulf, in which Antiochus again showed his moderation, receiving from the Gerrhians a gift, 500 talents of silver, 1000 talents of incense, and 200 talents of oil of myrrh, but leaving them the freedom they had enjoyed from time immemorial.

Under very different circumstances did Antiochus revisit the eastern lands eighteen years later, his prestige broken by the war with Rome, and his position as a great power shattered in a way that could not fail ultimately to react on his Asiatic subjects. His most urgent difficulty, however, lay in an exhausted treasury, and the demands of Rome for a heavy war-tribute. Antiochus came to Susa in search of money and seized a pretext to plunder the rich and famous temple of Bel in Elymais; but the attempt was fatal to its author, who was destroyed, together with his followers, by a rising of the Elymians (187). This, no doubt, was the moment when Elymais became independent and formed a small separate kingdom in the upland part of Susiana.

Antiochus was followed in the kingdom by his sons, first the weak Seleucus IV. Philopator (187-175), and then the gifted Antiochus IV. Epiphanes (175-164), who had a clear insight into the evils that were sapping the empire, but attempted to cure them and bind the loose complex of provinces more closely to the centre with such impatience and violence that he only hastened the fall of his dynasty. He too, like all the later Seleucids, was in chronic want of money, and it was chiefly to raise tribute that he marched into the East in 166. He first made for Greater Armenia and the neighbouring Sophene, which had never paid much more than nominal allegiance to Macedonia, and after the defeat of Antiochus the Great by Rome (189) had formed themselves into kingdoms under Artaxias and Zadiades, the former strategi. Antiochus penetrated into Armenia and took Artaxias prisoner, but restored him to his kingdom. He was next called by urgent affairs to the shores of the Persian Gulf. Over the Persians we read that his lieutenant in Mesene gained a double victory in one day, by sea and by land, at the promontory of Naumachæa<sup>5</sup> over against the Carmanian coast. This victory, however, implies that Persis had already cast off the Macedonian yoke,<sup>6</sup> and that the new kingdom had already extended its sway over the opposite coast of 'Omân, as we know to have been the case about 70 A.D.<sup>7</sup>

At the mouth of the Tigris Antiochus restored an old city of Alexander's and called it Antioch;<sup>8</sup> it had been destroyed by an inundation, a sign that the negligent government of the later Seleucids had let the canal system,

<sup>1</sup> Pliny, vi. § 152; but one is tempted to suspect a corruption of the text and read *Drymatine*, *Mace*; *horum*, &c.

<sup>2</sup> Strabo, xv. p. 786, gives a general confirmation of the existence of a kingdom here in the time of the Macedonians.

<sup>3</sup> *Peripl. M. Br. (Geog. Gr. Afric.*, i. 288). The connexion of the opposite coasts is natural; in the 10th century the Buwaihids ruled over 'Omân.

<sup>4</sup> Pliny, *N. H.*, vi. 139, says "Antiochus quintus regem," reckoning Antiochus Hierax. We call Eupator Antiochus V., but he cannot be meant, and there is no way of counting which would make Sidetes the 5th Antiochus.

<sup>1</sup> John of Antioch, in Müller, iv. 657.

<sup>2</sup> This king seems to have had Arsaces as his proper name, for Justin always uses the proper name of Parthian kings. Vaillant's conjecture, which gives him the name of Artabanus I., has no basis.

<sup>3</sup> For *Taroupias*, Polyb., x. 49, where all editors adopt the geographically impossible *Taroupias* of *Reiske*, read *τὰ Ποιπίανα*, comparing Ptol., vi. 10, 4.

<sup>4</sup> That Antiochus Nicator is Antiochus III. Magnus follows from Malalas, i. 261; if the style of his Bactrian coins, resembling as they do those of Diodotus, really demands an earlier date, they must belong to the last of the Diodotides not mentioned by the authors, not, as the numismatists suppose, to Antiochus II.

restored by Alexander, fall again into ruin. Another of Epiphanes's measures directed to the strengthening of the Hellenic element in the East was the occasion of the change to Epiphanæa of the name of the Median capital. But against these useful efforts must be set the plundering of the temples of the barbarians, a sure way to exhaust Oriental patience, and one which involved the king in a catastrophe so like to that of his father that we should suspect some confusion were the accounts not so well confirmed.<sup>1</sup> The king, we are told, heard of a rich temple of the goddess Nanaea in Elymais stored with the gifts of many generations; he marched out to plunder it, but was driven back by the natives to Babylon. In Persia he received tidings of the formidable rising in Judæa, excited by similar acts of violence; apparently he was then on his way against the Persian rebels, but on the journey he died of consumption in the Persian town of Tabæ (164).

Antiochus had given Mesene with its capital, Antioch, to a native dynast, Hyspasinæ, as satrap; and, when Antioch, like its predecessor Alexandria, was soon ruined by floods, the city was removed to an artificial hill and protected by an embankment. Under the name of Spasinu Charax (Hyspasinæ's pile-town) the new city rose to commercial prosperity, and became the capital of the petty kingdom of Characene, which probably became independent at the death of Antiochus. Thus the Seleucid empire was now quite cut off from the Persian Gulf by a circle of small native states.<sup>2</sup>

Now followed the troubled reign of the child-king Antiochus V. Eupator (164-162), which was cut short by Demetrius Soter (162-150). The latter was constantly persecuted by the Romans, who raised enemies against him on every side, and so the times seemed to invite a renewal of the enterprise of Molon. Since the time of Epiphanes the satrap of Media had been one Timarchus of Miletus, brother of the intriguing and influential treasurer Heraclides, and, like the latter, a favourite of the late king, who had often sent him to Rome. Knowing the ground there, he went to Rome, and easily persuaded the senate to grant him the title of king (161).<sup>3</sup> He made a treaty with Artaxias of Armenia against Demetrius, compelled the neighbours of Media to acknowledge him, and extended his power as far as Zeugma, and finally over Babylonia.<sup>4</sup> But he fared in the end no better than Molon. The Babylonians were oppressed and hated him, and the self-conceived majesty of Timarchus, who on his coins called himself "the Great," soon broke down in conflict with Demetrius, one of the most gifted princes of a highly-gifted dynasty. Timarchus was slain, his brother fled, and the victor was saluted as "saviour" (Soter) by the grateful Babylonians (160). It was a great victory for Demetrius; he had saved the best part of Iran for his monarchy, and he had shown all who speculated on the support of Rome that the decrees of the republic were powerless in regions to which its arm could not reach.

The true danger for the Macedonian monarchy came not from rebellious lieutenants but from the ever stronger reaction of the Oriental element, of which the little state of Parthia was the most vigorous champion. The kings of Parthia had long kept quiet after the war with Antiochus the Great. Phriapatius, successor of Arsaces II., who reigned fifteen years (c. 191-c. 176), calls himself on his coins

"Arsaces Philadelphus," perhaps because he had married a sister, and (first of all Parthian kings) Philhellen.<sup>5</sup> By the last title he presents himself, at a time when the Seleucid power was sinking, as the protector of his present and future Greek subjects. His eldest son and successor, Phraates I. (Arsaces Theopator of the coins), conquered the brave Mardian highlanders and transplanted them to Charax in the neighbourhood of the Caspian Gates, a proof that the Parthians had already detached Comisene and Choarene<sup>6</sup> from Media (Strabo, xi. 514), probably just after the death of Antiochus the Great.

About 171 Phraates died and left the crown not to his sons but to his brother Mithradates (Arsaces Epiphanes, and apparently also, on tetradrachms of 139, 138, Arsaces Philhellen), a prince of remarkable capacity, who made Parthia the ruling power in Iran. His first conquests, it would seem, were made at the expense of Bactria.

The kingdom of Bactria had made vast advances under Euthydemus, whose son Demetrius crossed the Indian Caucasus and began the Indian conquests, which soon carried the Greeks far beyond the farthest point of Alexander. The Punjab was reduced and the city of Çâkâla, under the name of Euthydemia, became the capital of the Indian conquests; but besides this it appears that Demetrius himself marched down the course of the Indus, conquered Pattala and the kingdoms of Saraoetes (Surâshtra) and Sigerdia, probably the district of the commercial city Barygaza. The object, it is plain, was to reach the sea and get a share in the trade of the world; and it is possible that the extension of the power of the Bactrian Greeks over Chinese Tartary as far as the Seres and Phaunians had a similar object, viz., to protect the trade-route with China along the Tarym river. For the Seres are the Chinese, and the Phauni, according to Pliny,<sup>7</sup> lay west of the Attacori (the mythical people at the sources of the Hoang-ho) and east of the Tochari, whose earlier settlements were east of Khoten. They occupied, therefore, the very region which, according to Chinese sources, was then held by a nomadic pastoral people, the Tibetan No-kiang. History shows that Chinese Tartary is easily conquered from the Oxus and Jaxartes, but very hard to hold, and there is thus no reason to doubt the truth of the Bactrian advance in this direction. Strabo, unluckily, does not tell us whether the campaign was made by Demetrius; it must have fallen before 177, when the great conquests of the Hiung-nu began, but after 201, when the founder of the Han dynasty regained the country as far as the Great Wall, and put China in a position to take part in the trade of inner Asia. This is precisely the period of the greatest power of the Greeks in Bactria. Demetrius, having succeeded his father, was displaced in Bactria by the able usurper Eucratides, some time between 181 and 171.<sup>8</sup> A thousand cities obeyed Eucratides, and both he and his rival Demetrius sought to extend the Greek settlements, the one founding Eucratidia in Bactria, the other Demetrias in Arachosia. Now Justin tells us that the Bactrians were so exhausted by wars with the Sogdians, Arachosians, Drangians, Arians, and Indians that they at length fell an easy prey to the weaker Parthians; but Eucratides he describes as a valiant prince, who once with 300 men held out during five months, though besieged by 60,000 men of Demetrius, king of India, and then, receiving succours, subdued India.

<sup>1</sup> Comp. *Gran. Licinian.*, p. 9, with the first confused account in the letter of the Jews to Aristobulus, 2 Mac. I. 10 sq.

<sup>2</sup> Hyspasinæ was not an Arab, as Pliny states, vi. § 139. The Iranian names of the older kings of Characene justify Juba's account of their extraction.

<sup>3</sup> The corrupt passage of Diodorus, *Exc. Escur.*, 13, ought to run thus, *Τιμάρχης ἑταίρος καὶ ἀδελφὸς βασιλέως ἐταύρα*.

<sup>4</sup> In *Diocl.*, l. c., read *τῆς Βαβυλωνίας* for *τῆς Βασιλείας*. Hence the error of Applan, who does not mention Media at all.

<sup>5</sup> For these and other Parthian coins P. Gardner's work is the authority. One of them is dated 125 Sel. = 187 a.c.

<sup>6</sup> Choarene contains the only Greek city in the older conquests of the Parthians, and the coin with Greek date and title is of the year of Antiochus's death.

<sup>7</sup> *N. H.*, vi. 65, where read "Phuni et Thocari."

<sup>8</sup> Sallet's numismatic arguments, which place Eucratides about 200 a.c., are not conclusive, and do violence to the other testimonies.

This implies that besides the kingdom of Bactria and that of Demetrius—the latter now confined to India and probably to the lands east of the Indus—there were independent states in various districts still Seleucid in 206. Justin's statement is confirmed by the coins, which also show that Eucratides came forth as victor from a series of wars with the lesser states. Sogdiana, according to Chinese authorities, was occupied by the Scythians in the lifetime of Eucratides; Antimachus, to judge from a naval victory recorded on his coins, once reigned on the lower Indus; the principal place where coins of him and his successor Antialcidas have been found is the Cophen valley; the latter prince, who borrows from Antiochus Epiphanes the title "Nicephorus," may be viewed as his younger contemporary. The neighbouring realm of Plato was ephemeral, but his money is unique as giving a date by the Seleucid era (166 B.C.). Pantaleon and Agathocles, whose coins are chiefly to be found in Bagram, Cabul, Ghasni, Kandahar, and Sistan, were doubtless kings of Arachosia and Drangiana. Before these countries belonged to Demetrius, and even, as the coins show, to his father Euthydemus, who cannot have been contemporary with the last years of Antiochus the Great, so that they were probably given as a dowry to his daughter when she married Demetrius. This marriage really took place, for the Seleucid name Laodice is found among the Bactrian Greeks. The victories of Eucratides are proved by his surfrappé coins. Thus he restruck coins of Antialcidas and appears posthumously as "God of the city Kariji" on money of Apollodotus, king of the Indians. Heliccles, co-regent and successor of Eucratides, and Strato, apparently the successor of Apollodotus, restruck each the money of the other, and Heliccles's name also appears over what is perhaps a coin of Philoxenus, who reigned in the region of Peshawar.<sup>1</sup>

On his way back from the conquest of India Eucratides was murdered by his son and co-regent, probably Heliccles.<sup>2</sup> The date of this murder may be fixed by that of Demetrius, who must have been born not later than 224, and may be taken to have lost his kingdom not later than 159. Eucratides cannot, according to Justin's account, have lived many years longer. This would give c. 155 B.C. as the latest possible date for the death of Eucratides. A little before this time notable signs of concession to the rising spirit of the natives appear on the coins. The medals of the older Greek kings follow the Attic standard and have only Greek legends, but from the time of Demetrius the reverse bears a legend in the Indian language spoken in the Cabul valley and in the so-called Arianian character, a letter derived from the Semitic. At the same time we begin to find square coins, and in the later part of the reign of Eucratides a new native standard begins to prevail.<sup>4</sup>

In the midst of the civil wars, which became more serious after the death of Eucratides, Mithradates of Parthia began to extend his dominions at the expense of Bactria; even in the lifetime of Eucratides he succeeded in annexing the satrapies of Aspionas and Turiana. These seem to have covered Aria, for the Hindu-Kush is named as the eastern boundary of the Parthians (Justin, xii. 6, 8),—whence perhaps the mention of Arians amongst the foes of Eucratides. Another account makes Mithradates rule as far as India, and declares him to have obtained without war the old kingdom of Porus, or the rule over all nations between the Indus and the Hydaspes.<sup>5</sup> The two accounts are reconciled by Chinese records, which tell that c. 161 B.C. the nomad people See broke into the valley of the Cophen and founded a kingdom in the very place of the

Parthian conquests in India, which must therefore have been ephemeral. This fact has its importance, as illustrating the way in which the internal wars of the east Iranian Greeks helped to prepare the ground for the Scythian invasion. After this success in the east Mithradates turned his attention to the west, where the chances of success were not less inviting. Demetrius had at length fallen before a coalition of the neighbouring sovereigns, powerfully supported by the Romans through their instrument the exile Heraclides. A pretender, who called himself son of Antiochus Epiphanes, was put up as king by the coalition; he appeared in Syria in 152, and slew Demetrius in battle in 150. The pretender, who took the name of Alexander Theopator Euergetes, proved quite incompetent, and lost the support of Ptolemy Philometor, who in 147 put up Demetrius, the son of Demetrius, against him. At length, in 145, Alexander, utterly defeated by Ptolemy, was slain in his flight by an Arab chieftain. Demetrius II. Nicator, however, soon made himself bitterly hated, and a certain Diodotus of Casiana, in the region of Ajamea, a man of mean origin, was able first to set up against him Alexander's young son Antiochus Epiphanes Dionysus, and then to murder his puppet and proclaim himself as King Trypho. Five years of fighting drove Demetrius out of the greater part of Syria. Such was the state of the empire when war broke out between Media and Parthia, and was finally decided in favour of the latter. Mithradates left Bacasis in Media and turned to Hyrcania. Media in this account appears as independent, and that this was so is confirmed by the notice in Diod., *Err. Ec.*, 25, that a certain Dionysius "the Mede" raised Mesopotamia in 142 against Trypho to avenge the murder of the young Antiochus. Dionysius must be a son of Timarchus; Heraclides, when he installed Alexander in Syria, must have thought also of his own family, and raised it again to the throne of Media, which the senate had already recognized as a separate kingdom. But the short-lived independence of Media was, as we have seen, soon cut short by Mithradates, who did not lose the opportunity afforded by the civil wars of Syria in 147. Babylonia followed the fate of Media; Demetrius's lieutenant was defeated, and the whole province, with its capital Seleucia, fell into the hands of the Parthians. Thus the East was finally lost to the Macedonians.

The change of rule was not well received by the new subjects of Parthia, least of all by the Greeks and Macedonians of the upper provinces, who sent embassy after embassy to Demetrius. That prince, who had now little to lose in Syria, at length accepted their invitation to come and take the rule over them, hoping that if he could secure the upper satrapies they would help him against Trypho. In 140 he marched into Mesopotamia, and thence by Babylon to the upper provinces. He was well received by the natives, and even the small native states made common cause with him against the proud barbarians, whose neighbourhood they felt as oppressive. He was joined by the Persians and Elymæans, and the Bactrians helped him by a diversion, appearing now for the last time as an independent people. At first things went well, and the Parthians were defeated in several battles, but in Media in 139 Demetrius was surprised by the lieutenant of Mithradates during negotiations for peace; his forces were annihilated, and he himself taken prisoner and dragged in chains through the provinces that had joined his cause. The Parthian king received his captive with favour and assigned him a residence and suitable establishment in Hyrcania. He even gave him his daughter Rhodogune, and promised to restore him to his kingdom, but this plan was interrupted by death.

Mithradates's last campaign was against the king of Elymais, Demetrius's ally; the rich temples of Elymais,

<sup>1</sup> *I. e.*, Charis, a Greek town, which Apollon, *Syr.*, 57, placed in Parthia with two other towns which really lay in Aria.

<sup>2</sup> See in general, A. v. Ballet's "Nachf. Alex. d. Gr.," in *Zeitschr. f. Num.*, vi., and Cunningham, *Num. Chron.*, ix. x.

<sup>3</sup> This is the usual assumption, for Heliccles appears on coins both as contemporary and as successor of Eucratides, and there is a surfrappé coin of his which was originally struck by Eucratides for the marriage of Heliccles with Laodice (perhaps a daughter of Demetrius by his Seleucid queen). But there is much to be said for the view of Cunningham (*Journ. As. S. Beng.*, 1840, p. 869; *Num. Chron.*, ix. 289), that the murderer was Apollodotus, whose title "Philopator" always points to a co-regency.

<sup>4</sup> Ballet, *op. cit.*, p. 25 sq.

<sup>5</sup> This account goes back through Oros., v. 4 (following Livy), and Diod., p. 597, to the excellent authority of Posidonius.

that of Athena, and that of Artemis or Nausa in Azara yielded him a booty of 10,000 talents (£2,258,000), and the great town of Selencia on the Hedyphnon was taken<sup>1</sup> (Strabo, xvi. p. 744). The country was brought under Parthia, but continued to have its own kings. The coins make it likely that Mithradates simply set up a new dynasty, a branch of his own house.<sup>2</sup> Mithradates died in a good old age in 138, or a little later.<sup>3</sup> His memory was revered almost equally with that of the founder of his house, but his real glory was much greater, for it was he who made Parthia a great power. He is praised as a just and human ruler, who, having become lord of all the lands from the Indian Caucasus to the Euphrates, introduced among the Parthians the best institutions of each country, and so became the legislator of his nation.

The divisions of the empire which he founded can be sketched by the aid of an excerpt from the itinerary of Isidore of Charax (at the beginning of the Christian era) and of Pliny (*N. H.*, vi. 44, 112). The empire was divided into the upper and lower kingdoms, separated by the Caspian Gates. The lower kingdoms were seven—(1) Mesopotamia and Babylonia, (2) Apolloniatis, (3) Chalonitis,<sup>4</sup> (4) Carina,<sup>5</sup> (5) Cambadene, (6) Upper Media, (7) Lower or Rhagian Media,<sup>6</sup> The upper kingdoms were eleven—(8) Choarene, (9) Comisene,<sup>7</sup> (10) Hyrcania, (11) Astaucene, (12) Parthyene, (13) Apsaurticene,<sup>8</sup> (14) Margiana, a part of Bactria, (15) Aria, (16) the country of the Anasans (a division of Aria), (17) Zarangiana,<sup>9</sup> (18) Arachosia, now called "White India." The eighteen Parthian kingdoms thus correspond to six old satrapies; the new divisions were probably derived from the provinces of Seleucus Nicator (see especially Posidonius in Strabo, xvi. p. 749). But upper and lower provinces have changed their meaning; apart from Arachosia, the upper provinces are the old conquests of the Parthians before they occupied Media and became lords of Iran, and the lower all the later conquests in the west. The Parthians, we see, gave much less attention to the west than did their predecessors, and they still left Mesopotamia as the only great satrapy, and perhaps first added Babylonia to it when Ctisipion became the residence of the Arsacids. We note also that they cared little for reaching the sea, which they can have touched only for a little way at the mouth of the Euphrates; and even here they allowed the petty Characene quite to outstrip them in competing for the great sea-trade. As compared with the older Macedonian empire, the Parthian realm lacked the east Iranian satrapies, Bactria with Sogdiana, and the Paropamisadae, and also the three Indian ones, which, with Paratracene, or, as it was afterwards called, Sacastane, remained under the Bactrian Greeks and their successors. In the north they lacked Lesser Media, which had long been an independent state, and in the south they lacked Susiana, which now belonged to Elymais, and the satrapies of Persis and Carmania, which the Persians held along with the

western part of Godrosia (*Per. Mar. Er.*, § 97). In the extreme west they lacked Arbelitis proper, which formed a small kingdom under the name of Adiabene, first mentioned in 69 B.C. (Plut., *Lucullus*, 27). The kingdom of Mannus of Orrha (*Máδρος Όρρα*, so read) in north Mesopotamia, which according to Isidore (§ 1) reached a good way south of Eleasa, seems also to have been independent, and, like Adiabene, probably existed before the Parthian time. From these small kingdoms the Parthians asked only an acknowledgment of vassalship. When Parthia was vigorous the vassalship was real, but when Parthia was torn by factions it became a mere name (Strabo, xvi. p. 732). The relation was always loose, and the political power of Parthia was therefore never comparable to the later power of the Sasanians. Arsaces Tiridates and his successors called themselves "great king." Mithradates, as overlord of the minor kingdoms, first bore the title "great king of kings." The title seems to have been conferred, not assumed in mere boastfulness; for (apart from a single usurper in times of disorder who calls himself "king of kings") none of his successors bears it until Phraates III., seventy years later,—a fact clear from the coins, but hitherto unnoticed. The nobility had great influence in all things, and especially in the nomination of the king, who, however, was always an Arsacid. Next to the king stood the senate of *probuli*,<sup>10</sup> from whom all generals and lieutenant-governors were chosen. They were called the king's kin, and were no doubt the old Parthian martial nobility. A second senate was composed of the Magians and wise men, and by these two senates the king was nominated (Posidonius, ap. Strabo, xi. p. 515). The Parthians were, in fact, very pious; conscientious in observing even the most troublesome precepts of Zoroastrianism as to the disposal of dead bodies, which were exposed to birds of prey and dogs, the bare bones alone being buried (Justin, xli. 3, 5, 6). When the Parthian prince Tiridates visited Nero he journeyed overland that he might not be forced to defile the sea when he spat, and his spiritual advisers the Magians travelled with him (Plin., xxx. 17). The Magians were not, indeed, so all-powerful as under the Sasanians, but it is quite a mistake to think that the Parthians were but lukewarm Zoroastrians.

The complete annihilation of the Macedonian empire in Iran was closely followed by the destruction of Greek independence in eastern Iran, north of the Paropamisus. The last mention of independent Bactria is in 140; no king of Bactria and Sogdiana is known from coins after the paricide Heliocles. Classical writers give only two laconic accounts of the catastrophe. Strabo says that "the nomadic peoples of the Asia, Pasiani, Tochari, and Sacaræ (so read for *Σακάρωνλοι καί* in xi. p. 511), dwellers in the land of the Sacæ, beyond the Jaxartes [in its middle course], opposite to the Sacæ and Sogdians, came and took Bactria from the Greeks." Troguus (*Prof.*, xli.) names the Scythian peoples Sarauæ and Asiani.<sup>11</sup> Fortunately the lively interest taken by the Chinese in the movements of the nomads of Central Asia enables us to fill up this meagre notice from the report of the Chinese agent in Bactria in 128, as recorded a little later by the oldest Chinese historian, and from other notices collected by the Chinese after the opening of the regular caravan route with the west, about 115, and embodied in their second oldest history.<sup>12</sup> According to these sources the Yue-chi, a nomad people akin to the Tibetans, lived aforesite between Tun-hoang (*i.e.*, Sha-chou) and the Kilien-shan mountains, and about 177 were subjugated, like all their neighbours, by the Turkish Hiung-nu. Between 167 and 161 they renewed the struggle without success; Lao-shang the great khan of the Hiung-nu, slew their king Chang-

<sup>1</sup> In giving this order of events it is assumed that the capture of Demetrius, omitted in Justin's epitome of Troguus, xli. 6, comes after § 7, not, as has been assumed since Vaillant, after § 8. When Troguus mentions such unimportant events as the nomination of Bacasis to Media and the visit of Mithradates to Hyrcania, we must suppose that these facts bore on others of more note, that Bacasis was the captor of Demetrius, and that the royal court was in Hyrcania when the captive was brought before the Parthian king.

<sup>2</sup> Coins of the venerable Camnascires, whom Pseudo-Lucian *Macrobii* calls a Parthian, but separated from the great kings by Armenia and Characene, have been brought from Baghdád and Shuster, and can hardly have been struck elsewhere than in Elymais. He was preceded by an Arsacæ, not one of the main Parthian line. See Sallet, in *Z. f. Num.*, viii. 207 sq.

<sup>3</sup> Demetrius had married Rhodogune when Antiochus VII. married his deserted wife Cleopatra in 138, and there were children by the marriage, though not earlier than the time of Demetrius's second attempt to escape; hence both attempts must have been after the death of Mithradates.

<sup>4</sup> These three make up the old satrapies of Mesopotamia (with Arbelitis) and Babylonia. The whole land between the Euphrates and the Tigris was now put together, and the countries to the east of the Tigris detached, Apolloniatis being taken from Babylonia, and Chalonitis from Arbelitis.

<sup>5</sup> In Isid., § 4 (*Geog. Min.*, l. 250), read *Ἐρεθθεν Μυθία καὶ χώρα Κάρανα, ἧτις κατέχει σχολαίους κβ. ἡ ἀρχὴ αὐτῶν.*

<sup>6</sup> Nos. 4 to 7 are all parts of the old satrapy of Media.

<sup>7</sup> The two most eastern parts of Media that were the first Parthian conquests.

<sup>8</sup> Nos. 10 to 13 form the old satrapy of Parthia and Hyrcania.

<sup>9</sup> Nos. 15 to 17 belong to the old satrapy of Aria with Drangiana. Sacastane, another part of this satrapy, was not Parthian, but, as Isidore remarks, belonged to the Sacæ.

<sup>10</sup> For *populorum* (Just., xli. 2, 2) a synonym of *senatus* (xlii. 4, 1) is wanted; write, therefore, *probulorum*.

<sup>11</sup> Modern writers since Beyer make the Greek kingdom in Bactria fall before the Parthians, appealing to Just., xli. 6, 3. But the epitome here contradicts its source, and confounds the fall of the kingdom with the earlier loss of two satrapies to the Parthians under Eucratides. The right account is to be found elsewhere in Justin himself, ii. 1, 3; 3, 6.

<sup>12</sup> Comp. the *Saeki* of Sematsien (100 B.C.), tr. by Brosset, *Font. Journ. As.*, ii. 418 sq., and the *Annals (of the first Han)* of Panku (80 A.D.), excerpts from which are given by Ritter, *Ersk.*, pt. vii. bk. 3, pp. 604-728; Deguignes, *Hist. des Huns*, l. 2, p. lxxv. sq., 41 sq., 121 sq.; Becherches sur quelques événements, " &c.," in *Mém. Ac. Inscr.*, xiv. 17 sq.; Abel Rémusat, on the *Fo-hi-kou-ki*, p. 37 sq. The account given in the text is based wholly on the two oldest sources, without reference to the newer Chinese encyclopædias. Comp. further Bickhoffen, *China*, p. 447.



lun, and made a drinking-cup of his skull,<sup>1</sup> and the great mass of the vanquished people (the great Yue-chi) left their homes and moved westward, and occupied the land on Lake Issyk-kul, driving before them another nomad race, the Sse. The Sse took the road by Uteh and Kaahgar, ultimately reaching and subduing the kingdom of Kipin (the Cabul valley), while their old seats were occupied by the Great Yue-chi, till they in turn were soon attacked by the Usun, who lived west of the Hiung-nu, and forced to move farther west (160 or 159). The older Chinese account ignores the residence of the Yue-chi at Lake Issyk-kul, which can at most have lasted only for a few years; the later account goes on to say that, moving westward, they conquered the Ta-hia, i.e., the Bactrians. The language of the older narrative has been held to imply that they went by way of Ferghana and remained there for some time; but in reality it only says that they retired beyond Ferghana and conquered the Ta-hia, thereupon pitching the royal camp north of the Oxus, and so it appears that in 159 they moved straight on Sogdiana, reaching that land just at the time when internal wars were undermining the might of Eucratides. The conquest, however, may have been gradual, since Bactria is still named as independent in 140.

When the Yue-chi were already settled in their new homes the king of China sent a certain Chang-kien to urge them to return and help him to clear the caravan-road by thrusting back the Hiung-nu. He was arrested on his way by the latter, but escaped in 129 to Ferghana, and thence was led to the Yue-chi through the land of the Khang-kiu, on the middle course of the Jaxartes. But the Yue-chi were too happily settled in a rich and peaceful land to listen to his representations, and after a year's residence (128-127) he returned to China, which he reached in 126, after falling again into the hands of the Hiung-nu on the way. From him are derived almost all the accounts of the country and its inhabitants given by the Chinese historians. There were, we are told, settled and agricultural peoples in Great Wan (Ferghana), Ta-hia (Bactria), and An-si (Parthia). All the races from Ferghana to Parthia had deep-set eyes and strong beard and moustache; their dialects varied, but as they all understood each other all must have been Iranian in speech. Their manners, too, were much alike; they paid great respect to women, and the men were very complaisant to their wives. This is almost exactly what Bardiennes says of the position of women in his time among the Kushan in Bactria;<sup>2</sup> but it was quite otherwise in Parthia, where the Oriental seclusion of women was carried to the extreme (Just., xii. 3, 1, 2). They were all knowing traders, and understood the preparation of silk and lac, but not metallurgy till they were taught that art by Chinese agents and deserters. They then imported the precious metals from China and made gold and silver vessels, but not money, being in this respect behind the Parthians.<sup>3</sup> Great Wan probably corresponds to the *Ὀξάρια* of Ptolemy (though he misplaces them) and the *Varena* of the *Vendidad*; it was a separate kingdom, with a population estimated at 300,000 souls in the 1st century B.C., and seventy subject cities. The king, probably a native who had risen on the fall of the Greeks, lived in Kuei-shan (probably Khojend, at the mouth of the Ferghana valley), and could call out an army of 60,000 men,—lancers, archers, and mounted bowmen. The land was famous for its wine and for horses of divine race which sweated blood, and for the possession of which China went to war with Great Wan in 104-103, and again in 102-98. Lucerne and grapes were exported to China; the name of the latter, "po-tao," is held to be the Greek *βότρυς*, which would show that the vine was introduced by the Greeks of Alexandria Eschata. South of the Wei or Oxus lies Ta-hia (probably *Zem Dabays*, the land<sup>4</sup>). Here there was no king, but the several cities were the seats of chiefs, a state of things such as Alexander had found in the country and as reappeared under the Turks in the 7th century A.D. Chang-kien estimated the population at a million; they were bad and cowardly soldiers, but excelled in trade, and the chief town, Lan-shi, had rich bazaars of many wares. This town must be one of the commercial cities on the river Bactrus, along which lay the trade-route from India to the north (Pliny, vi. 52), i.e., either Bactra or Eucratidia which, according to Ptolemy, vi. 11, 8 [Codd. B., E., Pal. 1], lay over down the stream on the left bank). In the latter case Lan-shi may stand for *Ἰλδάρια*. North of Ta-hia lay the Great Yue-chi,

and west of the latter was An-si towards the Oxus. This was a very great country, whose length might be 1000 li (258 miles), and it had 100 cities great and small. The first caravan from China to An-si passed on its way from the east frontier to the capital (called in the 1st century B.C. Fan-tou, i.e., probably Parthau), a dozen walled cities, which lay most close together, so dense was then the population of the fertile part of Chorasan. The merchants of An-si visited the neighbouring lands with waggons or with ships for distances of several thousand li. The coinage was silver, with the image of the king, and was called in and restamped on a new accession.<sup>5</sup> Writing was on skins in horizontal lines. Now, though the money as here described fits Parthia, the mercantile character of the race does not at all correspond to that of the Parthian aristocracy. Both here and in the general description given above, which also contains features not applicable to the Parthians, we see that the Chinese did not distinguish the ruling race from their subjects, and mainly described the latter, who were in point of fact very similar to the people of Bactria and Ferghana. As An-si extends to the Oxus the description is taken from the inhabitants of Margiana, a country which must have been then subject to Parthia. A later Chinese account, referring to the period 24-220 A.D., places on the east frontier the city Mo-lu or Little An-si, which is plainly the Mouru of the *Vendidad*, modern Morv-rud, and the Greek Antioch ἄντιόχος; An-si is a corruption of the last name, just as the Persians call the Syrian Antioch Andiv, and so came to be a name for the Parthian rulers of the city. West of An-si, on the western (Caspian) sea, lay Tiao-chi (Media), an agricultural country with a dense population, a dependency of An-si, and in part governed by tributary chiefs. Chang-kien is thinking less of the central parts of Media than of Gilan and Mazandaran, for he speaks of the warm moist climate where rice is produced. And in this quarter there were really various petty states; not only Atropatene but Dilem had its own king, as appears for the year 65 B.C. from Plutarch, *Pomp.*, 36 (where for *Ἐπιφάνης* read *Δελαφάνης*), and the Gelse and Cadusians doubtless stood under their own mountain chiefs as they had done under the later Achemenians, and did again under the first Sassanians. It is a proof of the solid power of the empire founded by Mithradates that Parthia was able to assert some kind of supremacy over these hardly accessible districts. North of An-si lay Li-kan (Hyrcania), whose wizards, with those of Tiao-chi, had great reputation. It is clear from this whole account that the centre of the empire was still in the old Parthian lands, and that the lower satrapies were viewed as mere dependencies, "outer lands." In the following century the Chinese obtained knowledge of the west by the caravan-route which passed through Kipin (the Cabul valley) to U-ghe-shan-li (Arachosia); and now we find a changed state of affairs; these two countries are bounded on the west by Tiao-chi, whose powerful king has his capital a hundred days' journey from the frontier. An-si is now only mentioned incidentally as reached from Arachosia by going first north and then east, which is correct if we take the name in its original sense of the subjects of Parthia in Margiana and its capital Antioch. But the empire of Parthia, which now had its centre in Media and the western lands, is certainly Tiao-chi, a word that is probably connected with the word for "land" in the official language of the Achemenians, old Persian *dāhyāus*.

As nomadic peoples Chang-kien names the Great Yue-chi in Sogdiana, the Khang-kiu on the middle course of the Jaxartes, and the Yen-tai in Chorasmia. The Yue-chi could put from 100,000 to 200,000 bowmen in the field; later they were reckoned at 100,000 warriors and their families. The royal camp had been north of the Oxus even after the conquest of Bactria, but they finally withdrew entirely to this district. Their capital is called Lan-shi; and the name of Ta-hia disappeared before that of "Land of the Great Yue-chi." At the conquest they had a single king; afterwards they formed five principalities. The fifth of these corresponds to Cabul, so that the division is younger than the Scythian invasion of Asia after the death of Phraates II. Immediately north of Ferghana, but separated from the Yue-chi in the south and the Hiung-nu in the east by a series of small kingdoms, were the pasture-grounds of the Khang-kiu on both sides of the Jaxartes; their force was 80,000 to 90,000 bowmen. North-west of these were the Yen-tai on the Aral, the northern neighbours of the An-si, and east of Hyrcania, that is, in Chorasmia. If there is no error in the writing of the number they mustered but 10,000 warriors; then again considerable changes had taken place when the Chinese made war on the Khang-kiu in 44 B.C. The small kingdoms south and east of the latter have disappeared, so that the Khang-kiu border on the Hiung-nu and the great Yue-chi; but the latter have now moved south, and now, too, the Khang-kiu are the northern neighbours of An-si, and not the Yen-tai; the latter are their dependants, and a tribute of mouse-skins is even drawn from the kingdom of Yen beyond the Yen-tai. Such a tribute cannot have come from any place south of the Mukhajar moun-

<sup>1</sup> The Lombards had the same custom, learned, no doubt, in the childhood of the race from their Avarian neighbours.

<sup>2</sup> See Langlois, *Coll. d. Mss. de l'Arménie*, 1. 84.

<sup>3</sup> *Seamantien*, in Ritter, vii. 3, p. 642.

<sup>4</sup> Certainly not Daba, for they were never in Bactria.

<sup>5</sup> On this point the younger Chinese account falls into a confusion with the coins of the kings of Kipin.

tains. The Khang-kin have risen in number as the Yue-chi fall, and have now 120,000 bowmen, or a population of 600,000 souls. Like the Yue-chi, they are divided into principalities, which are five in number, and the king is the prince of Su-hia, with his winter residence in a place of that name east of Ferghana, and his summer court much farther west at Lo-yuei-ni. The east of the Khang-kin country was often subject to the Hiung-nu, and the pressure of this Turkic tribe seems to have been the cause which pushed the Khang-kin and Yen-tsai farther west. The latter have now at least 100,000 bowmen, and extend westwards to the limits of Great Tain or the Roman empire. This compels us to conclude that the Yen-tsai are the Aorsi, the western part of whom ranged between the lower Don and the west coast of the Caspian, while the older upper Aorsi were round the north coast, and so on to the neighbourhood of the lower Jaxartes (Strabo, xi. p. 506; Ptol., vi. 14, 10). When Pharnaces ruled on the Bosphorus (63-47 B.C.) both parts of the Aorsi intervened in the affairs of the neighbouring kingdom with large armies, and as Pharnaces was a client of Rome the Chinese statement is intelligible. Later Chinese accounts relating to the first Christian century give A-lan-na as the later name of the Yen-tsai, which agrees with the fact that the Aorsi appear last in history in 49 A.D. (Tac., *Ann.*, xii. 15 sq.), and that Lucan, ten or fifteen years later, is the first to name the Alans, who succeeded to their geographical place. When we understand the Chinese data we can speak with more definiteness about the four nations to whom Strabo ascribes the fall of Greek Bactria, and which Ptolemy also seems to name from a source relating to the time when the invasion began. From these data, compared with our Chinese sources, we can be sure that the Tochari are the great Yue-chi, the former being probably the name of the nation and the latter that of the leading horde. The Asii of Strabo, Asiani of Trogus, Jattii of Ptolemy, will then be all attempts to render the difficult name of the horde which the Chinese call Yue-chi. But, while the classical writers place the Sacaruce in the west to balance the Tochari in the east, the Chinese know no second great nation between the latter and the Parthians in Margiana. We must therefore suppose that the Sacaruce are the Scythians who occupied part of the Greek lands, and were in turn conquered by Parthia according to Strabo (xi. 516); that this part was Margiana is known from a drachma of Phraates II. (Gardner, *Parthian Coins*, p. 33); and the conquest must have taken place a good while before 128, when Chang-kien visited Sogdiana, since by that time the Parthians had again displaced them. But he must have known and mentioned the Sacaruce in some form, and they can hardly be other than the most powerful nation known to him in Transoxiana, the Khang-kin. These, like the Sacaruce, came from beyond the Jaxartes; they were the northern neighbours of Parthia just at the time when the Sacaruce are so described. The only other tribe that can be thought of, the Yen-tsai, are known to the Greeks and Romans by a different name, as the Aorsi; and Trogus (*Prok.*, xlii.) mentions the fall of the Sacaruce as one of the latest events in Scythian history, which, as he wrote soon after 2 A.C., agrees with the fact that the last mention of the Khang-kin in Chinese history is in 11 A.C.; while the Aorsi are mentioned much later. Khang-kin seems to be properly the name of a country identical with the Katgha of the *Khorasana-Assets* and the Gangdiz of Pirdans. Finally, the Pasice or Pasiani are the same as the Apasiace of the earlier Parthian history; the Sacaruce will have conquered them and swept them with them as the Mongols did with many Tatar tribes. The conquest of Bactria probably followed soon after the last hopes of the Eastern Greeks in Demetrius II. came to nothing. It is very remarkable that Chang-kien notices no difference between the Greeks who had been rulers and the Iranians who were their subjects. This implies not merely some lapse of time but a marked decrease in the number of the Greeks, and probably also that here, as in other Eastern parts, they had become more and more completely Orientalized.

Phraates II.,<sup>1</sup> who succeeded his father in 138, and continued his work, wresting Margiana from the Scythians of Bactria in an expedition commemorated on extant coins, had also to meet the last and most formidable attempt to restore the sovereignty of the Seleucida. Antiochus VII., one of the ablest kings of his race, had put down the civil wars in Syria, even taking Jerusalem and compelling the Jews to acknowledge his might by paying him military service, and in 130 he marched eastward at the head of a force of 80,000 combatants, swollen by camp-followers to a total of 300,000. Many of the small princes, on whom the hand of Parthia lay heavy, joined him as they had joined his brother; the enemy was smitten on the Great Zab, and in two other battles; Babylon and then Ecbatana

opened their gates to the conqueror; and the subject-nations rose against the Parthians, who, when Antiochus took up his winter quarters in Media, were again confined to their ancient limits. When the snows began to melt, an embassy from Phraates appeared to ask for peace; but the terms demanded by Antiochus—the liberation of Demetrius, the surrender of all conquests, and the payment of tribute for the old Parthian country—were such as could not be accepted without another appeal to the fortunes of war. Demetrius, indeed, was released and sent to Syria, but only to stir up a hostile party in his brother's rear. During the winter the Syrian host had been dispersed over a wide range of cantonments; the disorderly insolence of the soldiers, for which the general Athenæus was held to be mainly responsible, and of the levies raised in the towns had disgusted the natives; the Medes made secret terms with Paughia, and all the cantonments were attacked by concert on a single day. Hastening to relieve the nearest corps, Antiochus was met by the Parthian with a superior force of 120,000 men; he refused the advice of his officers to fall back to the neighbouring mountains, and accepted battle on a field too narrow for the evolution of his troops. The Syrian soldiers, enervated by luxury, were readier to imitate the flight of Athenæus than the valour of his master; the whole host was involved in the rout and annihilated. Antiochus himself escaped wounded from the fray and cast himself from a rock that he might not be taken alive. This catastrophe (February 129<sup>2</sup>) freed the Parthians for ever from danger from Syria.

Phraates paid funeral honours to the fallen king, and afterwards sent his body to Syria in a silver coffin. He entertained his captive family royally, married one of the two daughters, and sent the eldest son Seleucus to Syria to claim the sovereignty, and so serve future plans of his own; for an attempt to follow and recapture Demetrius, made immediately after the battle, had proved too late. But dangers in the east soon turned the Parthian's attention away from enterprises in the west. In his distress he had bribed the Scythians<sup>3</sup> to send him help; as they arrived too late he refused to pay them, and they in turn began to ravage the Parthian country. Phraates marched against them, leaving his charge at home to his favourite, the Hyrcanian Euhemerus, who chastised the countries that had sided with Antiochus, made war with Mesene, and treated Babylon and Seleucia with the utmost cruelty. But the Scythian war proved a disastrous one; the enemy overran the whole empire, and for the first time for five hundred years Scythian plunderers again appeared in Mesopotamia<sup>4</sup>; in a decisive battle Phraates was deserted by the old soldiers of Antiochus, whom he had forced into his service and then treated with insolent cruelty; the Parthian host sustained a ruinous defeat, and the king himself was slain (spring 128, or somewhat later).<sup>5</sup>

Artabanus I.<sup>6</sup> (third son of Phriapatius), who now became king, was an elderly man. The Scythians, according to the too favourable account by our chief authority, were content with their victory, and moved homewards, ravaging the country. But we know from John of Antioch (66, 2) that the successor of Phraates paid them tribute; and the southern part of Drangiana must now have been per-

<sup>1</sup> The date is fixed by Livy, who, according to Orosius, v. 10, and Obsequ., *De Prodig.*, 28, places the expedition in the consular year 130. With this it agrees that Antiochus came to the throne in 138 and reigned nine years. Too much weight is often attached to Porphyry's dates by Olympiads, which are merely calculated from the years of reigns.

<sup>2</sup> Justin, xlii. 2, 1-2, plainly distinguishes these Scythians from the Tochari, so the Sacaruce must be meant.

<sup>3</sup> Jo. Ant., in Müller, iv. 561.

<sup>4</sup> The remains of Antiochus reached Syria in the reign of Alexander II., who came to the throne in 128 (Justin, xxxix. 1, 6).

<sup>5</sup> Arsaces Theopator Nicator of the coins.

<sup>1</sup> In coins Arsaces Theopator Euergetes Epiphanes Philhellen.

manently occupied by the Scythian tribes, who gave it the name of Sacastane (Sistan), for that name appears in Isidore of Charax (1 B.C.), which implies that the Scythian occupation was even then of long standing. Finally, the coins reveal the existence of Arsacids who were rival kings to Artabanus I. and Mithradates II., and perhaps borrow from individual successes against the Scythians the proud titles which so strongly contrast with the really wretched condition of the empire. One of these pretenders, Arsaces Energetes Dicaeos Philhellen, resumes the style "king of kings," which had lapsed since Mithradates I.; and his title "the just," which seems to be imitated from the Bactrian Heliocles, suggests that he may have come with the Scythians from the land where Heliocles once reigned. Meanwhile it would appear that the men of Seleucia, driven to desperation, had seized the tyrant Euhemerus and put him to a cruel death.<sup>1</sup> Artabanus, when they sought his pardon, threatened to put out the eyes of every man of Seleucia, and was prevented only by his death, in battle with the Tochari, after a very short reign.

His son and successor, Mithradates II. the Great,<sup>2</sup> was the restorer of the empire.<sup>3</sup> We are briefly told that he valiantly waged many wars with his neighbours, added many nations to the empire, and had several successes against the Scythians, so avenging the disgrace of his predecessors. His successes, however, must have been practically limited to the recovery of lost ground, and the eastern frontier was not advanced. It has been common to connect with his successes the appearance of Parthian names among the Indo-Scythian princes of the Cabul valley; but this must be false, for even Candahar (U-ghe-shan-li), which lies so much farther west, is represented by the Chinese as an independent kingdom in the middle of the 1st century B.C. On the other hand, Mithradates, if not the first to conquer Mesopotamia, was the first to fix the Euphrates as the western boundary of the empire, and towards the end of his reign he was strong enough to interfere with the concerns of Great Armenia and place Tigranes II. on the throne in a time of disputed succession (94), accepting in return the cession of seventy Armenian valleys. Now, too, the Parthians, as lords of Mesopotamia, came for the first time into contact with Rome, and in 92, when Sulla came to Cappadocia as propator of Cilicia, he met on the Euphrates the ambassador of Mithradates seeking the Roman alliance.<sup>4</sup> This embassy was no doubt connected with the Parthian schemes against Syria; Mithradates about this time was at war with Laodice, queen of Commagene or some neighbouring part; and her cousin, Antiochus X.,<sup>5</sup> who supported her, fell in battle with the Parthians. A few years later Strato, tyrant of Beroea, called in the Arab phylarch Arisus and the Parthian governor of Mesopotamia, Mithradates Sinaces, against Demetrius III., who reigned at Damascus. The Seleucid was compelled to surrender with his whole army and ended his life as a captive at the Parthian court. Mithradates the Great seems to have died just after this event; there is no reason to suppose that he lived to see the disasters which followed so close on his great successes.

<sup>1</sup> In Diod., *Exc. Vat.*, p. 107, there can be little doubt that ἐβλῶν is a corruption of Εὐμητέρου.

<sup>2</sup> On coins Arsaces Theos Energetes Epiphanes Philhellen.

<sup>3</sup> The time of his accession follows approximately from the date 123 on a coin of his rival, Arsaces Nisephorus.

<sup>4</sup> The ambassador allowed Sulla to take the place of honour, and on his return was punished for this by death.

<sup>5</sup> The queen Ἰνδὸν βασιλευσῶν of Jos., *Ant.*, xiii. 13, 4 (Layden MS.—the usual text has "queen of Gilead"), is doubtless the Laodice Thea Philadelphos, daughter of Antiochus VIII. of Syria, who, as Mommsen has shown (*Mithr. Arab. Inst. Athen.*, l. 82), was ancestress of the later sovereigns of Commagene. The word in Josephus is not perhaps a corruption of Commagene but of some neighbouring place—say Καλλιπυργῶν.

Artabanus II. was the next monarch,<sup>6</sup> but after him the style of king of kings was taken by the Armenian Tigranes, one of the most dangerous foes Parthia ever had. In 86 it was still a reason for choosing Tigranes as king of part of Syria that he was in alliance with Parthia (Just., xl. 1, 3), but very soon the latter state was so ruined by civil and foreign war that it was no match for Armenia (Plut., *Lucullus*, 36). Of the details in this history we know only the last act. In 77 the Arsacid Sinatruces<sup>7</sup> returned from the land of the Sacarance to take the throne at the age of eighty, and reigned seven years. There were probably other usurpers; the silence of the coins does not prove the contrary, but rather that the times were so bad that no money was struck, a case of which Parthian numismatics offer other examples. Tigranes conquered Media—primarily, that is, Atropatene—but he also entered Great Media and destroyed the city of Adrapanan, 7 miles west of Ecbatana, "the castle of those who have their seat in Batana" (Ecbatana),<sup>8</sup> i.e., of a line of the Arsacids, for, though Mithradates I. had had his seat in Hyrcania, Phraates II. and his successors down to Mithradates III. held their court in Media (Diod., *Exc. Vat.*, p. 603). The seventy valleys which had been the price of his throne were restored to Tigranes, and he also ravaged the country of Arbela and Nineveh, and compelled the cession of Adiabene, hitherto a Parthian dependency, and of Mesopotamia, with the fortress of Nisibis. This last war was against Sinatruces,<sup>9</sup> and was probably going on in 73 when Mithradates Eupator of Pontus made a vain appeal for help to both combatants (Memnon, in Photius, p. 234 b, 27).

Phraates III. succeeded his father Sinatruces a little before the arrival of Lucullus in the East in 70,<sup>10</sup> and in 69 refused a second invitation to give help against Rome which Mithradates and Tigranes addressed to him jointly, the latter offering to reward him by giving up all that he had taken from the Parthians. His hatred of Tigranes made him more disposed to alliance with Rome; and after a period of hesitating neutrality Phraates accepted the overtures of Pompey and prepared to invade Armenia (66), guided by the younger Tigranes, who had quarrelled with his father and taken refuge in Parthia, where he wedded the daughter of the king. Tigranes the elder fled to the mountains; and, after forming the siege of Artaxata, which proved tedious, Phraates turned homeward, leaving young Tigranes with part of the army to continue the war. The latter, who alone was no match for his father, fled after an utter defeat to Pompey, who was just preparing to invade Armenia, and to whom the elder Tigranes presently surrendered at discretion. The Roman, however, gave him very good terms, altogether abandoning his son's cause and even casting him into chains.

<sup>6</sup> In Trogu, *Procl.*, 41, the sentence "successores deinde eius Artabanus et Tigranes cognomine Deus a quo subacta est Media et Mesopotamia dictaque in excessu Arabis situs" is wrongly referred (after Vaillant) to Mithradates I. of Parthia. It can really refer only to the famous Tigranes, and in that case must have originally belonged to *Procl.*, 42, having dropped out by homototeleuton, and been restored from the margin in a false place. Artabanus II., therefore, followed Mithradates II., and his probably are the base coins of Arsaces Energetes Epiphanes Philhellen, which according to Gardner, p. 88, seem to belong to this time.

<sup>7</sup> On coins Arsaces Antocrotor Philopator Epiphanes Philhellen.

<sup>8</sup> Isid. Char., in *Geog. Gr. Min.*, l. 250.

<sup>9</sup> Ballist., *Hist.*, iv. fr. 19, § 3.

<sup>10</sup> So Memnon, in Photius, p. 239 a, 13, confirmed by Phlegon, *Stad.*, p. 84 a, 15. These sources, being independent, have more weight than Appian, *Mithr.*, 104, and Dio Cassius, xxxvi. 45, who speak of the arrival of Pompey. Phraates III. is the "king of kings, Arsaces Dicaeos Epiphanes Theos Eupator Philhellen," whose coins Gardner wrongly ascribes to Mithradates III. We have express testimony that Phraates was styled "king of kings" and had the epithet "Theos" (Plut., *Pomp.*, 38; Dio Cass., xxxvii. 6; Phlegon, *ut sup.*).

Meantime Phraates had occupied the Parthian conquests of Tigranes, which the Romans had promised him, and invaded Corduene (Beth-Kardo, now Jezirat bent 'Omar), whence he sent an embassy to Pompey to intercede for his son-in-law. But the Romans had no further occasion for Parthian help; and, instead of granting his request, Pompey commanded him to leave Corduene, and followed up the command by sending Afranius to clear the country and restore it to Tigranes. Immediately afterwards Pompey's officer marched into Syria through Mesopotamia, which by treaty had been expressly recognized as Parthian; and it was another grievous insult that Pompey in writing to Phraates had withheld from him the style of "king of kings." This no doubt was done out of regard to Tigranes, who claimed the sole right to the title, and had probably enforced his claim upon the weak predecessors of Phraates. Of the four subordinate kingships, the patronage of which was held to give a right to the title, Atropatene, Adiabene, Corduene are known, and the fourth was probably Orhoena. All these had once stood under Parthian suzerainty, and, now that Phraates had recovered the lost territory of his predecessors including these states, he resumed, as his coins show, the proud title which had dropped since the days of Mithradates I., and to which Tigranes had lost his real claim. Nevertheless Phraates at first contented himself with again sending a fruitless embassy to demand that Pompey would observe the treaty and acknowledge the Euphrates as the Parthian frontier, and it was only when Pompey had gone to Syria (64) that he again attacked and defeated Tigranes. Pompey declined to interfere by force and burden himself with a Parthian war while Mithradates of Pontus was still under arms, but, as both sides appealed to him, he sent umpires to settle the dispute (which probably turned on the possession of Corduene), and a peaceable solution was effected.<sup>1</sup> The Romans had done more than enough to irritate Parthia and not enough to inspire respect, but, as the Parthians were only beginning to recover from the inner and outer troubles of the last two decennia, they were not yet prepared to enter on a struggle with Rome.

For a century and a half up to the death of Mithradates the Great there had been an unusual degree of unity in the house of the Arsacids; but the corruptions to which every Eastern dynasty ultimately falls a prey appeared at length. About 57 Phraates, the restorer of the empire, was murdered by his two sons, one of whom, Orodes or Hyrodes I. (*Zend, Huroadka*), took the throne, while his brother Mithradates III. got Media;<sup>2</sup> but the latter ruled so cruelly that he was expelled by the Parthian nobles, and Orodes reigned alone. Mithradates, with a loyal follower, Orsanes, fled to Gabinus, proconsul of Syria, who had already crossed the Euphrates to restore him by force when he was summoned by Pompey to restore Ptolemy XI. to the throne of Egypt (55). Mithradates, dismissed by the Romans, now tried what he could do without help. Orodes had at first to flee, but soon regained his position, mainly through the help of Surenas, a young noble who had the hereditary right of crowning the king, and was the second person in the empire in point of wealth, nobility, and

influence, and the first in courage and political skill. Surenas took Selencia by storm; Babylon received Mithradates, but was reduced by famine; Mithradates then surrendered to his brother and was killed before his eyes. These events carry us far into the year 54.

Meantime Crassus, hoping for a rich and easy prey, had invaded Mesopotamia without a shadow of pretext, had defeated a small Parthian force at Ichna, and occupied a number of large towns, such as Nicephorium, Ichna, Carrhae, whose Greek inhabitants welcomed the Romans as liberators. As Mithradates was at this time in arms in Babylonia, we can understand why Crassus was blamed for a grave error of judgment in not marching direct from Nicephorium on Selencia and Babylon (*Plut., Crassus*, 17). Instead of this, he retired to winter-quarters in Syria, leaving 7000 foot and 1000 horse to garrison the Mesopotamian cities. Thus his hands were tied for the following campaign, and he could not accept the invitation of Artavasdes II. of Armenia to advance through his country and have his co-operation. A Parthian embassy appeared in Syria in spring to remonstrate against the faithlessness of Rome, but at the same time the Parthians were ready for war. Surenas, with Silaces, satrap of Mesopotamia, was pressing the Roman garrisons, and prepared to confront Crassus with an army wholly composed of cavalry, while Orodes in person invaded Armenia. In the spring of 53 Crassus crossed the Euphrates at Zeugma with seven legions and 8000 cavalry and light troops, making up a total of 42,000 or 43,000 men,<sup>3</sup> and was persuaded by Abgar of Orhoena to leave the river and march straight across the plains against Surenas. At midday, 6th May (9th June as the calendar then stood) the Romans had crossed the Balissus (Nahr Belik) and met Surenas half way between Carrhae and Ichna, or a little nearer the latter town. They were not, therefore, in the desert—as the older account represents—for it begins beyond the Chaboras.<sup>4</sup> Surenas kept the mass of his troops concealed by a wooded hill, showing only the not very numerous vanguard of cataphracts till the Romans were committed to do battle. The Roman cavalry under Publius Crassus, son of the proconsul, charged the enemy to prevent a threatening flank movement, and were drawn away from the mass of the army by the favourite Parthian manoeuvre of a simulated flight, and then surrounded and cut to pieces. The mass of the Roman host lost courage at this disaster, and already had suffered terrible loss from the light-armed hordes of Parthian serfs who hovered round the enemy at a safe distance and galled it with arrows shot with deadly precision. The legionaries serried their ranks and covered themselves with their shields; but in this close order they were easily broken by the charge of the Parthian freemen with their long heavy lances and almost impenetrable suits of complete armour. The heat, too, thirst, and dust oppressed the Romans, and this first day would have decided their fate but that the Parthians withdrew before evening, true to their rule of encamping

<sup>1</sup> Dio, using in xxxvii. 6 a different source from that which lay before him at xxxvi. 51, has not observed that the former recapitulates the whole story from the beginning, including the rebellion and defeat of the younger Tigranes as related above.

<sup>2</sup> This is Dio's account, and, though other writers dissent, it is justified by the coins. The coins of Arsaces Philopator (or Theopator) Euergetes Epiphanes Philhellen belong to Mithradates,—not, as Gardner thinks, to his father, for Theopator denotes a king whose father was Arsaces Theos, and these coins call him only "great king," while Orodes (Arsaces Philopator—or Euergetes—Dicaeos Epiphanes Philhellen) is called "king of kings." Both princes, it will be observed, ultimately give up the title of Philopator, which marks them as colleagues or recognized heirs of their father,—an indirect confirmation of their guilt as parricides.

<sup>3</sup> Florus says eleven legions and Appian 100,000 men; but Appian has made the mistake of adding to the legion its auxiliaries and counting the whole at the higher footing adopted under the empire. Seven such legions with the 8000 cavalry and light troops, and the 8000 men in garrison, make up his total. For the campaign of Crassus we have two independent narratives preserved in Plutarch and Dio; Plutarch's is the older account, full of colour and valuable detail, but lacking in topographical precision; in this respect Dio's source is much to be preferred, but it has suffered from that author's somewhat arbitrary way of meddling with his materials. The accounts based on Livy (*Perioche lib.* 106; Florus, *lib.* 11; Festus Rufus, *Brev.*, 17, and Orosius, *vi.* 13) agree in all essential points with Plutarch, who, however, draws not from Livy but from some Greek writer, perhaps Nicolaus of Damascus.

<sup>4</sup> Plutarch himself speaks of marshes (*cap.* 25); the only modern account that agrees with the facts is that of G. Rawlinson, *p.* 168 *et.*

at a distance from the foe. Crassus retired at night, leaving all who were badly wounded behind him, and reached Carrhæ safely; but his army was sadly demoralized, and he himself lost his head, and, though fairly secure at Carrhæ, thought only of immediate retreat to Syria.<sup>1</sup> He marched by night northwards towards the mountains; the several divisions lost one another and each sought only to shift for itself. The quaestor Cassius, one of Crassus's best officers, returned to Carrhæ and thence regained Syria in safety. Crassus himself, after getting dangerously entangled in marshy ground, had almost reached the mountains when he was induced, by the despair of his troops rather than by error of his own judgment, to yield to treacherous proposals of Surenas and descend again into the plain. As he mounted the horse which was to convey him to a meeting with the enemy's general the gestures of the Parthians excited suspicions of treachery, a struggle ensued, and Crassus was struck down and slain. Scarcely 10,000 men out of the whole host reached Syria by way of Armenia (Appian, *B. C.*, ii. 18); 20,000 had fallen and 10,000 captives were settled in Antioch, the capital of Margiana. The token of victory, the hand and head of Crassus, reached Orodes in Armenia just as he had made peace with Artavasdes and betrothed his eldest son Pacorus to the daughter of the Armenian king. The Roman disaster was due primarily to the novelty of the Parthian way of assault, which took them wholly by surprise, and partly also to bad generalship; but the Romans always sought a traitor to account for a defeat, and in the present case threw the blame partly on Andromachus of Carrhæ, who really did mislead Crassus in his retreat, and was rewarded by the Parthians with the tyranny of his native town (Nic. Dam., in Athen., vi. p. 252 D),<sup>2</sup> but had no great influence on the disaster, and partly on Abgar, whose advice was no doubt bad, but not necessarily treacherous,<sup>3</sup> while the silence of the older account disposes of Dio's improbable assertion that the men of Orrhoena fell on the rear of the Romans. That the Parthians did not count Abgar their friend and punished him with deposition may be fairly inferred from the list<sup>4</sup> of kings of Edessa given by Dionysius of Telmahar, which shows that the reign of Abgar II. ended in 53, and was followed by a year of interregnum.

Surenas, the victor of Carrhæ, whose fame was now too great for the condition of a mere subject, was put to death a little later, the victim of Orodes's jealousy; the victory itself was weakly followed up. Not till 52 was Syria invaded, and then with forces so weak that Cassius found the defence easy. In July 51 (Sextilis, according to the old calendar) the attack was renewed with greater forces; the Romans were still weak in troops, their harshness and injustice had alienated the provincials, and some districts—as Judæa—openly sympathized with the foe. Thus all the chances were still favourable to the Parthians, who indeed overran the open country, but were too unskilled in siege to take Antioch. As they drew off, Cassius stopped their way at Antigonina and inflicted on them a defeat in which Osaces, the real leader of their host under the young prince Pacorus, was mortally wounded (August 51). Pacorus wintered in Cyrrhestica, the Romans under the new proconsul Bibulus not venturing beyond the walls of Antioch;

but, the satrap of Mesopotamia<sup>5</sup> having raised a revolt against Orodes in the name of Pacorus, the latter was recalled by his father and Syria was entirely evacuated by May 50.

Orodes avoided the threatened breach with his son by associating Pacorus in the empire;<sup>6</sup> but the Parthians took little advantage of the civil wars that preceded the fall of the Roman republic. They occasionally stepped in to save the weaker party from utter annihilation, but even this policy was not followed with energy, and Orodes refused to help Pompey in his distress because the Roman would not promise to give him Syria. The Pompeian Cæcilius Bassus was saved from Cæsar's general Antistius Vetus by the sudden appearance of a Parthian force under Pacorus, which, however, retired when winter came on (December 45). In 43, again, Cassius had a force of mounted Parthian bowmen with him in Syria, but dismissed them when he marched to join Brutus and face the triumvirs. Labienus was with Orodes negotiating for help on a larger scale when the news of Philippi arrived, and remained with him till 40, when he was at last sent back to Syria, together with Pacorus and a numerous host. The Roman garrisons in Syria were old troops of Brutus and Cassius, who had been taken over by Antony; those in the region of Apamea joined Labienus; Antony's legate Decidius Saxa was defeated, and fled from the camp afraid of his own men. Apamea, Antioch, and all Syria soon fell into the hands of the Parthians, and Decidius was pursued and slain. Pacorus advanced along the great coast road and received the submission of all the Phœnician cities save Tyre. Simultaneously the satrap Barzaphranes appeared in Galilee; the patriots all over Palestine rose against Phasaël and Herod (see ISRAELI, vol. xiii. p. 425); and five hundred Parthian horse appearing before Jerusalem were enough to overthrow the Roman party and substitute Antigonus for Hyrcanus. The Parthian administration was a favourable contrast to the rule of the oppressive proconsuls, and the justice and clemency of Pacorus won the hearts of the Syrians. Meantime Labienus had penetrated Asia Minor as far as Lydia and Ionia; the Roman governor Plancus could only hold the islands; most of the cities opened their gates to Labienus, the "Parthian Emperor," Stratoniceæ alone resisting and successfully standing a siege. But Rome even in its time of civil divisions was stronger than Parthia; in 39 Ventidius Bassus, general for Antony, suddenly appeared in Asia and drove Labienus and his provincial levies before him without a battle as far as the Taurus. Here the Parthians came to Labienus's help, but, attacking rashly and without his co-operation, they were defeated by Ventidius, and Labienus's troops were involved in the disaster. Labienus himself escaped to Cilicia, but was captured and executed by the Egyptian governor of Cyprus. In the passes of the Amanus the Romans were again in danger, but Ventidius at length gained a decisive victory at Trapazon, north of the Orontes valley, where Phranipates, the ablest lieutenant of Pacorus, fell; and the Parthians evacuated Syria. Before Ventidius had completed the resettlement of the Roman power in Syria and Palestine, and while his troops were dispersed in winter-quarters, the Parthians fell on him again with a force of more than 20,000 men and an unusually large proportion of free cavaliers in full armour. Ventidius, however, gained time to bring up legions from Cappadocia by deceiving a dynast of Cyrrhestica, who was Pacorus's spy. Then a battle was fought near the shrine of Hercules at Gindarus in Cyrrhestica, on the anniversary, it is said, of the defeat of Crassus (9th June 38), and the Parthians were

<sup>1</sup> That he waited for the new moon—i.e., some twenty days, as Dio says—seems to be a mistake. Perhaps it is due to Dio himself; at all events, the older account is preferable.

<sup>2</sup> The Parthians leaned much on the despots of the Greek cities. Zenodotia, the only Mesopotamian town that Crassus had to storm, had a despot, Apollonius.

<sup>3</sup> The alternative of a march along the Euphrates was also open to serious military objections.

<sup>4</sup> It must be remembered that a correction of four years has to be applied to all the dates in this list.

<sup>5</sup> The name was Orondapates, corrupted to 'Orobdardary in Dio, xl. 30.

<sup>6</sup> So the coins show, Gardner, p. 41.

utterly routed and Pacorus himself slain. His head was sent round to the cities of Syria which were still in revolt to prove to them that their hopes had failed. There was no further resistance save from Aradus and Jerusalem.

Orodes, now an old man and sorely afflicted by the death of his favourite son, nominated his next son, Phraates, as his colleague, and the latter began his reign by making away with brothers of whom he was jealous as the sons of a princely mother, daughter of Antiochus of Commagene, and then strangling his father, who had not concealed his anger at the crime (37). The reign of Orodes was the culminating point of Parthian greatness, and all his successors adopted his title of "king of kings, Arsaces Energetes" (taken from Phraates II.) "Dicaeus" (first borne by the pretendant spoken of at p. 595, who was perhaps father of Sinatruces, and so ancestor of the succeeding princes) "Epiphanes" (like Mithradates I.) "Philhellen" (like Phriapatius). It was he who moved the capital westward to Seleucia, or rather to Ctesiphon (Taisefun), its eastern suburb.<sup>2</sup>

Phraates IV. continued his reign in a series of crimes, murdering every prominent man among his brothers, and even his own adult son, that the nobles might find no Arsacid to lead their discontent. Many of the nobles fled to foreign parts, and Antony felt encouraged to plan a war of vengeance against Parthia.<sup>3</sup> Antony had no hope of forcing the well-guarded Euphrates frontier, but since the death of Pacorus Armenia had again been brought under Roman patronage, and he hoped to strike a blow at the heart of Parthia through Atropatene. Keeping the Parthians in play by feigned proposals of peace while he matured his preparations, he appeared in Atropatene in 36 with 80,000 legionaries and 40,000 cavalry and auxiliary troops, and at once formed the siege of the capital Phraaspa (Takht-i-Suleimán). The Median king Artavasdes, son of Ariobarzanes,<sup>4</sup> had marched to join Phraates, who looked for the attack in another quarter. Phraates had only 40,000 Parthians, including but 400 freemen who never left the king, and probably 10,000 Median cavalry;<sup>5</sup> but these forces were well handled, and the two kings had reached the scene of war before Antony was joined by his baggage and heavy siege-train, and opened the campaign by capturing the train and cutting to pieces its escort of 7500 men under the legate Oppius Stavianus. Antony was still able to repel a demonstration to relieve Phraaspa, but his provisions ran short, and the foraging parties were so harassed that the siege made no progress; and, as it was now October, he was at length forced to open negotiations with Phraates. The Parthian promised peace if the Romans withdrew, but, when Antony took him at his word, abandoning the siege-engines, he began a vigorous pursuit, and kept the Romans constantly on the defensive, chastising one officer who hazarded an engagement by a defeat which cost the Romans 3000 killed and 5000 wounded. Still

greater were the losses by famine and thirst and dysentery; and the whole force was utterly demoralized and had lost a fourth part of its fighting men, a third of the camp-followers, and all the baggage when, after a retreat of twenty-seven days from Phraaspa to the Araxes by way of Mianeh (276 miles), they reached the Armenian frontier. Eight thousand more perished of cold and from snow-storms in the Armenian mountains; the mortality among the wounded was terrible; the Romans would have been undone had not Artavasdes of Armenia allowed them to winter in his land. The failure of the expedition was due partly to the usual Roman ignorance of the geographical and climatic conditions, partly to a rash haste in the earlier operations, but very largely also (as in the case of Napoleon's Russian campaign) to the lack of discipline in the soldiers of the Civil War, which called for very stern chastisement even during the siege of Phraaspa, and culminated at length in frequent desertions and in open mutiny, driving Antony to think of suicide. The Romans laid the whole blame on Artavasdes, but without any adequate reason. At the same time the disaster of Antony following that of Crassus seemed to show that within their own country the Parthians could not safely be attacked on any side, and for a century and a half Roman cupidity left them alone.

The Median Artavasdes, whose little country had borne the whole brunt of the war, fell out with the Parthians about the division of booty, and made overtures to Antony for alliance with Rome; and in 33, when the Romans had treacherously seized the person of the Armenian Artavasdes and occupied his land, a treaty was actually concluded by which Symbace, which had once been Median, was again detached from Armenia, and Roman troops were sent to co-operate with the Median king in repelling the efforts of the Parthians to reseat on the throne of his fathers Artaxes, son of the deposed king of Armenia. These troops, however, were recalled before the battle of Actium, and then Media and Armenia fell before the Parthians; the Romans who were still in the country were slain, and Artaxes II. was raised to the Armenian throne (30). In the very next year, however, the course of Parthian affairs led Artaxes to make his peace with Rome.<sup>6</sup>

Phraates's tyranny had only been aggravated by his successes, and open rebellion broke out in 33. We have coins of an anonymous pretender dating March to June 32.<sup>7</sup> To him succeeded Tiridates II., whose rebellion was at a climax during the war of Actium. Towards the end of 30 Tiridates succumbed and fled to Syria, where Octavian, who was wintering in the province, allowed him to remain. A fresh attempt made from this side, with the help perhaps of the Arabs of the desert, and by crossing the Euphrates at the island now called Koba, had better success. The order of events here given is that deduced by Vaillant and Longuerue, combining the Roman history of Dio with the Parthian of Troguus,—Lachmann, who makes Tiridates be expelled only once and supposes a mistake on the part of Troguus as to place and date of his meeting with Augustus, assigning 1st March 29 as the date of Horace, *Carm.*, iii. 8; but the chronological difficulties of this view are insuperable. Phraates was taken by surprise and fled, slaying his concubines that they might not fall a prey to his victor (*Isid. Char.*, 1). Tiridates seated himself on the throne in June 27,<sup>8</sup> and Phraates wandered for some time in exile till he persuaded the Scythians to undertake his cause.

<sup>2</sup> See coins in Bekhal, vi. 82, compared with Dio, ii. 16, and the reference in Horace, *Carm.*, ii. 9, 20-22.

<sup>3</sup> Ascribed to Tiridates II. by Gardner, p. 44 sq.

<sup>4</sup> *Deustus*, 285 Sal. In this month there are coins of Phraates and also of an Arsaces Energetes Autocrator Epiphanes Philhellen, who must be Tiridates II.

<sup>1</sup> Orodes indeed knew Greek and cared for Greek literature. The *Bacchæ* was performed at his son's betrothal.

<sup>2</sup> Ctesiphon was capital at the time of Crassus's invasion, and Ammianus (xviii. 6, 23) calls Pacorus the second founder of the city, the first Vardanes being perhaps a mythical person. A coin of Orodes with the title *αρχηγος* (Gardner, 39) may refer to this.

<sup>3</sup> Of this war we have three accounts, all based on one source, probably a monograph by Dellius. The best is Plutarch's (*Ant.*, 37 sq., favourable to Antony). The later minor historians (who draw from Livy) and Dio (xlix. 28 sq.) are hostile to Antony (Octavianist); but the former, while sharing Dio's general point of view, approach Plutarch in many points of detail. Plutarch drew from the original source, indirectly perhaps through Nis. Dem.; Dio used Livy, but not exclusively. The point in the story where the mutual relations of the several narratives come out most clearly is in what is said of the adviser who saved the Romans from utter destruction.

<sup>4</sup> *Mos. Anacr.*, col. vi. l. 12.

<sup>5</sup> *Plut.*, *Ant.*, 44; Justin, xli. 2, 6. The number 10,000 is given by Apollonides in Strabo, xi. p. 528.



To understand who his helpers were we must take up again the thread of the history of the far Eastern lands. It was now a century since the Tibetan races who had supplanted the Greeks to the north of the Hindu Kush had first exercised a decisive influence on western affairs, and during most of that time there had been little change in the boundaries of empire in eastern Iran. Since the time of Eucratides the centre of Greek influence had lain more to the south of the Hindu Kush and in India proper, and this was perhaps one reason why Sogdiana and Bactria were lost so early; since that loss Greek power and culture had their chief and most lasting seat in the Cabul valley, where colonies of Alexander were particularly numerous.

The places where coins have been found—and these are almost our only source of knowledge—prove that on the death of Eucratides the Indian country fell to Apollodotus and Bactria to Heliocles. Each of these held for a time the greater part of east Iran, but Apollodotus was the last Greek king who ruled over Kandahar and Sistan. For a time there were also separate kingdoms in the Cabul valley under Antialcidas, and in the district of Peshawar under Lysias, but after a period of civil war they were all merged in one great Greco-Indian realm extending from Cabul to the Sutlej, and at times as far south as Barygaza; the capital was Çakala (officially called Euthydemia). Eight Yavana kings, says the *Vāyu-Purāna*, reigned eighty-two years, and just eight names<sup>2</sup> are found on coins whose distribution justifies us in attributing them to kings whose sway extended over the whole Greek realm. This confirms the historical value of the Indian source, and the eighty-two years will have to be reckoned from the time when Demetrius was driven out of Bactria and fixed his residence in the Punjab (c. 175), so that the end of the kingdom will fall about 98. Menander, the most important of the eight (c. 125-c. 95 B.C.),<sup>3</sup> carried his arms farther than any of his predecessors, crossed the Hyphasis, and pushed as far as the "Isamua," a locality which must be sought much farther east than used to be supposed, since his coins are common as far as Mathurā (Muttarā) and Rampur, and Indian sources<sup>4</sup> tell us that the Greeks subdued Ayódhyā, the land of the Panchāla, and Mathurā, and even took the old capital, Pataliputra. The Greeks were too few to hold these exorbitant conquests without much concession to native habits and prejudices, and we learn without very great surprise from a Buddhist book that Menander became a Buddhist. The same source<sup>5</sup> tells us that Menander was born at Alaxanda (Alexandria ad Caucasum) or at the (neighbouring!) village of Kalasā. Buddhism was strong in this quarter at an early date, and a Buddhist stupa appears as type on a coin of Agathocles, who reigned in Arachosia and Drangiana about 180-165 (Sallet, *op. cit.*, p. 95). A Greek source praises Menander's just rule; the *Milinda-prasna* says, "In the whole of Jambudipa there was no one comparable to Milinda Rājā . . . he was endowed with riches . . . and guarded by military power in a state of the utmost efficiency" (*Jour. As. Soc. Beng.*, v. 532). When he died in the camp he received every honour paid to a deceased "chakravartī," and his ashes were divided, as Buddha's had been, in cenotaphs erected in every town. Perhaps political mingled with pious motives; the struggle for the dust of Menander mentioned by a Greek writer may be compared with that among the "diadochi" for the bones of Alexander, and so will be one phase of the many and long divisions among the Indian Greeks testified to by the coins. In little less than a century we have the names of twenty-three kings all later than Eucratides, and nine of them apparently later than Menander. They appear to belong to four kingdoms, the upper and lower Cabul valley, Peshawar, and the Punjab, and as there are but two names common to more than one king we may conclude that the rapid changes were often violent, that these were not fixed dynasties, perhaps that the kings rose by military election. All this confirms the Indian source (in Kern, *ut supra*, p. 38), "the fiercely-fighting Greeks did not stay in Madhyadesa; there was a cruel dreadful war in their own kingdom between themselves."

All the time that the Greek kingdom lasted there was beside it another whose kings bear Scythian or Parthian names; their coins belong chiefly to the western Punjab, the outrunners of the Kashmir Himalayas, and west of the Indus, Bajāwar, and sometimes Bamian. The founder of this kingdom was Maues, a younger contemporary of Demetrius and Apollodotus, whose types are imitated on his coins. The coins confirm the Chinese notice that the Sæ, driven from their seats at Balkash and Issi-kul, founded a kingdom in Kipin (Cabul valley) about 161, with the correction that the kingdom did not at once extend so far west, the coins of Maues being found only in the Punjab. Now this is just the country (between the Indus and Hydaspes) which is said to have submitted

without a war to Mithradates I. of Parthia, and we must probably assume that it was the Sæ who put themselves under the Parthian empire, but that the arrangement was not a lasting one, the parties to it lying so far apart.

The kings of the Sæ do not seem to have been Parthians,<sup>6</sup> but the nation was one of the many Iranian nomad tribes that once roamed over the steppes north of Sogdiana, while their coins show that they were influenced by the culture of the Indian Greeks, from whom they copied the titles of "satrap" and "strategus." The kingdom lay north of the Greeks, roughly bounded by the Cabul river and a line continuing eastward in the same latitude, and it is one of the unsolved puzzles of this obscure history how such a strip of mountain-land ever became so prosperous and powerful as it did under the second king, Azes, and how it was able to resist the might of Menander. We know from the *Periplus* that on the lower Indus the Parthians who fixed themselves there in the first Christian century had been preceded by a Scythian kingdom of sufficient permanency to leave to the district the name of Scythia or Indo-Scythia. But that the Sæ were the founders of this remote kingdom is not so certain as is usually supposed; it is quite as possible that at the time when the Scythians overran Iran the founders of the Indo-Scythian kingdom advanced from Bactriana through the Bolan Pass. The Sæ certainly did not force themselves wedge-like between the Greek settlements, and the chronology of the coins precludes the easy solution that their power developed only after the fall of the Greeks. The coins name five supreme kings—Maues, Azes, Axilises, Onones, Spalirises; the dynasty began about 161; Azes, the second king, restruck coins of Apollodotus; and there is not the least reason to doubt that he directly followed him, and that the power of the Sæ under Azes fell in the time before Menander, when the Greeks were weak and divided. It was probably Menander who again drove the Scythians within narrower limits. The coins show further a lack of unity in the later days of the Scythian kingdom, and, taking this fact with the smallness of the total number of names, we cannot conclude that it lasted much later than the Greek realms.

Hermæus, the last of the Greek kings, held the lower valley of the Cabul river and Peshawar with the district around it and the belt of the Punjab opposite, and he reigned, as the effigies on his coins show, from youth to old age. These last days of Greek rule in the East fortunately receive light from the Chinese *Annals of the First Han*.<sup>7</sup> After the opening of trade with the West about 105 a.c. the Chinese also visited Kipin, but their agents in this remote realm were repeatedly plundered by the King U-to-lao (between 105 and 87). At length, under the son of the latter, the Chinese commander on the frontier joined In-mo-fu, son of the king of Yung-khiu, in a sudden attack on the king of Kipin, who was slain and In-mo-fu installed in his place. Difficulties arose between the new king and China, and when In-mo-fu ultimately tried to make his peace the emperor Hiao-yuan-ti had just resolved to break off all connexion with the distant western lands. As the Chinese kept no military guard of the western frontier till 59 a.c.,<sup>8</sup> and the new policy of Hiao-yuan-ti began soon after 49,<sup>9</sup> In-mo-fu must have begun to reign in Kipin some time between 59 and 51. In 82 he again, but still in vain, sent tribute and attempted to reopen the profitable commerce with China. The coins keep us so well informed of the names of rulers in this period that In-mo-fu must be capable of identification, and no ruler can be meant but Hermæus, who in the commonest dialect of Prakrit would be Hermaid, a word necessarily mutilated by Chinese inability to pronounce r. Yung-khiu is therefore Yonaki "the city of the Greeks." The dethroned king of Kipin and his father U-to-lao must, from what the Chinese records tell of the origin of their power, be kings of the Sæ; U-to-lao is probably Azō Réas, "king Azes."

We have Chinese records of the eastern lands of Iran in the time of open trade along the great south road from Phi-shan on the Chinese frontier over the Hanging Pass (beside Lake Yashil-Kul at the west end of the Alichur Fahir),<sup>10</sup> and so south-west to Hian-tu (the Indians), and then to the fruitful and temperate plain of Kipin. The king of Kipin, a mighty lord, resided at Sun-Sun (perhaps *Διονύσιον*, Dionysopolis or Nagara, now Jalalabad). The inhabitants were industrious and ingenious in carving, building, weaving, and embroidery, and in silk manufacture; vessels of gold and silver, utensils of copper and tin, were found in their bazars. Their coins of gold and silver had a horseman on one side and a human head on the other. The silver pieces here described may be those of Hippostratus, or of any other of the later Greek, or of the Scythian kings; but as none of these kings struck gold the pieces of

<sup>1</sup> For the facts used in this paragraph see especially Cunningham, in *New Chron.*, new series, x. xl.

<sup>2</sup> Demetrius, Eucratides, Apollodotus, Strato I., Strato II., Eolius, Menander, Dionysius.

<sup>3</sup> He must have had a long reign; see Sallet, *Nachfolger Al. d. Gr.*, p. 84.

<sup>4</sup> "Gārgi Sanhita," in Kern, *Vārāna-Mātra*, p. 87. This is an astronomical work of the first century of our era. The Isamua of Strabo, xi. p. 516, is probably the Sambas of Arr., *Ind.*, 4. 4. The name is presumably corrupt, and Cunningham's conjecture, *Zodros* (the Çōna) for 'Isamua,' would suit best but for the graphical difficulty it involves.

<sup>5</sup> *Milinda-prasna*, in Hardy, *Manual of Buddhism*, pp. 516, 440.

<sup>6</sup> *Madr* differs only by a formative syllable from *Maudryr*, leader of the Sæos of Gangamela (Arr., III. 8. 5). 'Oryōrys' is a Parthian name, but really identical with that of Eunores, king of the Aorsi (Tac., *Ann.*, XII. 16); the other five names can hardly be Parthian.

<sup>7</sup> See Ritter, *Erdrkunde*, VII. 8, 682 sq.; and Abel Rémusat, *Nouveaux Mémoires Asiatiques*, I. 205 sq.

<sup>8</sup> Abel Rémusat, *Mém. de l'Ac.*, VIII. (1827) p. 110.

<sup>9</sup> See what is related for the year 46 in *Hist. Gén. de la Chine*, III. 161.

<sup>10</sup> This identification is obtained by comparing the old description of the Hanging Pass (Rémusat, *Nouv. Mém.*, I. 206) with that of the pass traversed by the Chinese expedition to Badakhshan in 1750 (*Hist. Gén.*, XI. 572).

Eucratides with his bust on one side and the mounted Diocuri on the other will still have had course. South-west of Kipin lay the hot plain of U-ghe-shan-li (Kandahar and Sistan), where the southern road ended (necessarily at a considerable commercial town, therefore at Alexandria in Arachosia). Hence a road leads to An-si (in its original sense, *supra*, p. 593), first northward (to Herat) and then east (to Merv). The inhabitants of U-ghe-shan-li, which was too remote to be often visited from China, hated bloodshed and had weapons adorned with gold and silver. Their coins are described in the same terms as those of Kipin; and probably the latter had course, and there was no native mint. But there was an independent kingdom; and, as it is certain that Drangiana and Arachosia were not at this time (middle of 1st century B.C.) subject to the Greeks—no coins of the successors of Apollodotus having been found there—we conclude that this kingdom was that of the Saces, who overran Iran in 128. Later Chinese writers say that the country was subject to An-si (Parthia), and Isidore of Charax (1 A.D.) makes Arachosia a Parthian satrapy. It was probably under Orodes that Arachosia was conquered and the Saces confined to Sacastane.

The latest coins of Hermias bear also the name of a king, Kujula-Kand, first in the Arrian and finally also in the Greek legend (Κουζουλο-Κανδης). Now the Chinese tell us (*Mém. de l'Ac.*, xxv, 27, 28) that about a century after the Tochari (Yue-chi) conquered Bactria—i.e., 89-27—Kieu-tzien-khio, prince of Kuei-shuang, conquered the other four principalities of the Tochari and named his whole kingdom Kuei-shuang (Kashan). He then warred against the Parthians and took the great land of Kao-fu (Cabal), which had been subject to India, Kipin, and Parthia, as well as the neighbouring lands of Po-ta (north of U-ghe-shan-li; to be identified with the Pactyes or Patans originally settled in Ghôr) and Kipin. The last fact shows that Kieu-tzien-khio is none other than Κουζουλο-Κανδης, who indeed is called on the coins Kashan-Yavugo, "king of Kashan," and "steadfast in the faith," i.e., in Buddhism, which early found entrance among the Tochari. With this account of the conquest of Cabul it agrees that Isidore names Arachosia but not Cabul as Parthian. Now the war of the king of Kashan with the Parthians is none other than that undertaken by the Scythians to restore Phraates to the throne. Troguus had an excursus in this connexion on the Asiatic Kings of the Tochari and the fall of the Sacaranes (doubtless before the increased might of the realm of the Tochari). These intestine conflicts of the Scythians seem to have been at their height during the exile of Phraates, and their issue decided his fortunes. The Romans followed these movements with attention because they threatened Tiridates, and Horace has repeated references to them of a kind that is more than poetic fancy (*Carm.*, i. 26, 3 sq., and especially *lib. 29, 26 sq.*,—"Tanais discors," wars of Tochari and Sacaranes; "plans of the Seres," the Chinese stood in close relation to these lands and had powerfully intervened in the affairs of the Sacaranes in 44).

Before the great host of the Scythians Tiridates retired without a contest. On 1st March 26<sup>1</sup> the news of this had not reached Rome; but in June, as the coins prove,<sup>2</sup> Phraates again held the throne. Tiridates fled to Augustus, who refused to give him up, but agreed not to support him, and restored to Phraates a son whom Tiridates had carried off and placed in his hands as a hostage. The Parthian in return promised to give up the captives and ensigns taken from Crassus and Antony, and fulfilled his promise in 20, when Augustus was in Syria. He would hardly have done so perhaps had not his throne been again insecure; there is a break in the Parthian coinage after October 23, and it is not resumed for many years—a sure sign of inner troubles. There is just one coin known of Phraates's later years (October 10 B.C.; Gardner, p. 62), which probably marks his return from a second exile; for we know from Josephus (*Ant.*, xvi, 8, 4) that between 12 and 9 B.C. Mithradates IV. was on the throne of the Arsacids, and that Herod of Judæa was accused of plotting with him against Rome.<sup>3</sup> The revolt of Media Atropatene, which asked a king from Rome some time between 20 B.C. and 2 A.D., and received Ario-

barzanes II., son of Artavasdes, was probably about this time (*Mon. Anc.*, vi, 9). In 10 or 9 B.C. Phraates took the precaution of sending his family to Rome so that the rebels might have no Arsacid pretender to put forward, keeping only and designating as heir his youngest son by his favourite wife Thea Musa Urania, an Italian slave-girl presented to him by Augustus. This was mainly a scheme of Urania's, and she and her son crowned it by murdering the old tyrant. Phraates V., or as he is usually called Phraataces (diminutive), was thus the third Arsacid, in successive generations, to reach the throne by parricide.<sup>4</sup>

Phraates V., whose first coin is of May 2 A.C., tried an energetic policy, expelling Artavasdes III. and the Roman troops that supported him from Armenia, and seating on the throne Tigranes IV., who had been a fugitive under Parthian protection. Ariobarzanes of Atropatene was probably expelled at the same time; a little later we find him in exile at Rome, and (in spite of Strabo, xi, p. 523, who perhaps had not the latest news) the old line of Atropates seems now to have been superseded by a line of Parthian princes. As Augustus did not wish to extend the empire, and Phraates was not very secure on his throne, neither party cared to fight, and an agreement was patched up after some angry words, Phraates resigning all claim on Armenia and leaving his brothers as hostages in Rome (1 A.D.). Phraates now married his mother, who appears with him on coins from April 2 A.D., a match probably meant to conciliate the clergy, as he knew that the nobles hated him. In fact he was soon driven by a rebellion (after October 4 A.D.) to flee to Roman soil, where he died, it seems, not long afterwards.

The Parthians called Orodes II. from exile to the throne. Of him we have a coin of autumn 6 A.D.; but his wild and cruel temper soon made him hated, and he was murdered while out hunting. Anarchy and bloodshed now gaining the upper hand, the Parthians sent to Rome (before 9 A.D.), and received thence as king Vonones, the eldest of the sons of Phraates IV., a well-meaning prince, whose foreign education put him quite out of sympathy with his country. He preferred a litter to a horse, cared nothing for hunting and carousals, liked to be with Greeks, and relaxed the stringent etiquette that barred approach to the sovereign, and at the same time he tried to check speculation. A strong reaction of national feeling took place, and the main line of the Arsacids being now exhausted by death or exile, Artabanus, an Arsacid on the mother's side, who had grown up among the Dahæ and had afterwards been made king of Media (Atropatene), was set up as pretendant in 10 or 11 A.D. Artabanus was defeated at first,<sup>5</sup> but ultimately gained a great and bloody victory and seated himself in Ctesiphon. Vonones fled to Armenia and was chosen as king of that country (16 A.D.), but Tiberius, who was anxious to avoid war, and did not wish to give Artabanus III. any pretext to invade Armenia, persuaded Vonones to retire to Syria. By and by he was interned in Cilicia, and in 19 A.D. lost his life in an attempt to escape.

The clearest proof of the miserable results of continual civil war in Parthia at this time is that a Jewish robber state maintained itself for fifteen years in the marshes of Nearda and the Babylonian Nisibis a little after 21 A.D.,

<sup>1</sup> Hor., *Car.*, iii, 8, 19-20, belongs to this year, as appears from Phraates's coinage of Darius, 286 B.C. The reduction of the Cantabrians refers to Augustus's personal presence in Spain in the end of 27 (Dio, *l.iii.*, 23), not to their second reduction in 25, which could hardly be known in Rome on 1st March. The retreat of the Scythians refers to the Sarmatian war (Florus, iv, 12, 20).

<sup>2</sup> Prokech-Osten, *Monnaies des Rois Parthes*, p. 87.

<sup>3</sup> Vaillant having missed this passage, no later writer cites it.

<sup>4</sup> Of the Benî Jellâh, who reigned in Tugurt till after the middle of the present century, every sultan is said to have murdered his father, and Mahmud Shah of Guzarat (1538-54), made all his wives procure abortion as the only possible protection for a king against attempts of sons on his life.

<sup>5</sup> A drachma of King Vonones when he had conquered Artabanus is one of the earliest examples of the use of the personal name of the king instead of the throne name. The practice became common, and marks an era of disputed successions, when it was necessary to indicate to which pretendant a coin belonged.

and that, when some satrapies were in revolt and others threatened it, the great king made a pact with the bandits to keep Babylonia in control in his absence. Yet amidst such constant rebellions Artabanus III., shrewd and energetic, not merely held his own but waged successful foreign wars, set his son Arsaces on the throne of Armenia, and challenged Rome still more directly by raising claims to lordship over the Iranian population of Cappadocia. Through the whole first century of the Roman empire all relations to Parthia turned on the struggle for influence in Armenia, and, much as he loved peace, Tiberius could not suffer this disturbance of the balance of power to pass unnoticed. He persuaded Pharasmanes, king of Iberia, to put forward his brother Mithradates as claimant to the Armenian throne. The Iberians, after having procured the assassination of Arsaces, advanced and took Artaxata, the capital; and, when the Parthians came against them under Orodes, another son of Artabanus, Pharasmanes strengthened himself by opening the Caucasian Gates to the Sarmatians,<sup>1</sup> whose chiefs were easily gained to fight where there was money or booty to be got. A bloody battle ensued; Orodes was wounded in single combat with Pharasmanes, and his troops fled, believing him to be dead. In 36 Artabanus himself took the field, but a widespread revolt, long prearranged by Tiberius with a Parthian party led by Sinnaces, rose behind him in the name of Tiridates, a grandson of Phraates IV., who had been chosen as pretendant from the Parthian princes at Rome, and Artabanus retired to Hyrcania to resume his old relations with the adjacent nomads. The Roman legate of Syria, Lucius Vitellius, with his legions, led Tiridates into Parthia, where his followers joined him; Mesopotamia, Apolloniatis, and Chalonitis did homage; and the Syrian and Jewish population of Seleucia, which hated the party of Artabanus (the oligarchy of the 300 "adiganes" drawn from the old Greek families), were gratified by democratic institutions. In Ctesiphon Tiridates was crowned by Surenas, but without waiting for Phraates and Hiero, satraps of two chief provinces (Upper and Rhagian Media), who became his enemies for this slight. Nor were they alone in their jealousy of the absolute court-influence of Sinnaces and his father Abdageses. Artabanus was called back and appeared from Hyrcania with an auxiliary force of Dahæ and Saces; Tiridates retired to Mesopotamia, where his party was strongest, but his army melted away, and in 36 A.D. he took refuge in Syria. Much as Artabanus hated the Romans, his insecure position at home drove him in 37 to make an accommodation on terms favourable to them and send his son Darius as hostage to Tiberius. Indeed, he was again for a short time an exile with Izates of Adiabene, who, however, effected his restoration and was rewarded by the transference of Nisibis to him from Armenia, which the Parthians had again got in their hands, taking advantage of the foolish policy of Gaius Cæsar, who had tempted Mithradates of Armenia to Rome and imprisoned him there. Artabanus died soon after his second restoration, probably in 40 A.D., as Josephus (*Ant.*, xviii. 7, 2) still mentions him in 39.

In Artabanus's lifetime the second place in the empire had been held by one Gotarzes, who appears to have been his colleague in the upper satrapies, and perhaps his lieutenant in his flight to Adiabene. But there is monumental evidence<sup>2</sup> that he was not, as Josephus says and Tacitus

implies, Artabanus's son (except by adoption), and so we find that the succession first fell to Vardanes, who coined money in September 40. But in 41 Gotarzes appears as king. The cruelties of Gotarzes gave Vardanes an opportunity of return; in two days he rode 345 miles, and taking his rival by surprise forced him to flee, and occupied the lower satrapies, where he coins regularly from July 42 onwards. Vardanes now laid siege to Seleucia, which had been in rebellion since it opened its gates to Tiridates in 36, but was presently called away to meet Gotarzes, who had secured the aid of the Hyrcanians and Dahæ. The renewal of civil war enabled the emperor Claudius, with the aid of the Iberians, to drive the Parthian satrap Demonax from Armenia and reseat Mithradates on the throne.<sup>3</sup> Meantime Gotarzes and Vardanes were face to face in the plain of western or Parthian Bactria, but an attempt on the life of the latter having been disclosed by his foe they made peace, and Gotarzes withdrew to Hyrcania, while Vardanes, confirmed in his empire, returned to Seleucia and took it in 43 after a siege of seven years.

Seleucia was then a city of vast resources; in the time of Pliny it reckoned 600,000 souls, and the neighbourhood of Ctesiphon had not ruined it as Seleucia had ruined Babylon. Indeed Strabo (xvi. p. 743) is probably to be believed when he says that Ctesiphon was founded as the winter residence of the Parthian kings mainly out of consideration for Seleucia, whose merchants would have been incommoded by the quartering on them of the rude hordes of nomads who formed the larger part of the army which surrounded the court. The friendship of the Parthians was necessarily impaired by the long rebellion and the insolence of the Seleucians: in 41 the Syrians and Greeks put aside their own quarrels and united to slaughter the Jews; the survivors fled to Ctesiphon, and even here the hatred of the Seleucians followed them in despite of the great king. Probably, therefore, it was as a rival to Seleucia that Volagases (or Vologases) I. founded a little later Volagocerta (near Hira) on a site very favourable for commerce. From the middle of the first Christian century Greek influence declined, and Orientalism revived in Parthia. The types of the Arsacid drachms—the imperial money—grew more and more barbaric from the time of Artabanus III.; and Pahlavi legends, first found on coins of Volagases I., become predominant with Mithradates VI., the contemporary of Trajan.

Vardanes was deterred from an attempt on Armenia by the threatening attitude of Vibius Marsus, legate of Syria from 42 to 44, and the rest of his reign was fully occupied by internal affairs. In February 45 Gotarzes had renewed his pretensions and struck money, supported by the rebellious nobles, and Vardanes, after defeating him at the passage of the Erindes,<sup>4</sup> pursued him eastwards through the deserts, driving the nomads before him as far as the Sindes (Tejend), which divided the Dahæ from the Arians, and returned boasting "that he had reduced nations who never before had paid tribute to an Arsacid." The glory that was held to surround these exploits on a stage scarcely different from that on which the oldest Parthian history had been enacted is a striking proof of the neglect of the original home of the monarchy under the pressure of Western affairs; but that Vardanes was a great king is plain from the high praise of Tacitus and the attention which the greatest of Roman historians bestows on a reign which had no direct relations to Rome. Vardanes, whose last coin is of August 45, was murdered while hunting—a victim, we are told, to the hatred produced by his severity to his subjects. But in judging of the charges brought against him and his two predecessors we must remember that the rise of a new dynasty like that of Artabanus is of Artabanus. The last title seems to mean "alter ego"; it appears miswritten Ταύμενος in Dio, xl. 12, as applied to Siliacus, whom Orodes I. sent against Crassus; comp. New Persian *katavasa*, "agent." Philostratus, in his life of Apollonius, which contains much that is useful for this period, regards the expulsion of Gotarzes as a restoration of the Arsacids.

<sup>2</sup> In the chronology of what follows Longuerus's arrangement has been brilliantly confirmed by the coins.

<sup>4</sup> Or Charindas (Ptol., vi. 2, 2), now the Kerind, which separates Mazandaran from Astarabad.

<sup>1</sup> Josephus, *Ant.*, xviii. 4, 4 (according to the MSS.), says Alans; *Σάρας* is an interpolation. In modern as in ancient times Iberian kings have repeatedly followed the same dangerous policy to increase their strength. The power of the Christian kings of Georgia in the 12th century rested wholly on alliance with the mountain tribes.

<sup>2</sup> On a Greek inscription at Bisanua he is "satrap of satraps and *ἑταίρος*" (son of Géw); on a coin he probably appears as *Γόταρζης*, king of the kings of the Arsaci (east Iranians), son of Ge, "kalymenos"

always accompanied by deeds of violence, and that the oppressed subjects are simply the utterly unruly Parthian nobles who had lost all discipline in the long civil wars, and could only be controlled by force.

After another period of dispute we now find Gotarzes again on the throne and coining regularly from September 46 onwards. But his qualities had not improved, and in 47 a secret embassy of malcontents was at Rome asking Claudius to send them as king Meherdates, son of Vonones. In 49 the legate, Gaius Casius, did in fact conduct Meherdates (Mithradates V.) as far as Zeugma, where he was met by divers Parthian magnates, and ultimately, after a detour through the snows of Armenia, got as far as Nineveh and Arbela. But his only real strength lay in Carenas, satrap of Mesopotamia; Abgar V. and Izates, the kings of Orrhoene and Adiabene, pretended to be with him, but were in private understanding with Gotarzes, and deserted before the decisive battle in which Carenas was surrounded and Meherdates taken (50 A.D.). Gotarzes cut off his rival's ears, but spared his life—an act of leniency most unusual in the East, which proves how much the national feeling of the Iranians despised the pretenders foisted on them by Rome.

Gotarzes died of a sickness, not before June 51, and was followed by Vonones II., who had been king in Atropatene, and was probably a brother of Artabanus III. According to the coins his short reign began before September 51 and did not end before October 54.<sup>1</sup> He was succeeded by his eldest son, Volagases I., the brothers acquiescing in his advancement, although his mother was only a concubine from Miletus (comp. Tac., *Ann.*, xii. 44, with Plut., *Crassus*, 32), and receiving their compensation by being nominated to kingdoms which gave them the second and third places after the "king of kings."—Pacorus to Media or Atropatene and Tiridates to Armenia,<sup>2</sup> which the Parthians invaded (in 52 f) to expel the usurper Radamistus, murderer of King Mithradates. Radamistus was not finally disposed of till 54, when his own people rose against him. The Armenians now offered no resistance to the Parthians, but the Romans were not content to lose their influence in the land, and their plans were favoured by the rising of a new pretendant, the son of Vardanes, against Volagases. The latter had marched to chastise Izates of Adiabene, whose conduct had been very ambiguous in previous embroilments with Rome, when a great army of Dahs and Sacs entered Parthia. Of the son of Vardanes<sup>3</sup> we have coins from December 55 to July 58, and as the series of coins of Volagases begins only in 61 it was probably not till then that he had quite mastered his more powerful rival and consolidated his own authority. At first he had to evacuate Armenia, and in 55 he even gave up the chief Arsacids as hostages to Domitius Corbulo, Nero's commissioner on the frontier. In 58, however, Volagases was again able to commence great operations in Armenia, though direct war between Parthia and Rome was still avoided, both sides accepting the fiction that what was done in Armenia was the private affair of Tiridates. The Parthians, indeed, were still in no condition for a great war; the intestine discords continued, and in 58 Hyrcania,

one of the oldest Parthian lands, revolted and sent an embassy to seek alliance with Rome. In the same year, and in that which followed, Corbulo was able with little resistance to destroy Artaxata, occupy Tigranocerta, and set on the Armenian throne, supported by Roman troops, Tigranes V., a prince of that branch line of the Herods which had been established in Cappadocia. At length, in 61, Volagases made peace with the Hyrcanians, acknowledging their independence; then, solemnly crowning Tiridates as king of Armenia, he directed his whole forces against Tigranes. Open war with Rome, however, was still delayed by negotiations with Corbulo, who proposed a peace with a secret condition that the Roman troops should be withdrawn from Armenia. He felt, no doubt, that Tigranes, who had inherited the servility but not the vigour of his ancestor Herod, was not strong enough to secure the obedience of a population which greatly preferred the rule of the Parthians as their brethren in faith, manners, and descent. But Rome refused to confirm the treaty, and war was declared.<sup>4</sup> The first year of the war (62) was unfortunate for the Romans, and ended with the capitulation of Csesennius Pætus (who now commanded in Armenia) at Randae, on the southern bank of the Arsanias (i.e., Aradzani, the Armenian name for the upper Euphrates), near Arsamosata. The Romans evacuated Armenia and had also to build the Parthians a bridge over the Arsanias. Corbulo meantime was in Syria, and had purposely left Pætus in the lurch, contenting himself with securing the passages of the Euphrates and guarding them by castles on Parthian soil. He now came to an agreement with the Parthian general, Monases, to raze the castles in return for the evacuation of Armenia by the Parthians till Rome should be again consulted. Next year the war was resumed, and Corbulo, crossing the Euphrates at Melitene, had penetrated into Sophene when the Parthians earnestly sought peace. It was agreed that Tiridates should lay down his diadem and go to Rome in person to receive it again from the emperor, which was done accordingly in 66. The real advantage of the war lay more with Parthia than with Rome, for, if the Roman suzerainty over Armenia was admitted, the Parthians had succeeded, after a contest which had lasted a generation, in placing an Arsacid on the Armenian throne. After Nero's death Volagases formed very friendly relations with Vespasian, which endured till 75. Meantime all Iran was sorely troubled by the Alans, who had spread themselves a little before over the plains on the north-west slopes of the Caucasus as far as the Don and the Sea of Azoff. In 72 the king of Hyrcania opened the pass of Derbend to these barbarians, who ravaged Media and drove King Pacorus into the recesses of his mountains, even capturing his harem. Armenia was also plundered, and the bandits retired laden with booty. In 75 the Alans entered Parthia itself and pressed Volagases so hard that he made an ineffectual application for help to Vespasian.<sup>5</sup> Vespasian's refusal very nearly led to war, and Trajan, who was now governor of Syria, was prepared for a Parthian invasion,<sup>6</sup> but Vespasian's pacific firmness ultimately averted an outbreak.<sup>7</sup>

We have the evidence of Tacitus (*Ann.*, xi. 8) and Josephus (*J. Ant.*, xx. 4, 2) that Bactria was the eastern limit of the Parthian empire

<sup>1</sup> Gardner (p. 51) is wrong in ascribing this coin to Volagases I. Tacitus makes Volagases come to the throne in 52 or 53, but if this is right he must have been associated in the empire under Vonones.

<sup>2</sup> Tac., *Ann.*, xv. 2. There was at this time a fourth monarchy under a Parthian king in east Iran and on the Indus, and a fifth among the Boythians (or rather the Maskhuth) on the northern slopes of the Caucasus, where an Arsacid reigned in 19 A.D. (Tac., *Ann.*, ii. 68). As the Median kingdom was subsequently united to the chief empire, the later Armenian historians, Agathangelus (Langlois, l. 109) and Sebéus (*ibid.*, p. 199), are right in speaking of four Arsacid kingdoms.

<sup>3</sup> His name was probably Nanes, for BNANO on a copper coin (Gardner, p. 51) must be read Β[αρ]Ναν[ος] Ναν[ος].

<sup>4</sup> Tacitus and Dio in this part of the history are both dependent on the very mendacious memoirs of Corbulo. Tacitus, as appears from *Ann.*, xv. 16, distrusted his source and followed it with more discrimination than Dio, but is still more favourable to Corbulo than a criticism strictly proceeding on the known facts can admit to be right.

<sup>5</sup> It must have been against the Alans that Vespasian in this year, according to a Greek inscription of Metakheta (*Journ. As.*, ser. 6, xiii. 93), fortified the castles of the Iberian Mithradates and of the Jamasdaltes.

<sup>6</sup> This is all that is meant by "Parthica laurus" Plin., *Plin.*, 14.

<sup>7</sup> In Victor, *Ces.*, 9, 10, read "ab illo" for "ac bello," comparing the epitome.

in 42 and 54 A.D., but in 59 the Hyrcanian ambassadors were able to return home from a port on the Persian Gulf without touching Parthian soil (Tac., *Ann.*, xiv. 25). This implies that all the upper satrapies had been lost to the empire. The Hyrcanians were still independent c. 165 during the reign of Antoninus Pius (Victor, *Epit.*, 15, 4). In 72 they held the whole southern coast of the Caspian, and for a time at least bordered on a Parthian kingdom which had succeeded that of the Scythians in Sacastane at a date subsequent to that of Isidore of Charax (1 A.C.). The names of seven kings of this dynasty, beginning apparently with an Arsaces Dicaeus, are known from coins. The most powerful of these was the Gondophares under whom, according to the legendary *Acta Thomæ*,<sup>1</sup> the apostle Thomas came to India in 29 A.D.; he reigned over a great territory, which in large part had formerly belonged to Parthia, his coins being found mainly in Herat, Sistān, and Kandahar, but also in Begram and sometimes in the Punjab; an inscription at Takht-i-Behi, north-east of Peshawar, makes his twenty-sixth year the hundredth of an era which is probably that of the introduction of Buddhism in the Cabul valley.<sup>2</sup> The dynasty of Gondophares, however, was but loosely constituted: we often find two kings at one time; and the *Periplus* (70 A.D.), which tells us of the possession of old Indo-Scythia by these Parthians, says that one king was constantly displacing another, a sure symptom of a moribund condition. One of the last kings, Sanabares, reigned a little after 78 A.D. (Sallet, *op. cit.*, p. 158). The author of the *Periplus* had also heard of the independent and very warlike nation of the Bactrians, i.e., the Tochari, whose greatest conquests fall at this time. Kieu-tsiou-khio, the founder of their power, died, according to Chinese accounts, at the age of eighty, and was succeeded by his son Yen-kao-chin, who conquered the Indus lands. The Tochari were then more powerful than ever, and ruled as far as Shao-ki or Oude. The coins, on the other hand, lead us to distinguish between Kozola-Kadaphes, the immediate successor of Korulo-Kadphizn (who borrows the latter's name and titles, and whose copper money found at Manikyala in the Punjab may be dated by its offering a close imitation of the head of Augustus on denarii struck between 4 B.C. and 2 A.D.), and the real conqueror of India, Ooemo-Kadphisés (Ar. Hima Kapiçé), who reigned from about the middle of the 1st century A.D., and whose might is proved by his striking gold, which no one had done since Eucratides. His coins, frequent in Kabulistan and the Punjab, have been found as far as Benares. This evidence is reconciled with the Chinese account by an Indian notice in Kern, *Parāka-Mūhira*, p. 39, which shows that the conquests of the Tochari were for a time interrupted. It speaks of a robber Çaka king who was very powerful (i.e., Yen-kao-chin, or Kozola-Kadaphes), after whom there were five native kings. Of these the first four reigned but a few years, while the fifth, who is unnamed, had a reign of twenty years over a happy land, after which the Çakas began their depredations again. The unnamed king may be identified with a king wearing earrings, and therefore Indian, whose coins, found by sackfuls in Begram, and occasionally in the Punjab, Malwa, and even farther east, mark him as a neighbour and probably contemporary of Gondophares; they bear no name, but only the title "king of kings" and "great saviour."<sup>3</sup> The recommencement of the Çaka conquest will thus begin with Ooemo-Kadphisés, who was the immediate predecessor of Kandrki or Kanishka, the founder of the Turnah dynasty, whose accession in 79 A.D. is the epoch of the Çaka era (Oldenberg, *Z. f. Num.*, viii. 290 sq.), and marks the consolidation of affairs in the East.

Volagases I. died soon after the Alan wars, leaving a just reputation by his friendly relations to his brothers—a thing so long unknown—his patient steadfastness in foreign war and home troubles, and his foundation of a new capital. Perhaps also he has the merit of collecting from fragments or oral tradition all that remained of the *Avesta*.<sup>4</sup> From June 78 we find two kings coining and reigning together, Volagases II. and Pacorus II., probably brothers. From 79 there is a long break in the coins of the former, and Artabanus IV. takes his place with a coin struck in July 81. This Artabanus appears as the protector of a certain Terentius Maximus, who pretended to be Nero<sup>5</sup>; he threatened to restore him and displace Titus by force, and, though the pretender was at length given up, the farce, which was kept up till 88, might have ended

in earnest but for the disorders of the times, indicated by a break in the Parthian coinage between 84 and 93, in which latter year Pacorus appears as sole king.<sup>6</sup>

At this time the political horizon of Parthia was very wide, and its intercourse with the farthest East was livelier than at any other date. In 90 the Yue-chi had come to war with the governor of Chinese Tartary and been reduced to vassalship; in 94 a Chinese expedition slew their king, and, advancing to the "North Sea" (Lake Aral), subdued fifty kingdoms.<sup>7</sup> The Tochari, one sees, like the Greeks before them, had neglected the lands north of the Hindu-Kush in their designs on India; even of Ooemo-Kadphisés no coins are found north of that range. In 97 Chinese envoys directed to Rome actually reached the Mediterranean, but were dissuaded from going farther by Parthian accounts of the terrors of the sea voyage, and in 101 Muon-kiu, king of the An-si (Parthians), sent lions and gazelles of the kind called "fu-pa" (Βούβαλος) to the emperor of China. Muon-kiu reigned in Ho-to, i.e., Carta or Zadracarta in Hyrcania; he was therefore a king of the Hyrcanians, who also held the old Parthian lands east of the Caspian Gate, and may be identical with a king, rival to Pacorus, who struck copper coins in 107 and 108, if the latter is not identical with the later monarch Osroes. But anyhow the representative of the Parthian power in the west was still Pacorus II., who in 110<sup>8</sup> sold the crown of Edessa to Abgar VII. bar Isat, and died soon after, making way for his brother Osroes, who coins in the same year, but had to reckon with two rivals, viz., Volagases II. (who reappears after an interval of thirty-three years), from 112 onwards, and Meherdates (Mithradates) VI. The latter was a brother of Osroes, and so probably was the former. None of the three was strong enough to conquer the others, and continual war went on between them till Osroes was foolish enough to provoke Roman intervention by taking Armenia from Exedares, son of Pacorus, to whose appointment Rome had not objected, and transferring it to another son of Pacorus called Parthamasiris. Trajan, who had quite thrown over the principle of the Julii and Flavii, that the Danube and the Euphrates were the boundaries of the empire, and was fully embarked on the old Chauvinist traditions of the republic, would not let such an occasion slip; and, refusing an answer to an embassy that met him at Athens, he entered Armenia and took Arsamoesta<sup>9</sup> without battle, after receiving the homage of western Armenia (114). Parthamasiris submitted himself to the emperor, but Trajan declared that Armenia must be a Roman province, appointed an escort to see the Parthian over the border, and when he resisted and tried to escape ordered his execution,—a brutal act, meant to inspire terror and show that the Arsacids should no longer be treated with on equal terms. Armenia and the neighbouring kings to the north having given in their submission, Trajan marched back by Edessa, receiving the homage of Abgar. The campaign of 115 was in Mesopotamia, and the burden of it fell on Mebarsapes of Adiabene and his ally Mannus of Singara. At

<sup>1</sup> There is a naive personal character about all the feelings of the Arsacids towards the Cæsars. Artabanus III. orders deep mourning for Germanicus, and sends Tiberius an insulting letter, advising him to escape the hate of his subjects by suicide. Volagases I. urges the senate to honour the memory of Nero. In the support given to the pseudo-Nero legitimist sympathies with the Julii may have combined with the wish to pay back in their own coin the Romans who had so often backed Parthian pretendants. *Hist. Gén. de la Chine*, iii. 393 sq.

<sup>2</sup> The third year of Abgar VII. was the fifteenth of Trajan (Curetton, *Ann. Syr. Doc.*, p. 41); this involves a correction of +23 years applied to all Dionysius of Telmahar's dates for the later kings of Edessa, as well as a blank of nineteen years before Abgar VII.

<sup>3</sup> Read *μύχμας Αραγοστέρας* in Dio, lxxviii. 19. Samocata was a Roman town, and if they had lost it first this would have been mentioned.

<sup>1</sup> See *N. Rhein. Mus.*, xix. 161 sq.

<sup>2</sup> This was 500 years after Buddha (*Z. f. K. d. Morgenl.*, iii. 129), which would give the date 57 A.D.

<sup>3</sup> This is perhaps the king *qui regnavit sine nomine* of Suetonius, *De Regibus* (Auzan., *Ep.*, 19).

<sup>4</sup> Dinkart, in *Hang. Publ.-Pec. Hoec.*, p. 144, calls the king who did this only Volkash (i.e., Volkash), descendant of Ashkan.

<sup>5</sup> Zonaras, xi. 18; *Oruc. Sib.*, iv. 124, 137.

its close Mesopotamia was made a Roman province; the Cardueni and the Marcomedi<sup>1</sup> of the Armenian frontier had also been reduced, and Trajan received the title of "Parthicus." In 116 the Tigris was crossed in face of the enemy (probably at Jezirat ibn 'Omar), and a third new province of Assyria absorbed the whole kingdom of Mebarsapes. Once more the Tigris was crossed and Babylonia invaded, still without resistance from the Parthians, whose intestine disorders continued. A Roman fleet descended the Euphrates and the ships were conveyed across on rollers to the Tigris, to co-operate with the army; and now Ctesiphon fell and Osroes fled to Armenia, the north-east parts of which cannot have been thoroughly subdued. The Roman fleet descended the Tigris and received the submission of Mesene; but now, while Trajan was engaged in a voyage of reconnaissance in the Persian Gulf—plainly aiming at Bahrein—all the new provinces revolted and destroyed or expelled the Roman garrisons. The rebels, whose centre was in Mesopotamia, set Meherdates VI. at their head;<sup>2</sup> and, when he died by a fall from his horse in a foray on Commagene, his son, Sinatruces II., took his place, and was aided by an army which Osroes sent from Armenia under his son Parthamaspates. The reconciliation of the Arsacids among themselves was rewarded by the defeat and death of the Roman general Maximus; but jealousy now sprang up between the cousins, and of this Lusius, a second general sent by Trajan from Babylon, took advantage to draw Parthamaspates to the Roman side by a promise of the Parthian throne. Sinatruces was defeated and slain, Nisibis retaken, Edessa stormed and destroyed, and the whole rebellion put down; but Trajan now saw what it would cost to maintain direct Roman rule over such wide and distant conquests, and Parthamaspates was solemnly crowned in the great plain by Ctesiphon in the presence of Romans and Parthians (winter 117). An unsuccessful siege of Atra (Ĥatrá) in the Mesopotamian desert was Trajan's next undertaking; illness and the revolt of the Jews prevented him from resuming the campaign, and after Trajan's death (7th August 117) Hadrian wisely withdrew the garrisons from the new provinces, which would have demanded the constant presence of the imperial armies, and again made the Euphrates the limit of the empire. Parthamaspates too had soon to leave Parthia, and Hadrian gave him Orrhoene.<sup>3</sup> Thus Trajan's Chauvinist policy had no other result than to show to the world the miserable weakness to which discord had reduced the Parthians.<sup>4</sup> And the discord did not cease even now, for, though Osroes was restored, Volagases still continued to coin, whether as rival or as partner of his rule, in some part of the realm. Hadrian continued to preserve peace, though a war threatened in 123,<sup>5</sup> and in 130 he restored to Osroes his daughter taken captive by Trajan at Ctesiphon. Osroes died soon after, and Volagases II. became sole monarch, dying in November 148 at the age of about ninety-six, after a reign of seventy-one years.<sup>6</sup>

<sup>1</sup> Entr., viii. 3; Festus Rufus, *Brev.*, 20. Marcomedi are the Medes called Markh, the plural of Mar, "Mede" in Armenian.

<sup>2</sup> What follows is drawn from Malalas, who has two passages (l. 351-352 and 357-358) drawn from Arrian's *Parthica*, but placed in a wrong context.

<sup>3</sup> He is the Parthaspates who was king of Edessa from 119 to 123; this fact and its relation to Spart., *Hadri.*, 5, has escaped notice owing to the false chronology of Dion. Telm.

<sup>4</sup> A proof of this is that very few silver drachms and no tetradrachms were struck between 96 and 120.

<sup>5</sup> See Dürr, *Reisen des K. Hadrian*, p. 48. The removal of Parthamaspates and restoration of the old dynasty of Orrhoene may have been a concession made on this occasion.

<sup>6</sup> The Volagases who appears in connexion with an Alan invasion of Media, Armenia, and Cappadocia in 135 is from the context a different person, viz. the unnamed king of Armenia who was appointed by Hadrian in 117 (Spart., *Hadri.*, 21), and whose successor took the throne between 140 and 143 (Eckhel, *Doct. num. vet.*, vii. 14).

Volagases III., who succeeded, had designs on Armenia, but an interview between him and Antoninus Pius (spring 155) delayed for a time the outbreak of war.<sup>7</sup> However, martial preparations went on, and on the death of Antoninus Volagases entered Armenia (162),<sup>8</sup> expelled the Arsacid Sohæmus, who was a client of Rome, and made Pacorus king. The destruction of a Roman legion under the legate of Cappadocia (Ælius Severianus), who fell on his own sword, laid Cappadocia and Syria open to the Parthians; Attidius Cornelianus, legate of Syria, was routed, and the provincials were in such distress that they even began to speak of revolt from Rome. When late in the year Ælius Verus arrived from the capital he found the troops so demoralized by defeat that he was ready to offer peace; but, when Volagases refused to treat, the able lieutenants whom Verus directed from Antioch soon changed the face of affairs. The war had two theatres, and was officially called the Armenian and Parthian war.<sup>9</sup> Armenia was regained and Sohæmus restored by Statius Priscus and Martius Verus (163, 164), while Avidius Cassius drove Volagases from Syria in a bloody battle at Europus, and, entering north Mesopotamia, took Edessa and Nisibis, though not without serious opposition.<sup>10</sup> At length, deserted by his allies (i.e., by the local kings, who were becoming more and more independent), Volagases abandoned Mesopotamia, and Cassius entered Babylonia, where, on a frivolous pretext, he gave up to rapine and fire the friendly city of Seleucia, still the first city of the East, with 400,000 inhabitants. The destruction of Seleucia was a hideous crime, a mortal wound dealt to Eastern Hellenism by its natural protectors; that Cassius next, advancing to Ctesiphon, razed the palace of Volagases to the ground may, on the other hand, be defended as a symbolical act calculated more than anything else to impair the prestige of the Parthian with his Oriental subjects. Cassius returned to Syria in 165, with his victorious army much weakened through the failure of the commissariat and by the plague, which, breaking out in Parthia immediately after the fall of Seleucia, spread over the whole known world. In the same year Martius Verus won hardly less considerable successes in Media Atropatene, then apparently a separate kingdom.<sup>11</sup> The peace which followed in 166 gave Mesopotamia to Rome. This was the greatest of all wars between Rome and Parthia, alike in the extent of the lands involved and the energy of attack shown by the Parthians. The Romans used their victory with moderation, but Parthia, after this last effort, continued steadily to sink.

The Romans at the same time made an effort to compete with Parthia for the Chinese trade (especially in silk), which the latter had jealously kept in their own hands, and in 166 an envoy of An-thun (M. Antoninus) reached the court of the emperor Huan-ti, via the sea and Tongking. But the effort to establish a direct trade with China was unavailing, and the trade still flowed in its old channels when a second Roman agent reached China in 226, a little before the fall of the Parthian empire. The Chinese tell us that with India also the Parthians drove a considerable trade.<sup>12</sup>

<sup>7</sup> Aristides, *Or. Sacra*, l. 498, Cant.; cp. Waddington, in *Mém. de l'Acad.*, xxvi. (1867) p. 260 sq.

<sup>8</sup> For this war cp. the excellent monograph of E. Napp, *De rebus imp. M. Aur. Ant. in Or. gentis*, 1879.

<sup>9</sup> *C. I. L.*, vi. Noa. 1377, 1457, 1497. For the order of events cp. Lucian, *De Cons. Hist.*, 30.

<sup>10</sup> Details in Suidas, s.v. *Zedypus*; Luc., *op. cit.*, 29; Fronto, *Epp. ad Verum*, li. 1, 121, Naber.

<sup>11</sup> This seems to follow from the fact that both emperors, who were already called "Armeniacus" and "Parthicus Maximus," also call themselves "Medicus" (on a coin earlier than 28th August 165), Eckhel, iv. 76; *Inscr. of Signa*, Orelli, No. 859.

<sup>12</sup> The "Annals of the Second Han," in Deguignes, *Mém. de l'Acad.*



Volagases III. died in 191, having reigned forty-two years without civil war, and was succeeded by Volagases IV. During the civil troubles of Rome which preceded the establishment of the military empire this prince maintained friendly relations with Pescennius Niger; and his vassal Barsenius of Atra was permitted to supply a force of bowmen, who took part in the fighting against Septimius Severus at Nicæa (194). When Niger's cause declined, however, Volagases allowed his clients of Adiabene to join with Orrhoene, now in revolt against the Roman power. The strongholds of Mesopotamia were taken, and their garrisons put to the sword; Nisibis itself was besieged. In truth, the Parthian could no longer pretend to control the policy of the princes on his frontier, who felt themselves their own masters since they had borne the chief brunt of the last two Roman wars. But in summer 195 Severus appeared in Mesopotamia, received the submission of Abgar VIII. of Orrhoene, and from Nisibis (which, with true insight into its strategic importance, he raised to a colony and great military station) directed two successful campaigns against Adiabene<sup>1</sup> (196) and the Arabs of the Singara district, incorporating the latter in the province of Mesopotamia.<sup>2</sup> The Parthians made no movement till Severus was busy with Albinus, when they ravaged Mesopotamia and besieged Laetus in Nisibis; but in 198 Severus was again on the scene of war, and they fell back without fighting, leaving the emperor free to prepare for next year a campaign on a great scale. In 199 a fleet on the Euphrates co-operated with the Roman army, and Severus, taking up an unaccomplished plan of Trajan, dredged out the old Naarmalca canal, through which his ships sailed into the Tigris, and took the Parthians wholly by surprise. Seleucia and Coche<sup>3</sup> were deserted by their inhabitants; Ctesiphon was taken by the end of the year with terrible slaughter, 100,000 inhabitants being led captive and the place given up to pillage, for the great king had fled powerless at the approach of the foe. Severus, whose force was reduced by famine and dysenteries, did not attempt pursuit, but drew off up the Tigris. The army was again in its quarters by 1st April 200 (*C.I.L.*, vi. 225 a), and for some time thereafter Severus was occupied in Armenia. But in 201 he undertook a carefully organized expedition against Atra, from whose walls the Romans had been repulsed with great loss when Severus, returning from the Tigris in the previous year, had attempted to carry it by a *coup de main*. This city, which in Trajan's time was neither great nor rich, was now a wealthy place, and the sun-temple contained vast treasures. The classical authors call Atra Arabian, but the king's name is Syriac, Barsenius, i.e., Bar Sîn, son of the moon, and we may suppose that it was really an Aramæan principality,<sup>4</sup> which, like Palmyra, had its strength from the surrounding Arab tribes that it could call into the field. Severus lay before Atra for twenty days, but the enemy's cavalry cut off his foraging parties, the admirable archers galled the Roman troops, a great part of the siege train was burned with naphtha; and, when, in addition, two assaults had been repulsed with tremendous loss on two successive days, the emperor was compelled to raise the siege,—a severe blow to Roman prestige in the East, and one that greatly raised the name of Atra and its prince, but did not help the decaying power of Parthia in the least.

xxxii. (1766), p. 358; Pian-t-tian, in *Mém. Ac. Inscr.*, viii. (1827) p. 124 sq.; and *Journ. As.*, ser. 3, viii. 278, 280 sq.

<sup>1</sup> In Dio, lxxv. 3, read τῆς Ἀρβηνίου for τῆς ἀρχῆς.

<sup>2</sup> Not only Herodian, iii. 9, but Capitol., *Macrinus*, 12, implies that these Arabs were Yemenites; the great migration of southern Arabs, which led to the foundation of the kingdom of Hira, had therefore already taken place.

<sup>3</sup> Dio, *Exc.*, lxxv. 9, has Babylon, but it was a mere heap of ruins in the beginning of the 2d century A.D.

<sup>4</sup> Cp. Nöldeke, *Tubari*, p. 34.

In 209 Volagases IV. was succeeded by his son Volagases V., under whom in 212 the fatal troubles in Persia began, while in 213 his brother Artabanus rose as rival claimant of the kingship;<sup>5</sup> and the civil war lasted for many years. A fresh danger arose when Tiridates, a brother of Volagases IV., who had long been a refugee with the Romans and had accompanied Severus's campaign of 199, escaped, in company with a Cilician adventurer, the Cynic Antiochus, to the court of his nephew Volagases; for the emperor Antoninus (Caracalla) demanded their surrender, and obtained it only by a declaration of war (215). About the same time Artabanus gained the upper hand, and in 216 he held Ctesiphon and its district; but Volagases still held out in the Greek cities of Babylonia, as his tetradrachms prove (till 222). Artabanus's strength lay in the north; the Arab histories of the Sāsānians make him king of the Median region, and agreeably with this he coins only drachms.<sup>6</sup> Presently Artabanus had a war with Rome on his hands; the pretext was that he had refused his daughter to Antoninus, but the emperor was mindful of his father's dying advice to enrich the soldiers and despise all other classes, and saw a prospect of rich booty. In 216 the Romans penetrated to Arbela by way of Carduene and Calachene,<sup>7</sup> and violated the graves of the kings of Adiabene, which they falsely took for those of the Arsacids. Thus far the Parthians, who had been taken by surprise in full peace, had offered little or no resistance, but Antoninus was murdered (8th April 217) while he was preparing for a new foray, and his successor Macrinus at once found that Artabanus was now armed, and was not the man to let the insult to his territory pass with impunity. An overwhelming Parthian force fell on Mesopotamia and refused to be appeased by the restoration of the captives of the previous year; Macrinus was beaten in two engagements<sup>8</sup> and compelled to retire to Syria, abandoning the Mesopotamian plain; and in the winter of 217/218 he was glad to purchase peace for an indemnity of 50,000,000 denarii (£1,774,298). In or about 222 Artabanus must also have displaced his brother in Babylonia, for he was a patron of Rab Abba, who became head of the Jewish school of Surā in 219.<sup>9</sup>

Persia, which dealt the last blow to the Arsacids, had through the whole Parthian period held an isolated position, and is so seldom mentioned that our knowledge of its history and native princes is almost wholly due to recently-found coins.<sup>10</sup>

These embrace a triple series of silver coins and a class of copper pieces. The oldest of the latter class bears the name of Camnascires, and his is the only name in the class known to us from other sources, for Hyrodes and Phraates (each of which names was borne by two kings of the series) are not Arsacid great kings, as their title is only "king," not "king of kings" (against Mordtmann). Nor do they seem to have ruled in the same quarter with the kings who struck silver; the latter were native kings of Persia, the former rather Elymæans, who in the times after Camnascires were forced back in a south-east direction (as appears from the places in which the coins are found), and ruled parts of Persia side by side with the

<sup>5</sup> According to Mani, in the book *Shaburkan*, the 4th year of Ardhabân = 216/217; see Al-Bérûni, tr. by Sachau, pp. 121, 190. This proves that in 216 Artabanus was the recognized sovereign in the district of Ctesiphon to which Mardinu (on Habl Ibrâhim) belongs; cf. Nöldeke, *Tubari*, p. 16.

<sup>6</sup> See above, p. 601.

<sup>7</sup> Dio says they invaded Media, but Antoninus had not such a hold of Armenia as to open to him the route of the triumvir Antony, and a march from Gasca to Arbela over Mount Zagrus is incredible. But, if Media at this time extended so far west as to include Arrapachitis and Calachene (the Marcomedians of Trajan's wars), the campaign is intelligible, and Spartian's mention of the Cadusians and Babylonians can be explained as a misreading of Καρδουνας and Ἀρβηνας in a Greek source.

<sup>8</sup> The lacuna in Dio, lxxviii. 26, is to be supplied by a passage of Xiphilinus, not given in recent editions.

<sup>9</sup> Jost, *Geogr. d. Jud.*, ii. 139.

<sup>10</sup> See Mordtmann in *Z. f. Num.*, iv. 152 sq., vii. 40 sq.

native princes. Camnascires appears as an old man on coins of 82 and 81 A.C., and his ten successors whom we know from the coins carry us down to 36 A.D., the latest date at which the Elymans are mentioned as independent (Tac., *Ann.*, vi. 44). The older coins have Greek inscriptions and often figures of Greek gods, but under the fifth successor of Camnascires, i.e., about the time of Christ, Pahlavi takes the place of Greek and Mithras of Serapis.

The silver class, again, has in all three series Pahlavi legends and the fire-altar on the reverse. The first series has seven princes with the unexplained title "Feritkarā," the second has three kings (Malkā), the third ten kings; the names are throughout either Achæmenian (Artahabstr, Dāryav), pointing perhaps to a claim of Achæmenian descent, or sacred names like those common with the Sāsānians (Nereh, Yedikert), or are taken from sacred legend (Minúchetr). The second and third series appear to be continuous (against Mordtmann); the last king of the second series is Zatrdat (II.), the first of the third Dāryav (I.) son of Zatrdat. With Dāryav I. the kings assume a Parthian costume, and his son Artahabstr II. is the only king of that name who from the number and various types of his coins can be fairly identified with the Artaxerxes of Isidore of Charax, who reigned "in the time of his fathers" (c. 80-50 B.C.), and was slain at the age of ninety-three by his brother Goathres. As Dāryav I. must also have reigned for a considerable time this datum places him about the commencement of the Parthian supremacy, which naturally explains his Parthian dress. Then the princes of the first silver series will be Selucid vassals, and the shorter series of kings before Dāryav independent princes falling between the Selucid and Parthian suzerainty. Finally Goathres, brother of Artahabstr II., has the same name as Gōshir, the last Bāsrangi king before the rise of the Sāsānians, so that it was probably one dynasty. The eight kings, in at least six different generations, who appear on coins between Artahabstr II. and Yirdat II., will carry us roughly to the middle of the second Christian century, leaving a space sufficient for Gōshir, the last Bāsrangi, and the anarchy of the first days of the Sāsānians.

The emblems on the coins show that Persia was always loyally Zoroastrian, and at Istakhr stood the famous fire-temple of the goddess Anāhéth. Its priest was Sāsān, whose marriage with a Bāsrangi princess, Rāmbehānt, laid the foundation of the greatness of his house, while priestly influence, which was very strong, doubtless favoured its rise. Pābak, son of Sāsān, and Ardaahštr, son of Pābak, begin the history of the Sāsānian dynasty, which occupies the next section of this article. Artabanus did nothing to check the use of the new power till Ardaahštr had all Persia in his hand (224) and had begun to erect a palace and temple at Gōr (Firuzabad). Nirofār, king of Elymais, was then sent against him, but was defeated, and now Ardaahštr passed beyond Persia and successively reduced Ispahan (Parstacene), Ahwas (Elymais), and Mesene.<sup>1</sup> After this victory Ardaahštr sent a challenge to Artabanus himself; their armies met by appointment in the plain of Hormisdžān, and Artabanus fell (28th April 227). Ctesiphon and Babylonia must have fallen not much later, though Volagases V. seems to have re-established himself there on his brother's death, and a tetradrachm of 539 Sel. shows that he held the city till autumn 227. The conquest of Assyria and great part of Media and Parthia is assigned by Dio expressly or by implication to the year 228, and so the Parthian empire was at an end.

The part of Parthia of which Dio speaks can only be Choarene and Comisene; it was only in a later expedition that Ardaahštr reached Socastana, Hyrcania, Nihapur, and Merv, and these do not seem to have been Parthian. Indeed, from 58 A.D. Comisene appears to have been the most eastern satrapy of the Arsacid empire. Eastern Iran was in this period very flourishing under the Tochari of the dynasty which Indian sources call Turashka, and which can be traced on inscriptions till 218 and 259 (or 359). Kanishka, the founder of the dynasty, is said to have ruled Cabul and all Hindustan, and in fact his coins extend over all northern India. The empire of which Kashmir was a main province was wider than that of the Greeks had been, and also more consolidated, for strategoi took the place of the native kings (*Journ. As.*, ser. 2, viii. 264, and ser. 4, x. 26). So,

<sup>1</sup> The flourishing state of Mesene had, as its coins show, been long sinking into barbarism; the latest date they supply is 167 (*J. J. Nees*, viii. 213 sq.). A little earlier, in 148, they are associated with coins of Mersedates, son of Phobas, king of the Omanians. The latter, already known to Pliny as dwelling in the desert west of Charax, must be the Ad from 'Omān, a part of whom shared the great migration and finally settled in Anbar and Hira.

too, Kanishka banished the native language from his coins, using Greek letters and his own foreign language. His predecessor had supplanted the Greek god, except Helios, by Oriental divinities, and now Helios too gives way to the Iranian *Muso* or *Maso*. The motley pantheon on the coins of Kanishka and his successors gives an interesting glimpse of the faiths of the Indo-Iranian frontier. We find here the old Iranian popular deities: *Mao*, the moon-god; *Muso*, the sun-god; *Nere*, the goddess of war; *Osse*, the wind-god; *Orharye*, i.e., Vārethraghno (see Behrens, *E. D. M. G.*, viii. 459); *Apa*, identical with the Zoroastrian Ahura-mazda; we find also abstractions like the *Iseds* of the heavenly hierarchy in official Zoroastrianism, e.g., *Orp*, i.e., Aniran, the eternal self-created light, and *Spas* (Pers., *farr*); synonymous with *Zand*, *Asaršās*, the royal majesty, side by side with Indian deities, such as Siva, and a number of unknown deities with barbarous names brought from the old homes of the Tochari. Hercules and Helios appear transformed by barbarous pronunciation or epithets, and *Zapare* is the cosmopolitan Serapis, probably introduced, as in Elymais, by Alexandrian sailors. Buddha, too, appears (Sallet, *Nachr. Al.*, p. 189 sq.). The Buddhists were the most active religious body in the kingdom, and the king, if not actually a convert, as the legend claims, showed them such favor as gave their faith a wide missionary field and unparalleled success. The kings built many Buddhist meeting-houses, monasteries, and shrines, and it was Kanishka who called together in Kashmir the council of 500 fathers that finally redacted the Tripitaka collection. Ptolemy (viii. 1, 47) speaks of Tochari as the *Kaeropsia*; the Chinese bear witness to their might in 159; and from 230 to 265 their empire retained its old compass (*Journ. As.*, ser. 2, viii. 268, 269). Kashmir was lost in the course of the 3d century, but the western provinces remained. About 100 A.D. Greek ceased to be understood in east Iran, and from this time we can trace a growing Iranian influence on the coins of the Tochari, especially in the Sāsānian period. The latest coins of the Tochari come mostly from Balkh, so that they seem to have been gradually pushed backwards to the point from which they started. Finally, their empire was overthrown by another branch of their own race, for, early in the 5th century, those of the Great Yue-chi who had remained in their old homes, a little west of Badakhshan, were compelled, by the pressure of the Juan-juan of Tartary, to move west to Po-lo or Balkh, and thence, under their warlike king Ki-to-lo (Kidara; whence they are called Cidaritis Huns by Pricus, in *Fr. H. Gr.*, iv. 102), crossed the Hindu-Kush and destroyed the old empire of the Tochari, founding in its place the kingdom of the Little Yue-chi. The date of this invasion can, from a variety of data, be fixed as c. 430, just about the time when the Sāsānians, in 429, destroyed the last of the Arsacids in Armenia; and with this agrees the Indian statement that eighteen Caka kings reigned 380 years (50-430 A.D.). Their successors were still powerful in India about 530, and in their old homes their empire fell in 562.

**Sources.**—1. FOR THE MACEDONIAN PERIOD.—For Alexander the sources are of two classes. (1) Arrian, and for the most part Plutarch also, draw from official Macedonian sources, especially the works of King Ptolemy and Arrian of Cassandria. (2) An unofficial history, written by a Greek citizen of the Greeks, is faithfully excerpted by Diodorus. Curtius and Justin (or rather Trogus) draw from a later work based on the same source but supplemented by extracts from a book of the first class and another book hostile to Alexander and of very indifferent authority. Droysen follows the writings of the first class exclusively, and indeed for military and historical points they alone are to be trusted. Grote uses also the works of the second class, which, though rhetorical, romantic, and uncritical, have the advantage of telling us many things that the official histories pass over, and, though they show little judgment themselves, are rich in materials to guide our judgment. The historian must deal with the material as a philologist would deal with a book preserved in two classes of MSS., one good, the other interpolated but independent. One must first restore as nearly as may be the archetype of the second class and then use it to correct the text—or here the history—based on the first class. For the immediate successors of Alexander, Diodorus, the excerpts from Arrian in Photius, and Plutarch's lives of Eumenes and Demetrius are our best guides, all three drawing from the excellent Hieronymus of Cardia. Trogus (Justin) makes a defective use of indifferent sources, and is good for India. Droysen's is the best modern book; Grote is useful because he does not take a purely Macedonian standpoint, but he deals mainly with the West. We have no really continuous ancient account for 301-230 B.C., for Justin's narrative is even less worthy of the name of a history than in the preceding period. The scattered material is best collected by Droysen. From 230 onwards we have the excellent work of Polybius, at first complete and then in large excerpts. There are some good modern monographs, but nothing that can be called even a tolerable general history of the latest period of Macedonian rule in Asia.

2. FOR THE PARTHIAN PERIOD.—The only continuous account of Parthian and Bactrian history which has reached us is Justin's abridgment of Trogus Pompeianus, ending with 9 A.C., and having also a lacuna, due to Justin's carelessness, between 94 and 55 A.C. For the wars with Rome in 58 and 53 A.C., Plutarch's *Crassus* and *Antonius* give full accounts. Under the early Caesars the Parthians were, in a sense, viewed as sharing the empire of the world with Rome (Strabo, vi. p. 218; Just., xii. l. 1), and Roman historians began to refer to notable events in Parthian history which had no direct connection with Rome affairs. Thus, from 69 A.C. to 73 A.D., Josephus, and Tacitus give us pretty complete accounts. Between 73 and 69 A.C. and between 73 and 227 A.D. the history is very much lost. The coins are most valuable, especially after 57 A.C., when they begin to be dated; for the later period they are our chief aid, the accounts from Dio not helping us much.

*Atlas*—Foy Valentin, *Aræodorum imperium* (Paris, 1798), and De Four de Longueville, *Aræodorum Imperium* (Geneva, 1792), are still indispensable complements to which G. E. J. Guilielmi de Silesio, *Crat.*, "M. A. ser. in generalis de Parthis," *Mém. de l'Acad.*, l. 48 sq., 736 sq., gives a good supplement. The most important modern books are those that explain the coins historically—

E. C. Visconti, *Icon. Gr.*, III.; Bartholomæi, "Rech. sur la num. Arac." *Mém. Soc. Arch.*, II.; A. de Longpérier, *Mém. sur la chron. et l'iconogr. des rois Parthes Arac.* (Paris, 1855)—and the catalogues of coins in Prokesch-Osten's *Monnaies des rois Parthes* (Paris, 1874-75) and F. Gardner's *Parthian Coins* (London, 1877). There are also recent histories of Parthia by Rawlinson, Schellererich, and Eysenck, and a book on the coins by Lindsay. As regards Bactria *Baktria's History* (Petersb., 1788) is poor, and quite upset by recent finds of coins. The Chinese material is still best given by Deguignes in *Mém. de l'Acad.*, xv. 17 sq. Of recent books see H. H. Wilson, *Artiana Antiqua* (London, 1841); Lassen, *Sur l'Éch. der Orienk. und Indostath. Künste* (Bonn, 1828) and *Ind. Alterthumsk.*, II. The best works on the coins are by Thomas, in his edition of *Crusop. Essays on Ind. Antiquities*, II. 173 sq.; A. Cunningham, in *Numb. Chron.*, vols. viii.-xii.; and Sallet, *Nachträge Alexanders des Gr. in Baktrien und Indien* (Berlin, 1878). (A. V. G.)

### SECTION III.—SÁSÁNIAN EMPIRE.

Of the minor kings who ruled in Persia, in the Arsacid period, in real or nominal allegiance to the Parthian "king of kings" we know some names from coins or ancient writers, but we cannot tell whether they were all of one dynasty. In the beginning of the 3d century the kings, who then belonged to a dynasty of which the name probably was Bázrangik, had lost much of their power; lesser potentates ruled in various parts of the land, which, by being all mountainous, falls naturally into ill-connected sections. One of these local princes was Pápak, or, in the more modern pronunciation, Pábak,<sup>1</sup> son or descendant of Sásán, a native of the village of Khír on the southern margin of the great salt lake east of Shíráz. Pábak overthrew Góáhr, the last prince of the Bázrangik, and became master of the district of Istakhr (Persepolis), and the coins and inscriptions of his son give him the title of king. His legitimate heir was his son Shápúr, for whom Pábak is said to have asked recognition from the Arsacids; but on Pábak's death a second son, Ardashír, refused to acknowledge his brother, and was in arms against him when Shápúr died suddenly, and hardly by mere accident. That Ardashír's claims were opposed by his brothers and that he put them to death are not to be doubted, as we have these facts from a tradition of strictly legitimist tendency.

Tradition names various local princes conquered by Ardashír for himself or for his father, and perhaps Pábak before his death was already lord of all Persia. Ardashír, at least presumably, was so when he struck the coins still extant.<sup>2</sup> Ardashír, who is to the Sásánian what Cyrus was to the Achaemenian empire, probably came to the throne in 211/212 A.D.<sup>3</sup> From the first he plainly leaned on the clergy of the Zoroastrian faith, which all through the Macedonian and Parthian eras had undoubtedly continued to be the religion of the people in Irán proper, and especially in Persia. The Parthian monarchs were Zoroastrians, but probably often very lukewarm in the faith. Ardashír, on the contrary, ostentatiously placed symbols of fire-worship on his coins, and on his inscriptions boasts himself a "Mazdayasn," or orthodox Zoroastrian. From his days onward the often fanatical and persecuting clergy enjoyed great power in the Sásánian empire, and the hierarchical organization of the state church, so similar to that of the Christian clergy, probably dates from Ardashír; it is referred to, at least, on the inscriptions of his immediate successors. Popularity and a certain religious prestige were the natural fruits of this orthodox zeal on the part of Ardashír, but his success was essentially the fruit of his energy and

<sup>1</sup> The Arabs, having no *p*, pronounce Bábak; but this is not Persian. In general the forms of proper names followed in this article give the more recent pronunciation, which may have prevailed about the end of the Sásánian period.

<sup>2</sup> These show a full-face portrait with the legend "Artakshahar king." The reverse has his father's portrait in profile with the legend "son of the divine Pápak." The older form of Ardashír's name, Artakshahar, is the ancient Achaemenian name, which the Greeks write Artaxerxes, and which, singularly enough (together with the name Darius, Dáryáv, Dáráb, Dárá), had survived in the home of the Achaemenians, although genuine Persian tradition had lost all memory of the old empire.

<sup>3</sup> See A. v. Gutschmid, in *J. D. M. G.*, xxxiv. 734.

valour. Slowly and not without toil he rose from king of Persia to be king of the kings of Irán. He began by subduing successively Kirmán, Susiana, and the petty states at the mouth of the Tigris. But after this he came into conflict with the great king, whom, according to the contemporary account of Dio Cassius, he smote in three battles. The decisive engagement with Ardáván (Artabanus) in which the last Parthian monarch fell, and where Ardashír gained the title of "king of kings," seems to have been on 28th April 224 (or 227, according to A. v. Gutschmid), and was probably fought in Babylonia or Susiana, for the next enterprise of Ardashír was an unsuccessful attack on the strong walls of Hátza, which perhaps was not taken and destroyed till the reign of his successor. Ardashír conquered Media, where an Arsacid prince was his adversary, and gained the greater part of the Iránian highlands, but failed in Armenia, whither a son of Ardáván had fled.

The Romans saw with concern the rise of a prince who already directed his aims against their Asiatic possessions, and seems to have had some success in this quarter, till in 233 he was smitten by Alexander Severus in a great battle.<sup>4</sup> Henceforth, though peace was often made between the two powers, they remained constant rivals,—and rivals on equal terms, for, though under able rulers and when the inner condition of the empire was not greatly disturbed, the Europeans of Rome or Byzantium were still too strong for the Asiatics, the tables were not seldom turned, and Rome sustained many a shameful defeat. This struggle fills the chief place in the political history of the Sásánians; and the inner development of the empire, its martial and political institutions, its art and industry, were also most powerfully influenced by the superior civilization of the West.

The nominal capital was always at Istakhr, where, for example, the holy "pyreum" of the royal house stood, and where the heads of conquered foreign kings were hung up. But the real metropolis was the Arsacid capital of Ctesiphon, with Ardashír's new foundation of Veh-Ardashír, just across the Tigris on the site of the old Seleucia. The rich alluvial land that surrounded these twin cities was no part of Irán proper, and its inhabitants were mainly Semites; but old example, and probably its vicinity to Roman soil, marked it out for the true seat of government.

The extent of the empire at the time of Ardashír's death is uncertain, for the national tradition ascribes to him some conquests that were really made by his successors, and others which the Sásánians never made at all. Shápúr, his son, calls himself on his inscriptions king of the kings of Irán and non-Irán, where his father says only "of Irán"; so that it was the son who first extended the realm beyond the bounds of what was then known as Irán. Non-Irán may refer to districts in the far East, where, however, the Sásánian power never reached so far as that of the Achaemenians, and it may also include Armenia. At any rate, Ardashír won a great empire and consolidated it, so that it held together for four centuries. He gave a powerful blow to the system of vassal states, which had become more and more prevalent under the Arsacids, and reduced most of these states to provinces. In this sense he is justly viewed by tradition as the restorer of the unity of Irán;<sup>5</sup> but the

<sup>4</sup> Lampridius, *Al. Sev.*, 56. His statement rests on documentary evidence, and is accepted by Tillemont and by Clinton, who confirms it from coins. The attachment of the troops from Orrhoens for Alexander (Captol., *Maximianus*, II.) was probably connected with his liberation of their country from the Persians. Rawlinson's and Spiegel's preference for the statement of the romancer Herodian, that the Persians were the victors, is pseudo-criticism.

<sup>5</sup> It must not be supposed that the Persians had a clear recollection of the might and breadth of the Achaemenian empire, though Western writers, who knew the old history from books, sometimes make Persians speak as if they shared in that knowledge. No doubt a Sásánian would sometimes hear from a Greek or Syrian how his predecessors

unity, of course, was not such as in a modern European state. The great barons in particular were still very powerful, and were more than once a danger to the kings. At bottom they were a continuation of the Parthian nobility, falling into divers classes, headed, as in the Achæmenian empire, by the seven noblest houses. There was also a numerous minor nobility. Later generations looked back upon the founder of the empire as the best of lawgivers and the ideal monarch; and, of course, so great a patron of Zoroastrianism left a high reputation for piety. A man of mark he certainly was, but the fratricide that opened his reign, and such a barbarity as tradition itself relates of his conduct to the conquered Ardaván, whose head he spurned with his feet, show him to have been very far from a pattern character. It is interesting to find his memory intertwined with similar romantic legends to those told of Cyrus. He was born of (we are told) a mean father, and lived as a page at the court of Ardaván, as Cyrus lived at that of Astyages, and so forth. Dreams and portents figure in the later as in the earlier legend, and even a mythical conflict with a dragon is recounted.<sup>1</sup> Fortunately a much more historical picture has been preserved by genuine tradition.

Ardashír is said to have adopted his son Shápúr as partner of his throne, and this is confirmed by coins on which a youthful head appears along with Ardashír's likeness. He died late in 241 or early in 242. Shápúr I. (older form *Shahpúr*; Sapor or Sapoires of the Westerns) was probably crowned on 20th Mách 242. Legendary tradition makes his mother an Arsacid princess taken at the capture of Ctesiphon; but, according to a more probable account, Shápúr was already able to bear arms in the decisive battle with Ardaván. Nor can he have been a mere stripling when his reign began, as his prowess against Rome shows; for in Ardashír's last years, in the reign of Maximin (236-238), the war had been renewed, and Nisibis and Carrhæ (Haran), two fortresses which constantly reappear in this history, had been taken. In 242 Shápúr had penetrated to Antioch, before Gordian III., or rather his father-in-law Timesitheus, drove him back and retook the Mesopotamian strongholds. The Persians were defeated at Réhainá, and Gordian proposed to march on the capital by way of the Euphrates, as Julian subsequently did; when almost on the frontier, a little below the junction of the Euphrates and Chaboras, he was murdered by Philip the Arab (244), who concluded a humiliating peace with Shápúr, and is said—for the details are obscure—to have given up to him Armenia and Mesopotamia. Our whole knowledge of the Perso-Roman wars in the 3d century is very defective; but there seems now to have been a lull for some years, till in 251 or 252 Shápúr again was in motion, now at length effecting an occupation of Armenia and compelling its king to flee to Roman soil. The Roman world was at this period so shaken that Syria was again and again invaded,—how often we can hardly say; nay, a Syrian, Cyriades, himself led the Persians to Antioch and assumed the purple under their protection. At last the emperor Valerian took the field in person; but, after protracted operations in Mesopotamia, fortune turned against the Romans and Valerian himself became Shápúr's captive (260), under unknown circumstances, and, according to

had reigned as far as Constantinople, but this was not living tradition. Western scholars again sometimes mixed up the old and the new state, as when Libanius supposes that Susa, the residence of Xerxes and Artaxerxes, must also be the residence of his contemporary Sapor (Shápúr). The Sásánians, however, regarded themselves as successors of the mythical kings of Irán.

<sup>1</sup> An abridged extract of the romantic history of Ardashír has been preserved in the original Pahlavi, and has been published by Nöldeke (see p. 135, note 1, above). The same legendary material is used by Firdausi; cp. also *E. D. M. G.*, xxxiv. 585, 599.

Roman accounts, through treachery, but certainly not till he had entered into negotiations and vainly sought to purchase a free retreat for his army with gold. Shápúr now penetrated with an invading host far into Roman territory towards Asia Minor, but he met with not unsuccessful opposition. The general Ballista cut off many Persians; but a heavier blow was struck by Odsenathus at the head of his Palmyrenes, who, in this or a subsequent campaign, smote the retreating Persians and even captured the royal harem; nay, once, if not twice, he laid siege to Ctesiphon itself (for details see PALMYRA). Presumably now as in later times the Persian empire proved unable to sustain the cost of prolonged campaigns. These Oriental kingdoms are on the whole poor, though they include some fertile regions, and though the kings accumulate large stores of treasure. The Persians had no great standing army like the Romans, and the levies summoned to the standard could not long be kept together; hence so many brilliant débuts in warfare without lasting result. Shápúr effected no permanent gain of territory, for even Armenia seems now to have fallen again under Roman suzerainty.<sup>2</sup> But Valerian was not delivered, and died in captivity. The figures of the victorious king and the captive Cæsar are still to be seen hewn, perhaps by Roman subjects, on the rocks of Persia, and Persian tradition, which preserves so few historical facts as to the immediate successors of Ardashír, has not forgotten this crowning humiliation of Rome. Some of the traditional deeds of Shápúr I. really belong to Shápúr II., but we may accept him as the author of the great irrigation works at Shúshtar, and it was he who built Gúndév Shápúr (Ar. Jundai-Sábur; Syr. Bêth Lápát), which was often used by the kings as their second residence, and stood to Ctesiphon as its neighbour Susa in Achæmenian times did to Babylon. Shápúr's sway over non-Iránian peoples has been already referred to; but the Augustan historians are certainly right in speaking of the Bactrians as a nation still independent and often hostile to Persia, and the same is true of the Cadusians (Pollio, *Val.*, ch. i.), i. e., the Délamites of Ghán, who were never subdued by the Sásánians. At the very beginning of Shápúr's reign Mani, founder of the Manichæan sect (see MANICHÆISM), began to preach, against which the Persian priests fought for centuries as vigorously as against the various sections of Nicene Christians.

The close of Shápúr's reign saw great changes in the Roman east (see PALMYRA). At the fall of Palmyra Shápúr was probably no longer alive. His son Hormizd (*Ormizd*) I. came to the throne in 272 or 273, having previously been governor of Khorásán. His title, "the hero," appears to have been gained by prowess against the Romans before his accession, for his reign of one year gave little time for great deeds.

His successor, Bahrám (*Vahhrám*) I., was not his son as tradition represents, but, according to an inscription, his brother. He is said to have been a weak prince, given to pleasure. The execution of Mani falls within his reign, which (subject to a possible error of as much as two years, which affects all dates of reigns between Bahrám I. and Shápúr II.) may be dated between 274 and 277.

Of his son, Bahrám II. (c. 277-294), Persian tradition has next to nothing to tell. To him may be probably ascribed two long but ill-preserved inscriptions, religious in content, almost sermonizing, and of very clerical colour. He had wars with Rome, of which we only know that they were terminated by a peace with Probus (276-282),<sup>3</sup> and that Probus was murdered before he could renew the con-

<sup>2</sup> See an essay by Gutshmid, *E. D. M. G.*, xxxi. 51, which is instructive as to the relations between Persia and Armenia generally.

<sup>3</sup> Vopiscus, *Probus*, 17, who, as Tillemont remarks, wrongly puts "Narsesus" for "Bahrám."

fict. Carus, however, in 283 led his army as far as the hostile capital, and had taken Ctesiphon and Coche (a part of Seleucia) when he suddenly died (by lightning, it is said), and the Romans drew off. Carus is said to have been favoured by intestine disorders, which at this period were certainly common in Persia. In 291 a rhetorician mentions the rebellion of a certain Hormizd (Ormies) against his brother the king, in alliance with barbarians.

A youthful son, who appears opposite the queen on coins of Bahrám II., seems never to have ascended the throne, which was probably contested between Bahrám III. (a son of Hormizd I.) and Narseh (according to an inscription, son of Shápúr I.). Bahrám III., called Sagán Sháh, because he had been governor of Sagastán (Sástan), reigned, or at least held the capital, for a very short time; Narseh reigned from c. 293 to 303, and, following up Shápúr's policy, occupied Armenia and defeated Galerius (probably in 297) between Carrhæ and Callinicus (Rakka) in Mesopotamia. But under Diocletian's wise rule Galerius soon restored the honour of the Roman arms, totally defeating Narseh in Armenia and taking his wives and children. A brilliant peace (298) rewarded the victors; to recover his family the Persian ceded Armenia and Mesopotamia, and even some districts east of the Tigris as far as Kurdistan. The peace lasted forty years.

Narseh's son, Hormizd II., came to the throne about 303 and was succeeded early in 310 by his son, Ádharnarseh, who was soon deposed, and probably slain, ostensibly for his cruelty. The nobles now held the reins of power, and, having blinded one brother of the fallen king and imprisoned another (Hormizd),<sup>1</sup> crowned Shápúr II., the newborn (or unborn) son of Queen Ifrá (¶) Hormizd (310). The rule of the queen-mother and nobles was what may be readily imagined in an Oriental empire, which above all things needs a strong man at the head; but such a man young Shápúr, one of the greatest princes of the dynasty, soon proved himself to be. Persian tradition preserves few really historical notices of Shápúr II., but is full of stories of astounding campaigns against the Arabs, highly coloured by hatred of that race; and there is no doubt that Shápúr did devote himself with energy to the always important task of repelling the plundering Bedouins from the civilized lands on which their deserts border. Another notable undertaking was the new foundation of Susa after it had rebelled and been chastised by total demolition, the very ground being stamped down by the king's elephants. Νίσίρτις (*q. v.*), i. e., *Nís-sháhpúr*, may be his foundation, or that of Shápúr I.

In Shápúr's youth fell the victory of Roman Christianity over paganism under Constantine, and the Christians of Persia at once threw in their sympathies with the Christian state. These feelings were openly shown when Shápúr in 337 or 338 began a Roman war, as appears in a homily of the Syrian bishop Aphraates, a subject of Persia. The bishop of the capital, too, ventured to use language against the king which no Oriental prince, least of all one like Shápúr, could submit to. And so almost simultaneously with the Roman war a terrible persecution of the Christians broke out (339/340), of which the Syrian *Acts of Persian Martyrs* give a lively picture,—instructive, too, for the light cast on persons and affairs in the realm. Shápúr was no fanatic, as even the *Acts* of the martyrs show, and he did not molest the Jews, whom his priests hated quite as much as the Christians. But, like Diocletian, he wished to destroy the organization of the church, and therefore used the utmost rigour against the lower as well as the higher clergy, and destroyed the ecclesiastical

buildings. To break up congregations he often constrained prominent church members to stone their own priests. The Persian priests, of course, used the opportunity to gratify their hatred of the Christians, and other impure passions increased the cruelty of Shápúr's hard measures. The Christians on their part showed much heroic courage mixed with not a little cowardice.

Roman sources tell us that the war was begun by the Persians with an invasion of Mesopotamia. Constantine died on 22d May 337, before he could march against them. But Shápúr's great preparations, as we learn from Aphraates, fell in the year that begins with autumn 337. With many vicissitudes and long pauses the war endured for twenty-five years, but only for its second part do we possess fuller accounts by contemporaries and in part eye-witnesses. Shápúr's aim was to drive the Romans from the upper Tigris, where they were dangerously near Ctesiphon, and especially to seize Nisibis, and then to reduce Armenia, that old apple of discord between East and West. Three times Nisibis victoriously resisted a severe siege (338, 346, 350), and other sieges occupy a great place in the story of the war. Constantius, when he took the field in person, was always defeated, as in 348 at the great battle of Singara (Shingár, Ar. Sínjár). Yet Shápúr's successes bore little fruit, mainly perhaps because Diocletian and Constantine had put the fortresses in the best condition, and in all respects had made wise provisions to cover the threatened districts. Even when victorious the Persians could hardly penetrate into western Mesopotamia, and if Shápúr had taken all the strong places he could hardly have garrisoned them. Thus he took Amida (Ámid) after long and costly sieges, and in the very next year (360) the Romans found it ungarrisoned. The Romans were helped, too, by the trouble which Shápúr had with barbarous enemies; the third siege of Nisibis was all but successful when the Persian was called away to Khorásán by urgent affairs there. These eastern conflicts were the prelude to a long pause in the contest (350-358), broken only by small forays. When, however, the Romans opened negotiations (356 to 358) Shápúr had made peace in the east and offered no conditions that could be accepted. In 359 and 360 the war was again hotly renewed, and Shápúr took several important fortresses. Then there was a lull till 363, when the warlike, active, and ambitious Julian, now sole emperor, resolved to strike at the capital of the enemy, as Trajan, Severus, and Carus had done. He left Antioch for Mesopotamia in March and swiftly descended the Euphrates, wasting the enemy's land with fire and sword and taking several cities by short sieges, among others the royal city of Máhós Malká, not far from Ctesiphon. Julian now occupied Seleucia, but, finding he was not strong enough to take Ctesiphon, the fortified capital on the opposite bank of the Tigris, he ordered a retreat along the left bank. And now for the first time Shápúr's troops began to harass him, but the army might have regained Roman soil without serious loss had not Julian fallen mortally wounded in a skirmish (28th June 363). The army chose Jovian emperor, a man too weak for such an occasion, who managed his soldiers and the negotiations so badly that a shameful peace was the result, and Shápúr regained the lands east of the Tigris lost to Galerius, and part of Mesopotamia with Nisibis and Singara. Nisibis was the gravest loss, for in all future wars it was to the Persians a sure base for advance and a bulwark for defence. But a still more shameful condition was that the Romans should not help their ally Arsaces of Armenia against Shápúr. The Persian, nevertheless, did not find Armenia an easy conquest. He took Arsaces captive, but this did not decide the fate of the whole country, divided as it was by nature into a number of separate regions under almost independent

<sup>1</sup> Hormizd escaped to the Romans in 323 and remained with them all his life. As late as 368 he shared the Roman campaign against his half-brother Shápúr.

captains. The Christian Armenians leaned on the whole towards Rome, while the Zoroastrians, who still formed a large part of the nation, inclined to Persia, and the personal interests of the great barons, who preferred to recognize no lord, inclined them now to this side, now to that. Pape, son of Arsaces, fled to the Romans and got help from them, first secretly and then openly; but he was only their tool in the design of reducing Armenia to a province. Conflicts between the rival empires took place also to the north of Armenia in Iberia, and after five years they were practically again at war. In 371 Shápúr was openly met by Roman troops in Armenia, which both parties were determined to have by force or by fraud. Once and again negotiations failed, but a general war was still averted by external circumstances (on Rome's part by the Gothic war) and considerations of prudence.

Shápúr II., who is justly celebrated by the later traditions, died towards the end of the summer of 379, and was succeeded by his brother, Ardaahír II., an old man, who was perhaps chosen king for similar reasons to those which governed the choice of Shápúr as an infant. As prince and governor of Adiabene Ardaahír had taken an active part in the suppression of Christianity in 344 and as late as 376, but with his accession the persecution ceased—whether of purpose or merely from the Oriental lack of persistency we cannot tell—and a bishop was again admitted even in the capital. Ardaahír was deposed in 383 or 384, having taken strong measures against the nobles and put some of them to death.

His successor, Shápúr III., son of Shápúr II., at once sent ambassadors to Constantinople and made a definite treaty of peace (384). In 388 or 389 he was murdered by the nobles. His successor (a son, or perhaps a brother), Bahrám IV., called Kirmán Sháh,<sup>1</sup> kept peace with Rome and was clement to the Christians. In 390 Armenia was divided by treaty, much the larger part becoming a vassal state of Persia and the rest falling to Rome. The division, with various modifications and vicissitudes, lasted into Arab times. Bahrám was shot by a band of "miscreants" in the summer of 399.

Yasdegerd I., son of Shápúr II. or Shápúr III., seems to have been designated heir to the throne while Bahrám IV. was still alive, or at least he held such high dignity that his name appears on coins of his predecessor. Persian tradition makes him wise but very wicked. Christian witnesses, on the other hand, speak very favourably of him, and it appears certain that his surname, "the Sinner," was gained by a severity, perhaps tyrannical, towards the grandees, by tolerance towards the Christians, and little favour shown to the priests. In 410 the Christians were even allowed to hold a regularly constituted synod in the capital, and the king employed the "Catholicus"—i.e., the primate of the church, a functionary possessed of full religious autonomy—on a mission to the emperor, and even in settling differences with his own brother, who governed Persia. Yasdegerd had no personal inclination towards Christianity, and he severely punished the fanaticism of Bishop Abdá, who had insulted a Zoroastrian sanctuary in Susiana, but his habitual tolerance was enough to make him hated of the Persian priests. The warlike nobles also found cause for dissatisfaction in his earnest endeavours to keep on quiet terms with Rome, with whom he made a treaty of peace and friendship in the summer of 408, when he seems to have pledged himself to support the throne of Theodosius II. during his minority. Over Persian Armenia he set his own son Shápúr. We have every reason to deem Yasdegerd an excellent prince for the time and circumstances, but he was not well pleasing to the god of the

Persians, who smote him with sudden and miraculous death in distant Hyrcania. The explanation of the miracle is no doubt that he was murdered by the magnates (probably late in summer 420).

Shápúr, hurrying from Armenia on the news of his father's death, was slain by the grandees, who had resolved altogether to exclude from the throne the seed of the hated Yasdegerd. A distant relation, Khosrau, was made king, but had to contest the throne with another son of Yasdegerd, Bahrám, who in his father's lifetime had dwelt apparently in a sort of exile, with the powerful vassal prince Al-Mondhir (Alamundaros) of Híra, on the borders of the desert to the west of the Euphrates. Mondhir energetically supported the claims of his guest-friend, and appeared with a vast Arab horde before the gates of Ctesiphon, which is only three or four days' march from Híra. As Bahrám doubtless had support among the Persians also, Khosrau gave way, and Bahrám took the throne, but with a promise to reign in a different spirit from his father and please the magnates and the priests. This is the first important intervention of the Arabs in the affairs of Persia.

Bahrám V., surnamed Gó or Wildas, is the favourite hero of Persian tradition, which tells many incredible stories about him. He came to the throne young, and was always a jolly prince, very fond of women, and whose personal strength and prowess as a huntaman, perhaps also in war, blinded men's eyes to the real weakness of his sway. The change of policy was at once announced in a systematic persecution of the Christians and in war with Rome. For the latter there were pretexts enough on both sides, but the Romans would not have begun the war merely because the Christians were persecuted; its real authors were presumably the Persian nobles. The chief seat of war was the north of Persian Mesopotamia and the mountain-land above. The Persians were led by one of the greatest nobles, Mihr Narseh, whom Persian tradition represents as taking Constantinople, while we know that he really sustained heavy defeat at the very commencement of the war (August 421). Nisibis was attacked by the Romans, but relieved after a siege of some length. In 422 both parties were glad to make peace; religious freedom was given to Christians in Persia and to Zoroastrians in the Roman empire. There seems to have been no change of frontier, but the Romans promised to receive no Arabs who wished to change their allegiance,<sup>2</sup> and to pay an annual sum towards the maintenance of the defences of the Caucasian Gates (the pass of Dariel), which protected both powers from the inroads of the northern barbarians. This last condition reappears in almost all treaties and always caused soreness. For, however carefully the provision was worded, both sides looked on the contribution as a tribute, of which the Romans evaded payment whenever they could.

The Persians, we may suppose, were the readier to make peace that they were again embroiled with the nation of Kúshán or Hailál, the Hephthalites or "white Huns," who then ruled in Bactria and the surrounding lands. Constant wars of Persia with this people went on during the 5th century and gave the Romans repose, and we are hardly bound to believe the Persian tradition that Bahrám had a glorious victory over the Hephthalites. A movement for freedom had taken place in Persia Armenia during the Roman war; but after the peace Bahrám established a new vassal king, till in 429 the conduct of the selfish Armenian nobles led the Persians

<sup>1</sup> He had ruled in Kirmán, and from him two towns, in Kurdistan and in Kirmán, take the name Kirmánsháhn.

<sup>2</sup> The Bedouin tribes, "nec amici nobis unquam nec hostes optandi" (Amman., xiv. 4, 1), and the petty states that had been formed out of them, under Roman or Persian suzerainty, were a constant trouble to both empires in war and in peace.



to make Armenia a province,—a change which was supported by a strong party among the Armenians themselves. But the Persian governors had as much trouble with barons and clergy as the old kings had had.

Bahrám, dying in 438 or 439, was succeeded by his son, Yazdegerd II., of whom little good can be said. He persecuted both Jews and Christians, abolished the audiences on the first day of each month on which every man of position could approach the king with petitions or complaints, and is recorded to have married his daughter (that, of course, was no crime in a Zoroastrian) and then murdered her.

In 441 he very nearly came to war with Rome, but peace was concluded without further conflict than some harrying of the marches, and it was provided (as in later and probably in earlier treaties) that no new fortresses should be erected on the border by either party. Yazdegerd was much in Khorásán, where he sustained repeated defeats from the Hephthalites; and in 450/451 he had to deal with a serious rebellion in Armenia, mainly produced by persecution of the Christians, which was not quelled till he promised complete freedom of Christian worship.

On the death of Yazdegerd II. (457) the throne was for two years contested between his two sons by Dínak—Hormizd, prince-governor of Sagastán, and Péróz. The latter, who was the younger, proved successful by aid of the Hephthalites and the energy of Rahám of the house of Mihrán, and put his brother and three others of the nearest royal kin to death. Péróz was again a persecutor of Jews and Christians, but had political wisdom enough to favour the reception of Nestorianism by his Christian subjects when that party was driven from the Roman empire. At the synod of Béth Lápát (483 or 484) the old Christian church of Persia adopted the Nestorian confession, and was thus separated from Byzantium by a wide breach. But in truth Christianity in Persia had never been really much of a danger to the state.<sup>1</sup>

The Hephthalites and Péróz soon fell out about the reward for their services, and fierce fighting ensued, in which Péróz gained several victories; but the seat of war was a desert very unfavourable to his operations, and twice he had to make peace on disadvantageous terms, while at least once he was himself taken prisoner and released on heavy ransom, leaving his son Kavádh a hostage for its payment for the space of two years. But Péróz always broke faith again with the foe, and at length, in 484, he was among the missing after a terrible battle, in which his daughter was taken captive and placed in the harem of the Hephthalite king. The conquerors now overflowed Persia, which for a time was without a monarch till order was restored by Zarmihr, of the great house of Káren, who at the time of Péróz's death had been successfully dealing with a revolt in Armenia, and now hastened to the capital and made Balásh, Péróz's brother, king. The Hephthalites seem to have been bought off by a yearly tribute.<sup>2</sup> Balásh's brother, Zarah, who also claimed the crown, was vanquished and put to death. But the new king had little power, and secured the obedience of the Armenians only by granting that the Persian state religion should be wholly excluded from their land. The clemency of Balásh is praised by the Syrians and Armenians, possibly for no other reason than that his relations with the Persian priesthood were unfriendly. Their enmity proved fatal to him; his treasures were empty, so that he could neither

gain a party among the nobles nor secure the support of an army, and in 488 or 489 he was deposed and blinded.

His nephew and successor, Kavádh I., son of Péróz, found the land in a very disturbed state; there were rebellions among the barbarous mountain tribes and there was another rising in Armenia. Now Kavádh was not disposed to be the humble servant of the priests and nobles to whom he owed the crown, and to humiliate them he played the dangerous game of encouraging Mazdak, the energetic priest of a new religion, which demanded in the name of justice that he who had a superfluity of goods and several wives should impart to those who had none. This theory was actually put in practice to some considerable extent, but then the nobility and clergy rose, deposed Kavádh, and imprisoned him in the "Castle of Oblivion,"<sup>3</sup> placing his brother Jámásp on the throne (c. 496). But Kavádh escaped to the Hephthalites, where he had once lived as a hostage, received in marriage the daughter of the king (whose mother was the captive sister of Kavádh), and with his help expelled Jámásp and recovered his kingdom (498 or 499).<sup>4</sup> Kavádh held severe judgment on the traitors, and it was probably at this time that he gave up Zarmihr into the hands of his most dangerous rival, Shápúr of the house of Mihrán. He does not seem to have carried his Mazdakite experiment farther, and he had put the realm into fair order when he began a war with Rome.

Between Rome and Persia there had been such a series of negotiations and compacts, none of which had been scrupulously observed, that either side could find a *casus belli* at will. Kavádh had the will, and in summer 503 he opened that era of hideous strife between Rome and Persia which so exhausted both powers as to pave the way for the new empire of the Arabs. In August he seized without a fight Theodosiopolis (Karin, Erzerúm), capital of Roman Armenia. On 10th January 503 Amida fell after a siege of three months and was cruelly chastised for its resistance, tens of thousands of the inhabitants being put to the sword.<sup>5</sup> The Romans acted with little energy or unity of plan, and in the course of the war Mesopotamia suffered terribly. Amida was restored to the Romans by compact, or rather by purchase, after a long siege in 504; and after much fighting a peace was concluded in the autumn of 506, leaving things as they were before the war. The Persians, we are told, were ready for peace because they had on their hands a war with the "Huns,"—a very vague word in the mouth of a Greek. But Kavádh must have been in considerable difficulty, for he tamely submitted to a gross breach of the treaty when Anastasius raised the village of Dara to a great fortress to hold Nisibis in check. There was no more war while Anastasius was emperor, but Justin I. (518-527) seems to have ceased the payment for the Caucasian Gates again stipulated in the peace of 506, to which Kavádh replied by letting loose his Arabs on the empire, and the Romans retaliated by forays in Persian Armenia. There were also serious disputes about the suzerainty of the lands between Caucasus and Pontus, but Kavádh was still anxious to avert war, from which presumably he saw that no permanent advantage could flow. At the same time he was very eager to secure the succession for his favourite son, Khoerau, who was not his eldest; and he thought that if he could induce the emperor to adopt Khoerau as his own son this would form a sort of guarantee and greatly impress the Persians. A nego-

<sup>1</sup> Dínak's likeness is preserved on a gem; see B. Dorn, in *Comptes rendus de la Com. Arch. pour 1878, 1879*, p. 162 sq. (St. Petersburg).

<sup>2</sup> The Armenians, on the other hand, joined the Monophysites, who had a large party in the Roman empire and often had the upper hand there.

<sup>3</sup> Persian tradition makes Sôkhrá (i.e., Zarmihr) humble the enemy and compel them to restore their booty.

<sup>4</sup> Identified by Sir H. Rawlinson as Gúlgard in northern Ssiana.

<sup>5</sup> Kavádh's escape and restoration seem to have been favoured by some of the greatest nobles, and Persian tradition, which, however, is very confused in this whole chapter, makes Zarmihr the companion of his flight.

<sup>6</sup> Of this war we have good accounts in contemporary Syriac sources.

tion on this and other matters at Nisibis (525 or 526) seems, however, to have been badly managed on both sides, and its failure cost the Roman ambassador his place and the Persian his head. War now began on the borders in 527 before Justin's death (i.e., before 1st August).<sup>1</sup> A Roman attack on Nisibis and a Persian on Dara failed. Fighting, broken by negotiations, went on for several years, and in it Belisarius first came to the front as a general.

An important episode in this war is the invasion of Syria by Mondhir of Hira. This prince seems to have been more powerful than was safe for Persia, and Kavádih had stripped him of all or part of his possessions and given them to Hārith, a scion of the widespread house of the kings of the Kinda. When war broke out Mondhir, who was an experienced warrior, was restored to his old sway, and in 529 he fell on Syria, pillaging and holding captives to ransom as far as Antioch. Mondhir was a savage heathen, who on one day sacrificed 400 nuns of a Syrian cloister to his goddess 'Uzzá (the planet Venus). In the same year he slew Hārith in battle and executed in Hira a number of captives of the Kinda house. For half a century he was the terror of the subjects of Rome, little reckoning whether they were at peace or at war with his master, till in 554 he fell in battle with a Roman vassal, Hārith ibn Jabala, whose son he had also sacrificed to 'Uzzá.

Under Mondhir's influence Kavádih in 531 undertook a regular campaign against Syria, the first since centuries. The Persians crossed the Euphrates and had pressed far to the north when Belisarius compelled them to turn back. In a battle at Rakka Belisarius was defeated, but the Persians found it expedient to continue their retreat (19th April 531). In Mesopotamia the Persians were this year successful, and had almost reduced the great fortress of Martyropolis (Maiferka, Arab. Mayáfariqn) when news came of Kavádih's death, and a truce was made.

In 528 or 529 Kavádih, through his son Khosrau, had made a bloody end of the Mazdakites, whose success proved too dangerous to society to be longer endured.

Kavádih died, eighty-two years old, 13th September 531, and was succeeded by his destined heir, Khosrau (Chosroes), surnamed Anósharván, "the Blessed," whom his father is said to have caused to be crowned as he lay on his death-bed.<sup>2</sup> Khosrau I was a great king, and deserved the title of "the Just," though he was not the ideal prince that Eastern writers make him. By carrying out the regulation of the land-tax already commenced by his father, and by measures to control the collection of taxes, he benefited his subjects as well as the treasury. In Babylonia at least, the richest province, his fiscal ordinances proved productive, and, according to an Eastern standard, not too oppressive, down to the fall of the Sásánian empire; the Arabs themselves contrast the old Persian system with the oppressive taxation of Moslem times, which was ruinous to the finances of the state as well as to the inhabitants. The public welfare, too, was served by the construction or repair of bridges, canals, embankments, and the like. The priests favoured Khosrau for his extirpation of the Mazdakites, which he completed at the beginning of his reign; but they were not permitted to rule his policy. He managed the great nobles with tact, rather strengthening than weakening the aristocratic basis of the realm, but making it serviceable to himself. Measures were taken to relieve the insecurity which the Mazdakites had introduced in relations of property and the family, and the army was the object of special care. Khosrau had a decided leaning to Western civilization; and, though an Oriental despot could not be expected to sympathize with the highest fruits of Hellenic genius at a time when they

were little appreciated even in Europe, and the heathen philosophers who came to Persia to seek a philosophic state soon returned undeceived, it is to his honour that the Persian secured for them the free exercise of their faith by a clause in the treaty of 549. The Christians, so long as they obeyed the laws, were unmolested; nay, Khosrau helped to maintain the worship not only of the Nestorians but even of the Monophysites, who had much more friendly relations to the Roman empire. Apostasy from Zoroastrianism was forbidden by ancient law, and proselytizing by Christians was strictly prohibited, yet the Monophysite abbot Ahúdemme, who had got a large contribution from the king to build his monastery, and thereafter baptized a son of Khosrau, who presently fled to the Romans, was punished only by a mild imprisonment, in which he was allowed to see his scholars.<sup>3</sup> Nor did the Christians suffer for their sympathy with the rebellious prince Anóshazádh; and yet Khosrau was no weakling, but energetic, warlike, and on occasion cruel.<sup>4</sup>

The negotiations begun in 531 issued in September 532 in a "perpetual peace," the Romans promising a large annual subsidy and other concessions, while the Persians gave back certain castles in Láxistán at the eastern end of the Black Sea. Khosrau had need of peace, and need it probably to protect the frontiers from divers barbarous foes, for tradition speaks of his measures for the safety of the borders towards the Caucasus and on the east. Unmanageable tribes, too, were moved to new homes. In a few years he was strong enough to go to war again, feeling perhaps that Justinian's successes in Africa and Italy had made the hereditary foe too strong. This danger, no doubt, was forcibly set before him by the emissaries of the Gothic king Vitiges, and a tempting opportunity was presented by an appeal which came to him from the rebel nobles of Roman Armenia, Christians though they were. Pretexts for war were never lacking, if only through the Arab subjects of the two powers. But Khosrau certainly desired the war, and early in 540 he set forth to attack Syria as Shápúr I. had done, and marched through the land to the shore of the "Roman sea," taking and pillaging such strong cities as did not buy him off. Antioch in particular yielded an enormous booty; it was burned and the inhabitants carried captive. Turning homewards, the Persian traversed north Syria and Mesopotamia from west to east, levying a contribution even from the hated fortress of Dara. Carrhæ alone, whose population was still mainly heathen, and so presumably inclined to the non-Christian empire, escaped sote free. Ctesiphon was reached at the close of summer, the whole campaign having come off without a single pitched battle. Khosrau, still more than Shápúr II., sought in the barbarous old usage of wholesale captivities a means of appropriating to his own service the culture and technical skill of the West. Thus he made for the captive Antiochians a new municipality (Khosrau-Antiochia, or "the Roman town") hard by the royal residence, which was a notable tribute to the superiority of Roman culture and life. The town was made as Western in character as could be, and the inhabitants were established in comfort, and had religious freedom, and even a Christian mayor. They retained their national manners till the fall of the empire. Chariot-races, for example, were as popular as they had been in old Antioch.

Next year Khosrau was invited to Láxistán by the natives, and penetrated to the Black Sea and took the strong place of Petra. In Mesopotamia war went on for several

<sup>1</sup> The principal sources for this war are Procopius and the Syrian account in Land, *Anecdota*, iii.

<sup>2</sup> That the nomination of Khosrau surprised the Persian nobles is simply impossible. Procopius, it must be remembered, drew for the events at Khosrau's accession on the tales of the (true or false) pretendant Kavádih, son of Jam, and grandson of King Kavádih. But it is quite possible that such things as the removal of princes and the execution of valuable officials took place under Khosrau.

<sup>3</sup> This is known from an unprinted Syrian biography by a disciple of Ahúdemme, who manages to make the king a tyrant by inventing a silly miracle to explain his clemency. Ahúdemme died, after two years' imprisonment, 2d August 575.

<sup>4</sup> Procopius naturally speaks unfavourably of so dangerous an enemy of the Romans.

years with chequered fortune. In 546 the Romans paid a large sum for a five years' truce, and another five years' truce followed in 553, though Láxistán was excluded from both truces until 556, when the Romans had gained successes there; but during all this time the Persian and Roman Arabs never laid down their arms. At length, about Christmas 562, a fifty years' peace was concluded, the Romans again promising a considerable yearly subsidy, and the Persians withdrawing their claims on Láxistán, though the possession of the neighbouring Suania was left an open question. The treaty also provided for religious freedom to the Persian Christians, while all proselytizing among Zoroastrians was strictly forbidden.

During the truces (546-562) great changes had taken place in the East, where a powerful empire had been formed in the northern steppes by the Turks, whose name then, for the first time, became known in the West. The khákán of the Turks, whom the Greeks call Silibulos and the Arabs (after the Persians) name Sinjibú, took from the Hephthalites the right bank of the Oxus, while Khosrau (seemingly in alliance with the khákán, whose daughter he wedded) occupied the left bank (c. 560). Thus Bactria, from which the Sásánians had suffered so much, was at length embodied in their empire, and Péróz was fully avenged.<sup>1</sup> But the friendship of Turks and Persians was soon changed to that hostility which has long made the rulers of Turkeistán and the deserts appear the natural enemies of the lords of Khorásán. Khosrau must have made other conquests about the same time, for in the negotiations with Rome the Persian representative boasts that his master had conquered ten nations, and tradition enumerates the conquest, or rather recovery, of seven eastern lands. These statements must be taken with some discount, and it is not to be believed that Khosrau really ruled in Afghanistan or Sind, as tradition says, though he doubtless widened and secured the eastern limits of the empire.<sup>2</sup>

About 570 an expedition was sent against Yemen, which the Christian Abyssinians had conquered in 525. A native prince invited Khosrau to expel the Blacks, and, after some hesitation, he sent a small force under Vahriz which easily effected this object. Persian rule was nominally maintained in Yemen till the time of Islám, and tribute was paid more or less irregularly; but, as the Persians were not a seafaring people, this remote province beyond the waters was of no practical use to them in the way of diverting trade from the hands of the Romans. Khosrau had presumably hoped otherwise, for affairs of trade, especially the overland silk trade in inner Asia, had considerable influence on Sásánian policy.

About 551 Khosrau had to deal with a rebellion of his son Anóshazáh, who was then in disgrace in Susiana; hearing that his father was dangerously ill, he claimed the crown, leaning on the Christians, whose religion was that of his mother. The rebel was easily overpowered and taken; his punishment was not death, but such a partial blinding as made him unfit to reign.

In his last years Khosrau had again to face the Romans. The Roman alliance with the Turkish khákán, the efforts of Khosrau to hamper their intercourse with that potentate, now his dangerous foe, the annoyance of the Christian empire at the fall of the Christian realm in Yemen, and the refusal of Justin II. (565-578) to pay the stipulated subsidy were all pretexts for war, but the decisive thing was that all Armenia suddenly threatened to become Roman. There were already plans of rebellion among the

<sup>1</sup> A curious proof of the late character of Persian tradition is that it regards the Oxus as having always divided Irán and Túrán, and the Turks as having always been next neighbours of Persia.

<sup>2</sup> Purely fabulous exploits, like the conquest of Caylon, mean only that to the Persians Khosrau, like Bahrán V., was lord of the whole world.

Armenian nobles when an outburst of popular fanaticism was caused by the attempt to erect a fire-temple in the capital Dovin, and the Persian Sírén<sup>3</sup> was slain (spring 571). The rebels and the king of Iberia turned to Constantinople, and were taken under the protection of the incapable emperor, who fancied that he could regain both countries. This, of course, was a declaration of war. The events that followed are known from good contemporary sources, but cannot be arranged in clear chronological order. One of the first operations was an unsuccessful siege of Nisibis by the Romans. Khosrau, on the other hand, took Dara in 573, after a siege of six months, and was joined beneath its walls by his captain Ádharmahán, returning from a successful campaign in Syria on the model of that of 540, in which he had destroyed Apamea.<sup>4</sup> Tiberius, who with the empress Sophia held the reins of power in Constantinople and was recognized as co-regent in the end of 574, desired peace; but Armenia was excluded from the three years' truce that he procured. In 575 Khosrau penetrated through that country into Cappadocia, and, though he had to retire before the Romans and leave his camp to be pillaged, he escaped safely, burning Sebastia and Melitene on the way. The Romans pressed forward and spent the winter in Persian Armenia, but were driven back next year; they had not even secured the sympathy of the Monophysite population. Even beyond Armenia the war broke out again before the truce had expired, and the Romans conducted it with no more humanity than the Persians, leading captive the Christian inhabitants of Arzanene, and making it a special favour to give them a place in Cyprus (577). Negotiations for peace were frequent; the Romans saw that it was vain to try to hold Armenia and Iberia, and might even have consented to give up the temporal and spiritual heads of the rebellion who had taken refuge at Constantinople, but they very naturally would not make peace without recovering Dara. So things stood when Tiberius became sole emperor, and some months later Khosrau died (c. February 579).

Hormizd IV., son of Khosrau by the Turkish princess, was a proud enterprising prince. The Greeks speak ill of him, and indeed were much offended from the first that he neglected the usual courtesy of formally announcing his accession at Constantinople. Persian tradition makes him ill-disposed and a shedder of blood, and we know that he put his brothers to death when he took the throne, but that, as the contemporary Christian narrator says, was a Persian custom. On the other hand, tradition acknowledges the strict impartial justice with which he upheld the cause of the poor against the great. It was the great man who felt his severity. In the army, too, he was careful of the plebeian troops, and lowered the status of the aristocratic cataphracts. Much to his honour is his reply to the priests when they asked him to withdraw his favour from the Christians. "As our royal throne," he said, "cannot stand on its front legs alone, so our rule cannot stand and be firm if we turn against us the Christians and members of other alien religions. Cease, therefore, your attacks on the Christians and follow zealously good works, that the Christians and others of alien faith may see them, and give praise and be drawn towards your faith." In many respects Hormizd seems to have resembled Yazdegerd I., whose fate, too, he shared; the misfortune was that he had not his father's tact in managing the nobles and the clergy.

The war with Rome went on throughout his reign with varying fortune. There was a serious war, too, with the Turks, but over these, or rather over one of their vassals, the Persian general Bahrán Chóbín gained so complete

<sup>3</sup> A member of the same house with the conqueror of Cræsus.

<sup>4</sup> Part of the captive Apameans were settled in New Antioch.

a victory that he is said to have made the Turks pay instead of receiving tribute. Bahrām was next sent into the lands south of the Caucasus to strike a great blow at Rome (589), but here he was utterly defeated, and Hormizd was foolish enough to dismiss him with disgrace. The general, who was head of the great house of Mihrān, replied by open revolt, feeling, no doubt, that he could reckon on the discontent of the nobles and the other armies. The troops in Mesopotamia which had been driven back on Nisibis by the Romans and were afraid of punishment did in fact mutiny and open communication with Bahrām, who marched against the capital and reached the Great Zab. An army sent forth against him also mutinied, but declared for Hormizd's son, Khosrau, who was on bad terms with his father. Next, part of the troops rose in Ctesiphon, whither Hormizd had hurried from Media. Bindōe, Khosrau's maternal uncle, was in prison there, and his brother Bistām (Vistāhm) set him free by force. Hormizd was deposed and soon after put to death, and Khosrau, who had probably consented to a crime he could not prevent, was proclaimed king (summer 590).

Khosrau II: Parvāz, "the conqueror," had now to deal with Bahrām, who sought the crown, or at least the regency, for himself. But the pusillanimous king could not inspire his troops with courage to face the experienced general; he was deserted in the first shock of battle, and fled to Circesium to cast himself on the aid of the emperor Maurice, who undertook to restore Khosrau, but, able prince as he was, missed the great opportunity of securing an adequate equivalent for the service. Himself a man of obscure descent, he seems to have been flattered by the idea of posing as "father" of a legitimate king of ancient stock. The enterprise was not very difficult, for though Bahrām had seized the crown and begun to coin in his own name the nobles would not submit to one of their own peers, and the people were still stricter legitimists than they had been under the Arsacids. In their view the royal majesty (*farrāhi kayānīk*) was innate in the house of Ardāshīr, and none outside of it could be king. Bahrām had to put down an insurrection in Ctesiphon itself, and Bindōe escaped and took up his nephew's cause. In the beginning of 591 a Roman host drew near, and Khosrau caused the gates of Martyropolis<sup>1</sup> and Dara to be opened to them. He was now joined by the Persian army of Nisibis, and Persian and some Armenian grandees came in to him day by day. The other armies took the same side. In Atropatene Bistām, Bindōe's brother, gathered a host against Bahrām, while the united Persian and Roman forces advanced along the left bank of the Tigris and smote him in a decisive battle near the Zab (summer 591). Seleucia, Ctesiphon, and New Antioch had already been taken by troops sent through the Mesopotamian desert. Thus Khosrau was restored, and peace with Rome followed of course. The Romans ceased to pay tribute, but only recovered their old frontier, Nisibis still remaining Persian. Bahrām fled to the Turks and was honourably received, but was murdered not long afterwards. Khosrau was still so insecure that he asked a bodyguard of 1000 Romans, and now he set himself to remove all dangerous persons, especially Bindōe and the other conspirators who had overthrown his father and set himself on the throne. Bistām was not so easily reached. When he saw himself condemned he made himself king in Media, and held out for almost six years with the help of the remnants of Bahrām's forces and in alliance with Turks and Délamites. He fell by treachery probably in 595 or 596.

To a land already weakened by long wars all these

<sup>1</sup> This town had been betrayed to the Persians, and the Romans had lain before it for some time.

disorders were ruinous. Nor was Khosrau II. the king fit for such times. A weak coarse-minded man, at once boastful and timid, avaricious and fond of luxury and splendour, he was at best a very ordinary Oriental despot. He found the treasury empty and left it full, while the empire was impoverished by wars. And in these he won no glory; his victories were those of his generals. To the Christians he long extended protection and favour, and even built them churches; for he fancied that not only the Christian empire but St Sergius himself, the chief saint of the Roman Syrians and Arabs, had a share in his restoration, and he was much under the influence of a Christian wife, Shīrīn, and of some other Christians, such as his physician Gabriel.<sup>2</sup> But in later years his disposition toward the Christians was altogether reversed.

When Maurice fell by treason and the hideous tyrant Phocas seized the throne (November 602) Khosrau felt himself called to avenge his "father" and protect Maurice's supposed son, Theodosius, who had fled to the Persian court. Narses too, the commandant of Eblēssa, called for help against Phocas. Khosrau accordingly imprisoned the ambassadors who came to announce the new accession, and a war began, early in 604, which for twenty years laid the Roman lands open to such ravages as had never before been known; so helpless was the empire under the bad rule of Phocas and through the pressure of Avars and other barbarians. Khosrau was present at the taking of Dara (604),<sup>3</sup> but had no personal share in the war after that event. After a few years the Persian armies were seen as far west as Chalcedon over against Constantinople. Yet the real weakness of the Sāsānian realm was strikingly exposed in these very years (604-610) in the battle of Dhū Kār, a small affair in itself, but very significant. Khosrau had abolished the kingdom of Hīra and put King No'mān to death, thus ridding himself of a troublesome vassal, but at the same time losing a very useful means of influencing and checking the desert tribes. And soon after No'mān's fall the tribe of Bakr ibn Wāil actually defeated a regular army at Dhū Kār near the Euphrates, but a few days' journey from Ctesiphon, and maintained themselves on the soil in spite of the Persians. Arabic vanity greatly exaggerated this success, and the result was a notable increase of self-confidence on the part of the Arabs, by which the Moslems ultimately benefited when they came to attack Persia.

The Romans still had the worst of the war when in October 610 Phocas gave place to the valiant Heraclius. The new emperor, hard pressed on all sides, vainly asked for peace. In 613 Damascus was taken, and the country round it, on which the Persians had never before set foot, was ravaged in a way of which countless ruins bear witness to this day. In June 614 Jerusalem fell, and, to the horror of all Christendom, the "precious and life-giving cross" went into captivity. Next Egypt was conquered, and Asia Minor swept as far as Chalcedon. Heraclius was not able to strike a counter blow till 622, when an expedition towards Armenia and the Pontine territories from the Gulf of Issus restored respect for the Roman arms. His great campaigns began in the following year and carried him deep into the Persian country, often quite cut off from his base, in a way that could not have succeeded with any leader who was not a great politician as well as a great general. In the first year of these campaigns he destroyed one of the holiest of Persian shrines, the fire-temple of Ganjāk, near Lake Urmīyah, and so

<sup>2</sup> Shīrīn and the king even took part in the quarrels of Nestorians and Monophysites, and foolishly took the side of the latter, who were the minority and less Persian in sympathy. There are good contemporary Syriac records of all this which in part are still unused.

<sup>3</sup> Land, *Assecl. Syr.*, i. 15.

avenged Jerusalem. Now we find him near the Caucasus, now in eastern Asia Minor, now again in Mesopotamia, never beaten, often victorious, but oftener perhaps outwitting superior forces by adroit movements. In 626 Khosrau attempted a diversion by sending his best general, Shahrbarás, with a great force directly against Chalcedon. It was an anxious summer in Constantinople, with the Avars behind and the Persians in front, and the emperor almost lost in the depths of Asia. But in the beginning of August the Avars drew off, the Persians, who had no ships, having failed to cross the Bosphorus and effect a junction with them. Heraclius replied by drawing the KHAZARS (*q.v.*) down into Persian territory, and in 627 he ventured to strike a blow at the heart of the monarchy. The feast of 6th January 628 he celebrated in Dastagerd, which was but some three days' march from Ctesiphon, and had been Khosrau's usual residence for twenty-four years. Khosrau had fled in terror, and did not deem himself safe till he and his harem were over the bridge of Ctesiphon. The capital was, of course, too strong to be carried by the small forces that the Roman had been able to lead by a rapid march from the Caucasus, and Heraclius turned swiftly before any great army could be gathered against him, and cut his way through the enemy's country back to Ganjak over the Kurdiáh Alps amid the snows of February and March,—an exploit almost unparalleled in the history of war.

Meantime there was revolution in Ctesiphon. Khosrau's tyranny and greed had offended high and low; his panic flight had made him contemptible; and, to crown all, his legitimate heir Kavádih and most of his brothers were pining in prison to leave the heirship open to Mardánaháh, son of Shírin, who, even in advanced years, had retained absolute command of her husband, in spite of his thousands of other wives. Certain nobles liberated Kavádih and proclaimed him king (25th February 628), and Khosrau, deserted by all, was dragged from his hiding-place and executed (29th February). Thus miserably perished a prince whose armies had covered almost the whole breadth of the Achaemenian empire. No hand was raised to help him, and the Christians, who had never forgiven the insult to the true cross, were the first to welcome the elevation of the parricide Kavádih, in which, indeed, one of their own number, Shamtá, son of the farmer-general Yazdín, had a leading part.

The first act of Kavádih II. Shéróe was to murder some eighteen brothers, his second to ask peace from the Romans. A truce was conceded, but Heraclius was too much master of the situation to agree to a final peace at once. Persian troops were recalled from Roman soil, but, when Heraclius, after a hasty reorganization of Mesopotamia, had gone on to Syria, he learned that the Persian king was already dead after a reign of but six months, in which the chief occurrence was a terrible pestilence.

Ardaahr III., son of Kavádih, was now crowned at the age of seven. An era of distress and trouble followed, in which children or women sat on the throne, and the nobles disputed with one another for the reality of power. The holy cross was sent back from Ctesiphon through the primate of the Nestorians; and the feast of the Elevation of the Cross still commemorates the joyful day (14th September 629) when Heraclius solemnly re-erected it in Jerusalem. The Government at Ctesiphon was powerless; the Khazars harried the empire; and it was perhaps at this time that Khosrau, son of Kavádih, and grandson of Hormizd IV., who had been brought up among the Turks, sought to make himself king in Khorásán, but was slain after a few months. A more dangerous pretendant was the victorious general Shahrbarás, who met with Heraclius in June 629 at Arabissus in Cappadocia, and prob-

ably there obtained an approval of his enterprise from the emperor, who naturally favoured the cause of disorder in Persia. Shahrbarás took Ctesiphon with a small force aided by treason within; Ardaahr was put to death (27th April 630); and robbery, murder, and every terror raged in the royal city. But Shahrbarás, too, fell on the 9th of June a victim to the envy of his peers and the spirit of legitimacy. His body was dragged through the streets, and tradition speaks with grotesque irony of the man who sought to be king but could not, because he was not of the lawful house.

Bórán, daughter of Khosrau II., now sat for a time on the throne (till about autumn 631), and appears to have closed the treaty of peace with Heraclius. The conditions are not recorded, but were probably the same as in the peace with Maurice; at all events the Persians kept Nisibis. Bórán was followed in Ctesiphon by her sister Ázarmídkht, probably after a short interval in which a certain Pérós reigned. But in Nisibis the soldiery of the slain Shahrbarás put forward Hormizd V., a grandson of Khosrau II., and he maintained himself in that quarter for a time (631-32). Ázarmídkht was dethroned by Rustam, the powerful hereditary marshah of Khorásán, whose father's death she had procured. Our confused records of this age of disorder do not permit us to give a clear chronological or geographical view of all pretenders who arose in the capital and provinces; but in Ctesiphon, we know, there reigned for a time a certain Ferrukhzádh (or Khorrezádh) Khosrau, apparently a child.<sup>1</sup> But another child, Yazdegerd III., son of Shahriyár, and so a grandson of Khosrau II., was put forward by certain nobles in Persia, and crowned in the fire-temple of Ardaahr (second half of 632 or first half of 633). Soon Khosrau was slain and Yazdegerd acknowledged in the capital, and without much resistance in the provinces also.

Fond hopes could now be entertained that the wounds of the monarchy might be healed under a legitimate prince unstained by descent from the parricide Shéróe, consecrated in the cradle of the monarchy, and upheld by the strong hand of Rustam. Some temporary recovery seems actually to have taken place; but a new foe more dangerous than Julian or Heraclius was already knocking at the gates of the monarchy. That Yemen and some tracts in north Arabia had already been lost by Persia to the Moslems had scarcely been observed at Ctesiphon amidst so many greater disasters. But now the Moslems already hovered on the frontier. Mothanná, one of the boldest leaders of those Bedouins who since Dhú KÁR had made frequent forays on Persian soil, accepted Islám, and had its strength at his back. These attacks became bolder and bolder. Presently Khálid, in all the prestige of his victory over the revolt of the Arabs against Islám (see vol. xvi. p. 562), appeared with a small force on the lower Euphrates to take the lead of these Bedouins. Persian troops and their Arab allies were repeatedly beaten in small engagements, and soon a number of frontier-posts were in the hands of the Moslems.<sup>2</sup> The inhabitants of the western bank of the lower Euphrates, who were all Christians and had little attachment to Persia, submitted themselves and promised to supply the victors with intelligence. Soon the Arabs ventured to cross the river and plunder the villages west of the Tigris.<sup>3</sup> In the early summer of 634, however, Khálid was called away to Syria; his successor, Abú 'Obaid of Táif, though strengthened by reinforce-

<sup>1</sup> He appears beardless on his only known coin. By some accounts he was the only son of Khosrau II. who had escaped massacre.

<sup>2</sup> The history of the conquest is here given mainly after Belldhori, whose short notices stand examination much better than Tabari and the historians who follow him. The chronology is in many points uncertain.

<sup>3</sup> Baghdád, then such a village, was plundered on a fair tide.

ments, was utterly defeated and slain on his first meeting with a regular Persian host in the hard-fought "battle of the bridge" at the Euphrates, and Mothanná had great difficulty in saving the remains of the army (26th November 634). Not without hesitation the caliph 'Omar resolved to send a greater force to Irák, calling on his Arabs to win for themselves the treasures of the Khoarasm and paradise; and now for the first time a considerable Persian army was defeated at Bowaib (635 or 636), with the loss of its general, a prince of the house of Mihrán. In Sa'd ibn Abi Wakkás the Moslems had now an energetic and cautious leader, and the Persian court began to see its danger, especially when the news arrived of the battle of Yarmúk, by which Syria was lost to Heraclius. Rustam in person placed himself at the head of a great army, over which, in sign of the gravity of the enterprise, was borne the venerable sacred banner of the empire (*dírafahi káwiyán*). Sa'd fell back before the Persian advance and posted himself at Kádísiya on the edge of the desert south or south-west of Híra, where the armies lay facing each other for months. The Arab force must have been inferior in strength, for no great army could have long held such a barren post nourished only by forays and what the caliph could send from Medina. At length, towards the close of the year 636, or in 637, battle was joined and raged for several days, Sa'd giving orders to his men in spite of a sickness under which he laboured. The Persians were better armed, but the Arabs fought with desperate energy. The elephants, which formed part of every regular Persian army, greatly terrified them at first, but ultimately these huge beasts, getting out of command, only aided the discomfiture of the Persians. Of the mass of a Persian host no great bravery was to be expected; yet it was only after a hard fight that the victory was decided, Rustam slain, and the sacred banner taken.

The battle of Kádísiya virtually decided the fate of the Tigris valley; but there was still some fighting on the plains of Babylonia, at Birs (Borsippa), and Seleucia was not taken without a lengthy siege. Then the Arabs crossed the Tigris and fell on Ctesiphon, Yazdegerd fleeing before them to Holwán on the Medo-Babylonian frontier. At Jalúla on the road to Holwán the Arabs gained a fresh victory over Rustam's brother, Khorresádh, and Yazdegerd continued his flight. Meantime another body of Arabs had occupied Lower Irák and entered Susiana. A strong and wise leader might still perhaps have saved Irán proper, and 'Omar, as energetic as cautious, was in fact slow to allow his armies to assail the highlands. It was not till some time between 640 and 642 that the

"victory of victories," as the Arabs rightly call it, was gained at Nehávend (a little south of the old high road from Babylon to Ecbatana), and the last great army of the Persians was shattered by No'mán, who fell on the field, and the Meccan Hodhaifa. Even now many individual provinces and cities did not yield without stubborn resistance, and in many places rebellion after rebellion had to be crushed, especially in the region around Istakhr, the cradle and sacred hearth of the fallen monarchy. Everywhere the great local barons and even the lesser nobility dealt with the Arabs as independent chiefs, and in many cases came to peaceful terms with them.

Yazdegerd fled from one to another of his lieutenants without venturing himself to strike a blow for his crown and his life. He still retained the forms of sovereignty, and coins were still struck in his name; but one host after another dismissed him as a burdensome guest, and at length he was miserably murdered in the remote district of Merv, not, it would appear, without the connivance of Máhóe, governor of that province (651 or 652).

The great similarity in the ends of the Achaemenian and Sásánian empires is no mere accident, but significant of the internal resemblance between the two. Granicus which showed the reality of the danger, Issus which lost Darius his western provinces, Gaugamela which broke up the monarchy and yet did not at once give possession of the several lands of the realm, have their parallels a thousand years later at Bowaib, Kádísiya, and Nehávend. The flight of Darius to the farthest north-east, and his death by the hand of traitors, not of the foe, are repeated in the fate of Yazdegerd, who resembles Darius also in his lack of heroism. The nobles showed more loyalty and patriotism against the Arabs than against Alexander, and indeed religious antipathy and the barbarism of the Arabs made it less easy in the later case for a Persian to accept the foreign yoke; yet even now there were too many traitors and deserters among the nobles high and low. Fully to subdue the Persian monarchy cost the Arabs a much longer time than it had cost the Macedonians; but the conquest went far deeper,—Hellenism never touched more than the surface of Persian life, but Irán was penetrated to the core by Arabic religion and Arabian ways. See MOHAMMEDANISM.

A fragment of the Sásánian empire lasted for a considerable time in the mountains of Tabaristán (Mázandarán), to which the hereditary generals (*Spahpat, Ispehbedh*) of Khorisán, of the house of Káren, withdrew, and where they reigned for over a hundred years, though sometimes paying tribute to the caliphs. They remained faithful to Zoroastrianism, and apparently viewed themselves as direct successors of Yazdegerd, since the era employed on their coins seems to have his death as its epoch.

*Literature*.—G. Rawlinson, *The Seventh Great Oriental Monarchy* (London, 1876), is inadequate. Fuller but still inadequate use of Oriental sources is made by Spiegel, *Iranische Alterthümer*, vol. III. (Leipzig, 1878). The documentary evidence is mostly collected in Nöldeke's translation of *Tábari (Geschichte der Perser, &c., Leyden, 1879)*. For the relations of the Sásánians with Rome, Tillemont, *Hist. des Empereurs*, and Clinton, *Fasti Romani*, must be used, and Saint-Martin's notes to Lebeau, *Hist. de l'Empire Persan* (Paris, 1822-36), are still useful. A great deal of serviceable matter is to be found in Hofmann's translation of excerpts from the Syriac Acts of Persian Martyrs (*Syrische Acten Persischer Märtyrer*, Leipzig, 1866). (TH. N.)

## PART II.—MODERN PERSIA.

### SECTION I.—GEOGRAPHY AND STATISTICS.

LONG prior to the Christian era the satrapies of Cyrus comprehended roughly an immense range of territory, from the Mediterranean to the Indus and from the Caucasian chain and Jaxartes to the Persian Gulf and Arabian Ocean. In the 17th and 18th centuries A.D. the conquests of 'Abbás and Nádír kept up these boundaries more or less on the east, but failed to secure them on the west, and were limited to the Caucasus and Oxus on the north. Persia of the present day is not only, in the matter of geographical definition, far from the vast empire of Sacred Writ and remote history; but it is not even the less extensive, though very expansive dominion of the Safawi kings and Nádír Sháh. It may be said, however, to comprise now quite as much settled and consolidated territory as at any period of its political existence of which we can speak with the authority of intimate acquaintance.

If it has less extent of land than before its latest disastrous war with Russia, there is certainly within its recognized limits less rebellion and more allegiance. And, if the true interests of Persia, considered as a living power, were only understood by her kings and ministers, she might reasonably seek to attain a state of security which would amply compensate for the loss of precarious and profitless expanse.

*Boundaries*.—The region of Ararat presents a good starting-point for the definition of a western and northern boundary to the kingdom of Násru'd-Dín Sháh. East of the Greater Ararat a short oblique line from the Arras to the south-west divides it from Russia. Below this begins the Perso-Turkish frontier, for the settlement of which a mixed commission was appointed in 1843. The outcome of the labours of this commission, which lasted more than twenty-five years, has been rather a careful delineation of the disputed tract than the delimitation of



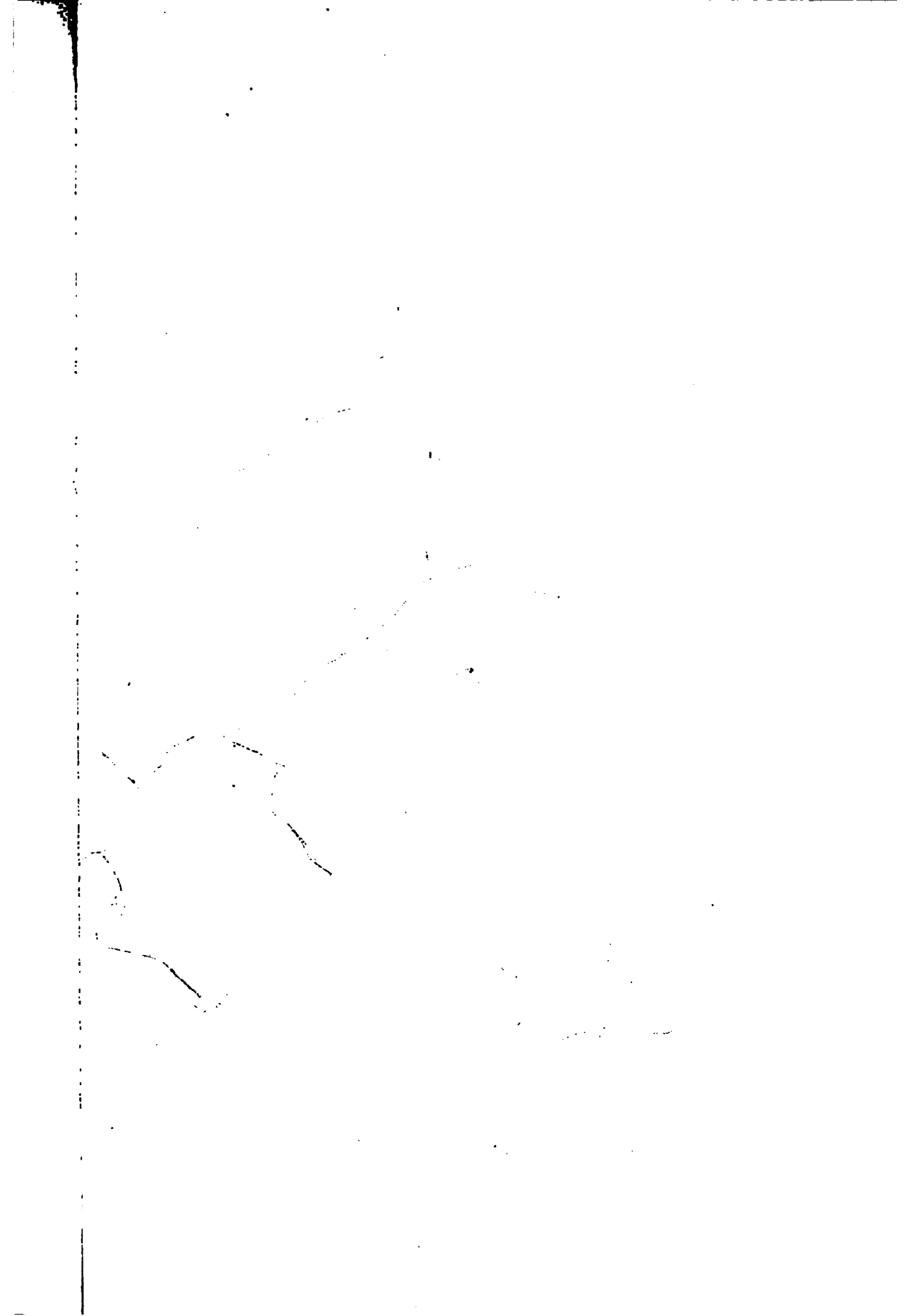





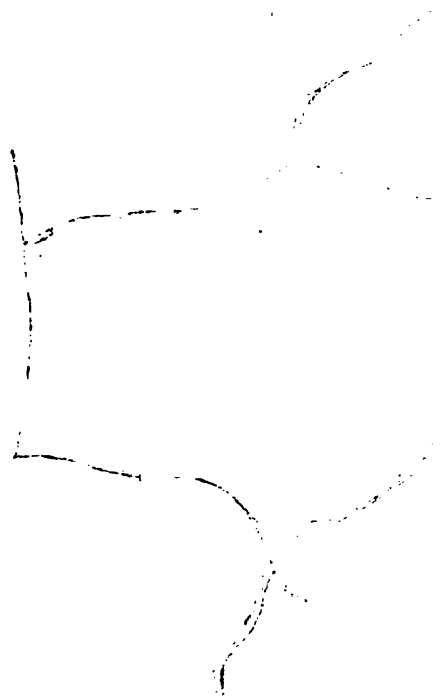

an exact boundary, while the cession of Kotur to Persia, though part of the general question, must, if carried out at all, be looked upon as a separate result, due only to later diplomacy. The territorial claims of Turkey and Persia bear chiefly upon Kurdistan and the respective tribes which inhabit the plains and valleys of that extensive mountain region. They are founded upon the treaty of Sultan Murád IV. with Sháh Sûfi in 1639, a later one of Nádir Sháh with Sultan Mahmúd I. in 1736, and one more recent still between Fath 'Alí Sháh and Mahmúd II. in 1823,—the last two maintaining the *status quo* established by the first. But, when the Anglo-Russian commission first met, the boundary of possession fell far short of Turkish pretensions. These would have extended the pashalik of Baiyazid (Bayazid) in the province of Arzrum (Erzeroum) to a line including Makú, chief place in the district, and situated on the bank of the river of that name.<sup>1</sup> Farther south, again, the sultan insisted on increasing the area of the province of Van by the forcible annexation of Kotur. Such an act, after the assembly of a commission for the demarcation of the disputed frontier, was neither justified by precedent nor could it enhance the merits of the Turkish claim, and the reason alleged, that Kotur was essential to the Ottoman Government for strategic reasons—in other words, that it gave the Turk free access into his neighbour's territory—could scarcely be taken to account in the estimation of their opponents. The question was submitted on behalf of Persia to the Berlin Conference in 1878, and a special Anglo-Russian commission appointed to consider it in July 1880. The proposed cession, if accepted, would substitute for the present curve eastwards a line more direct but with a westerly inclination, whereby the fort and station of Kotur become embodied in Persian territory. This section of frontier is overlooked on the north by the mountains Bebi Kourgui, Guerdi Beranan, and Khidhr Baba, passes through Tépé Avristan on the west to the Turkish road to Kotur, follows this road to the west for half a mile, and then turns due south between Mount Kevlik and the river Shíva Resh to the sources of the latter, whence it zigzags to the eastward to rejoin the general boundary-line overlooked by the Kára Hisár, Mír 'Omar, Guéré-Sourava, and Guéré-Berian Mountains. Sir Henry Rawlinson saw difficulty in defining a line of frontier from Ararat to Kotur; for the country was not only intersected by ranges running in every possible direction, but it wanted a fixed population, and was, moreover, liable to the incursions of wild Kurdish tribes, who would have no respect for boundary-marks. Below Kotur, and south-west of the important Persian town of Khoi, the old line of possession inclined considerably to the westward, but Turkey claimed a more advantageous line running nearly north and south to the passes between Súk Bulak and Rowandiz, one of which was crossed in 1875 by Thielmann, who gives an interesting account of the surrounding country. The plain of Lahijan on the Persian side—some 20 miles long and 20 miles broad—he describes to be at an elevation of 5650 feet, "watered by the two sources of the Little Záb, which, several miles after their junction, traverses the mountain range through a deep rent . . . and then flows towards the Tigris." On the west of this district is the "gigantic wall of the Zagros Mountains, the frontier-line between Turkey and Persia." Hence, to the latitude of Sulimaniya, or for more than 100 miles, the Turks claimed farther than the ancient limits assigned to them, and sought to include

within the Ottoman territory the border-fort of Sardaht, on the left bank of the Akau.

Continuing the line of disputed frontier to the southward, the same difficult country still presents itself to perplex the decisions of commissioners or arbitrators, but from the warmly-contested district of Zoháb in the province of Karmansháh up to Dizful on the Dis river the mountains may be said generally to indicate Persian and the plains Turkish territory. Lúristan and Khúristan (with Arabistan) are the frontier provinces of the sháh, and the Hamrin Hills, with Hawízah, Muhamrah, and the east bank of the Shattu 'l-'Arab, show the Persian possessions to the head of the gulf.

The want of a determined line of demarcation between the two countries for the 700 miles from Ararat to the Shatt, or outlet into the sea of the waters of the Tigris and Euphrates, may have political advantages, but is inconvenient to the geographer and most unfavourable to the cause of order and good government. Even without the evidence of open conflict, it may be assumed that there are few inhabited sections of the strip of disputed frontier (from 20 to 40 miles in breadth) where mutual ill feeling is not the rule, and where the Turkish Sunni does not abstain from friendly association with the Persian Shi'ah. More recently attempts have been made, and apparently with success, to reconcile differences by British and Russian mediation, and a renewal of the days need not be anticipated when telegraph-posts were torn up or destroyed, lands laid waste, and villages plundered, owing to the prevalence of the old spirit of hostility. A fixed boundary would, however, in a great measure facilitate settlements of dispute, because it would more clearly make known the actual transgressors.

From the already-adverted-to point on the Arras east of the Greater Ararat the river itself supplies a northern boundary to Persia up to the fortress of 'Abbasabad, where a cession of strategical works to Russia is noted by a loop on the southern bank. Thence the line is generally marked by the bed of the Arras for a distance of about 180 miles, descending as low as 38° 50' N. lat., and rising again to 39° 30' north-east of the steppe of Moghan. An oblique line running south-east to the Bulgaru Chái makes that stream the southern boundary for 13 miles to the confluence of the Adina Bazár and Saikamish, the former of which then limits the Persian territory on the east. From the source of the Adina Bazár the crest of the mountains towering over the more distant Russian ports on the western shores of the Caspian, and separating the Talish from the Araha, marks the division of the two territories up to the river of Astara, the port of which name completes the demarcation on the sea-coast. Thus far the result of the treaty of Turkmánchái, dated 10 [22] February 1828, which involved Persia in a serious loss. To the southward all is Persian, and the two large maritime provinces of Gilan and Mazandaran, both laved by the waters of the Caspian, represent the northernmost parts of the sháh's dominions between the 49th and 54th meridians of E. long. In the south-eastern corner of the Caspian the island of Ashuráda in the Bay of Astrábád was appropriated by Russia in 1842 as a convenient post for overawing the Türkmans (Turkomans).

Eastward of the Caspian, from the Hasan Kúli Gulf, the line of Persian territory cannot be indicated with absolute certainty, because the Russian maps do not correspond with those prepared by the war department in England; and it need hardly be added that the former give to Russia far more land than do the others. According to Colonel Stewart, an officer for some time resident in the vicinity of the Atak, or skirt of the mountains fronting the Black Sand Desert, the line follows the Atrak (Atrek) from its mouth to Shatt, where it leaves the river

<sup>1</sup> Under the treaty of San Stefano (3d March 1878) the old Perso-Turkish became the Perso-Russian frontier as far south as to include the post-road below Baiyazid; but the territory so taken from the Turks was restored under the later treaty of Berlin.

and passes obliquely west of the Simbar to a point within 15 miles of Kizil Arvat,<sup>1</sup> and then turns towards the Tekke range to Darahgáz, which district it includes in an outer curve, passing on to the Tajand at Sarakhs. The Russian official map, however, brings the line south and east of the Simbar, and otherwise impoverishes Persia to the benefit of her powerful neighbour. But the first article of the Russo-Persian treaty signed in December 1881 at Tehran (Teheran) thus describes the situation:—

“From Chat (Shatt?) the frontier-line follows in a north-easterly direction the ridges of the Songou Dagh and Sagirim ranges, thence extending northward to the Chandir river, reaching its bed at Chakan Kala. From this point it runs in a northerly direction to the mountains dividing the Chandir and Simbar valleys, and extends along the ridge of these in an easterly direction, descending into the bed of the Simbar at the spot where the Ak-Agayan stream falls into it. Hence, eastward, the bed of the Simbar marks the frontier as far as the ruins of Masjid Damanah, where a local road forms the boundary to the ridge of the Kopet Dagh, along which the frontier extends south-eastward, turning south among the mountain heights which divide the valley of the Simbar from the source of the Garmáb. Taking a south-easterly course across the summit of the Miano and Chubest Mountains, it then strikes the road between Garmáb and Ribát at a distance of less than a mile north of the latter, and, following a high ridge, proceeds in a north-easterly direction to the boundaries of Giúk Kaital. Hence, after crossing the gorge of the river Firuzé, it turns south-east till it reaches the summits of the mountain range, bounding the valley on the south, through which the road from the Russian station of Askabad to Firuzé passes, and pursues its course along the crest of these mountains to the most easterly part of the range. The frontier-line now crosses over to the northernmost summit of the Aselm range, whence it seeks out the junction of the mountains called Zirí Kuh and Kizil Dagh, extending south-eastward along the summits of the former until it issues into the valley of the Baba Durmas stream. It then takes a northerly direction and reaches the oasis at the road from Gawars to Lutábad, leaving the fortress of Baba Durmas to the east.”

The distance from Baba Durmas to Sarakhs is about 185 miles, and the intervening boundary is that of the ataks of Darahgáz and Kelat, both of which districts belong to Persia. The word “atak,” signifying “skirt,” applies to the whole hill-country separating Persia from the Türkman desert, though these mountains and their passes and valleys are not all within the sháh’s present dominion. That they present a formidable barrier and remarkable geographical features may be inferred from the ascertained height of the loftier peaks, which, though inferior to those situated some 50 miles to the south, can still boast a figure varying from 5000 to 10,000 feet. In the Hazár Masjid range is one of 10,500. Adopting Rawlinson’s divisions and distances, the whole Atak, or “Daman-i-Kuh,” as the Persians call it, is divided into three districts: the Akhal Atak, extending for 160 miles, from Kizil Arvat to Darahgáz, the last Türkman camp (*obak*) in which is at Gawars; the Darahgáz Atak, 70 miles, to Abiverd; and the Kelat Atak, 60 miles, to Mehna. Thence to Sarakhs another 70 miles may be reckoned, to accomplish which the traveller leaves the mountains on his right and the wonderful natural fortress of Kelat-i-Nádírí in his rear, to strike the Tajand at the crossing point between Merv and Maahhad (Meshed).

The subjection by Russia of the Türkman tribes and the planting of her standard in the hill-country on the western side of the Atak have immensely strengthened her power in the region east of the Caspian. These new Cossacks of the Black Sand Desert will be a great acquisition to her force, though their antecedents denote propensities rather aggressive than protective. In one respect the Persians should be gainers by the encroachment. It is hardly probable that under the new arrangements in the Atak the north-east frontier of Persia will be so frequently the scene of plunder and invasion as it has been of old, or that the marauders will be allowed by the Russian con-

querors to continue the unchecked exercise of their infamous profession in Khurásan (Khorásan).

Special mention of Sarakhs, the extreme outpost of Persia in the north-east, appears to be appropriate, both on account of its geographical position and of its political importance. This place, situated on the plain of the same name,<sup>2</sup> was fifty years ago a mere outpost of Mazduran, the frontier hill-station on the shortest of three roads (and somewhat more than midway) between Maahhad the capital of Khurásan and Sarakhs. It was visited in 1860 by M. de Blocqueville, who found there a recently-constructed Persian fort, with strong walls and protected by a ditch. Some of the towers contained as many as ten guns. He says nothing of the ruins of the old town on the east of the Tajand, though he forded the river; but Burnes, who in 1833 put up in a ruined tomb amid the Türkman tents or “khargáhs” in that particular locality, had been equally silent regarding it. The last-named traveller speaks of the shrine of a Muhammadan saint, of a small weak fort, and of a few mud-houses only, and states that, at the third mile after leaving his encampment to enter Persia, he crossed the Tajand,—not supposing it, however, to be the Herat river. Sir Charles Macgregor was at New Sarakhs in 1879. He describes the fort as immense,—an irregular polygon, with eleven bastions, and citadel attached. It had a garrison of some 700 infantry, with a few horse-men, and eleven guns of more or less use. From its walls he reviewed the surrounding country. On the north stretched one vast plain almost unbroken by tree, bush, mound, or undulations, for the bed of the Tajand winding round to the north-west was too low to be visible. On the north-east lay the road to Merv stretched out beyond the dark tamarisk foliage of the river. To the east all was clear; south-east were undulating rounded ridges extending towards the Múrg'háb; south was Mazduran; and north of west was a confused mass of rugged hills in the direction of Kelat-i-Nádírí. Lastly, we have the testimony of Lessar, the Russian engineer, who, visiting the place in 1882, found it extensively fortified and occupied by a battalion of Persian infantry; the armament of the fortification, however, consisted only of six old guns, which were never discharged, while the artillerymen were ignorant of their duties, and neither drilled nor exercised. Water was supplied from wells inside the walls and by canal from the Tajand.<sup>3</sup>

To define the eastern boundary of Persia, the lower course of the Hari Rúd, under its name of Tajand, may be accepted generally up to Pul-i-Khátún, whence to Tuman Agha the line is continued by the river in its own name. From this point it runs due south across the mountain range overtopped by the conical peak of the Sang-i-Dukhtar, and through the edge of the Salt Desert, leaving Kuhsan and Zangi Suwar, villages near the Hari Rúd, and the more important Ghurian in Afghan territory.<sup>4</sup> Again crossing the ranges which intersect the desert from the north-east, the line, inclining somewhat to the west of south, is continued to Cháh Sagak (the “dog’s well”), an elevated spot on the old caravan route between India and Persia, as far as which the Afghans have the right of pasturage. To the westward is the Persian province of Káíyan. The surrounding country bears the significant name of Dasht-i-Na-Umaid, or “Waste of Hopelessness.” For 8 miles south-east, 8 miles due east, and 24 miles south, in all about 40 miles, the line is carried to the

<sup>1</sup> West of the Tajand, called by Dr Wolf the “Dartya” (or *as*) of Sarakhs.

<sup>2</sup> Other modern travellers have written of Sarakhs, among them an intelligent Indian, Dáúd Khan, but they give no information additional to that of the authorities quoted.

<sup>3</sup> When Mr Forster was at Kháf in 1783, Timur Sháh, the ruler of Afghanistan, had his boundary between that place and Turakís.

<sup>4</sup> Probably a plural or perversion of *ribd*, a caravan-road.



Siyáh Kuh, or "Black Hill," on the border of the district of Nebbandan. Here begins the line of frontier determined by the Sístan arbitration of 1872. The British commissioner (Sir F. Goldsmid) decided that an oblique line drawn from the Siyáh Kuh to the southern limit of the reedy marsh called "Naisár," and prolonged to the main outlet of the Helmand, would fairly separate and distinguish the possessions of the two states respectively in the north of Sístan. On the east the bed of the Helmand itself would be the boundary up to Kuhak, where was the large "band" or dam which diverted the waters of the river into the more fertile lands to the west. From Kuhak a line south-west to the Kuh Malik Siyáh completed the delimitation by leaving the two banks of the Helmand in the hands of the Afghans, and placing a large tract of partly desert and partly inundated country between the litigants. Subsequent surveys by Sir Charles Macgregor have thrown new light upon the large and little-populated tract to the far south of Sístan, and are suggestive of an Afghan-Baluch as well as of a Perso-Afghan frontier.

In whatever light it be regarded, the line of Persian frontier from the Kuh Malik Siyáh to the sea rather concerns Baluchistan than Afghanistan; but, though roughly delineated by St John and Macgregor, it cannot be described with scientific accuracy until it reaches the district of Jalk, or after a south-easterly passage of 170 miles through the deserts of Fir Kaisar and the Mashkel or Mashkid,—names used as the more likely to identify the region traversed. From Jalk the Perso-Kelat boundary begins, as determined by Major-General Goldsmid, the British commissioner in 1871, and verified in the subsequent year by Captain (now Sir Oliver) St John, R.E. The state of Kelat (Khelat), it should be explained, is now that of western Baluchistan, the western half of that country having become annexed to Persia by a process of gradual encroachment. It was this action of Persia, and the disquiet and mischief which it occasioned in Makran and other parts of Baluch and Brahui territory, that brought about the British mediation.

From Jalk to the sea is about 150 miles as the crow flies. By the line laid down it is very much farther, as the nature of the country and of the claims of the contending parties did not admit of other than a tortuous course. The small district of Kuhak, lying south-east of Jalk, should, in a geographical sense, have been included among the lands on the Persian side, but the evidence of right and possession was insufficient to warrant its separation from Kelat, and, whatever may have been its subsequent fate, it was not made over to the sháh's governors by the original decision, which was expressed in the following terms:—

"The territory of Kelat is bounded to the west by the large Persian district of Dink, composed of many dehs or minor districts, those on the frontier being Jalk and Kalagán. Below these two last-named is Kuhak, including Kumarbasta and Isfandar. This small district belongs to the Naubahrwánia, and, as its chief pays no tribute, cannot be included among the conquests of Persia. It therefore remains as a tract of country within the Kelat frontier. Adjoining Kuhak to the east is the district of Panjgúr, with Párum and other dependencies, which are in the possession of Kelat; while on the Persian side Bampasht is the frontier possession. Below Panjgúr the frontier possessions of Kelat to the sea are Bulaida, including Zamrán and other dependencies, Mand, and Daast. Within the Persian line of frontier are the villages or tracts belonging to Sarbás and Bahu Destiárl. The boundary of Daast is marked by a line drawn through the Drabol hill, situated between the rivers Bahu and Daast, to the sea, in the bay of Gwatar."

The boundaries of the frontier districts or village-lands named are well known, and may be distinguished by mountains, hills, hillocks, rivers, streams, or cultivation. In some places desert tracts occur which can offer no inducement for encroachment on either side, but through which a line may at any time be declared, if necessary, both by geographical computation and the erection of pillars,

The frontiers of Persia on the west, north, and east have now been described. The southern, or more strictly the south-western merging into the southern boundary, is the coast-line of the Persian Gulf and Arabian Ocean. This extends from the Khor Abdullah west to the port of Gwatar east, and may be held to be comprised between the meridians 49° and 61° 30' E. long. It will be observed that the Caspian Sea boundary, on the immediate north of Persia, is only two-fifths of this extent. On the Persian shores of the gulf are the ports of Bushahr (Bushire), Lingah, and Bandar-'Abbás, with the islands of Karag, Shaikh Sh'ah, Hindarábi, Kais, Kishm, Hangám, Hormus (Ormuz), and Larak, of which the last four are habitually held in lease by the imám of Masqat (Muscat). On the Perso-Baluch coast are the telegraph stations of Jask and the quasi-ports of Chárbár (or Chahbár) and Gwatar. In some parts of the generally dry and barren coast are ranges of rugged mountains, sometimes rising to a very considerable height.

*Physical Geography.*—Major (now Sir Oliver) St John, R.E., is perhaps the latest recognized authority on the physical characteristics of the large extent of country comprised within the boundaries just described. He has himself surveyed or travelled over no insignificant portion, and has carefully studied the labours of his colleagues and predecessors in a similar field. In the following adaptation of that officer's account of its orography and hydrography attention has been given to the results of independent observation, as well as to those theories put forward by other travellers which seem to merit acceptance.

Persia—that is, modern Persia—occupies the western and larger half of the great Iranian plateau which, rising to a height of from 4000 to 8000 feet between the valleys of the Indus and Tigris, covers in round numbers more than a million square miles. Taking the Kuren Dag and Kopet Dag to form the northern scarp of this plateau east of the Caspian, we find a prolongation of it in the highlands north of the political frontier on the Arras, and even in the Caucasus itself. In St John's own words:—"The Caucasian provinces of Russia are but an excrescence of the great elevated mass to the south-east; differing from it only in characteristics produced by the more bounteous rainfall which has scooped out the valleys to a greater depth." On the north-west Persia is united by the highlands of Armenia to the mountains of Asia Minor; on the north-east the Paropanisus and Hindu Kush connect it with the Himalayas of ancient India. The lines of boundary on the western and eastern faces are to be traced amid high ranges of mountains broken here and there by deserts and valleys. These ranges lie for the most part north-west and south-east, as do those in the interior, with a marked exception between Tehran (Teheran) and Bájínúrd, and in the more recently acquired territory of Baluchistan, where they lie rather north-east and south-west, or, in the latter case, sometimes east and west. The real lowlands are the tracts near the sea-coast belonging to the forest-clad provinces of the Caspian in the north and the shores of the Persian Gulf below Basrah and elsewhere.

With regard to the elevation of the Persian mountains, the Russian Caspian survey gives to the highest, Damávand, 18,600 feet, and to Mount Savalan in Adarbaijan (Azerbaijan) 14,000. St John estimates the Kuh Hazár and summits of the Jamal Bárix in the province of Karman (Kirman) at a greater figure than the last, but he believes the chain of the Kuh Dinár—snow-clad mountains in Fárs, visible from the sea at a distance of 130 miles, and over ranges known to be 10,000 feet high—to present the highest continuous range in Persia. To the Kúrd range, between Ispahan and Kashan, he gives an elevation of above 11,000 feet, and notes the absence of prominent spurs in all ranges

except the Alburz (Elburz), and to a lesser extent in the Khurásan hills.

The Khúzistan delta is cited as the only plain of extent and importance at sea-level. In the north-west, that part of the Moghan steppe which belongs to Persia and the delta of the Saffid Rúd are large and fertile tracts. St John writes:—

"Inland the long and narrow plains between the ridges rise gradually from 1000 feet to eight times that height in the valleys between the ridges on the east-side of the western water-parting, and 4, 5, and 6000 farther south and east. The plains of Isfahan, Shiráz, and Persepolis are about 5000 feet; that of Karmán somewhat higher. The valleys of Adarbáijan present alluvial slopes furrowed by torrents, and the only extensive tableland in Persia, that of Sultánah.

"As they recede from the east and north, the intervals between the ridges are wider, and the rainfall smaller, till grassy valleys are replaced by gravelly deserts, which culminate in wastes of shifting sand. The valley between Abádán and Yazd, a prolongation of the Zaidarúd valley, contains the first of these sandy wastes, which, under the influence of the strong south-easterly winds, occasionally invade the neighbouring cultivated tracts. The original city of Rhages, south-east of Tehrán, is said to have been abandoned on this account."

Estimating the extent of Persia proper at 610,000 square miles, St John thus distributes the drainage:—(1) into the Arabian Sea and Persian Gulf, 130,000; (2) into the Caspian and Aral Seas, 100,000; (3) into the Sístán Lake, 40,000; (4) into the large lake of Úrmíya or Úrumiyah, 20,000; (5) interior drainage, 320,000. No. (1) comprises the south-west provinces and the whole of the coast-region up to the small port of Gwatar in Baluchistan; (2) relates to the tracts south, south-west, and south-east of the Caspian; (3) is the tract adjudicated to Persia, including the Hámún and part of the Helmand basin; (4) is a comparatively small area on the western frontier containing the basin of Lake Úrmíya, shut off from the rest of the inland draining of Persia; (5) takes in Ispahan, Karman, and the province of Khurásan, with the Daht-i-Kavir, or "Great Salt Desert." He points out that the area draining into the ocean consists of a long strip nearly parallel to the Tigris and sea-coast without a single protrusion inland, but is uncertain whether an outlet exists from the Bampur plain in Persian Baluchistan to the sea. A later traveller, Floyer, mentions the names of two rivers debouching on the coast, namely the Sadaich and Gabrig, which might represent such outlets, but their courses have not been traced with sufficient completeness to supply a solution to the problem. If the native evidence taken by Major Goldsmid at Fanooh in 1866 can be relied on, the river entering the pass of that name from the highlands of Bampur, after undergoing two or three changes of nomenclature, passes out into the ocean as the Kálíg.

According to St John, a narrow strip of land, not more than 30 to 50 miles wide, along the southern coast of the Caspian, drains into that sea. On the west it suddenly widens out to a depth of 250 miles, meeting the watershed of the Tigris on the one side and that of the Euphrates and Lake Van on the other, and embracing between the two the basin of Lake Úrmíya, which forms with the basin of Lake Van what may be termed the supplementary plateau of Armenia, differing only from the Persian and Helmand basins in its superior altitude and smaller area. On the east the watershed of the Caspian gradually increases in breadth, the foot of the scarp extending considerably to the north of the south-east angle of that sea, three degrees east of which it turns to the south-east, parallel to the axis of the Kuren and Kopet ranges, which, as before stated, are a prolongation of the Caucasus. A little short of Herat the Caspian water-parting turns eastward, separating the valleys of the Hari Rúd and Hárút rivers. West of Herat the desert plateau of Kháf divides the Caspian from the Helmand basin,

The three rivers belonging essentially to Persia, in reference to the Caspian watershed, are the Kísil Uzain or Saffid Rúd on the south-west and the Atrak and Gurgan at the south-eastern corner of that inland sea. The first is stated by St John to drain about 25,000 square miles of country east and south of the Úrmíya basin. According to Colonel Stewart, the Atrak has its source in the Hazár Masjid range of mountains, a distance, probably, of 250 miles as the crow flies, from the river mouth. The Gurgan rises to the west of it and passes to the sea south of the Atrak. Observing that the Tajand, taking a sweep round Sarakhs, forms a swamp in the Atak about the 58th meridian, the same authority explains that as far south as 30° N. lat.—

"the eastern slopes of the ranges which shut off the valley of the Helmand from the deserts of eastern Persia drain directly towards the Sístán Lake. South of that parallel the surplus water flows by several channels in a south-easterly direction, or away from the lake. About latitude 29°, the water-parting of the Balúchistán mountain-system, running east and west, changes the direction of these streams, and collects them into a single channel, which, under the name of the Maahkid river, bursts through the northern scarp of the Balúch hills into the Khárán desert. Here it takes a north-westerly course, thus reversing the original direction of its waters, which are lost in the desert not far from their most northern sources. It is very probable that these, finding a subterranean channel some distance farther to the north, aid to fill the Zirreh swamp, the southern of the three depressions which, united by flood-waters, form the Hámún or Sístán Lake."

The great central area of Persia, included in the watersheds he has described, "forms a figure nearly triangular, with a base running south-west about 1000 miles long, and nearly equal sides north and east of 700 miles."

St John observes that the streams draining southern and western Persia into the sea diminish regularly in importance from north-west to south-east. He notes the Diyálah and Karkhah flowing into the Tigris from the mountains of Kurdistan; the Dis and Kárún, which unite below Shústar (Shuster), and reach the Shattu 'Arab at Muhamrah; and the Jaráhi and Táh, which with the Kárún form "the delta of Persian Arabistan, the most extensive and fertile plain in Persia." After these he lays stress upon the fact that not a single stream unfordable at all seasons bars the passage of the traveller along the coast till he reaches the Indus. Those rising amid the high mountains north of Bushahr and Bandar-'Abbás are, with the exception of the Mira, which debouches at 60 miles below Bushahr, nameless in the most trustworthy maps; and in Persian Baluchistan we have the Jagín, Gabrig, Sadaich, Rábij, Kair, and Kájú.

The Kárún merits especial notice as a navigable river for small steamers up to within a mile or two of Shústar, though not favourable to the establishment of a regular service, owing to the existence of rapids at Ahwaz. By land there are perhaps somewhat more than 100 miles from Muhamrah to Shústar; and Colonel Champain, an excellent authority, states that from Shústar to Ispahan the distance is as nearly as possible the same as from Shirás to Ispahan, the high road for ordinary travellers passing to and fro between Tehran and the sea-coast. Little need be said on the streams having no outlet to the sea, the water of which is utilized by cultivators both before they reach the alluvial plain between the ranges and afterwards in irrigating the banks. Referring to these St John notes the constant affluents which prevent the rapid exhaustion of water, and the salt swamps or lakes formed by the rivers at points far removed from their source. Six of these inland streams he mentions by name, viz., the Ají Chái and Jaghatu, flowing into the salt-lake of Úrmíya; the Hamadan Rúd or Kára Sú and the Shúráb, flowing eastwards to the Salt Desert; the Zainda Rúd, a river of Ispahan, lost in an unexplored swamp; and the Kúr or Bándamir, which forms the salt-lake of Nírís. He sees

cause for believing the lakes of Shiráz and Kazrún to be fed mainly by springs.

St John writes further:—

"It will be readily believed that the rainfall on the Oceanic and Caspian watersheds is far in excess of that on the interior. Wherever the water-parting is formed, as it is in most parts, by a lofty mountain ridge, it intercepts the moisture-bearing clouds from the sea which are discharged from its outer slopes. The Alburz chain, which shuts off the plateau from the Caspian, may be taken as the typical instance of this. Its northern face is furrowed into deep valleys by the constant and heavy showers which have clothed them in forests of almost tropical luxuriance, while the southern generally presents a single abrupt scarp, rising above long gravel slopes, unchanneled by anything worthy the name of a river, and bare of any vegetation rising to the dignity of a tree. At the most moderate estimate the rainfall of Gilán and Mazandarán may be taken as five times that of the adjoining districts across the ridges to the south.

"In other parts, however, we find the water-parting considerably below the level of the summits farther inland; and here the interior has a more plenteous rainfall than the coast. This is particularly the case in south-eastern Persia, where the Khurasán, Sarhad, and Dizak hills, far exceeding in altitude the ranges to the south, attract to themselves the major portion of the scanty supply of moisture borne inland from the sea. Again the rainfall differs very much in different parts of the country, under apparently similar conditions as regards mountains and distance from the sea; the east and south being far drier than the north and west, while the dampest parts of the Tigris valley have not half the rainfall of the southern and south-eastern shores of the Caspian.

"Two palpable causes unite to produce the prevailing winds throughout Persia and the Persian Gulf. These are, with an extraordinary uniformity, north-west or south-east. The first cause is the position of the Black Sea and Mediterranean on the north-west, and of the Arabian Sea on the south-east. The second is the bearing of the axes of the great mountain chains, which lie mainly in the same direction, and thus tend to guide the currents of air in a uniform course. The south-west, moreover, is not felt, except as moderating the temperature of the Makrán coast inside a line from Ras-al-Hadd, south of Maskat, to Karachi.

"The effect of the sun on the great Iranian plateau is to produce a heated stratum of air, which, when it rises, is succeeded by a current from the colder atmospheres above the seas to the south-east or north-west. Naturally the latter is the colder, and therefore, as might be expected, north-west winds are most prevalent. But in southern Persia and the gulf it often occurs that the two currents meet, and that a north-westerly gale is raging at Bushahr while a south-easterly is blowing at Bandar-Abbas. This latter wind is the rain-bearer throughout the greater part of Persia, the exception being the north-west, where occasional rain-clouds from the Black Sea and the Caspian find their way across the Kúrdish mountains or the Alburz. It is true that it often rains even on the gulf during a north-wester, but only when this has followed a succession of south-easterly gales, the moisture borne by which is returned from the opposite quarter."

There are no sufficient statistics available accurately to estimate the rainfall in Persia, but St John, himself a resident of some years in the country, was of opinion that in no part of it excepting the watersheds of the Caspian and Persian Gulf (north of 28° lat.) and their immediate reverse slopes, with perhaps the Úrmíya basin, is there an average of 10 inches, taking mountain and hill together. He believed that throughout the greater part of central and south-eastern Persia and Baluchistan the annual rainfall could not be much more than five inches, and that, were it not for the snow stored on the lofty hills, nine-tenths of the country would be the arid desert which one-half was found to be when he wrote (1876). Cultivation is carried on mainly by artificial irrigation, the most approved arrangement being an underground tunnel called "kanát," whereby wells are connected and supplies of water ensured.

One remarkable feature in the plains of Persia which naturally engaged St John's attention was the salt-swamp called "kavir." He applied the term to those bogs of almy mud found in the lowest depressions of the alluvial soil, where the supply of water, though constant, was insufficient to form a lake. In winter they are covered with brine, and in summer with a thick crust of salt. The principal kavir is that in Khurasán, and marked in the maps as the Great Salt Desert. St John describes

it as "the eastern part of what is probably the most extensive plain in Persia, that intercepted between the Alburz and its parallel ridges on the one hand and the heads of the ranges of the central plateau which run south-east on the other. Westward, it is divided into two valleys, originating, one in the Sultániah plateau, and the other north of and near Hamadan. These are drained by rivers named respectively the Shúráb and the Kára Sú, which, with another considerable affluent from Turshiz, on the east, unite to form the great kavir." He was unable to determine the altitude of this extensive swamp further than that it might be below the level of the sea, but could not be much above it.

Other kavirs he finds in the Sarjan or Sayidábád plain west of Karman and in the neighbouring valley of Kútrú. Among ordinary kavirs, which are "innumerable," he considers the largest to be on the south of Kháf, and the best known that north of Kúm.

It is clear, from the description given, that the range of these particular salt-swamps or kavirs is confined to the actual depression which has been directly affected by the passage of water, and that the term is not intended to apply to the surrounding wastes. But it seems to have been otherwise understood by the generality of travellers, and the better-known writers on Persia have seldom made the actual distinction here implied. Malcolm in 1800 crossed a "salt-desert" between Pul-i-Dallak and Haus-i-Sultan, which, he says, was called Darys-i-Kabir, or "the great sea." Morier, nine years later, calls the place the "swamp of kavir, . . . part of the great desert which reaches unto Khurasán, the soil of which is composed of a mixture (at least equal) of salt and earth." Colonel Johnson, passing over precisely the same road in 1817, describes it as leading "over a saline plain, leaving here and there hollows of considerable magnitude, white with salt; . . . eastward it stretches as far as the eye can see, and is said to reach to Mausila, distant 40 miles." The writer would probably have been surprised to learn that it extended for at least ten times the distance named. He does not, however, use the word "kavir," which, while duly recorded as a Persian word in the dictionary, meaning salubrious ground, is strangely like the Arabic adjective "kabir," which Malcolm, as just mentioned, has coupled with "darys" in his *Sketches of Persia*. St John states that in the south the salt-swamps are called "kafeh."

The last writer asserts that but one European, Dr Buhár, a Russian, had seen the true kavir, having crossed it in about 84° lat., when going from Damghan to Yazd. Sir Charles Macgregor must have been close upon this traveller's track in 1875, for in the district of Biabának (the "little desert"), which he visited, one of the eight villages, Jandak, is marked in St John's map as an oasis just above the parallel mentioned. Biabának is, according to Macgregor, situated "south of the kavir," but it is joined to Semnan (on the Tehran-Mashhad highway) by a "regular road" which "crosses a bit of kavir of about 80 miles without water."

The drier deserts of Karman and Bampur cannot be included in the category of swamps; and the term "lut," made use of by the Russian geographer Khanikoff in reference to the former, whatever its original derivation, must simply be accepted as the common local expression, in eastern Persia and western Baluchistan, for a waste waterless tract.

*Geology.*—Mr W. T. Blanford has given us an interesting sketch of the geology of Persia. He found that by far the greater number of those who had treated the same subject before him had restricted their inquiries to the north-western provinces, and that few had penetrated east of Damávand or south of Tehran. Mr Loftus had imparted a fair knowledge of western Persia, and Russian and German explorers had made students tolerably acquainted with Adarbáijan, Gilán, and Mazandarán. Khurasán and eastern Persia generally were, however, in a geological sense unknown, and the south was almost equally a *terra incognita*, unless exception were made for certain stray observations on the shores of the Persian Gulf. The following passages are extracted from his paper.

"The most striking circumstance noticed during a journey in Persia is the great prevalence of formations, such as gravel, sand, and clay, of apparently recent origin; the whole of the great plains, covering at least one-half the surface of the country, consist either,

of a fine, pale-coloured alluvial loam, which covers the lowest portion of the surface, or of gravel, fine or coarse, which usually forms a long gentle slope from the surrounding hills to the alluvial flat, and fills up with long slopes the broad valleys opening into the larger plains. All these deposits are more conspicuous than they are in most countries in consequence of the paucity of vegetation and the absence of cultivation throughout the greater part of the surface. Nor is this prevalence of recent or sub-recent detrital accumulations confined to the plains, for the slopes of the hills up to a considerable elevation are in some cases composed of similar unconsolidated formations, from which only occasional peaks of solid rock emerge. This, however, is by no means universally the case, many ranges consisting entirely of rock. Again, the descent in Baluchistán from the plateau to the sea-coast is over broad terrace-like flats of gravel and sand, separated from each other by ranges of hills running parallel to the coast-line.

"The mountains and hill-ranges of Persia comprise a considerable variety of geological formations, a few of which, however, prevail over large areas of country. So far as our knowledge at present extends, the great mass of the Zagros chain (the term being used in the widest sense for the whole mountain-range from Mount Ararat to Shiráz, together with the numerous parallel minor ranges north-east of the main chain) consists of cretaceous (hippuritic) and tertiary formations, the former constituting the north-east half of the range and its slope towards the central plain of Persia, whilst the nummulitic and later formations prevail almost exclusively on the south-west watershed overlooking the Tigris valley. Older rocks occur, but they are of subordinate importance, and it appeared probable, both to Mr Loftus and myself, that part at least of the altered rocks which form no inconsiderable portion of the range to the north-east is very probably of cretaceous origin. Old granite rocks, however, form a great band, extending from Lake Urumiah to a point nearly due west of Isfahán, and the same crystalline masses appear in the ranges between Isfahán and Káshán."

The general direction of the Persian mountains north-west to south-east has already been noticed. Speaking of these, Blanford says that, so far as they have been examined, "they have the same geological features as the Zagros, and consist similarly in the main of cretaceous and nummulitic rocks, the former prevailing to the north-east towards the desert, the latter to the south-west near the sea. Here, again, metamorphic rocks occur, some of them granite, others but little altered, and closely resembling in facies the cretaceous beds in their neighbourhood. Volcanic formations also occupy an extensive area, and whilst some appear of very late origin, others are possibly contemporaneous with the cretaceous epoch."

Of the southern border-land of the Persian plateau he writes—"Where crossed by Major St John and myself, between Gwádir and Jalk, it consisted of low ranges running east and west, and, except near the sea, was almost entirely composed of unfossiliferous sandstones and shales, associated with a few beds of nummulitic limestone. So far as could be ascertained, these ranges appear to belong entirely to the older tertiary epoch. Here and there a few isolated masses of basaltic igneous rock have been introduced through the strata, but their occurrence is exceptional. Along the sea-coast, however, from the frontier of Sind to the Persian Gulf, and probably throughout a large portion of the north-east shores of the gulf, a newer series of rocks rests upon the nummulitics. This newer series is easily recognized by the presence of thick beds of hardened clay or marl; it is of great thickness, and abounds in fossils, a few of which appear to be living forms, whilst others are extinct. The exact age has not been ascertained; the mineral character is very different from that described by Loftus as characteristic of the gypseous series, and it is therefore premature to class these beds of the Persian coast, for which I have proposed the name of Makrán group, more definitely than as newer tertiaries. It is highly probable that they represent a portion at least of the gypseous series. Along the coast itself are a few mud-volcanoes."

Remarking that hippuritic limestones had not been noticed on the eastern frontier, he turns to north-western Persia, a region "widely explored by various Russian and German travellers."

"There would appear, both in Adarbajján and the Alburz range, to be a greater development of older Mesozoic and Palæozoic formations than in any other parts of western or in southern Persia. From the very brief visits I was enabled to pay to the Alburz and the small area examined, I can form but an imperfect conception of the range as a whole, but the impression produced by my visits is that the geological composition of this mountain-chain presents a striking contrast to that of all other parts of Persia which I had previously seen. It appears probable that a very considerable portion of this range consists of carboniferous and Devonian beds, and that Jurassic or Liassic rocks are also extensively developed. The same formations extend to Adarbajján, but here, as well as in the eastern parts of the Alburz, cretaceous and nummulitic rocks are also found. Metamorphics (granite, &c.) exist in several places,

<sup>1</sup> It has since been found extensively in southern Afghanistan and around Kwatta.

whilst volcanic outbursts occupy a considerable area, and the highest mountain in Persia, Damávand, in the Alburz chain, about 60 miles east-north-east of Tehran, is a volcano which, although dormant in the historical period, is of recent formation, and still gives vent to heated gases. The volcanic masses of Ararat, Sabend, south of Tabriz, and Saválán are also, in great part at least, of geologically recent origin."

*Minerals, &c.*—Of the value and extent of minerals in Persia much still remains a matter of surmise. Iron and lead are to be found, copper and coal also, but gold and silver have not yet become substantial results, and the turquoise is perhaps the only product of high price and estimation. This gem, however, is not readily procurable at Nishápúr, its birthplace, but should rather be sought for at Tehran or Isfahan, where it comes into the market with other exotics. The mines are situated at the base of the hill of Sulaimaniyah, lying north of Zamánabád, a village on the high-road from Mashhad to Tehran. When the Sístan mission was at Nishápúr in 1872 they were farmed by the Government for 8000 "tumáns" per annum, or about £2300 in English money.

In Malcolm's days, though coining was held to be a choice privilege of royalty, foreign piastres and ducats were in considerable vogue. Accounts are kept in "tumáns," "kráns," and "sháhs," of which the value of the first has deteriorated to 8s., the second is barely the French franc, and the third is about a halfpenny. Less than the last is called "pul-siyáh," or black money. The "sháhi" and the "panabat," a silver coin worth about 5d., have for long been in common circulation. In late years the manufacture of false money and forging the royal seals had become such common practices that the old rough hammer-struck coinage was called in, and medals in gold and silver with milled edges were substituted. But these also were counterfeited, and a head of police was called in from Austria to endeavour to check the evil.

The Yazd marble has a watered appearance with yellowish tinge. A handsome specimen is to be seen in the tomb of Háfiz at Shiráz. There is a quarry on the road from Yazd to Karman. The perfumations called Tabriz or Marígha marble are found on the road between those two places.

Eastwick describes the coal obtained from the pits at Hit, in the hill-country west of Tehran, as light, brittle, glittering, and with occasional red stains. There were no large blocks visible.

Though petroleum and naphtha appear indigenous to Persia, and Floyer visited an oil-spring in Báshakard, the produce of which was burnt in lamps at Míráb near Bandar-Abbás, the produce of the oil-wells at Báki has found its way to Mashhad, and meets there with a ready sale. In connexion with this circumstance, Lovett states that a great number of lamps of the most trumpery German manufacture are imported into Khurásán and sold at large profit.

Dr Bellow, referring to the twelve divisions of the district of Nishápúr, and to its 1200 villages and hamlets, mentions the report that it possesses also twelve different mines, yielding turquoise, salt, lead, copper, antimony, iron, together with marble and soap-stone. The statement needs, however, verification.

*Climate.*—The climate of Persia varies much according to locality. In the Caspian provinces, where rain is frequent, it is hot, humid, and unhealthy for the greater part of the year. In the tablelands it is intensely cold in winter, and, though it is hot in summer, its dry clear heat is temperate in comparison with that of Sind and the Punjab. The spring and autumn are the best seasons. In the south and south-west, towards the Persian Gulf and in Baluchistan, the heat is intense throughout the summer and often in the spring and autumn. The three regions of Nearchus and the old travellers—illustrated by parching heat, sand, and barrenness in the south, a temperate climate, pastures, and cultivation in the centre, and severe cold with bare or snow-clad mountains in the north—may still be accepted as conveying a fairly accurate description of the tracts lying generally between Bushahr and Tehran; but of course there are seasons and seasons, and it may be very hot as well as very cold in the north as elsewhere. In June the traveller, starting from the former place *en route* to the capital (Tehran), will for more than 50 miles, or up to the bridge of Dálaki, experience a fierce heat during the day, and not always find relief in a cool night. Reaching the plateau of Kunár Takhtab, 12 miles farther, at an elevation of 1800 feet, he will not then necessarily have escaped the influence of hot winds and a thermometer ranging to 100°. Some 50 miles farther he will have felt a most agreeable change at an altitude of 7000 feet; and in another 24 miles, at Khan-i-Zamian, he will

have had every cause to be grateful for a delightful temperature. Shiráz, though some 4750 feet above sea-level, and in respect of climate so belauded by the native poets, can be hot enough in the summer, and is subject to drought, scarcity, and other contingencies of Persia.

Mounsey considers May the finest month, when the plains are fresh and green, the gardens filled with roses and nightingales, the cherries ripe, and the green almonds in vogue. Binning, writing from Ispahan on the 1st of July, had not seen the thermometer higher than 87° in his room; in the morning at sunrise it was generally 70°. Sleeping, as others, on the roof of his house, he described the air to be very dry, and the nights clear and bright, the little dew which fell being so pure as to be innocuous. He expected hotter weather towards the close of the month, but a long autumn would make amends for little heat. Many years before Binning, Mr Jukes had recorded that, from the average of 27 days, including the end of May and beginning of June, the thermometer at Ispahan at sunrise was 56°, at 2 P.M. 87°, and at 9 P.M. 67°. Sir John Malcolm remarked that this city appeared to be placed "in the happiest temperature" that Persia could boast. Lady Sheil, whose experience were chiefly gained in Tehran, limits the "glorious weather of Persia" from the "Nau-rus" or New Year (21st March) to the middle of May; but most persons would perhaps prefer the autumn in the highlands of the north, as in many other parts of the country. September and October are beautiful months. The blue sky, with its tempering haze, as it were a veil of reflected snow gathered from the higher peaks and ridges of continuous mountain chains, is too exquisite a sight to be readily forgotten; and the enjoyment is all the more complete when the temperature is that of October. To those who come from India direct, or to whom an Indian heat is habitual, the change to Persia is most grateful. In the late spring, fashion moves out a few miles from Tehran to the "yalaks of Shamiran," or cooler residences near the hills, and summer rendezvous of the various foreign legations, returning in the late autumn to the precincts of the capital, which, it may be noted, have been considerably extended of late years, and are designed for yet further extension. On the 5th of June 1871 the thermometer in Tehran was at 1 A.M. at 62° and at 2 P.M. at 75°. On the two following days it was at 6 A.M. at 62° and at 2 P.M. at 80°. In February the traveller across the plains of Sulimaniya, or approaching the capital from Tabriz, will sometimes experience the most bitter cold.

Bushahr and the Caspian provinces have already been mentioned, but the heat of the former place is fairly shared by other ports on the seaboard to the south,—among them, Lingah, Bandar-'Abbás, and Chárbár. When the Sistan mission was at Bandar-'Abbás in December 1871, malarious fevers were prevalent, and enlarged spleen was a common complaint. The average maximum temperature was then only 72° and the minimum 52°; but the summer and winter heats are in this locality extreme. More than a month later the officers of the mission slept out on the desert plains south of Sistan, and woke in the morning to find their beds and bedding covered with frost and icicles. With reference to the Caspian provinces the consular report to the English Foreign Office for 1881 is available. Major Lovett, remarking that the "minimum isotherms passing through the north of continental Europe are deflected considerably to the south on approaching the longitude of the Caspian," calls attention to the fact that, while during the winter the northern part of that large inland sea is frozen over, farther south, at only 10° distance, the climate of Astrábad (if there be no wind from the north and the sun shine) is like that of Madeira at the same time of the year. Though the preceding cold season had been unusually severe, and heavy snow had fallen at Bákrí and lower down, the lowest reading of the thermometer was 25° Fahr., and the maximum during the months of December, January, and February was 62° in the shade.

The following extract from the report is interesting, as it bears on the products as well as the climate of the north of Persia.

"It must be remembered, in connexion with the influence the Caspian Sea has on the climate of its shores, that its surface is 84 feet below the level of the ocean; and, consequently, the superincumbent strata of air being denser than, *ceteris paribus*, elsewhere, it is also more capable of absorbing solar heat and moisture than the air at ocean-level. This partly accounts for the mildness as well

as for the dampness of the climate. I cannot give the amount of rainfall, having no gauge; but it rained, during the 245 days of recorded observations, forty-five times, and the sky was overcast seventy times besides. This tolerable proportion of rain and cloud is doubtless due to the action of cold northerly blasts impinging on the warm and moisture-laden air shrouding the slopes of the Elburz, and hemmed in, as it were, between them and the icy northern wind. Currents thereupon are set up from the central region of the southern shores of the Caspian that blow to the east and to the west. The central region is a zone of much greater rainfall than the districts more remote. The westerly current, passing over this province, has its fertilizing influence expended on reaching the Goklan hills, 100 miles from the sea. The breadth and intensity of this moisture-bearing current is well marked by the gradually proportionate denseness of the vegetation extending from the sands of the Atrak steppes to the mountain summits. The action of these damp winds is distinctly traceable on all portions of the mountain-range exposed to the sea-breeze, even by the channels afforded by the valleys of the rivers that debouch on to the Caspian. Such are densely clothed with forest of a type similar to that found in southerly temperate climates. The flora is distinctly not tropical. In addition to the trees already mentioned, I should add that wild hops and plums are to be found. In the spring the hill-sides are covered with thick excellent pasture. In the gardens and orchards of Astrábad are to be found vines, fig trees, orange trees, pomegranate, and lemon trees, and the vegetables chiefly cultivated are melons, pumpkins, marrows, lettuce, aubergines, &c., that form at their seasons food-staples for the people. Tobacco, used for manufacturing cigarettes, is also grown here on a small scale.

"The Turkman steppe lying north of Astrábad is, as far as the Atrak, a prairie of exceeding fertility. Wheat reproduces itself more than a hundredfold without artificial irrigation or any trouble beyond sowing."

*Soil and Products.*—Where there is irrigation the productiveness of the soil in Persia is remarkable, but unfortunately there is too much truth in the notion that two-thirds of the tablelands of the country are sterile from want of water. The desert is the rule, fertility the exception, and generally in the form of an oasis. Yet wheat, barley, and other cereals are grown in great perfection; there are the sugar-cane and rice also, especially in Mazandaran, where the soil is favourable and water procurable; opium, tobacco, and cotton, madder roots, henna, and other dyes, are as well-known exports as the woollen goods of Persia; and the first may become of importance in its bearing upon the Indian market.<sup>1</sup> In Gilán, famous for its mulberry plantations, silk has been one of the most valuable of products. Yazd and Mazandaran contribute also the same material, but of late years the worm has comparatively failed to do its office, and disease has destroyed crop after crop. According to Mr Secretary Dickson's report of August 1882 the peasants of Gilán had turned their attention to the cultivation of rice, and, though a marked improvement was perceptible in the silk produce, they were not disposed to revert to this branch of culture on the former large scale. "Silk, once the staple produce of Persia, upon which it mainly depended for repaying the cost of its imports, is not likely," he fears, "to resume its former importance. In its flourishing days about 20,000 bales, or 1,400,000 lb, representing a value of £700,000, were annually exported. Now not more than a fourth of that quantity can be obtained." Rice was found to suit the cultivators better; it gave them less trouble and provided them with an article of daily food. The production of silk, on the other hand, profited the richer landed proprietors, and subjected the cultivators to oppression.

Consul Beresford Lovett, in his report before quoted, says that at Astrábad the soil is so productive, and subsistence is practicable on so small a piece of land and with so little labour and expense, that many very poor emigrants come

<sup>1</sup> In 1881 the crop at Karmansháh yielded about 13,500 lb; Ispahan claimed to have produced 3000 chests; in Khurásán it was reported that the cultivation of the poppy had increased tenfold, and so extended was the area that the opium realized was estimated at an eighth of the whole produce of the province, the yield for 1882 being reckoned at 33,750 lb. At Yazd it was largely cultivated, at Tehran to a small extent only.

there to settle from distant parts of Persia, Afghanistan, and the Indian border. "Rice," he writes, "is husked under tilt-hammers worked by a water-wheel apparatus, a rude and clumsy contrivance, but strong, simple, and cheap. Corn and barley are ground by water-mills of primitive construction; the best wheat-flour produced is inferior to English 'middlings.' They are careless as to the use of rusty corn; the effect of eating bread made with flour containing any of the noxious element is to render those unused to it very giddy."

Sir John Malcolm considered the shores of the Persian Gulf to be sandy and unproductive in comparison with the rich clayey soil on those of the Caspian. Yet at Bushahr, and elsewhere on the lowlands of the southern border, patches of luxuriant vegetation may be found and a soil producing wheat and barley.

Vines are abundant, and the Persian grapes are not only of a good flavour and kind, but the wines made from them by the Jews and Armenians have more than a mere local reputation. That of Shíráz is the most universally known and celebrated; but a description of port manufactured at Isfahan is equally palatable and less astringent. It might not, however, bear the vicissitudes of export. A light wine made at Hamadan, diluted with water, is found very drinkable by European visitors and residents. Other cities in Persia could be cited where the juice of the grape is turned to similar account. Samuel Gottlieb Gmelin, who explored the southern shores of the Caspian in 1771, observed that the wines of Gilán and Mazandaran were all made from the wild grape only.

*Flora.*—Eastwick refers to the trees in the low country of Gilán as "part of that great forest which extends some 400 miles from Astarabad to Talish." No longer do the sparse olive and occasional plantation of fruit-trees here meet the eye of the traveller descending from the Persian plateau, but his path will be through dense thickets of "jungal," amid which the birch and the box and many familiar friends are recognized. There is an oak-forest in the vicinity of Shíráz, but no part of the country is so thickly wooded as the tract south of the Caspian. For the greater part of the province of Astrábad, Lovett surmises that nine-tenths of the surface is covered with forest. He excepts the pasture-lands of Sháh Kub, a high mountain-range between Sháh Rúd and the sea. The trees are mostly deciduous. He had counted forty different kinds, including shrubs, but was unable to identify all. There were the oak, beech, elm, walnut, plane, sycamore, ash, yew, box, and juniper, but no pine, fir, or cedar,—though these last were said to exist in the dense forests of Fínderiák, and on the slopes of the Goklan Hills to the eastward. He applies to the oak, beech, and elm used in building the native names of "máru," "núa," and "azad."

Fruits and flowers are abundant, and are fully appreciated in Persia. Poets sing of them, and prince and peasant delight in them. Of fruits the variety is great, and the quality, though not always the best, is in some cases unrivalled. There is perhaps no melon in the world superior to that of Nusrabad, a village between Kaahan and Kúm. It were easier to name the few English fruits—such as the gooseberry, strawberry, raspberry, currant, and medlar—that are seldom, if at all seen, than the many that are commonly enjoyed by Persians. Apples and pears, filberts and walnuts, musk-melons and water-melons, grapes, peaches, plums, nectarines,—all these are to be had in profusion and so cheap as to be within reach of the poorest inhabitant.

Among the flowers are roses of many kinds, the marigold, chrysanthemum, hollyhock, narcissus, tulip, tuberose, convolvulus, aster, wallflower, dahlia, white lily (much valued), hyacinth, violet, larkspur, pink, and many

ornaments of the European parterre. Of the roses, Lady Sheil observes that they are so profuse during the spring at Tehran that some are cultivated in fields as an object of trade to make rosewater. The double-coloured orange rose at Nishápúr is exceptionally attractive and fragrant.

As with fruits and flowers, so also with vegetables for the table. If the parsnip be excepted, which is probably not found because not wanted, all those commonly used in England are to be had in Persia.

*Fauna.*—Mr W. T. Blanford has described with great care and minuteness the zoology of Persia. In company with Major St John, R.E., he made a large collection of the vertebrate fauna in a journey from Gwatar to Tehran in 1872. Having added to this a previous collection made by the same officer with the assistance of a native from Calcutta, he had before him the principal materials for his work. Before commencing his analysis he adverted to his predecessors in the same field, *i.e.*, Gmelin (whose travels were published in 1774-84), Olivier (1807), Pallas (1811), Ménétries (1832), Belanger (1834), Eichwald (1834-41), Ancher Éloy (1851), Loftus, Count Keyserling, Kokschy, Chesney, the Hon. C. Murray, De Filippi (1865), Hume (1873), and Professor Strach of St Petersburg. All of these had, more or less, contributed something to the knowledge of the subject, whether as writers or as collectors, or in both capacities, and to all the due meed of credit was assigned. Blanford divided Persia into five zoological provinces: (1) the Persian plateau, or from the Kopet Dagh southwards to nearly 28° N. lat., including all Khurásan to the Perso-Afghan border, its western limit being indicated by a long line to the north-west from near Shíráz, taking in the whole upper country to the Russian frontier and the Alburz; (2) the provinces south and south-west of the Caspian; (3) a narrow strip of wooded country south-west of the Zagros range, from the Diyah river in Turkish Arabia to Shíráz; (4) the Persian side of the Shattu'l-'Arab, and Khúzistan, east of the Tigris; and (5) the shores of the Persian Gulf and Baluchistan. The fauna of the Persian plateau he described as "Palaearctic, with a great prevalence of desert forms; or, perhaps more correctly, as being of the desert type with Palaearctic species in the more fertile regions." In the Caspian provinces he found the fauna, on the whole, Palaearctic also, "most of the animals being identical with those of south-eastern Europe." But some were essentially indigenous, and he observed "a singular character given to the fauna by the presence of certain Eastern forms, unknown in other parts of Persia, such as the tiger, a remarkable deer of the Indo-Malayan group, allied to *Cervus asiæ*, and a pit viper (*Halys*)." Including the oak-forests of Shíráz with the wooded slopes of the Zagros, he found in his third division that, however little known was the tract, it appeared to contain, like the second, "a Palaearctic fauna with a few peculiar species." As to Persian Mesopotamia, he considered its fauna to belong to the same Palaearctic region as Syria, but could scarcely speak with confidence on its characteristic forms. The fifth and last division, Baluchistan and the shores of the Persian Gulf, presented, however, in the animals common to the Persian highlands "for the most part desert types, whilst the characteristic Palaearctic species almost entirely disappear, their place being taken by Indian or Indo-African forms." Blanford adds: "Just as the fauna of the Persian plateau has been briefly characterized as of the desert type with a large admixture of Palaearctic forms, that of Baluchistan and the shores of the Persian Gulf may be described as being desert with a small admixture of Indian species." Irrespective of scientific classification and detail, it may be stated that among the tame animals of Persia the horse, mule, and camel occupy an important position, and, jointly



perhaps with oxen (used for tilling purposes), are first and foremost in usefulness to man. The Persian-Gulf Arab, though not equal to the pure Arabian, is a very serviceable animal, and has always a value in the Indian market. Among others, the Kashgais, or those wandering semi-Turkish tribes brought down from Turkestan to the neighbourhood of Shirás, have the credit of possessing good steeds. The Türkman horse of Khurásan and the Atak is a large, bony, and clumsy-looking quadruped, with marvellous power and endurance. Colonel C. E. Stewart speaks of a "splendid breed of camels" in the north-eastern district, of which Radkan, a small town of 4000 inhabitants with a deputy-governor, is the capital. He also states that the Khurásan camel is celebrated for its size and strength, that it has very long hair, and bears cold and exposure far better than the ordinary Arabian or Persian camel, and that, while the ordinary Persian camel only carries a load of some 320 lb and an Indian camel one of some 400 lb, the Khurásan camel will carry from 600 to 700 lb. The best animals, he notes, are a cross between the Bactrian or two-humped and the Arabian or one-humped camel. Sheep, goats, dogs, and cats are good of their kind; but not all the last are the beautiful creatures which, bearing the name of the country, have arrived at such distinction in Europe. Nor are these to be obtained, as supposed, at Angora in Asia Minor. Lake Van or Ispahan is a more likely habitat. The cat at the first place, called by the Turks "Van kedisi," has a certain local reputation.

Among the wild animals are the lion, tiger, leopard, lynx, wolf, jackal, fox, hare, wild ass, wild sheep, wild cat, mountain-goat, gazelle, and deer. The tiger is peculiar to the Caspian provinces. Lovett says they are plentiful in Astrábad; "they do not attack men, but hardly a week passes but some cow belonging to this town is reported to have fallen a victim to the tiger's rapacity." He measured two specimens, one 10 feet 8 inches, the other 8 feet 10 inches from the tip of the nose to the end of the tail. Lynxes and bears were to be found in the same vicinity, and the wild pig was both numerous and destructive.

Poultry is good and plentiful, and the game birds, if not of many varieties, have admirable representatives in the "durráj" (black partridge) in the three kinds of partridge called respectively the "kabk," "kabk darah," and "tihá." The "hubára," a kind of bustard, is well known to the sportsman in northern India.

*Commerce, &c.*—The most direct and accurate information obtainable in England on the trade of Persia must be looked for in the reports of the secretary of H. M. Legation at Tehran, the resident at Bushahr (Bushite), and the consul-general at Tabriz.

Mr Secretary Dickson's report of the 30th August 1882 is hopeful as to the general prospects of trade and improvement of the condition of the people. There had been a good harvest; but money was scarce at the capital, cash sales were difficult operations, and considerable failures had occurred to render the native bankers cautious. Manchester goods, however, still sold well at Ispahan and elsewhere.

The comparative failure of silk had given an impetus to the cultivation of opium, the greater part of which, when prepared for the market, was shipped to China. Carpets had found new favour in Europe, and the value of those exported was estimated at ten times the amount of former days. But a fear was expressed that the introduction of European designs and dimensions, and deterioration in quality of the articles supplied, would eventually prove prejudicial to the trade.

The larger traffic in opium effected both in 1880 and immediately preceding years is remarkable, and will be seen in the following table—

Year.	Number of Cases.	Value in Rupees.	Year.	Number of Cases.	Value in Rupees.
1871-72	870	696,000	1876-77	2670	2,313,000
1872-73	1400	1,130,000	1877-78	4780	4,780,000
1873-74	2000	1,800,000	1878-79	5200	5,900,000
1874-75	2000	1,625,000	1879-80	6100	6,100,000
1875-76	1800	1,701,000	1880-81	7700	8,470,000

Persian opium was, it appears, first exported from Ispahan in

1858. Since that period it has been grown in several parts of the country. The destination is usually China. In 1879, for instance, eighteen steamers took 497½ chests from Bushahr, of which all but 236—for London—were for Hong-Kong. Except in Ispahan, there is every probability of extended cultivation, and that the production will increase to an appreciable degree year by year. In the statement of a private firm, quoted by Mr Baring in his report from Tehran in September 1881, is the following passage:—"The Persian drug has already succeeded in throwing out Turkish sorts from the China market, and, with due abstinence from adulteration, it can at any moment command a large outlet in Europe, America, and in the Dutch colonies." Mr Baring himself says: "Whether the Persian opium trade in its present conditions constitutes a danger to the Indian revenue is, of course, a question to which I can furnish no reply. It depends upon circumstances respecting which I have no information. As matters at present stand, we have a trade that has been increasing steadily for several years past, and which the majority of persons think will continue to increase. The cultivation pays, and the limit of land and labour has not yet been reached. There are so many reasons, in fact, why it should extend, so few why it should fall off."

Carriageable roads were still a desideratum, and the want of these obstructed the development of trade. On the other hand, it was remarked that a fair road had been constructed between Kárvín and Tehran, a supply of carriages and carts had been obtained from Russia, and postal stations had been built at regular distances of 12 miles from each other. In the capital also the streets had been put into repair, and the palace, square, and main streets lit with gas; and there was a greater number of private carriages. A concession had been granted for a railway from Rasht to Tehran; Mr Dickson, while approving of this line as a step in the right direction, was very strongly in favour of another to join Tehran to Baghdád. A branch from Karmanaháb or Hamadan to Shústar or Dízfúl, whence goods could be exported by the Kárvín, would, he argued, give Persia an independent outlet for her commerce; but he doubted whether Baghdád, with its prestige and advantages of climate, would not be accepted as the main commercial entrepôt. The navigability of the Kárvín river has been already noticed.

The Bushahr reports on the trade of the Persian Gulf for 1880 show that, as regards southern Persia, the year was unfavourable from a commercial point of view. Large imports from India served to avert famine; but the seed so provided for 1881 was not at hand in time to allow full advantage being taken of an unusually good rainfall in autumn and winter. Increased imports in sugar from France and Java, the introduction of tea from Japan, and a decrease in exports of cotton and other ordinary produce owing to drought were all noticed.

The table showing the total estimated value of imports into Bushahr during the year 1882 gives a total of 10,188,980 rupees,—say something less than £1,000,000. Of this about four-ninths are from England and more than a third is from India. Of the exports, amounting to 6,566,220 rupees,—say £650,000—more than two-fifths are for China, not a fifth is for England, and more than a fifth is for India. The most valuable items of import are the piece-goods and brass,—the last from England and India only; and of export, opium, of which just three-fourths go to China, and wheat, of which more than two-thirds go to England.

As regards the trade of Lingah, the year 1882 showed a decrease. The total value of imports was 6,922,000 rupees, of which pearls formed the largest portion. These were brought chiefly from Bahrain and the Arab coast, but some from the Persian Gulf and Makran and Aden. Rice, almost wholly from India, was the next most valuable item. The total value of exports was 5,999,945 rupees. In this also pearls formed by far the largest item. Next in value mother-of-pearl shells exemplified a traffic almost entirely carried on with England.

From Gez on the Caspian, Consul Lovett gives to the exports of 1881 a value of £86,280. These consisted of silk, cotton, wools, furs and skins, dried fruits, rice, corn, and miscellaneous articles. Silk represented nearly the half, and furs and skins nearly a quarter of the total figure. The imports he valued at £287,640, of which the amount for piece goods was entered at £256,000. The remaining articles specified were sugar, tea, iron, copper, steel, crockery, hardware, and brass utensils.

*Manufactures, &c.*—The handbook on Persian art published by Colonel Murdoch Smith, R. E., in 1876, with reference to the collection purchased and sent home by him for the South Kensington Museum, has an instructive account of the more common manufactures of the country. They are classified under the respective heads of "porcelain and earthenware," "tiles," "arms and armour," "textile fabrics," "needlework and embroidery," "metal-work," "wood carving and mosaic-painting," "manuscripts," "enamel," "jewelry," and "musical instruments." Specimens of the greater number are not only to be procured in England, but are almost familiar to the ordinary Londoner. It need scarcely be said that the tiles have rather increased in value than deteriorated in the eyes of the connoisseur, that the ornamentation of metal-work, wood carving and inlaying,

gem and seal engraving, are exquisite of their kind, and that the carpets manufactured by the "ustāds" or skilled workmen of local repute, when left to themselves and their native patterns, are to a great extent unrivalled. One shown to Colonel Goldsmid at Karman, under preparation for the tomb of Shāh Niyāmat Ullāh, situated at the neighbouring village of Mahun, would have been greatly prized in Europe. In company with Murdoch Smith that officer visited the carpet manufactories of the city in 1865. Of this interesting branch of Persian art Smith writes:—"Carpets are now made in many parts of Persia, but chiefly in Kurdistan, Khurasān, Feraghān (in Irāk), and Karman; each of these districts producing a distinctive kind both in texture and style. The finest are unquestionably those of Kurdistan, of which good specimens exist in the museum. The pattern does not represent flowers, bouquets, or other objects thrown up in relief from a uniform ground, like so many of the inappropriate designs of Europe, but looks more like a layer of flowers strewn on the ground, or a field of wild flowers in spring; a much more suitable style of ornament for a fabric meant to lie under foot. The borders are always well marked and usually of brighter colours than the centre. Besides the ordinary 'kali,' or pile carpet, others, called 'do-ru,' very thin and smooth and alike on both sides, are made in Kurdistan, of which there is a specimen in the museum. These 'do-ru,' from their portability, are much used in travelling for spreading by the roadside during the halts for pipes and tea. The carpets of Feraghān resemble those of Kurdistan in style, although the texture is looser and the pattern simpler. They are consequently much cheaper and in more general use. . . . The Khurasān carpets are somewhat superior in texture to those of Feraghān, but the patterns are generally more realistic; the flowers, &c., being represented as standing out of the ground. There is a fine Khurasān carpet in the museum made by the Kurdish settlers on the Turkman frontier. Karman carpets are the next in value to those of Kurdistan, but the designs are usually still more realistic than those of Khurasān. Besides flowers, figures of men and animals are not uncommon." Referring to the Turkman carpet he says: "The texture is very good and the pile is peculiarly velvety to the touch. The design, however, is crude, and the colours although rich are few in number. Still it is astonishing to think that, such as they are, these carpets are woven in the tents of a wild nomadic race like the Turkmans. Of late years there has been unfortunately a slight importation from Europe into Persia both of colours and designs which are far from being an improvement. The carpets of every description are made without even the simplest machinery, the loom being simply a frame on which the warp is stretched. The woof consists of short threads woven into the warp with the fingers without a shuttle. When a row of the woof is thus completed, a sort of comb is inserted into the warp and pressed or hammered against the loose row of woof until it is sufficiently tightened to the rest of the web. The pile is formed by merely clipping the ends of the woof until an even surface is obtained. The weaver sits with the reverse side of the web towards him, so that he depends solely on his memory for the formation of the pattern. . . ."

Felts or namads are made in many parts of Persia, but chiefly at Isfahan and Yazd. The material consists of all kinds of wool mixed together, that of the camel predominating. The colour is generally brown, but the surface on one side, and sometimes on both, is ornamented with geometric and other designs in different colours which are inlaid (so to speak) in the namad, and not simply stamped on the surface.

The shawls of Karman are not much inferior to those of Kashmir. They are woven by hand similarly to the carpets. The material called 'kurk' of which the shawls are made is the under wool of a particular kind of white goat: numerous flocks of this animal are in the neighbourhood of Karman. Like the merino sheep in Spain, these flocks migrate annually according to the season, in which respect they are like almost all the flocks and herds of Persia. I therefore made enquiries at Karman why the 'kurk' producing goats were only to be found in that neighbourhood, and was informed that in that district the rapid descent from the high plateau of Persia to the plains near the sea afforded the means of keeping the flocks throughout the year in an almost even temperature and in abundant pastures, with a much shorter distance between the summer and winter quarters than in other parts of Persia, and that such an even climate without long distances to traverse in the course of migration was necessary to the delicate constitution of the animal, or rather to the softness of its wool. The whole of the 'kurk' is not made use of in the looms of Karman, a large quantity being annually exported to Amrīsar in upper India, where it is manufactured into false Kashmir shawls. Besides the ordinary long shawls of which men's and women's tunics are made, others of a single colour are made at Karman, which are afterwards richly ornamented with needlework. Of these there are in the museum several specimens, in which the softness of the shawl and the richness of the embroidery are both to be admired. Shawls of a coarser kind are also made at Yazd, of which a specimen may be seen in the museum in a pair of door curtains."

*Political Divisions.*—According to the latest information obtained, or up to 1884, the 36th year of the reign of Nāsur d-Din Shāh, Persia is found to be partitioned out into four large divisions and six smaller governments, of which governors-general or governors are appointed by the king. The four divisions are:—(1) Adarbaijan (Azerbaijan) in the west; (2) N. North Central Districts; (3) Khurāsān in the east, including Sīstān; (4) Southern Persia, c. from the Shattu'l-'Arab to the Masahid. The minor governments are:—(5) Astrābād, (6) Mazandaran, (7) Gilān, (8) Khamseh with Zanjan, (9) Karvīn, (10) Gerus.

Adarbaijan, the ancient Atropatene, is under the "wali-'abd," or heir-apparent, Mupaffarū'd-Din Mirza, second son of the shāh, who resides at Tabriz, and appoints governors to the several districts within his range. Among the more important of these are Ardabil, Sarāh, and Khalkhāl towards the Caspian, Maku, Khof, and Urumiā in the west, Marāgha in the centre, and Solduz, Saunbulāk, and Sein Kalah in the south. Adarbaijan is about 250 miles in length from the Little Ararat to Sardasht, and the same distance in breadth from Kotur to the Talish. It is separated from Armenia in the north by the Aras, which rises in the mountains to the westward, and from Irāk in the south by the Kizil Uzun, which, after a long winding course from Kurdistan, and union with other streams, empties itself into the Caspian under the name of Safid Rūd. On the west it is enclosed by the Kurdish mountains, and to a great extent on the east by those overlooking the Caspian shores. It is a land of mountains, ravines, plains, and plateaus. Lake Urumiā, about 75 miles in length by an average breadth of 80, is one of its most remarkable geographical features. In parts it is fertile, and produces wheat, barley, and maize, also cotton and tobacco. Markham says that its villages "are embosomed in orchards and gardens, which yield delicious fruits," and that its most picturesque and flourishing portion is around the towns of Urumiā (west of the lake) and Khof. Tabriz, the capital, has long been the most populous city of Persia. The other chief towns of the province are Ardabil, Urumiā, Khof, and Marāgha.

The North Central Districts is a name given to the country under the immediate supervision of the naib, s-sultānah, or "deputy of the kingdom," the shāh's third son, who appoints governors to Tehran and Firzūkh in the north, to Zarand, Sawah, Kūm, Kashān, and Natanz, south of Tehran, and to Mahālat, Sultanabad in 'Isfāh, Malaiyir, Nahāvand, Hamadan, and Tusirkān, west of Kūm and Kashān. The places named will serve to indicate the range of this division, one of some 150 miles in length, but of very irregular breadth. There are included in it remarkable centres of population, besides Tehran. Kūm is held in high repute as a sacred city, second in importance to Mashhad only. It contains the tomb of Fātima, the sister, or, as some affirm, the daughter of the imām Rīfā, and the bones of thousands of Muhanmadana, bequeathed to its honoured soil by the affection or superstition of sorrowing friends and relatives. It is a large, straggling, ill-kept, semi-ruined, uninviting place, relieved by patches of a new and well-built bazaar. The many domes of Kūm recall it readily to memory, but they are more characteristic than striking. Kashān has not much more attraction as a residence, but is held in good estimation for its silks, and is deservedly famous, above all towns in Persia, for its tiles and potteries.

The large province of Khurasān is perhaps not less than 500 miles in length from the Perso-Türkman frontier to the southern limit of Persian Sīstān. In breadth it is irregular, but from Pul-Khātūr or the Lady's Bridge on the Tajand to Pul-i-Abrahim or the Bridge of Silk on the Kal Mura—a fair limitation for Khurasān proper, exclusive of Sīstān—it is about 260 miles. The mountainous character of its northern frontier has been noticed in the description of the general boundaries of Persia. It is, however, worthy of remark that the supposed connexion of the Alburz range and that of the Parapanisus does not prevent an easy passage into Herat by the valley of the Hari Rūd. The mention of rivers east and west of Khurasān must not lead to the inference that the water-supply is abundant; one, the Tajand, has to fertilize the desert tracts of the Persian Atak; at the other, the Kal Mura, the bridge is often useless, owing to the dryness of the river-bed. Central and southern Khurasān are more or less a vast desert with kavra. Parts of Kāiyan and Sīstān on the Afghan border are fertile, though barren mountains and desert plains abound in the former, and the second has no lack of waste, notwithstanding the proximity of the Helmand.

The principal city in Khurasān proper is Mashhad, the capital, which may be said to contain, without contradiction, the most venerated and popular shrine in the whole of Persia, that of the eighth imām, Rīfā. A pilgrimage to this spot has, owing to its convenient site, become a duty more essential if not more important than one to Karbala in Turkish Arabia, or even to Mecca and Medina; and the thousands who year by year win the privilege of becoming "Mashhadis" testify to the value set upon it. Mashhad, built on the perpetual Persian plain, and admirably situated as to roads of traffic with Būkhāra (Bokhara), Khiva, Herat, and Kandahar, has little in its general exterior, except the imām's golden dome, to dis-

tingulah it from other cities in the sháh's territory; but it can boast also the tomb of the famous Hárún al-Bashíd and of Gauhar Sháh Agha, the favourite wife of Sháh Rukh; and its canal and quays merit at least a passing remark from their rarity. It is divided into two towns, the sacred and the secular, each of which has its distinct governor—the first called the "mutawallí," the second being also governor of the whole province of Khurásan, and often a prince of the blood-royal. After Mashhad, among the chief towns of Khurásan are Nishápúr and Sabzawár on the highroad to Tehran, the first an ancient city within walls, the second notable for its surrounding cultivation; Bújnúrd on the north, which in Burnes's time was "a rather large place standing in a spacious valley"; Túrbat-i-Haidari, the chief town of a populous district with ten villages, visited by Conolly in 1830, by Goldsmid in 1872, and by Stewart in 1880; Sultanabad, capital of the Turshiz district (in which there is no specific "Turshiz"), called by Colonel Stewart "a small and flourishing town of some 5000 inhabitants"; Káiyán, once capital of the district of that name, and still a town of some importance, much frequented by "mullas" and "ásiyids"; Tún, which Macgregor describes as "decidedly a picturesquely situated town, surrounded by a wall (of irregular outline), which goes outside all the houses, and encloses besides a space—quite equal to that occupied by the houses—taken up with cultivation and gardens. Thus it is," he adds, "that Tún may be said to be a town 4 miles in circumference, though, if only the space occupied by houses was calculated, it would dwindle to one-eighth of this. There are no buildings of any note in the place, but a few mosques and colleges are to be found, while most of the better houses, of which there is a total of about 1500, have *badgirs*." <sup>1</sup> Coupled with Tún is Tabas, to which the same writer gives no importance; then come Birjand, picturesque and clean, with a better class of mud buildings, well situated at the foot of hills, and having rather high mountains to the westward, the modern capital of the Káiyán district; and finally, Sikúha, the true but somewhat insignificant chief town of Sistan, here chosen in preference to Nasrabad, its military headquarters. Mr Rozario, medical attaché to the mission of 1872, described Sikúha as "composed of 200 arch-roofed mud-built houses, connected with each other without any kind of woodwork about them," the land wanting in rice and timber, but producing wheat, barley, beans, and cotton in abundance.

The fourth, Southern Persia, is a very extensive division, embracing not only the whole seaboard between 48° and 61° 30' E. long. but a great part of the country as far north as 32° 40', the parallel of Ispahan. Nothing could better illustrate the arbitrary and uncertain mode of parcelling out a kingdom than the separation of natural and the combination of abnormal elements of union to be found in this vast territory entrusted to the charge of the "zil-i-sultán," or "shad of the monarch," the title given to the sháh's eldest son. That such an arrangement can work at all in one of many strange truths which are intelligible only to persons acquainted with the centralizing power exercised in Tehran. General Schindler, an officer of great local knowledge and experience, has guaranteed the correctness of the statement that the prince-governor or governor-general of Southern Persia—residing himself at Shiráz (or at Ispahan)—appoints governors to the following places:—Kurdistan, Karmansháh, Lúristán, Búrjird, Dízfúl, Shústár, Muhamrah, Behbahan, and Bam Hormuz in the west; the tracts occupied by the Bakhtiáris, Gulpáigan, Khonsar, Faridun, Chahr Mahál, Yazd (with Nain, Baff, and Shahr-i-Babek); Fárs (with Fasa, Darab, Lar, Parum, and Kázaran) in the centre; Bushahr and Língah on the coast; and Karman (with Bam, Bampur, Rafsinjan, Khabá, Sirjan, Jiruft, and Rudbar) to the east. Among the more prominent cities or towns within this range are:—Ispahan, a fine city, still worthy from its site, buildings, gardens, river, and surroundings to be the royal residence; Shiráz, happily situated with pleasant neighbouring resorts and the ordinary requirements of a first-class Persian town,—possessing, moreover, a special national prestige for high and low, yet not a genial residence for strangers, who can accomplish its lions in a couple of days; Yazd, a large and fairly populated city, with one remarkable mosque and a handsome new bazaar, but somewhat gloomy in character and drearily situated on a flat plain in an amphitheatre of hills; Karman, a place of pleasant recollection to those English travellers who experienced the genuine kindness and hospitality of the wakila 'l-mulk, Muhammad Ismail Khán, its governor in 1865-66, and not wanting in material attractions of its own; lastly, Bam and Bampur, visited by Lieutenant Pottinger in 1810, more than half a century afterwards by Colonel Goldsmid, and later still by Majors St John and Lovett,—the one a frontier town with associations of border warfare, the other a mere Perso-Baluch cantonment with a fort and mud buildings, long the residence of Ibrahim Khán, a chief of notoriety serving the interests of Persia. Muhamrah, Bushahr, Língah, and Bandar-'Abbás are ports, but there is no real harbour between Fáo at the mouth of the Shattu 'l-'Arab and Karáchi (Kurrachee) in British India.

Astrábad is a town and district near the entrance of the bay of the same name on the Caspian. In 1884 it was governed by Habib Ullah Khán, the "as'ídu 'l-daulah," or "arm of the state." Mazandaran and Gilan are the Caspian provinces, *par excellence*, of Persia. General Schindler makes them distinct governments, but they appear to have once formed part of the northern division under the prince-governor.

Khamesh, a district on the high road between Tabriz and Tehran, of which the chief town, Zanjan, is a place of some importance. The governor's name in 1884 was Násr Kúli Khán, the "amidú 'l-mulk," or "prop of the kingdom."

Karvin, a considerable town, with surrounding district, in the plains south of the Alburz, and not a hundred miles from Tehran, was governed in 1884 by Mirza Ríza, the "mu'ayinu 'l-sultánah," or "helper of the kingdom."

Gerrus is a district on the south of Khamesh.

*Population.*—Although the present section deals with statistics only, the following well-considered remarks of Mr Robert Grant Watson, formerly a secretary in the Persian legation, form an appropriate preface to the record of population.

"Persia is peopled by men of various races. A very great proportion of the population is composed of wandering tribes, that is, of a large number of families who pass a portion of the year on the hills. It is in this sense only that they can be considered wanderers. They invariably occupy the same pasture-grounds one year after another. Their chiefs are possessed of great authority over the tribesmen, and all dealings between the Government and the tribes are carried on through the heads of these divisions. Through the chief the taxes, whether in money or in kind, are paid, and through him the regiments which his tribe may furnish are recruited. The office of chief is hereditary. The tents in which the tribesmen dwell are for the most part composed of a light framework of the shape of a beehive. This is covered with a coating of reeds, and above it is placed a thick black felt. It has but one door, and no window or chimney. This is the Turkman tent, which is used by the Shahsavand and other tribes, but the Iliyáts in central Persia make use of tents of another construction, with flat or slightly-sloping roofs.

"The provinces near the Persian Gulf contain many Arabs and men of Arab extraction. Such are for the most part the inhabitants of Laristan and of the country lying to the left of the Shattu 'l-'Arab and of the lower part of the Tigris. The Bakhtiári mountains, between the valley of the lower Tigris and the plain of Ispahan, are the dwelling-place of tribes of another race, and of whom their country very little is known. The mountains of Kurdistan give birth to a warlike people, who are attached to their own tribes, and who never go far from the borders of Turkey and of Persia, sometimes proclaiming themselves subjects to the Porte, and sometimes owing allegiance to the Shah. At the foot of one part of these mountains, on the borders of the lake of Urúmia, there is a plain on which dwell many Christian families who hold the tenets of Nestorianism. At Ispahan, at Tehran, at Tabriz, and in other parts of Persia, there is a more or less considerable population of Armenians. At Hamadan, at Ispahan, at Tehran, at Mashhad, at the town of Damávand, and elsewhere in Persia, Jews are found in considerable numbers. The province of Gilan is inhabited by a race of men peculiar to itself, the descendants of the ancient Gelsa. The people of Mazandaran speak, as do the Gileks, a dialect of their own. The province of Astrabad is partly inhabited by Turkmans; and in the districts claimed by Persia, which border on Afghanistan and Beluchistan, the Afghan and Baluch elements are prominent in the population. At Karman a few Hindus reside, and at Yazd there are about 2000 families of the original fire-worshippers of Iran. <sup>2</sup> But the two principal races to be met with in Persia are the Turks and the Persians or Mongols. The former are, as a general rule, spread over the northern provinces; the latter over the southern. The Persians of Mongol extraction for the most part speak only the Persian language, while those of Turkish race speak the Turkish language in preference to Persian.

"The inhabitants of Persia may be divided into two classes,—those who inhabit the towns and villages, and those who dwell exclusively in tents. The former class remain stationary during the greater part of the year, the richer orders only leaving the towns for two months during the summer heats, when it is possible to obtain cool air in the hills or upper grounds close by. The tribes who dwell in tents move from place to place with the varying seasons of the year. In the springtime they drive their flocks and herds to their accustomed pasture-grounds, and if they have a right to the pasture of mountains which are inaccessible in spring, they move up to their summer quarters as soon as the snow disappears. Winter finds them on the plains, prepared, in their black tents, to brave its utmost rigour. These Iliyát tribes serve each a separate chief. For the Iliyáts of Fárs there is a hereditary chief called the Ilkhán, to whom they all owe allegiance; from whom they receive the laws that rule their conduct; and to whom they pay the revenue imposed upon them. They contribute a certain number

<sup>1</sup> Literally "wind-catchers,"—towers erected on the roofs of houses for purpose of ventilation.

<sup>2</sup> Since greatly reduced in numbers.

of soldiers to the Shah's army. Very little is known as to the numbers and the peculiarities of these nomads. The Iliyát tribes of Turkish descent have an Ikhán appointed by the Shah. Besides these tribes there are wanderers who are less numerous, and who occupy a less prominent position,—the gipsies common to so many countries."

It is difficult to form an estimate of the population of Persian towns or districts. In the first place, opinion is divided upon the approximate figure to be accepted for the kingdom at large. According to St John, the discrepancy is between ten and four millions; and if the smaller one were made a basis there would be but a scanty number indeed for partition among the cities and principal centres. The famine of 1870 was, moreover, severe and fatal enough to cause a considerable diminution in the totals calculated prior to its occurrence. When returning through Mashhad in the spring of 1872 the British commissioner for the Sistan boundary settlement was informed that no less than 100,000 persons had been carried off within the limits of the prince-governor's rule, of whom 24,000 were from the city itself, where, exclusive of passing pilgrims, reckoned by thousands, a population of 70,000 might well be supposed. In Yazd and Ispahan the losses were also very great, and must have sensibly affected the figures.

The official estimate for 1881 is recorded as follows:—inhabitants of cities, 1,963,800; wandering tribes, 1,909,800; inhabitants of villages and country, 3,780,000; total, 7,653,600. It is probable that 8,000,000 would be a fair estimate in round numbers; and this should include the comparatively new accessions of territory in Sistan and western Baluchistan.

The population of certain cities may be recorded as follows. Those figures marked with an asterisk are from the official returns given in the *Statesman's Year Book* for 1884. Tehran, \*100,000; Astrábad (city), 8000—in the province, 26,000 (Lovett, 1881); Tabriz, \*120,000; Urumiá, \*40,000; Hamadan, \*30,000; Karmánahá, 25,000; Rasht, 20,000; Kárvín, 25,000; Zanjan or Zanjánah, 20,000 (Eastwick, 1860); Kúm, 20,000 (Euan Smith said in 1871 that out of 20,000 houses which it originally possessed only 4000 were then habitable); Ispahan, 60,000; Shiráz, \*30,000; Bushahr, 11,000; Yazd, \*40,000; Kármán, 40,000; Birjand, 12,000 (Sistan mission, 1872); Ardakan (Khurásan desert), 20,000 (Colonel Stewart, 1880); Bam, 6000 (Goldsmid, 1866-72).

With regard to three interesting places in eastern Persia visited by Macgregor in 1875, this active explorer gives no clue to the population of Tabas, beyond the fact that it is a wall-enclosed town about half a mile in length by a quarter in breadth, with an "ark" or citadel, but no bazars; of Tún, his 1500 "better houses" may imply about 6000 well-to-do people only; and Bashruyah, between Tabas and Tún, he calls a village of some 600 houses, equivalent to a population of between 3000 and 4000.

**Government.**—The sháh is regarded as vicegerent of the Prophet, and, as such, claims implicit obedience so long as his commands do not go against the Koran and the sacred law. The executive government is carried on by a ministry of which the *personnel* is subject to constant change, and the distribution of duties depends much upon the standing in royal favour of individual ministers. It may be said, as a rule, that those who fill the more important functions and do the most real work are better known by their family names than the official titles accorded them. The somewhat common prefix "mirza" is usually taken by high functionaries of state,—a word which invariably denotes a member of the royal house when used as an affix.<sup>1</sup>

The division of the country for administrative purposes has been mentioned above, p. 626. Provinces are further subdivided into districts under "hákims," or chiefs, who collect the revenue as well as exercise a general superintendence. In villages the "kathúdd," or magistrate, administers justice.

Of the Armenians under Persian rule there are said to be 43,000, chiefly in Julfa near Ispahan, and of Nestorians and Chaldeans 23,000, chiefly in Urumiá and Salmas. There are probably 70,000 Christians of every denomination. The number of Jews given is 19,000, and of Gabars (Guebres) or Parsis 8000. Perhaps the Nestorians have been under-estimated; but the Parsis have greatly diminished in recent years. However tolerant the declared principles of the Government towards aliens in religion, there is no doubt that much could yet be done to improve the condition of the sháh's non-Moslem subjects in respect of taxation, civil and social rights, and general treatment by local authorities. Efforts on behalf of the Nestorians have from time to time been made in late years, with the support of the British Government, and special agents have been deputed to Urumiá to report upon supposed grievances

with a view to their alleviation or removal. The temporary appointment of a Christian governor was an indication of the sháh's good wishes, but can hardly be said to have attained the desired end. It is just possible that the desire awakened in England in the second half of the 19th century to know more of the Eastern churches may result in the exercise of a beneficial influence over the fortunes of a people who have suffered various forms of oppression for five centuries or more. See NESTORIAN, vol. xvii. p. 357 sq., where statistics, &c., are given.

**Army.**—Military service is not popular, and could not be provided for at all but by compulsory enrolment. Pay is always kept in arrears, generally for two or three years; and, when issued, it is reduced from its legitimate amount by the exactions of distributing officers, from the "carhang," or lieutenant-colonel, downwards. The native officers are, as a rule, incapable and ignorant of military affairs; and the European drill-instructors, whatever their local rank, have no actual command in the native army. The common "sarbaz," or Persian infantry soldier, might with good officers and good training be made very efficient. In the performance of his long marches—24 or even 40 miles a day—he has very often a companion, his donkey, without which adjunct no picture of a Persian infantry soldier would be complete. Setting such an aside, the marching and endurance of the sarbaz are wonderful, and, though better food might in some respects improve his *physique*, his frugality is such as to account in some measure for his bodily strength. If wanting in the discipline that is considered in England essential to the well-being of the service, the fault is that of his superiors, by whom he is ill-commanded, ill-taught, and ever accursed with an evil example. In fact, the moral value of the soldier deteriorates as the social grade rises. It is much the same in Turkey, where the state of things is perhaps Oriental rather than national. The post of "wakíl," or non-commissioned officer, becomes thus the first step to demoralization. Above this rank is the "naib," or lieutenant, corresponding to the Turkish "mulázm"; then comes the "sultán," or captain, the Turkish "yuzbashi"; "yávar," or major, the Turkish "binbashi"; "sirhang," or lieutenant-colonel, the Turkish "káim-makám"; and the "artip," or colonel, the Turkish "mir-alai"; such are roughly the respective grades which represent the commissioned ranks.

The most business-like cavalry the present writer can recall in the sháh's dominions were the stray horsemen met with in the Kármán province. Their dress, brown from top to toe, with the *sapkas* of Herodotus and the carbine slung over the back, appeared simple and soldier-like; and nothing but hereditary aptitude could make the horseman so fitted to the horse. Both in 1866 and in 1871 the governor of Bampur, in Baluchistan, had good stuff to discipline into irregular cavalry in his mounted Baluchis as well as Persians; and the same remark applies to the Persian governor of Sistan in 1872. The "sítikbal," or motley troop of cavaliers, sent out to meet the writer by either chief, presented a singular specimen of rough but sufficiently formidable-looking satellites—men who had, clearly, fighting propensities, and might be moulded, without much effort, into very serviceable soldiers. Colonel (now Sir Charles) Macgregor found the few irregular cavalry incidentally brought under his observation in Khurásan very fairly mounted in a working sense. Over the saddle and behind it they seemed to carry all that belonged to them. With less than £2 a year in pay, over and above a grain allowance, he says truly of these cavaliers, that, "if not the best light horsemen in the world, they are the very cheapest." At Mashhad he saw several Persian regiments encamped outside the city. They were composed of men generally of fine physique, hardy and muscular; but their small pay of seven "tumáns" (not £2, 16s.) per annum was seldom realized up to half the amount, and they had to subsist chiefly on their rations. Their uniform consisted of a black lamb's-wool busby, with a lion and sun in brass on the front, a dark-blue tunic, on the European model, with white bands across the breast, blue trousers with red stripe, and shoes (if they like to wear them). They had "clumsy percussion, smooth-bore muskets and bayonets, with locks of French manufacture"; but they did not clean them, and it was probable that more than half were unfit for actual use. The artillery he states to be probably the most efficient branch of the service, not smart, but rough and ready.

Although there were no English officers employed in training the Persian troops during any of the present writer's visits to Tehran, there were two Englishmen connected with the arsenal to whom the local Government was indebted for useful service. The chief control of the arsenal, however, and indeed the direction of the whole Persian artillery, was in the hands of an Armenian; the two principal drill-instructors were Italians, a Florentine and a Neapolitan; while that vital part of the public works department comprising roads and bridges was under an Austrian officer holding the rank of general. There were, besides, two or three other Europeans holding quasi-military posts.

Sir Henry Rawlinson, who was for five years in the sháh's army, believes that, "if the Persian material were placed at the disposal of a European power who would encourage and take care of the

<sup>1</sup> In 1884 the following were among the more prominent ministers:—*War*.—Nábu 's-Saltánah, Kamran Mirza. *Interior and Finance*.—Mustafá 'l-Mamálík, Mirza Yásef Khán. *Foreign Affairs*.—Nágra 'l-Mulk, Mirza Mahmúd Khán. *Justice*.—Mushtra 'd-Daulah, Mirza Abdul Waháb. *Worship and Telegraphs*.—Makhharu 'd-Daulah, 'Alí Káfi Khán. Of these, Mirza Mahmúd Khán, the "nágra 'l-mulk," had been minister in London. His predecessor in the cabinet had been always known as simply Mirza Bek Khán.

men, and develop their military instincts, a fine working army, very superior to anything that Turkey could produce, might be obtained in a very short period of time."

It is difficult to rely on statistics in the present case, but the following are found in the latest and most trustworthy records.<sup>1</sup>

"The Persian army, according to official returns of the minister of war, numbers 105,500 men, of whom 5000 form the artillery, 53,900 the infantry, 31,000 the cavalry, regular and irregular, and 7300 militia. Of these troops, however, only one-third are employed in active service, the standing army of Persia consisting, on the peace footing, of a total of 30,000 men. By a decree of the Sháh, issued in July 1875, it was ordered that the army should for the future be raised by conscription, instead of by irregular levies, and that a term of service of twelve years should be substituted for the old system, under which the mass of the soldiers were retained for life; but the decree has not been enforced to any extent. The organization of the army is by provinces, tribes, and districts. A province furnishes several regiments; a tribe gives one, and sometimes two, and a district contributes one battalion to the army. The commanding officers are almost invariably selected from the chiefs of the tribe or district from which the regiment is raised. The Christians, Jews, and Guebres in Persia are exempt from all military service. In recent years the army has been under the training and organization of European officers."

*Revenue.*—According to the *Statesman's Year Book* for 1884 the revenue and expenditure of the Government are known only from estimates. If we accept these as based on consular reports, the total receipts of the Government amounted, on the average of the years 1872 to 1875, to £1,900,000 per annum, while the expenditure during the same period was at the rate of £1,756,000 per annum. The receipts of the year 1882 amounted to £1,600,000 in money, besides £280,000 in kind, consisting of barley, wheat, rice, and silk, making the total revenue equal to £1,880,000; and of this sum £1,520,000 came from direct taxes and £353,600 from customs. The expenditure amounted to £1,800,000, of which £760,000 was for the army; £360,000 for the regular court; the priesthood, &c., £240,000; foreign affairs, £28,000; other departments, £60,000; education, £12,000. The surplus is paid into the sháh's treasury. About one-fourth of the receipts are constituted by payments in kind, mostly reserved for the use of the army and the sháh's own household. The whole revenue is raised by assessments upon towns, villages, and districts, each of which has to contribute a fixed sum, the amount of which is changed from time to time by tax-assessors appointed by the Government. Almost the entire burthen of taxation falls upon the labouring classes, and among these upon the Muhammadan subjects of the sháh. The amount of revenue collected from the Christian population, the Jews, and the Guebres is reported to be very small. The Government has no public debt. The *Almanach de Götting* adds to the above items of expenditure in 1882 the sum of £90,000 for the priesthood, &c.

In 1868 the revenue demanded from each province, under the divisions then made, was:—Aderbaijan, £248,000; Gilan, £176,000; Ispahan, £163,000; Fars, £152,000; Khurásan, &c., £88,000; Arabistan, £86,000; Tehran, &c., £84,000; Karman, £84,000; Karmansháh, &c., £80,000; Khamseh, £72,000; Yazd, £68,000; Mazandaran, £44,000; Karvin, £28,000; Kahan, £28,000; Búrdjir, £24,000; Gulpáigan, £24,000; Kurdistan, £20,000; Hamadan, £12,000; Astrábad, £10,000; Kúm, £6000; total, £1,502,000. The customs were £214,664, and the value of income received in kind was £220,336,—making a total revenue of £1,937,000, or something less than two millions.

A prince-royal appointed to a province is often little more than a nominal ruler. On the other hand, some governors, such as Muhammad Isma'íl Khán, the late wakíl 'U-mulk of Karman, attend to even the minute details of administration, and pay especial attention to the collection of revenue. It is not always an easy matter to pay into the royal treasury the sum insisted on, or even voluntarily offered for the government of a province.

*National Character.*—Malcolm's *Sketches* and Morier's *Hajji Baba* are still, after more than half a century, unsurpassed as standard records of accurate information on the manners and customs of an Oriental people. A clever volume<sup>2</sup> published in 1833, which is also worth quoting, contains, among many other faithful delineations, the following.

"The character of the Persian is that of an easy-going man with a wish to make things pleasant generally. He is hospitable, obliging, and specially well disposed to the foreigner. His home virtues are many: he is very kind and indulgent to his children, and, as a son, his respect for both parents is excessive, developed in a greater degree to his father, in whose presence he will rarely sit, and whom he is in the habit of addressing and speaking of as 'master.' The full stream of his love and reverence is reserved for his mother; he never leaves her to starve, and her wishes are laws to him. The mother is always the most important member of the household, and the grandmother is treated with veneration. The

presence of the mother-in-law is coveted by their sons-in-law, who look on them as the guardians of the virtue of their wives. The paternal uncle is a much nearer tie than with us; while men look on their first cousins on the father's side as their most natural wives.

"Black slaves and men-nurses or 'lallaks' are much respected; the 'dyah' or wet nurse is looked on as a second mother and usually provided for life. Persians are very kind to their servants; a master will often be addressed by his servant as his father, and the servant will protect his master's property as he would his own. A servant is invariably spoken to as 'bacha' (child). The servants expect that their master will never allow them to be wronged. The slaves in Persia have a good time; well fed, well clothed, treated as spoiled children, given the lightest work, and often given in marriage to a favourite son or taken as 'segah' or concubine by the master himself, slaves have the certainty of a well-cared-for old age. They are looked on as confidential servants, are entrusted with large sums of money, and the conduct of the most important affairs; and seldom abuse their trust. The greatest punishment to an untrustworthy slave is to give him his liberty and let him earn his living. They vary in colour and value: the 'Habahi' or Abyssinian is the most valued; the Súhálí or Somálí, next in blackness, is next in price; the Bombasi, or coal-black negro of the interior, being of much less price, and usually only used as a cook. The prices of slaves in Shirás are, a good Habahi girl of twelve to fourteen £40, a good Somálí same age, half as much; while a Bombasi is to be got for £14, being chosen merely for physical strength. They are never sold, save on importation, thought at times they are given away. . . . I have never seen a Persian unkind to his own horse or his slave, and when overtaken by poverty he will first sell his shirt, then his slave.

"In commercial morality, a Persian merchant will compare not unfavourably with the European generally. . . . To the poor, Persians are unostentatiously generous; most of the rich have regular pensioners, old servants, or poor relations who live on their bounty; and though there are no workhouses, there are in ordinary times no deaths from starvation; and charity, though not organized, is general. . . . Procrastination is the attribute of all Persians, 'to-morrow' being ever the answer to any proposition, and the 'to-morrow' means indefinite delay. A great dislike is shown generally to a written contract binding the parties to a fixed date; and, as a rule, on breaking it the Persian always appeals for aid and expects delay and indefinite days of grace. . . .

"Persians are clean in their persons, washing themselves and their garments frequently. The Persian always makes the best of his appearance; he is very neat in his dress, and is particular as to the sit of his hat and the cut of his coat. All Persians are fond of animals, and do not treat them badly when their own property.

"Cruelty is not a Persian vice; torture and punishments of an unusual and painful nature being part of their judicial system. There are no vindictive punishments, such as a solitary confinement, penal servitude for long terms of years, &c. Seldom, indeed, is a man imprisoned more than twelve months, the rule being that there is a general jail delivery at the New Year. Royal clemency is frequently shown, often, perhaps, with want of judgment."

The close adherence to ceremony and etiquette, the ready adaptation to foreign habits, together with the capacity for using and love of receiving the grossest forms of flattery—which in the days of Herodotus were found to be notable features of the national character—are still to be seen in the 19th century.

Morier, in his *Second Journey through Persia*, relates how on arrival at Bombay his fellow-traveller, the Persian ambassador, returning from a mission to the court of St James's, would not call at Government House until the governor had visited him, on the plea that, when in London, the chairman and deputy-chairman, whom he styled the father and grandfather, of the East India Company, as well as the "viziers" and "grand vizier" himself (Mr Spencer Perceval), had made the first call upon him,—clothed, moreover, in the very dress they had worn before their own sovereign! The present writer, when discussing the necessary conduct of British diplomatists accredited to Persia, said:<sup>3</sup> "In some courts . . . there is a meaning in ridiculous minutiae, the comprehension of which is of vital importance to the envoy and the cause he advocates. . . . A chair pushed one inch or two forward or backward, so as to transgress the border of a particular carpet marked for its limit, may cause serious offence; a cup of tea, or a tobacco pipe missing from the conventional number offered to a guest, may awake hostile feelings, there may be hidden mischief in a misapplied word of welcome or farewell, in a clumsy gesture, in a new-fashioned article of wearing apparel. Trifles count hardly go further in the way of puerility; but it is a part of common-sense diplomacy to acknowledge with gravity things which are to all seeming the most opposed to common-sense."

Forms of compliment and adulation are in such constant requisition with him that a Persian is never at fault to find occasion for their use. If the following example be too characteristic to be

<sup>1</sup> *Statesman's Year Book*, 1884, pp. 796, 797.

<sup>2</sup> *Wills, In the Land of the Lion and Sun*, 1833.

<sup>3</sup> Lecture at the Royal United Service Institution, 26th May 1876.

admitted, be it understood that it indicates a grosser kind of procedure than that which, at the present day, is known to the higher classes. It is a common custom on the arrival at the gate of a town of a distinguished traveller for some duly appointed official to strike off the head of a sheep, and roll it, with the blood dripping, across the path of the new-comer. Morier gives a revolting illustration of the length to which this ceremony was carried on the arrival of the shah at the halting-place of Morchikar. The head man of the village went so far as to strip his own son naked from the waist upwards, and, having tied the lad's hands behind his back, to lift his knife as though to cut the victim's throat. The conclusion of the story is not told; but it is to be hoped that the shah exercised his prerogative of preventing any evil results.

*Costume.*—The costume of the Persians may be shortly described as fitted to their active habits. The men invariably wear an unstarched shirt of cotton, sewn with white silk, often, particularly in the south of Persia, elaborately embroidered about the neck. It fastens in front by a flap, having two small buttons or knots at the left shoulder, and seldom comes below the hips. It has no collar, and the sleeves are loose. The lower orders often have it dyed blue; but the servant and upper classes always prefer a white shirt. Silk shirts are now seldom seen on men. Among the very religious during the mourning month ("Muharram") the shirt is at times dyed black. The "zir-jamah," or trousers, are of cloth among the higher classes, particularly those of the military order, who affect a garment of a tightness approaching that worn by Europeans. The ordinary "zir-jamah" are of white, blue, or red cotton, very loose, and are exactly similar to the "pai-jamahas" worn by Europeans in India. They are held up by a thin cord of red or green silk or cotton round the waist, and the labouring classes, when engaged in heavy or dirty work, or when running, generally tuck the end of these garments under the cord, which leaves their legs bare and free to the middle of the thigh. The amplitude of this part of his attire enables the Persian to sit without discomfort on his heels; chairs are only used by the rich, great, or Europeanized. Over the shirt and "zir-jamah" comes the "arkhalik," generally of quilted chintz or print, a closely-fitting garment, collarless, with tight sleeves to the elbow, whence, to the wrist, are a number of little metal buttons, fastened in winter, but not in summer. Above this is the "kamarchin," a tunic of coloured calico, cloth, Kashmir or Karman shawl, silk, satin, or velvet (gold embroidered, or otherwise), according to the time of year and the purse and position of the wearer. This, like the "arkhalik," is open in front, and shows the shirt. It sometimes has a small standing collar, and is double-breasted. It has a pocket-hole on either side, giving access to the pockets which are always in the "arkhalik," where also is the breast-pocket in which watch, money, jewels, and seals are kept. The length of the "kamarchin" denotes the class of the wearer. The military and official classes and the various servants wear it short, to the knee, while fops and sharpers wear it even shorter. Priests, merchants, villagers, especially about Shiraz, townsmen, shopkeepers, doctors, and lawyers wear it very long, often nearly to the heels. Over the "kamarchin" is worn the "kuljah," or coat. This is, as a rule, cast off in summer, save on formal occasions, and is often borne by a servant, or carried over the shoulder by the owner. It is of cloth, shawl, or camel-hair cloth and is lined with silk or cloth, flannel or fur. It has, like the Turkish frockcoat, a very loose sleeve, with many plaits behind. It has lapels, as with us, and is trimmed with gold lace, shawl, or fur, or is worn quite plain. It has a roll collar and false pockets.

Besides these garments there are others: the long "jubba," or cloth cloak, worn by "mirzas" (secretaries), Government employes of high rank, as ministers, farmers of taxes, courtiers, physicians, priests; the "abba," or camel-hair cloak of the Arab, worn by travellers, priests, and horsemen; the "pustin," or Afghan skin-cloak, used by travellers and the sick or aged; the "nimtan," or common sheepskin jacket, with short sleeves, used by shopkeepers and the lower class of servants, grooms, &c., in winter; the "yapanjah," or woollen Kurdish cloak, a kind of felt, having a shaggy side, of immense thickness, worn generally by shepherds, who use it as greatcoat, bed, and bedding. There is also the felt coat of the villager, very warm and inexpensive, the cost being from 5 to 15 krans (a kran = 10d.). The "kamarband," or girdle, is also characteristic of class. It is made of muslin, shawl, or cotton cloth among the priests, merchants, bazaar people, the secretary class, and the more aged Government employes. In it are carried, by literati and merchants, the pen-case and a roll of paper; its voluminous folds are used as pockets; by the bazaar people and villagers, porters and merchants' servants, a small sheath knife is stuck in it; while by "farrashes," the carpet-spreader class, a large "khanjar," or curved dagger, with a heavy ivory handle, is carried. The headgear is very distinctive. The turban worn by priests is generally white, consisting of many yards of muslin. When the wearers are "sadyid" of the Prophet, a green turban is worn, also a "kamarband" of green muslin, or shawl or cotton cloth. Merchants generally wear a turban of muslin embroidered in colour, or of a yellow pattern on straw-

coloured muslin, or of calico, or shawl. The distinctive mark of the courtier, military, and upper servant class is the belt, generally of black varnished leather with a brass clasp; princes and courtiers often replace this clasp by a huge round ornament of cut stones. The "kulah," or hat, is of cloth or sheepskin on a frame of pasteboard. The fashions in hats change yearly. The Isfahan merchant and the Armenian at times wear the hat very tall. (The waist of the Persian is generally small, and he is very proud of his fine figure and broad shoulders.)

The hair is generally shaved at the crown, or the entire head is shaved, a "kukul," or long thin lock, being sometimes left, often 2 feet long, from the middle of the crown. This is to enable the prophet Muhammad to draw up the believer into paradise. The lower orders generally have the hair over the temporal bone long, and brought in two long locks turning backwards behind the ear, termed "sulf"; the beaux and youths are constantly twisting and combing these. The rest of the head is shaven. Long hair, however, is going out of fashion in Persia, and the more civilized affect the cropped hair worn by Europeans, and even have a parting in it. The chin is never shaved, save by "beauty men," or "kashangs," though often elipped, while the moustache is usually left long. At forty a man generally lets his beard grow its full length, and cherishes it much; part of a Persian's religious exercises is the combing of his beard. Socks, knitted principally at Isfahan, are worn; they are only about 2 inches long in the leg. The rich, however, wear them longer. They are of white cotton in summer and coloured worsted in winter. Villagers only wear socks on state occasions. Shoes are of many patterns. The "iriansi," or Russian shoe, is the most common; next, the "kafsh" or slipper of various kinds. The heel is folded down and remains so. The priests wear a peculiar heavy shoe, with an ivory or wooden lining at the heel. Green shoes of shagreen are common at Isfahan. Blacking is unknown to Persians generally. Boots are only used by horsemen, and are then worn much too large for ease. Those worn by courtiers often come up to the thigh. With boots are worn "shalwara," or baggy riding breeches, very loose, and tied by a string at the ankle; a sort of kilt is worn by courtiers. Pocket-handkerchiefs are seldom used, save by the rich or the Tehranis. Most Persians wear a "shab kulah," or night hat, a loose baggy cap of shawl or quilted material, often embroidered by the ladies.

Arms are usually carried only by tribesmen. The natives of the south of Persia and servants carry a "kammah," or dirk. The soldiery, on or off duty, always carry one of these or their side-arms, sometimes both. They hack but never thrust with them. On the road the carrying of weapons is necessary.

The costume of the women has undergone considerable change in the last century. It is now, when carried to the extreme of fashion, highly indecent and must be very uncomfortable. The garment doing duty as a chemise is called a "pirahan"; it is, with the lower orders, of white or blue calico, and comes down to the middle of the thigh, leaving the leg nude. Among the upper classes it is frequently of silk. At Shiraz it is often of fine cotton, and elaborately ornamented with black embroidery. With the rich it is often of gauze, and much embroidered with gold thread, pearls, &c. The head is usually covered with a "char-kadd," or large square of embroidered silk or cotton, folded so as to display the corners, and fastened under the chin by a brooch. It is often of considerable value, being of Kashmir shawl, embroidered gauze, &c. A "jika," a jewelled feather-like ornament, is often worn at the side of the head, while the front hair, cut to a level with the mouth, is brought up in love-locks on either cheek. Beneath the "char-kadd" is generally a small kerchief of dark material, only the edge of which is visible. The ends of the "char-kadd" cover the shoulders, but the gauze "pirahan" is quite transparent. A profusion of jewellery is worn of the most solid description, none hollow; silver is worn only by the very poor, coral only by negroes. Necklaces and bracelets are much affected, and chains with scent-caskets attached, while the arms are covered with clanking glass bangles called "alangu," some twenty even of these being on one arm. Jewelled "barzbands," containing talismans, are often worn on the upper arm, while among the lower orders and south Persian or Arab women nose-rings are not uncommon, and bangles or anklets of beads.

The face on important occasions is usually much painted, save by young ladies in the heyday of beauty. The colour is very freely applied, the cheeks being as much riddled as a clown's, and the neck smeared with white, while the eyelashes are marked round with "kuhl." This is supposed to be beneficial to the eyes, and almost every woman uses it. The eyebrows are widened and painted till they appear to meet, while sham moles or stars are painted on the chin and cheek; even spangles are stuck at times on the chin and forehead. Tattooing is common among the poor and in villages, and is seen among the upper classes. The hair, though generally hidden by the "char-kadd," is at times exposed and plaited into innumerable little tails of great length, while a coquettish little skull-cap of embroidery, or shawl, or coloured silk is worn. False hair is common. The Persian ladies' hair is very luxuriant, and never cut; it is nearly always dyed red with henna, or with indigo



to a blue-black tinge; it is naturally a glossy black. Fair hair is not esteemed. Blue eyes are not uncommon, but brown ones are the rule. A full-moon face is much admired, and a dark complexion termed "namak" (salt) is the highest native idea of beauty. Most Persian women are small, with tiny feet and hands. The figure is always lost after maternity, and no support of any kind is worn.

A very short jacket, of gay colour, quite open in front, having tight sleeves with many metal buttons, is usually worn in summer, and a lined outer coat in cold weather. In winter a pair of very short white cotton socks are used, and tiny slippers with a high heel; in summer in the house ladies go often barefoot. The rest of the costume is composed of the "tumbūn" or "shalwār," short skirts of great width, held by a running string,—the outer one being usually of silk, velvet, or Kashmir shawl, often trimmed with gold lace, or, among the poor, of loud-patterned chints or print. Beneath are innumerable other garments of the same shape, varying in texture from silk and satin to print. The whole is very short, among the women of fashion extending only to the thigh. In winter an over-mantle like the "kulājāh," or coat of the man, with short sleeves, lined and trimmed with furs, is worn. Leg-coverings are now being introduced. In ancient days the Persian ladies always wore them, as may be seen by the pictures in the South Kensington Museum. Then the two embroidered legs, now so fashionable as Persian embroideries ("naḥōh"), occupied a girl from childhood to marriage in making; they are *all serving* in elaborate patterns of great beauty, worked on muslin in silk. The outdoor costume of the Persian women is quite another thing. Enveloped in a huge blue sheet, with a yard of linen as a veil perforated for two inches square with minute holes, the feet thrust into two huge bags of coloured stuff, a wife is perfectly unrecognizable, even by her husband, when out of doors. The dress of all is the same; and, save in quality or costliness, the effect is similar.

As for the children, they are always when infants swaddled; when they can walk they are dressed as little men and women, and with the dress they generally ape the manners. It is a strange custom with the Persian ladies to dress little girls as boys, and little boys as girls, till they reach the age of seven or eight years; this is often done for fun, or on account of some vow,—oftener, to avert the evil eye.

A summary of personal impressions of Persia may serve to convey a tolerably correct idea of the country, without the necessity of serious study or the aid of science and statistics. The reader is asked to suppose a tableland dropping to the Caspian Sea for nearly one-third of its northern frontier, and to the Persian Gulf for its southern limit. The lowlands, naturally, are the coast-tracts. In the north these are covered with forest, and the climate there is damp, feverish, relaxing; in the south they are dry and barren, and the winds are hot and violent, yet a relief to the scorching summer atmosphere. In the central highlands (that is, Persia generally) there are few rivers, and the country is either composed of parallel mountain-ranges and broad intervening plains, or of irregular mountain-masses with fertile valleys, basins, and ravines. One plain on the last is of exceptionally large extent, and is called the Salt Desert of Khurāsān. The theory that this was once a sea is supported by the circumstance that at one of its extreme edges is the village of Yunai, so called because the prophet Jonah (Yūnas) is locally believed to have been cast up there by the whale. For irrigation the plains and valleys depend on the mountains, and at the base of these are "kanāts," or underground canals, with watercourses on the surface. Yet where rain and snow fall during the year there is scarcity of water, and where both are wanting there is always distress and sometimes famine. The valleys and ravines are more fertile than the plains, affording often bright, picturesque, and grateful prospects, while the latter are for the most part barren and sandy wastes, scored or streaked, as it were, rather than ornamented with patches of green oases. Forests are rare and, except in Gilan, not dense; numerous gardens are commonly found in the neighbourhood of large towns, not cared for as in Europe, yet pleasant in their wildness; and there are many beautiful trees usually also near the centres of population. Persian cities are not like cities in Europe. The passing stranger sees no street or house in any of them at all comparable to a respectable street or building, as

England, France, or Germany rate structural respectability. Blank mud-walls and narrow ill-paved thoroughfares are the rule; the windowed or terraced front of a Persian house is for the inner court or inner precincts of the abode, and not for the world without. Some mosques are handsome, some caravansarās solid, some bazaars highly creditable to the designer and builder; but everything is irregular, nothing is permanent, and architectural ruin blends with architectural revival in the midst of dirt, discomfort, and a total disregard of municipal method. Even Constantinople and Cairo cannot bear the ordeal of close inspection. Beautiful and attractive as they may be from without—and the first has a charm beyond description, while the second is always interesting in spite of her barbarous boulevard—they are palpably deficient in completeness within; and yet Tehran, Baghdād, Ispahan, Tabriz, Mashhad, Shirāz are far behind them in civilized construction and order.

*Sources.*—Independently of original sources, information has been obtained from official and parliamentary records, to which access was kindly facilitated under authority; from *Eastern Persia*, 2 vols. (1876); and various books of travel by authors already named. The writer has also to express his thanks to General Schindler, in the service of the shāh, to Mirza Hasan 'Alī Khān, attaché to the Russo-Afghan boundary commission; to Colonel Bateman-Champain, R. E., Mr W. T. Blanford, Mr Andrews (of the Indo-European telegraph), and others, who have more or less favoured him with special information, written or oral.

## SECTION II.—HISTORY.

Oriental history, as told by Oriental historians, is for the majority of readers in Europe a study of little attraction. Its genealogies and oft-repeated names are wearisome; its stories of battle, murder, and rapine are monotonous and cast in one mould; the mind cannot readily impart life to the dry bones of the more prominent *dramatis personæ* by conceiving for them any flesh-and-blood individuality. The court-chronicler of an Eastern potentate writes to order, and in accordance with a precedent which fetters style and expression; and even the painter of state-portraits strives rather to turn out a conventional and model monarch than the likeness of an original human being. In the palace of Kirich, near Tehran, is a picture of Fath 'Alī Shāh and his sons. There may be a certain waxwork beauty in some of the faces, but they give no more signs of innate character or mental idiosyncrasy than do the kings and knaves of a pack of cards.

The Timurides in these respects were exceptionally fortunate. Tīmūr himself, their great progenitor, though not the distinct figure of an English king as delineated by Macaulay, has been handed down to us in some kind of personality in the history called *Zafardāma*,<sup>1</sup> in his *Mafrūzāt* or utterances, and in the *Tusūkāt* or institutes.<sup>2</sup> There are, moreover, portraits of him in existence which are professed likenesses. Bābar, Akbar, and Jahāngir were either their own chroniclers or had comparatively competent men to write for them; and, to illustrate the period in which they lived, we obtain—in addition to records of events—biography, memoirs, and something also of the current sayings, writings, and doings. But the reigns of these three monarchs rather concern the annals of India than of Persia, whereas Tīmūr has so much to do with the latter that a brief retrospect of the career of that conqueror and his immediate descendants as it affected the countries generally south of the Caspian will be an appropriate opening to the present history.

<sup>1</sup> Unfortunately, perhaps, there are two histories bearing this title. In the one, as Sir William Jones explains, "the Tartarian conqueror is represented as a liberal, benevolent, and illustrious prince"; in the other he is "as deformed as impious, of a low birth and detestable principles." The authenticity of the *Mafrūzāt* is disputed.

<sup>2</sup> Both these last terms, however, are indifferently applied to the writings of Tīmūr. *Tusūk* is the passive participle of *tusmak*, "to arrange," hence *tusūkāt*, "arrangement."

*The Timurides and Türkmans (1405-1499).*—Timúr died in 1405, when in the seventieth year of his age and about to enter upon a new war,—an invasion of China. Besides exercising sovereignty over Transoxiana and those vast regions more or less absorbed in Asiatic Russia of the 19th century, inclusive of the Caucasus, Astrakhan, and the lower Volga, and overrunning Mesopotamia, Syria, Asia Minor, Afghanistan, and India, he had at this time left his indelible mark upon the chief cities and provinces of Persia. Khurásan and Mazandaran had submitted to him in 1381, Adarbajian had shortly after followed their example, and Ispahan was seized in 1387. If the chroniclers are to be trusted, the occupation of this place was accompanied by the slaughter of 70,000 inhabitants,—a number in excess of its whole population as officially estimated in 1868. From Ispahan he passed on to Shíráz, and thence returned in triumph to his own capital of Samarkand. Five years later his cruel hand was stretched out to subdue a formidable resistance in Mazandaran, and later still he was again at Shíráz, having effected the subjugation of Lúristan and other provinces in the west. It may be said that from north to south, or from Astrábád to Hormuz, the whole country had been brought within his dominion.

The third son of Timúr, Míran Sháh, had ruled over part of Persia in his father's lifetime; but he was said to be insane, and his incapacity for government had caused the loss of Baghdád and revolt in other provinces. His claim to succession had been put aside by Timúr in favour of Pir Muhammad, the son of a deceased son, but Khalil Sháh, a son of the discarded prince, entered the lists against the nominee and won the day. The reign of this chief, however, was not of any duration. His lavish waste of time and treasure upon a fascinating mistress named Shádu 'l-Mulk, the "delight of the kingdom," soon brought about his ruin and deposition, and in 1408 he gave way to Sháh Rukh, who, with the exception of Míran Sháh, was the only surviving son of Timúr. In fact the uncle and nephew changed places,—the one quitting his government of Khurásan to take possession of the Central-Asian throne, the other consenting to become governor of the vacated Persian provinces and abandon the cares of the empire at Samarkand. In the following year Khalil Sháh died; and the story goes that on his death Shádu 'l-Mulk stabbed herself and was buried in the same tomb with her royal lover at Rhé, one of the towns which his grandfather had passed through and partly destroyed.

Sháh Rukh, the fourth son of Timúr, reigned for thirty-eight years, and appears to have been a brave, generous, and enlightened monarch. He removed his capital from Samarkand to Herat, of which place he rebuilt the citadel, restoring and improving the town. Merv also profited from his attention to its material interests. Sir John Malcolm speaks of the splendour of his court and of his encouragement of men of science and learning. He sent an embassy to China; and an English version of the travels to India of one of his emissaries, 'Abdu 'r-Razzák, is to be found in the volumes of the Hakluyt Society. As regards his Persian possessions, he had some trouble in the north-west, where the Türkmans of Asia Minor, known as the Kára Koiyún,<sup>1</sup> or "Black Sheep," led by Kára Yúsuf<sup>2</sup> and his sons Iskandar and Jahan Sháh, had advanced upon Tabriz, the capital of Adarbajian, a province in which they had supplanted the settlers of Halaku, called, after him, 'Ilkhání. The distance from Herat—supposing that city to represent

the centre of imperial power—was favourable to intrigue and revolt in these parts. On the death of Sháh Rukh in 1446 he was succeeded by his son Ulugh Bey, whose taste for scientific pursuits and active patronage of scientific men are practically demonstrated in the astronomical tables bearing his name, quoted by European writers when determining the latitude of places in Persia. He was, moreover, himself a poet and patron of polite literature, and built a college as well as an observatory at Samarkand. On the other hand, there is no evidence to show that he did much to consolidate his grandfather's conquests south of the Caspian. Ulugh Bey was put to death by his son 'Abdu 'l-Latif, who, six months later, was in his turn slain by his own soldiers. Bábar—not the illustrious founder of the Mughal dynasty in India, but an elder member of the same house—next obtained possession of the sovereign power, and established himself in the government of Khurásan and the neighbouring countries. He did not, however, achieve any special reputation, and died after a short rule, from habitual indulgence in intemperate habits,—an abuse which he had vainly striven to check by the registry of a solemn vow. After him Abú Sa'íd, grandson of Míran Sháh, and once governor of Fárs, became a candidate for empire, and was to a great extent successful. This prince allied himself with the Uzbek Tatars, seized upon Búkhára, entered Khurásan, and waged war upon the Türkman tribe aforesaid, which, since the invasion of Adarbajian, had, under Jahan Sháh, overrun Irák, Fárs, and Karman, and pillaged Herat. But he was eventually taken prisoner by Uzun Hasan, and killed in 1468.

It is difficult to assign dates to the few events recorded in Persian history for the eighteen years following the death of 'Abdu 'l-Latif; and, were it not for the happy intervention of chance European missions, the same difficulty would be felt in dealing with the period after the death of Abú Sa'íd up to the accession of Isma'íl Súfi in 1499. Nor can the chain of events within the range of Persia proper be connected with certainty for the period specified by the aid of native annals or histories. Sultan Ahmad, eldest son of Abú Sa'íd, reigned in Búkhára; his brother, 'Umar Shaikh, in Farghána; but the son of the latter, the great Bábar, was driven by the Uzbeks to Kabul (Cabul) and India. More to the purpose is it that Sultan Husáin Mirza, great-grandson of 'Umar Shaikh, son of Timúr, reigned in Herat from 1487 to 1506. His siege and capture of the fort of that city are incidentally told in Bábar's *Commentaries*, where he is described as an old and experienced soldier. He was a patron of learned men, and as such his reign is remarkable for many brilliant names inscribed as visitors to his court. Among others are those of the historians Mírkhund and Khúndamír, and the poets Jámí and Hátíf. But at no time could the control exercised by this scion of a far-famed stock have extended over central and western Persia. The nearest approach to a sovereignty in those parts on the death of Abú Sa'íd is that of Uzun Hasan just mentioned, who achieved his greatness by individual prowess and the force of circumstances. He was the leader of the Ak Koiyún, or "White Sheep" Türkmans, and conqueror of the "Black Sheep," whose chief, Jahan Sháh, he defeated and slew. Between the two tribes there had long been a deadly feud. Both were composed of settlers in Asia Minor, the "Black Sheep" having consolidated their power at Van, the "White" at Diarbekir.

Sir John Malcolm states that at the death of Abú Sa'íd, Sultan Husáin Mirza "made himself master of the empire," and, a little later, that "Uzun Hasan, after he had made himself master of Persia, turned his arms in the direction of Turkey"; but the reader is left to infer

<sup>1</sup> They were commonly called Kára Koiyún-lú and the "White Sheep" Türkmans Ak Koiyún-lú, the affix "lú" signifying possession, i.e., possession of a standard bearing the image of a black or white sheep.

<sup>2</sup> According to Erakine, this chief killed Míran Sháh, whose dwelling-place was Tabriz.

for himself what was the real "empire" of Husain Mirza, and what the limit of the "Persia" of Uzun Hasan. The second could not well be included in the first, because the Türkmans were in possession of the greater part of the Persian plateau, as understood in modern geography, while the "sultan" was luxuriating in Herat, to which Khurásan belonged. It may be assumed as a broad fact that an empire like that acquired by Timúr could not long be maintained by his descendants in its integrity, even though separate kingdoms or sovereignties were formed in its more important divisions. The retention of particular provinces, or groups of provinces, must have depended not only on the loyalty but on the capability of particular rulers and their subordinate governors; and it was manifestly impossible for an emperor at Samarkand or Herat to know what revolutions were taking effect at Baghdád, Tabriz, or similarly remote places, inland or on the seaboard, which passed away from the original "empire" through the weakness or treachery of unfit agents, even when these were lineal descendants of its distinguished founder.

The Turkish adjective *uzun*, "long," applied to Hasan, the Türkman monarch of Persia (called also by the Arabs *Hasanu 't-Tawil*), is precisely the qualifying Persian word *دراز* used in the compound designation of Artaxerxes Longimanus; and Malcolm quotes the statement of a Venetian envoy in evidence that Uzun Hasan was "a tall thin man, of a very open and engaging countenance." This reference, and a further notice in Markham's more recent history, supply the clue to a store of valuable information on the place and period made generally available by the publications of the Hakluyt Society. The narratives of Caferino Zeno, Barbaro, and Contarini, envoys from Venice to the court of Uzun Hasan, are in this respect especially interesting, and throw much light on the personality of one who was a genuine sháh of Iran. Zeno was sent in 1471 to incite this warlike ruler against the Ottoman sultan, and succeeded so far in his mission as to bring the two powers into open warfare. That the result, was disastrous to the sháh is not surprising, but the whole affair seems to hold a comparatively unimportant place in the annals of Turkey.

Uzun Hasan had married Despina (Gr. *Δέσποινα*), daughter of the emperor of Trebizond, Cáo Johannes of the house of the Comneni; and Zeno's wife was niece to this Christian princess. The relationship naturally strengthened the envoy's position at the court, and he was permitted to visit the queen in the name of the republic which he represented. Barbaro and Contarini met at Ispahan in 1474, and there paid their respects to the sháh together. The description of the royal residence—"in the middle of a field, through which a river flowed, in a very delightful locality"—recalls the palaces in that city, such as the Haft Dast, where strangers of distinction are lodged in the present day. Moreover, the continual and excessive instalments of "good confections" brought to satisfy the travellers' appetites show that the lavish hospitality of the local authorities is a time-honoured institution. Kúm and Tauris or Tabriz (then the capital) were also visited by the Italian envoys following in the royal suite; and the incidental notice of these cities, added to Contarini's formal statement that "the extensive country of Ussuncassan [*sic*] is bounded by the Ottoman empire and by Caramanis," and that Siras (Shíráz) is comprehended in it, proves that at least Adarbaijan, Irák, and the main part of the provinces to the south, inclusive of Fárs, were within the dominions of the reigning monarch.

There is good reason to suppose that Jahan Sháh, the Black Sheep Türkman, before his defeat by Uzun Hasan, had set up the standard of royalty; and Zeno, at the

outset of his travels, calls him "king of Persia"<sup>1</sup> in 1450. Chardin alludes to him in the same sense; but, even admitting the validity of his precarious tenure, the limits of his sovereignty were too confined to warrant more than casual mention of his name in an historical summary.

Hasan the Long is a far more prominent figure, and has hardly received justice at the hands of the historian. Indeed, his identity seems to have been lost in the various modes of spelling his name adopted by the older chroniclers, who call him indiscriminately<sup>2</sup> Alymbeius, Asembeius, Asembec, Assimbeo, or Ussan Cassano. He is said to have earned the character of a wise and valiant monarch, to have reigned eleven years, to have lived to the age of seventy, and, on his death in 1477 or (according to Krušinaki and Zeno) 1478, to have been succeeded on the throne of Persia by his son Ya'kúb. This prince, who had slain an elder brother, died by poison, after a reign of seven years. The dose was offered to him by his wife, who had been unfaithful to him and sought to set her paramour on his throne. Krušinaki thus tells the story.

"Notwithstanding the assurance she put on at the very moment she was acting the crime, the king her husband fancying he saw an air of confusion in her countenance, had a suspicion of her, and required her to drink first. As she could not get off of it without condemning herself, she swallowed the poison with an affected intrepidity; which deceived the king, and so encouraged him that after he had drunk of it himself, he commended it to the lips of the prince his son, then with him, who was eight years of age. The poison was so quick, that all three died of it that night in the year 1485."

Writers differ as to the succession to Ya'kúb.<sup>1</sup> Zeno's account is that a son named Alamut (called also Alamut, Alvante, El-wand, and Alwung Bey) was the next king, who, "besides Persia, possessed Diarbekir and part of greater Armenia near the Euphrates." On the other hand, Krušinaki states that, Ya'kúb dying childless, his relative Julaver, one of the grandees of the kingdom, seized the throne and held possession of it for three years. Baisingar, it is added, succeeded him in 1488 and reigned till 1490, when a young nobleman named Rustan (Rustam †) obtained the sovereign power and exercised it for seven years. This account is confirmed by Angiolollo, a traveller who followed his countrymen Barbaro and Contarini to Persia; and from the two authorities combined may be gathered the further narration of the murder of Rustam and usurpation of the throne by a certain Ahmad, whose death, under torture, six months afterwards, made way for Alamut, the young son of Hasan. These discrepancies can be reconciled on reference to yet another record bound up with the narratives of the four Italians aforesaid, and of much the same period. In the *Travels of a Merchant in Persia* the story of Ya'kúb's death is supplemented by the statement that "the great lords, hearing of their king's decease, had quarrels among themselves, so that for five or six years all Persia was in a state of civil war, first one and then another of the nobles becoming sultan. At last a youth named Alamut, aged fourteen years, was raised to the throne, which he held till the succession of Shaikh Ismail." Who this young man was, is not specified; but other writers call Alamut and his brother Murád the sons of Ya'kúb, as, though the relationship were unquestioned.

Now little is known, save incidentally, of Julaver or Rustam; but Baisingar is the name of a nephew of Umar Shaikh, king of Farghána (Ferghana) and contemporary of Uzun Hasan. There was no doubt much anarchy and confusion in the interval between the death of Ya'kúb and the restoration, for two years, of the dynasty of the White Sheep. But the tender age of Alamut would, even in civilized countries, have necessitated a regency; and it may be assumed that he was the next legitimate and more

<sup>1</sup> See also Ramusio's preface.

<sup>2</sup> Knolles, Purchas, Zeno.

generally recognized sovereign. Markham, in designating this prince the last of his house, states that he was dethroned by the renowned founder of the Šafawī dynasty. This event brings us to one of the most interesting periods of Persian history, any account of which must be defective without a prefatory sketch of Isma'īl Šūfī.

*The Šūfī or Šafawī Dynasty (1499-1736).*—Shaikh Saifu 'd-Dīn Izhāk<sup>1</sup>—lineally descended from Mūsā, the seventh imām—was a resident at Ardabil, south-west of the Caspian, some time during the 14th century. It is said that his reputation for sanctity attracted the attention of Timūr, who sought him out in his abode, and was so charmed by the visit that he released, at the holy man's request, a number of captives of Turkish origin, or, as some affirm, Georgians, taken in the wars with Baiyazid, who had been probably reserved for some more cruel end. The act ensured to the shaikh the constant devotion and gratitude of these men,—a feeling which was loyally maintained by their descendants for the members of his family in successive generations. Morier's description of the mausoleum erected to the memory of Shaikh Šūfī at Ardabil enables the reader to form some idea of the extraordinary veneration in which he was held. Among the offerings on the tomb,<sup>2</sup> which was covered with brocades and shawls, bunches of feathers, ostrich eggs, and other ornaments, was a golden ewer set with precious stones, said to have been presented by the Indian emperor Humāyūn.

His son Sadru 'd-Dīn and grandson Kwājah 'Alī (who visited Mecca and died at Jerusalem) retained the high reputation of their pious predecessor. Junaid, a grandson of the last, and not a whit less prominent in the pages of history, married a sister of Uzun Hasan, and by her had a son named Shaikh Haidar, who married his cousin Martha, daughter of Uzun Hasan and Queen Despina. Three sons were the issue of this marriage, Sultan 'Alī, Ibrāhīm Kirza, and the youngest, Isma'īl, the date of whose birth is put down as 1480 for reasons which will appear hereafter. So great was the influence of Shaikh Haidar, and so earnestly did he carry out the principles of conduct which had characterized his family for five generations, that his name has become, as it were, inseparable from the dynasty of his son Isma'īl; and the term "Haidari" (conine) is applied by many persons to indicate generally the Šafawīs of Persia. As to the nature of his teaching, and the peculiar tenets professed, this is hardly the place for their discussion; but it may be broadly stated that the outcome was a division of Muhammadanism vitally momentous to the world of Islām. The Persian mind was peculiarly adapted to receive the form of religion prepared for it by the philosophers of Ardabil.

The doctrines presented were dreamy and mystic; they rejected the infallibility of human wisdom, and threw suspicion on the order and arrangement of human orthodoxy. They breathed in harmony with the feelings of a people who, partly in the Athenian spirit and wholly with Athenian perversity, were ever ready "to tell or to hear some new thing." There was free scope given for the indulgence of that poetical imagination which revels in revolution and chafes at prescriptive bondage. As Malcolm truly and happily remarks, "the natives of Persia are enthusiastically devoted to poetry; the meanest artisan of the principal cities of that kingdom can read or repeat some of the finest passages from their most admired

writers; and even the rude and unlettered soldier leaves his tent to listen with rapture to the strain of the minstrel who sings a mystic song of divine love, or recites the tale of a battle of his forefathers." And he adds, "the very essence of Šūfī-ism is poetry . . . the Masnavi . . . the works of the celebrated Jāmī . . . the book of moral lessons of the eloquent Sa'dī, and 'the lyric and mystic odes of Hafiz . . . to them, they (the Šūfīs) continually refer; and the gravest writers who have defended their doctrine take their proofs from the pages of these and other poets whom they deem to have been inspired by their holy theme."

Those authorities who maintain that Ya'qūb Shāh left no son to succeed him consider valid the claim to the vacant throne of Shaikh Haidar Šūfī. At any rate, he could not be otherwise than formidable to a usurper such as Rustam, both from relationship to the deceased monarch and position as one of the most noted of Šūfī teachers. Purchas says that Ya'qūb himself, "jealous of the multitude of Aidar's disciples and the greatness of his fame, caused him to be secretly murdered"; but Krusinski attributes the act to Rustam a few years later. Zeno, the anonymous merchant, and Angiolello affirm that the devotee was defeated and killed in battle,—the first making his conqueror to be Alamut, the second a general of Alamut's, and the third an officer sent by Rustam named Sulaiman Bey. Malcolm, following the *Zubdatu 't-tawārikh*, relates that Shaikh Haidar was vanquished and slain by the governor of Shirwan. The subsequent statement that his son, Sultan 'Alī, was seized, in company with two younger brothers, by Ya'qūb, "one of the descendants of their grandfather Uzun Hasan, who, *jealous of the numerous disciples that resorted to Ardabil*, confined them to the hill fort of Istakhr in Fars," seems to indicate a second interpretation of the passage just extracted from Purchas, and that there is confusion of persons and incident somewhere. One of the sons here alluded to was Isma'īl, whom Malcolm makes to have been only seven years of age when he fled to Gilan in 1492. Zeno states that he was then thirteen, which is much more probable,<sup>3</sup> and the several data available for reference are in favour of this supposition.

The life of the young Šūfī from this period to his assumption of royalty in 1499 was full of stirring adventure; and his career as Isma'īl I. was a brilliant one for the annals of Persia. According to Zeno, who seems to have carefully recorded the events of the time, he left his temporary home on an island of Lake Van before he was eighteen, and, passing into Karabagh,<sup>4</sup> between the Arras and Kur, turned in a south-easterly direction into Gilan. Here he was enabled, through the assistance of a friend of his father, to raise a small force, with which to take possession of Bākū on the Caspian, and thence to march upon Shumakhi in Shirwan, a town abandoned to him without a struggle. Hearing, however, that Alamut was advancing to meet him, he was compelled to seek new levies from among the Jengian Christians and others. In this he was quite successful. Finding himself at the head of an army of 16,000 men, he thoroughly routed his opponents, and, having cleared the way before him, marched straight upon Tabriz, which at once surrendered. He was soon after proclaimed shāh of Persia (1499), under the designation which marked the family school of thought.

Amamut had taken refuge at Diarbekir; but his brother Murād, at the head of an army strengthened by Turkish auxiliaries, was still in the field with the object of contesting the paternal crown. Isma'īl lost no time in moving against him, and won a new victory on the plains of Tabriz. Murād fled with a small remnant of his soldiers to Diar-

<sup>1</sup> According to Langlès, the annotator of Chardin, his real designation was Abū 'l-Fath Izhāk, the Shaikh Saifu 'l-Hakk wa 'd-Dīn or "pure one of truth and religion."

<sup>2</sup> Langlès finds 1334 to be the year of his death. This is impossible if he was contemporary with Timūr, who was born in 1336. Malcolm's opinion, derived from the *Zubdatu 't-tawārikh*, that the conqueror's visit was paid to Sadru 'd-Dīn, is, however, the more credible theory.

<sup>3</sup> So thinks the editor and annotator of the *Italian Travels in Persia*, Mr Charles Grey.

<sup>4</sup> Possibly Kāra-dāgh, as being the more direct road.

bekir, the rallying-point of the White Sheep Türkmans. One authority (Zeno) states that in the following year Isma'íl entered upon a new campaign in Kurdistan and Asia Minor, but that he returned to Tabriz without accomplishing his object, having been harassed by the tactics of Ala'ud-Daulah, a beylarbey, or governor in Armenia and parts of Syria. Another, ignoring these movements, says that he marched against Murád Khán in 'Irák-'Ajmi ('Irák-'Adjemi) and Shiráz. This last account is extremely probable, and would show that the young Türkmán had wished to make one grand effort to save Ispahan and Shiráz (with Kazvín and the neighbouring country), these being, after the capital Tabriz, the most important cities of Uzun Hasan's Persia. His men, however, apparently dismayed at the growing prestige of the enemy, did not support him, and he was defeated and put to flight. One writer says that he was slain in battle; and, since he appears to have made no further attempt on Persia, the statement is perhaps correct. There is similar evidence of the death of Alamut, who, it is alleged, was treacherously handed over to be killed by the sháh's own hands.

Isma'íl returned again to Tabriz (1501) "and caused great rejoicings to be made on account of his victory." In 1503 he had added to his conquests Baghdád, Mosul, and Jazirah on the Tigris. The next year he was called to the province of Gilán to chastise a refractory ruler. Having accomplished his end, he came back to his capital and remained there in comparative quiet till 1507.<sup>1</sup> Malcolm's dates are somewhat at variance with the above, for he infers that Baghdád was subdued in that particular year; but the facts remain. All writers seem to agree that in 1508 the king's attention was drawn to an invasion of Khurásan by Shaibáni, or Sháhi Beg, the Uzbek, a descendant of Jenghiz and the most formidable opponent of Bábar, from whom he had, seven years before, wrested the city of Samarkand, and whom he had driven from Turkestan to Kabul. Since these exploits he had obtained great successes in Tashkand, Farghána, Hissar, Kunduz, and Khwárizm (Kharezm), and, at the time referred to, had left Samarkand intent upon mischief south and west of the Oxus, had passed the Murgáb, and had reached Sarakhs. Isma'íl encamped on this occasion at Ispahan, and there concentrated the bulk of his army,—strengthening his northern (and probably north-eastern) frontier with large bodies of cavalry. Zeno's statement that the royal troops were kept for the whole year in a state of suspense and preparation for encountering their powerful adversaries derives a colour of truth from the circumstance that, before the Uzbek army of invasion could have quite overrun the Khurásan of Husáin Mirza, it found occupation to the eastward in Herat and Kandahar; and it must have been represented, even in Mashhad, Nishápúr, Astrábád, and Turshiz—all named as the scenes of conflict—rather by lieutenants than by the leader in person. Such diversion from any direct invasion of his own territories may have caused the sháh to maintain an attitude of simple watchfulness. In 1510, when Shaibáni had invaded Khurásan the second time, and in person, and had entered the fine province of Mazandaran—then in the possession of an independent chief—it was discovered that his troops, in the wantonness of success, had ravaged the Persian province of Karman. Sháh Isma'íl had asked for redress, referring to the land encroached on as "hereditary"; and Shaibáni had replied that he did not understand on what was founded the claim "to inherit." Mutual taunt and recrimination followed; and eventually the Persian troops were put in movement, and the Uzbeks, having been divided into small detachments scattered over the country, fell back and retreated to Herat. Their leader, however,

<sup>1</sup> Angiolello.

not being in a position to oppose the sháh in the field, repaired to Merv, where he could obtain sufficient reinforcements, or whence he could, if hard pushed, retire across the Oxus. Isma'íl quickly followed him there, and enticed him out to battle by the use of taunt and reproach at his remaining within walls. Shaibáni was defeated and fled, but was overtaken in his flight, surrounded, and put to the sword, together with numerous relatives and companions (see MONGOLS, vol. xvi. p. 749).

The next remarkable event in Isma'íl's reign is his war with Sultan Salim I. Its origin may be traced to the Ottoman emperor's hatred and persecution of all heretical Moslems in his dominions, and the sháh's anger at the fanaticism which had urged him to the slaughter of 40,000 Turks suspected to have thrown off the orthodox Sunni doctrines. The declaration of war sent by Salim in the form of a letter is one of the most singular of documents, and breathes the true spirit of the age: "I, the glorious Sultan . . . address myself to thee, Amr Isma'íl, chief of the Persian troops, who art like in tyranny to Zohak and Afrasiab, and art destined to perish like the last Dara." Words such as these might well provoke a less haughty potentate than the Súfi; and, when to them was added the accusation of iniquity, perjury, blasphemy, impiety, heresy, and schism, it is not surprising that the response was a ready resort to arms.<sup>2</sup> As a preliminary, however, to this decisive step Isma'íl replied to the sultan in a calm and dignified letter, denying the existence of a *casus belli*, expressing willingness to resume peaceful relations, and regretting the mode of address it had been thought fit to adopt towards himself; but he nullified the conciliatory passages by the ironical conclusion that the sultan's communication must have emanated from the brain of a secretary who had taken an overdose of narcotics,—a remark the significance of which was aggravated by the accompaniment of a box of opium, and the popular belief that Salim was addicted to the use of the drug.

The sultan's army advanced into Adarbáijan and western Persia through Tokat and Arrinjan. Isma'íl had at this time the greater number of his soldiers employed in his newly-conquered province of Khurásan, and was driven to raise new levies in Kurdistan to obtain a sufficient force to resist the invasion. It is asserted by some that his frontier then extended westward to Sivas, a city situated in a large high plain watered by the Kizil Irmak, and that thence to Khoi, 90 miles west of Tabriz, he followed the approved and often successful tactics of ravaging and retreating, so as to deprive his advancing enemy of supplies. There is good evidence to show that the Turkish janissaries were within an ace of open revolt, and that but for extraordinary firmness in dealing with them they would have abandoned their leader in his intended march upon Tabriz. In fine, at or near Khoi, the frontier-town of Adarbáijan, the battle (1514) was fought between the two rival monarchs, ending in the defeat of the Persians and the triumphant entry of Salim into their capital.

There are stirring accounts of that action and of the gallant deeds performed by Salim and Isma'íl, both personally engaged, in it, as well as by their generals.<sup>3</sup> Others maintain that Isma'íl was not present at all.<sup>4</sup> It is tolerably

<sup>2</sup> Creasy's *History of the Ottoman Turks*.

<sup>3</sup> Knolles, Malcolm, Creasy, Markham, &c.

<sup>4</sup> Zeno. Angiolello says that "the Sophi monarch had left for Tauris [Tabriz] in order to assemble more troops." Krusinski infers much to the same effect, for he notes that "Salim came in person and took Tauris from Ismail, but at the noise of his approach was obliged to retreat with precipitation." The battle must thus have been fought and the victory gained when the sháh was himself absent. Yet Markham quotes a journal which thus records his feats of prowess: "It was in vain that the brave Sháh, with a blow of his sabre, severed a chain with which the Turkish guns were fastened together to resist the shock of the Persian cavalry."

certain that the Turks won the day by a better organization of the arms of the military service, superiority of numbers, and more especially the use of artillery. On the side of the Persians the force consisted of little more than cavalry.

Salim remained at Tabriz no more than eight days. Levying a contribution at that city of a large number of its skilled artisans, whom he sent off to Constantinople, he marched thence towards Karabagh with intent to fix his winter quarters in those parts and newly invade Persia in the spring, but the insubordination of his troops rendered necessary his speedy return to Turkey. His expedition, if not very glorious, had not been unproductive of visible fruits. Besides humbling the power of an arrogant enemy, he had conquered and annexed to his dominions the provinces of Diarbekir and Kurdistan.

From 1514 to 1524, although the hostile feeling between the two countries was very strong, there was no serious nor open warfare. Salim's attention was diverted from Persia to Egypt; Isma'il took advantage of the sultan's death in 1519 to overrun and subdue unfortunate Georgia, as Jahan Sháh of the "Black Sheep" had done before him; but Sulaiman had not won without cause his attribute of "great," and was too strong a successor to the imperial throne to admit of retaliatory invasion being carried out with impunity at the cost of Turkey.

In 1524 Isma'il died<sup>1</sup> at Ardabil when on a pilgrimage to the tomb of his father. "The Persians dwell with rapture on his character," writes Sir John Malcolm, for they deem him "not only the founder of a great dynasty, but the person to whom that faith in which they glory owes its establishment as a national religion. He is styled in their histories Shah Shian, or 'king of the Shiah,' an appellation which marks the affection with which his memory is regarded. Though he may not be entitled to their extravagant praises, he certainly was an able and valiant monarch." And he quotes a note handed down by Purchas from a contemporary European traveller which reports of him thus. "His subjects deemed him a saint, and made use of his name in their prayers. Many disdained to wear armour when they fought under Ismail; and so enthusiastic were his soldiers in their new faith that they used to bare their breasts to their enemies and court death, exclaiming, 'Shiah! Shiah!' to mark the holy cause for which they fought."

The proposition has been already laid down that Oriental celebrities, whether heroes or tyrants, as depicted by native flunners, bear commonly so strong a family resemblance one with another that the European reader is unable to discriminate between the 'Abbáses and Akbars, the Tímúrs and the Nádírs; and it cannot be pleaded that Isma'il Sháh Síff is an exception to the rule. He is belauded and reviled according to the lights or prejudices of his historian. "Reputed one of the greatest and most famous kings that ever ruled in the East,"<sup>2</sup> he is at the same time charged with acts of the greatest cruelty and most flagrant vice.<sup>3</sup> Purchas, apparently guided by the "Italian merchant" and Angiolello, has described him as "of faire countenance, of reasonable stature, thicke and large in the shoulder, shauen al but the mustaches; left-handed, and stronger than any of his nobles."

Sháh Tahmásp,<sup>4</sup> the eldest of the four sons of Isma'il,

<sup>1</sup> Malcolm says 1523, Krusinski 1525; Angiolello heard of his death at Cairo in August 1524. Krusinski adds that he was forty-five years of age. <sup>2</sup> Krusinski.

<sup>3</sup> See chaps. xiv. and xxii. of *Travels of a Merchant in Persia*, Hakluyt reprint, 1873.

<sup>4</sup> Angiolello calls him "Shiathemese." As an instance of the absurd transliterating current in France as in England the word "Ach-tacon" may be mentioned. It is explained in Chardin's text to mean "les hôpitaux à Tauris: c'est-à-dire *heux ou l'on fait profusion de vivres*." Chardin's editor remarks, "La dernière partie de ce mot

succeeded to the throne on the death of his father.<sup>5</sup> The principal occurrences in his reign, placed as nearly as possible in chronological order, were a renewal of war with the Uzbeks, who had again invaded Khurásan, and the overthrow of their army (1527); the recovery of Baghdád from a Kurdish usurper (1528); the settlement of an internal feud between Kizil-bash tribes (Shámli and Tukúlu), contending for the custody of the royal person, by the slaughter of the more unruly of the disputants (1529); the rescue of Khurásan from a fresh irruption, and of Herat from a besieging army of Uzbeks (1530); a new invasion of the Ottomans, from which Persia was saved rather by the severity of her climate than by the prowess of her warriors (1533); the wresting of Baghdád from Persia by the emperor Sulaiman (1534); the king's youngest brother's rebellion and the actual seizure of Herat, necessitating the recovery of that city and a march to Kandahar (1536); the temporary loss of Kandahar in the following year (1537), when the governor ceded it to Prince Kamran, son of Bábar; the hospitable reception accorded to the Indian emperor Humáiyún (1543); the rebellion of the sháh's brother next in age, Ilkhás, who, by his alliance with the sultan, brought on a war with Turkey (1548);<sup>6</sup> and finally a fresh expedition to Georgia, followed by a revengeful incursion which resulted in the enforced bondage of thousands of the inhabitants (1552).

Baiyazid, a son of the Turkish emperor, rebelled, and his army was beaten in 1559 by the imperial troops at Koniah in Asia Minor. He fled to Persia and took refuge with Sháh Tahmásp, who pledged himself to give him a permanent asylum. Sulaiman's demand, however, for extradition or execution was too stern and peremptory for refusal; the pledge was broken, and the prince was delivered up to the messengers sent to take him. Another account ignores the pledge and makes the surrender of the guest to have been caused by his own bad conduct. Whatever the motive, the act itself was highly appreciated by Sulaiman, and became the means of cementing a recently-concluded peace between the two monarchs, which theretofore, perhaps, had been more formal than real. "Perhaps the domestic affliction of the emperor and the anarchy which in his later years had spread in his dominions had, however, more to do with the maintenance of tranquillity than any mere personal feeling. It is to be feared that at this time not only was there religious fanaticism at work to stir up the mutual hatred ever existing between Sunni and Shí'ah, but the intrigue of European courts was probably directed towards the maintenance of an hostility which deterred the sultan from aggressive operations north and west of Constantinople. "Tis only the Persian stands between us and ruin" is the reported saying of Busbecq, ambassador at Sulaiman's court on the part of Ferdinand of Austria; "the Turk would fain be upon us, but he keeps him back."

In 1561 Anthony Jenkinson arrived in Persia with

est méconnaissable, et je ne puis deviner quel mot Persan signifie profusion a pu donner naissance à la corruption qu'on voit ici." In other words, the first syllable "ach" (Anglice *ack*) was understood in its common acceptance for "food" or "victuals"; but "tacon" was naturally a puzzle. The solution of the whole difficulty is, however, to be found in the Turco-Persian *آتشخانه* *akshákháneh*, pronounced by Turks *akshákhána*, or more vulgarly *akshákhán* and even to a French ear *ach-tacon*, a hospital, literally a sick-house. This word is undoubtedly current at Tabriz and throughout northern Persia.

<sup>5</sup> The other brothers were Ilkhás, Bahráim, and Sáim Mirza, each having had his particular spangé assigned him.

<sup>6</sup> Professor Creasy says that "Suliman led his armies against the Persians in several campaigns (1533, 1534, 1535, 1543, 1552, 1554), during which the Turks often suffered severely through the difficult nature of the countries traversed, as well as through the bravery and activity of the enemy." All the years given were in the reign of Tahmásp I.



a letter from Queen Elizabeth to the sháh. He was to treat with his majesty of "Traffique and Commerce for our English Marchants,"<sup>1</sup> but his reception was not encouraging, and led to no result of importance.

Tahmásp died in 1576, after a reign of about fifty-two years. He must have been some sixty-six years of age, having come to the throne at fourteen. Writers describe him as a robust man, of middle stature, well-lipped, and of tawny complexion. His long reign was hardly a profitable or glorious one to Persia, especially in respect of the losses to Turkey. He was not wanting in soldierly qualities; but his virtues were rather negative than decided. While one writer acquits him of any remarkable vices, and even calls him prudent and generous, another taxes him with love of ease, avarice, and injustice. If it be true that he abandoned his old capital, Tabriz, for Kasvin because the former was too close to Ardabil, his birthplace, and reminded him too keenly of the mean condition of his grandfather, Shaikh Hafdar, his *morale* must have been low indeed.<sup>2</sup>

The deceased sháh had a numerous progeny, and on his death his fifth son, Haidar Mirza, proclaimed himself king, supported in his pretensions by the Kizil-báh tribe of Ustájult. Another tribe, the Afahár, insisted on the succession of the fourth son, Isma'il. Had it not been that there were two candidates in the field, the contention would have resembled that which arose shortly after Tahmásp's accession. As it was, the claim to guardianship of the royal person was put forward, but each tribe declared for its own particular nominee. Finally Isma'il, profiting from his brother's weak character and the intrigues set on foot against him, obtained his object, and was brought from a prison to receive the crown.

The reign of Isma'il II. was a short one,—less than two years. He was found dead in the house of a confectioner in Karvin, having left the world either drunk, drugged, or poisoned. No steps were taken to verify the circumstances, for the event itself was a cause of general relief and joy. He has been represented as a tyrant of the worst type, but it is only right to observe that his youth and part of his manhood had been embittered by injustice and ill-treatment. A prisoner in a dreary fort for years, if his accession to power was marked by cruelties such as disgraced the name of Tiberius, he had, like Tiberius, been brutalized by a hard and continuous provocation.

He was succeeded by his eldest brother, Muhammad Mirza, otherwise called Muhammad Khudábanda, whose claim to sovereignty had been originally put aside on the ground of physical infirmity. A few words will dispose of this prince's career as a sovereign of Persia. Historians are divided as to his qualities, though he certainly failed to prove, in any shape, equal to the opportunity opened to him. He had the good sense to trust his state affairs almost wholly to an able minister; but he was cowardly enough to deliver up that minister into the hands of his enemies. His kingdom was distracted by intestine divisions and rebellion, and the foe appeared also from without. On the east his youngest son, 'Abbás, held possession of Khurásan; on the west the sultan's troops again entered Adarbáijan and took Tabriz. His eldest son, Hamza Mirza, nobly upheld his fortunes to the utmost of his power, reduced the rebel chieftains, and forced the Turks to make peace and retire; but he was stabbed to death by an assassin. On the news of his death reaching Khurásan, Murshid Káfí Khán, leader of the Ustájult Kizil-báh, who had made good in fight his claims to the guardianship of 'Abbás, at once conducted the young prince from that province to Kasvin, and occupied the royal city. The object was evident, and in accordance with the popular feeling. 'Abbás,

who had been proclaimed king by the nobles at Nishápur some two or three years before this occurrence, may be said to have now undertaken in earnest the cares of sovereignty. His ill-starred father, at no time more than a nominal ruler, was at Shirás, apparently deserted by soldiers and people. Malcolm infers that he died a natural death, but when<sup>3</sup> or where is not stated. Alluding to him at this period, he writes, "He was never afterwards mentioned." The stories originated by Olearius that Hamza and a second son, Isma'il, each reigned a few months may refer to attempts on the part of the Kizil-báh chiefs to assert, for one or the other, a share of sovereign power, but do not seem to merit particular consideration.

Sháh 'Abbás, the Great, commenced his long and glorious reign (1586) by retracing his steps towards Khurásan, which had been reinvaded by the Uzbeks almost immediately after his departure thence with the Kizil-báh chief. They had besieged and taken Herat, killed the governor, plundered the town, and laid waste the surrounding country. 'Abbás advanced to Mashhad, the provincial capital and great resort of Persian pilgrims as the burial-place of Imám Riza, but owing to internal troubles he was compelled to return to Kasvin without going farther east. In his absence 'Abdul Munim Khán, the Uzbek commander, attacked the sacred city, obtained possession of it while the sháh lay helplessly ill at Tehran, and allowed his savage soldiers full licence to kill and plunder. The whole kingdom was perplexed, and 'Abbás had much work to restore confidence and tranquillity. But circumstances rendered impossible his immediate renewal of the Khurásan warfare. He was summoned to Shirás to put down rebellion in Fárs; and, that being over, before he could give his individual attention to drive out the Uzbeks, he had to devise the best means of securing himself against Turkish inroads threatening from the west. He had been engaged in a war with Murád III. in Georgia. Peace was concluded between the two sovereigns in 1590; but the terms were unfavourable to Persia, who lost thereby Tabriz and one or more of the Caspian ports. A somewhat offensive stipulation was included in the treaty to the effect that Persians were not to curse any longer the first three khalifs, —a sort of privilege previously enjoyed by Sháhahs as part and parcel of their religious faith.

In 1597 'Abbás renewed operations against the Uzbeks, and succeeded in recovering from them Herat and Khurásan. Eastward he extended his dominions to Balkh, and in the south his generals made the conquest of Bahrain (Bahrein), on the Arabian side of the Persian Gulf, and the territory and islands of the Persian seaboard, inclusive of the mountainous province of Lar. He strengthened his position in Khurásan by planting colonies of Kurdish horsemen on the frontier, or along what is called the "atak" or skirt of the Türkman mountains north of Persia. In 1601 the war with the Ottoman empire, which had been partially renewed prior to the death of Sultan Murád in 1595, with little success on the Turkish side, was now entered upon by 'Abbás with more vigour. Taking advantage of the weakness of his ancient enemy in the days of the poor voluptuary Muhammad III., he began rapidly to recover the provinces which Persia had lost in preceding reigns, and continued to reap his advantages in succeeding campaigns under Ahmad I., until under Othman II. a peace was signed restoring to Persia the boundaries which she had obtained under the first Isma'il. On the other side Kandahar, which Tahmásp's lieutenant had yielded to the Great Moghal, was recovered from that potentate in 1609. The following slightly abridged extract from Clements Markham's history of Persia, relating to distinguished Englishmen of the period, will be an appro-

<sup>1</sup> Pumba.<sup>2</sup> Kruzinski.<sup>3</sup> Kruzinski says in 1585.

priate conclusion of the narrative of events as above summarized.

"In 1598 Sir Anthony and Robert Shirley, two English gentlemen, arrived at the Sháh's court at Kazvin with a numerous retinue. They were well received, and after some months Sir Anthony returned to Europe with credentials to several Christian princes. Robert, with five Englishmen, remained at the court of the Sháh. He married a Circassian lady named Teresa, and in 1607 was sent by 'Abbás as his ambassador to James I. of England. After travelling through Europe and remaining a long time at Madrid, Sir Robert Shirley and his Circassian wife landed in his native country in 1611, and was received by James I. with every respect, as the ambassador of a powerful sovereign. His object was to open a trade between England and Persia, but he did not meet with success, owing to the opposition of the Levant merchants. He sailed from Dover with his wife in 1613, and after visiting the court of the Great Mogul, reached Isfahan in 1615. He was soon afterwards sent as ambassador to Spain, where he remained until 1622. In 1613, while Shirley was residing at Madrid, the government of Philip III. of Spain sent an embassy to Persia, at the head of which was Don Garcia de Silva y Figueroa, an able and learned diplomatist, who made good use of his time in collecting information, and in writing a detailed account of his mission and of Persia, including a Life of Timúr. Garcia de Silva landed at Ormuz, and proceeded thence to Shíráz, where he was most hospitably entertained. The ambassador was forwarded to Kazvin in June, and had an audience of the Sháh, who received him very graciously. Many conversations afterwards took place between 'Abbás and the stately Spaniard, touching Spanish victories over the Turks, and other matters of state. But the main object of the embassy, namely, security for Ormuz, which was now, through the absorption of Portugal, a Spanish possession, was not obtained. Garcia de Silva returned home by way of Aleppo, and embarked at Tripoli for France on 12th November 1616, devoutly praying that his friend the Sháh might be victorious over the Grand Turk.

"In the meanwhile Sháh 'Abbás was occupied in establishing and regulating the important trade of the Persian Gulf. Lar had previously been completely subdued; and Fars was ruled by one of the Sháh's most trusty and faithful servants. In 1622 the Sháh determined on the expulsion of the Portuguese from the Persian Gulf. They had seized upon the Isle of Ormuz in 1507, under the famous Albuquerque, and in their hands it had attained great prosperity, and become the emporium of all the commerce of the gulf. But they were quite independent of the Sháh of Persia, whose jealousy and resentment they excited. Assisted by the English East India Company, 'Abbás collected a fleet at Gombroon, and embarked a Persian force under Imám Kúli Khán. They laid siege to Ormuz, and the Portuguese, having no hope of succour, were forced to surrender. The island is now covered with desolate heaps of ruins. The port of Gombroon, on the mainland, and sheltered by the islands of Kishm and Ormuz, rose on the fall of the Portuguese city. It received the name of *Bandar 'Abbás*, and both the English and Dutch were allowed to establish factories there.

"In 1623 Sir Robert Shirley again arrived in England on an embassy from the Sháh; and in 1627 sailed for Persia, in company with Sir Dormer Cotton, who was sent as envoy from Charles I. of England to the Sháh of Persia. They landed at Gombroon in 1628, and Sir Dormer obtained a very gracious reception from 'Abbás, at Kazvin, where he soon afterwards died. Sir Robert Shirley had now grown old in the service of Persia. On his return he was slighted by the Sháh and his favourite, Muhammad 'Ally Beg, and he died at Kazvin in July 1628. Of all the brave and gallant adventurers of the glorious age of Elizabeth, Sir Robert Shirley was by far the greatest traveller, with the exception, perhaps, of Anthony Jenkinson."

At the age of seventy, after a reign of forty-two years, 'Abbás died at his favourite palace of Farahabad, on the coast of Mazandaran, on the night of the 27th January 1628. Perhaps the most distinguished of all Persian kings, his fame was not merely local but world-wide. Isfahan was his capital, and he did much for its embellishment and enlargement. At his court were ambassadors from England, Russia, Spain, Portugal, Holland, and India. To his Christian subjects he was a kind and tolerant ruler. His conquests have been already mentioned; but there are few sovereigns of an age so closely following the mediæval who have done such real good to their country by material improvement and development of resources. The establishment of internal tranquillity, the expulsion of interlopers and marauders like Turks and Uzbeks, the introduction of salutary laws, and the promotion of public works of utility—

these alone would render remarkable his two-score years of enlightened government. Even in the last quarter of the 19th century the gratified traveller admires the magnificent caravansarás which afford him rest and shelter, and the solid bridges which facilitate his "chapar" (posting), and of which, if he ask particulars, he invariably hears that they were constructed by Sháh 'Abbás.<sup>1</sup> With a fine face, "of which the most remarkable features were a high nose and a keen and piercing eye,"<sup>2</sup> he is said to have been below the middle height, robust, active, a sportsman, and capable of much endurance. It is, however, to be regretted that this monarch's memory is tarnished by more than one dark deed. The murder of his eldest son, Súfi Mirza, and the cruel treatment of the two younger brothers, were stains which could not be obliterated from the page of history by an after-repentance. All that can be now said or done in the matter is to repeat the testimony of historians that his grief for the loss of Súfi Mirza was profound, and that, on his death-bed, he nominated that prince's son (his own grandson) his successor. Kruinski adds that, on being told at that time by his confidential officers of a prophecy which some astrologers had made to the effect that the new king would reign but three months at most, he replied, "Let him reign as long as he can, though it be but three days. I shall be glad of the assurance that one day, at least, he will have that crown upon his head which was due to the prince, his father."

Sám Mirza was seventeen years of age when the nobles, in fulfilment of the charge committed to them, took him from the "haram" and proclaimed him king under the title of Sháh Súfi. He reigned fourteen years, and his reign was a succession of barbarities, which can only be attributed to an evil disposition acted upon by an education not only wanting the *ingenus artes* but void of all civilizing elements and influences. Taught to read and write, his diversions were to shoot with the bow and ride upon an ass. There was a rumour, moreover, that his father, to stunt the possible growth of wit, ordered him a daily supply of opium. When left to his own devices, he became a drunkard and a murderer, and is accused of the death of his mother, sister, and favourite queen. Among many other sufferers Imám Kúli Khán, conqueror of Lar and Ormuz, the son of one of 'Abbás's most famous generals, founder of a college at Shíráz, and otherwise a public benefactor, fell a victim to his savage cruelty. During his reign the Uzbeks were driven back from Khurásan, and a rebellion was suppressed in Gilan; but Kandahar was again handed over to the Mughals of Dehli (Delhi), and Baghdád retaken from Persia by Sultan Murád,—both serious national losses. Tavernier, without charging the sháh with injustice to Christians, mentions the circumstance that "the first and only European ever publicly executed in Persia was in his reign." He was a watchmaker named Rodolph Stadler, who had slain a Persian on suspicion of intrigue with his wife. Offered his life if he became a Moalem, he resolutely declined the proposal, and was decapitated. His tomb is to be recognized at Isfahan by the words "Cy git Rodolphe" on a long wide slab. Sháh Súfi died (1647) at Kashan and was buried at Kúm.

His son, 'Abbás II., who succeeded him, appears to have possessed some good qualities, and to have been actuated by liberal sentiments; but his accession to the throne in extreme youth, and the restraint put upon him by his advisers, were fatal to healthy development, and on arriving at an age which should have been that

<sup>1</sup> It would be unfair, however, to forget that there are, in parts of Persia, especially Karman, some fine caravansarás whose construction is due to the munificence of governors or private individuals. 'Abbás seems certainly to have set the example, and to have furnished the best specimens.

<sup>2</sup> Malcolin.

of discretion he became wilfully indiscreet. Beyond the credit of regaining Kandahar, an operation which he is said to have directed in person when barely sixteen, there is not much to mark the period of his life to the outer world. As to foreign relations, he received embassies from Europe and a deputation from the French East India Company; he sought to conciliate the Uzbeks by treating their refugee chiefs with unusual honour and sumptuous hospitality; he kept on good terms with Turkey; he forgave the hostility of a Georgian prince when brought to him a captive; and he was tolerant to all religions,—always regarding Christians with especial favour. But he was a drunkard and a debauchee, and chroniclers are divided in opinion as to whether he died from the effects of drink or licentious living. That he changed the system of blinding his relatives from passing a hot metal over the open eye to an extraction of the whole pupil is indicative of gross brutality. 'Abbás II. died (1668) at the age of thirty-eight, after a reign of twenty-seven years, and was buried at Kúm in the same mosque as his father.

'Abbás was succeeded by his son, Sháh Šúfi II., crowned a second time under the name of Sháh Sulaiman.

Sir John Malcolm remarks that from the middle of the reign of 'Abbás II. till the elevation of Nádír Sháh, or for about eighty years, there are but few Persian histories which give particular or authentic accounts of current events; and he attributes this circumstance to the absence for nearly a century of any one political event of magnitude. "And yet," he writes—

"this extraordinary calm was productive of no advantage to Persia. The princes, nobles, and high officers of that kingdom, were, it is true, exempt from the dangers of foreign or internal war; but their property and their lives were the sport of a succession of weak, cruel, and debauched monarchs. The lower orders were exposed to fewer evils than the higher, but they became every day more unwarlike; and what they gained by that tranquillity which the state enjoyed, lost almost all its value when they ceased to be able to defend it. This period was distinguished by no glorious achievements. No characters arose on which the historian could dwell with delight. The nation may be said to have existed upon the reputation which it had before acquired till all it possessed was gone, and till it became, from the slow but certain progress of a gradual and vicious decay, incapable of one effort to avert that dreadful misery and ruin in which it was involved by the invasion of a few Afghan tribes, whose conquest of Persia affixed so indelible a disgrace upon that country, that we cannot be surprised that its historians have shrunk from the painful and degrading narration."

Though weak, dissolute, and cruel, Sulaiman is not without his panegyrists. Chardin, whose testimony is all the more valuable from the fact that he was contemporary with him, relates many stories characteristic of his temper and habits. The statement that on one occasion he compelled his grand wazir to drink to intoxication, and on another to have his hair cut by a barber after the unorthodox fashion of the day, contrary to the old man's religious prejudices, belongs to the record of unworthy and disgraceful acts. He kept up a court at Ispahan which surprised and delighted his foreign visitors, among whom were ambassadors from European states; and one learned writer, Kaempfer, credits him with wisdom and good policy. *Au reste*, during his reign Khurásan was invaded by the ever-encroaching Uzbeks, the Kapchak Tatars plundered the shores of the Caspian, and the island of Kishm was taken by the Dutch; but the kingdom suffered otherwise no material loss. He died in 1694, in the forty-ninth year of his age and twenty-sixth of his reign.

About a year before his death he is described by Sanson,<sup>1</sup> a missionary from the French king Louis XIV., as tall, strong, and active, "a fine prince,—a little too effeminate for a monarch," with "a Roman nose very well proportioned to other parts," very large blue eyes, and "a milking mouth, a beard painted black, shav'd round, and

well turn'd, even to his ears." His air was "affable, but nevertheless majestic"; he had a masculine and agreeable voice, and sweet manner of speaking, and was "so very engaging that when you but bow'd to him he seem'd in some measure to return it by a courteous inclining of his head, and which he always did smiling." The same writer greatly praises him for his kindness to Christian missionaries.

Krusinski's memoir is full of particulars regarding Sháh Husáin, the successor of Sulaiman. He had an elder and a younger brother, sons of the same mother, but the eldest had been put to death by his father's orders, and the youngest secreted by maternal precaution lest a similar fate should overtake him. There was, however, a second candidate for power in the person of a half-brother, 'Abbás. The latter prince was the worthier of the throne, but the other better suited the policy of the eunuchs and those noblemen who had the right of election. Indeed Sulaiman himself is reported to have told the grandees around him, in his last days, that "if they were for a martial king that would always keep his foot in the stirrup they ought to choose Mirza 'Abbás, but that if they wished for a peaceable reign and a pacific king they ought to fix their eyes upon Husáin." But he himself made no definite choice.

Husáin was selected, as might have been anticipated. On his accession (1694) he displayed his attachment to religious observances by prohibiting the use of wine,—causing all wine-vessels to be brought out of the royal cellars and destroyed, and forbidding the Armenians to sell any more of their stock in Ispahan. The sháh's grandmother, by feigning herself sick and dependent upon wine only for cure, obtained reversal of the edict; and the process by which the venerable lady made her son, in pure regard to herself, drink the first glass with her (and thereby become a confirmed tippler) is woven into a story good enough to attract a writer of vaudevilles. For the following account of Sháh Husáin and his successors to this accession of Nádír Sháh, Markham's abstract history has been mainly utilized.

The new king soon fell under the influence of mullas, and was led so far to forget his own origin as to persecute the Šáfiá. Though good-hearted, he was weak and licentious; and once out of the hands of the fanatical party he became enamored by women and entangled in harem intrigues. For twenty years a profound peace prevailed throughout the empire, but it was the precursor of a terrible storm destined to destroy the Safawi dynasty and scatter calamity broadcast over Persia. In the mountainous districts of Kandahar and Kabul the hardy tribes of Afghans had for centuries led a wild and almost independent life. They were divided into two great branches—the Ghilzís of Ghazni and Kabul and the Sádúzís of Kandahar and Herat. More than one fanciful explanation is given of the etymology of the first name; the most probable one is perhaps that which connects them with a Turki tribe of Khalji or Khilagi, a word not improbably derived from the Turkish *khilj*, "a sword," the affix "chi" or "ji" always denoting possession. The second take their name from Sádú, their leader in the time of Sháh 'Abbás. In 1702 a newly-appointed governor, one Sháh Nawás, called Gúrji Khán from having been "wall" or ruler of Georgia, arrived at Kandahar with a tolerably large force. He was a clever and energetic man, and had been instructed to take severe measures with the Afghans, some of whom were suspected of intriguing to restore the city to the Delhi emperor. At this time Kandahar had been for sixty years uninterruptedly in the sháh's possession. The governor appears to have given great offence by the harshness of his proceedings, and a Ghilzí chief named Mir Wá'iz, who had complained of his tyranny, was sent a prisoner to Ispahan. This person had much ability and no little cunning. He was permitted to go on a pilgrimage to Mecca, and on his return in 1708 he so gained upon the confidence of the Persian court that he was allowed to go back to his country. At Kandahar he planned a conspiracy against the Government, slew Gúrji Khán and his retinue, seized the city, defeated two Persian armies sent against him, and died a natural death in 1716. His brother, Mir 'Abdallah, succeeded him in the government of the Afghans; but after a few months, Mahmúd, a son of Mir Wá'iz, a very young man, murdered his uncle and assumed the title of a sovereign prince.

In the meanwhile dark clouds were rising all round the horizon

<sup>1</sup> *Present State of Persia*, London, 1695.

ready to overwhelm the doomed Safawi dynasty. The Sédúzai tribe revolted at Herat, and declared itself independent in 1717; the Kurds overran the country round Hamadan; the Uzbeks desolated Khurásan; and the Arabs of Maskat seized the island of Al-Bahrain and threatened Bandar-'Abbás. Thus surrounded by dangers on all sides the wretched sháh was bewildered. He made one vain attempt to regain his possessions in the Persian Gulf; but the Portuguese fleet which had promised to transport his troops to Al-Bahrain was defeated by the imám of Maskat and forced to retreat to Goa.

The court of Ispahan had no sooner received tidings of this disaster than Mahmúd, with a large army of Afghans, invaded Persia in the year 1721, seized Karman, and in the following year advanced to within four days' march of the city of Ispahan. The sháh offered him a sum of money to return to Kandahar, but the Afghan answered by advancing to a place called Gulnabad, within 9 miles of the capital. The effeminate and luxurious courtiers were taken completely by surprise; no preparation had been made, and the capital was unprovided with either provisions or ammunition. The ill-disciplined Persian army, hastily collected, advanced to attack the rebels. Its centre was led by Shaikh 'Alí Khán, covered by twenty-four field-pieces. The wáli of Arabia commanded the right, and the 'itímádu' d-daulah, or prime minister, the left wing. The whole force amounted to 50,000 men, while the Afghans could not count half that number.

On 8th March 1722 the richly-dressed hosts of Persia appeared before the little band of Afghans, who were scorched and disfigured by their long marches. The wáli of Arabia commenced the battle by attacking the left wing of the Afghans with great fury, routing it, and plundering their camp. The prime minister immediately afterwards attacked the enemy's right wing, but was routed, and the Afghans, taking advantage of the confusion, captured the Persian guns and turned them on the Persian centre, who fled in confusion without striking a blow. The wáli of Arabia escaped into Ispahan, and Mahmúd the Afghan gained a complete victory. Fifteen thousand Persians remained dead on the field. A panic now seized on the surrounding inhabitants, thousands of country people fled into the city, and the squares and streets were filled with a helpless multitude. Ispahan was then one of the most magnificent cities in Asia, containing more than 600,000 inhabitants. After his victory Mahmúd seized on the Armenian suburb of Julfa, and invested the doomed city; but Tahmásp, son of the sháh, had previously escaped into the mountains of Masandaran. Famine soon began to press hard upon the besieged, and in September Sháh Husáin offered to capitulate. He agreed to abdicate in favour of Mahmúd, and to deliver himself up as a prisoner. Having been conducted to the Afghan camp, he fixed the royal plume of feathers on the young rebel's turban with his own hand; and 4000 Afghans were ordered to occupy the palace and gates of the city.<sup>1</sup> Mahmúd entered Ispahan in triumph, with the captive sháh on his left hand, and, seating himself on the throne in the royal palace, he was saluted as sovereign of Persia by the unfortunate Husáin. When Tahmásp, the fugitive prince, received tidings of the abdication of his father he at once assumed the title of sháh at Karvin.

Turkey and Russia were not slow to take advantage of the calamities of Persia. The Turks seized on Tiflis, Tabris, and Hamadan, while Peter the Great, whose aid had been sought by the friendless Tahmásp, fitted out a fleet on the Caspian.<sup>2</sup> The Russians occupied Shirván, and the province of Gilan on the south-west corner of the Caspian<sup>3</sup>; and Peter made a treaty with Tahmásp II. in July 1722, by which he agreed to drive the Afghans out of Persia on condition that Darband (Derbend), Bákt, Gilan, Masandaran, and Astrábd were ceded to Russia in perpetuity. These were all the richest and most important northern provinces of Persia.

Meanwhile the cruel invader was deluging Ispahan with the blood of its citizens. Dreading rebellion, in 1723 he invited three hundred of the principal Persian nobility to a banquet and massacred them. To prevent their children rising up in vengeance they were all murdered also. Then he proceeded to slaughter vast numbers of the citizens of Ispahan, until the place was nearly depopulated. Not content with this, in February 1726 he assembled all the captives of the royal family, except the sháh, in the courtyard of the palace, and caused them all to be murdered, commanding the massacre with his own hand. The wretched Husáin,

<sup>1</sup> We have an account of the Afghan invasion and sack of Ispahan from an eye-witness, Father Krasinski, procurator of the Jesuits at that place, whose interesting work was translated into English in the last century.

<sup>2</sup> In 1721 Sultan Husáin sent an embassy to the Russians, seeking aid against the Afghans. In May 1722 a flotilla descended the Volga commanded by Czar Peter, and on 19th July the Russian flag first waved over the Caspian. Gilan was occupied by 6000 men under General Matuchkin.

<sup>3</sup> The Russians remained in Gilan until 1784, when they were obliged to evacuate it, owing to the unhealthiness of the climate.

frantic with grief, rushed to this scene of horror, and was himself wounded in endeavouring vainly to save his infant son, only five years of age. All the males of the royal family, except Husáin himself, Tahmásp, and two children, are said to have perished. At length the inhuman miscreant Mahmúd died, at the early age of twenty-seven, on 22d April 1725. With scarcely any neck, he had round shoulders, a broad face with a flat nose, a thin beard, and squinting eyes, which were generally downcast.

Mahmúd was succeeded in his usurpation by his first cousin Ashraf, the son of Mir 'Abdallah. He was a bravo but cruel Afghan. He gave the dethroned sháh a handsome allowance, and strove, by a mild policy, to acquire popularity. In 1727, after a short war, he signed a treaty with the Turks, acknowledging the sultan as chief of the Moslems. But the fortunate star of Tahmásp II. was now beginning to rise, and the days of Afghan usurpation were numbered. He had collected a small army in Masandaran, and was supported by Fath 'Alí Khán, the powerful chief of the Kájir tribe. In 1727 the fugitive sháh was joined by Nádír Kúh, a robber chief, who was already famous for his undaunted valor, and who was destined to become the mightiest conqueror of the age. He murdered Fath 'Alí, and, having easily appeared the sháh, received the command of the royal army. In 1729 Ashraf became alarmed at these formidable preparations in the north, and led an Afghan army into Khurásan, where he was defeated by Nádír at Damghan, and forced to retreat. The Persian general followed close in his rear, and again entirely defeated him outside Ispahan in November of the same year. The Afghans fled through the town; and Ashraf, murdering the poor old sháh Husáin on his way, hurried with the wreck of his army towards Shiráz. On 18th November the victorious Nádír entered Ispahan, and was soon followed by his master, the young sháh Tahmásp II., who burst into tears when he beheld the ruined and defaced walls of the palace of his ancestors. His mother, who had escaped the numerous massacres by disguising herself as a slave, and performing the most degrading offices, now came forth and threw herself into his arms. Nádír did not give his enemies time to recover from their defeat. He followed them up, and again utterly routed them in January 1730. Ashraf tried to escape to Kandahar almost alone, but was murdered by a party of Balúch robbers; and thus, by the genius of Nádír, his native land was delivered from the terrible Afghan invaders.

The ambition of Nádír, however, was far greater than his loyalty. On the pretext of incapacity he dethroned Tahmásp II. in 1732, and sent him a prisoner into Khurásan, where he was murdered some years afterwards by Nádír's son, while the conqueror was absent on his Indian expedition. For a short time the rily usurper placed Tahmásp's son on the throne, a little child, with the title of 'Abbás III., while he contented himself with the office of regent. Poor little 'Abbás died at a very convenient time, in the year 1736, and Nádír then threw off the mask. He was proclaimed sháh of Persia by a vast assemblage on the plain of Moghan.

By the fall of the Safawi dynasty Persia lost, as it were, her race of national monarchs, considered not only in respect of origin and birthplace but in essence and in spirit. The Persians have never been governed by more truly representative kings than Isma'íl, Tahmásp, and 'Abbás; and, whatever their faults and failings, they were Persian and peculiar to Persians. Thoroughly to realize this truth we must endeavour for a moment to change our own for the Oriental standpoint, and accept even the murders and excesses committed as an outcome of the age, place, and circumstances, and as natural as are the freaks of unrestrained childhood. Regarded in a sober English spirit, the reign of the great 'Abbás is rendered mythical by crime. No sovereign could be great in the estimation of civilized Europe who acted as he did on certain occasions. No victory or healthy legislation could compensate for moments of madness, which, under Western orthodoxy, must mar a whole career. But something liberal in the philosophy of their progenitors threw an attractiveness over the earlier Safawi kings which was wanting in those who came after them. In course of time the old philosophical element disappeared; and one of Sháh Husáin's immediate predecessors not only disavowed all sympathy with Súfism but threatened to crush it where detected. The fact is that, two centuries after Sháh Isma'íl's accession to the throne, the Safawi race of kings was effete; and it became necessary to make room for a more vigorous if not a more lasting rule. Nádír was the strong man for

the hour and occasion. He has been designated a "robber chief"; but his antecedents, like those of many others who have filled the position, have redeeming points of melodramatic interest. He was driven to this mode of life by injustice, and raised to consideration above ordinary banditti by ability as much as by physical force. It was the repute he had thus obtained which caused Saifu 'd-Din Beg, a general of Sháh Tahmásp, and chief of a tribe, to unite his fortunes to Nádír's, and so enable him to rise on the ladder of his ambition. That Nádír misused his advantages by acts of treachery is not to be denied. Such was, unfortunately, one of the visible roads to success in those barbarous times.

A map attached to Kruinski's volumes (see Plate VIII.) illustrates the extent of Persian territory in 1728, or one year before Ashraf was finally defeated by Nádír, and some eight years prior to the date on which Nádír was himself proclaimed king. It shows, during the reign of the Safawí kings, Tiflis, Erivan, Khoi, and Baghdád to have been within the limits of Persia on the west, and in like manner Balkh and Kandahar to have been included within the eastern border. There is, however, also shown, as a result of the Afghan intrusion and the impotency of the later Safawí kings, a long broad strip of country to the west, including Tabris and Hamadan, marked "conquests of the Turks," and the whole west shore of the Caspian from Astrakan to Mazanderan marked "conquests of the czar of Muscovy"; Makran, written Mecran, is designated "a warlike independent nation." If further allowance be made for the district held by the Afghan invaders as part of their own country, it will be seen how greatly the extent of Persia proper was reduced, and what a work Nádír had before him to restore the kingdom to its former proportions.

But the former proportions had been partly reverted to, and would doubtless have been in some respects exceeded, both in Afghanistan and the Ottoman dominions and on the shores of the Caspian, by the action of this indefatigable general, had not his sovereign master, Tahmásp II., acting on his own account, been led into a premature treaty with the Turks. Nádír's anger and indignation had been great at this weak proceeding; indeed, he had made it the ostensible cause of the sháh's deposition. He had addressed letters to all the military chiefs of the country, calling upon them for support; he had sent an envoy to Constantinople insisting upon the sultan's restoration of the Persian provinces still in his possession—that is, Georgia and part of Adarbáijan,—and he had threatened Baghdád with assault. As regent, he had failed twice in taking the city of the kalifs, but on the second occasion he had defeated and killed its gallant defender, Topal 'Othman, and he had succeeded in regaining Tiflis, Kara, and Erivan.<sup>1</sup>

Russia and Turkey, naturally hostile to one another, had taken occasion of the weakness of Persia to forget their mutual quarrels and unite to plunder the tottering kingdom of the Safawí kings. A partition treaty had been signed between these two powers in 1723, by which the czar was to take Astrábád, Mazandaran, Gilan, part of Shirwan and Daghistán, while the acquisitions of the Porte were to be traced out by a line drawn from the junction of the Arrás and Kur rivers, and passing along by Ardabil, Tabriz, and Hamadan, and thence to Karman-sháh. Tahmásp was to retain the rest of his paternal kingdom on condition of his recognizing the treaty. The ingenious diplomacy of Russia in this transaction was manifested in the fact that she had already acquired the greater part of the territory allotted to her, while Turkey had to obtain her share by further conquest. But the combination to despoil a feeble neighbour was outwitted

by the energy of a military commander of remarkable type.

*Nádír Sháh.*—Nádír, it has been said, was proclaimed sháh in the plains of Moghan in 1736. Mirza Mahdí relates how this event was brought about by his address to the assembled nobles and officers on the morning of the 'Náu-rus,' or Persian New-Year's Day, the response to that appeal being the offer of the crown. In the spirit of the third English Richard, he refused to accept the high dignity, but eventually suffered his petitioners, on certain conditions, to "buckle fortune on his back." The conditions were that the crown should be hereditary in his family, that the claim of the Safawís was to be held for ever extinct, and that measures should be taken to bring the Sháh's to accept uniformity of worship with the Sunnis. The mulla báshi (or high priest) objecting to the last, Nádír ordered him to be strangled, a command which was carried out on the spot. On the day following, the agreement having been ratified between sovereign and people, he was proclaimed emperor of Persia. At Kasvín the ceremony of inauguration took place. Having girt on the royal scimitar and put the crown on his head, he took the accustomed oath. The edict expressing the royal will on the religious question is dated in June, but the date of coronation is uncertain. From Kasvín Nádír moved to Isfahan, where he organized an army for a proposed expedition against Kandahar, then in the possession of a brother of Mahmúdd, the conqueror of Sháh Husáin. But before setting out for Afghanistan he took measures to secure the internal quiet of Persia, attacking and seizing in his stronghold the chief of the marauding Bakhtiáris, whom he put to death, retaining many of his men for service as soldiers. With an army of 80,000 men he marched through Khurásán and Sístán to Kandahar, which city he blockaded ineffectually for a year; but it finally capitulated on the loss of the citadel. Balkh fell to Ríza Kálí, the king's son, who, moreover, crossed the Oxus and defeated the Uzbeks in battle. Besides tracing out the lines of Nadirabad, a town since merged in modern Kandahar, Nádír had taken advantage of the time available and of opportunities presented to enlist a large number of men from the Abdáli and Ghilzái tribes. It is said that as many as 16,000 were at his disposal. His rejection of the Shí'án tenets as a state religion seems to have propitiated the Sunni Afghans, and it is not to be otherwise wondered at that a man of his warlike habits should have succeeded in attaching many of the rough mountaineers to his person. Such a force, in addition to his own army, rendered him a truly formidable foe, and the prospect which now opened out before him must have fired his heart and the hearts of his warriors with restless exultation.

He had sent an ambassador into Hindustán requesting the Mughal emperor to order the surrender of certain unruly Afghans who had taken refuge within Indian territory, but no satisfactory reply was given, and obstacles were thrown in the way of the return of the embassy. The Persian monarch, not sorry perhaps to find a plausible pretext for encroachment in a quarter so full of promise to booty-seeking soldiers, pursued some of the fugitives through Ghasni to Kabul, which city was then under the immediate control of Nágr Khán, governor of eastern Afghanistan, for Muhammad Sháh of Dehli. This functionary, alarmed at the near approach of the Persians, fled to Pesháwar. Kabul had long been considered not only an integral part but also one of the main gates of the Indian empire; notwithstanding a stout resistance on the part of its commandant, Shír or Shírzah Khán, the place was stormed and carried (1738) by Nádír, who, after slaughtering the greater part of the garrison, took possession of it and moved on to the eastward. Mirza Mahdí relates

<sup>1</sup> Malcoln.

that from the Kabul plain he addressed a new remonstrance to the Delhi court, but that his envoy was arrested and killed, and his escort compelled to return by the governor of Jalálabád. The same authority notes the occupation of the latter place by Persian troops and the march thither from Gandamak. There are some doubts as to the exact route now taken, but it was probably through the Khaibar (Khyber) Pass that he passed into the Pesháwar plain, for it was there that he first defeated the imperial forces.

The invasion of India had now fairly commenced, and its successful progress and consummation were mere questions of time. It will not do to cite a triumphal march of an irresistible horde in example of what may still be achieved by an inroad upon modern Hindustan. The prestige of this Eastern Napoleon was immense. It had not only reached but had been very keenly felt at Delhi before the conquering army had arrived. There was no actual religious war; all sectarian distinction had been disavowed; the contest was between vigorous Muhammadans and effete Muhammadans. Nádir had not, like Cæsar, come, and seen, and conquered. His way had been prepared by circumstances, and as he progressed from day to day his army of invaders increased. There must have been larger accessions by voluntary recruits than losses by death or desertion. The victory on the plain of Karnál, whether accomplished by sheer fighting or the intervention of treachery, was the natural outcome of the previous situation; it was the shifting of the scene as anticipated and prepared, and the submission of the emperor followed as a matter of course. But the coming and going of Nádir are studies quite as interesting and instructive as the coming and going of Alexander, and belong to comparatively recent days.

Delhi must have experienced a sense of relief at the departure of its conqueror, whose residence there had been rendered painfully memorable by carnage and riot. The marriage of his son to the grand-daughter of Aurangzib and the formal restoration of the crown to the dethroned emperor, both prominent parts of the first pageant, were doubtless politic, and his parting counsels to the wretched Muhammad Sháh were, it is probable, good and appropriate; but the descendant of Bábar could not easily forget how humiliating a chapter in history would remain to be written against him. The return march of Nádir to Persia is not recorded with precision. On the 5th May 1739 he left the gardens of Shalimar, north of Delhi, to proceed, by Lahore and Pesháwar, through the passes to Kabul. Thence he seems to have returned to Kandahar and, either in person or by his lieutenants, to have recrossed the Indus into Sind. But the subjection of Núr Muhammad, the Kalhora chief then ruling in that province, would hardly have been a sufficient inducement to bring back the great Nádir Kúli so far as 'Umarkot; and in May 1740—just one year after his departure from Delhi—he was in Herat displaying the imperial throne and other costly trophies to the gaze of the admiring inhabitants. Sind was certainly included in the cession to him by Muhammad Sháh of "all the territories westward of the river Attok," but only that portion of it, such as Thattah (Tatta), situated on the right bank of the Indus.

From Herat he moved upon Balkh and Búkhara, and at a short distance from the latter city received the submission of Abú'l-Fáiz Khán, the Uzbek ruler, whom he restored to his throne on condition that the Oxus should be the acknowledged boundary between the two empires. The khán of Khwárizm was his next opponent; and, as this chief rejected conciliation, and had given serious cause of offence by repeated depredations in Persian territory, he was made prisoner and doomed, with some of his officers, to execution. Nádir then visited the strong

fortress of Kelat, a place which now bears his name and to which he was greatly attached as the scene of his boyish exploits, and Mashhad, which he constituted the capital of his empire. Here he spent three months in festivity; and if extension of dominion be a cause for gratulation he could well justify the demonstration, for he had extended his boundary on the east to the Indus, and to the Oxus on the north.

On the south he was restricted by the Arabian Ocean and Persian Gulf; but the west remained open to his further progress. He had in the first place to revenge the death of his brother Ibráhm Khán, slain by the Leeshians; and a campaign against the Turks might follow in due course. The first movement was unsuccessful, and indirectly attended with disastrous consequences. Nádir, when hastening to the support of some Afghan levies who were doing good service, was fired at and wounded by a stray assailant; suspecting his son, Riza Kúli, of complicity, he commanded the unfortunate prince to be seized and deprived of sight. From that time the heroism of the monarch appeared to die out. He became morose, tyrannical, and suspicious. An easy victory over the Turks gave him but little additional glory; and he readily concluded a peace with the sultan which brought but insignificant gain to Persia.<sup>1</sup> Another battle won from the Ottoman troops near Diarbekir by Násr Ulláh Mirza, the young prince who had married a princess of Delhi, left matters much the same as before. "It was agreed that prisoners on both sides should be released, that Persian pilgrims going to the holy cities of Mecca and Medina should be protected, and that the whole of the provinces of Irak and Adarbajjan should remain with Persia, except an inconsiderable territory that had belonged to the Turkish Government in the time of Sháh Lamail, the first of the Suffavi kings."<sup>2</sup>

The last years of Nádir's life were full of internal trouble. On the part of the sovereign, murders and executions; on that of his subjects, revolt and conspiracy,—these were the ordinary topics of common interest throughout the country. Such a state of things could not last, and certain proscribed persons plotted together for the destruction of a sovereign who had now become a half-demented tyrant. He was despatched by Salah Bey, captain of his guards, to whom, with three others, was committed the work of his assassination (1747). He was some sixty years of age, and had reigned eleven years. About the time of setting out on his Indian expedition he was described as a most comely man, upwards of 6 feet high, well-proportioned, of robust make and constitution; inclined to be fat, but prevented by the fatigue he underwent; with fine, large black eyes and eyebrows; of sanguine complexion, made more manly by the influence of sun and weather; a loud, strong voice; a moderate wine-drinker; fond of simple diet, such as piláos and plain dishes, but often neglectful of meals altogether, and satisfied, if occasion required, with parched peas and water, always to be procured.<sup>3</sup>

Malcolm winds up a long account of his idiosyncrasies with the following.

"The character of this wonderful man is, perhaps, exhibited in its truest colours in those impressions which the memory of his actions has left upon the minds of his countrymen. They speak of him as a deliverer and a destroyer; but while they expatiate with pride upon his deeds of glory, they dwell with more pity than horror upon the cruel enormities which disgraced the latter years of his reign; and neither his crimes, nor the attempt he made to abolish their religion, have subdued their gratitude and veneration for the hero, who revived in the breasts of his degraded countrymen

<sup>1</sup> Professor Creasy says the war broke out in 1743, but was terminated in 1746 by a treaty which made little change in the old arrangements fixed under Murád IV.

<sup>2</sup> Malcolm.

<sup>3</sup> Fraser's *History of Nádir Sháh* (1742).



a sense of their former fame, and restored Persia to her independence as a nation."

During the reign of Nádír an attempt was made to establish a British Caspian trade with Persia. The names of Jonas Hanway and John Elton were honourably connected with this undertaking; and the former has left most valuable records of the time and country.

*From Nádír Sháh to the Kajár Dynasty.*—After the death of Nádír Sháh something like anarchy prevailed for thirteen years in the greater part of Persia as it existed under Sháh 'Abbás. No sooner had the crime become known than Ahmad Khán, chief of the Abdáli Afghans, marched off rapidly with his men to Kandahar and took possession of that city and a certain amount of treasure. The chief of the Bakhtiáris, Rashid, also with treasure, fled to the mountains, from which his people had been drawn prior to the Indian expedition; and the conspirators who had done the murderous deed invited 'Alí, a nephew of the deceased monarch, to ascend the vacant throne. By the action of Ahmad Abdáli, Afghanistan was at once lost to the Persian crown, for this leader was strong enough to found an independent kingdom. The Bakhtiári encouraged his brother, 'Alí Mardan, to compete for the succession to Nádír; and the nominee of the disaffected party hastened from Sístan to Mashhad to take advantage of his nomination. The prince was welcomed by his subjects; he told them that the murder of his uncle was due to his own instigation, and, in order to conciliate them towards him in a practical manner, remitted the revenues of the current year and all extraordinary taxes for the two years following.

Taking the title of 'Adíl Sháh, or the "just" king, he commenced his reign by putting to death the two princes Ríza Kúli and Násr Ulláh, as well as all relatives who could, in his estimation, be considered his competitors, with the exception of Sháh Rukh, son of Ríza Kúli, whom he spared in case a lineal descendant of Nádír should at any time be required by the people. His calculations proved, however, no wiser than beneficent. He had not removed all dangerous members of the royal house, nor had he gauged the temper of the times or people. 'Adíl Sháh was soon dethroned by his own brother, Ibráhm, and he in his turn was defeated by the adherents of Sháh Rukh, who made their leader king.

This young prince had a better and more legitimate title than that of the grandson of Nádír, whose usurpation was too recent an occurrence to have eradicated and supplanted a comparatively ancient dynasty of national kings. He was also grandson, on the mother's side, of the Šafawí Sháh Husáin. Amiable, generous, and liberal-minded, and of prepossessing exterior, he proved to be a popular prince. But his friends and supporters had done well to have left him in honourable obscurity; for he was neither of an age nor character to rule over a people led hither and thither by turbulent and disaffected chiefs, ever divided by the conflicting interests of personal ambition. No sooner had his claim to succession been admitted than his authority was subverted. Sa'íd Muhammad, son of Mírza Dáúd, a chief mulla at Mashhad, whose mother was the reputed daughter of Suláiman, collecting a body of men, and assuming the name of his maternal grandfather, declared himself king, and imprisoned and blinded Sháh Rukh. Yúsuf 'Alí, the general commanding the royal troops, came to the rescue, defeated and slew Suláiman, and replaced his master on the throne, reserving to himself the protectorship or regency. A new combination of chiefs, of which Jí'afir the Kurd and Mir 'Alam the Arabian are the principal names handed down, brought about the death of Yúsuf 'Alí and the second imprisonment of Sháh Rukh. These events were followed by a quarrel terminating in the supremacy of the Arab. At this junc-

ture Ahmad Sháh Abdáli reappeared in Persian Khurásan from Herat; he attacked and took possession of Mashhad, slew Mir 'Alam, and, pledging the local chiefs to support the blinded prince in retaining the kingdom of his grandfather, he returned to Afghanistan. But thenceforward this unfortunate young man was a mere shadow of royalty, and his purely local power and prestige had no further influence whatever on Persia as a country.

The land was partitioned among several distinguished persons, who had of old been biding their opportunities, or were born of the occasion. Foremost among these was Muhammad Hasan Khán, hereditary chief of those Kajárs who were established in the south-east corner of the Caspian. His father, Fath 'Alí Khán, after sheltering Sháh Tahmásp II. at his home in Astrábád, and long acting as one of his most loyal supporters, had been put to death by Nádír, who had appointed a successor to his chiefdom from the "Yukári" or "upper" Kajárs, instead of from his own, the "Ashgha," or "lower."<sup>1</sup> Muhammad, with his brother, had fled to the Túrkmans, by whose aid he had attempted the recovery of Astrábád, but had not succeeded in regaining a permanent footing there until Nádír had been removed. On the murder of the tyrant he had raised the standard of independence, successfully resisted Ahmad Sháh and his Afghans, who sought to check his progress in the interests of Sháh Rukh, and eventually brought under his own sway the valuable provinces of Gílan, Mazandaran, and Astrábád,<sup>2</sup>—quite a little kingdom in itself. In the large important province of Adarbaijan, Azad Khán, one of Nádír's generals, had established a separate government; and 'Alí Mardan, brother of the Bakhtiári chief, took forcible possession of Ispahan, empowering Sháh Rukh's governor, Abú 'l-Fath Khán, to act for the new master instead of the old.

Had 'Alí Mardan declared himself an independent ruler he would have been by far the most important of the three persons named. But such usurpation at the old Šafawí capital would have been too flagrant an act for general assent; so he put forward Isma'íl, a nephew of Sháh Husáin, as the representative of sovereignty, and himself as one of his two ministers,—the other being Karím Khán, a young chief of the Zend Kurds. Sháh Isma'íl, it need scarcely be said, was a mere nominal king, and possessed no real authority; but the ministers were strong men in their way, and the Zend especially promised to be useful in his generation, for he had many high and excellent qualities. After a time 'Alí Mardan was assassinated, and Karím Khán became the sole living power at Ispahan. The story of the period is thus told by Watson.

"The three rivals, Karím, Azad, and Muhammad Hasan, proceeded to settle, by means of the sword, the question as to which of them was to be the sole master of Persia. A three-sided war then ensued, in the course of which each of the combatants in turn seemed at one time sure to be the final conqueror. Karím, when he had arranged matters at Ispahan, marched to the borders of Mazandaran, where the governor of that province was ready to meet him. After a closely-contested battle victory remained with Muhammad Hasan; who, however, was unable to follow up the foe, as he had to return in order to encounter Azad. That leader had invaded Gilan, but, on the news reaching him of the victory which the governor of Mazandaran had gained, he thought it prudent to retrace his steps to Sultaniyah. Karím reunited his shattered forces at Tehrán, and retired to Ispahan to prepare for a second campaign. When he again took the field it was not to measure himself once more with the Kajár chief, but to put down the pretensions of Azad. The wary Afghan, however, shut himself up in Kasvin, a position from which he was enabled to inflict much injury on the army of Karím, while his own troops remained unharmed

<sup>1</sup> There were three branches of the Kajár tribe, *i. e.*, the Sulddís, Tíngkút, and Jaláiyar. The last, according to Watson, became settled in Iran and Turan, and seem at first to have given their name to all the tribe.

<sup>2</sup> Watson. Malcolm says that Gílan was under one of its own chiefs, Hiddáyat Khán.

behind the walls of the town. Karim retired a second time to Ispahan, and in the following spring advanced again to meet Azad. A pitched battle took place between them, in which the army of Karim was defeated. He retreated to the capital, closely pressed by the foe. Thence he continued his way to Shiráz, but Azad was still upon his traces. He then threw himself upon the mercy of the Arabs of the Garmair, or hot country, near the Persian Gulf, to whom the name of the Afghans was hateful, and who rose in a body to turn upon Azad. Karim, by their aid, once more repaired his losses and advanced on Ispahan, while Muhammad Hasan with fifty thousand men was coming from the opposite direction, ready to encounter either the Afghan or the Zend. The Afghan did not await his coming, but retired to his government of Tabriz.

"The Zend issued from Ispahan, and was a second time defeated in a pitched battle by the Kajar. Karim took refuge behind the walls of Shiráz, and all the efforts of the enemy to dislodge him were ineffectual. Muhammad Hasan Khan in the following year turned his attention to Adarbajjan. Azad was no longer in a position to oppose him in the field, and he in turn became master of every place of importance in the province, while Azad had to seek assistance in vain—from the Pasha of Baghdad, and then from his former enemy, the Tsar of Georgia. Next year the conquering Kajar returned to Shiráz to make an end of the only rival who now stood in his way. On his side were 80,000 men, commanded by a general who had twice defeated the Zend chief on an equal field. Karim was still obliged to take shelter in Shiráz, and to employ artifice in order to supply the place of the force in which he was deficient. Nor were his efforts in this respect unattended with success: seduced by his gold, many of the troops of the Kajar began to desert their banners. In the meantime the neighbourhood of Shiráz was laid waste, so as to destroy the source from which Muhammad Hasan drew his provisions; by degrees his army vanished, and he had finally to retreat with rapidity to Ispahan with the few men that remained to him. Finding his position there to be untenable, he retreated still further to the country of his own tribe, while his rival advanced to Ispahan, where he received the submission of nearly all the chief cities of Persia. The ablest of Karim's officers, Shaikh 'Ali, was sent in pursuit of the Kajar chief. The fidelity of the commander to whom that chieftain had confided the care of the pass leading into Mazandarán, was corrupted; and, as no further retreat was open to him, he found himself under the necessity of fighting. The combat which ensued resulted in his complete defeat, although he presented to his followers an example of the most determined valour. While attempting to effect his escape he was recognized by the chief of the other branch of the Kajar tribe, who had deserted his cause, and who had a blood-feud with him, in pursuance of which he now put him to death.

"For nineteen years after this event Karim Khan ruled with the title of wakíl, or regent, over the whole of Persia, excepting the province of Khurasán. He made Shiráz the seat of his government, and by means of his brothers put down every attempt which was made to subvert his authority. The rule of the great Zend chief was just and mild, and he is on the whole, considering his education and the circumstances under which he was placed, one of the most faultless characters to be met with in Persian history."

Karim Khan died at his capital and favourite residence in 1779 in the twentieth year of his reign, and, it is said, in the eightieth of his age. He built the great bazaar of Shiráz, otherwise embellishing and improving the city, had a tomb constructed over the remains of Háfiz, and repaired the "túrbat" at the grave of Sa'dí, outside the walls. He encouraged commerce and agriculture, gave much attention to the state of affairs along the shores of the Persian Gulf, and carefully studied the welfare of the Armenian community settled in his dominions. In his time the British factory was removed from Gombroon to Bushahr (Bushire). It would be pleasant, if space allowed, to repeat the anecdotes creditable to his memory; for it is unusual to find so worthy a figure in Oriental annals.

On Karim's death a new period of anarchy supervened. His brother, Zaki, a cruel and vindictive chief, and without a pardoned rebel—for, when governor of Ispahan, he had revolted against Karim—assumed the government. At the same time he proclaimed Abú 'l-Fath Khán, second son of the deceased monarch, and his brother Muhammad 'Ali, joint-successors to the throne. The seizure of the citadel at Shiráz by the adherents of the former, among whom were the more influential of the Zends, may have induced him to

adopt this measure as one of prudent conciliation. But the garrison held out, and, to avoid a protracted siege, he had recourse to treachery. The suspicious nobles were solemnly adjured to trust themselves to his keeping, under promise of forgiveness. They believed his professions, tendered their submission, and were cruelly butchered. Zaki did not long enjoy the fruits of his perfidious dealing. The death of Karim Khán had raised two formidable adversaries to mar his peace, who could not fail to bring on a dénouement of some kind seriously affecting his interests.

Agha Muhammad, son of Muhammad Hasan, the Kajar chief of Astrábad, a prisoner at large in Shiráz, was in the environs of that city awaiting intelligence of the old king's decease, and, hearing it, instantly escaped to Mazandaran, there to gather his tribesmen together and put himself in a condition to compete for the crown of Persia. Taken prisoner by Nádir and barbarously mutilated by 'Adil Sháh, he had afterwards found means to rejoin his people, but had surrendered himself to Karim Khán when his father was killed in battle. On the other hand, Sádik, brother to Zaki, who had won considerable and deserved repute by the capture of Basrah from the Turkish governor, abandoned his hold of the conquered town on hearing of the death of Karim, and appeared with his army before Shiráz. To provide against the intended action of the first, Zaki detached his nephew, 'Ali Murád, at the head of his best troops to proceed with all speed to the north; and, as to the second, the seizure of such families of Sádik's followers as were then within the walls of the town, and other violent measures, struck such dismay into the hearts of the besieging soldiers that they dispersed and abandoned their leader to his fate. From Karman, however, where he found an asylum, the latter addressed an urgent appeal for assistance to 'Ali Murád. This chief, encamped at Tehran when the communication reached him, submitted the matter to his men, who decided against Zaki, but put forward their own captain as the only master they would acknowledge. 'Ali Murád, leaving the pursuit of Agha Muhammad, then returned to Ispahan, where he was received with satisfaction, on the declaration that his one object was to restore to his lawful inheritance the eldest son of Karim Khán, whom Zaki had set aside in favour of a younger brother. The sequel is full of dramatic interest. Zaki, enraged at his nephew's desertion, marched out of Shiráz towards Ispahan. On his way he came to the town of Yazdikhaat,—a singular place, steep and rugged, something like a section, or three upper stories, of the old town of Edinburgh set upon a natural foundation of crumbling stone. It comes upon the traveller as an abrupt elevation in a dreary vale, and the surrounding scenery savours of the weird and romantic. Here he demanded a sum of money from the inhabitants, claiming it as part of secreted revenue; the demand was refused, and eighteen of the head men were thrown down the precipice beneath his window; a "sáiyid," or holy man, was the next victim, and his wife and daughter were to be given over to the soldiery, when a suddenly-formed conspiracy took effect, and Zaki's own life was taken in retribution for his guilt (1779).

When intelligence of these events reached Karman, Sádik Khán hastened to Shiráz, proclaimed himself king in place of Abú 'l-Fath Khán, whom he declared incompetent to reign owing to dissipation and indolence, and put out the eyes of the young prince. He despatched his son Jí'áfr to assume the government of Ispahan, and watch the movements of 'Ali Murád, who appears to have been then absent from that city; and he gave a younger son, 'Ali Naki, command of an army in the field. A campaign ensued with success from time to time on either side, but ending in the capture of Shiráz and assumption of sovereignty by 'Ali Murád, who caused Sádik Khán to be put to death.

From this period up to the accession of Agha Muhammad Khán the summarized history of Markham will supply the principal facts required.

'Alí Murád reigned over Persia until 1785, and carried on a successful war with Agha Muhammad in Mazandaran, defeating him in several engagements, and occupying Tehran and Sari. He died on his way from the former place to Ispahan, and was succeeded by Ji'áfir, son of Sádk, who reigned at Shíráz, assisted in the government by an able but unprincipled "kalántar," or head magistrate, named Hajji Ibráhím. This ruler was poisoned by the agency of conspirators, one of whom, Sáiyid Murád, succeeded to the throne. Hajji Ibráhím, however, contriving to maintain the loyalty of the citizens towards the Zend reigning family, the usurper was killed, and Lutf 'Alí Khán, son of Ji'áfir, proclaimed king. He had hastened to Shíráz on hearing of his father's death and received a warm welcome from the inhabitants. Hajji Ibráhím became his chief adviser, and a new minister was found for him in Mirza Husáin Shíráz. At the time of his accession Lutf 'Alí Khán was only in his twentieth year, very handsome, tall, graceful, and an excellent horseman. To his fearless bravery and indomitable perseverance he united the nobler virtues of generosity and magnanimity. He formed many enduring friendships; and, though false-hearted traitors forsook him in the hour of adversity, others loyally stood by him to the last. While differing widely in character, he was a worthy successor of Karím Khán, the great founder of the Zend dynasty. Lutf 'Alí Khán had not been many months on the throne when Agha Muhammad advanced to attack him, and invested the city of Shíráz, but retreated soon afterwards to Tehran, which he had made the capital of his dominions. The young king then enjoyed a short period of peace. Afterwards, in the year 1790, he collected his forces and marched against the Kajárs, in the direction of Ispahan. But Hajji Ibráhím had been intriguing against his kind young sovereign, to whose family he owed everything, not only with his officers and soldiers but also with Agha Muhammad, the chief of the Kajárs, and arch-enemy of the Zends. Lutf 'Alí Khán was suddenly deserted by the whole of his army, except seventy faithful followers; and when he retreated to Shíráz he found the gates closed against him by Hajji Ibráhím, who held the city for the Kajár chief. Thence falling back upon Bushahr, he found that the shaikh of that town had also betrayed him. Surrounded by treason on every side, basely deserted alike by his dearest friends and by those who had been raised from the dust by his family, yet, still undaunted by the black clouds that gathered round him, with his little band he boldly attacked and routed the chief of Bushahr and blockaded the city of Shíráz. His unconquerable valour gained him many followers, and he defeated an army sent against him by the Kajárs in 1792.

Agha Muhammad then advanced in person against his gallant young rival. He encamped with an army of 80,000 men on the plain of Mardaht, near Shíráz. Lutf 'Alí Khán, in the dead of night, suddenly attacked the camp of his enemy with only a few hundred followers. The Kajárs were completely routed and thrown into confusion; but Agha Muhammad, with extraordinary presence of mind, remained in his tent, and at the first appearance of dawn his "muazzin," or public crier, was ordered to call the faithful to morning prayer as usual. Astonished at this, the few Zend cavaliers, thinking that the whole army of Kajárs had returned, fled with precipitation, leaving the field in possession of Agha Muhammad. The successful Kajár then entered Shíráz, and promoted the traitor Hajji Ibráhím to be his wazír. Lutf 'Alí Khán took refuge with the hospitable chief of Tabas in the heart of Khurásan, where he succeeded in collecting a few followers; but, advancing into Fárs, he was again defeated, and forced to take refuge at Kandahar.

In 1794, however, the undaunted prince once more crossed the Persian frontier, determined to make a last effort, and either regain his throne or die in the attempt. He occupied the city of Karman, then a flourishing commercial town, half-way between the Persian Gulf and the province of Khurásan. It had a very fine bazaar and was well fortified. Agha Muhammad besieged it with a large army in 1795, and, after a stout resistance, the gates were opened through treachery. For three hours the gallant young warrior fought in the streets with determined valour, but in vain. When he saw that all hope was gone he spurred his faithful horse against the ranks of the enemy and, with only three followers, fought his way through the Kajár host and escaped to Bam-Narmashir, the most eastern district of the province of Karman on the borders of Sístan.

Furious at the escape of his rival, the savage conqueror ordered a general massacre; 20,000 women and children were sold into slavery, and 70,000 eyes of the inhabitants of Karman were brought to Agha Muhammad on a platter. The monster counted them with the point of his dagger, then, turning to his minister, he exclaimed, "If one had been wanting I would have made up the

number with your own eyes." Karman has never fully recovered from the effects of this fiend's atrocities.

Lutf 'Alí Khán took refuge in the town of Bam; but the governor of Narmashír, anxious to propitiate the conqueror, basely surrounded him as he was mounting his faithful horse Kúran to seek a more secure asylum. The young prince fought bravely; but, being badly wounded and overpowered by numbers, he was secured and sent to the camp of the Kajár chief. The spot where he was seized at Bam, when mounting his horse, was marked by a pyramid, formed, by order of his revengeful enemy, of the skulls of the most faithful of his adherents. The most hideous indignities and atrocities were committed upon his person by the cruel Kajár, in whose breast not one spark of generous or humane feeling had ever found a place. Finally, the last reigning prince of the house of Zend was sent to Tehran and murdered, when only in his twenty-sixth year. Every member of his family and every friend was ordered to be massacred by Agha Muhammad; and the successful but guilty miscreant thus founded the dynasty of the Kajárs at the price of all the best and noblest blood of Iran.

The Zend is said to be a branch of the Lak tribe, dating from the time of the Kaianian kings, and claims to have been charged with the care of the *Zend-Avesta* by Zoroaster himself.<sup>2</sup> The tree attached to Markham's chapter on the dynasty contains the names of eight members of the family only, i.e., four brothers, one of whom had a son, grandson, and great-grandson, and one a son. Four of the eight were murdered, one was blinded, and one cruelly mutilated. In one case a brother murdered a brother, in another an uncle blinded his nephew.

*Kajár Dynasty.*—Agha Muhammad was undoubtedly one of the most cruel and vindictive despots that ever disgraced a throne. But he was not without care for the honour of his empire in the eyes of Europe and the outer world, and his early career in Mazandaran gave him a deeply-rooted mistrust of Russia, with the officers of which power he was in constant contact. The following story, told by Forster,<sup>3</sup> and varied by a later writer, is characteristic. A party of Russians having obtained permission to build a "counting-house" at Ashraf, in the bay of that name, erected instead a fort with eighteen guns. Agha Muhammad, learning the particulars, visited the spot, expressed great pleasure at the work done, invited the officers to dine with him, imprisoned them, and only spared their lives when they had removed the whole of the cannon and razed the fort to the ground. As this occurrence must have taken place about 1782, when he was engaged in family feuds, and the sovereign power was vested in the hands of 'Alí Murád, it may be received as an illustration not only of his patriotism but of the independent action he was ever ready to exercise when opportunity offered.

Forster was travelling homeward by the southern shores of the Caspian in January 1784, and from him we gather many interesting details of the locality and period. He calls Agha Muhammad chief of Mazandaran, as also of Astrábád and "some districts situate in Khurásan," and describes his tribe, the Kajár, to be, like the Indian Rajput, usually devoted to the profession of arms. Whatever hold his father may have had on Gílan, it is certain that this province was not then in the son's possession, for his brother, Ji'áfir Kúli, governor of Balfrush (Balfróah), had made a recent incursion into it and driven Hidáiyat Khán, its ruler, from Rasht to Enzali, and Agha Muhammad was himself meditating another attack on the same quarter. The latter's palace was at Sari, then a small and partly fortified town, thickly inhabited, and with a plentifully-supplied market. As "the most powerful chief in Persia" since the death of Karím Khán, the Russians were seeking to put their yoke upon him, and he was naturally averse to the infliction. It is not clear, however, from the context

<sup>2</sup> Markham. Morier says of Karím Khán's family, "it was a low branch of an obscure tribe in Kurdistán."

<sup>3</sup> *Journey from Bengal to England* (1798), vol. ii. p. 201; see also Markham, pp. 841, 842.

<sup>1</sup> A five days' usurpation of Bekir Khán, governor of Ispahan, is not taken into account.

what Forster means when he writes that Agha Muhammad is "the only Persian chief bordering on the Caspian Sea whom the empire of Russia has yet made tributary, or rendered subservient to its policy."

As Agha Muhammad's power increased, his dislike and jealousy of the Muscovite assumed a more practical shape. His victory over Lutf 'Ali was immediately followed by an expedition into Georgia. After the death of Nádír the wálí or prime ruler of that country had looked around him for the safest and surest means of shaking off the offensive yoke of Persia; and in course of time an opportunity had offered of a promising kind. In 1783, when the strength of the Persian monarchy was concentrated upon Ispahan and Shíráz, the Georgian czar Heraclius entered into an agreement with the empress Catherine by which all connexion with the sháh was disavowed, and a quasi-vassalage to Russia substituted,—the said empire extending heregis of protection over her new ally. Agha Muhammad now demanded that Heraclius should return to his position of tributary and vassal to Persia, and, as his demand was rejected, prepared for war. Dividing an army of 60,000 men into three corps, he sent one of these into Daghistán, another was to attack Erivan, and with the third he himself laid siege to Shíshah in the province of Karabagh. The stubborn resistance offered at the last-named place caused him to leave there a small investing force only, and to move on with the remainder of his soldiers to join the *corps d'armée* at Erivan. Here, again, the difficulties presented caused him to repeat the same process and to effect a junction with his first corps at Ganja, the modern Elisabethopol. At this place he encountered the Georgian army under Heraclius, defeated it, and marched upon Tiflis, which he pillaged, massacring and enslaving<sup>1</sup> the inhabitants. Then he returned triumphant to Tehran, where (or at Ardabil on the way) he was publicly crowned sháh of Persia. Erivan surrendered, but Shíshah continued to hold out. These proceedings caused Russia to enter the field. Darband was taken possession of by Imhoff, Bákt and Shumakhi were occupied, and Gilan was threatened. The death of the empress, however, caused the issue of an order to retire, and Darband and Bákt remained the only trophies of the campaign.

In the meantime Agha Muhammad's attention had been called away to the east. Khurásán could hardly be called an integral part of the sháh's kingdom so long as it was under even the nominal rule of the blind grandson of Nádír. But the eastern division of the province and its outlying parts were actually in the hands of the Afghans, and Mashhad was not Persian in 1796 in the sense that Delhi was British at the outbreak of the Indian mutiny. Sháh Rukh held his position, such as it was, rather under Ahmad Sháh and his successors in Afghanistan than under any other sovereign power. Agha Muhammad determined to restore the whole province to Persia, and, after a brief residence in Tehran on his return from the Georgian expedition, he set out for Mashhad. It is important to note that on the occasion of his coronation he had girded on the sabre consecrated at the tomb of the founder of the Safawis,—thus openly pledging himself to support the Shí'ah faith.

But there had been continual dissatisfaction in the capital of Khurásán, and there had been constant inroads upon it from without, which the powerless royal puppet was unable to prevent. His popularity was real, but wholly wanting in political vigour. It never seemed to have effect outside the limited sphere of personal sympathy and regard. Owing to the frequent revolutions in the

holy city the generals of Thátr Sháh, king of the Afghans, had made three expeditions on Sháh Rukh's behalf. Mashhad had been taken and retaken as though he were not a resident in it, much less its *de jure* king. Moreover, his two sons Nádír Mirza and Wálí Ni'amat had been long waging, one with the other, a predatory war, and the former was practically in 1796 the actual ruler of the place. Three years before Timúr had died, and his third son, Zaman Sháh, by the intrigues of an influential sardár, Paiyanda Khán, had been proclaimed his successor at Kabul.

Agha Muhammad's entry into Mashhad was effected without a struggle on the part of those in possession. The Kajár sháh walked on foot to the tomb of Imám Ríza, before which he knelt and kissed the ground in token of devotion, and was recognized as a Shí'ah of Shí'ahs. Sháh Rukh submissively followed in his train. Then began the last act of the local tragedy. The blind king's gradual revelation, under horrible torture, of the place of concealment of his several jewels and treasures, and his deportation and death (of the injuries thus received, at Damaghra, *en route* to Mazandaran), must be classed among the darkest records of Oriental history.

From Mashhad Agha Muhammad sent an envoy to Zaman Sháh, asking for the cession of Balkh, and explaining his invasion of Khurásán; but the Afghan monarch was too perplexed with the troubles in his own country and his own insecure position to do more than send an unmeaning reply. It is not shown what was the understood boundary between the two countries at this particular period; but Watson states that on the sháh's departure he had received the submission of the whole of Khurásán, and left in Mashhad a garrison of 12,000 men.

Agha Muhammad had now fairly-established his capital at Tehran. On his return thither in September 1796 he dismissed his troops for the winter, directing their reassembly in the following spring. The reinvansion by Russia of the provinces and districts he had recently wrested from her west of the Caspian had made great progress, but the circumstance does not seem to have changed his plans for the army. Olivier, who had in those days come to the Persian court on a commercial and political mission from the French republic, and whose book is quoted by Watson, expressed his surprise to the prime minister that, while his majesty thought it necessary to strangle some twenty-seven Russian sailors sent in as prisoners, he took no immediate measures to check the Muscovite forces in the field. The reply was that there was no hurry in the matter. Although, when the spring arrived and the sháh led his forces to the Arras, the Russians had, it is true, retreated, yet territory had been regained by them as far south as the Taliáh. Agha Muhammad had now arrived at the close of his career. He was enabled, with some difficulty, to get his troops across the river, and take possession of Shíshah, which had given them so much trouble a year or two before. There, in camp, he was murdered (1797) by his own personal attendants,—men who, singularly enough, were under sentence of death, but allowed to be at large. He was then fifty-seven years of age, and had ruled over part of Persia for more than eighteen years,—over the kingdom generally for about three years, and from his coronation for about one year only.

The brutal treatment he had experienced in boyhood under the orders of 'Adíl Sháh, Nádír's wretched nephew, and the opprobrious name of "eunuch" which attached to him, and with which he was taunted by his enemies, no doubt contributed to embitter his nature. His vindictiveness and inhumanity were notorious, and exemplified at almost every period of his life. On the other hand his contempt of luxury and frugality of diet, his *aveidanz*

<sup>1</sup> Lady Sheil says (1849): "I saw a few of these unhappy captives, who all had to embrace Mahomedanism, and many of whom had risen to the highest stations, just as the Circassian slaves in Constantinople."

of hyperbole and dislike of excessive ceremony, his protection to commerce and consideration for his soldiers, the reluctance with which he assumed the crown almost at the close of his reign, his positive refusal to wear any royal headgear but the small circular pearl-adorned diadem in which he is commonly represented by the native painter,—all these would have been praiseworthy in another man; but the fearful weight of evil on the other side of the scales made them of comparatively small consideration, and on his death the memory of his atrocious tyranny alone survived. Those who have seen his portrait once will recognize the face wherever presented. "Beardless and shrivelled," writes Sir John Malcolm, "it resembled that of an aged and wrinkled woman, and the expression of his countenance, at no time pleasant, was horrible when clouded, as it very often was, with indignation. He was sensible of this, and could not bear that any one should look at him."

Agha Muhammad had made up his mind that he should be succeeded by his nephew Fath 'Alī Shāh, son of his full brother, Husāin Kūlī Khān, and governor of Fārs, a young prince with whom he had always been on good terms, and to whom he had proved himself exceptionally well disposed. There was a short interval of confusion after the murder. The remains of the sovereign were exposed to insult, the army was disturbed, the recently-captured fort on the left bank of the Arras was abandoned; but the wisdom and resolution of the minister, Hajji Ibrāhīm, and of Mirza Muhammad Khān Kajār, a high functionary, prevailed to secure order and acceptance of the duly-appointed heir. The first, proclaiming his own allegiance, put himself at the head of a large body of troops and marched towards the capital. The second closed the gates of Tehran to all comers until Fath 'Alī Shāh came himself from Shīrāz. Though instantly proclaimed on arrival, the new monarch was not crowned until the spring of the following year (1798).

The so-called rebellions which followed were many, but not of any magnitude. Such as belong to local history are three in number, i.e., that of Sādik Khān Shakāki, the general whose possession of the crown jewels enabled him, after the defeat of his army at Karvīn, to secure his personal safety and obtain a government; of Husāin Kūlī Khān, the shāh's brother, which was compromised by the mother's intervention; and of Muhammad, son of Zaki Khān, Zend, who was defeated on more than one occasion in battle, and fled into Turkish territory. There may have been other names mixed up with these, but of aiders and abettors rather than principals. Later, Sādik Khān, having again incurred the royal displeasure, was seized, confined, and mercilessly bricked up in his dungeon to die of starvation.

Another adversary presented himself in the person of Nādir Mirza, son of Shāh Rukh, who, when Agha Muhammad appeared before Mashhad, had taken refuge with the Afghans. This prince, hearing of the death of his father's destroyer, gathered around him a military force and made a show of independence. Fath 'Alī sent to warn him of the consequences of his act, but without the desired effect. Finally, he advanced into Khurāsān with an army which appears to have met with no opposition save at Nishāpūr and Tūrbat, both of which places were taken, and when it reached Mashhad Nādir Mirza tendered his submission, which was accepted. Peace having been further cemented by an alliance between a Kajār general and the prince's daughter, the shāh returned to Tehran.

Now that the narrative of Persian kings has been brought up to the period of the consolidation of the Kajār dynasty and commencement of the 19th century, there remains but to summarize the principal events in the reigns of Fath 'Alī Shāh and his immediate successors, Muhammad Shāh and Nāsrū 'd-Dīn Shāh.

Fath 'Alī Shāh came to the throne at about thirty-two years

of age, and died at sixty-eight, after a reign of thirty-six years. The period was an eventful one. It was that of George III., George IV., and William IV. in England, of Napoleon I. from first consul to emperor, of the restoration of the Bourbon kings and the interposition of the house of Orleans, in France. The sons of Paul, Alexander and Nicholas, were emperors of Russia; and, except for the last few years of Salim II., the second Mahmūd ruled over the Turkish dominions. No other European nations had any direct concern with Persia. In Afghanistan it was the epoch of the revolution which broke up its short-lived unity as a kingdom. The struggles of Mahmūd Shāh and Shuj'au 'l-Mulk enabled them to be quasi-sovereigns for a time; but Kabul was divided from Kandahar, and Kandahar from Herat, and the work of Ahmad Abdālī was all undone. Among the governors general of India in those days are the distinguished names of Wellesley, Cornwallis, Hastings, and William Bentinck.

Persia's great aim was to recover in the north-west, as in the north-east of her empire, the geographical limits obtained for her by the Sāfawī kings; and this was no easy matter when she had to contend with a strong European power whose territorial limits touched her own. Fath 'Alī Shāh undertook, at the outset of his reign, a contest with Russia on the western side of the Caspian, which became constant and harassing warfare. Georgia was, clearly, not to revert to a Muhammadan suzerain. In 1800 its czar, George, son and successor of Heraclius, notwithstanding his former professions of allegiance to the shāh, renounced his crown in favour of the Russian emperor. His brother Alexander indignantly repudiated the act and resisted its fulfilment, but he was defeated by General Lazeroff on the banks of the Lora. Persia then re-entered the field. Among the more notable occurrences which followed were a three days' battle, fought near Etchmiadzin near Erivan, between the crown prince, 'Abbās Mirza, and General Zizianoff, in which the Persians suffered much from the enemy's artillery, but would not admit they were defeated; unsuccessful attempts on the part of the Russian commander to get possession of Erivan; and a surprise, in camp, of the shāh's forces, which caused them to disperse, and necessitated the king's own presence with reinforcements. On the latter occasion the shāh is credited with gallantly swimming his horse across the Arras, and setting an example of energy and valour. In the following year 'Abbās Mirza advanced upon Shīshah, the chief of which place and of the Karabagh, though an old foe to Agha Muhammad, had declared for Russia; much fighting ensued, and Erivan was formally taken possession of in the name of the shāh. The Russians, moreover, made a futile attempt on Gilan by landing troops at Enzali, which returned to Bākū, where Zizianoff fell a victim to the treachery of the Persian governor. Somewhat later Ibrāhīm Khāllī of Shīshah, repenting of his Russophilism, determined to deliver up the Muscovite garrison at that place, but his plans were betrayed, and he and his relatives put to death. Reprisals and engagements followed with varied success; and the crown prince of Persia, after a demonstration in Shirwan, returned to Tabriz. He had practically made no progress; yet Russia, in securing possession of Darband, Bākū, Shirwan, Shēki, Ganja, the Talish, and Moghan, was probably indebted to gold as well as to the force of arms. At the same time Persia would not listen to the overtures of peace made to her by the governor-general who had succeeded Zizianoff.

Relations had now commenced with England and British India. A certain Mahdi 'Alī Khān had landed at Bushahr, entrusted by the governor of Bombay with a letter to the shāh. His mission had reference to the politics of Afghanistan, and appears to have been fairly successful; but he was followed shortly by an English envoy from the governor-general, Captain Malcolm of the Madras army. He had not only to talk about the Afghans but about the French also, and the trade of the Persian Gulf. The results were a political and commercial treaty, and a return mission to India from Fath 'Alī Shāh. To him France next sent her message. In 1801 an American merchant from Baghdād had appeared as the bearer of credentials from Napoleon, but his mission was mistrusted and came to nothing. Some five years afterwards Jaubert, after detention and imprisonment on the road, arrived at Tehran and went back to Europe with a duly-accredited Persian ambassador, who concluded a treaty with the French emperor at Finkenstein. On the return of the Persian diplomatist, a mission of many officers under General Gardanne to instruct and drill the local army was sent from France to Persia. Hence arose the counter-mission of Sir Harford Jones from the British Government, which, on arrival at Bombay in April 1808, found that it had been anticipated by a previously-sent mission from the governor-general of India, under Malcolm again, then holding the rank of brigadier-general.

The home mission, however, proceeded to Bushahr, and Malcolm's return thence to India, from pressure of circumstances, enabled Sir Harford to move on and reach the capital in February 1809. A few days before his entry General Gardanne had been dismissed, as the peace of Tilait debarred France from aiding the shāh against Russia. However open to criticism may have been the after-conduct of the British diplomatist, his diplomacy was so far successful that he

concluded a treaty with Persia the month after his arrival at the capital; but the Government of India were not content to leave matters in his hands: notwithstanding the anomaly of a double mission, Malcolm was in 1810 again despatched as their own particular envoy. He brought with him Captains Lindsay and Christie to assist the Persians in the war, and presented the shah with some serviceable field-pieces; but there was little occasion for the exercise of his diplomatic ability save in his non-official intercourse with the people, and here he availed himself of it to the great advantage of himself and his country.<sup>1</sup> He was welcomed by the shah in camp at Ujani, and took leave a month afterwards to return *via* Baghddad and Basrah to India. The next year Sir Harford Jones was relieved as envoy by Sir Gore Ouseley.

Meanwhile hostilities had been resumed with Russia: the crown prince vainly attempted to penetrate Georgia; and one or two engagements ensued with more or less assertion of success on either side. In 1812 the British envoy used his good offices for the restoration of peace between the belligerents, and a Russian officer of high rank was sent to the Persian camp to propose the appointment of deputies. But there was no possibility of agreement, and the endeavour failed. To add to the Persian difficulty, it so happened that in July of this year a treaty was concluded between England and Russia "for re-establishing the relations of amity and good understanding between the two kingdoms respectively"; and this circumstance caused the envoy to direct that British officers should take no further part in Russo-Persian military operations. Christie and Lindsay, however, resolved to remain at their own risk, and advanced with the Persian army to the Arras. On the 31st October the force was surprised by an attack of the enemy, and retreated; the next night they were again attacked and routed at Aalanduz. Christie fell bravely fighting at the head of his brigade; Lindsay saved two of his nine guns; but neither of the two Englishmen was responsible for the want of proper disposition of the troops which mainly caused the disaster. Lankuran was taken by Persia, but retaken by Russia during the next three months; and on the 18th October 1813, through Sir Gore Ouseley's intervention, the treaty of Gulistan put an end to the war. Persia formally ceded Georgia and the seven provinces before named, with Karabagh.

On the death of the emperor Alexander in December 1825 Prince Menschikoff was sent to Tehran to settle a dispute which had arisen between the two Governments regarding the prescribed frontier. But, as the claim of Persia to a particular district then occupied by Russia could not be admitted, the special envoy was given his *congé*, and war was recommenced. The chief of Talish struck the first blow, and drove the enemy from Lankuran. The Persians then carried all before them; and the hereditary chiefs of Shirvan, Sheki, and Bakü returned from exile to co-operate with the shah's general in the south. In the course of three weeks the only advanced post held by the governor-general of the Caucasus was the obstinate little fortress of Shishah. But before long all was again changed. Hearing that a Russian force of some 9000 men was concentrated at Tiflis, Muhammad Mirza, son of the crown prince, advanced to meet them on the banks of the Zezam. He was defeated; and his father, seeking to repair the loss, was routed more seriously still at Ganja. The shah made great efforts to renew the war; but divisions took place in his son's camp, not conducive to successful operations, and new proposals of peace were made. Ardabil, and even Tabriz, had been threatened, and, although the threat had been rather signified than expressed, the presence of Russian troops south of the Arras was calculated to strike terror in Adarbaijan. But Russia demanded Erivan and Nakhitchivan (Nakhichevan) as well as the cost of the war; and in 1827 the campaign was reopened. Briefly, after successive gains and losses, not only Erivan was taken from Persia but Tabriz also, and finally, through the intervention of Sir John Macdonald, the English envoy, a new treaty was concluded at Turkmanchah, laying down the boundary between Russia and Persia very much as it has been formed in 1884. Among the hard conditions for the latter country were the cession in perpetuity of the khanates of Erivan and Nakhitchivan, the inability to have an armed vessel in the Caspian, and the payment of a war indemnity of some £3,000,000.

After Russia, the neighbouring state next in importance to the wellbeing of Persia was Turkey, with whom she was united on the west by a common line of frontier. Fath 'Ali Sháh was fortunate in having had but one war with the sultan during his whole reign, and that one of no duration. Salim had not scrupled, it is true, in 1804 and 1805, to allow the Russians to make free use of the south-eastern coasts of the Black Sea, to facilitate operations against the shah's troops; and there had been a passage of arms between the king's eldest son, Muhammad 'Ali Mirza, and Sulaiman Pasha, son-in-law of the governor-general of Baghddad, which is locally credited as a battle won by the former. But there was no open rupture between the two sovereigns until 1821, when the frontier disputes and com-

<sup>1</sup> The "wañlu 'i-mulk," governor of Karman, told Colonel Goudmid, when his guest in 1864, that "his father had been Sir John Malcolm's *Mismander*. There never was such a man as 'Malcolm Bahá'í.' Not only was he generous on the part of his government, but with his own money also" (*Telegraph and Press*, p. 586).

plaints of Persian travellers, merchants, and pilgrims culminated in a declaration of war. This made 'Abbás Mirza at once seize upon the fortified places of Toprak Kalch and Ak Sarai within the limits of the Ottoman empire, and, overcoming the insufficient force sent against him, he was further enabled to extend his incursions to Maz, Bitlis, and other known localities. The Turkish Government retaliated by a counter-invasion of the Persian frontier on the south. At that time the pasha of Baghddad was in command of the troops. He was defeated by Muhammad 'Ali Mirza, the prince-governor of Karmanshah, who drove his adversary back towards his capital and advanced to its immediate environs. Being attacked with cholera, however, the Persian commander recrossed the frontier, but only to succumb under the disease in the pass of Kirind. In the sequel a kind of desultory warfare appears to have been prosecuted on the Persian side of Kurdistan, and the shah himself came down with an army to Hamadan. Cholera broke out in the royal camp and caused the troops to disperse.

In the north the progress of 'Abbás Mirza was stopped at Baijuzi by a like deadly visitation; and a suspension of hostilities was agreed upon for the winter season. At the expiration of four months the sardar of Erivan took possession of a Turkish military station on the road to Arrzum (Erzeroum), and the crown prince marched upon that city at the head of 30,000 men. The Ottoman army which met him is said to have numbered some 52,000; but victory was on the side of their opponents. Whether the result was owing to the defection of 15,000 Kurds or not the evidence adduced is insufficient to decide. In the English records of the period it is stated that "the defeat of the Turks was complete; the greater part of their army fled in disorder from the field, abandoning all their tents and baggage, and fourteen pieces of artillery." It is added: "the prince royal followed up his successes, and advanced within two days' march of Arrzum, but the cholera morbus is said to have again broken out in his army, and in such a manner as effectually to arrest its further advance."

Profiting from this victory, 'Abbás Mirza repeated an offer of peace before made without avail to the pasha of Arrzum; and, in order to conciliate him more effectually, he retired within the old limits of the dominions of the shah, his father. But more troubles arose at Baghddad, and other reasons intervened to protract negotiations for a year and a half. At length, in July 1823, the treaty of Arrzum closed the war between Turkey and Persia. It may be remarked that this document is sensible and business-like, and provides especially against a recurrence of the proved causes of war, such as interference in one another's frontier districts, extorting taxes from Persian travellers or pilgrims, disrespect to the ladies of the royal harem and other ladies of rank proceeding to Mecca or Karbala (Kerbela), irregular levies of custom-duties, non-punishment of Kurdish depredators transgressing the boundary, and the like. Fath 'Ali Sháh in it is styled "King of kings, the Sultan son of a Sultan—the Conqueror," and Mahmud II. is "Protector of the Faith, Guardian of the Holy Cities, Ruler by Sea and Land, the Sultan son of a Sultan—the Conqueror."

With respect to the eastern boundaries of his kingdom, Fath 'Ali Sháh was fortunate in having to deal with a less dangerous neighbour than the Muscovite of persistent policy and the Turk of precarious friendship. The Afghan was neither a contemptible nor a sure ally, but he was not tainted with that fictitious civilization of semi-Oriental people which makes duplicity the essence of diplomatic intercourse. He had seen too little of Europeans to imitate them in their worst and weakest points; and, though equal to the Persian in physical force and prowess, he was his inferior in worldly knowledge and experience. Quite as dishonest as his neighbours and more treacherous than most, he had not the polished ingenuity to conceal his dishonesty and double-dealing. Moreover, the family divisions among the ruling houses of Afghanistan grew from day to day more destructive to that patriotism and sense of nationality which Ahmad Sháh had held out to his countrymen as the sole specifics for becoming a strong people.

The revolt of Nádír Mirza had, as before explained, drawn the shah's attention to Khurasaan in the early part of his reign; but although quiet had for the moment been restored at Mashhad by the presence of the royal camp, fresh grounds of complaint were urged against the rash but powerless prince, and recourse was had to extreme measures. Charged with the murder of a holy saint, his hands were cut off and his tongue was plucked out, as part of the horrible punishment inflicted on him.

It does not appear that Nádír Mirza's cause was ever seriously espoused by the Afghans, nor that Fath 'Ali Sháh's claim to Mashhad, as belonging to the Persian crown, was actively resisted. But the large province of Khurasaan, of which Mashhad was the capital, and which included Darabghas and Kelat-i-Nádír in the north and Káiyán in the south, had never been other than a nominal dependency of the crown since the death of Nádír; and in the autumn of 1830

<sup>2</sup> *Annual Register*, "History of Europe" (1823). There is a note in connection with the text from which these extracts are taken, on the state of Anglo-Persian relations and the predominance of Russian influence at Tehran, well worthy the reader's perusal.



the sháh, under Russian advice, assembled a large force to bring into subjection all turbulent and refractory chiefs on the east of his kingdom. Yazd and Karman were the first points of attack; Khurásan was afterwards entered by Semnan, or the main road from Tehran. The expedition, led by 'Abbás Mirza, involved some hard fighting and much loss of life. A considerable extent of ground was traversed; several forts and places were captured, among them Kabushan and Sarakhs; and it may be concluded that the objects contemplated were more or less attained. An English officer, Colonel Shee, commanded what was called the "British detachment" which accompanied the prince. Thus far as regards Yazd, Karman, and Khurásan. It was otherwise with Herat.

Hajji Firúsh 'd-Din, son of Tímur Sháh, reigned undisturbed in that city from 1800 to 1816. Since Fath 'Alí Sháh's accession he and his brother Mahmúd had been, as it were, under Persian protection; and, when the king retraced his steps homeward after his expedition to Mashhad, at the commencement of the century, it is supposed that he did so at the request of an ambassador from Zaman Sháh of Kabul. Persia claimed the principality of Herat as part of the empire of Nádir, but her pretensions had been satisfied by payments of tribute or evasive replies. Now, however, that she marched her army against the place, Firúsh 'd-Din called in the aid of his brother Mahmúd Sháh of Kabul, who sent to him the famous wazír, Fath Khán Bárakzái. The latter, intriguing on his own account, got possession of the town and citadel; he then solicited fight, engaged and defeated the Persian force, and forced them to retire into their own country. There are various accounts of this action, and the Persian story is that the Afghans were defeated; but no one disputes the result, *i. e.*, the retreat of the invading army. In 1824, on a solicitation from Mustafá Khán, who had got temporary hold of Herat, more troops were despatched thither, but, by the use of money or bribes, their departure was purchased. Some eight or nine years afterwards 'Abbás Mirza, when at the head of his army in Mashhad, invited Yar Muhammad Khán of Herat to discuss a settlement of differences between the two Governments. The meeting was unproductive of good. Again the Persian troops advanced to Herat itself under the command of Muhammad Mirza, son of 'Abbás; but the news of his father's death caused the commander to break up his camp and return to Mashhad.

Sir Gore Ouseley returned to England in 1814, in which year Mr Ellis, assisted by Mr Morier—whom "Hajji Baba" is the unflattering proof of his ability and deep knowledge of Persian character—negotiated on the part of Great Britain the treaty of Tehran. England was to provide troops or a subsidy in the event of unprovoked invasion, while Persia was to attack the Afghans should they invade India. Captain Wilcock succeeded Mr Morier as chargé d'affaires in 1815, and since that period Great Britain has always been represented at the Persian court. It was in Fath 'Alí Sháh's reign that Henry Martyn was in Persia, and completed his able translation of the New Testament into the language of that country. He had met Malcolm and Mackintosh at Bombay, and Sir John had recommended him to Sir Gore Ouseley, to whose mission he officiated as chaplain prior to departure from Shiráz in 1812. Martyn died at Tokat in Asia Minor, on his homeward journey. Little more remains to be here narrated of the days of Fath 'Alí Sháh. Among the remarkable occurrences may be noted the murder at Tehran in 1828 of M. Grobeyadoff, the Russian envoy, whose conduct in forcibly retaining two women of Erivan provoked the interference of the mullas and people. To repair the evil consequences of this act a conciliatory embassy, consisting of a young son of the crown prince and some high officers of the state, was despatched to St Petersburg. Shortly afterwards the alliance with Russia was strengthened, and that with England slackened in proportion. There were reasons why this should be the outcome of the previous situation, some of which will be self-evident to the reader of blue-books, while others will remain mere matters of opinion.

As an Oriental despot Fath 'Alí Sháh was neither cruel nor unjust, but acts of cruelty and injustice were committed under his sanction. The treatment of Nádir Mirza has been mentioned. That of the old minister, Hajji Ibráhím, was perhaps more barbarous still. His fondness for sport and his literary tastes gave him the capacity of suiting his conversation to visitors of different kinds; but the love of money was a drawback to the exercise of his sympathies, and the loss of territory to Russia, involving as it did loss of revenue, was not calculated to arouse any strong sentiment of friendship towards the czar's European allies. Morier's description of the king's person was thus given in 1809.

"He is a man of pleasing manners and an agreeable countenance, with an equiline nose, large eyes, and very arched eyebrows. His face is obscured by an immense beard and mustachios, which are large very black; and it is only when he talks and smiles that his mouth is discovered. His voice has once been thin, and is still harmonious; though now hollow, and obviously that of a man who has led a free life. . . . He was seated on a species of throne called the *tehd-t-áddá*, or the throne of the peacock, which is raised 3 feet from the ground, and appears an oblong square of 8 feet broad and 12 long. We could see the bust only of his majesty, as the rest of his body was hidden by an elevated railing, the upper work of the throne, at the corners of which were placed several ornaments of vases and toys. The back is much raised; on

each side are two square pillars, on which are perched birds, probably intended for peacocks, studded with precious stones of every description, and holding each a ruby in their beak. The highest part of the throne is composed of an oval ornament of jewelry, from which emanate a great number of diamond rays."

One passage may be added as not only significant of the individual monarch, but also of the national character.

"When the audience was finished, the king desired one of his ministers to inquire from J'áfr 'Alí Khán (the English Agent) what the foreigners said of him, and whether they praised and admired his appearance."

Fath 'Alí Sháh had a numerous family. Agreeably to the Persian custom, asserted by his predecessors, of nominating the heir-apparent from the sons of the sovereign without restriction to seniority, he had passed over the eldest, Muhammad 'Alí, in favour of a junior, 'Abbás; but, as the nominee died in the lifetime of his father, the old king had proclaimed Muhammad Mirza, the son of 'Abbás, and his own grandson, to be his successor. Why a younger son had been originally selected, to the prejudice of his elder brother, is differently stated by different writers. The true reason was probably the superior rank of his mother. Markham's estimate of the character of the crown prince, based upon conflicting evidence, but apparently correct, is that "he possessed enlightened views," was "desirous of improving the condition of his country," yet "was deficient in talent, rather weak-minded, and loved flattery."

It is worthy of remark that the selection of Muhammad Mirza was made with the express concurrence of the British and Russian Governments, communicated to their respective representatives at the sháh's court; and the British minister at St Petersburg was instructed to express to the Government of the czar the gratification of his own Government at finding that the two powers were "acting with regard to the affairs of Persia in the same spirit," and were "equally animated by a sincere desire to maintain not only the internal tranquillity but also the independence and integrity of Persia."<sup>1</sup>

Muhammad Sháh was twenty-eight years old when he came to the throne in 1834. He died at the age of forty-two, after a reign of about thirteen and a half years. His accession was not publicly notified for some months after his grandfather's death, for it was necessary to clear the way of all competitors, and there were two on this occasion,—one 'Alí Mirza, governor of Tehran, who actually assumed a royal title, and one Hasan 'Alí Mirza, governor of Shiráz. Owing to the steps taken by the British envoy, Sir John Campbell, assisted by Colonel Bethune, at the head of a considerable force, supplied with artillery, the opposition of the first was neutralised, and Muhammad Sháh, entering Tehran on 2d January, was proclaimed king on the 31st of the same month. It cost more time and trouble to bring the second to book. Hasan 'Alí, "farmán-farmá," or commander-in-chief, and his brother ad abettor, had an army at their disposal in Fára. Sir Henry Lindsay Bethune marched his soldiers to Ispahan to be ready to meet them. An engagement which took place near Kumisháh, on the road between Ispahan and Shiráz, having been successful, the English commander pushed on to the latter town, where the two rebel princes were seized and imprisoned. Forwarded under escort to Tehran, they were, according to Watson, ordered to be sent on thence as state prisoners to Ardabil, but the farmán-farmá died on the way, and his brother was blinded before incarceration. Markham, however, states that both 'Alí Mirza and Hasan 'Alí were allowed to retire with a small pension, and that no atrocities stained the beginning of the reign of Muhammad Sháh. It is presumed that the fate of the prime minister, or "kám-makám," who was strangled in prison, was no more than an ordinary execution of the law. This event, and the prevalence of plague and cholera at Tehran, marked somewhat gloomily the new monarch's first year.

The selection of a premier was one of the first weighty questions for solution. A member of the royal family, the "asafu 'd-daulah," governor of Khurásan, left his government to urge his candidature for the post. The king's choice, however, fell on Hajji Mirza Agháí, a native of Erivan, who in former years, as tutor to the sons of 'Abbás Mirza, had gained a certain reputation for learning and a smattering of the occult sciences, but whose qualifications for statesmanship were craftiness and suspicion. Such a counsellor was hardly fitted for Muhammad Sháh, whose natural bigotry could scarcely fail to accept the short-sighted policy which the minister would be sure to advocate. As might have been anticipated, the hajji fell into the hands of Russia, represented by Count Simonich, who urged him to a fresh expedition into Khurásan and the siege of Herat. There was no doubt a plausible pretext for both proposals. The chiefs, reduced to temporary submission by 'Abbás Mirza, had again revolted; and Sháh Kamran, supported by his wazír, Yar Muhammad, had broken those engagements and pledges on the strength of which Fath 'Alí Sháh had withdrawn his troops. In addition to these causes of offence he had, appropriated the province of Sístan, over which Persia had long professed to hold the rights of suzerainty. But the king's ambition was to go farther than retaliation or chastisement. He refused to acknowledge any right to separate government whatever on the part of the Afghans.

<sup>1</sup> Correspondence relating to Persia and Afghanistan, London, 1830.

and Kandahar and Ghazni were to be recovered, as belonging to the empire of the Safawi dynasty. The advice of the British envoy was dissuasive in this respect, and therefore distasteful.

Sir John Campbell, in less than a year after the sovereign's installation, went home, and was succeeded as British envoy by Mr Henry Ellis. The change in *personnel* signified also a transfer of superintendence of the Persian legation, which passed from the Government in India to the authorities in England. In 1836, on the return home of Mr Ellis, Mr M'Neill became chargé d'affaires.

About this time the arrangements for the expedition were matured. It was to commence with a campaign against the Türkmans,—Herat being its later destination. The king would command in person, and the army would be formidable in numbers and war material. Such counter-proposals as Mr Ellis had suggested for consideration, in his earnest endeavours to divert the shah from his purpose, had been politely put aside, and the counsels of the war-party had prevailed. Should the main operations designed be successful, and Herat fall to Persia, it was impossible to foretell the result; and the case was now more than ever complicated by the action of the Bārakzai chiefs of Kandahar, who had sent a mission to Tehran to offer assistance against their Sádúzai rival at Herat. Fresh provocation had, moreover, been given to the shah's Government by the rash and incapable Kamran.

About the close of the summer the force moved from Tehran. The royal camp was near Astrábad in November 1836. Food was scarce: barley sold for ten times the usual price, and wheat was not procurable for any money. The troops were dissatisfied, and, being kept without pay and without short rations, took to plundering. There had been operations on the banks of the Gurgau, and the Türkmans had been driven from one of their strongholds; but little or no progress had been made in the subjection of these marauders, and the Heratis had sent word that all they could do was to pay tribute, and, if that were insufficient, the shah had better march to Herat. A military council was held at Shahrud, when it was decided to return to the capital and set out again in the spring. Accordingly the troops dispersed, and the sovereign's presence at Tehran was taken advantage of by the British minister to renew his attempts in the cause of peace. But remonstrance was vain, and, although on the present occasion Count Simonich ostensibly aided Mr M'Neill, no argument was of any avail to divert the monarch from his purpose. He again set out in the summer, and, invading the Herat territory in November 1837, began the siege on the 23d of that month.

Not until September in the following year did the Persian army withdraw from before the walls of the city; and then the movement only took place on the action of the British Government. Ordinary pressure and argument had failed. It had become necessary to use strong language, and to resort to strong measures, the purport of which could not be mistaken. Mr M'Neill, who had joined the Persian camp on 6th April, left it again on 7th June. He had in this interval done all in his power to effect a reasonable agreement between the contending parties by personal communication with Afghans in Herat as well as with the shah and his minister; but both in this respect and in the matter of a commercial treaty with England, then under negotiation, his efforts had been met with evasion and latent hostility, and this last feeling had been notably evinced in the seizure and violent treatment of a messenger bearing an official communication from a foreign Government to the British minister at Tehran. The Russian envoy, who had appeared among the tents of the besieging army almost simultaneously with his English colleague, no sooner found himself alone in his diplomacy than he resumed his aggressive counsels, and little more than a fortnight had elapsed since Mr M'Neill's departure when a vigorous assault, planned, it is asserted, by Count Simonich himself, was made upon Herat. The Persians attacked at five points, at one of which they would in all likelihood have been successful had not the Afghans been aided by Eldred Pottinger, a young Englishman, who with the science of an artillery officer combined a courage and determination which inevitably influenced his subordinates. Through his exertions the assailants were beaten back, as they were also independently at the other points noted. Still the garrison was disheartened; and, had not Colonel Stoddart's arrival on 11th August to threaten the shah with British intervention put a stop to further action, there is no knowing what mischief might have resulted from the incompetence and intrigues of Kamran and his advisers. As it happened, Colonel Stoddart's firm attitude and refusal to allow any but British mediators to decide the pending dispute won the day; and that officer was able to report that on 9th September Muhammad Sháh had "mounted his horse" and gone from before the walls of the beleaguered city.

The siege of Herat was the great event in the reign of Muhammad Sháh. It lasted for nearly ten months; and the story of its progress is a strange record of a desultory campaign in which intrigue and conspiracy were the continuously working agencies, while military action was spasmodic. The British expedition in support of Sháh Shujá, which may be called its natural consequence, involves a question foreign to the present narrative. Persia's con-

nexion with Afghanistan can only be partial, and confined to Herat, Kabul, Kandahar, or one section of the country only. A united Afghanistan would always be distasteful to her.

The remainder of the king's reign was marked by new difficulties with the British Government; the rebellion of Agha Khan Mahláti, otherwise known as the chief of the Assassins; a new rupture with Turkey; the banishment of the asafu 'd-daulah, governor of Khurásan, followed by the insurrection and defeat of his son; and the rise of the sect of the Bábis. The first of these only calls for any detailed account.

In the demands of the British Government was included the cession by Persia of places such as Ghurian, Farah, and Sabzavir, which had been taken during the war from the Afghans, as well as reparation for the violence offered to the courier of the British legation. The shah, in ill-humour at his fruitless expedition to Herat, deferred compliance with these requisitions, and indeed sought to evade them altogether. M'Neill gave a certain time for decision, at the end of which, no satisfactory reply having reached him, he broke off diplomatic relations, ordered the British officers left to the shah to proceed towards Baghdád *en route* to India, and retired to Arrzum with the members of his mission. On the Persian side, charges were made against M'Neill, and a special envoy, sent to England to support them, was instructed to represent the so-called injuries which British diplomatic action had inflicted on the shah. An endeavour was at the same time made to interest the cabinets of Europe in influencing the British Government on behalf of Persia. The envoy managed to obtain an interview with the minister of foreign affairs in London, who, in July 1839, supplied him with a statement, fuller than before, of all English demands upon his country. Considerable delay ensued, but the outcome of the whole proceedings was not only acceptance but fulfilment of all the engagements contracted. In the meantime the island of Karak had been taken possession of by an expedition from India.

On 11th October 1841 a new mission arrived at Tehran from London, under Mr (now Sir) John M'Neill, to renew diplomatic relations. It was most cordially received by the shah, and it need scarcely be added that, as one of its immediate results, Karak was evacuated by the British-Indian troops.

There had been a long diplomatic correspondence in Europe on the proceedings of Count Simonich and other Russian officers at Herat. Among the papers is a very important letter from Count Nesselrode to Count Pozzo di Borgo in which Russia declares herself to be the first to counsel the shah to acquiesce in the demand made upon him, because she found "justice on the side of England" and "wrong on the side of Persia." She withdrew her agent from Kandahar and would "not have with the Afghans any relations but those of commerce, and in no wise any political interests." She recalled to the English cabinet her wishes before expressed.

"To re-establish promptly the relations of friendship between the courts of London and of Tehran; to put an end to the hostile measures adopted at the Persian Gulf; to abstain from disturbing the tranquillity of the people of the centre of Asia by nourishing their animosities; to be contented with competing in industry in those vast countries, but not to engage there in a struggle for political influence; to respect the independence of the intermediate countries which separate her own from British territory. Such, it was emphatically stated, was "the system which England and Russia have a common interest invariably to pursue, in order to prevent the possibility of a coalition between these two great powers, which, that they may continue friends, require to remain each within its own limits, and not to advance against each other in the centre of Asia."

Agha Khán's rebellion was fostered by the defection to his cause of a large portion of the force sent against him; but he yielded at last to the local authorities of Karman and fled the province and country. He afterwards resided many years at Bombay, where, while maintaining among natives a quasi-spiritual character, he is better known among Europeans for his doings on the turf.

The quarrel with Turkey, though specific in the case of individual actors, was generally about frontier relations and transgressions of the border. Eventually the matter was referred to an Anglo-Russian commission, of which Colonel Williams (since Sir Fenwick Williams of Kara) was president. A massacre of Persians at Karbala might have seriously complicated the dispute, but, after a first burst of indignation and call for vengeance, an expression of the regret of the Ottoman Government was accepted as a sufficient apology for the occurrence.

The rebellion of the asafu 'd-daulah, maternal uncle of the shah, was punished by exile, while his son, after giving trouble to his opponents, and once gaining a victory over them, took shelter with the Türkmans.

Sa'id Muhammad 'Alí, founder of the Bábis, was born at Shíráz about 1810.<sup>1</sup> Adopting a life of seclusion, and practising a kind of exaggerated Súfism, he followed for some time the calling of a dervish, and when at Kárimain near Baghdád he openly asserted his pretensions as a prophet. The Turkish authorities

<sup>1</sup> Correspondence relating to Persia and Afghanistan, London, 1839. The annexation of Sind and the Panjab will, it is presumed, be given as excuses for the partial absorption of Turkestan. But the cases are in no way analogous. The occupation by Russia of the Persian island of Ashuráda in the south-east corner of the Caspian followed the British reverses in Kabul of 1841.

<sup>2</sup> Lady Sheil. *Gobineau* says 1824.

would have put him to death, but the Persian consul, claiming him as a subject, saved his life, and sent him to his native place. Thenceforward his career is strange and adventurous; and even when he himself had been committed to prison his agents were employed in promulgating his doctrine, with sufficient success to occasion the issue of a decree making it a capital crime to profess the tenets of Bábism. More will be said on the subject shortly.

Before closing the reign of Muhammad Sháh note should be taken of a prohibition to import African slaves into Persia, and a commercial treaty with England,—recorded by Watson as gratifying achievements of the period by British diplomatists. The French missions in which occur the names of M.M. de Lavalette and de Sartiges were notable in their way, but somewhat barren of results.

In the autumn of 1848 the sháh was seized with the malady, or combination of maladies, which caused his death. Gout and erysipelas had, it is said,<sup>1</sup> ruined his constitution, and he died at his palace in Shamiran on 4th September. He was buried at Kím, where is situated the shrine of Fátima, daughter of Imám Ríza, by the side of his grandfather, Fath 'Alí, and other kings of Persia. In person he is described as short and fat, with an aquiline nose and agreeable countenance.<sup>2</sup>

On the occasion of his father's death, Násur 'd-Dín Mirza, who had been proclaimed wálí 'ahd, or heir-apparent, some years before, was absent at Tabriz, the headquarters of his province of Adarbaiján. Colonel Farrant, then chargé d'affaires on the part of the British Government, in the absence of Colonel Sheil, who had succeeded Sir John McNeill, had, in anticipation of the sháh's decease and consequent trouble, sent a messenger to summon him instantly to Tehran. The British officer, moreover, associated himself with Prince Dolgorouki, the representative of Russia, to secure the young prince's accession; and there was no doubt in the minds of the wiser lookers-on that, if the two diplomatists were really of one mind in the matter, they would attain their end in spite of all obstacles.

They did so after a time, and with the aid of the queen-mother, who, as president of the council, showed much judgment and capacity in conciliating adverse parties. But the six or seven weeks which passed between the death of the one king and the coronation of the other proved a disturbed interval, and full of stirring incident. The old minister, Hajji Mirza Aghásí, incurred the displeasure of the influential part of the community by shutting himself up in the royal palace with 1200 followers, and had to take refuge in the sanotuary of Sháh 'Abdu'l-'Azim near Tehran. On the other hand Mirza Agha Khán, a partisan of the asafu 'd-daulah, and himself an ex-minister of war, whom the hajji had caused to be banished, was welcomed back to the capital. At Isfahan, Shiráz, and Karman serious riots took place, which were with difficulty suppressed. While revolution prevailed in the city, robbery was rife in the province of Yazd; and from Kazvin the son of 'Alí Mirza, otherwise called the "gíllu 's-sultan," the prince-governor of Tehran, who disputed the succession of Muhammad Sháh, came forth to contest the crown with his cousin, the heir-apparent. The last-named incident soon came to an inglorious termination for its hero. But a more serious revolt was in full force at Mashhad when, on the 20th of October 1848, the young sháh entered his capital and was crowned at midnight king of Persia.

The chief events in the long reign of the present sháh, Násur 'd-Dín, may be reviewed under four heads: (1) the insurrection in Khurásan, (2) the insurrection of the Bábía, (3) the fall of the amír 'n-nízám, and (4) the war with England.

It has been stated that the asafu 'd-daulah was a competitor with Hajji Mirza Aghásí for the post of premier in the cabinet of Muhammad Sháh, that he was afterwards, in the same reign, exiled for rising in rebellion, and that his son, the salár, took shelter with the Türkmen. Some four months prior to the late king's decease the latter chief had reappeared in arms against his authority; he had gained possession of Mashhad itself, driving the prince-governor, Hamza Mirza, into the citadel; and so firm was his attitude that Yar Muhammad of Herat, who had come to help the Government officials, had retired after a fruitless co-operation, drawing away the prince-governor also. The salár now defied Murád Mirza, Násur 'd-Dín's uncle, who was besieging the city; he found secret means of obtaining money and supplies; and, by occasionally repelling an assault or effecting a skillful sortie, he kept up a prestige of power, which, added to his personal popularity, commanded the sympathy and good wishes of the multitude. In April 1850, after a siege of more than eighteen months, fortune turned against the bold insurgent, and negotiations were opened between the citizens and besiegers for the surrender of the town and citadel. Treachery may have had to do with the result, for when the sháh's troops entered the holy city the salár sought refuge in the mosque of Imám Ríza, and was forcibly expelled. He and his brother were seized and put to death, the instrument used being, according to Watson, "the bowstring of Eastern story." The conqueror of Mashhad, Murád Mirza, became afterwards himself the prince-governor of Khurásan.

<sup>1</sup> Watson.

<sup>2</sup> Markham.

Lady Sheil has written a graphic account of the death of Sa'id Muhammad 'Alí. After repeated arrests and warnings to no purpose the spread of his doctrines had become so rapid among all classes that it was thought necessary to remove him by the severest punishment of the law. He was conveyed to Tabriz, and brought out in the great square for execution.

"A company of soldiers was ordered to despatch Báb by a volley. When the smoke had cleared away Báb had disappeared from sight. It had so happened that none of the balls had touched him, and, prompted by an impulse to preserve his life, he rushed from the spot. Had Báb possessed sufficient presence of mind to have fled to the bazar . . . he would in all probability have succeeded in effecting his escape. A miracle palpable to all Tabriz would have been performed, and a new creed would have been established. But he turned in the opposite direction, and hid himself in the guard-room, where he was immediately discovered, brought out, and shot. His body was thrown into the ditch of the town, where it was devoured by the half-wild dogs which abound outside a Persian city. Báb possessed a mild and benignant countenance, his manners were composed and dignified, his eloquence was impressive, and he wrote rapidly and well."

Later on she wrote—

"This year (1850) seven Bábís were executed at Tehrán for an alleged conspiracy against the life of the prime minister. Their fate excited general sympathy, for every one knew that no criminal act had been committed, and suspected the accusation to be a pretence. . . . Previously to decapitation they received an offer of pardon, on the condition of reciting the kalama (or Muhammadan creed). . . . It was rejected, and these visionaries died steadfast in their faith. . . . In Zanján the insurrection, or the religious movement, as the Bábís termed it, broke out with violence. This city is only 200 miles from Tehrán, midway to Tabriz. At its head was a mulla of repute and renown, who, with his associates, retired into an angle of the city, which they strengthened as best they could. For several months they defended themselves with unconquerable resolution against a large force in infantry and guns, sent against them from Tehrán. It was their readiness to meet death that made the Bábís so formidable to their assailants. From street to street, from house to house, from cellar to cellar, they fought without flinching. All were killed at their posts, excepting a few who were afterwards bayoneted by the troops in cold blood."

In the summer of 1852 his majesty was attacked, while riding in the vicinity of Tehrán, by four men, one of whom fired a pistol and slightly wounded him. This man was killed, and two others were captured by the royal attendants; the fourth jumped down a well. The existence of a conspiracy was then discovered, in which some forty persons were implicated; and ten of the conspirators (one a young woman) were put to death,—some under cruel torture. A short reign of terror then ensued which is well illustrated in the following extract from Watson's *History*.

"The prime minister . . . was fearful of drawing down upon himself and his family the vengeance of the followers of the Báb; and, in order that other might be implicated in these executions, he hit upon the device of assigning a criminal to each department of the state; the several ministers of the Shah being thus compelled to act as executioners. The minister for foreign affairs, the minister of finance, the son of the prime minister, the adjutant-general of the army, and the master of the mint, each fired the first shot, or made the first cut with a sabre, at the culprits assigned to their several departments, respectively. The artillery, the infantry, the camel-artillery, and the cavalry, each had a victim. . . . But the result of all this slaughter was, as might have been expected, to create a feeling of sympathy for the Bábís, whose crime was lost sight of in the punishment which had overtaken them. They met their fate with the utmost firmness, and none of them cared to accept the life which was offered to them on the simple condition of reciting the Muslim creed. While the lighted candles were burning the flesh of one follower of the Báb, he was urged by the chief magistrates of Tehrán to curse the Báb and live. He would not renounce the Báb; but he cursed the magistrate who tempted him to do so, he cursed the Báb, and even cursed the prophet Muhammad, his spirit rising superior to the agony of his torture."

The movement, however, was not only felt in Tehrán and Zanjan but also in Mazandaran, Fára, Karman, and Tabriz; and, in spite of the fearful punishments with which the professors of the doctrine have been visited, the complete extinction of Bábism by fire and sword is a consummation hardly to be set within the range of human probability.

Mirza Taki, the amír 'n-nízám (vulgarly amír nízám), or commander-in-chief, was a good specimen of the self-made man of Persia. He was the son of a cook of Bahám Mirza, Muhammad Sháh's brother, and he had filled high and important offices of state and amassed much wealth when he was made by the young sháh Násur 'd-Dín, on his accession, both his brother-in-law and his prime minister. The choice was an admirable one; he was honest, hard-working, and liberal according to his lights; and the services of a loyal and capable adviser were secured for the new régime. For the rebellion in Khurásan and all emergencies that occurred during his thirty years' tenure of office, he was the same active and intelligent mentor that he had been when associated with the prince in his government of Adarbaiján. Unfortunately, he did not boast the confidence of the queen-mother; and this circumstance greatly strengthened the hands of those enemies whom an honest minister must ever raise around him in a corrupt Oriental state. For a time the sháh closed his eyes to the accusations and insinuations breathed against him; but at last he fell under the evil influence of designing counsellors, and acts which should have redounded to the minister's credit became the charges on which he lost his office and his life. He was credited with an intention to grasp in his own hands the royal power; his influence over the army was

<sup>3</sup> "Even the Shah's admirable French physician, the late lamented Dr Clouquet, was invited to show his loyalty by following the example of the rest of the court. He excused himself, and pleasantly said that he killed too many men professionally to permit him to increase their number by any voluntary homicide on his part" (Lady Sheil).

cited as a cause of danger; and on the night of 12th November 1851 he was summoned to the palace and informed that he was no longer premier. Mirza Agha Khán, the "tímáin d-danlah," was named to succeed him, and had been accordingly raised to the dignity of "sadr'asim." As the hostile faction pressed the necessity of the ex-minister's removal from the capital, he was offered the choice of the government of Fára, Ispahan, or Kúm. He declined all; but, through the mediation of Colonel Shell, he was afterwards offered and accepted Káshán. It is not probable that Mirza Taki, once fallen from his high estate, would have long survived, or rather would have been long suffered by his rivals or foes to survive, this crisis in his career. For intrigues and charlatans he was too real a character to be harmless, and means would have doubtless been devised to get rid of him altogether. As it happened, opportunity was taken of an ill-timed if well-meant interference on his behalf of the Russian legation, and the sháh's ire was aroused more than ever against him.

"Once having got him out of the way," writes Major Thom Smith from information gathered on the scene of the tragedy he is recounting, "his enemies had full play, and, forty days after his banishment, prevailed upon the king to issue orders for his execution. . . . The executioners arrived at Fir, and, seeing the ex-minister, told him that they had been sent by the sháh to ask after his health. Mirza Taki Khán at once saw that his fate was sealed; he merely asked that, instead of having his throat cut, he might be allowed to die in his own way. The request was granted; he went into the hammam, where the king's barber opened the two principal arteries in each arm, and he quietly sat there and bled to death."<sup>1</sup>

When England was engaged in the Crimean War of 1854-55 her alliance with a Muhammadan power in no way added to her popularity or strengthened her position in Persia. The Sunni Turk was almost a greater enemy to his neighbour the Shíah than the formidable Muscovite, who had curtailed him of so large a section of his territory west of the Caspian. Hence during the war Persia coquetted with Russia as to a possible secret alliance, rather than with France or England. Moreover, since Sir John M'Neill's arrival in Tehran in 1841, formally to repair the breach with Muhammad Sháh, there had been little difference, demands, and explanations, which were portentous of a storm in the future; and these symptoms had culminated in 1856, the year of the peace with Russia. As to Afghanistan, the vezir Yar Muhammad had in 1842, when the British troops were perishing in the passes, or otherwise in the midst of dangers, caused Kamran to be suffocated in his prison. Since that event he had himself reigned supreme in Herat, and, dying in 1851, was succeeded by his son Sa'id Muhammad. This chief soon entered upon a series of intrigues in the Persian interests, and, among other acts offensive to Great Britain, suffered one 'Abbas Káil, who had, under guise of friendship, betrayed the cause of the sháh at Mashhad, to occupy the citadel of Herat, and again place a detachment of the sháh's troops in Ghurian. Colonel Shell remonstrated, and obtained a new engagement of non-interference with Herat from the Persian Government, as well as the recall of 'Abbas Káil. In September 1856 Muhammad Yúsuf Sádúzi seized upon Herat, putting Sa'id Muhammad to death with some of his followers who were supposed accomplices in the murder of his uncle Kamran.

About this time Kohan Dil Khán, one of the chiefs of Kandahar, died, and Dost Muhammad of Kabul annexed the city to his territory. Some relations of the deceased chief made their escape to Tehran, and the sháh, listening to their complaint, directed the prince-governor of Mashhad to march across to the eastern frontier and occupy Herat, declaring that an invasion of Persia was imminent. Such was the situation when the Hon. Mr Murray was fulfilling his second year of duty at the legation in Tehran. He had relieved Mr T aylour Thomson, Colonel Shell's *locum tenens*, at a time when relations were somewhat strained, and coolness and want of confidence were daily becoming more apparent between the British representative and the court to which he was accredited. The following passage is from a recently-published work treating of the place and period.<sup>2</sup>

"At the end of 1855, our relations with the court of Tehran were anything but satisfactory. Even the outward semblance of civility towards the English representative was disregarded, and, in like manner, the veneer of courtesy was wanting in the official communications bearing the sign-manual of the sháh or his responsible minister. So great was the tension of ill-feeling occasioned, that our envoy withdrew to Baghdad, desiring to resume the functions of his office until ample apology had been made, by certain persons named, for certain offences charged, after a manner detailed by himself. A crisis such as this may, it is true, be known about in Persia by the attitude of Persian evidence of withdrawal and an exhibition of more than ordinary temper; but not only were the sháh's own words full of insult, but his expressions were supplemented by deeds. Finally, by sending a large military expedition under his royal uncle, Prince Murád Khán, to take possession of Herat, he showed his contempt of treaties, and aimed a blow at England's Eastern policy in the most sensitive part.

"This occurred in December, the same month in which the British envoy quitted Tehran. In the first week of 1856, negotiations were opened at Constantinople, when the Persian chargé d'affaires in that city related his version of the quarrel to our well-known ambassador there. Discussion was prolonged for some months in 1856, during which an 'ultimatum' from Lord Cowley had been put forward without result; and in October, a plenipotentiary named Farrakh Khán arrived at the Porte with the sháh's instructions to settle the whole matter in dispute. But although this passage went so far as to say a declaration that Herat should immediately be evacuated by the troops of his sovereignty, other engagements were required from him which he could not undertake, and the attempt at a settlement failed. Lord Stratford presented a new 'ultimatum' on November 22d; but it was then too late to avert an outbreak. The news that Herat had been captured on October 26th, and that these proceedings declared war against Persia, had been issued by the governor-general of India on November 1st, soon reached Constantinople, and Farrakh Khán's occupation was, for the moment, gone."

In less than three weeks after issue by the governor-general of India of the proclamation of war with Persia the Sind division of the field force left Karachi (Kurrachee). On 13th January following the Bombay Government orders notified the formation of a second division under Lieutenant-General Sir James Outram. Before the general arrived the island of Karak and part of Bushahr had both been occupied, and the fort of Kishir had been attacked and carried. After the general's arrival the march upon Berazjín and the engagement at Khushab—two places on the road to Shiráz—and the operations at Muhamrah and the Káirín river decided the campaign in favour of England. On 5th April, at Muhamrah, Sir James Outram received the news that the treaty of peace had been signed in Paris, where Lord Cowley and Farrakh Khán had conducted the negotiations. The stipulations regarding Herat were much as before; but there were to be apologies made to the mission for past insolence and rudeness, and the slave trade was to be suppressed in the Persian Gulf.

With the exception of a small force retained at Bushahr under General John Jacob for the three months assigned for execution of the ratifications and giving effect to certain stipulations of the treaty with regard to Afghanistan, the British troops returned to India, where their presence was greatly needed, owing to the outbreak of the mutiny. The envoy retraced his steps from Baghdad to Tehran, to receive the excesses of the sháh's minister. Before Mr Murray's arrival, however, an act of so-called retaliation, but avouring rather of sheer revenge, had been perpetrated, which could not have commended itself to the mind of an English diplomat on the spot. One of the articles of the treaty of peace provided for the release of all prisoners taken by the Persians at Herat. Among these was the ex-ruler Muhammad Yúsuf, who, having resisted the besieging army, had been brought captive to Tehran. The provision of mercy was in his case tantamount to a sentence of savage death, for the relatives of Sa'id Muhammad (whom he had slain in return for the murder of his uncle Sháh Kamran) awaited his release literally to hew him to pieces in front of the Kasri Kajár, a royal palace about 5 miles from the walls of the capital. When Colonel Taylor and the officers deputed with him to certify the evacuation of Herat by the Persian soldiers reached their destination, they were received by a newly-appointed governor, Sultan Ahmad Khán, better known as Sultan Ján, nephew and son-in-law of the amir Dost Muhammad. It is unnecessary to refer to other than the political reasons of the war. They soon ceased to interest the minds of even European residents in Persia; and the war became a thing of the past. Mr Murray was succeeded in 1859 by Sir Henry Rawlinson as British envoy. No more popular nomination could have been made than that of this justly-distinguished Oriental statesman; but he barely remained a year at the work. Retiring at his own request, he was succeeded by Mr Charles Alison, whose marvellous acquaintance with Turks and their language had rendered him an invaluable secretary at Constantinople.

It now only remains to mention those incidents which have engaged the attention of the British Government, or in which British officers have had to play a part. Such are the establishment of a telegraph, the settlement of the Perso-Balúch, and the arbitration on the Perso-Afghan frontier. The proceedings of Russia in the countries east of the Caspian and bordering on the Oxus have, moreover, a bearing more or less direct on the interests of Great Britain, with especial reference to her Indian empire.

The question of constructing a telegraph in Persia as a link in the overland line to connect England with India was broached in Tehran by Colonel Patrick Stewart and Captain Champain, officers of engineers, in 1862, and an agreement on the subject concluded by Mr Edward Eastwick, when chargé d'affaires, at the close of that year. Three years later a more formal convention, including a second wire, was signed by Mr Alison and the Persian foreign minister; meantime the work had been actively carried on, and communication opened on the one side between Bushahr and Karachi and the Makran coast by cable, and on the other between Bushahr and Baghdad via Tehran. The untrustworthy character of the line through Asiatic Turkey caused a subsequent change of direction; and an alternative line—the Indo-European—from London to Tehran, through Russia and along the eastern shores of the Black Sea, was constructed, and has worked well since 1872.

<sup>1</sup> *Eastern Persia*, vol. 1. p. 158. The palace of Fir, near Káshán, was the residence of the amir nishán.

<sup>2</sup> *James Outram: a Biography*, vol. 2, London, 1860.

in conjunction with the Persian land telegraph system and the Bushahr-Karachi line.<sup>1</sup>

The Sistan mission, under Major-General (afterwards Sir Frederic) Goldsmid, left England in August 1870, and reached Tehran on 8d October. Thence it proceeded to Ispahan, from which city it moved to Baluchistan, instead of seeking its original destination. Difficulties had arisen both in arranging the preliminaries to arbitration and owing to the disordered state of Afghanistan, and it was therefore deemed advisable to commence operations by settling a frontier dispute between Persia and the Kelat state. Unfortunately, the obstructions thrown in the way of this settlement by the Persian commissioner, the untoward appearance at Bampur of an unexpected body of Kalatis, and the absence of definite instructions marred the fulfilment of the programme sketched out; but a line of boundary was proposed, which has since been accepted by the litigants, and which, except perhaps in the case of a small district on the north, has, it is believed, been generally respected. In the following year the same mission, accompanied by the same Persian commissioner, proceeded to Sistan, where it remained for more than five weeks, prosecuting its inquiries, until joined by another mission from India, under Major-General (afterwards Sir Richard) Pollock, accompanying the Afghan commissioner. Complications then ensued by the determined refusal of the two native officials to meet in conference; and the arbitrator had no course available but to take advantage of the notes already obtained on the spot, and return with them to Tehran, there to deliver his decision. This was done on 19th August 1872. The contending parties appealed to the British secretary of state for foreign affairs, as provided by previous understanding; but the decision held good, and was eventually accepted on both sides (see above, p. 619).

The Russo-Persian boundary question of 1881 might have been considered to belong to history, but has been treated elsewhere. It is, however, a strictly pacific arrangement, and has nothing in common with the treaties of Gulistan or Turkmanchâh.

Mr Alison died at Tehran in April 1872. Mr Ronald Thomson, whose experience of Persia is of thirty-five years' duration, then

became chargé d'affaires, and held the post until relieved by his brother, Mr (since Sir) Tylour Thomson from Chiffi. On the retirement of the latter in April 1879, Mr (since Sir Ronald) Thomson succeeded as envoy. During the later years of the reign of Nâsur 'd-Din several Englishmen have distinguished themselves as explorers in the north-east. Among them the names of O'Donovan, Napier, Baker, Gill, Clayton, and Stewart will be readily remembered. Colonels Bateman-Champain, Murdoch Smith, Sir Oliver St John, Beresford Lovett, and the late Major Pierson, all engineer officers connected with the telegraph, have made their mark in the country. Nâsur 'd-Din Shâh, unlike his predecessors, has paid two visits to Europe,—one in 1878 and one in 1879. On the first occasion only he extended his journey to England, and was then attended by his "sadr 'asim," or prime minister, the late Mirza Husain Khân, an able and enlightened adviser, with a Grand Cross of the Star of India. His second visit was to Russia, Germany, France, and Austria, but he did not cross the Channel. Among the shâh's latest projects are the possession of a little fleet in the Persian Gulf, and of some vessels on the Kârdin. In 1884 it was stated that a thousand-ton steamer (the "Persepolis") and a smaller one for river navigation were actually in course of construction. The route by the Kârdin was to be opened, and a carriageable road constructed from Shûstâr to Tehran, via Dîrful, Khuramabad, Bûrdjird, Sultanabad, and Kûm. Orders had been given for building two tugs to pull native craft up the Kârdin. The arrangements for the road, transport, and administration from Muhamrah to Tehran were confided to General Houtum Schindler, the inspector-general of Persian telegraphs.<sup>2</sup>

The works which have been mainly followed and quoted in the above historical sketch are Sir John Malcolm's *History of Persia*; the more modern histories by Robert Grant Watson and Clements Markham; the *Travels of Pevsien in Persia*, edited by Lord Stanley of Alderley, printed for the Hakluyt Society (1879); and the *History of the late Revolution in Persia*, taken from the memoirs of Father Kruzinski, procurator of the Jesuits at Ispahan (1788). Those which have contributed information in a minor degree are Lady Sheil's *Diary in Persia*; Meukins's *Bâbâr*; Chardin's *Trajecta*, annotated by Langlet; Professor Cressy's *History of the Ottoman Turks*; Ferriar's *History of the Afghans*; *Telegraph and Travel* (1874); and others mentioned in the footnotes. (F. J. G.)

PART III.—LANGUAGE AND LITERATURE.

SECTION I.—PERSIAN (IRANIAN) LANGUAGES.

Under the name of Persian is included the whole of that great family of languages occupying a field nearly coincident with the modern Iran, of which true Persian is simply the western division. It is therefore common and more correct to speak of the Iranian family. The original native name of the race which spoke these tongues was Arian. King Darius is called on an inscription "a Persian, son of a Persian, an Arian of Arian race"; and the followers of the Zoroastrian religion in their earliest records never give themselves any other title but *Aryasê danghadê*, that is to say, "Arian race." The province of the Iranian language is bounded on the west by the Semitic, on the north and north-east by the Ural-altaic or Turanian, and on the south-east by the kindred language of India.

The Iranian family of languages is one of the seven great branches of the Indo-European stem, and was first recognised as such by Sir William Jones and Friedrich Schlegel. Whatever uncertainty still remains as to the exact relationship between all the several branches of the Indo-European family, it is at least certain that Indian and Persian belong together more closely than the rest, and that they continued to develop side by side for a long period after the other branches had been already severed from the parent stem.

The common characteristics of all Iranian languages, which distinguish them especially from Sanskrit, are as follows.

- (1) Change of the original *s* into the spirant *h*. Thus—
 

Sanskrit.	Zend.	Old Persian.	New Persian.
sindha (Indus)	hinda	hinda	hind
sava (all)	haura	haura	har
sama (whole)	hama	hama	ham
sant (sunt)	hent	hant	hend.
- (2) Change of the original aspirates *gh, dh, bh* (= *χ, φ, θ*) into the corresponding mediale—
 

Sanskrit.	Zend.	Old Persian.	New Persian.
bhâmi (earth)	bûmi	bûmi	bûm.
dhita (θerês)	dâta	dâta	dâd
gharma (heat)	garama	garma	garm.
- (3) *k, t, p* before a consonant are changed into the spirants *kâ, tâ, f*—
 

Sanskrit.	Zend.	Old Persian.	New Persian.
grathama (first)	gratama	gratama	gratum (Fart).
kratu (insight)	kratu	kratu	khîrad.
- (4) The development of soft sibilants—

Sanskrit.	Zend.	Old Persian.	New Persian.
Asurê Medhâs <sup>3</sup>	Ahurê Maudâo	Auramâdâ	Ormuzd
bâhu (arm)	bâru	....	bâd
nîma (nîema)	zîma	....	zîm.

Our knowledge of the Iranian languages in older periods is too fragmentary to allow of our giving a complete account of this family and of its special historical development. It will be sufficient here to distinguish the main types of the older and the more recent periods. From antiquity we have sufficient knowledge of two dialects, the first belonging to eastern Iran, the second to western.

1. *Zend, or Old Bactrian.*—Neither of these two titles is well chosen. The name Old Bactrian suggests that the language was limited to the small district of Bactria, or at least that it was spoken there,—which is, at the most, only an hypothesis. Zend, again (originally *dasintêk*), is not the name of a language, as Anquetil Duperron supposed, but means "interpretation" or "explanation," and is specially applied to the mediæval Pahlavi translation of the *Avesta*. Our "Zend-Avesta" does not mean the *Avesta* in the Zend language, but is an incorrect transcription of the original expression "Avistak va sand," i.e., "the holy text (*Avesta*) together with the translation." But, since we still lack sure data to fix the home of this language with any certainty, the convenient name of Zend has become generally established in Europe, and may be provisionally retained. But the home of the Zend language was certainly in eastern Iran; all attempts to seek it farther west—e.g., in Media<sup>4</sup>—must be regarded as failures.

Zend is the language of the so-called *Avesta*,<sup>5</sup> the holy book of the Persians, containing the oldest documents of the religion of Zoroaster. Besides this important monument, which is about twice as large as the *Iliad* and *Odyssey* put together, we only possess very scanty relics of the Zend language in mediæval glosses and scattered quotations in Pahlavi books. These remain, however, suffice to give a complete insight into the structure of the language. Not only amongst Iranian languages but amongst all the languages of the Indo-European group, Zend takes one of the very highest places in

<sup>1</sup> In the transcription of proper names in Part II. an endeavour to render the pronunciation current in Persia has caused the modification of the more conventional, and perhaps the more strictly correct, mode elsewhere followed in this work. On this principle it is that the *s* is replaced by *t* and *c*, and the *e* by *â*, as in Makran for Makran, Bigan for Ragan, Khuristan for Khorsistan, &c. In Arabic words, however, the *w* is not exchanged for *v*, nor is the *y* necessarily used for the *ç*, except where the repetition of *t* would be confusing, as in *siyid*. As a general rule the system of spelling Indian words, accepted for official correspondence, has been applied to the transliteration of Persian. When a final *s* is not accented it represents *sh*, as *khru* for *khruâh*, and so forth.

<sup>2</sup> Name of the supreme god of the Persians.  
<sup>3</sup> Cp. I. Darmesteter, *Études Iraniennes*, l. 10 (Paris, 1868).  
<sup>4</sup> As was said above, this, and not *Zend-Avesta*, is the correct title for the original text of the Persian Bible. The origin of the word is doubtful, and we cannot point to it before the time of the Sassanians. Perhaps it means "announcement," "revelation."

<sup>1</sup> The Indo-European Telegraph Company have now (1884), on rather more than 400 miles of wire, from Jûlfa on the Araxes to Tehran, in what is called the "Maintenance Department," six stations with fifteen employes; the "commercial" stations, with twenty employes, are at Tabriz and Tehran only. The Persian telegraph system, under British officers, has fourteen stations in all, the chief being at Tehran, Ispahan, Shirâz, and Bushahr. The official staff numbers between thirty-five and forty. The number of paid words passing through these lines has steadily increased from 308,496 in 1877 to 1,177,413 in 1883. The average time taken by a message from London to Calcutta via Tehran varies from one and a half to two and a half hours.

importance for the comparative philologist. In age it almost rivals Sanskrit; in primitiveness it surpasses that language in many points; it is inferior only in respect of its less extensive literature, and because it has not been made the subject of systematic grammatical treatment. The age of Zend must be examined in connexion with the age of the *Avesta*. In its present form the *Avesta* is not the work of a single author or of any one age, but embraces collections produced during a long period. The view which became current through Anquetil Duperron, that the *Avesta* is throughout the work of Zoroaster (in Zend, *Zarathushtra*), the founder of the religion, has long been abandoned as untenable. But the opposite view, which is now frequently accepted, that not a single word in the book can lay claim to the authorship of Zoroaster, also appears on closer study too sweeping. In the *Avesta* two stages of the language are plainly distinguishable, for which the supposition of local dialectic variation is not sufficient explanation, but which appear rather to be an older and a younger stage in the development of the same language. The older is represented in but a small part of the whole work, the so-called *Gâthas* or songs. These songs form the true kernel of the book Yasna<sup>1</sup>; they must have been in existence long before all the other parts of the *Avesta*, throughout the whole of which allusions to them occur. These *gâthas* are what they claim to be, and what they are honoured in the whole *Avesta* as being,—the actual productions of the prophet himself or of his time. They bear in themselves irrefutable proofs of their authenticity, bringing us face to face not with the Zoroaster of the legends but with a real person, announcing a new doctrine and way of salvation, no supernatural Being assured of victory, as he is represented in later times, but a mere man, often himself despairing of his final success, and struggling not with spirits and demons but with human conflicts of every sort, in the midst of a society of fellow-believers which was yet feeble and in its earliest infancy. It is almost impossible that a much later period could have produced such unpretentious and almost depreciatory representations of the deeds and personality of the prophet; certainly nothing of the kind is found outside the *gâthas*. If, then, the *gâthas* reach back to the time of Zoroaster, and he himself, according to the most probable estimate, lived as early as the 14th century B.C., the oldest component parts of the *Avesta* are hardly inferior in age to the oldest Vedic hymns. The *gâthas* are still extremely rough in style and expression; the language is richer in forms than the more recent Zend; and the vocabulary shows important differences. The predominance of the long vowels is a marked characteristic, the constant appearance of a long final vowel contrasting with the preference for a final short in the later speech.

Sanskrit.	Gâthâ.	Later Zend.
abhi (near)	abi	abi
thâ (work)	ihâ	isha.

The clearest evidence of the extreme age of the language of the *gâthas* is its striking resemblance to the oldest Sanskrit, the language of the Vedic poems. The *gâthâ* language (much more than the later Zend) and the language of the *Vedas* have a close resemblance, exceeding that of any two Romanic languages; they seem hardly more than two dialects of one tongue. Whole strophes of the *gâthas* can be turned into good old Sanskrit by the application of certain phonetic laws; for example—

"mat vâo padâh yâ thrâtâitâ ihâyâo  
 parjâsâi masâi utânâsâto  
 ât vâ ashâ aredrâhyâso nemanghâ  
 ât vâo vanghushâ mananghâ hunarettâ."

becomes in Sanskrit—

"mana vah padâh yâ pragrâtâ thâyâh  
 parigachâi medhâ utânâsâto  
 ât va ritnâ redhrâsyâso namâsâ  
 ât vâo vasor manasâh sânpâyâ."<sup>2</sup>

The language of the other parts of the *Avesta* is more modern, but not all of one date, so that we can follow the gradual decline of Zend in the *Avesta* itself. The later the date of a text, the simpler is the grammar, the more lax the use of the cases. We have no chronological points by which to fix the date when Zend ceased to be a living language; no part of the *Avesta* can well be put later than the 6th or 4th century B.C. Persian tradition at least regards the collection and arrangement of the holy texts as completed before Alexander's time. At that period they are said to have been already written out on dressed cowhides and preserved in the state archives at Persepolis.

The followers of Zoroaster soon ceased to understand Zend. For this reason all that time had spared of the *Avesta* was translated into Middle Persian or PAHLAVI (g.s.) under the Sassanians. This translation, though still regarded as canonical by the Parsis, shows a very imperfect knowledge of the original language. Its value for modern philology has been the subject of much needless contro-

<sup>1</sup> The *Avesta* is divided into three parts: (1) Yasna, with an appendix, Vîsparsd, a collection of prayers and forms for divine service; (2) Vendîdâd, containing directions for purification and the penal code of the ancient Persians; (3) Khordâh-Avesta, or the Small *Avesta*, containing the Yasht, the contents of which are for the most part mythological, with shorter prayers for private devotion.

<sup>2</sup> "With verses of my making, which now are heard, and with prayerful hands, I come before thee, Mazda, and with the sincere humility of the upright man and with the believer's song of praise."

versy amongst European scholars. It is only a secondary means towards the comprehension of the ancient text, and must be used with discrimination. A logical system of comparative exegesis, aided by constant reference to Sanskrit, its nearest ally, and to the other Iranian dialects, is the best means of recovering the lost sense of the Zend texts.

The phonetic system of Zend consists of simple signs which express the different shades of sound in the language with great precision. In the vowel-system a notable feature is the presence of the short vowels *e* and *o*, which are not found in Sanskrit and Old Persian; thus the Sanskrit *asati*, Old Persian *asanti*, becomes *asenti* in Zend. The use of the vowels is complicated by a tendency to combinations of vowels and to epenthesis, i.e., the transposition of weak vowels into the next syllable; e.g., Sanskrit *dhârâti*, Zend *dhârâiti* (he carries); Old Persian *maruyâ*, Zend *maruoyâ* (Merr); Sanskrit *rinakâti*, Zend *rinakâiti*. Triphthongs are not uncommon; e.g., Sanskrit *asvâhyâs* (dative plural of *asva*, a horse) is in Zend *asvâityâs*; Sanskrit *krnôti* (he does), Zend *krnôiti*. Zend has also a great tendency to insert irrational vowels, especially near liquids; owing to this the words seem rather inflated; e.g., *asvâs* (on the left) becomes in Zend *asvâyas*; *dhârjâiti* (it glitters), Zend *dhârjâiti*; *gud* (gold), Zend *gudâ*. In the consonantal system we are struck by the abundance of sibilants (*s* and *sh*), in three forms of modification, *s* and *sh* and nasals (five in number), and by the complete absence of *l*. A characteristic phonetic change is that of *rt* into *st*; e.g., Zend *ashta* for Sanskrit *ashta*, Old Persian *ashta* (in *Artaxerxes*); *fravashî* for Pahlavi *fravardîn*, New Persian *farsh* (the spirits of the dead). The verb displays a like abundance of primary forms with Sanskrit, but the conjugation by periphrasis is only slightly developed. The noun has the same eight cases as in Sanskrit. In the *gâthas* there is a special ablative, limited, as in Sanskrit, to the "a" stems, whilst in later Zend the ablative is extended to all the stems indifferently.

We do not know in what character Zend was written before the time of Alexander. From the Sassanian period we find an alphabetic and very legible character in use, derived from Sasanian Pahlavi, and closely resembling the younger Pahlavi found in books. The oldest known manuscripts are of the 14th century A.D.<sup>3</sup>

Although the existence of the Zend language was known to the Oxford scholar Hyde, the Frenchman Anquetil Duperron, who went to the East Indies in 1755 to visit the Parsi priests, was the first to draw the attention of the learned world to the subject. Scientific study of Zend texts began with E. Burnouf, and has since then made rapid strides, especially since the *Vedas* have opened to us a knowledge of the oldest Sanskrit.

2. *Old Persian*.—This is the language of the ancient Persians properly so called, in all probability the mother-tongue of Middle Persian of the Pahlavi texts, and of New Persian. We know Old Persian from the rock-inscriptions of the Achemenians, now fully deciphered. Most of them, and these the longest, date from the time of Darius (Old Persian, *Dârayavaush*); but we have specimens as late as Artaxerxes Ochus. In the latest inscriptions the language is already much degraded; but on the whole it is almost as antique as Zend, with which it has many points in common. For instance, if we take a sentence from an inscription of Darius, as—

"Anramasâdâ hya imân bûmîn adâdâ hya avam asmanem adâdâ hya martiyam adâ hya syâtîm adâdâ martiyâhâ hya Dârayavaum khakhyathiyam akunashâ avas paruvân khakhyathiyam," it would be in Zend—

"Ahurâ manâto yo imân bûmîn adâdâ yo avam asmanem adâdâ yo martiim adâdâ yo shâtîm adâdâ martiyâhâ yo dârayavôvôum khakshâstem akunashâ; ôyîm paruvân khakshâstem."<sup>4</sup>

The phonetic system in Old Persian is much simpler than in Zend; we reckon twenty-four letters in all. The short vowels *e*, *o* are wanting; in their place the old "a" sound still appears as in Sanskrit, i.e., *Zend bagem*, Old Persian *bagom*, Sanskrit *bagas*; Old Persian *Amarana*, *Zend Amerena*, Sanskrit *amarana*. As regards consonants, it is noticeable that the older *s* (soft *s*) still preserved in Zend passes into *sh*,—a rule that still holds in New Persian; compare—

Sanskrit.	Zend.	Old Persian.	New Persian.
hasâ (hand)	asâ	dashâ	dash
jrâyas (sea)	srâyô	daraya	daryâ
aham (I)	asem	adam	âdâ

Also Old Persian has no special *l*. Final consonants are almost entirely wanting. In this respect Old Persian goes much farther than the kindred idioms, e.g., Old Persian *abara*, Sanskrit *abharat*, Zend *abarât*, *êpepe*; nominative *bagâ*, root-form *bagâ-s*, Sanskrit

<sup>3</sup> Grammar by Spiegel (Leipzig, 1867); Dictionary by Justi (Leipzig, 1864); edition of the *Avesta* by Westergaard (Copenhagen, 1853), translation into German by Spiegel (Leipzig, 1853), and into English by Darmesteter (Oxford, 1880) in the *Sacred Books of the East*.

<sup>4</sup> And perhaps of the Medes. Although we have no record of the Median language, we cannot regard it as differing to any great extent from the Persian. The Medes and Persians were two closely-connected races. There is nothing to justify us in looking for the true Median language either in the cuneiform writings of the second class or in Zend.

<sup>5</sup> "Ormuzd, who created this earth and that heaven, who created man and man's dwelling-place, who made Darius king, the one and only king of usay."



*Magas*. The differences in declension between Old Persian and Zend are unimportant.

Old Persian inscriptions are written in the cuneiform character of the simplest form, known as the "first class." Most of the inscriptions have besides two translations into the more complicated kinds of cuneiform character of two other languages of the Persian empire. One of these is the Assyrian; the real nature of the second is still a mystery. The interpretation of the Persian cuneiform, the character and dialect of which were equally unknown, was begun by Grotefend, who was followed by Burnouf, Rawlinson, and Oppert. The ancient Persian inscriptions have been collected in a Latin translation with grammar and glossaries by Spiegel (Leipzig, 1862). The other ancient tongues and dialects of this family are known only by name; we read of peculiar idioms in Sogdiana, Zabulistan, Herat, &c. It is doubtful whether the languages of the Scythians, the Lydians, and the Lydians, of which hardly anything remains, were Iranian or not.

After the fall of the Achæmenians there is a period of five centuries, from which no document of the Persian language has come down to us.

Under the Arsacids Persian nationality rapidly declined; all that remains to us from that period—namely, the inscriptions on coins—is in the Greek tongue. Only towards the end of the Parthian dynasty and after the rise of the Sasanians, under whom the national traditions were again cultivated in Persia, do we recover the lost traces of the Persian language in the Pahlavi inscriptions and literature.

3. *Middle Persian*.—The singular phenomena presented by Pahlavi writing have been discussed in a separate article (see PAHLAVI). The language which it disguises rather than expresses—Middle Persian, as we may call it—presents many changes as compared with the Old Persian of the Achæmenians. The abundant grammatical forms of the ancient language are much reduced in number; the case-ending is lost; the noun has only two inflexions, the singular and the plural; the cases are expressed by prepositions, —e.g., *râdân* (the soul), nom. and acc. sing., plur. *râdânân*; dat. *ai* or *ae* *râdân*, abl. *maî* or *as* *râdân*. Even distinctive forms for gender are entirely abandoned, e.g., the pronoun *ae* signifies "he," "she," "it." In the verb compound forms predominate. In this respect Middle Persian is almost exactly similar to New Persian.

4. *New Persian*.—The last step in the development of the language is New Persian, represented in its oldest form by Firdausi. In grammatical forms it is still poorer than Middle Persian; except English, no Indo-European language has so few inflexions, but this is made up for by the subtle development of the syntax. The structure of New Persian has hardly altered at all since the *Sâdnâm*; but the original purism of Firdausi, who made every effort to keep the language free from Semitic admixture, could not long be maintained. Arabic literature and speech exercised so powerful an influence on New Persian, especially on the written language, that it could not withstand the admission of an immense number of Semitic words. There is no Arabic word which would be refused acceptance in good Persian. But, nevertheless, New Persian has remained a language of genuine Iranian stock.

Among the changes of the sound system in New Persian, as contrasted with earlier periods, especially with Old Persian, the first that claims mention is the change of the tenues *k, t, p, c*, into *g, d, b, z*. Thus we have—

<i>Old Persian or Zend.</i>	<i>Pahlavi.</i>	<i>New Persian.</i>
<i>mahrta</i> (death)	<i>mark</i>	<i>mar</i>
<i>Thraštâna</i>	<i>Frštan</i>	<i>Furštan</i>
<i>âp</i> (water)	<i>âp</i>	<i>âb</i>
<i>hvatô</i> (self)	<i>khô</i>	<i>khôd</i>
<i>râncak</i> (day)	<i>rôj</i>	<i>rûs</i>
<i>haca</i>	<i>âj</i>	<i>az</i>

A series of consonants often disappear in the spirant; thus—

<i>Old Persian or Zend.</i>	<i>Pahlavi.</i>	<i>New Persian.</i>
<i>kaufâ</i> (mountain)	<i>kof</i>	<i>kôh</i>
<i>gâthû</i> (place), <i>Z. gâtu</i>	<i>gâs</i>	<i>gâh</i>
<i>cahvare</i> (four)	.....	<i>châr</i>
<i>bandaka</i> (slave)	<i>bandak</i>	<i>bandah</i>
<i>spâda</i> (army)	.....	<i>sipâh</i>
<i>dâdâmi</i> (I give)	.....	<i>dâham</i>

Old *â* and *âh* frequently become *y*—

<i>Old Persian or Zend.</i>	<i>Pahlavi.</i>	<i>New Persian.</i>
<i>madhu</i> (wine)	.....	<i>mai</i>
<i>baodôh</i> (consciousness)	<i>bôd</i>	<i>bôt</i>
<i>pâtha</i> (foot)	.....	<i>pâi</i>
<i>kadha</i> (when)	.....	<i>kai</i>

Old *y* often appears as *j*: Zend *yama* (*glass*), New Persian *jâm*; *yavana* (a youth), New Persian *javân*. Two consonants are not allowed to stand together at the beginning of a word; hence vowels are frequently inserted or prefixed, e.g., New Persian *siddâan* or *istâdan* (to stand), root *stâ*; *birdâdar* (brother), Zend and Pahlavi *brdâr*.<sup>1</sup>

<sup>1</sup> Grammars of New Persian, by Lumsden (Calcutta, 1820), Chodzko (Paris, 1852), Vullers (Glossen, 1870). For the New Persian dialects see Fr. Müller, in the *Sitzungsber. der Wien. Acad.*, vols. Lxxvii, Lxxviii.

Amongst modern languages and dialects other than Persian which must be also assigned to the Iranian family may be mentioned—

1. *Kurdish*, a language nearly akin to New Persian, with which it has important characteristics in common. It is chiefly distinguished from it by a marked tendency to shorten words at all costs, e.g., Kurd *berd* (brother) = New Persian *birdâdar*; Kurd. *dâm* (I give) = New Persian *dâham*; Kurd. *spt* (white) = New Persian *sipâd*.

2. *Baluch*, the language of Beluchistan, also very closely akin to New Persian, but especially distinguished from it in that all the old spirants are changed into explosives, e.g., Baluch *odh* (sleep) = Zend *haftna*; Baluch *kap* (slime) = Zend *kafsa*, New Persian *kaf*; Baluch *hapt* (seven) = New Persian *haft*.

3. *Ossetic*, true Iranian, in spite of its resemblance in sound to the Georgian.<sup>2</sup>

4. *Afghan*, which has certainly been increasingly influenced by the neighbouring Indian languages in inflexion, syntax, and vocabulary, but is still at bottom a pure Iranian language, not merely intermediate between Iranian and Indian.

The position of *Armenian* alone remains doubtful. Some scholars attribute it to the Iranian family; others prefer to regard it as a separate and independent member of the Indo-European group. Many words that at first sight seem to prove its Iranian origin are only adopted from the Persian.<sup>3</sup> (K. G.)

SECTION II.—MODERN PERSIAN LITERATURE.

Persian historians are greatly at variance about the origin of their national poetry. Most of them go back to the 5th Christian century and ascribe to one of the Sasanian kings, Bahrâmgûr or Bahrâm V. (420-439), the invention of metre and rhyme; others mention as author of the first Persian poem a certain Abulhafâ of Soghd, near Samarkand. In point of fact, there is no doubt that the later Sasanian rulers fostered the literary spirit of their nation (see PAHLAVI). Pahlavi books, however, fall outside of the present subject, which is the literature of the idiom which shaped itself out of the older Persian speech by slight modifications and a steadily increasing mixture of Arabic words and phrases in the 9th and 10th centuries of our era, and which in all essential respects has remained the same for the last thousand years. The national spirit of Iran, although smothered and stifled by the Arab conquest, could not be entirely annihilated. The system of centralization was at no time very strong in the extensive dominions of the Omayyad and 'Abbâsid dynasties; and the more their power and influence decayed the more they lost their hold on Persia, especially since the native element began to aspire to governorships and to take the political management into its own hand. The death of Hârun al-Rashîd in the beginning of the 9th century, which marks the commencement of the decline of the caliphate, was at the same time the starting-point of movements for national independence and a national literature in the Iranian dominion, and the common cradle of the two was in the province of Khorâsan, between the Oxus and Jaxartes. In Merv, a Khorâsânian town, a certain 'Abbâs composed in 809 A.D. (193 A.H.), according to the oldest biographical writer of Persia, Mohammed Aulf, the first real poem in modern Persian, in honour of the 'Abbâsid prince Ma'mûn, Hârun al-Rashîd's son, who had himself a strong predilection for Persia, his mother's native country, and was, moreover, thoroughly imbued with the freethinking spirit of his age. Soon after this, in 820 (205 A.H.), Tâhir, who aided Ma'mûn to wrest the caliphate from his brother Amîn, succeeded in establishing the first semi-independent Persian dynasty in Khorâsan, which was overthrown in 872 (259 A.H.) by the family of the Şeffârids, founded by Ya'kûb b. Laith, originally a brazier in Sistân or Zabulistan.

The development of Persian poetry under these first native dynasties was slow. Arabic language and literature had gained too firm a footing to be supplanted at once

<sup>2</sup> Compare Hübschmann, in Kuhn's *Zeitschrift*, xxiv. 396.  
<sup>3</sup> Compare P. de Lagarde, *Armenische Studien* (Göttingen, 1877); H. Hübschmann, *Armenische Studien* (Leipzig, 1888).

by a new literary idiom still in its infancy; nevertheless the few poets who arose under the Tahirids and Saffarids show already the germs of the characteristic tendency of all later Persian literature, which aims at amalgamating the enforced spirit of Islamism with their own Aryan feelings, and reconciling the strict deism of the Mohammedan religion with their inborn loftier and more or less pantheistic ideas; and we can easily trace in the few fragmentary verses of men like Hanzalah, Hakim Firds, and Abū Saif those principal forms of poetry now used in common by all Mohammedan nations—the forms of the *kašida* (the encomiastic, elegiac, or satirical poem), the *ghazal* or ode (a love-ditty, wine-song, or religious hymn), the *rubāʿī* or quatrain (our epigram, for which the Persians invented a new metre in addition to those adopted from the Arabs), and the *mathnawī* or double-rhymed poem (the legitimate form for epic and didactic poetry). The first who wrote such a *mathnawī* was Abū Shukr of Balkh, the oldest literary representative of the third dynasty of Khorāsān, the Sāmānids, who had been able in the course of time to dethrone the Saffarids, and to secure the government of Persia, nominally still under the supremacy of the caliphs in Baghdād, but in fact with full sovereignty. The undisputed reign of this family dates from the accession of Amīr Naṣr II. (913-942; 301-331 A.E.), who, more than any of his predecessors, patronised arts and sciences in his dominions. The most accomplished minstrels of his time were Mohammed Farāldī; Abū ʿAbbās of Bokhārā, a writer of very tender verses; Abū ʿMuṣaffar Naṣr of Nīshāpūr; Abū ʿAbdallāh Mohammed of Junaid, equally renowned for his Arabic and Persian poetry; Maʿnawī, full of original thoughts and spiritual subtleties; Khusrāwānī, from whom even Firdausi condescended to borrow quotations; Abū ʿḤasan Shahīd of Balkh, the first who made a *diwān* or alphabetical collection of his lyrics; and Master Rūdāgī, the first classic genius of Persia, who impressed upon every form of lyric and didactic poetry its peculiar stamp and individual character (see RŪDĀGĪ). His graceful and captivating style was imitated by Hakim Khabbās, a great baker, poet, and quack; Abū Shuʿaib Ṣāliḥ of Herāt, who left a spirited little song in honour of a young Christian maiden; Raunaḳī of Bokhārā; Abū ʿFath of Bust, who was also a good Arabic poet; the amīr Abū ʿḤasan ʿAlī Alagāṭchī, who handled the pen as skilfully as the sword; ʿUmārah of Merv, a famous astronomer; and Kisāʿī, a native of the same town, a man of stern and ascetic manners, who sang in melodious rhythm the praise of ʿAlī and the twelve imāms. All these poets flourished under the patronage of the Sāmānid princes, who also fostered the growing desire of their nation for historical and antiquarian researches, for exegetical and medical studies. Manṣūr I., the grandson of Rūdāgī's patron, ordered (963; 352 A.E.) his waṣīr Balʿamī to translate the famous universal history of Tabarī (224-310 A.E.) from Arabic into Persian; and this *Tārīkh-i-Tabarī*, the oldest prose work in modern Persian, is not merely remarkable from a philological point of view, it is also the classic model of an easy and simple style. The same prince employed the most learned among the ulemā of Transoxiana for a translation of Tabarī's second great work, the *Tafsīr*, or commentary on the Koran, and accepted the dedication of the first Persian book on medicine, a pharmacopœia by the physician Abū Manṣūr Muwaffaq b. ʿAlī of Herāt (edited by Seligmann, Vienna, 1859), which forms a kind of connecting link between Greek and Indian medicine. It was soon after further developed by the great Avicenna (died 1037; 428 A.E.), himself a Persian by birth, and author of pretty wine-songs, moral maxims, psychological tracts, and a manual of philosophic science, the *Dāwānāmā-i-ʿAlī*, in his native tongue.

A still greater impulse was given, both to the patriotic feelings and the national poetry of the Persians, by Manṣūr's son and successor, Prince Nūḥ II., who ascended the throne in 976 (365 A.E.). Full of enthusiasm for the glorious past of the old Iranian kingdom, he charged his court poet Dakīqī, who openly professed in his *ghazals* the Zoroastrian creed, to turn the Parsi collection of the venerable legends and traditions of the heroic ages of Iran, the *Khodāʾnāma*, or "Book of Kings" (which had been translated from the Pahlavi under the Saffarid Yaʿqūb b. Laith), into Persian verse. Shortly after commencing this work Dakīqī was murdered in the prime of life; and the fall of the minstrel was soon followed by that of the Sāmānid dynasty itself, which was supplanted by the younger and more vigorous house of Sabuktāgīn, the founder of the Ghasnawids, who had rapidly risen from the rank of a common Turkish soldier to that of an independent ruler of Ghama (Ghazni, Ghuznee) and all the surrounding countries, including a considerable portion of India. But Dakīqī's great enterprise was not abandoned; a stronger hand, a higher genius, was to continue and to complete it, and this genius was found in Firdausi (940-1020; 328-411 A.E.), with whom we enter the golden age of the national epopee in Persia (see FIRDAŪSĪ). In 1011, after thirty-five years of unremitting labour, he accomplished his gigantic task, and wrote the last distichs of the immortal *Shāhnāma*, that "glorious monument of Eastern genius and learning," as Sir W. Jones calls it, "which, if ever it should be generally understood in its original language, will contest the merit of invention with Homer itself." And, although it was not he, the unrivalled master of epic art, but his old friend and patron, the less-renowned ʿUnṣurī, who officiated as "king of poets" in the court of Maḥmūd of Ghama (998-1030; 388-421 A.E.), who had continued his father Sabuktāgīn's conquests, and founded an empire extending from the Caucasus to Bengal and from Bokhārā and Kaahgar to the Indian Ocean, he was nevertheless the central sun round which all the minor stars revolved, those four hundred poets who formed the famous "Round Table" in the sultan's magnificent palace. Firdausi's fame eclipsed that of all his contemporaries (however well founded their claim upon literary renown),—men like ʿUnṣurī, Farrukhī, Asjadi, Ghadāʾirī, Minūṭchehrī, and others, whose eloquent praises of Maḥmūd have come down to us in very scarce copies, and even that of his own teacher Asadi, who survived his great pupil, and established a reputation of his own by introducing into Persian literature the novel form of the *masnawī* or strife-poem, the equivalent of the Provençal *tenson* and the English *estraf* or *joust*. The *Shāhnāma*, from the very moment of its appearance, exercised such an irresistible fascination upon all minds that there was soon a keen competition among the younger poets as to who should produce the most successful imitation of that classic model; and this competition has gone on under different forms through all the following centuries, even to the most recent times. First of all, the old popular traditions, so far as they had not yet been exhausted by Firdausi, were ransacked for new epic themes, and a regular cycle of national epopees gathered round the *Book of Kings*, drawn almost exclusively from the archives of the princes of Sistān, the family of Firdausi's greatest hero, Rustam. The first and most ambitious of these competitors seems to have been Asadi's own son, ʿAlī b. Ahmad al-Asadi, the author of the oldest Persian glossary, who completed in 1066 (458 A.E.), in upwards of 9000 distichs, the *Garahāspnāma*, or marvellous story of the warlike feats and love-adventures of Garahāsp, one of Rustam's ancestors. The heroic deeds of Rustam's grandfather were celebrated in the *Sāsnāma*, which almost equals the *Shāhnāma* in length; those of Rustam's two sons, in the *Jahāngīrnāma* and the *Far-*

*surmāna*; those of his daughter, an amazon, in the Brunhild style of the German Nibelunge, in the *Bāst Gushāpānāma*; those of his grandson, in the *Barrānāma*; those of his great-grandson, in the *Shahriyārānāma* (ascribed to Mukhtār and dedicated to Mas'ūd Shāh, who is probably identical with Mas'ūd b. Ibrāhīm, Sultan Mahmūd's great-grandson, 1088-1114; 481-508 A.H.); and the wonderful exploits of a son of Isfandi-yār, another hero of the *Shāh-nāma*, in the *Bakmānāma*.

When at last these old Iranian sources were almost entirely exhausted, the difficulty was met in various but equally ingenious ways. Where some slight historical records of the heroic age—no matter how doubtful their authenticity—were still obtainable, poetical imagination seized upon them at once, and filled the wide gaps by its own powerful invention; where no traditions at all were forthcoming, fiction pure and simple asserted its indisputable right; and thus the national epopee gave way to the epic story, and—substituting prose for verse—to the novel and the fairy tale. Models of the former class are the various *Iskandar-nāmas*, or "Books of Alexander the Great," the oldest and most original of which is that of Nizāmī (completed about 1202; 599 A.H.); the latter begins with the *Kutb-i-Samak 'Iyār*, a novel in three volumes (about 1189; 585 A.H.), and reaches its climax in the *Bāstān-i-Khayāl*, or "Garden of Imagination," a prose romance of fifteen large volumes, by Mohammed Taqi Khayāl, written between 1742 and 1756 (1155 and 1169 A.H.). Many aspirants to poetical fame, however, were not satisfied with either of these expedients: they boldly struck out a new path and explored hitherto unknown regions, and here again a twofold tendency manifested itself. Some writers, both in prose and verse, turned from the exhausted fields of the national glory of Persia to the comparatively original soil of Arabian traditions, and chose their subjects from the chivalrous times of their own Bedouin conquerors, or even from the Jewish legends of the Koran. Of this description are the *Anbiyānāma*, or history of the pre-Mohammedan prophets, by Hasanī Shabistārī 'Ayānī (before the 8th century of the Hijra); Ibn Husām's *Kāwār-nāma* (1427; 830 A.H.), or the deeds of 'Alī; Bādhill's *Hamla-i-Haidarī*, which was completed by Najaf (1723; 1135 A.H.), or the life of Mohammed and the first four caliphs; Kāsim's *Farāh-nāma-i-Fātima*, the book of joy of Fātima, Mohammed's daughter (1737; 1150 A.H.),—all four in the epic metre of the *Shāh-nāma*; and the prose stories of *Hādim Jāfī*, the famous model of liberality and generosity in pre-Islamic times; of *Amir Hamsak*, the uncle of Mohammed; and of the *Mu'jizat-i-Mūsawī*, or the miraculous deeds of Moses, by Mu'in-almiakin (died about 1501; 907 A.H.).

Quite a different turn was taken by the ambition of another class of imitators of Firdausī, especially during the last four centuries of the Hijra, who tried to create a new heroic epopee by celebrating in rhythm and rhyme stirring events of recent date. The gigantic figure of Timūr inspired Hātifī (died 1521; 927 A.H.) with his *Tīmūr-nāma*; the stormy epoch of the first Safawī rulers, who succeeded at last in reuniting for some time the various provinces of the old Persian realm into one great monarchy, furnished Kāsim' died after 1560; 967 A.H.) with the materials of his *Shāh-nāma*, a poetical history of Shāh Isma'īl and Shāh Tahmāsp. Another *Shāh-nāma*, celebrating Shāh 'Abbās the Great, was written by Kamālī of Sebzar; and even the cruelties of Nādir Shāh were duly chronicled in a pompous epic style in 'Isratī's *Shāh-nāma-i-Nādirī* (1749; 1162 A.H.). But all these poems are surpassed in length by the 33,000 distichs of the *Shāhīnshāh-nāma* by the poet-laureate of the late Feth 'Alī Shāh of Persia, and the 40,000 distichs of the *Georgenāma*, a poetical history of India from its discovery by the Portuguese to the conquest

of Poonah by the English in 1817. In India especially this kind of epic versification has flourished since the beginning of Humāyūn's reign (1530-1556); the court-poets of the great Mogul emperors of Delhi, as well as of all the minor dynasties, vied with one another in glorifying the exploits of their respective sovereigns, as is sufficiently proved by the *Zafar-nāma-i-Shāhjahānī* by Kudāī (died 1646; 1056 A.H.); the *Shāhīnshāh-nāma* by Talīb Kalīm (died 1651; 1061 A.H.), another panegyrist of Shāh Jahān; *Ātash's 'Adīb-nāma*, in honour of Shāh Mohammed 'Ādil of Bijāpūr, who ascended the throne in 1629 (1039 A.H.); the *Tawārīkh-i-Kutb Kāshānī*, a metrical history of the Kūsh āhābs of Golkonda; and many more, down to the *Fāh-nāma-i-Tipū Sulṭān* by Ghulām Hasan (1784; 1189 A.H.).

But the national epopee, with both its legitimate and its illegitimate offspring, was not the only bequest the great Firdausī left to his nation. This rich genius gave also the first impulse to the higher development of those other branches of poetical art which were to flourish in the following ages—particularly to *romantic, didactic, and mystic poetry*; and even his own age produced powerful co-operators in these three most conspicuous departments of Persian literature. *Romantic fiction*, which achieved its highest triumph in Nizāmī of Ganja's (1141-1203; 535-599 A.H.) brilliant pictures of the struggles and passions in the human heart (see NIZĀMĪ, vol. xvii. pp. 521, 522), sent forth its first tender shoots in the numerous love-stories of the *Shāh-nāma*, the most fascinating of which is that of Zal and Rūdabeh, and developed almost into full bloom in Firdausī's second great mathnawī *Yāsūf u Zākīkā*, which the aged poet wrote after his flight from Ghazna, and dedicated to the reigning caliph of Baghdād, Alkādīr-billāh. It represents the oldest poetical treatment of the Biblical story of Joseph, which has proved so attractive to the epic poets of Persia, among others to 'Amāk of Bokhārā (died 1149), who was the first after Firdausī to write a *Yāsūf u Zākīkā* (which can be read in two different metres), to Jāmī (died 1492), Maujī Kāsim Khān, Humāyūn's amīr (died 1571), Nāzīm of Herāt (died 1670), and Shaukat, the governor of Shirās under Feth 'Alī Shāh. Perhaps prior in date to Firdausī's *Yāsūf* was his patron 'Ungurī's romance *Wāmīk u Adhrā*, a popular Iranian legend of great antiquity, which had been first written in verse under the Tāhirid dynasty. This favourite story was treated again by Fāstī Jurjānī (in the course of the same 5th century of the Hijra), and by many modern poets,—as Damīrī, who died under the Safawī Shāh Mohammed (1577-1586; 985-994 A.H.), Nāmī, the historiographer of the Zand dynasty, and Husān of Shirās under Feth 'Alī Shāh, the last two flourishing towards the beginning of the present century. Another love-story of similar antiquity, which had originally been written in Pahlavī, formed the basis of Fakhr-uddīn As'ad Jurjānī's *Wis u Rāmīs*, which was composed in Isfahān (Ispahān) about 1048 (440 A.H.),—a poem remarkable not only for its high artistic value but also for its close resemblance to one of the epic masterpieces of mediæval German literature, Gottfried von Strasburg's *Tristan und Isolde*.

The last-named Persian poet was apparently one of the earliest eulogists of the Seljūks, and it was under this Turkish dynasty, which soon became a formidable rival both of the Ghazawīds and of the Arabian caliphs of Baghdād, that lyrical romanticism—that is, panegyric and satirical poetry—rose to the highest pitch. What Firdausī, in his exalted descriptions of royal power and dignity, and the court-poets of Sultan Mahmūd, in their unbounded praise of the great sovereign and protector of arts, had commenced, what other encomiasts under Mahmūd's successors—for instance, Abū 'l-Faraj Rūmī of Lahore and Mas'ūd b. Sa'd b. Salmān (under Sultan

Ibrāhīm, 1059-1088)—had successfully continued, reached its perfection in the famous group of panegyrists who gathered in the first half of the 6th century of the Hijra round the throne of Sultan Sanjar, and partly also round that of his great antagonist, Atsiz, shāh of Khwārizm. This group included Adīb Šābir, who was drowned by order of the prince in the Oxus about 1145 (540 A.H.), and his pupil Jauharī, the goldsmith of Bokhāra; Amīr Mu'izzī, the king of poets at Sanjar's court, killed by a stray arrow in 1147 (542 A.H.); Rašīd Waṭwāt (the Swallow), who died in 1172 (568 A.H.), and left, besides his *kaḡidas*, a valuable treatise on poetry (*Ḥaḡid-ih-essīr*) and a metrical translation of the sentences of 'Alī; 'Abd-al-wāsi' Jabālī, who sang at first, like his contemporary Ḥasan Ghasnawī (died 1169; 565 A.H.), the praise of the Ghaznawid shāh Bahrām, but afterwards bestowed his eulogies upon Sanjar, the conqueror of Ghazna; and Aḥmad-uddīn Anwarī, the most celebrated *kaḡida*-writer of the whole Persian literature. Anwarī (died between 1191 and 1196; 587 and 592 A.H.), who in early life had pursued scientific studies in the madrasah of Tūs and who ranked among the foremost astronomers of his time, owes his renown as much to the inexhaustible store of poetical similes and epithets ornamenting which he showered upon Sanjar and other royal and princely personages as to his cutting sarcasms, which he was careful enough to direct, not against special individuals, but against whole classes of society and the cruel wrongs worked by an inexorable fate,—thus disregarding the more manly example of Firdausī, whose bold attack upon Suṭān Mahmūd for having cheated him out of the well-earned reward for his epopee is the oldest and, at the same time, most finished specimen of personal satire. This legitimate branch of high art, however, soon degenerated either into the lower forms of parody and travesty—for which, for instance, a whole group of Transoxanian writers, Sūzānī of Samarqand (died 1174; 569 A.H.) and his contemporaries, Abū 'Alī Shatrānjī of the same town, Lāmī of Bokhāra, and others gained a certain literary reputation—or into mere comic pieces and jocular poems like the "Pleasantries" (*Ḥasīyyāt*) and the humorous stories of the "Mouse and Cat" and the "Stone-cutter" (*Samtārak*) by 'Ubaid Zakānī (died 1370; 772 A.H.). Anwarī's greatest rival was Khāḡānī (died 1199; 595 A.H.), the son of a carpenter in Shīrwān, and panegyrist of the shāhs of Shīrwān, usually called the Pindar of the East on account of the difficult and enigmatic style of his verses. Oriental critics, of course, greatly admire the obscure allusions, far-fetched puns, and other eccentricities with which the otherwise energetic and harmonious language, both of his laudatory odes and of his satires, is loaded; to European taste only the shorter epigrams and the double-rhymed poem *Tuḡyat-ush-shāhin*, in which Khāḡānī describes his journey to Mecca and back, give full satisfaction. Among his numerous contemporaries and followers may be noticed Muḡīr-uddīn Baīlāḡānī (died 1198; 594 A.H.), Zāhir Faryābī (died 1202; 598 A.H.), and Athīr Akḡaḡatī (died 1211; 608 A.H.),—all three panegyrists of the atābāgs of Adharbaijān (Azerbijan), and especially of Sultan Kizil Arslan—Kamāl-uddīn Isfahānī, tortured to death by the Moguls in 1237 (635 A.H.), who sang, like his father Jamāl-uddīn, the praise of the governors of Isfahān, and gained, on account of his fertile imagination, the honorary epithet of the "creator of fine thoughts" (*Khallāḡ-ul-mā'ānī*); and Saif-uddīn Isfarāngī (died 1267; 666 A.H.), a favourite of the shāhs of Khwārizm.

Fruitful as the 6th and 7th centuries of the Hijra were in panegyrics, their literary fame did not rest upon these alone; they attained an equally high standard in two other branches of poetry, the didactic and the mystic, which after a short period of separate existence entered into a close and henceforth indissoluble union. The origin of

both can again be traced to Firdausī and his time. In the ethical reflexions, wise maxims, and moral exhortations scattered throughout the *Shāhnāma* the didactic element is plainly visible, and equally plain in it are the traces of that mystical tendency which was soon to pervade almost all the literary productions of Persian genius. Šūfī pantheism, which tends to reconcile philosophy with revealed religion, and centres in the doctrine of the universality and absolute unity of God, who is diffused through every particle of the visible and invisible world, and to whom the human soul during her temporary exile in the prison-house of the body strives to get back through progressive stages till she is purified enough to be again absorbed in Him, is already hinted at in the numerous verses of the "Book of Kings" in which the poet cries out against the vanity of all earthly joys and pleasures, and expresses a passionate desire for a better home, for a reunion with the Godhead. But the most characteristic passage of the epopee is the mysterious disappearance of Shāh Kaikhosrau, who suddenly, when at the height of earthly fame and splendour, renounces the world in utter disgust, and, carried away by his fervent longing for an abode of everlasting tranquillity, vanishes for ever from the midst of his companions. The first Persian who devoted poetry exclusively to the illustration of Šūfī doctrines was Firdausī's contemporary, the renowned sheikh Abū Sa'īd b. Abū 'l-Khair of Mahna in Khorāsān (968-1049; 357-440 A.H.), the founder of that specific form of the rubā'ī which gives the most concise expression to religious and philosophic aphorisms,—a form which was further developed by the great freethinker 'OMAR B. KHAYYĀM (q.v.), and Fādal-uddīn Kāshī (died 1307; 707 A.H.). The year of Abū Sa'īd's death is most likely the same which gave to the world the first great didactic mathnawī, the *Rūshān-nāma*, or "Book of Enlightenment," by NĀṢIR B. KHOSRAU (q.v.), a poem full of sound moral and ethical maxims with slightly mystical tendencies. About twenty-five years later the first theoretical handbook of Šūfīsm in Persian was composed by 'Alī b. 'Uthmān al-jullābī al-hujwīrī in the *Kaḡf-ul-maḡhīb*, which treats of the various schools of Šūfīs, their teachings and observances. A great saint of the same period, Sheikh 'Abdallāh Anḡārī of Herāt (1006-1089; 396-481 A.H.), assisted in spreading the pantheistic movement by his *Munāḡāt* or invocations to God, by several prose tracts, and by an important collection of biographies of eminent Šūfīs, based on an older Arabic compilation, and serving in its turn as groundwork for Jāmī's excellent *Nafahāt-ulsunā* (completed in 1478; 883 A.H.). He thus paved the way for the publication of one of the earliest text-books of the whole sect, the *Ḥadīḡat-ul-ḡhabīḡat*, or "Garden of Truth" (1130; 525 A.H.), by Ḥakīm Sanā'ī of Ghazna, to whom all the later Šūfī poets refer as their unrivalled master in spiritual knowledge. In this extensive mathnawī in ten cantos, as well as in his smaller poetical productions, he skillfully blended the purely didactic element, which is enhanced by pleasant stories and anecdotes, with the chief tenets of higher theosophy,—an example which has been strictly adhered to by all the following Šūfī poets, who only differ in so far as they give preponderance either to the ethical or to the mystical side of their writings. As the most uncompromising Šūfīs appear the greatest pantheistic writer of all ages, Jelāl-uddīn Rūmī (1207-1273; 604-672 A.H.; see RŪMĪ), and his scarcely less renowned predecessor Farīd-uddīn 'Aṭṭār, who was slain by the Moguls at the age of 114 lunar years in 1230 (627 A.H.). This prolific writer, originally a druggist ('aṭṭār) in Nishāpūr, after having renounced all worldly affairs and performed the pilgrimage to Mecca, devoted himself to a stern ascetic life, and to the composition of Šūfī works, partly in prose, as in his valuable "Biography of eminent Mystic Divines," but mostly in the form of math-

nawis (upwards of twenty in number), among which the *Pandnāma*, or "Book of Counsels," and the *Mantik-uffair*, or the "Speeches of Birds," occupy the first rank. In the latter, an allegorical poem, interspersed with moral tales and pious contemplations, the final absorption of the Šūfi in the deity is most ingeniously illustrated, and the seven valleys through which the birds travel on their way to the fabulous phoenix or *sīmurǧ* (literally thirty birds), and in which all except thirty succumb, are the seven stations of the mystic road that leads from earthly troubles into the much-coveted *Faná* or *Nirvāna*.

In strong contrast to these advanced Šūfis stands the greatest moral teacher of Persia, Sheikh Sa'dī of Šhīrāz (died about 110 lunar years old in 1292; 691 A.H.; see Sa'dī), whose two best known works, the *Būstān*, or "Fruit-garden," and the *Gulistān*, or "Rose-garden," owe their great popularity both in the East and the West to the purity of their spiritual thoughts, their sparkling wit, charming style, and the very moderate use of mystic theories. However, both have found comparatively few imitations,—the former in the *Dastūr-nāma* of Nizārī of Kohistān (died 1320; 720 A.H.), in the *Dah Bāb*, or "Ten Letters," of Kātibī (died 1434; 838 A.H.), and in the *Gulzar* of Hairatī (murdered 1554; 961 A.H.); the latter in Mu'īn-uddīn Juwainī's *Nigāristān* (1335; 735 A.H.) and Jāmī's *Bahāristān*, or "Spring-garden" (1487; 892 A.H.); whereas an innumerable host of purely Šūfic compositions followed in the wake of Sanā'ī's, Aṭṭār's, and Jelāl-uddīn Rūmī's mathnawis. They consist partly of mere expositions of doctrines with or without illustrations by tales and anecdotes, partly of complete Šūfic allegories, often disfigured by the wildest eccentricities. It will suffice to name a few of the most conspicuous in each class. To the former belong the *Lama'āt*, or "Sparks," of Irāki (died between 1287 and 1309; 686 and 709 A.H.), the *Zād-ul-musafirin*, or "Store of the Wayfarers," by Ḥusainī (died 1318; 718 A.H.), the *Gulshan-i-Rāz*, or "Rose-bed of Mystery," by Maḥmūd Shabistari (died 1320; 720 A.H.), the *Jām-i-Jam*, or "Cup of Jamahid," by Anḥadī (died 1338; 738 A.H.), the *Ans-ul-'Arifin*, or "Friend of the Mystics," by Kāsim-i-Anwār (died 1434; 837 A.H.), and others; to the latter 'Asār's *Mīhr u Muhtārī*, or "Sun and Jupiter" (1376; 778 A.H.), 'Arīf's *Gūi u Changān*, or "The Ball and the Bat" (1438; 842 A.H.), *Ḥuṣn u Dil*, or "Beauty and Heart," by Fattāḥī of Nishāpūr (died 1448; 852 A.H.); *Šam' u Parwana*, or "The Candle and the Moth," by Ahlī of Šhīrāz (1489; 894 A.H.), *Shāh u Gada*, or "King and Dervish," by Hilālī (put to death 1532; 939 A.H.), Bahā-uddīn 'Amīlī's (died 1621; 1030 A.H.) *Nān u Ḥalwā*, or "Bread and Sweets," *Šīr' u Šakar*, or "Milk and Sugar," and many more.

During all these periods of literary activity, lyric poetry, pure and simple—i.e., the ghazal, in its legitimate form—had by no means been neglected; almost all the renowned poets since the time of Rūdagi had sung in endless strains the pleasures of love and wine, the beauties of nature, and the almighty power of the Creator; but, however rich the ghazals of Sa'dī in lofty thoughts and pious feelings, how-  
ever sublime the hymns of Jelāl-uddīn Rūmī, it was left to the incomparable genius of Hāfiz (died 1389; 791 A.H.; see HAFIZ) to give to the world the most perfect models of lyric composition; and the lines he had laid down were more or less strictly followed by all the ghazal-writers of the 9th and 10th centuries of the Hijra,—by Salmān of Sāwa (died about 1377; 779 A.H.), who excelled besides in *kašīda* and mathnawī; Kamāl Khujandī, Hāfiz's friend, and protégé of Sultan Ḥusain (776-784 A.H.); Mohammed Šhīrīn Maghribī (died at Tabriz in 1406; 809 A.H.), an intimate friend of Kamāl; Ni'mat-ullāh Wālī (died 1431; 834 A.H.), the founder of a special religious order; Kāsim-i-

Anwār (see above); Amīr Shāhī (died 1453; 857 A.H.), or the princely family of the Sarbadārs of Sabzawār; Bannā'ī (died 1512; 918 A.H.), who also wrote a romantic poem, *Bakrām u Bihriis*; Bābā Fighānī of Šhīrāz (died 1519; 925 A.H.), usually called the "Little Hāfiz"; Nargis (died 1531; 938 A.H.); Lisānī (died 1534; 941 A.H.), who himself was imitated by Damīrī of Isfahān, Muḥtasham Kāshī, and Wahshī Bāfīkī (all three<sup>d</sup> died in the last decade of the 10th century of the Hijra); Ahlī of Šhīrāz (died 1535; 942 A.H.), author of the *Sīhr-i-Halāl*, or "Lawful Witchcraft," which, like Kātibī's (died 1434; 838 A.H.) *Majma'-ul-bahras*, or the "Confluence of the Two Seas" can be read in two different metres; Nau'ī (died 1610; 1019 A.H.), who wrote the charming romance of a Hindu princess who burned herself in Akbar's reign with her deceased husband on the funeral pile, styled *Sūs u Guda*, or "Burning and Melting," &c. Among the immediate predecessors of Hāfiz in the 8th century of the Hijra, in which also Ibn Yamin, the great *kitāh*-writer,<sup>1</sup> flourished, the highest fame was gained by the two poets of Delhi, Amīr Ḥasan and Amīr Khosrau. The latter, who died in 1325 (725 A.H.), two years before his friend Ḥasan, occupies the foremost place among all the Persian poets of India by the richness of his imagination, his graphic style, and the historical interest attached to his writings. Five extensive *dīwāns* testify to his versatility in all branches of lyric poetry, and nine large mathnawis to his mastership in the epic line. Four of the latter are poetical accounts of contemporary events during the reigns of the emperors of Delhi, 'Alā-uddīn Mohammad Shāh Khiljī (1296-1311), his predecessor Firūz Shāh, and his successor Kutb-uddīn Mubārek Shāh,—the *Miftāḥ-ul-futūḥ*, or "Key of Mysteries," the *Kirān-ussa'dāin*, or "The Conjunction of the Two Lucky Planets," the *Nuh Sipihr*, or "Nine Spheres," and the love-story of *Khidrkhān u Duwalrānī*. His other five mathnawis formed the first attempt ever made to imitate Nizāmī's famous *Khamsah*, or five romantic epopees, and this attempt turned out so well that henceforth almost all epic poets wrote quintuples of a similar description. Khwājū Kirmānī (died 1352; 753 A.H.) was the next aspirant to Nizāmī's fame, with five mathnawis, among which *Humāsī u Humāyūn* is the most popular, but he had to yield the palm to 'Abd-urrahmān Jāmī (1414-1492; 817-898 A.H.), the last classic poet of Persia, in whose genius were summed up, as it were, all the best qualities of his great predecessors, and who combined, in a manner, the moral tone of Sa'dī with the lofty aspirations of Jelāl-uddīn Rūmī, and the graceful ease of Hāfiz's style with the deep pathos of Nizāmī, to whose *Khamsah* he wrote the most successful counterpart (see his *Yūsuf u Zalkhad* mentioned above). Equally renowned are his numerous prose works, mostly on Šūfic topics, and his three *dīwāns*. Many poets followed in Jāmī's footsteps, first of all his nephew Hātifī (see above), and either wrote whole *khamsahs* or imitated at least one or other of Nizāmī's epopees; thus we have a *Lailā u Majnūn*, for instance, by Maktabī (1490), Hilālī (see above), and Rūḥ-ulamīn (died 1637). But their efforts could not stop the growing corruption of taste, and it was only at the court of the Mogul emperors, particularly of the great Akbar (1556-1605), who revived Sultan Maḥmūd's "round table," that Persian literature still enjoyed some kind of "Indian summer" in poets like Ghazālī of Mashhad or Mehed (died 1572); 'Urī of Šhīrāz (died 1591), who wrote spirited *kašīdas*, and, like his contemporaries Wahshī and Kautharī, a mathnawī, *Farḥād u Šīrīn*; and Faidī (died 1595), the author of the romantic poem, *Nal u Damān*, who also imparted new life into the rubā'ī. In Persia proper

<sup>1</sup> A *kitāh* or *mukatta'ah* is a poem containing moral reflexions and differs from the *kašīda* and *ghazal* only by the absence of a *maṭla'* or initial distich.

only Zulâfi, whose clever romance of "Sultan Mahmûd and his favourite Ayâs" (1592) is widely read in the East, Sâ'ib (died 1677), who is commonly called the creator of a new style in lyric poetry, and, among the most modern, Hâfîz of Isfahân, the singer of sweet and tasteful odes (died about 1785), deserve a passing notice.

But we cannot conclude our brief survey of the national literature of Persia without calling attention to the rise of quite a novel form of Iranian poetry, the *drama*, which has only sprung up in the beginning of the present century. Like the Greek drama and the Mysteries of the European Middle Ages, it is the offspring of a purely religious ceremony, which for centuries has been performed annually during the first ten days of the month Moharrem,—the recital of mournful lamentations in memory of the tragic fate of the house of the caliph 'Alî, the hero of the Shi'itic Persians. Most of these passion-plays deal with the slaughter of 'Alî's son Hôsain and his family in the battle of Kербelâ. But lately this narrow range of dramatic subjects has been considerably widened; Biblical stories and even Christian legends have been brought upon the Persian stage; and there is a fair prospect of a further development of this most interesting and important movement.

In the various departments of general Persian literature, not touched upon in the foregoing pages, the same wonderful activity has prevailed as in the realm of poetry and fiction, since the first books on history and medicine appeared under the Sâmanids (see above). The most important section is that of historical works, which, although deficient in sound criticism and often spoiled by a highly artificial style, supply us with most valuable materials for our own research, especially when they relate contemporary events in which the authors took part either as political agents or as mere eye-witnesses. Quite unique in this respect are the numerous histories of India, from the first invasion of Sultan Mahmûd of Ghazna to the English conquest, and even to the first decades of the present century, most of which have been described and partly translated in the eight volumes of Elliot's *History of India* (1867-78). Persian writers have given us, besides, an immense variety of universal histories of the world, with many curious and noteworthy data (see, among others, Mirkhond's and Khwandamîr's works under Mirkhond, vol. xvi. p. 499); histories of Mohammed and the first caliphs, partly translated from Arabic originals, which have been lost; detailed accounts of all the Persian dynasties, from the Ghaznavids to the still reigning Kajars, of Jenghis Khân and the Moguls (in Juwainî's and Wassâf's elaborate *Tarîkh*), and of Timur and his successors (see an account of the *Zafarnâma* under PERSIANS CHRON.; histories of sects and creeds, especially the famous *Dabistân*, or "School of Manners" (translated by Troyer, Paris, 1843); and many local chronicles of Iran and Tûrân. Next in importance to history rank geography, cosmography, and travels (for instance, the *Nusbat-ul-Musâfir*, by Hamdallah Mustaufi, who died in 1349, and the translations of Isfakhri's and Kaswin's

Arabic works), and the various *tadhkiras* or biographies of Sûfis and poets, with selections in prose and verse, from the oldest of 'Aufi (about 1220) to the last and largest of all, the *Makhsûs-ul-shar'ûb*, or "Treasure of Marvellous Matters" (completed 1803), which contains biographies and specimens of more than 3000 poets. We pass over the well-stocked sections of philosophy, ethics, and politics, of theology, law, and Sûfism, of mathematics and astronomy, of medicine (the oldest thesaurus of which is the "Treasure of the shâh of Khwarizm," 1110), of Arabic, Persian, and Turkish grammar and lexicography, and only cast a parting glance at the rich collections of old Indian folk-lore and fables preserved in the Persian versions of *Kalîla's Dimnah* (see RÛDÂG), of the *Sindbâdnâma*, the *Tâ'îdnâma*, or "Tales of a Parrot," and others, and at the translations of standard works of Sanskrit literature, the epopees of the *Râmâyana* and *Mahâbhârata*, the *Bhagavad-Gîtâ*, the *Yoga-Vasistha*, and numerous *Purânas* and *Upanishads*, for which we are mostly indebted to the emperor Akbar's indefatigable zeal.

A complete history of Persian literature is still a desideratum. Hammer's *Schicksal der Persiens*, Vienna, 1818, is altogether unsatisfactory and obsolete. Concise sketches of Persian poetry are contained in Ouseley's *Biographical Notices*; in Flügel's article in Eruch and Gruber's *Allgemeine Encyclopædie* (1842); in Bland's papers in the *Journal of the Roy. Asiatic Society*, vol. vii. p. 345 sq. and vol. ix. p. 123 sq.; and in Barbier de Meynard's *Poésies Perses*, Paris, 1877. Real mines of information are the catalogues of Sprenger, Calcutta, 1854; Morley, London, 1854; Flügel, 3 vols., Vienna, 1868; and Rieu, 3 vols., London, 1879-82. For the first five centuries of the Hijra compare Ethé's editions and metrical translations of "Rûdâg's" *Vorläufer und Zeitgenossen*, in *Morgenländische Forschungen*, Leipzig, 1875; of Kisâ'i's songs, Firân's lyrics, and Abd Sa'îd b. Abd 'I-Khair's rubâ'is, in *Singungsberichte der bayr. Akademie* (1872, p. 375 sq.; 1873, p. 623 sq.; 1874, p. 133 sq.; 1875, p. 145 sq.; and 1878, p. 88 sq.); of Avicenna's Persian poems, in *Göttinger Nachrichten*, 1875, p. 555 sq.; and of Asadî and his munâzarât, in "Persische Tensonen," *Verhandlungen des 5ten Orientalisten-Congresses*, Berlin, 1882, part ii., first half, p. 48 sq.; *Zotenberg's Chronique de Tabari*, Paris, 1867-71; Jurjân's *Wu's u. Ramâs*, edited in the *Bibl. Indica*, 1864 (translated into German by Graf v. D. M. G., xxiii. 375 sq.); and Kasimîraki's *Specimen du diction de Menouchéari*, Versailles, 1876. On Khâkânî, see Khanykoff's "Mémoire," in *Journal Asiatique*, 6th series, vol. iv. p. 187 sq. and v. p. 296 sq., and Salemann's edition of his rubâ'is, with Russian transl., Petersburg, 1878; on Farîd-ud-dîn 'Attâr, Sacy's edition of the *Pandnâma*, Paris, 1819, and Gardin de Tassy's *Manuscrits-officiels*, Paris, 1857; in the *Gulistan-irâzi*, E. H. Whinfield's edition, London, 1880; and on Amîr Khosraw's mathnawîs, the abstracts given in Elliot's *History of India*, vol. iii. p. 524 sq. German translations of Ibn Yamin were published by Schleichler-Wasserd, *Bruchstücke*, Vienna, 1852; of Jâmî's minor poems, by Rosenzweig, Vienna, 1840; by Eickert, in *Zeitschrift für die Kunde des Morgenlandes*, vols. v. and vi., and *Zeitschrift der D. Morgenl. Gesellsch.*, vols. ii., iv., v., vi., xxiv., xxv., and xxix.; and by Wlckerhauser, Leipzig, 1855, and Vienna, 1858; German translation of *Yâsuf u. Zuleikha*, by Rosenzweig, Vienna, 1834, English by Griffith, London, 1881; French translation of *Lailâ u. Majnun*, by Chézy, Paris, 1805, German by Hartmann, Leipzig, 1807; Hîlâl's "König und Derwisch," by Ethé, in *Morgenländ. Stud.*, Leipzig, 1870, p. 197 sq. On the Persian drama, compare Gobinet's *Religions et Philosophies de l'Asie centrale*, Paris, 1866; Chodzko's *Théâtre persan*, new ed., Paris, 1878; and Ethé, "Persische Pensionspiele," in *Morgenländ. Stud.*, p. 174 sq. (H. K.)

INDEX.

<p>'Abbâs I., 687. 'Abbâs II., 684. Achemenians, 535. Adarbatjan, 686. Afghans, 680, 640, 646 Agâs Muhammad, 645. Alexander, 681. Antiochus I., 687. " II., 687. " III., 688. " IV., 688. Ardasîr, 606, 607. Armenia I., 587. Armenia II., 587. Armenians III., 600. Armenians IV., 605. Artaxerxes I., 573. " II., 578.</p>	<p>Artaxerxes III., 580. Astrâbâd, 687. Babylon, 590, 572. Bactrian Greeks, 587, 589, 590. Bahram V., 610. Cambyses, 587. Chinese accounts, 592 sq., 590. Cressus, 586. Cyzaxars, 586. Cyrus, 584 sq. " (strap), 579, 577. Darius I., 586, 586. " II., 575. " III., 581. Demetrius I., 590. " II., 591. Fath 'Alî Shâh, 647.</p>	<p>Gilan, 681, 686, 687. Gottarua, 681. Hephthalites, 610, 612. Harat, 650, 632. Hormisd IV., 613. Huzand, 680. India invaded, 540, 583, 586, 591, 590, 641. Ionian revolts, 579, 578, 579. Iran, 561. Isma'il I., 624 sq. Ispahan, 627, 628, 629, 630. Kajars, 642, 645 sq. Kerman, 626, 645. Kawâd I., 611 sq. Kaswin, 627, 628, 637. Khoran I., 612. " II., 614.</p>	<p>Khosrow, 681, 628, 646, 651. Lut 'Alî Khân, 645. Masbhad, 626, 628, 637. Mansûrdar, 611, 623, 637. Medes, 581 sq. Mithradates I., 590, 591, 590, 608. " II., 590. Mondîr of Hir, 610, 612. Moslems, 612. Muhammad Shâh, 646. Nâdir Shâh, 641 sq. Nâsru 'D-dîn Shâh, 651. Nîrweh, 585. Orodes I., 585 sq. Parsus, 597. Parthians, 587, 582. Pârs, 611. Persia, 651, 585, 605.</p>	<p>Pirantes II., 604. " III., 598. " IV., 598. Sakwîsh, 604 sq. Sarkîsh, 612. Saryshân, 588, 579, 584, 590, 608. Selenucia, 587, 601, 604. Seleucia, 585 sq. Selenus I., 585. Sevurus, 606. Shâh Buh, 645. " Sûr, 628. " Tahmasp, 606 sq. Shâh Sâ'î, 604. Shâpûr I., 612. " II., 609. Shîrâz, 623, 624, 627, 628.</p>	<p>See, 581, 586, 590. Sulaiman, 628. Tabriz, 626, 622, 628, 622. Tahra, 623, 627, 622. Tigranes (Armenia), 584. Timurides, 623, 623. Tîrîdates, 585. Tosbat, 582, 584, 626, 625, 606. Trajan, 605, 604. Vardanes, 601. Volgases I., 602. " II., 602. " III., 604. Xerxes I., 573. Yasdagird I., 612. " II., 612. Yusuf, 582, 584, 584, 590.</p>
--	--	---	---	---	--



**PERSIGNY, JEAN GILBERT VICTOR FIALIN, DUC DE** (1808-1872), the most devoted servant of Napoleon III., who with the duc de Morny and Marshal Saint-Arnaud formed the triumvirate which established the second empire, was born at Saint-Germain Lespinasse (Loire) on 11th January 1808. He came of a good family, but not a noble one, and, as his father had been killed at the battle of Salamanca in 1812, he was brought up by an uncle, who sent him to be educated at the college of Limoges. He entered the 3d Hussars in 1825, the cavalry school at Saumur in 1826, and became *maréchal des logis* in the 4th Hussars in 1828. He was at this time a Legitimist, but was soon made a Republican by his captain, and he helped to persuade his regiment to assist in the insurrection of 1830. For this service he expected great rewards, but got none, and was eventually dismissed from the army for insubordination in 1831. Finding himself without resources, he took to journalism, and assisted in editing the *Temps*, and in 1833, by which time he had become a profound Bonapartist, he issued a solitary number of a new journal, the *Occident français*, in which he proclaimed his political creed. This number was sent to Queen Hortense at Arenenberg, and when M. Fialin followed it in person, calling himself the vicomte de Persigny, he met with a warm reception, and soon became indispensable to Louis Napoleon. He had two qualities which gave him ascendancy over the young prince, fidelity and audacity. He it was who planned the attempt on Strasburg in 1836, and that on Boulogne in 1840. For his share in the last escapade he was sentenced to imprisonment in a fortress for twenty years, which was commuted into detention at Versailles, where he wrote a curious book to prove that the Pyramids were built to keep the Nile from silting up. When the Revolution of 1848 broke out he laboured indefatigably for the Bonapartist cause, securing the election of Louis Napoleon to the Constituent Assembly in June and in September 1848, and to the presidency in December 1848. His own prosperity was now secured; he was made aide-de-camp to the prince president, and elected to the Legislative Assembly in May 1849 for the department of the Loire. He then became one of the secret plotters of the coup d'état, and was at first designed for the office of minister of the interior, but a man of more capacity, De Morny, was chosen for this post, and Persigny only accompanied Colonel Espinasse to take possession of the hall of the assembly. On securing the throne Napoleon III. hastened to reward his most faithful personal adherent. Persigny became minister of the interior in the place of De Morny in January 1852, and a senator in December 1852. He resigned office in 1854 and became ambassador in London, with but one short interval (1858-59), from May 1855 to November 1860, when he again became minister of the interior. His second tenure of office lasted till June 1863, when he resigned in disgust at the influence which M. Rouher was attaining over the mind of the emperor, and was made duc de Persigny in September 1863. As a minister he showed very little capacity, and throughout the years of his political influence he never seemed to understand, like De Morny, the real bases of the existence of the second empire. He, however, from dislike of Rouher, supported Ollivier in 1869, and defended the plébiscite, and when the empire fell in 1870 escaped to England. He did not long survive the overthrow of the idea which he had so strenuously supported, and died at Nice on 11th January 1872. Fialin de Persigny was certainly only an adventurer, but he had one merit, which the other founders of the second empire did not possess, fidelity to his master.

For Persigny's life, see a most eulogistic biography by Delaroc (*Le duc de Persigny et les doctrines de l'empire*, 1865); a short biography in Mircourt's *Portraits contemporains* (1868); and Cas-

telle's *Portraits politiques et historiques* (1869). His own curious book, *De la destination et de l'utilité permanente des Pyramides d'Égypte et de Nubie*, was published in 1845, and he wrote various political pamphlets, of which the most interesting relates to the Strasburg attempt, *Relation de l'entreprise des princes Napoléon Louis* (Lond. 1837). For his political career under the empire, see Texfils Delord's *Histoire du second empire* (1868-75).

**PERSIMMON**, the name given to the fruits of *Diospyros virginiana* in the United States. The tree which bears them belongs to the order *Ebenaceæ*, and has oval entire leaves, and monocious flowers on short stalks. In the male flowers, which are numerous, the stamens are sixteen in number, arranged in pairs, and with the anthers opening by slits. The female flowers are solitary, with traces of stamens, and have a glabrous ovary with one ovule in each of the eight cells,—the ovary being surmounted by four styles, which are hairy at the base. The fruit-stalk is very short, bearing a subglobose fruit an inch or rather more in diameter, of an orange-yellow colour, and with a sweetish astringent pulp. It is surrounded at the base by the persistent calyx-lobes, which increase in size as the fruit ripens. The astringency renders the fruit somewhat unpalatable, but, after it has been subjected to the action of frost, or has become partially rotted or "bletted" like a medlar, its flavour is improved. In some of the southern States the fruit is said to be kneaded with bran, made into cakes, and baked. From the cakes a fermented liquor is made with the aid of yeast. The tree is cultivated in England, but rarely if ever ripens its fruit, and in the States it is said not to ripen north of New Jersey.

The Chinese and Japanese cultivate another species, the *Diospyros Kaki*, of which there exist numerous ill-defined varieties, which, according to Mr Hiern in his exhaustive monograph of the *Ebenaceæ*, all belong to one species. The fruits are larger than those of the American kind, variable in shape, but have similar properties. Some varieties have been introduced into Great Britain, and have produced their fruits in orchard-houses. The fruit is in appearance something like that of the apricot, but very astringent to the taste. After "bletting," however, it becomes sweet and agreeable. Some specimens analysed by Dr Voelcker for the scientific committee of the Royal Horticultural Society contained, roughly, 84 per cent. of water, 2½ per cent. of tannic acid, and 9·3 of sugar, pectin, &c., with small quantities of woody, albuminoid, and mineral matters.

**PERSIUS (A. PERSIUS FLACIUS)** stands third in order of time of those recognized by the Romans as their four greatest satirists. These represent four distinct periods of the national development—the revolutionary era of the Gracchi, the years immediately preceding the establishment of the monarchy, the first years of the reign of Nero, the age of Domitian and the dawning of the better era which followed on the accession of Nerva. Their relative value consists in the truth, freedom, and power with which they expressed the better spirit of their time, commented on its vices and follies, and described the actual personages, the prevailing types of character, and the fashions and pursuits—the "quicquid agunt homines"—by which it was marked. Of these four representatives of the most distinctly national branch of Roman literature—Lucilius, Horace, Persius, and Juvenal—Persius is the least important. He is indeed inferior to none of them in the purity and sincerity with which he expresses the best spirit of his age; but he was inferior in literary originality and vigour to Lucilius, in literary art to Horace and Juvenal,—less powerful in his denunciation of evil than Lucilius and Juvenal, less searching in his criticism than Horace,—less true to life in his delineation of men and manners than the two earlier satirists, less powerful in his effects than the latest among them. This inferiority is to be ascribed partly to the circumstances of his age. Its literature was more artificial, and also more opposed to the true principles of art, than that of any other stage in the development of Roman letters. The generation which succeeded the Augustan age—the generation which lived

under Tiberius, Gaius, and Claudius—had not the genius to originate a literature of its own nor the sense of security which would enable it to perpetuate the literary accomplishment of the preceding age. No period between the Ciceronian era and the reign of Hadrian was so unproductive. The accession of the young emperor, in whom were ultimately realized the worst vices of the tyrant along with the most despicable weaknesses of the *litterateur* and *artiste*—"scenicus ille" is the term of contempt applied to him in Tacitus—gave a fresh impulse to that fashion of verse-making which Horace remarked as almost universal among his educated contemporaries, and which was stimulated by the rhetorical education of the day. But the writers of the Neronian age had neither the genius nor the true sense of art which distinguished the Ciceronian and Augustan ages, nor had they acquired the cultivated appreciation and good taste of the later Flavian era, nor were they animated by that sense of recovered freedom of speech and thought which gave to Roman literature its two last great representatives. The writing of the Neronian age was, for the most part, a crude and ambitious effort to produce sensational effects by rhetorical emphasis. Of its representatives four can still be read with a certain though by no means an unmixt pleasure,—Seneca, Lucan, Petronius, and Persius. Of these Persius had least of the true literary gift. He had neither the smooth and fluent elegance of Seneca, the "ingenium amicum et auribus illius temporis accommodatum" attributed to him by Tacitus, nor the rhetorical passion of Lucan, nor the cynical realism and power of representation which enabled Petronius to originate a new form of literature. Persius could not have become a satirist of the type of Petronius or of Martial: he could not have treated human degradation in a spirit of cynical sympathy or of amused tolerance. On the other hand earnest satire directed against its legitimate objects, the emperor and his favourites, could not at such a time express itself openly. "Pone Tigellinum" is an expressive reminder that it was safer to write sickly sentimentalism about "Phyllis and Hypsipyle" than to assume the rôle of Lucilius.

But apart from the influence of his time and the natural limitations of his genius, the personal circumstances of Persius were unfavourable to success in the branch of literature to which he devoted himself. The shortness of his life and the retirement in which it was spent, his studious tastes, his delicate health, and that which is most admirable in him, his exceptional moral purity, all contributed to keep him ignorant of that world which it is the business of a satirist to know. Lucilius, Horace, Petronius, Martial, Juvenal, were all men of the world, who knew the life of their day by close personal contact with it, and had no need to imagine it through the medium of impressions received from literature, or situations invented as themes for rhetorical exercises. Some aspects of his time, such as the outward signs of literary affectation and effeminacy, did come within the range of Persius's observation, and these he describes with no want of the pungency, "Italum acetum," characteristic of his race. But from any intimate knowledge, even through the medium of conversation, of the vices and vulgarities from which Petronius lifts the curtain he was debarred by the purity alike of his moral instincts and of his taste. Thus his satire, while able to lash "the sickly morals" of his time ("pallentes radere mores") in fervid generalities, cannot perform the more important function of probing them through living examples.

But Roman satire had another function besides the representation and criticism of men and manners. More than any other branch of literature it was the expression of the writer's own nature and convictions. The frank sincerity with which these were expressed was a great cause

of the personal hold which Lucilius had on his readers; it is still one of the secrets of the personal charm of Horace. The sympathy with which Persius was read in the early days of Christianity and the enthusiasm which many readers have felt for him in modern times are mainly due to the impression of character which he produces. But he is to be regarded further, not as an isolated specimen of purity in an impure age, but as an important witness of that undercurrent of moral and spiritual sentiment which gathered force as a protest against the corruption and tyranny of the first century of the empire. The consciousness of moral evil which became intensified during that period is very apparent when we compare the spirit of Cicero and Horace, men in their own day seriously concerned with questions of conduct, with that of Tacitus and Juvenal. This great inward change was stimulated and directed by the teaching of Stoicism; and it was in the reign of Nero that Stoicism gained its chief ascendancy over educated men, and supplanted among the adherents of the republic the fashionable Epicureanism of the days of Lucretius and Horace. Of the Stoical spirit of that time, represented also by Seneca and Lucan, Persius is the purest representative. His chief claim to consideration is not that he is a great poet, satirist, or humorist, or even an agreeable writer, but that he is one of the earliest, and, amongst classical writers, one of the most sincere preachers of a pure personal morality based on a spiritual conception of religion.

The impression of him produced by his writings is confirmed by the accounts transmitted of his life, for which we are indebted to the contemporary grammarians, Valerius Probus of Berytus. Written when the impression left by him was fresh on the memory of his friends, it may be accepted as trustworthy in regard both of outward fact and of the sentiments which he inspired.

Well born and well connected, and the inheritor of a good estate, Persius lived the uneventful life of a student, and was chiefly remarkable for his affection for his friends, his teachers, and his family. He was a native of Etruria, a district which contributed less than any other in Italy to the literary distinction of Rome. And it is noticeable that, while Persius has all the characteristic moral fervour of the more serious Roman writers, he shows less, compared with those who have an important place in the national literature, of that sensuous vivacity and susceptibility to beauty in art and nature with which the purely Italian race was pre-eminently endowed. He was born at Volaterræ in the year 34 A.D., and received his early education there. His father died when he was six years of age, and his mother, Fulva Sisennia, whose latter name by its termination is indicative of an Etruscan stock, married a second time and was soon again left a widow. In one of the satires he speaks of the eagerness with which his father used to bring his friends to listen to his recitation of the dying speech of Cato. It is not likely that at the age of six he could have been so far advanced in his rhetorical education, and perhaps, though he uses the word "pater," this reminiscence, which is told not without satirical colouring, may be a testimony to the interest which his stepfather took in watching his progress. The nature of the lesson—"morituri verba Catonis"—is suggestive of an early direction towards Stoicism given in his teaching; but by what he tells us of his way of shirking his lessons and of his healthy preference of play to work, he seems to have done what he could to escape the doom of becoming a precocious prodigy. He was taken at the age of twelve to Rome, and continued his education under the two most famous grammarians and rhetoricians of the day, Remmius Palaemon and Virginius Flavius. The decisive influence of his life was his friendship with the Stoic philosopher, Anneus Cornutus, whose

pupil he became on assuming the "toga virilis" at the age of sixteen. To the charm of this man's conversation and teaching Persius attributes his escape from the temptations to a life of pleasure, to which youths of good position and fortune were exposed at Rome. Besides his friendship with Cornutus, he enjoyed during ten years of his life the intimate friendship of Thræsea Pætus, the noblest specimen of Stoicism which the Roman world produced in the first century of the empire. This intimacy was probably due, in the first place, to the relationship of Persius to the younger Arria, the wife of Thræsea. Though a much younger man, he gained so completely the affection of Thræsea that he often went with him as the companion of his travels. The knowledge that he was an intimate member of the circle of Thræsea and Helvidius gives an additional interest to the opinions of Persius on literature and conduct, and also to the indications of his attitude towards the reigning power. He was introduced also to Seneca, but was not much attracted by his genius. The influence of Thræsea may have had something to do with this want of sympathy. The true Stoic, who "kept as holidays the birthdays of the two Brutuses and of Cassius," was not likely to have been among the admirers of the apologist for parricide.<sup>1</sup>

He was also intimate with some of the younger poets of the time, especially with Cæsius Bassus, to whom he addresses his sixth satire. He was acquainted with his younger and more famous contemporary, Lucan, who is said, with the generous impulses which seemed to have been mixed with the fatal weaknesses of his character, to have been carried away by great enthusiasm when he first heard Persius reciting some of his verses. His biographer tells us that the impulse to writing satire was derived from reading a book of Lucilius. He was evidently a diligent student both of him and of Horace. He himself justifies his adoption of this mode of writing by his natural tendency to satiric criticism,—"*sum petulanti splene cacinno.*" But his satire shows as little of the humorous amusement in contemplating the comedy of life, which is one of the motives of the satire of Horace, as of the fierce indignation which the tragic spectacle of its crimes produced in Juvenal. We should rather be inclined to conclude that, as his Stoicism was a protest against the vices and tyranny of the time, so his adoption of that masculine national form of literature which took its subjects from the actual experience of Roman life was a protest against the effeminate style and exotic themes which were then fashionable with the social class to which he belonged.

There is no trace in his writings of any participation in the active interests of public or professional life. More than any other Roman writer, except perhaps Lucretius, he chose the "secretum iter et fallentis semita vitæ" (the flowery path that winds by stealth). But his life, if apparently much happier, was not enriched by the fulness of contemplative interest and of delight in nature which lightened up the gloom of the older poet. His latest satire, addressed to his friend Cæsius Bassus, is written from the port of Luna on the Gulf of Genoa; but, while celebrating the mildness of its winter climate, grateful to him as an invalid, he is silent about the charm of its natural beauty. He died at the age of twenty-eight, on one of his own estates on the Via Appia, within eight miles of Rome. His satires were revised by Cornutus, and edited at his own request by Cæsius Bassus. The former is said to have altered into a vague generality an expression reflecting on the poetical gifts of Nero, a subject as dangerous to deal with as his vices and tyranny. Dying in the

<sup>1</sup> Cf. "Ergo non iam Nero, cuius inmanitas omnium questus antefat, sed Seneca diverso rumore erat, quod oratione tali confessionem scripsisset" (Tac., *Ann.*, xiv. 11).

year 62 A.D., Persius did not witness the worst crimes of that reign, and escaped the fate which awaited Seneca, Lucan, and Thræsea.

His character is thus summed up by his biographer. "He was of a most gentle disposition, of maidenly modesty, handsome in person, and marked by exemplary affection towards his mother, sister, and aunt. He lived soberly and chastely." The characteristic of "virginalis pudicitia" it is natural to associate with the pure family atmosphere in which he lived; and the existence of cultivated women who could exercise such an influence is a warning not to judge Roman society, even in its worst time, altogether from the representation of Juvenal. The letters of Pliny amply confirm the belief that the world was not all so bad as it appears in that representation. The tone of the biographer as well as his explicit statements attest the warm affection which Persius inspired in his lifetime. Mere asceticism unaccompanied by other graces of character cannot account for this sentiment of affection; and the Roman world had a keen eye to detect insincere professions of austerity. But, while there are many signs of inexperience of life and much forced and artificial writing in Persius, there is in the expression of his deepest convictions an unmistakable ring of genuineness. He seems to love virtue without effort, because his nature finds in the love and practice of virtue the secret of happiness. There is also in the personal addresses to his friends, as in that to Macrinus, a tone of genial sympathy with the innocent enjoyments of life. In the expression of affection for those whom he loved no ancient writer is so cordial and single-minded, except one, as much separated from him by the licence of his life as by the force of his genius, who also died in early youth, the ardent true-hearted poet of Verona.

Persius is said to have written slowly and seldom, and, though he seems to have composed, probably before he devoted himself to satire, a tragedy on a Roman subject, an account in verse of some of his travels, and some lines on the elder Arria (none of which were ever given to the world), the only result of his literary activity is the short book of six satires which we now possess. The contrast between the small amount of his contributions to literature and the reputation which he enjoyed is noticed by two ancient writers, who indicate their appreciation of his value, Quintilian and Martial. The satires are not only fewer in number than those of Horace and Juvenal, but they are for the most part shorter. Only one of them, the first, fulfils the proper function of satire by representing any phase of the life of the time and pointing its moral. It exposes by personal sketches and representative imitations the fashionable taste in poetry, and marks its connexion with the luxury and effeminacy of the age. The satire was believed in ancient times to be aimed at the emperor; and this is confirmed, not only by the tradition of the substitution by Cornutus of the vague generality "quis non" for the pointed "*Mida rex*," but also by the parody "*Torva Mimalonæ implerunt cornua bombis*," &c., which is in keeping with the account we have in Tacitus and other writers of the style of the emperor's compositions. In an age abounding in informers it would have been dangerous to have published or even to have read before a circle of friends a more direct comment; but the attitude of Persius towards the absolute ruler of the day may be inferred from other references in the satires, as from the passage iii. 35, beginning "*Magne pater divum*"; and again at iv. 20, in the words, "*Ast ego Dinomaches*," we may suspect a protest against the degradation of the Roman world in submitting to be governed by the son of Agrippina. Even in the abstinence from one single word of compliment to the ruling power we enjoy an agreeable contrast to the time-serving of Seneca and the adulation of Lucan.

While the first satire is, like most of those of Lucilius, Horace, and Juvenal, essentially representative, and has its motive in the desire to paint in satiric colours a prevailing fashion and some of the actual personages or types of character of the day, all the rest are essentially didactic and have their motive in the desire to enforce and illustrate some lesson of morality or tenet of Stoicism. The second is an admirable sermon on prayer, and illustrates by examples that union of worldliness and covetousness with religious faith and practice which has not been absolutely confined to Paganism. The third is aimed at the exposure and correction of the weakness of character which, in spite of good resolutions, succumbs to the attacks of sloth and pleasure. The fourth, suggested by the first *Alcibiades* of Plato, though perhaps also written with covert reference to one whose "Greek levity" may have prompted him to

pose as a Roman Alcibiades, is directed against the arrogant claims of a sensual youth to deal, on the ground of his hereditary distinction, with affairs of state and to govern men. The fifth, the most elaborate of all, illustrates the Stoical doctrine of the difference between true and false freedom, and shows the power of avarice, luxury, the passion of love, ambition, and superstition to make men slaves. It is the same subject as that which Horace treats in the third satire of the second book; but it is treated with neither the irony nor the direct knowledge of life which Horace applies to it. The last satire is chiefly devoted to a subject which played a large part in the satire of Horace and Lucilius,—the proper use of money. In all these latter pieces the subjects are the common-places of satire and moral disquisition, illustrated rather by new versions of old characters than by pictures of the living men and women of the day. Though he expresses admiration for the spirit of Lucilius and the old comedy, he seems to keep clear of all personality and detraction. He professes "ingenuo culpam deliquere ludo," and, whatever may be thought of his humour, he at least always writes in the spirit of a gentleman. So far as there is real contact with life in his satires, it is with the vanity and weakness of the class to which he himself belonged that he shows familiarity. Other sketches, however, show original observation, as that of the provincial ædile, of the brawny centurion who laughs at all philosophers, and, the most elaborate of all, that of the man torn asunder by his avarice and his love of luxury, who shrinks from the hard roughing of a sea-voyage, to which he is prompted by his cupidity (l. 129, il. 76-87, v. 141-150).

In point of form he aims at reproducing the dialogue of the old "saturn," to which Horace finally adhered. But for the dramatic vivacity of ordinary speech he substitutes the curt questions and answers of Stoical disquisition. This is a great source of the obscurity of his writing. Some of his satires take the form of a familiar epistle, but in them also there is a large intermixture of dialogue. In style, while he protests against other modes of affectation, he cannot escape the perverse fashion of forced and exaggerated expression. While disclaiming imaginative inspiration and avoiding poetical ornament, he falls into the opposite extreme of excessive realism, and disguises his plain meaning under contortions of metaphor, taken from the forge, the potter's wheel, the carpenter's rule, the baker's oven, &c. He is fond, too, of the realism of physical expression to denote states of mind and feeling, such as "fibra," "pulpa," "gluto," &c.; and this tendency, combined perhaps with the wish to imitate Lucilius, has led him occasionally to disfigure the purity of his pages with unnecessary coarseness. It is only rarely, and when he is at his best, that we are not conscious of a constant strain to express his meaning with unnecessary emphasis. Though single phrases of forcible condensation can be quoted from him, yet almost every period and paragraph seems to have been made harsh and obscure with the purpose of arresting attention. In the pictures which he draws from life, as in that of the reciting poet in the first satire, he strives by minuteness and exaggeration of detail to produce a strong sensational impression; and this is still more observable in those numerous cases where he distorts and caricatures the temperate and truthful effects of Horace's sketches. No Latin writer is less natural. His works have engaged the industry of many commentators both in ancient and modern times. None could claim less the praise which Martial claims for his own, of "pleasing grammarians without needing the aid of their interpretation."

It is not, accordingly, among writers but among moralists that he holds a high place. Among the professors of Stoicism some were better writers, others were greater men; no one was purer in all his instincts, more sincere in all his nature, or inspired with a more genuine enthusiasm for virtue. It is when he gives expression to this enthusiasm and to his single-hearted affection for his friends that he is able for a few lines to write with simple force and with impassioned earnestness. Such lines as these—

"Compositum ius hæque anima, sanctoque recessus  
Mentis, et incoctum generoso pectus honesto" (l. 73, 74);

"Quid sumus et quidam victuri gignimur . . .  
... quem se deus esse

Jussit et humana qua parte locatus es in re" (il. 66-73), &c.;

are in a strain more in accordance with the best modern ideas of man's highest duty and his true position in the world than anything to be found in the other satirists of Rome. The aim of Lucilius was to make men good citizens. He judged their life by the standard of public virtue and utility. The aim of Horace's satire was to make men happier in themselves and more agreeable in their intercourse with one another. He judged them by the standard of good sense, good feeling, and good manners. The aim of Juvenal—so far as it was sincere—was to raise human life from the degradation into which it had fallen. The standard by which he judged the men of his day was that of the manliness and dignity realized in the best ages of the republic. The aim of Persius was to make men live in accordance with the dictates of a pure conscience. His standard was that ideal of human conduct which has arisen out of the aspirations and convictions of an enlightened theism.

The best recent editions of Persius are those of O. Jahn and of Professor Conington. The edition of Mr. Pretor is also to be named. All of these contain, in their introductions, important contributions to the critical estimate of Persius. An excellent account of his life, character, and writings is to be found in Martha's *Lex Moritatus Romanæ*, and an interesting, though somewhat disparaging, criticism of him as a writer is contained in *Miscell. Poet. Latine de la Jonckheere*. (W. Y. S.)

**PERSONAL ESTATE.** Strictly speaking, the term **ESTATE** (*q.v.*) is confined in English law to the extent of interest which can exist in real property. But "personal estate" is a term often conveniently, if not accurately, applied to all property that is not real property. The division of property into real and personal represents in a great measure the division into immovable and movable incidentally recognized in Roman law and generally adopted since. "The only natural classification of the objects of enjoyment, the only classification which corresponds with an essential difference in the subject-matter, is that which divides them into moveables and immoveables" (Maine, *Ancient Law*, ch. viii.). "Things personal," according to Blackstone, "are goods, money, and all other moveables which may attend the owner's person wherever he thinks proper to go" (*Comm.*, vol. ii. p. 16). This identification of things personal with moveables, though logical in theory, does not, as will be seen, perfectly express the English law, owing to the somewhat anomalous position of chattels real. In England real property is supposed to be superior in dignity to personal property, which was originally of little importance from a legal point of view. This view is the result of feudal idea, and had no place in the Roman system, in which immovables and moveables were dealt with as far as possible in the same manner, and descended according to the same rules. The law of personal property has developed more rapidly and freely than that of real property, as it is of more modern growth and has not been affected by the notion of tenure. The main differences between real and personal property which still exist in England are these: (1) In real property there can be nothing more than limited ownership (see **ESTATE**); there can be no estate properly so called in personal property, and it may be held in complete ownership. There is nothing corresponding to an estate-tail in personal property; words which in real property would create an estate-tail will give an absolute interest in personalty. A life-interest may, however, be given in personalty, except in articles *que ipso usu consumuntur*. Limitations of personal property, equally with those of real property, fall within the rule against perpetuities. (See **REAL ESTATE**.) (2) Personal property is not subject to various incidents of real property, such as rent, dower, or escheat. (3) On the death of the owner intestate real property descends to the heir; personal property is divided according to the Statute of Distributions. (4) Real property as a general rule must be transferred by deed; personal property does not need so solemn a mode of transfer. (5) Contracts relating to real property must be in writing by the Statute of Frauds, 29 Car. II. c. 3, s. 4; contracts relating to personal property need only be in writing when it is expressly so provided by statute, as, for instance, in the cases falling under a 17 of the Statute of Frauds. (6) A will of lands need not be proved, but a will of personalty or of personal and real property together must be proved in order to give a title to those claiming under it. (7) Devices of real estate fall as a rule within the Mortmain Act, 9 Geo. II. c. 36 (see **CHARITIES, CORPORATION**); bequests of personal property, other than chattels real, are not within the Act. (8) Mortgages of real property need not generally be registered; mortgages of personal property for the most part require registration under the Bills of Sale Acts (see **PLEDGE**); and **BILL OF SALE**, vol. iii. p. 674).

Personal estate is divided in English law into *chattels*

*real and chattels personal*; the latter are again divided into *choses in possession* and *choses in action*. Chattels real are personal interests in real estate, which, though they are annexed to land, still descend in the same manner as personal estate. Blackstone speaks of them as being "of a mongrel amphibious nature." Examples are a term of years, the next presentation to a benefice, an estate *pur autre vie*, and money due upon a mortgage. Under the head of chattels personal fall all kinds of property other than real estate and chattels real. In cases of bequest to a charity the terms pure and impure or mixed personality are often used. The latter class is almost coterminous with chattels real. It falls as a rule within the Mortmain Act. A chose in action denotes the right of recovery by legal proceedings of that which, when recovered, becomes a chose in possession. Choses in action were before the Judicature Acts either legal, as debts (whether arising from contract or tort), recoverable in a court of law, or equitable, as legacies (residuary personal estate of a deceased person), or money in the funds. A legal chose in action was not assignable. A consequence of this view was that until 1875 (subject to one or two statutory exceptions, such as actions on policies of insurance) an action on an assigned chose in action must have been brought at law in the name of the assignor, though the sum recovered belonged in equity to the assignee, and in equity he might have sued in his own name, making the assignor a party as co-plaintiff or as defendant. The Judicature Acts have made the distinction drawn between legal and equitable choses in action of no importance. The Judicature Act, 1873, 36 and 37 Vict. c. 66, s. 25, (6), enacts that the legal right to a debt or other legal chose in action may be passed by absolute assignment in writing under the hand of the assignor. The old law as to the reduction into possession by a husband of his wife's choses in action (see HUSBAND AND WIFE) seems to have been practically rendered obsolete by the Married Women's Property Act, 1882. Blackstone, who is followed by Mr Joshua Williams (*Law of Personal Property*), recognises a further division of *incorporeal personal property*, standing between choses in action and choses in possession, and including personal annuities, stocks and shares, patents, and copyrights.

Interest in personal property may be either absolute or qualified. The latter case is illustrated by animals *feræ naturæ*, in which property is only coextensive with detention. Personal estate may be acquired by occupancy (including the *accessio, commissio, and confusio* of Roman law), by invention, as patent and copyright, or by transfer, either by the act of the law (as in bankruptcy, judgment, and intestacy), or by the act of the party (as in gift, contract, and will).

There are several cases in which, by statute or otherwise, property is taken out of the class of real or personal to which it seems naturally to belong. By the operation of the equitable doctrine of conversion money directed to be employed in the purchase of land, or land directed to be turned into money, is in general regarded as that species of property into which it is directed to be converted. An example of property *prima facie* real which is treated as personal is an estate *pur autre vie*, which, since 14 Geo. II. c. 20, s. 9 (now replaced by 1 Vict. c. 26, s. 6), is distributable as personal estate. The absence of a special occupant. Examples of property *prima facie* personal which is treated as real are FIXTURES (*q. v.*), heirlooms, such as deeds and family portraits, and shares in some of the older companies, as the New River Company, which are real estate by statute. In ordinary cases shares in companies are personal estate, unless the shareholders have individually some interest in the land as land.

The terms *heritable* and *moveable* of Scotch law to a great extent

correspond with the real and personal of English law. The main points of difference are these. (1) Leases are heritable as to the accession to the lessee, unless the destination expressly exclude heirs, but are moveable as to the fiak. (2) Money due on mortgages and securities on land is personal in England. At common law in Scotland debts secured on heritable property are themselves heritable. But by 31 and 32 Vict. c. 101, s. 117, heritable securities are moveable as far as regards the succession of the creditor, unless executors are expressly excluded. They still, however, remain heritable *quoad Acum*, as between husband and wife, in computing legitim, and as far as regards the succession of the debtor. (3) Up to 1868 the heir of heritage succeeded to certain moveable goods called heirship moveables, which bore a strong likeness to the heirlooms of English law. This right of the heir was abolished by 31 and 32 Vict. c. 101, s. 160. (4) Annuities, as having *tractus futuri temporis*, are heritable, and an obligation to pay them falls upon the heir of the deceased (Watson, *Law Dict.*, s. v. "Annuities").

The law in the United States agrees in most respects with that of England. Heirlooms are unknown, one reason being, no doubt, that the importance of title-deeds is much less than it is in England, owing to the operation of the Registration Acts. Long terms in some States have annexed to them the properties of freehold estates. Thus in Massachusetts, if the original term be a hundred or more years, it is deemed a fee as long as fifty years remain unexpired (*Mass. Gen. Stat.*, c. 90, § 20). In the same State estates *pur autre vie* descend like real property (*Gen. Stat.*, c. 91, § 1). In New York and New Jersey an estate *pur autre vie* is deemed a freehold only during the life of the grantee; after his death it becomes a chattel real. In other States the heir has a *scintilla* of interest as special occupant (Kent, *Comm.*, vol. iv. p. 37). In some States railway rolling-stock is considered as purely personal, in others it has been held to be a fixture, and so to partake of the nature of real property. Shares in some of the early American corporations were, like New River shares in England, made real estate by statute, as in the case of the Cape Sable Company in Maryland (Schouler, *Law of Personal Property*, vol. i. p. 619). In Louisiana animals employed in husbandry are, and slaves were, regarded as immovables. Pews in churches are generally real property, but in some States they are made personal property by statute, e. g., in Massachusetts (*Gen. Stat.*, c. 30, § 38). The assignment of choses in action is generally permitted, and is in most States regulated by statute. The circuit court has no jurisdiction in the case of an assigned chose in action unless a suit might have been prosecuted in that court if no assignment had been made (*Revised Stat. of U. S.*, tit. xiii. § 639). (J. Wt.)

#### PERSPECTIVE. . See PROJECTION.

PERTH, an inland county of Scotland, is situated almost in the centre of the country between 56° 4' and 56° 57' N. lat., and between 3° 4' and 4° 50' W. long. The larger part of its border-line is formed of natural boundaries, the Grampians separating it on the west and north from Argyll, Inverness, and Aberdeen, while the Ochils and the Firth of Tay in the south-east divide it from Kinross, Clackmannan, and Fife. In the south the river Forth forms a large portion of the boundary with Stirling, but the boundary with Forfar in the north-east is almost at no point defined either by rivers or mountains. The county is of an irregular circular form, the diameter being about 70 miles. A small portion in the south-east is separated from the main portion at the junction of Clackmannan and Fife, and another small portion is surrounded by Stirlingshire. Perthshire is the fourth largest county in Scotland, the total area being 1,617,808 acres, or 2528 square miles. Situated on the Highland border, Perthshire embraces characteristics scarcely combined in any other county of Scotland, and it excels them all in the picturesqueness and multiform variety of its scenery. The finest passes into the Highlands are Killiecrankie, Leny, and the Troasachs. With hardly any exception the rivers and streams flow east and south and reach the ocean either by the Forth or the Tay. They generally issue from large elongated lochs formed by depressions at the foot of the mountains. The Erich in the extreme north-west unites Loch Erich and Loch Rannoch; and from the latter flows the Tummel, which, after passing through Loch Tummel and forming a series of rapids and falls, joins the Tay. The Tay, which rises on the borders of Argyllshire, passes through Loch Dochart and Loch Tay, and in its course

of rather over 100 miles receives nearly the whole drainage of the county, discharging a larger volume of water to the sea than any other river in Great Britain; its principal tributaries are the Tummel at Logierait, the Bran near Dunkeld, the Iala near Kinclaven (after its junction with the Erich), the Almond near Perth, and the Earn from Loch Earn, at the borders of Fifeshire. The Forth from Loch Ard skirts the southern boundary of the county, and receives the Teith from Lochs Katrine, Achray, Venmacher, Voil, and Lubnaig, the Goodie Water from Loch Menteith, and the Allan, which rises in the Ochil Hills. Loch Erich, partly in Inverness-shire, and Loch Tay are each more than 14 miles in length, Loch Rannoch is 9 miles long, Lochs Earn and Katrine are 7 each, and Lochs Venmacher, Lubnaig, and Voil each between 5 and 3. There are an immense number of small lochs varying in length from 1 to 3 miles, among which may be mentioned Garry, Tummel, Lows, Lyon, Dochart, Freuchie, Ard, and Menteith. The lochs and rivers abound in salmon and varieties of trout; and scarcely any of the streams have been perceptibly injured by the pollution of manufactures. About four-fifths of the surface of the county, chiefly in the west and north-west, is occupied by the Grampians, or encroached on by their ridges or by isolated summits, among the highest of the chain in Perthshire being Ben Lawers (3984 feet), north of Loch Tay; Ben More (3843) and Stobinnain (3821), south of Loch Dochart; Ben-y-Gloe (3690), and other peaks, near Glen Tilt; Schiehallion (3547), south of Loch Rannoch; and Ben Voirlich (3180), south of Loch Earn. The Ochils, occupying a considerable area in the south-east, attain in many cases a height of over 2000 feet, and the Sidlaws, practically a continuation of the Ochils running into Forfarshire, reach a height of about 1500 feet. The lowland districts consist chiefly of the straths and river-valleys, as Strath-tay; Strathmore, extending into Forfarshire; Strathearn, stretching across the county from west to east, and bounded on the south by the Ochils; the district of Menteith between the Teith and the Forth; and the Carse of Gowrie between the Sidlaws and the Firth of Tay.

*Geology and Minerals.*—As regards its geology Perthshire consists of two distinct areas, that differ from each other entirely in the rocks of which they are composed and consequently in their scenery. The larger of these regions comprises the mountainous ground and occupies the northern and by much the larger part of the county. The rocks in this region belong to the series of crystalline schists, and include varieties of gneiss, mica-schist, clay-slate, hornblende-rock, &c., with important bands of quartzite, quartz-schist, and limestone. These rocks are arranged in approximately parallel folds, the axes of which range in a general sense from south-west to north-east, the same groups of strata being repeated again and again by successive plications. The quartzites from their durability and whiteness form specially marked zones across the county, as in the ranges of Schiehallion and Ben-y-Gloe. The limestones also from their persistence afford excellent horizons for interpreting the geological structure. A notable band of them runs along the valley of Loch Tay, plunging under Ben Lawers and rising up again in Glen Lyon, whence it continues across Strath Tummel into Glen Tilt. These various crystalline rocks are believed to be prolongations of the schistose series that overlies the Lower Silurian rocks of Sutherland; but they have not yet yielded fossils. They are here and there pierced by masses of granite, porphyry, or other eruptive rocks.

The southern (or more correctly south-eastern) limit of the mountain ground is defined by a line drawn from the foot of Loch Lomond by Aberfoyle, Pass of Leny, Comrie,

a little below Dunkeld, and Bridge of Cally, to Lintrathen. On the southern side of this line the ground presents distinctively lowland scenery. It is occupied by the Lower Old Sandstone with its included conglomerates, flagstones, and volcanic rocks. A remarkable dislocation, which nearly coincides with the line just traced, separates the younger series of formations from the older rocks of the mountains. But here and there on the north side of the fracture, in bay-like hollows of the hills, the massive conglomerates of the Old Red Sandstone can be seen resting upon the upturned edges of the schists. These conglomerates with their associated strata appear to have been laid down in a large lake or inland sea which lay across central Scotland and northern Ireland, and was tenanted by the peculiar Old Red Sandstone fishes (*Cephalaspis*, &c.). A long line of active volcanoes extended through this lake. Their sites are still traceable in the Ochil and Sidlaw Hills. See *Geology*, vol. x. p. 343 sq. Much of the lower ground is covered with the clays, gravels, and sands left by the ice-sheets and glaciers that once occupied the surface. Raised beaches marking recent upheaval of the land are seen in the Firth of Tay. The larger rivers present a succession of three or more alluvial terraces. Copper ore is found in the southern Ochils and coal at their base. Ironstone is wrought at Culross. Lead and other metals are found sparingly in the neighbourhood of Tyndrum, Ben Ledi, and Glen Lyon. Roofing slates are quarried at Birnam. In many valleys there are large deposits of peat.

*Agriculture.*—The climate and soil of Perthshire present greater varieties than in any other county of Scotland. In the higher western regions it is very moist; and long stretches of exposed uplands alternate with finely-sheltered valleys. The arable land is chiefly in the drier eastern districts. For the most part the soil is sharp and fertile. The county, agriculturally, may be classed in four divisions: deer-forests, chiefly the wilder mountain districts; grazing and pasture lands on the hills, embracing about four-fifths of the total area; light soils in the lower undulating districts, including the north portion of Menteith and the upper portion of the principal river-valleys, specially suited for oats, barley, turnips, and potatoes; clay and carse land, chiefly in the Carse of Gowrie, which extends to about 100,000 acres, in the Carse of Stirling north of the Forth and in the lower part of Strathearn below and above Bridge of Earn. The Carse of Gowrie has as its basis the boulder clay, above which rests the blue clay proper, or peat, or the carse clay,—a mixture of sand and clay, ranging from the finest clay soil to poor whitish "end clay." The best heavy carse land is very rich and productive, but requires to be thoroughly wrought, limed, and manured. The district is well adapted for wheat, although the area sown is decreasing. A considerable area is occupied by orchards, the light quick soil on Tayside and in the upper districts of Menteith being admirably adapted for apples.

Between 1875 and 1880 the number of holdings decreased from 5296 to 6123, although their area increased from 331,890 to 344,728 acres. Of the holdings 179 in 1880 were above 300 acres in extent, 1038 between 100 and 300 acres, 786 between 50 and 100 acres, and 3125 did not exceed 50 acres each. There are a large number of small holdings in the Highland valleys and in the neighbourhood of the villages and small towns. According to the agricultural returns for 1883 there were 344,240 acres, or only a little less than a fifth of the total area, under cultivation, 103,650 acres being under corn crops, 50,799 acres green crops, 100,631 rotation grasses, 87,064 permanent pasture, and 2696 fallow. Of the corn crops, 70,424 acres were under oats, 22,770 acres barley and bere, 6238 wheat, and 3087 beans; and of the green crops, 81,059 acres were under turnips and swedes and 18,611 under potatoes. The number of horses was 13,661, of which 10,524, chiefly Clydesdales, were used solely for agricultural purposes. Cattle numbered 73,097, of which 18,755 were cows and heifers in milk or in calf. Although dairy-farming is not in itself an important industry, a large number of cows are generally kept on the lowland farms. The cows are principally Ayrshires, but the West



Highland or Kylee breed of cattle is common in the straths and lower grounds adjoining the Highlands. Sheep in 1883 numbered 696,640. All the pasturage in the Grampians, not in deer-forests, is occupied by sheep, and there are also large sheep-runs on the Ochils. The blackfaced are principally kept in the Grampians, but there are also a large number of Cheviots, and in the lower grounds South Downs and Leicesters are common. In 1812 there were 203,880 acres under wood, of which 61,164 were planted and 142,716 natural. The area under woods in 1884 was 94,563 acres, in addition to which 424 acres were under orchards, 585 acres market-gardens, and 118 acres nurseries. In Breadalbane and Menteith there are still extensive remains of the old forest.

According to the latest return (1872-73) the land was divided among 573 proprietors, possessing 1,612,001 acres at an annual value of £959,365, or about 11s. 10d. an acre. Of the proprietors 4680, or nearly four-fifths, possessed less than one acre each. The following possessed upwards of 20,000 acres each, viz., duke of Athole, 194,640; earl of Breadalbane, 198,504; Baroness Willoughby d'Eresby, 76,887; trustees of marquis of Breadalbane, 40,662; earl of Moray, 40,553; Hon. Lady Menzies, 35,500; Sir A. D. Drummond Stewart, 33,274; trustees of R. Stewart Menzies, 33,000; Sir Robert Menzies, 32,784; duke of Montrose, 32,294; earl of Mansfield, 31,197; D. R. Williamson, 29,494; C. H. Drummond Moray, 24,980; Mrs Mary Stuart Robertson, 24,000; W. M. Macdonald, 22,600; David Carnegie, 22,205; and Lieutenant-Colonel Farquharson, 20,056.

**Manufactures.**—The manufacture of coarser linen fabrics is largely carried on in the towns and villages, and there are a considerable number of flour-mills. Cotton-works exist at Deanston and Stanley; hand-loom weaving is carried on at Auchterarder, Dunblane, Doune, Crieff, and elsewhere, and in several places the manufacture of shawls, blankets, and other fabrics. For the industries of the city of Perth see below.

**Railways.**—The lowland districts of the county are intersected by branches of the principal railway lines of Scotland, supplying convenient communication between all the principal towns; and by the Highland and Oban railways, supplemented by coaches and steamers on the larger lochs, the finest scenery in the county has been rendered easy of access.

**Administration and Population.**—Anciently the county was divided into the hereditary jurisdictions of Athole in the north, Balquhider in the south-west, Breadalbane in the west, Gowrie in the east, Menteith in the south, Perth in the south-east, Rannoch in the north-west, and Stormont and Strathearn in the middle. These jurisdictions were abolished by the Act of 1748, and in 1795 an Act was passed dividing the county for administrative purposes into the ten districts of Auchterarder, Blairgowrie, Carse of Gowrie, Crieff, Culross, Coupar-Angus, Dunblane, Dunkeld, Perth, and Weem. The sheriffdom is divided into an eastern and a western district, the seat of the one being Perth and of the other Dunblane. The county is represented in parliament by one member, the city of Perth by one member, and Culross is included in the Stirling district of burghs. Perthshire embraces eighty-one parishes, and contains three ancient cities, Perth, formerly the capital of Scotland, and Dunkeld and Dunblane, formerly the seats of bishops, as was also Abernethy. The royal burghs are Perth (27,207) and Culross (380); and Auchterarder, Abernethy, and Dunblane formerly held this rank. The police burghs are Abernethy (906), Alyth (2377), Blairgowrie (4537), Callander (1522), Coupar-Angus (partly in Forfarshire), Crieff (4469), Dunblane (2186), Perth (26,951), and Rattray (2538). The population of the county in 1831 was 142,166, which by 1851 had diminished to 138,660, and by 1871 to 127,768; but in 1881 it had increased to 129,007, of whom 61,552 were males and 67,455 females. The increase has been wholly in the town population, from 44,250 (in 1871) to 49,642 (in 1881), there being a decrease in the village population from 23,321 to 22,849, and in the rural from 60,197 to 57,016. The number of persons speaking Gaelic was 14,505, or more than one-ninth of the total population.

**History and Antiquities.**—In the 2d century the district was divided, according to Ptolemy, among three tribes. The Damnonii inhabited Menteith, Strathearn, and Forthryfe (including the western part of Fife), and had three principal oppida—Alauna, at the junction of the Allan and Forth, guarding the entrance to the Highlands from the south; Lindum, at Ardoch; and Victoria, at Loch Orr in Fife. The Venicones inhabited part of Fife and the adjoining district of Perthshire, with the town of Orre, probably Abernethy, at the junction of the Earn and Tay, the nearest Roman station to which was at Ardarie. The Vacomagi skirted the Highland region, and had the towns of Tames in Inchtuthill (an island in the Tay), where remains still exist, and Banatia, at Buchanty on the Almond, where there was a strong Roman station. In 83 A. D. Agricola explored the country beyond the Forth, and in the following year probably carried his legions to the foot of the Grampians. At Mons Graupius or Grampius, whose site is not ascertained, but which is, according to the most probable conjecture (Mr Skene's), in the district of Stormont in Perthshire, amongst the outliers of

the Grampians near Melkicour, where the Cleavers Dyke and Buzzard Dykes perhaps mark the camps of Agricola and Galgacus, and the Hill of Blair the scene of battle, the Romans (according to their own accounts) defeated the tribes of Caledonia with great slaughter; but they deemed it imprudent to pursue the victory. Perthshire was accordingly left in the possession of its native tribes till its invasion by Severus in 207. The Roman road of Severus passed by Alauna to Liudum at Ardoch, where there are extensive remains of a Roman station, and thence by Stragath near Auchterarder, Dalgin Ross near Comrie, where there were prominent remains a century ago, and Buchanty, where one branch passed eastwards to the coast, and the other turned northwards over the Grampians.

As Severus renewed the wall of Antoninus, he does not appear to have retained possession of the county north of the Forth and the Clyde. Perthshire was included in the kingdom of the Southern Picts, who had their capital first at Abernethy and afterwards at Forteviot. On the burning of Forteviot by the Northmen in the 8th century the seat of the Government was changed to Scone, which continued to be the capital of Albany, the chief royal residence in Scotland, and the place where its kings were crowned, though circumstances led to James II., James III., and Mary being crowned elsewhere. But, as Perth increased in population, it became the seat of the parliament, and the favourite residence of the kings, until it was succeeded by Edinburgh in the reign of James II. In the early history of the county fall the defeat of the Danes at Luncairy in the 10th century and of Macbeth by Earl Sward at Dunsinane in 1054. To its later history, apart from incidents connected with the city of Perth, belong the removal of the coronation stone from Scone to Westminster by Edward I.; the battle of Dupplin, where Edward Balliol defeated the earl of Mar; the rout of the troops of General Mackay at Killiecrankie by the Highlanders under Dundee, 17th July 1689; and the indecisive battle at Sheriffmuir, 13th November 1715, between the adherents of the Pretender under the earl of Mar and the forces of the Government under Argyll. Apart from the camp at Ardoch Roman remains are not important. Of hill-forts the most remarkable is that on Dunsinane Hill. Among other relics of an early period are a ship-barrow of the vikings on the Hill of Rattray; weems in the parishes of Monzie, Alyth, and Bendochy; the witchstone near Cairnbeddie, where Macbeth is said to have met the witches, probably a sepulchral memorial of some old battlefield; and another stone in Meikle parish called Macbeth's Stone; a group of standing stones near Pitlochrie; and a number of sculptured stones at Meikle.

Abernethy, originally founded by the Pictish king Nertan in the 5th century, and refounded by St Columba in the 6th, succeeded Iona as the seat of the primacy of Scotland, afterwards transferred to St Andrews. The round tower in the churchyard, resembling those in Ireland, is supposed to have been built in the time of Kenneth Macalpine. The Culdees had monastic churches at Dunblane, Dunkeld, Abernethy, and Muithill. DUNBLANE (q.v.) and DUNKELD (q.v.) were subsequently erected into bishoprics. The Canons Regular had an abbey at Scone, founded in 1124 and burned in 1559, its site being now occupied by a modern mansion; a priory at Loch Tay, 1114; a priory at Inchafray, 1200; a priory at Strathfillan, 1814; and a priory at Abernethy, 1278. The Dominicans had a convent at Perth, 1231, where there was also a Carthusian monastery, 1429, and a Greyfriars monastery, 1460. Culross abbey, of which the tower and the Gothic choir still remain, was founded by the Cistercians in 1217, and there was also an abbey of Cistercian nuns at St Leonards, Perth, founded in 1296. A Carmelite convent was founded at Tulliallan in 1267. There were collegiate churches at Methven and Tullibardine. Of the old castles of the chiefs mention may be made of Elcho Castle on the Tay, 4 miles south of Perth; Blair Castle, garrisoned by Montrose in 1644, stormed by Cromwell in 1653, occupied by Claverhouse in 1689, dismantled in 1690, and restored in 1870; Castle Huntly, built in 1452 by Lord Grey, master of the household to James II.; the ruins of Castle Dhu, near Moulin, once a stronghold of the Campbell family; the ruins of Finlraig Castle, Killin, the cradle of the Breadalbane family; Cluny Castle, on the island in the loch of the same name between Dunkeld and Blairgowrie; and Doune Castle, on the Teith, a picturesque ruin of very old date, rebuilt by Murdoch, duke of Albany. Among modern mansions the principal are Keir House, the seat of the late Sir W. Stirling-Maxwell; Blair Drummond House, the seat of the Drummonds; Blair Castle, duke of Athole; Taymouth Castle, earl of Breadalbane; Doune Lodge, earl of Moray; Dupplin Castle, earl of Kinnoull; Scone Palace, earl of Mansfield; Gleneagles, earl of Camperdown; Strathallan Castle, Viscount Strathallan; and Drummond Castle, Baroness Willoughby d'Eresby.

PERTH, an ancient city, a royal and parliamentary burgh, and the chief town of the above county, is beautifully situated at the foot of Kinnoull Hill, chiefly on the west bank of the Tay, about 40 miles north of Edinburgh and about 20 west of Dundee. It is substantially built

of stone, and contains a number of good public buildings, while the lower slopes of Kinnoull Hill are studded with villas embosomed in woods. To the north and south of

the town along the banks of the Tay are the extensive meadows of the North and South Inches. The Tay is crossed by a stone bridge for carriage traffic, erected in 1771 and widened in 1869, and by a stone and iron railway bridge with a footway. Notwithstanding its importance in early times, the city now retains almost no relics of antiquity. The religious houses were razed by the mob after John Knox preached his famous sermon in St John's church against the idolatries of Rome. The Dominican or Blackfriars monastery, founded by Alexander II. in 1231 and a residence of the Scottish kings, occupied a site near the west end of the present bridge; the site of the Carthusian monastery, founded by James I. in 1439, and where he and his queen, and Margaret queen of James IV., were buried, has since 1750 been occupied by the hospital founded by James VI.; Greyfriars monastery, founded in 1460, stood on the present Greyfriars churchyard; and a little west of the

town was a house of the Carmelites or Whitefriars, founded in 1260. The parliament house, where the ancient parliaments of Scotland were held, was cleared away in 1818, and was succeeded by the Freemasons' Hall; Earl Gowrie's palace, founded in 1520, was removed in 1805 to make way for the county buildings; the Spey tower near the Spey gate, a mural fortress long used as a prison, was taken down about fifty years ago. The cross, erected in 1668 in place of that demolished by Cromwell, was removed in 1807. The old church of St John is said to have been founded in the 6th century; the transept and nave of the existing structure date from the early part of the 13th century and the choir in its present state from the 15th; the building is now divided into an east, a middle, and a west church. Among other public edifices the principal are the county buildings (erected 1819-20 at a cost of £32,000, and enlarged in 1866), the general prison for Scotland (originally erected in 1812 as a dépôt for French prisoners, remodelled as a convict prison in 1840, and enlarged in 1858 and 1881), the city and county jail (1819), the military barracks (1793-94), the public seminaries (1807), Marshall Museum and Library (1823), Murray's Royal Lunatic Asylum (1827), the infirmary (1836), the general railway station (1848), the new public hall (1881), the Boys' and Girls' Religious Society hall (1881), the new municipal buildings (1881),—a fine range in the Tudor style, cost £13,000.

Some of the most extensive bleach-fields in the kingdom are in the immediate neighbourhood of Perth on the banks of the Tay and the Almond. Perth itself has manufactories of gauge glasses, muslins, ginghams, imitation India shawls and scarfs, union goods, and boots and shoes; and there are rope-works, coach-building yards, iron-foundries, breweries, and distilleries. The Tay has valuable salmon fisheries. The navigation of the river is considerably obstructed by sand. In 1834 an Act was obtained for constructing a harbour and docks and enlarging the quays, which were further extended in 1856. In 1840 Perth was made an independent port; vessels of 200 tons can unload at its quays. The number of vessels

in cargo and in ballast that entered the port in 1883 was 124 of 9767 tons, that cleared 194 of 9731 tons. The principal imports are Baltic timber, coal, salt, and manure, and the exports corn,



Plan of Perth.

potatoes, timber, and slates. The population of the parliamentary burgh in 1851 was 23,635; this had increased by 1861 to 25,250, and by 1881 to 23,949, of whom 13,453 were males and 15,496 female.

*History.*—Perth is stated to have been anciently called *Peritha*, and to have been situated at the junction of the Almond and Tay, whence it was removed to its present site after an inundation in 1210. In any case the church of St John was founded long before this; and a variety of Roman remains seem to indicate that there was a Roman station on the present site of the city. The obscurity of its early history is accounted for by the fact that its records were removed by Edward I. Perth is stated to have been a burgh as early as 1106. The charter granted it by James VI. makes mention also of another granted by David I., and the charter of King David was renewed by William the Lion, by whom Perth was created a royal burgh. It was fortified by the last-named king in 1210 and again by Edward I. in 1298. It was attacked without success by Robert Bruce in 1306, but in 1311 he succeeded in scaling its walls one dark night. It was captured by Edward III. in 1335 and retaken by the Scots in 1339. The earl of Cornwall is stated by Fordun to have been stabbed in 1336 by his brother Edward III. before the great altar in the parish church of St John. In 1396 a famous combat took place on the North Inch, between Clan Chattan and Clan Kay, which has been made familiar to English readers by Sir W. Scott in his *Fair Maid of Perth*. The Blackfriars monastery, where the kings then resided, was the scene in 1487 of the murder of James I. by Walter, earl of Athole, and Gowrie House in 1600 of a mysterious conspiracy against James VI. Perth succeeded *Scots* as the capital of Scotland, but after the murder of James I. the parliament and courts were transferred to Edinburgh, which was declared the capital in 1482. The city was visited by the plague in 1513, 1585-87, 1608, and 1645, by the cholera in 1832, and by inundations in 1210, 1621, 1740, 1778, and 1814. It was taken by Montrose in 1644, capitulated to Cromwell in 1651, and was occupied by Dundee in 1689; it was recovered by Argyll from the adherents of the Pretender in 1715, and was occupied by Prince Charles Edward in 1745. The famous articles of Perth were agreed to at a meeting of the General Assembly in the parish church of St John, 25th August 1618.

*Scott, Statistical Account of the Town and Parish of Perth, 1796; Maidment, The Chronicle of Perth from 1210 to 1608, 1881; Peunsey, Traditions of Perth, 1830; Lawson, The Book of Perth, 1847; Peacock, Perth, its Annals and Antiquities, 1848.*

PERTH, a city of Australia, capital of the colony of Western Australia, is picturesquely situated on the Swan



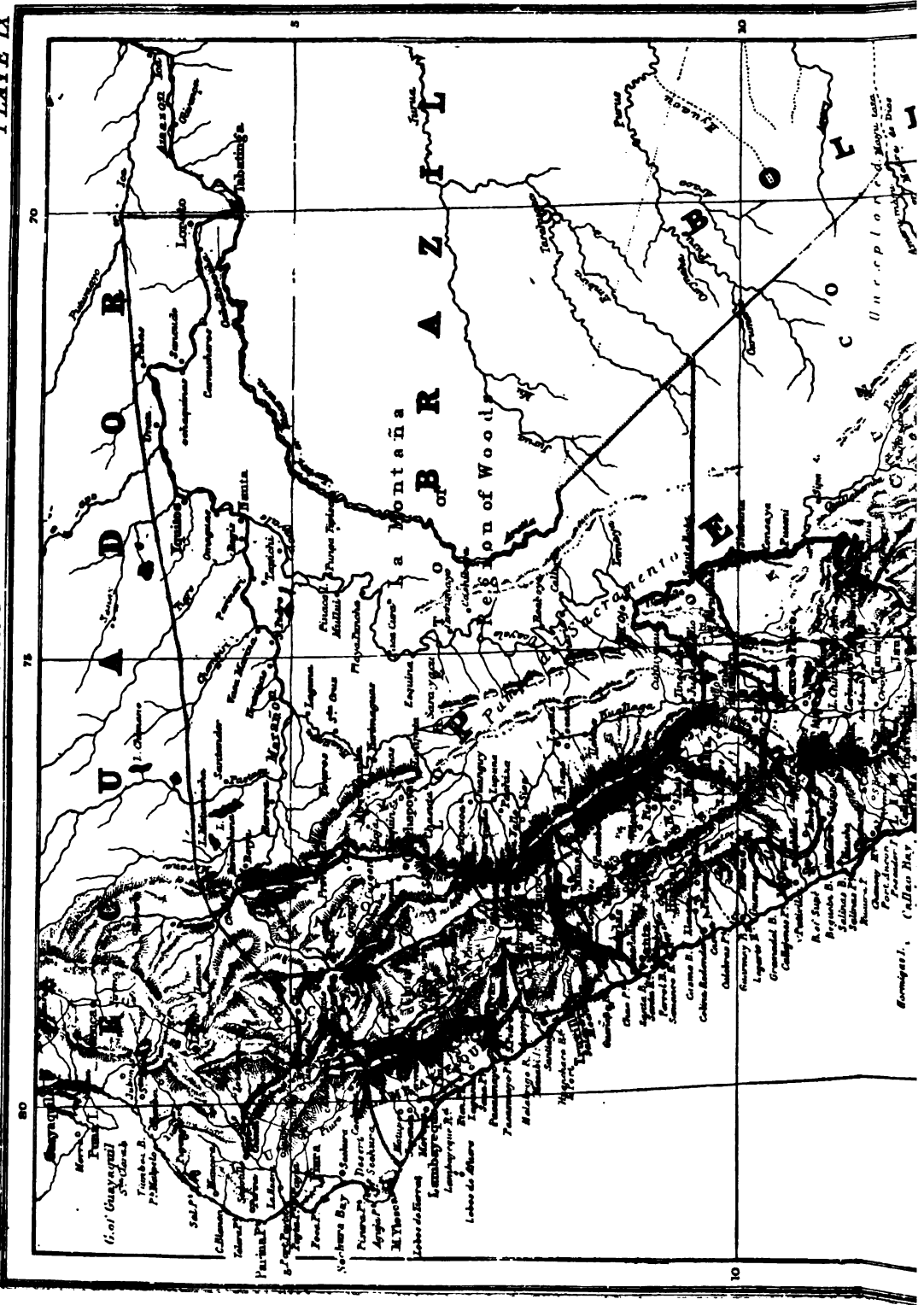



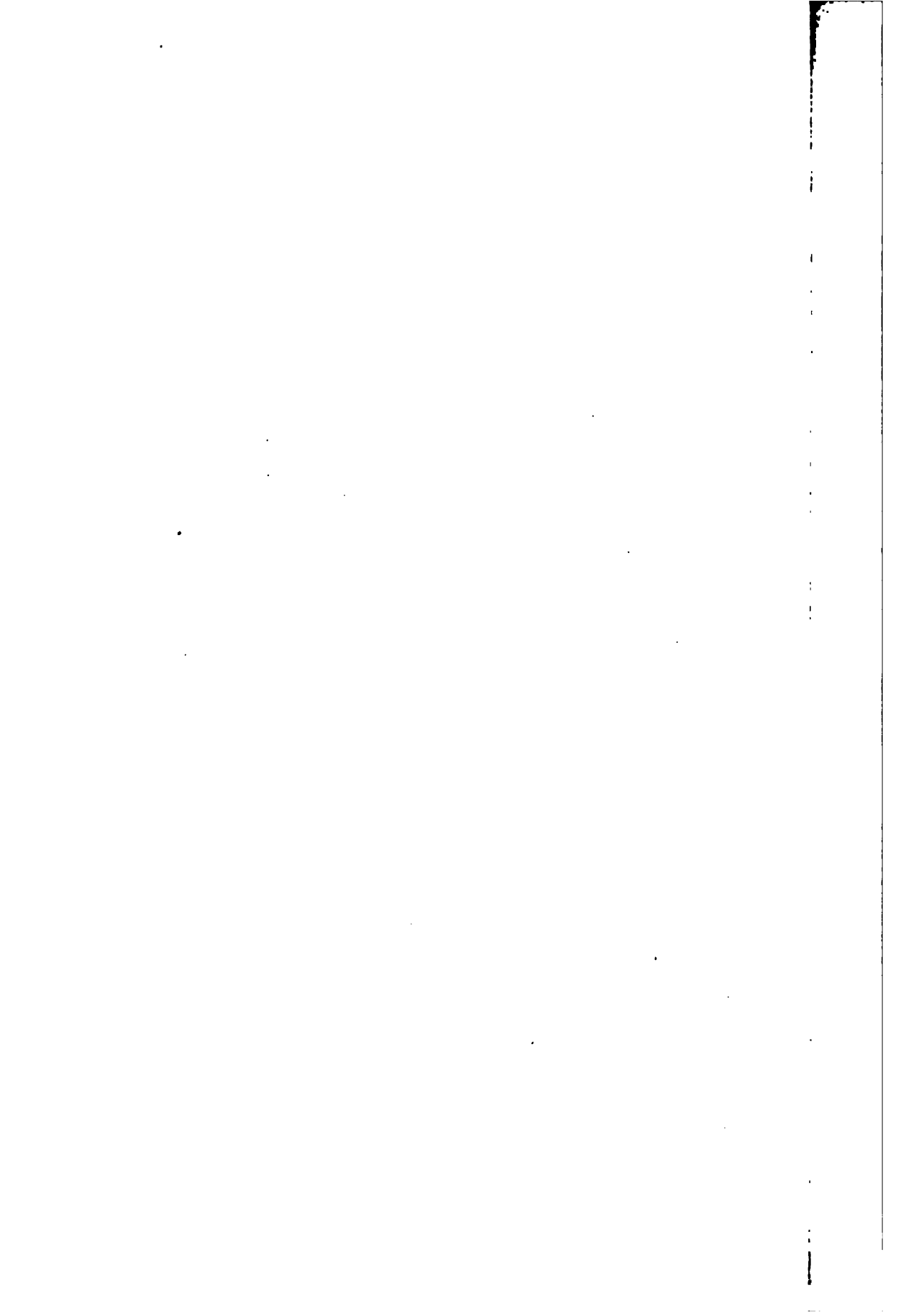



river, 31° 57' 10" S. lat., 115° 52' 20" E. long., 12 miles above Freemantle and 1700 west-north-west of Melbourne. The streets are wide and regular, and the houses are built chiefly of brick and stone. It is the seat of an Anglican and of a Roman Catholic bishop. In addition to the cathedrals the principal buildings are the town-hall, built entirely by convict labour, the mechanics' institute, the governor's palace, and the high school. Perth was founded in 1829, received a municipal constitution in 1856, and was created a city in 1880. In the same year railway communication was opened up by means of the Eastern Railway. The population of the city, including the military, in 1871 was 5007, and in 1881 it was 5044.

**PERTHES, FRIEDRICH CHRISTOPH** (1772-1843), German publisher, was born at Rudolstadt on 21st April 1772. At the age of fifteen he became an apprentice in the service of Böhme, a bookseller in Leipsic, with whom he remained about six years. In Hamburg, where he settled in 1793 as an assistant to the bookseller Hoffmann, he started in 1796 a bookselling business of his own, in developing which he soon gave evidence of remarkable tact, energy, and intelligence. In 1798 he entered into partnership with his brother-in-law, J. H. Besser, with whose aid he rapidly succeeded in forming an establishment which commanded universal confidence and respect. By his marriage with a daughter of the poet Matthias Claudius (in 1797) he was brought into intimate relation with a group of Protestant writers, who, although of a liberal tendency, retained a strong belief in the essential doctrines of Christianity; and they exercised a powerful influence on the growth of his religious opinions. This, however, did not prevent him from being on friendly terms with a number of eminent Roman Catholic authors. Perthes was an ardent patriot; and during the period of Napoleon's supremacy he distinguished himself by his steady resistance to French pretensions. His zeal for the national cause led him to issue (in 1810-11) *Das Deutsche Museum*, to which many of the foremost publicists in Germany contributed. For some time the French made it impossible for him to live in Hamburg; and when, in 1814, he returned, he found that his business had greatly fallen off and that it would have to be thoroughly reorganized. In 1821, his first wife having died, he left Hamburg, transferring his business there to his partner, and went to Gotha, where he established what ultimately became one of the first publishing houses in Germany. Among other important works issued by him may be named the *Theologische Studien und Kritiken* and the *Geschichte der europäischen Staaten*, the latter conducted in the first instance by Heeren and Ukert, afterwards by Giesebrecht. Perthes died at Gotha on 18th May 1843.

Of the three sons of Perthes, the youngest, A. H. T. Perthes, succeeded him as a publisher. The elder sons became authors of some eminence, and one of them, C. T. Perthes, wrote an excellent biography of his father, *Friedrich Perthes' Leben*. In 1785 a publishing house was founded in Gotha by the uncle of F. C. Perthes, J. G. Justus Perthes, whose son Wilhelm became distinguished as a publisher of works relating to geography. Bernhard Wilhelm,

Wilhelm's son, who succeeded to the business in 1853 and died in 1857, greatly extended its operations. In 1854 he established a geographical institute, and the *Mittheilungen aus Justus Perthes' geographischem Institut*, conducted by A. Petermann, soon gained a European reputation. This house issues the *Almanach de Gotha*, and has published the maps and writings of many of the most eminent German geographers and travellers.

**PERTINAX, HELVIUS**, Roman emperor, was the son of a charcoal-burner, and was born in 126 A.D. in Liguria, or at Villa Martis among the Apennines. From being a teacher of grammar he rose through many important offices, both civil and military, to the consulate, which he held twice. Chosen on 31st December 192 to succeed the murdered Commodus, he was himself assassinated in a mutiny of the soldiers after a reign of eighty-six days.

**PERTZ, GEORG HEINRICH** (1795-1876), editor of the *Monumenta Germanica Historica*, was born at Hanover on 28th March 1795. From 1813 to 1818 he studied at Göttingen, chiefly under Heeren. His graduation thesis, published in 1819, on the history of the Merovingian mayors of the palace, attracted the attention of Baron Stein, by whom he was engaged in 1820 to edit the Carolingian chronicles of the newly-founded Historical Society of Germany. In search of materials for this purpose, Pertz made a prolonged tour through Germany and Italy, and on his return in 1823 he received at the instance of Stein the principal charge of the entire work of the society, which was to be the publication, under the title of *Monumenta Germanica Historica*, of accurate texts of all the more important historical writers on German affairs down to the year 1500, as well as of laws, imperial and regal archives, and other valuable documents, such as letters, falling within this period. In the discharge of this, the principal task of his life, Pertz made frequent journeys of exploration to the leading libraries and public record offices of Europe, publishing notes on the results of his explorations in the *Archiv der Gesellsch. f. Deutsche Geschichtskunde* (1824-72). In 1823 he had been made secretary of the archives, and in 1827 principal keeper of the royal library at Hanover; from 1832 to 1837 he edited the *Hannoversche Zeitung*, and more than once sat as a representative in the Hanoverian Second Chamber. In 1842 he was called as chief librarian to Berlin, where he shortly afterwards was made a privy councillor and a member of the Academy of Sciences. Failing health and strength led to the resignation of all his appointments in 1874, and on 7th October 1876 he died at Munich while attending the sittings of the historical commission.

The *Monumenta*, with which the name of Pertz is so closely associated, began to appear in 1826, and at the date of his resignation 24 volumes ("Scriptores," "Leges," "Diplomata") had appeared. The work, which for the first time made possible the existence of the modern school of scientific historians of medieval Germany, continues to be carried on under Waitz, Wattenbach, Dümmler, and others. In connexion with the *Monumenta* Pertz also published *Scriptores rerum Germanicarum in usum Scholarum*; among his other literary labours may be mentioned an edition of the *Gesammelte Werke* of Leibnitz, and a life of Stein (*Leben des Ministers Freiherrn vom Stein*, 6 vols., 1849-55; also, in an abridged form, *Aus Stein's Leben*, 2 vols., 1856).

## P E R U

**PERU** has, in different periods, included areas of territory of varying extent. The empire of the Incas and the Spanish vicerealty were not coterminous with the modern republic nor with each other. In the present article the sections relating to physical geography and the moral and material condition of the people will be confined to the limits of the republic, while in the historical section there will necessarily be references to events which took place beyond the existing limits of the country.

*Extent.*—The republic of Peru is situated between the equator and the Tropic of Capricorn, yet, owing to the differences of elevation, it includes regions with every variety of climate. It lies between the parallels of 3° 21' S. and 19° 10' S. and between 68° and 81° 20' 45" W. long., and has an area of about 480,000 square miles.<sup>1</sup> The

<sup>1</sup> Before the war with Chili the southern limit of Peru was in 23° S. lat., the coast-line measured 1400 miles, and the area was 504,000 square miles (see p. 679 below).

length along the Pacific coast is 1240 miles, while the width ranges from 300 to 400 miles.

**Boundaries.**—The republic is bounded on the W. by the Pacific Ocean, on the E. by Brazil and Bolivia, on the N. by Ecuador, and on the S. by Chili. The northern boundary commences at the village of Santa Rosa, near the southern shore of the Gulf of Guayaquil, whence it passes southwards to the river Macara, a tributary of the Chira, which falls into the Pacific. It takes the course of the Macara, up the ravine of Espindula, to its source in the cordillera of Ayavaca; in the Amazonian basin it follows the river Cauches to its junction with the Chinchipe, and the Chinchipe to the Marañon. The Marañon then forms the boundary until the first Brazilian town is reached at Tabatinga. The frontier with Brazil was determined by article ii. of the treaty of San Ildefonso in 1777. A treaty dated 23d October 1851 further settled the boundary, which was fixed by the commissioners who explored the Yavari in 1866 and 1871. It first follows the course of the Yavari from the point where it falls into the Amazon, in  $4^{\circ} 13' 21''$  S., up to a point near its source in  $7^{\circ} 1' 17''$  S.; from this it forms a straight line to a point in  $6^{\circ} 52' 15''$  S. on the left bank of the Madeira, being half the distance between the mouth of the Mamoré and that of the Madeira. This is the point where the frontiers of Peru, Brazil, and Bolivia meet. The Peru-Bolivian frontier, within the basin of the Amazon, has not been accurately defined. It follows the Madeira to the mouth of the Mamoré, then the Beni and its tributary the Madidi to the junction of the latter with a stream called the Pablo-bamba, ascending the ravine of the Pablo-bamba to the source of that stream in the eastern Andes. The line then crosses the Andes in a straight line southwards to the village of Conima on the shore of Lake Titicaca. Thence it passes across the lake in another straight line to the isthmus of Yunguyo, and thence to the mouth of the Desaguadero. From the Desaguadero the frontier takes a south-south-west direction to the source of the river Mauri, and then, until the recent war with Chili, it ran south along the watershed of the Maritime Cordillera to the source of the river Loa, which falls into the Pacific. The southern boundary separating the Peruvian province of Tarapaca from the Bolivian province of Atacama was formed by the ravine of Duende, south of the Loa, to the coast of the Pacific in  $22^{\circ} 23'$  S. near Tocapilla. This part of the frontier was carefully delineated in 1628, and the boundary marks are recorded in a document which is still extant. But the Chilians conquered and in 1884 annexed the Peruvian province of Tarapaca.

**Physical Geography.**—Peru is divided longitudinally into three well-defined regions, the coast, the sierra, and the montaña. The coast, extending from the base of the Maritime Cordillera to the Pacific Ocean, consists of a sandy desert crossed at intervals by rivers, along the banks of which there are fertile valleys. The sierra is the region of the Andes, and is about 250 miles in width. It contains stupendous chains of mountains, elevated plains and table-lands, warm and fertile valleys, and ravines. The montaña is the region of tropical forests within the valley of the Amazon, and skirts the eastern slopes of the Andes.

The coast has been upraised from the ocean at no very distant geological epoch, and is still nearly as destitute of vegetation as the African Sahara. It is, however, watered by fifty streams which cross the desert at intervals. Half of these have their origin in the summits of the Andes, and run with a permanent supply of water into the ocean. The others, rising in the outer range, which does not reach the snow-line and receives less moisture, carry a volume of water to the sea during the rainy season, but for the rest of the year are nearly dry. The absence of rain here is caused by the action of the lofty uplands of

the Andes on the trade-wind. The south-east trade-wind blows obliquely across the Atlantic Ocean until it reaches Brazil. By this time it is heavily laden with vapour, which it continues to bear along across the continent, depositing it and supplying the sources of the Amazons and La Paz. Finally, the trade-wind arrives at the snow-capped Andes, and here the last particle of moisture is wrung from it that the very low temperature can extract. Coming to the summit of that range, it rushes down as a cool and dry wind on the Pacific slopes beyond. Meeting with an evaporating surface, and with no temperature colder than that to which it is subjected on the mountain-tops, the wind reaches the ocean before it becomes charged with fresh moisture. The constantly prevailing wind on the Peruvian coast is from the south. From November to April there are usually constant dryness, a clear sky, and considerable though by no means oppressive, heat. From June to September the sky is obscured for weeks together by fog, which is often accompanied by drizzling rain called "garua." In 1877 the maximum temperature at Lima was  $75^{\circ}$  Fahr. in February and the minimum  $61\frac{1}{2}^{\circ}$  Fahr. in July. At the time when it is hottest and driest on the coast it is raining heavily in the Andes, and the rivers are full. When the rivers are at their lowest, the "garua" prevails on the coast. The climate of various parts of the coast is however, modified by local circumstances.

The deserts between the river-valleys vary in extent the largest being upwards of 70 miles across. On the western margin steep cliffs generally rise from the sea, above which is the "tablazo" or plateau, in some parts slightly undulating, in others with ridges of considerable height rising out of it, the whole apparently quite bare of vegetation. The surface is generally hard, but in many places there are great accumulations of drifting sea-sand. The sand usually forms isolated hillocks, called "medanos" of a half-moon shape, having their convex sides towards the trade-wind. They are from 10 to 20 feet high, with an acute crest, the inner side perpendicular, the outer with a steep slope. Sometimes, especially at early dawn, there is a musical noise in the desert, like the sound of distant drums, which is caused by the eddying of grains of sand in the heated atmosphere, on the crests of the "medanos." Apparently the deserts are destitute of all vegetation; yet there are kinds of herbs exist, which bury themselves deep in the earth, and survive long periods of drought. One is an annual anthaceous plant, whose stems ramify through the sand-hills; the other two are a *Martynia* and an *Anacardium*, which maintain a subterranean existence during many years, and only produce leafy stems in those rare seasons when sufficient moisture penetrates to the roots. In a few hollows which are reached by moisture the trees of the desert find support, the "algarrobo" (*Prosopis horrida*), a low tree with very scraggy growth, the "vichaya" (*Capparis cotinifolia*), and "zapoté del perro" (*Coliodendrum scabridum*), are shrubs. Far away towards the first ascents to the Andes a tall branched cactus is met with, and there are *Salicornia* and *Salsola* near the coast. But, when the mists set in, the low hills near the coast bordering the deserts, which are called "lomas," undergo a change as if by magic. A blooming vegetation of wild flowers for a short time covers the barren hills. Near Lima one of the low ranges is brightened by the beautiful yellow lily called "amancaes" (*Ismens Amancaes*). The other flowers of the "lomas" are the "papita de San Juan" (*Begonia geraniifolia*), with red petals contrasting with the white inner sides, valerian, the beautiful *Bomarea ovata*, several species of *Oralis*, *Solanum*, and crucifers. But this carpet of flowers is very partially distributed and lasts but a short time. Generally the deserts present a desolate aspect, with no sign of a living creature or of vegetation. Only in the very loftiest

regions of the air the majestic condor or the turkey buzzard may be seen floating lazily; perhaps a lizard will dart across the path; and occasionally a distant line of mules or a solitary horseman seems to shimmer weirdly in the refraction on the distant horizon.

The valleys form a marvellous contrast to the surrounding desert. A great mass of pale-green foliage is usually composed of the "algarrobo" trees, while the course of the river is marked by lines or groups of palma, by fine old willows (*Salix humboldtiana*), fruit-gardens, and fields of cotton, maize, sugar, and lucerne. In some valleys there are expanses of sugar-cane, in others cotton, whilst in others vineyards and olive-yards predominate. The woods of "algarrobo" are used for pasture, cattle and horses greedily enjoying the pendulous yellow pods.

For purposes of description the coast-region of Peru may be divided into six sections, commencing from the north:—(1) the Piura region; (2) the Lambayeque and Truxillo section; (3) the Santa valleys; (4) the section from Lima to Nasca; (5) the Arequipa and Tacna section; (6) Tarapaca.

(1) The great desert-region of Piura extends for nearly 900 miles from the Gulf of Guayaquil to the borders of the Morrope valley, and is traversed by three rivers—the Tumbos, Chira, and Piura, the two former receiving their waters from the inner cordillera and breaking through the outer range. It is here that the coast of South America extends farthest to the westward until it reaches Capa Blanco and Parí, and then turns southward to the Bay of Payta. The climate of Piura is modified by the lower latitude, and also by the vicinity of the forests of Guayaquil. Fog and "garua" are much less frequent than in the coast-region farther south, while positive rain sometimes falls. At intervals of about ten years there are occasional heavy showers of rain from February to April.

(2) The second section of the coast-region includes the valleys of the Morrope, the Chiclaya, and Lambayeque, the Saba, the Jequetepeque, the Chicama, Moche, Viru, and Chao. With the intervening deserts this section extends over 200 miles. All these valleys, except Morrope and Chao, are watered by rivers which have their sources far in the recesses of the mountains, and which furnish an abundant supply in the season when irrigation is needed. (3) The third section, also extending for 200 miles, contains the valleys of Santa, Nepeña, Casma, Huarmpo, Fortaleza, Pativilca, Supé, and Huaura. The river Santa, which rises in the lake of Conococha, 12,907 feet above the sea, and has an entire length of 180 miles, is remarkable for its long course between the outer and central ranges of the Andes, in a trough known as the "Callejon de Huaylas," 100 miles in length. It then breaks through in a deep gorge, and reaches the sea after a course of 35 miles over the coast-belt, and after fertilizing a rich valley. The Santa and Nepeña valleys are separated by a desert 8 leagues in width, on the shores of which there is a good anchorage in the bay of Ferrol, where the port of Chimbote is to be the terminus of a projected railway. The Nepeña, Casma, Huarmpo, Fortaleza, and Supé rivers rise on the slope of an outer range called the Cordillera Negra, and are consequently dry during the great part of the year. Wells are dug in their beds, and the fertility of the valleys is thus maintained. The Pativilca (or Barranca) river and the Huaura break through the outer range from their distant sources in the snowy cordillera, and have a perennial supply of water. There are 9 leagues of desert between the Nepeña and Casma, 16 between the Casma and Huarmpo, and 18 between the Huarmpo and Fortaleza. The latter desert, much of which is loose sand, is called the "Pampa de Mata Cavallos," from the number of exhausted animals which die there. Between the Supé and Pativilca is the desert called the "Pampa del Medio Mundo."

(4) The next coast-section extends for over 300 miles from Chancay to Nasca, and includes the rivers of Chancay or Lacha, of Carabaylo, Rimac, Lurin, Mala, Cañete, Chincha, Pisco or Chunchanga, Yca, and Rio Grande. Here the maritime range approaches the ocean, leaving a narrower strip of coast, but the fertile valleys are closer and more numerous. Those of Carabaylo and Rimac are connected, and the view from the Bay of Callao extends over a vast expanse of fertile plain bounded by the Andes, with the white towers of Lima in a setting of verdure. Lurin and Mala are smaller valleys, but the great vale of Cañete is one green sheet of sugar-cane; and narrow strips of desert separate it from the fertile plain of Chincha, and Chincha from the famous vineyards of Pisco. The valleys of Yca, Palpa, San Xavier, and Nasca are rich and fertile, though they do not extend to the sea; but between Nasca and Acari there is a desert 60 miles in width. (5) The Arequipa and Tacna section extends over 350 miles, and comprises the valleys of Acari, Atequipa, Atico, Ocoña, Majes or Camana, Quilca, with the interior valley of Arequipa, Tambo, Ylo or Moquegua, Ité or Locamba, Sama, Tacna, and Azapa or Arica. Here the Maritime Cordillera recedes, and the important valley of Arequipa, though

on its western slope, is 7000 feet above the sea, and 90 miles from the coast. Most of the rivers here have their sources in the central range, and are well supplied with water. The coast-valleys through which they flow, especially those of Majes and Locamba, are famous for their vineyards, and in the valley of Tambo there are extensive olive plantations. (6) The most southern coast-section is that of Tarapaca, extending between the cordillera and the Pacific, in a narrow strip from the ravine of Camarones, south of Arica, to the former southern frontier of Peru. Only two rivers reach the sea in Tarapaca, the Tiliviche in the north of the province, and the Loa in the extreme south. The other streams are lost in the desert soon after they issue from their ravines in the Andes. The reason of this is that in Tarapaca there is an arid range of hills parallel with the sea-shore, which is about 30 miles in width, and covered with sand and saline substances. Between this coast-range and the Andes is the great plateau called the "Pampa de Tamarugal," from 3000 to 3500 feet above the sea, which is about 30 miles wide, and extends the whole length of Tarapaca. This plateau is covered with sand, and contains vast deposits of nitrate of soda. Here and there a few "tamarugas" or acacia trees are met with, which give their name to the region.

The coast of Peru has few protected anchorages, and the headlands are generally abrupt and lofty. These and the few islands are frequented by myriads of sea-birds, whence come the guano-deposits, the retention of ammonia and other fertilizing properties being due to the absence of rain. The islets off the coast are all barren and rocky.

The most northern is Foca, in 5° 13' 30" S., near the coast to the south of Payta. The islands of Lobos de Tierra and Lobos de Afuera (3), in 6° 27' 45" S. and 6° 56' 45" S. respectively, are off the desert of Sechura, and contain deposits of guano. The two Afuera islands are 60 and 36 miles from the coast at the port of San José. The islets of Macabi, in 7° 49' 20" S., also have guano-deposits, now nearly exhausted. The two islets of Guañapo, surrounded by many rocks, in 8° 34' S., contain rich deposits. Chao rises 450 feet above the sea, off the coast, in 8° 46' 30" S. Corobado is in 8° 57' S. La Viuda is off the port of Casma, in 9° 23' 30" S.; and Tortuga is 2 miles distant to the north. Santa Islet lies off the bay of Cosca, in 9° 1' 40", and the three high rocks of Ferrol in 9° 8' 30" S. Farther south there is the group of islets and rocks called Huaura, in 11° 27' S., the chief of which are El Pelado, Tambillo, Chiquitana, Bravo, Quitacalzones, and Mazarque. The Hormigas are in 11° 4' S. and 11° 58", and the Pescadores in 11° 47' S. The island of San Lorenzo, in 12° 4' S., is a lofty mass, 4½ miles long by 1 broad, forming the Bay of Callao; its highest point is 1050 feet. Off its south-east end lies a small but lofty islet called Fronton, and to the south-west are the Palomitas Rocks. Horadada Islet, with a hole through it, is to the south of Callao Point. Off the valley of Lurin are the Pachacamac Islands, the most northern and largest being half a mile long. The next, called San Francisco, is like a sugar-loaf, perfectly rounded at the top. The others are mere rocks. Asia Island is farther south, 17 miles north-west of Cerro Azul, and about a mile in circuit. Pisco Bay contains San Gallan Island, high, with a bold cliff outline, 2½ miles long by 1 broad, the Ballista Islets, and farther north the three famous Chincha Islands, whose vast guano-deposits are now exhausted. South of the entrance to Pisco Bay is Zarate Island, and farther south the white level islet of Santa Rosa. The Infernillo rock is quite black, about 50 feet high, in the form of a sugar-loaf, a mile west of the Point of Santa Maria, which is near the mouth of the Yca river. Alacran is a small islet off the lofty "morro" of Arica. A low island protects the anchorage of Iquique on the coast of Tarapaca, and farther south are the three islets of Patillos in 20° 46' 20" S., and the Pajaros, with guano-deposits, in 22° 6' 4" S. All these rocks and islets are barren and uninhabitable, mere outworks of the desert headlands.

The more common sea-birds, which haunt the islets and headlands in countless myriads, are the *Sula variegata* or guano-bird, a large gull called the *Larus modestus*, the *Pelecanus thagus*, and the *Sterna Yaca*, a beautiful tern with curv'd white feathers on each side of the head. The rarest of all the gulls is also found on the Peruvian coast, namely, the *Xema fuscatum*.<sup>1</sup> The immense flocks of birds, as they fly along the coast, appear like clouds, and one after another is incessantly seen to plunge from a height into the sea to devour the fishes, which they find in extraordinary numbers. The guano-deposits are in layers from 40 to 50 feet thick, of a greyish-brown colour outside, and more and more solid from the surface downwards, owing to the gradual deposit of strata and evaporation of fluid par-

<sup>1</sup> The third known example was shot in Paracas Bay, near Pisco by Captain Markham, in 1861.

ticles. Sea-lions (*Otaria forsteri*) are common on the rocky islands and promontories. These large creatures frequent particular islets for the purpose of breathing their last, the wounded or aged being helped there by their companions.

The Maritime Cordillera, overhanging the Peruvian coast, contains a long line of volcanic mountains, most of them inactive, but their presence is probably connected with the frequent and severe earthquakes, especially in the southern section of the coast. Since the year 1570 there have been seventy violently destructive earthquakes recorded on the west coast of South America, but the register is of course incomplete in its earlier part. The most terrible was that of 1745, which destroyed Callao. There had been subterranean noises for some days previously; the first shock was at 10.30 p.m. on 28th October, and there were 220 shocks in the following twenty-four hours. The town was overwhelmed by a vast wave, which rose 80 feet; and the shocks continued until the following February. On 13th August 1868 an earthquake nearly destroyed Arequipa, and great waves rolled in upon the ports of Arica and Iquique. On 9th May 1877 nearly all the southern ports were overwhelmed. These fearful catastrophes are in greatest force where there are volcanoes, whether active or extinct, in the vicinity. That of 1877 had its origin in the volcanic mountains near the frontier of Peru and Bolivia, and spent its chief fury near its centre of origin, gradually working itself out as it went north. Usually the line of disturbance is meridional and along the coast, but in some instances the line takes a seaward direction at an angle with the mountain-chains.

The most important part of Peru is the region of the cordilleras of the Andes divided into "puna" or lofty uninhabited wilderness, and "sierra" or inhabitable mountain slopes and valleys. This great mountain-system, running south-east to north-west with the line of the coast, consists of three chains or cordilleras. The two chains which run parallel, and near each other on the western side, are of identical origin, and have been separated by the action of water during many centuries. On these chains are the volcanoes and many thermal springs. The narrow space between them is for the most part, but not always, a cold and lofty region known as the "puna," containing alpine lakes,—the sources of the coast-rivers. The great eastern chain, rising from the basin of the Amazon and forming the inner wall of the system, is of distinct origin. These three chains are called the Maritime Cordillera, the Central Cordillera, and the Andes. Paz Soldan and other Peruvian geographers give the name of Andes, *par excellence*, to the eastern cordillera.

The Peruvian Maritime Cordillera contains a regular chain of volcanic peaks overlooking the coast-region of Tarapaca, which attain a height of 16,000 to 18,000 feet. Chief among them are the snowy peak of Lirima over the ravine of Tarapaca, the volcano of Ialuga overhanging Camiña, the unmeasured peak of Sehana, and Tacora near the Bolivian frontier. In rear of Moquegua there is a group of volcanic peaks, clustering round those of Ubinas and Huaynaputina. A great eruption of Huaynaputina commenced on 15th February 1600 and continued until the 28th. An incessant rain of fine white sand was poured over the surrounding country for a distance of 40 miles, accompanied by a mighty subterraneous roaring sound. But generally these volcanoes are quiescent. Farther north the Misti volcano rises over the city of Arequipa in a perfect cone to a height of over 18,000 feet, and near its base are the hot sulphur and iron springs of Yura. As the maritime chain advances northward it fully maintains its elevation. The peak of Sarasara, in Parinacochas (Ayacucho), is 19,500 feet above the sea, and in the mountains above Lima the passes attain a height of more

than 15,000. In latitude 10° S. the maritime chain separates into two branches, which run parallel to each other for 100 miles, enclosing the remarkable ravine or Callejon de Huaylas,—the eastern or main branch being known as the Cordillera Nevada and the western as the Cordillera Negra. On the Nevada the peak of Huascar reaches a height of 22,000 feet, according to the trigonometrical measurement of the railway engineer Hindle. The Huandoy peak, above Carhuaz, reaches to 21,065 feet; the Hualcan peak, overhanging the town of Yungay, is 19,945 feet high; and most of the peaks in this part of the chain reach a height of 19,000 feet. During the rainy season, from October to May, the sky is generally clear at dawn, and the magnificent snowy peaks, with sharply-defined outlines, stand out in lovely contrast to the deep-blue background. But as the day advances the clouds collect, and the whole is shrouded in a dense veil. In most parts of the Peruvian Andes the line of perpetual snow is at 16,400 feet above the sea; but in the Cordillera Nevada, above the Callejon de Huaylas, it sinks to 15,400 feet. This greater cold is obviously caused by the intervention of the Cordillera Negra, which intercepts the warmth from the coast. As this lower chain does not reach the snow-line, the streams rising from it are very scantily supplied with water, while the Santa Pativilca, and other coast-rivers which break through it from sources in the snowy chain have a greater volume from the melted snows. At the point where the river Santa breaks through the Cordillera Negra that range begins to subside, while the Maritime Cordillera continues as one chain to and beyond the frontier of Ecuador.

The Central Cordillera is the true water-parting of the system. No river, except the Marañon, breaks through it: either to the east or west, while more than twenty coast-streams rise on its slopes and force their way through the maritime chain. The Central Cordillera consists mainly of crystalline and volcanic rocks, on each side of which are aqueous, in great part Jurassic, strata thrown up almost vertically. In 14° 30' S. lat. the central chain is connected with the Eastern Andes by the transverse mountain-knot of Vilcañota, the peak of that name being 17,500 feet above the sea. The great inland basin of Lake Titicaca is thus formed. The central chain continues to run parallel with the Maritime Cordillera until, at Cerro Pasco, another transverse knot connects it with the Andes in 10° 30' S. lat. It then continues northward, separating the basins of the Marañon and Huallaga; and at the northern frontier of Peru it is at length broken through by the Marañon flowing to the eastward.

The Eastern Andes is a magnificent range in the southern part of Peru, of Silurian formation, with talcose and clay slates, many quartz veins, and eruptions of granitic rocks. Mr Forbes says that the peaks of Illampu (21,470 feet) and Illimani (21,040 feet) in Bolivia are Silurian and fossiliferous to their summits. The eastern range is cut through by six rivers in Peru, namely, the Marañon and Huallaga, the Perena, Mantaro, Apurimac, Vilcamayo, and Paucartambo, the last five being tributaries of the Ucayali. The range of the Andes in south Peru has a high plateau to the west and the vast plains of the Amazonian basin to the east. The whole range is highly auriferous, and the thickness of the strata is not less than 10,000 feet. It is nowhere disturbed by volcanic eruptions, except at the very edge of the formation near Lake Titicaca, and in this respect it differs essentially from the Maritime Cordillera. To the eastward numerous spurs extend for varying distances into the great plain of the Amazon. It is here that the majestic beauty of the Andean scenery is fully realized: masses of dark mountains rise for thousands of feet, with their bases washed by foaming torrents and their

summits terminating in sharp peaks or serrated ridges; the lower slopes are covered with dense vegetation; and everywhere there is flowing water in cascades or rushing torrents, the condensed moisture of the trade-winds hurrying back to the Atlantic. The Andes lose their majestic height to the northward; and beyond Cerro Pasco the eastern chain sinks into a lower range between the Huallaga and Ucayali. But throughout the length of Peru the three ranges are clearly defined.

For purposes of description the sierra of Peru may be conveniently divided into four sections, each embracing portions of all three ranges. The first, from the north, comprises the upper basins of the Marañon and the Huallaga, and is 850 miles long by 100 broad. The second extends from the Knot of Cerro Pasco to Ayacucho, about 200 miles, including the Lake of Chinchay-cocha and the basin of the river Xauxa. The third or Cuzco section extends 250 miles to the Knot of Vilcañota with the basins of the Pampas, Apurimac, Vilcamayu, and Paucartambo. The fourth is the basin of Lake Titicaca, about 160 miles in length and breadth.

The Lake of Chinchay-cocha, in the second section, is 36 miles long by 7 miles broad, and 13,000 feet above the sea. Its marshy banks are overgrown with reeds and inhabited by numerous water-fowl. From this lake the river Xauxa flows southwards through a populous valley for 150 miles before entering the forests. Lake Titicaca, in the fourth or most southern section, is about 80 miles long by 40 broad, the frontier of Bolivia passing across it diagonally. It is 12,545 feet above the sea by the railroad-levels. The drainage is carried off southwards by the river Desaguadero to the great swampy Lake of Aullagas in the south of Bolivia, while it is fed by streams from the Andes and the Central Cordillera. The largest is the Ramiz, formed by the two streams of Pucara and Azangaro, both coming from the Knot of Vilcañota to the north. The Suchiz, formed by the Cavaniña and Lampá streams, falls into the lake on the north-west side, as well as the Yllpa and Ylave. Much of the water flows out by the Desaguadero, but a great proportion is taken up by evaporation in the dry season from April to September. The waters are gradually receding under the combined influence of evaporation and the sediment brought down by the rivers. The deepest part of the lake is on the Bolivian side; in other parts it is very shoaly, and along the shore there are many acres of tall reeds. The principal islands are Titicaca and Coati (at the south end near the peninsula of Copacabana), Campanaria (9 miles from the east shore), Soto, and Esteves. There are two other lakes in the Collao, as the elevated region round Titicaca is called. Lake Atapa, a few miles from the northern shore of Titicaca, is 30 miles in circumference. Lake Umayo is on higher ground to the westward. The lake in Peru which is third in size is that of Parinacochas on the coast watershed, near the foot of the snowy peak of Sarasara. It is 12 miles long by 6 broad, but has never been visited and described by any modern traveller. The smaller alpine lakes, often forming the sources of rivers, are numerous.

The great rivers of the sierra are the Marañon, rising in the Lake of Lauricocha and flowing northward in a deep gorge between the Maritime and Central Cordilleras for 850 miles, when it forces its way through the mountains at the famous Pongo de Mauseriche and enters the Amazonian plain. The Huallaga rises north of Cerro Pasco, and, passing Huanuco, flows northwards on the other side of the Central Cordillera for 800 miles. It breaks through the range at the Pongo de Chasuta and falls into the Marañon. The other great rivers are tributaries of the Ucayali. The Foxuru, flowing eastward from the Knot of Cerro Pasco, joins the Pachites, which is the most northern important affluent of the Ucayali. The Xauxa, becoming afterwards the Mantaro, receives the drainage of Xauxa, Huancavelica, and Ayacucho. The southern valleys of this part of the sierra furnish streams which form the main rivers of Pampas, Pachachaca, and Apurimac. These, uniting with the Mantaro, form the Ene, and the Ene and Perene (which drains the province of Tambo) form the Tambo. The classic river of Vilcamayu rises on the Knot of Vilcañota, flows north through a lovely valley, receives the Yanatilde and Paucartambo on its right bank, and, uniting with the Tambo, forms the Ucayali. Most of these main streams flow through profound gorges in a tropical climate, while the upper slopes yield products of the temperate zone, and the plateaus above are cold and bleak, affording only pasture and the hardiest cereals.

The great variety of elevation within the sierra produces vegetation belonging to every zone. There is a tropical flora in the deep gorges, higher up a sub-tropical, then a temperate, then a sub-arctic flora. In ascending from the coast-valleys there is first an arid range, where the great-branched cacti rear themselves up among the rocks. Farther inland, where the rains are more plentiful, is the native home of the potato. Here also are other plants with edible roots—the "oca" (*Oxalis tuberosa*), "ullucus" (*Ullucus tuberosus*), "massua" (*Tropaeolum tuberosum*), and "learcé" (*Polyp.*

*nia sonchifolia*). Among the first wild shrubs and trees that are met with are the "chilca" (*Baccharis Fusillet*), with a pretty yellow flower, the *Mutisia acuminata*, with beautiful red and orange flowers, several species of *Senecio*, calcicolarias, the *Schinus Molle*, with its graceful branches and bunches of red berries, and at higher elevations the "lambras" (*Ainus acuminata*), the "sauco" (*Sambucus peruviana*), the "queñuar" (*Buddleia incana*), and the *Polyplepis racemosa*. The *Buddleia*, locally called "oliva silvestre," flourishes at a height of 12,000 feet round the shores of Lake Titicaca. The temperate valleys of the sierra yield fruits of many kinds. Those indigenous to the country are the delicious "chirimoyas," "paltas" or alligator pears, the "paccay," a species of *Inga*, the "lurma," and the "granadilla" or fruit of the passion-flower. Vineyards and sugar-cane yield crops in the warmer ravines; the sub-tropical valleys are famous for splendid crops of maize; wheat and barley thrive on the mountain slopes; and at heights from 7000 to 13,000 feet there are crops of "quinua" (*Chenopodium Quinua*). In the loftiest regions the pasture chiefly consists of a coarse grass (*Stipa Ychu*), of which the llamas eat the upper blades while the sheep browse on the tender shoots beneath. There are also two kinds of shrubby plants, a thorny *Composita* called "canllí" and another called "tola," which is a resinous *Baccharis*, and is used for fuel.

The animals which specially belong to the Peruvian Andes are the domestic llamas and alpacas and the wild vicuñas. There are deer, called "taruco" (*Cervus antisensis*), the "viscacha," a large rodent, a species of fox called "atoc"; and the "puma" (*Felis concolor*) and "ucumari" or black bear with a white muzzle, when driven by hunger, wander into the loftier regions. The largest bird is the condor, and there is another bird of the vulture tribe, with a black and white wing feather, formerly used by the Yncas in their head-dress, called the "coraqueñue" or "alcamari." The "pito" is a brown speckled creeper which flutters about the rocks. There is a little bird, the size of a starling, with brown back striped with black, and white breast, which the Indians call "yncahuapa"; it utters a monotonous sound at each hour of the night. A partridge called "yutu" frequents the long grass. On the lakes there is a very handsome goose, with white body and dark-green wings shading into violet, called "huachua," two kinds of ibis, a large gull (*Larus serranus*), frequenting the alpine lakes in flocks, flamingoes called "parihuana," ducks, and water-hens. Many pretty little finches fly about the maize-fields and fruit-gardens, and a little green parakeet is met with as high as 12,000 feet above the sea.

The third division of Peru is the region of the tropical forests, at the base of the Andes, and within the basin of the Amazons. It is traversed by great navigable rivers. The Marañon, having burst through the defile of the Pongo de Mauseriche, and the Huallaga through that of Chasuta, enter the forests and unite after separate courses of about 600 and 400 miles, the united flood then flowing eastward to the Brazilian frontier. After 150 miles it is joined by the Ucayali, a great navigable river with a course of 600 miles. The country between the Huallaga and the Ucayali, traversed by the eastern cordillera, is called the Pampa del Sacramento. The forests drained by the Marañon, Huallaga, and Ucayali form the northern portion of the Peruvian montaña. The southern half of the montaña is watered by streams flowing from the Eastern Andes, which go to form the river Madre de Dios or Amaru-mayu, the principal branch of the river Beni, which falls into the Madeira. The region of the Peruvian montaña, which is 800 miles long from the Marañon to the Bolivian frontier, is naturally divided into two sections, the sub-tropical forests in the ravines and on the eastern slopes of the Andes and the dense tropical forests in the Amazonian plain. The sub-tropical section is important from the value of its products, and interesting from the grandeur and beauty of its scenery. Long spurs run off from the Andes, gradually decreasing in elevation, and it is sometimes a distance of 60 or 80 miles before they finally subside into the vast forest-covered plains of the Amazon basin. Numerous rivers flow through the valleys between these spurs, which are the native home of the quinine-yielding chinchona trees. The most valuable species, called *C. Calisaya*, is found in the forests of Carabaya in south Peru and in those of Bolivia. The species between Carabaya and the head-waters of the Huallaga yield very little of the febrifuge alkaloid. But the forests of Huanuco and

Humalies abound in species yielding the grey bark of commerce, which is rich in chinchonine, an alkaloid efficacious as a febrifuge, though inferior to quinine. With the chinchona trees grow many kinds of *Melastomaceæ*, especially the *Lasiandra*, with masses of purple flowers, tree-ferns, and palms. In the warm valleys there are large plantations of coca (*Erythroxylon Coca*), or *CUCA* (see vol. vi. p. 684), the annual produce of which is stated at 15,000,000 lb. The other products of these warm valleys are most excellent coffee, cocoa, sugar, tropical fruits of all kinds, and gold in great abundance. In the vast untrodden forests farther east there are timber trees of many kinds, incense trees, a great wealth of india-rubber trees of the *Hevea* genus, numerous varieties of beautiful palms, sarsaparilla, vanilla, ipecacuanha, and copaiba. The abundant and varied fauna is the same as that of the Brazilian foresta.

**Population.**—The earliest reliable enumeration of the people of Peru was made in 1793, when there were 617,700 Indians, 241,225 mestizos (Indian and white), 136,311 Spaniards, 40,337 negro slaves, and 41,404 mulattoes, giving a total of 1,076,977 souls, without counting the wild Indians of the montaña. The ecclesiastics numbered 5496, including 1260 nuns. This tells a sad story of depopulation since the fall of the Yncas, to which the abandoned terraces on the mountain-sides, once highly cultivated, bear silent testimony. In 1862 the population was officially estimated at 2,487,716. The latest census was taken in 1876 with much care. The result was 2,673,075 souls (males 1,352,151, females 1,320,924); of these 57 per cent. were Indians, 23 per cent. mestizos, and 20 per cent. of Spanish descent, negroes, Chinese, and foreigners: so that Peru is still the country of the Ynca people.

**Political Divisions.**—The empire of the Yncas was divided into four main divisions, Chinchay-suyu to the north of Cuzco, Anti-suyu to the east, Colla-suyu to the south, and Cunti-suyu to the west, the whole empire being called Tliahuanstin-suyu, or the four governments. Each was ruled by a viceroy, under whom were the "huaranca-camayocs," or officers ruling over thousands, and inferior officers, in regular order, over 500, 100, 50, and 10 men. All disorders and irregularities were checked by the periodical visits of the "tucuyricocs" or inspectors. The Spanish conquest threw this complicated system out of gear. In 1569 the governor, Lope Garcia de Castro, divided Peru into "corregimientos" under officers named "corregidores," of whom there were 77, each in direct communication with the Government at Lima. An important administrative reform was made in 1784, when Peru was divided into 7 "intendencias," each under an officer called an "intendente." These "intendencias" included about 6 of the old "corregimientos," which were called "partidos," under officers named "sub-delegados." Thus the number of officers reporting direct to Lima was reduced from 77 to 7, a great improvement. The republic adopted the same system, calling the "intendencias" "departments" under a prefect, and the "partidos" "provinces" under a sub-prefect. Peru is divided into 18 departments, 2 littoral provinces, and what is called the constitutional province of Callao. The departments contain 95 provinces. The Government recognizes 65 cities, 70 towns, 1337 smaller towns, 641 villages, 40 hamlets on the sea-coast, and 600 in the rural districts. The departments (going from north to south) are:—

Coast.	Sierra.	Montaña.
Piura.	Caxamarca.	Amazonas and Loreto.
Lambayeque.	Huanuco.	
Libertad.	Junin.	
Ancacha.	Huancavelica.	
Lima.	Ayacucho.	
Yca.	Apurimac.	
Arequipa.	Cuzco.	
Moquegua.	Puno.	
Tacna.		

**Towns and Seaports.**—The principal towns on the coast, except Payta, Callao, and Arica, are always some distance from the seashore. San Miguel de Piura, founded by Pizarro in 1532, is on the river of the same name. The towns in all parts of Peru are built on the same plan where the ground will allow of it, in squares or "quadras," with the streets at right angles, and a quadrangular open space or "plaza," one side being occupied by the principal church, near the centre. The church usually has an ornamental façade in the Renaissance style, with two towers. The houses on the coast are flat-roofed, with folding doors to the street, leading to a court or "patio," with rooms opening on it. Piura is a town of this class. Farther south are the cities of Lambayeque, Chiclayo, and Saña. Truxillo, founded by Pizarro in 1535, is of more importance. It is of oval shape, and was surrounded by walls with fifteen bastions, built in 1686, which have recently been demolished. Besides the cathedral, seat of a bishopric founded in 1609, there are three churches, and formerly four monasteries and a Jesuit college. Truxillo is the most important city north of Lima.

To the north of Lima there are five principal ports and thirteen smaller ones. Payta has a good anchorage and exports the cotton of the Chira and Piura valleys, the anchorages of Tumbex to the north and Sechura to the south being subsidiary to it. Pimentel is the port for the valleys of Lambayeque and Chiclayo, and Eten for that of Ferreñafe, the older port of San José having been abandoned as more dangerous. Pacasmayo, also a precarious anchorage, is the port which taps the rich valley of Jequetespeque. Farther south Malabrigo is the port for the valley of Chicama. Huanchaco was formerly the port for Truxillo, but Salaverry, a few miles to the south, has been substituted as affording a safer anchorage. Santiago de Chao and Guañape in the Viru district are lesser ports, the latter being resorted to by ships loading with guano at the adjacent islands. Chimbote, in the bay of Ferrol, has a good anchorage, and is important as the principal outlet for the Santa valley and the department of Ancacha. Farther south are the lesser ports of Santa, Samanco, Casma, Huarney, Supé, Huacho, Chancay, and Ancón.

Lima, the capital (see vol. xiv. p. 644), according to the census of 1876 had a population of 100,046, of whom 33,020 were of European descent, 23,010 half-castes, 19,630 Indians, 15,378 foreigners, and 9008 negroes. South of Lima are the cities of Chinchu and Yca, with the principal seaport of Pisco, whence the wines and spirits of the adjacent valleys are exported. The small ports of Cerro Azul and Tambo Mora export the sugars of the Cañete and Chinchu valleys. Farther south the exposed port of Chala, with a bad anchorage, is used for the valley of Acari and the province of Parinacochas in the mountains. South-east of Yca are the charming agricultural towns of Palpa and Nasca. AREQUIPA (see vol. ii. p. 484), the most important coast-city south of Lima, was founded by Pizarro in 1536. South of Arequipa is the littoral province of Moquegua, with a pleasant town, the centre of a vine-growing industry. The cities of Tacna, Arica, and Iquique are in the Chilean province of Tarapaca. The ports of Arequipa were formerly Quilca, then Ilay, and now Mollendo. Ylo and Pacocha, in the same bay, are the ports of Moquegua; Saña, under the lofty headland of the same name, is a port where landing is impossible except in "balsa," and it is little used. Arica was a very important port before the Chilean invasion, as through it passed all the trade to Bolivia. Iquique and Pisagua are the chief ports of Tarapaca, the others being Junin, Mexillones, Molla, Chucumata, Patilloa, In the sierra there is the same regularity in intention in laying out the plan of the towns, but it is often interceded



with by the irregularity of the ground. High-pitched red tiled roofs take the place of the flat roofs of the coast. The upper stories often recede, leaving wide corridors under the overhanging eaves, and in the "plazas" there are frequently covered arcades. Fruit-gardens and fields waving with lucerne and barley encircle the towns, and there is almost always a background of mountain-ranges. The principal interior towns in the north of Peru are Caxamarca, Huaraz, Huanuco, Cerro Pasco, the centre of the great silver-mining industry, 13,200 feet above the sea, Tarma, and Xauxa. Huancavelica owed its existence to the famous quicksilver mine. Ayacucho, formerly Guamanga, founded by Pizarro in 1539, is a charming abode amidst lovely scenery. Between Ayacucho and Cuzco are the pleasant towns of Andahuaylas and Abancay. Cuzco (see vol. vi. p. 744), the centre of Peru, the old capital of the Incas, lies at the foot of the famous hill of Sacsahuaman. South of Cuzco are many delightful places in the vale of Vilcamayu, and the towns in the Collao, the chief being Puno on the shore of Lake Titicaca.

**Commerce.**—The resources of Peru consist of its mineral wealth, its flocks, yielding valuable wool, its crops, and the products of its virgin-forests. Silver-mines extend along the whole length of the cordilleras from Hualgayoc to Puno. The mines are worked here and there, the great centre of this industry being at Cerro Pasco, where 1,427,592 ounces of silver were produced in 1877. The value of the silver exported from Peru in that year was £575,000, of copper £330,000; of gold there is no return. The exportation of guano from the Chincha Islands began in 1846 and continued until 1872. Between 1853 and 1872 there were 8,000,000 tons shipped from these islands. The deposits on the Guahape Islands were first worked in 1869, and from that year to 1871 as many as 838,858 tons were shipped,—460,000 tons remaining. On the three Macabi Islands there were 400,000 tons of guano in 1872, and large deposits on the Lobos Islands. But the most important discoveries of guano-deposits, since the exhaustion of the Chincha Islands, have been on the coast of Tarapaca. In 1876 the quantity at Pabellon de Pica was calculated at 850,000 tons, at Punta de Lobos 200,000 tons, at Huanillos 1,000,000 tons (buried under huge boulders of rock), at Chipana 250,000 tons. The total quantity of guano on islands north of Lima may be 600,000 tons, and on the coast of Tarapaca 1,800,000 tons.

Since 1830 nitrate of soda has been exported from the southern parts of Peru, the deposits being found on the western side of the Pampa de Tamarugal in Tarapaca. This region contains sufficient nitrate for the supply of Europe for ages. From 1830 to 1850 the export from Iquique amounted to 239,860 tons; in 1875 the annual export reached its maximum (326,869 tons).

The sugar cultivation in the coast-valleys is a great source of wealth. In 1877 the yield was estimated at 85,000 tons, valued at £1,360,000; of this quantity 63,370 tons went to Great Britain. Cotton, an indigenous product of the coast-valleys, is next in importance to sugar, the estates being worked with intelligence and a due outlay of capital. The cultivation of the vine is also a profitable industry,—a well-known spirit and excellent wine being made in the valleys of Pisco and Yca, and in the districts of Majes and Moquegua. Rice-crops are raised at Ferreñafe; olives are grown largely in the Tambo valley; and the silk-worm and cochineal insect have been successfully cultivated. In the sierra large quantities of wheat, barley, and potatoes are raised, and millions of pounds of alpaca and sheep's-wool are exported. From the forests of the mountains come chinchóna bark, coca, coffee of the finest quality, cocoa, india-rubber, and some medicinal roots.

**Communication.**—Several railroads have been constructed of late years to connect the coast-towns and valleys with their seaports. That from Payta to Piura, contracted for in 1872, is 63 miles long; one from the port of Pimental to Chiclayo and Lambayeque has a length of 45 miles. There are 50 miles of railway from Eten to Ferreñafe, 93 from Pacasmayo to Magdalena, 25 from Malabrigo to Ascope and the Chicamayo valley, 85 from Selaverry to Truxillo, 172 from Chimbote to Huaraz (only 52 finished). Several short lines radiate from Lima. A line from Pisco to Yca is 48 miles long, from Mollendo to Arequipa 107, from Ylo to Moquegua 63 miles, from Arica to Tacna 39 miles; and there are railroads in Tarapaca connecting the nitrate-works with the ports of Pisagua, Iquique, and Patillos. At Cerro Pasco a short line, begun in 1869, connects the silver-mines with the town. A railroad was commenced in 1870, from Callao and Lima, across the western and central cordilleras to Oroya, 12,178 feet above the sea in the valley of Xauxa, a distance of 136 miles. It ascends the valley of the Rimac, rising nearly 5000 feet in the first 46 miles. It then threads intricate gorges of the Andes, along the edges of precipices and over deep chasms. It

tunnels the Andes at a height of 15,645 feet. There are sixty-three tunnels, and the bridge of Verrugas spans a chasm 580 feet wide, resting on three piers, the centre one being 252 feet high, made of hollow wrought-iron. This great work is completed (1884) as far as Chicla, a distance of 86½ miles. Another railroad across the Andes connects Arequipa with Puno on the shores of Lake Titicaca. The summit is crossed in a cutting only 6 feet deep, 14,660 feet above the sea. The first locomotive reached Puno on 1st January 1874. The line is 232 miles long, and is to be prolonged to Cuzco. The cost of the Oroya line has been £4,625,887, and of the Arequipa and Puno line £4,346,659.

Two steamers were launched on Lake Titicaca in March 1874, which carry the traffic from Bolivia to Puno. Extensive harbour-works have been completed at Callao since 1870; and iron piers have been constructed at other ports. Steam communication connects the Peruvian ports on the Huallaga and Marañon with the Brazilian line at Tabatinga.

**Education and Literature.**—Universities and colleges were founded in Peru very soon after the conquest, and there was intellectual progress both among the Indians and the families of Spanish descent. The university of San Marcos at Lima is the most ancient in the New World, having been created by order of Charles V. in 1551. The college of San Carlos was founded in 1770, and the school of medicine in 1792. At Cuzco the university of San Antonio Abad was founded in 1598, and the college of San Geronimo at Arequipa in 1616. Since the independence there has been very considerable intellectual and educational progress in the country. There is a university of the first rank at Lima, 5 lesser universities, 33 colleges for boys and 18 for girls, 1578 schools for boys and 729 for girls, besides private schools. The most prolific author in Spanish times was Dr Pedro de Peralta y Barnuevo, author of an epic poem called *Lima Fundada* and many other works. Towards the latter end of the last century scientific studies began to receive attention in Peru. M. Godin, a member of the French commission for measuring an arc of the meridian near Quito, became professor of mathematics at San Marcos in 1750; and the botanical expeditions sent out from Spain gave further zest to scientific research. Dr Gabriel Moreno (died 1809), a native of Huamantanga in the Maritime Cordillera, studied under Dr Jussieu, and became an eminent botanist. Don Hipolito Unanue, born at Arica in 1756, wrote an important work on the climate of Lima and contributed to the *Mercurio Peruano*. This periodical was commenced in 1791 at Lima, the contributors forming a society called "Amantes del País," and it was completed in eleven volumes. It contains many valuable articles on history, topography, botany, mining, commerce, and statistics. An ephemeris and guide to Peru was commenced by the learned geographer Dr Cosme Bueno, and continued by Dr Unanue, who brought out his guides at Lima from 1793 to 1798. In 1794 a nautical school was founded at Lima, with Andres Baleato as instructor and Pedro Alvarez as teacher of the use of instruments. Baleato also constructed a map of Peru. A list of Peruvian authors in viceregal times occupies a long chapter in the life of St Toribio<sup>1</sup> by Montalvo; and the bibliographical labours of the Peruvian Leon Pinelo are still invaluable to Spanish students.

The topographical labours of Cosme Bueno and Unanue were ably continued at Lima by Admiral Don Eduardo Carrasco, who compiled annual guides of Peru from 1826. But the most eminent Peruvian geographer is Dr Don Mariano Felipe Paz Soldan, whose *Geografía del Perú* appeared in 1862. His still more important work, the *Diccionario geográfico estadístico del Perú* (1877), is a gazetteer on a most complete scale, displaying an immense amount of labour, research, and literary skill. In 1868 appeared his first volume of the *Historia del Perú Independiente*, and two others have since been published. The earlier history of Peru has been written in three volumes by Sebastian Lorente; Mariano Rivero has ably discussed its antiquities; and Manuel Fuentes has edited six interesting volumes of memoirs written by Spanish viceroys. But the most valuable and important historical work by a modern Peruvian is undoubtedly General Mendiburu's *Diccionario Histórico-Biográfico del Perú*, a monument of patient and conscientious research, combined with critical discernment of a high order, which has certainly secured for its accomplished author a permanent place in the history of literature. As laborious historical students, Don José Toribio Polo, the author of an ecclesiastical history of Peruvian dioceses, and Don Enrique Torres Saldamando, the historian of the Jesuits in Peru, have great merit. Among good local annalists may be mentioned Juan Gilberto Valdivia, who has written a history of Arequipa, and Pio Benigno Mesa, the author of the *Anales de Cuzco*.

The leading Peruvian authors on constitutional and legal subjects are Dr José Santistevan, who has published volumes on civil and criminal law; Luis Felipe Villaran, author of a work on con-

<sup>1</sup> The city of Lima produced two saints, the archbishop St Toribio, who flourished from 1578 to 1608, and Santa Rosa, the patron saint of the city of the kings (1586-1616), whose festival is celebrated on 26th August.

stitutional right; Dr Francisco Garcia Calderon (late president of Peru), author of a dictionary of Peruvian legislation in two volumes; Dr Francisco Xavier Mariategui, one of the fathers of Peruvian independence; and Dr Francisco de Paula Vivil (died 1875), orator and statesman as well as author, whose work *Defensa de los Gobiernos* is a noble and enlightened statement of the case for civil governments against the pretensions of the court of Rome. Manuel A. Fuentes, an able statistician and the author of the *Estadística de Lima*, has also written a manual of parliamentary practice.

On the whole, Peruvian literature since the independence has attained to highest merit in the walks of poetry and romance. The Guayaquil author Olmedo, who wrote the famous ode on the victory of Junin, and the Limenians Felipe Pardo and Manuel Segura are names well known wherever the Spanish language is spoken. Pardo, as well as Segura, wrote in a satirical vein. Both died between 1860 and 1870. The comedies of Segura on the customs of Lima society, entitled *Un Paseo a Amancaesca* and *La Suya y Manío*, have no equal in the dramatic literature of Spanish America and few in that of modern Spain. From 1848 date the first poetical efforts of Arnaldo Marquez, Manuel Nicolas Corpancho, Adolfo Garcia, Clemente Althaus, Pedro Paz Soldan (better known under his nom de plume of "Juan de Arona"), Carlos Augusto Salaverry, a son of the ill-fated general, Luis Benjamin Cisneros, Trinidad Fernandez, Constantino Carrasco, Narciso Arestegui, José Antonio Lavalle, Ricardo Palma, and Numa Pompilio Llona. Marquez is undoubtedly the most correct in diction and the most richly endowed with imaginative sentiment among Peruvian poets of the present generation. Corpancho was a dramatist of the romantic school and author of a bright little volume of poems entitled *Brevés*. He perished in a shipwreck off the coast of Mexico when barely thirty years old. Adolfo Garcia is the poet of most robust and vigorous thought, and he has written much, but only one volume of his select poems has been published (Havre, 1870). Among other productions of great merit this book contains a sonnet to Bolivar, which is one of the most beautiful that has appeared from the muse of Peru. Althaus (d. 1880) was a poet, imaginative, tender, elegant, and very careful as regards rhythm and diction. Paz Soldan, a good classical scholar, has published three volumes of poems. Salaverry is one of Peru's best lyrical poets; and the novels of Cisneros, entitled *Julia* and *Edgardo*, have secured him a lasting reputation. Fernandez and Carrasco were two poets of merit who died very young. The principal work of Carrasco was his metrical version of the Quichua drama of *Ollantay*. Lavalle and Arestegui are chiefly known as novelists. Palma has published three books of poetry, entitled *Armonías*, *Verbo y Gerundio*, and *Pasionarias*. Since 1870 he has devoted his great literary powers to writing the historical traditions of Peru in prose, of which six volumes have already appeared. They display great research, and are written in a graceful and agreeable style. Palma is a member of the Spanish Academy, a distinction shared, among Peruvian poets, with Felipe Pardo. The collected poems of Llona have recently been published; his *Canto de la Vida* is highly spoken of for its depth of thought and elegance of diction.

Peruvians have not neglected their early history and the study of the literature and language of the Yncas. Several have followed in the footsteps of Rivero. José Sebastian Barranca, the naturalist and antiquary, and Gavino Pacheco Zagarra, a native of Cuzco, have published translations of the ancient Ynca drama of *Ollantay*.

Among Peruvian naturalists since the independence the most distinguished have been Rivero, the geologist and mineralogist, and his friend and colleague Nicolas de Pierola, author of *Memorial de Ciencias Naturales*. Dr Cayetano Heredia, rector of the college of medicine in Lima from 1845 to his death in 1861, was an ardent patron of medical science. His successor, Dr Miguel de los Rios, has followed in his footsteps; and since 1856 many valuable contributions have been published by Peruvian physicians in the *Gaceta Médica de Lima*.

The most prominent publicists of Peru have been Mariategui, Vivil, Reynaldo and Cesario Chalcatana, Ricardo Heredia, José Casimiro Ulloa, Toribio Pacheco, and Luciano Cisneros.

The Peruvian priesthood, though justly accused of tyranny in their relations with the Indians in early times, and of immorality in many instances, can point to numerous learned and upright prelates, to devoted parish priests, to noble-minded teachers and ardent patriots, in their body. Founded in 1541, and raised to archiepiscopal rank in 1545, the see of Lima has been ruled by twenty-three prelates. The first was a Dominican friar, Dr Geronimo de Loaysa (1542-1575), who was more a politician than a priest. But the second, Dr Toribio Mogrovejo (1581-1606), devoted himself to the welfare of his flock, and died in the odour of sanctity, being finally canonized as St Toribio. Since the independence, Archbishop Luna Pizarro has added lustre to the see by his learning and ability. The bishopric of Cuzco was founded by Pope Paul III. in 1537, and has had twenty-seven prelates. Among them, Dr Gorrichategui (1771-76) was an excellent Quichua scholar and preacher and a devoted friend of the oppressed Indians; Dr Moscoso y Peralta (1777-89) was a prelate of consummate virtue and learning. The

bishoprics of Arequipa, Guamanga (Ayacucho), and Truxillo were created in 1600. The missionary bishopric of Maynas or Chachapoyas was founded in 1802, those of Huanuco and Puno in recent times. The Jesuits were once very powerful and wealthy in Peru, and both Jesuits and Franciscans, while working at their calling as missionaries, achieved much valuable geographical work on the rivers and in the forests of the montaña. Since the independence the religious orders have been gradually suppressed, yet monks as well as priests were in the front rank in advocating the cause of liberty. The ecclesiastical seminary at Lima, founded by St Toribio in 1601, was removed to part of the monastery of San Francisco in 1853, where it still flourishes, and where youths intended for holy orders are educated. The priests occupy a very important position in the social system, and much of the teaching is in their hands. Such men as Luna Pizarro and Vivil have performed their duties in a singularly faithful and enlightened spirit. Unfortunately there is still deplorable laxity among parish priests, though there are many noble exceptions.

*Inhabitants*.—The early inhabitants of Peru originally consisted of several distinct nations, subdivided into many tribes, which were eventually combined in the empire of the Yncas. The principal race was that of the imperial Yncas themselves, inhabiting the two central sections of the sierra, from the Knot of Cerro Pasco to that of Vilcañota, a distance of 380 miles. Here nature has worked her grandest and most imposing scale. The scenery is magnificent, the products of every zone are collected in the valleys and on the mountain-sides; but the difficulties in the way of advancing civilization, caused by the obstacles of nature, are such as to try man's ingenuity to the utmost. A country like this was well adapted for the cradle of an imperial race. Six nations originally peopled this central mountain-region—the Yncas in the valley of the Vilcamayu and surrounding plateaus, the Canas round the sources of the Apurimac, the Quichuas along the upper courses of the Pachachaca and the Apurimac, the Chancas, a very warlike people from Guamanga to the Apurimac, the Huancas in the valley of the Xauxa, and the Rucanas round the summits and on the slopes of the Maritime Cordillera. These six nations were divided into "syllus" or tribes, the most distinct of which were the still feroce Morochucos and Yquichanos, brave mountaineers of the Chaca nation. There are reasons for believing that these nations spoke different languages, especially the Chancas, but, excepting a few words imbedded in the general language of the Yncas, they are now lost.

In the basin of Lake Titicaca there was another race, anciently called Colla, but now better known as Aymara. Their language survives, and, though closely allied grammatically, the vocabulary differs from that of the Yncas. Within the Colla region, differing from the rest of the inhabitants both in language and physical appearance, there was a savage tribe called Uru, inhabiting the reed-beds and islands in the southern part of Lake Titicaca. In the region north of the Knot of Cerro Pasco comprising the basin of the Marañon there were many warlike tribes speaking a language which the Yncas called Chinchaynu. The most important of these tribes were the Conchucos, Huamachuco, and Ayabaco far to the north.

The Peruvian coast appears originally to have been inhabited by a diminutive race of fishermen called Changos, a gentle and hospitable people, never exceeding 5 feet in height, with flat noses. They fished in boats made of inflated seal-skins, lived in seal-skin huts, and slept on heaps of dried seaweed. Vestiges of this race may be traced in the far south, as well as at Eten, Morca, and Catacaos in the north. The later and more civilized coast-people were a very different and an extremely interesting race. They appear to have formed distinct communities in the different valleys each under a chief, of whom the most civilized and powerful was the Chimú, who ruled over the five valleys of Pativilca, Huancabamba, Santa, Viru, and Moche, where Truxillo now stands. The subject of this prince made great advances in civilization, and his vast palaces near Truxillo now form extensive ruins. The irrigator works of this coast-people were most elaborate; every acre of cultivable ground was brought under cultivation, and water was conveyed at high levels from great distances. The Yncas called this people Yncas, but they have entirely passed away, giving place to the negroes and Chinese labourers who now swarm in the coast-valleys. There is no dictionary of the Ynca language, but there is a grammar and a short list of words written in 1644, before it had entirely ceased to be spoken.

The Ynca or Quichua tribes of the Andes of Peru average a height of 5 feet to 5 feet 6 inches. They are of slender build, but with well-knit muscular frames, and are capable of enduring great fatigue. Their complexions are of a fresh olive-colour, skin very smooth and soft, beardless, hair straight and black, the nose aquiline. They are good cultivators, and excel as shepherds by reason of their patience and kindness to animals. They are naturally gentle, most affectionate to their families, with an intense love of home; but at the same time they are enduring and brave. The Aymaras are more thick-set than the Yncas, and their chief phy-

sical peculiarity is that the thigh, instead of being longer, is rather shorter than the leg. The whole build is admirably adapted for mountain-climbing.

The policy of the Incas was to enforce the use of their language, called by the earliest Spanish grammarian "Quichua," among all the conquered tribes. Hence its very general use throughout the mountainous part of Peru, the only differences being the survival of words in some of the districts from the language or dialect that was superseded. Quichua was the language of a people far advanced in civilization; it was assiduously cultivated by learned men for several centuries; not only songs but elaborate dramas and rituals were composed in it; and it is still the language of the majority of the people of Peru. Aymara, which is a closely-allied tongue, is spoken along the shores of Lake Titicaca.

The wild Indians of the montañas, except a few tribes on the skirts of the Andes, do not belong to the Peruvian family. They are part of the great Tupi group of nations, and belong to the region of the Amazona. On the banks of the Hualaga are the Cocomas, Cholones, Panos, and Motilonas; and on the Ucayali the wild tribes of the Cashibos, Capahuans, Remos, Amajuacas, and Mayorunas. The Conibos, Pirros, Senoia, Setebos, and Shipibos are peaceful traders. The Antis or Campes form a large and important tribe on the upper course of the Ucayali, with probably a large share of Ynca blood in their veins. The savage Indians on the tributaries of the Beni are called Chunchoa. It is, however, to another family of the American race that the tribes of the Amazona mainly belong.

*History.*—Cyclopean ruins of vast edifices, apparently never completed, exist at Tiahuanaco near the southern shore of Lake Titicaca. Remains of a similar character are found at Huaras in the north of Peru, and at Cuzco, Ollantay-tambo, and Huilca between Huaras and Tiahuanaco. These works appear to have been erected by powerful sovereigns with unlimited command of labour, possibly with the object of giving employment to subjugated people, while feeding the vanity or pleasing the taste of the conqueror. Their unfinished state seems to indicate the break-up of the Government which conceived them and which must have held sway over the whole of Peru, and the occurrence of Aymara words, especially in the names of places over the whole area, points to an Aymara origin for this lost and prehistoric empire. It is certain that for ages afterwards the country was again broken up into many separate nations and tribes. Then the most civilized and most powerful people, the Incas of Cuzco and the Vilcamayu, began slowly to build up and cement together a later and more civilized empire. This great work, which probably occupied five centuries, was just completed when the Spaniards discovered Peru. The history of Ynca civilization has yet to be written. Our knowledge even of the Spanish writers who collected information at the time of the conquest is still very incomplete. Much that is essential for a correct appreciation of this interesting subject is still inedited and in manuscript. But, to comprehend it, a knowledge is also necessary of the people, of their country and languages. Without such qualifications for the task, the numerous traditions, customs, and beliefs cannot be understood nor assigned to the particular epochs and nationalities to which each belonged. With our existing imperfect knowledge the subject cannot be adequately treated without a detailed and critical examination of conflicting evidence which would be foreign to the purpose of the present article.

The great Ynca Huayna Capac died in 1527, the year when Pizarro first appeared on the coast. His consolidated empire extended from the river Ancasmayu north of Quito to the river Maule in the south of Chili. The Incas had an elaborate system of state-worship, with a ritual, and frequently recurring festivals. History and tradition were preserved by the barlas, and dramas were enacted before the sovereign and his court. Roads with post-houses at intervals were made over the wildest mountain-ranges and the bleakest deserts for hundreds of miles. A well-considered system of land-tenure and of colonization provided for the wants of all classes of the people. The administrative details of government were minutely and carefully organized, and accurate statistics were kept by means of the "quipus" or system of knots. The edifices displayed marvellous building skill, and their workmanship is unsurpassed. The world has nothing to show, in the way of stoneworking and fitting, to equal the skill and accuracy displayed in the Ynca structures of Cuzco. As workers in metals and as potters they displayed infinite variety of design, though not of a high order, while as cultivators and engineers they in all respects excelled their European conquerors.

The story of the conquest has been told by Prescott and Hays, who give ample references to original authorities; it will be sufficient here to enumerate the dates of the leading events. On 10th March 1526 the contract for the conquest of Peru was signed by Almagro and Luque, Gaspar de Espinosa supplying the funds. In 1527 Francisco Pizarro, after enduring fearful hardships, first reached the coast of Peru at Tumbes. In the following year he went to Spain, and on 26th July 1529 the capitulation with the crown for the conquest of Peru was executed. Pizarro sailed from

San Lucar with his brothers in January 1530, and landed at Tumbes in 1532. The civil war between Huascar and Atahualpa, the sons of Huayna Capac, had been fought out in the meanwhile, and the victorious Atahualpa was at Caxamarca on his way from Quito to Cuzco. On 16th November 1532 Francisco Pizarro with his little army entered Caxamarca and in February 1533 his colleague Almagro arrived with reinforcements. The murder of the Ynca Atahualpa was perpetrated on 29th August 1533, and on 15th November Pizarro entered Cuzco. He allowed the rightful heir to the empire, Manco the legitimate son of Huayna Capac, to be solemnly crowned on 24th March 1534. Almagro then undertook an expedition to Chili, and Pizarro founded the city of Lima on 18th January 1535. In the following year the Incas made a brave attempt to expel the invaders, and closely besieged the Spaniards in Cuzco during February and March. But Almagro, returning from Chili, raised the siege on 18th April 1537. Immediately afterwards the dispute arose between the Pizarros and Almagro as to the limits of their respective jurisdictions. An interview took place at Mala, on the sea-coast, on 13th November 1537, which led to no result, and Almagro was finally defeated in the battle of Las Salinas near Cuzco on 26th April 1538. His execution followed. His adherents recognized his young half-caste son, a gallant and noble youth generally known as Almagro the Lad, as his successor. Bitterly discontented, they conspired at Lima and assassinated Pizarro on 26th June 1541. Meanwhile Vaca de Castro had been sent out by the emperor, and on hearing of the murder of Pizarro he assumed the title of governor of Peru. On 16th September 1542 he defeated the army of Almagro the Lad in the battle of Chupas near Guamanga. The ill-fated boy was beheaded at Cuzco.

Charles V. enacted the code known as the "New Laws" in 1542. "Encomiendas," or grants of estates on which the inhabitants were bound to pay tribute and give personal service to the grantee, were to pass to the crown on the death of the actual holder; a fixed sum was to be assessed as tribute; and forced personal service was forbidden. Blasco Nunez de Vela was sent out, as first viceroy of Peru, to enforce the "New Laws." Their promulgation aroused a storm among the conquerors. Gonzalo Pizarro rose in rebellion, and entered Lima on 28th October 1544. The viceroy fled to Quito, but was followed, defeated, and killed at the battle of Anaquito on 18th January 1546. The "New Laws" were weakly revoked, and Pedro de la Gasca, as first president of the Audiencia (court of justice) of Peru, was sent out to restore order. He arrived in 1547, and on 8th April 1548 he routed the followers of Gonzalo Pizarro on the plain of Xaquixaguana near Cuzco. Gonzalo was executed on the field. La Gasca made a redistribution of "encomiendas" to the loyal conquerors, which caused great discontent, and left Peru before his scheme was made public in January 1550. On 23d September 1551 Don Antonio de Mendoza arrived as second viceroy, but died at Lima in the following July. The country was then ruled by the judges of the Audiencia, and a formidable insurrection broke out, headed by Francisco Hernandez Giron, with the object of maintaining the right of the conquerors to exact forced service from the Indians. In May 1554 Giron defeated the army of the judges at Chuquinga, but he was hopelessly routed at Pucara on 11th October 1554, captured, and on 7th December executed at Lima. Don Andres Hurtado de Mendoza, marquis of Cañete, entered Lima as third viceroy of Peru on 6th July 1555, and ruled with an iron hand for six years. He at length brought the turbulent conquerors to their knees. All the leaders in former disturbances were put on board a ship at Callao and sent to Spain. Corregidores, or governors of districts, were ordered to try summarily and execute every turbulent person within their jurisdictions. All unemployed persons were sent on distant expeditions, and moderate "encomiendas" were granted to a few deserving officers. The previous anarchy was thus completely stamped out. At the same time the viceroy wisely came to an agreement with Sayri Tupac, the son and successor of the Ynca Manco, and granted him a pension. He took great care to supply the natives with priests of good conduct, and promoted measures for the establishment of schools and the foundation of towns in the different provinces. The cultivation of wheat, vines, and olives, and European domestic animals were introduced. The next viceroy was the Conde de Nieva (1561-64). His successor, the licentiate Lope Garcia de Castro, who only had the title of governor, ruled from 1564 to 1569. From this time there was a succession of viceroys until 1824. The viceroys were chief magistrates, but they were not supreme. In legal matters they had to consult the Audiencia of judges, in finance the Tribunal de Cuentas, in other branches of administration the Juntas de Gobierno and de Guerra.

Don Francisco de Toledo, the second son of the count of Oropesa, entered Lima as viceroy on 26th November 1569. Fearing that the little court of the Ynca Tupac Amaru (who had succeeded his brother Sayri Tupac) might become a formidable focus of rebellion, he sent troops to seize the young prince, and unjustly beheaded the last of the Incas in the square of Cuzco in the year 1571. After a minute personal inspection of every province in Peru, he, with the experienced aid of the learned Polo de Ondegardo,

and the judge Matiana, established the system under which the native population of Peru was ruled for the two succeeding centuries; and future viceroys referred to him as the great master of statesmanship who was their guide, and to his ordinances as their acknowledged text-book. His *Libro de Tasa* fixed the tribute to be paid by the Indians, exempting all men under eighteen and over fifty. He found it necessary, in order to secure efficient government, to revert in some measure to the system of the Incas. The people were to be directly governed by their native chiefs, whose duty was to collect the tribute and exercise magisterial functions. The chiefs or "curacas" had subordinate native officials under them called "pichca-pachacas" over 500 men, and "pachacas" over 100 men. The office of curaca (or "cacique") was made hereditary, and its possessor enjoyed several privileges. Many curacas were descended from the imperial family of the Incas, or from great nobles of the Yncarial court. In addition to the tribute, which was in accordance with native usage, there was the "mita," or forced labour in mines, farms, and manufactories. Toledo enacted that one-seventh of the male population of a village should be subject to conscription for this service, but they were to be paid, and were not to be taken beyond a specified distance from their homes.

In their legislation the Spanish kings and viceroys showed a desire to protect the people from tyranny, but they were unable to prevent the rapacity and lawlessness of distant officials. The country was depopulated by the illegal methods of enforcing the mita, and an air of sadness and desolation spread over the land. Toledo was succeeded in 1581 by Don Martin Henriquez, who died at Lima two years afterwards. The subsequent history of the viceroyalty is well worthy of detailed attention by students of history in all countries possessing a colonial empire. The Spanish colonies suffered from the strict system of monopoly and protection, which was only slightly relaxed by the later Bourbon kings, and from the arbitrary proceedings of the Inquisition. Between 1581 and 1776 as many as fifty-nine heretics were burned at Lima, and there were twenty-nine "autos," but the Inquisition affected Europeans rather than natives, for the Indians, as catechumens, were exempted from its terrors. The curacas sorrowfully watched the gradual extinction of their people by the operation of the mita, protesting from time to time against the exactions and cruelty of the Spaniards. At length a descendant of the Incas, who assumed the name of Tupao Amaru, rose in rebellion in 1780. The insurrection lasted until July 1783, and the cruel executions which followed its suppression failed to daunt the people. The death of Tupao Amaru shook the power of Spain and made it totter to its fall. From that time both Indians and Peruvians of Spanish descent began to think for themselves, and to entertain ideas of liberty and progress. Tupao Amaru was followed by Dr Pedro José Chaves de la Rosa, the Spanish bishop of Arequipa, and Dr Toribio Rodriguez de Mendoza, rector of the university of San Carlos at Lima, whose pupils, among whom were the future republican statesmen Drs Lima Pizarro and Vivil, became ardent advocates of reform. When, on 28 August 1814, Mateo Garcia Pumacagua, a Peruvian chief, raised the cry of independence at Cuzco, he was joined by many Peruvians of Spanish descent, but was defeated in the battle of Umachiri (12th March 1815), taken, and executed. At the same time the youthful and enthusiastic poet Molgar suffered death in the cause of his country.

Peru was the centre of Spanish power, and the viceroy had his military strength concentrated at Lima. Consequently the more distant provinces, such as Chili and Buenos Ayres, were able to throw off the yoke first. But the destruction of the viceroy's power was essential to their continued independent existence. The conquest of the Peruvian coast must always depend on the command of the sea. A fleet of armed ships was fitted out at Valparaiso in Chili, under the command of Lord Cochrane and officered by Englishmen. It conveyed an army of Argentine troops, with some Chilians, under the command of the Argentine general San Martin, which landed on the coast of Peru in September 1820. San Martin was enthusiastically received, and the independence of Peru was proclaimed at Lima on his entrance, after the viceroy had withdrawn (28th July 1821). On 20th September 1822 San Martin resigned the protectorate, with which he had been invested, saying that the "presence of a fortunate soldier is dangerous to a newly-constituted state," and on the same day the first congress of Peru became the sovereign power of the state. After a short period of government by a committee of three, the congress elected Don José de la Riva Agüero to be first president of Peru on 26th February 1823. He displayed great energy and capacity as an administrator, but the aid of the Colombians under Bolívar was sought, and the native ruler was unwisely deposed. Bolívar arrived at Lima on 1st September 1823, and began to organize an army to attack the Spanish viceroy in the interior. On 8th August 1824 the cavalry action of Junin was fought with the Spanish general Canterac near the shores of the lake of Chinchay-cocha. It was won by a gallant charge of the Peruvians under Colonel Suarez at the critical moment. Soon afterwards Bolívar left the army to proceed to the coast, and the final battle of Ayacucho (9th December 1824)

with the viceroy and the whole Spanish power was fought by his second in command, General Sucre. The Spaniards were completely defeated. The viceroy and all his officers were taken prisoners, and Spanish power in Peru came to an end.

General Bolívar now showed that he was actuated by personal ambition; he intruded to impose a constitution on Peru, with himself as president for life. He failed, and left the country on 2d September 1826, followed by all the Colombian troops in March 1827. General Lamar, who commanded the Peruvians at Ayacucho, was elected president of Peru on 24th August 1827, but was deposed, after waging a brief but disastrous war with Colombia, on 7th June 1829. General Gamarra, who had been in the Spanish service, and was chief of the staff in the patriot army at Ayacucho, was elected third president on 31st August 1829.

For fifteen years, from 1829 to 1844, Peru was painfully feeling her way to a right use of independence. The officers who fought at Ayacucho, and to whom the country felt natural gratitude, were all-powerful, and they had not learned to settle political differences in any other way than by the sword. From 1837 to 1839 there was a lawless and unprincipled intervention on the part of Chili which increased the confusion. Three men, during that period of probation, won a prominent place in their country's history, Generals Gamarra, Salaverry, and Santa Cruz. Gamarra, born at Cuzco in 1785, never accommodated himself to constitutional usages; too often he made his own will the law; but he attached to himself many loyal and devoted friends, and, with all his faults, which were mainly faults of ignorance, he loved his country and sought its welfare according to his lights. Salaverry was a very different character. Born at Lima in 1806, of pure Basque descent, he joined the patriot army before he was fifteen and displayed his audacious valour in many a hard-fought battle. Feeling strongly the necessity that Peru had for repose, and the guilt of civil dissension, he wrote patriotic poems which became very popular. Yet he too could only see a remedy in violence. He seized the supreme power, and perished by an iniquitous sentence on 15th February 1836.<sup>1</sup> Andres Santa Cruz was an Indian statesman. His mother was a lady of high rank, of the family of the Incas, and he was very proud of his descent. Unsuccessful as a general in the field, he nevertheless possessed remarkable administrative ability and for nearly three years (1836-39) realized his lifelong dream of a Peru-Bolivian confederation.<sup>2</sup> But Peruvian history is not confined to the hostilities of these military rulers. Two constitutions were framed, in 1828, 1833, and 1839. There were lawyers, statesmen, and orators who could defend the rights and liberties of the people. On 7th November 1832 Dr Vivil, the deputy for Tacna, rose in his place in congress and denounced the unconstitutional acts of President Gamarra in a memorable speech of great eloquence. Nor should a much humbler name ever be omitted in writing the history of republican Peru. Juan Rios, a private soldier, was sentry at the door of congress when Gamarra illegally sent his troops to disperse the members. He defended his post against two companies, and fell mortally wounded.

In 1844 General Ramon Castilla restored peace to Peru, and was elected constitutional president on 20th April 1845. Ten years of peace and increasing prosperity followed. In 1849 the regular payment of the interest of the public debt was commenced, steam communication was established along the Pacific coast, and a railroad was made from Lima to Callao. After a regular term of office of six years of peace and moral and material progress Castilla resigned, and General Echenique was elected president. But the proceedings of Echenique's government in connexion with the consolidation of the internal debt were disapproved by the nation, and, after hostilities which lasted for six months, Castilla returned to power in January 1855. From December 1856 to March 1858 he had to contend with and subdue a local insurrection headed by General Vianco, but, with these two exceptions, there was peace in Peru from 1844 to 1879, a period of thirty-five years. The existing constitution was framed in 1856, and revised by a commission in 1860. Slavery and the Indian tribute were abolished; by its provisions the president is elected for four years, and there are two vice-presidents. The congress consists of a senate and chamber of deputies. The senators are elected by departments and the deputies by the people, every 30,000 inhabitants having a representative. When congress is not sitting there is a permanent commission of the legislature, elected at the end of each session, and consisting of seven senators and eight deputies. The chamber of deputies may accuse the president of infractions of the constitution and the senate passes judgment. The president appoints the prefects of departments and sub-prefects of provinces; the prefects nominate the governors of districts. In each province there is a judge; a superior court of justice sits at the capital of each department; and there is

<sup>1</sup> The romance of his life has been admirably written by Manuel Bilbao (1st ed., Lima, 1885; 2d ed., Buenos Ayres, 1887).

<sup>2</sup> The succession of presidents and supreme chiefs of Peru from 1826 to 1844 was as follows:—1826-28, Agustín Gamarra; 1824-25, Luis José Orbegoso; 1826-30, Felipe Santiago Salaverry; 1826-30, Andrés Santa Cruz; 1830-41, Agustín Gamarra; 1841-44, Manuel Mendocena.

an appeal to the supreme court at Lima. Castilla retired at the end of his term of office in 1862, and died in 1868. On 2d August 1868 Colonel Balta was elected president. Before his time the public debt had been moderate, amounting to £4,491,042, and the interest had been regularly paid since 1849. But Balta's government increased it to £49,000,000, the payment of the interest of which from the ordinary revenues was simply impossible. The creditors, as security, had the whole of the guano and nitrate deposits assigned to them. With the vast sum thus raised President Balta commenced the execution of public works, principally railroads on a gigantic scale. His period of office was signalized by the opening of an international exhibition at Lima. He was succeeded (2d August 1872) by Don Manuel Pardo, an honest and enlightened statesman, who did all in his power to retrieve the country from the financial difficulty into which it had been brought by the reckless policy of his predecessor, but the conditions were not capable of solution. He regulated the Chinese immigration to the coast-valleys, which, from 1860 to 1872, had amounted to 58,606. He paid great attention to statistics, promoted the advance of education, and encouraged literature. He was the best president Peru has ever known, and his death in 1878 was a public calamity. On 2d August 1876 General Prado was elected, and his term of office saw the commencement of that calamity which has since overwhelmed his country.<sup>1</sup>

On 5th April 1879 the republic of Chili declared war upon Peru, the alleged pretext being that Peru had made an offensive treaty, directed against Chili, with Bolivia, a country with which Chili had a dispute; but the publication of the text of this treaty made known the fact that it was strictly defensive and contained no just cause of war. The true object of Chili was the conquest of the rich Peruvian province of Tarapaca, the appropriation of its valuable guano and nitrate deposits, and the spoliation of the rest of the Peruvian coast.

After the capture of the "Huascar" off Point Angamos on 8th October 1879 by two Chilean ironclads and four other vessels, the Peruvian coast was at the mercy of the invaders, and Tarapaca, surrounded by trackless deserts, yet open to the sea, though bravely defended for some time by the Peruvian army, fell into the hands of the enemy after the hotly-contested battle of Tarapaca on 17th November 1879.

Chili then landed an army farther north, and on 26th May 1880 the battle of Tacna was fought, followed by the capture of the port of Arica on 7th June. In these combats the Peruvians lost 147 officers alone. The possession of the sea enabled the Chilean ships to desolate the whole coast; and, the Peruvian army having been almost annihilated, only a force of volunteers and raw recruits could be assembled for the defence of the capital. After the two desperately-contested battles of Chorrillos and Miraflores on the 13th and 15th of January 1881, Lima was entered on the 17th, and was not evacuated by the invaders until 22d October 1883. During that period General Cáceres, the hero of the defence, carried on a gallant but unequal struggle in the sierra. At last a provisional Government, under General Iglesias, signed a treaty with the Chileans on 20th October 1883, by which the province of Tarapaca was ceded to the conquerors, Tacna and Arica were to be occupied by the Chileans for ten years, and then a vote by plebiscitum is to decide whether they are to belong to Peru or Chili; and there are clauses respecting the sales of guano; while all rights to the nitrate deposits, which are hypotheated to the creditors of Peru, have been appropriated by the Chilean conquerors. This most disastrous war has brought ruin and misery on the country, and has thrown Peru back for many years. The country contains the elements of recovery, but it will be a work of time.

**Bibliography.**—The history of Ynca civilization is to be found in works contemporaneous with the conquest or written in the succeeding century, in the native literature, and in the modern descriptions of ruins and other remains. The highest authority is Pedro de Cieza de Leon, whose *Chronica*, which bears the stamp of impartiality, accuracy, and intelligence, was written within twenty years of the conquest (Eng. tr. of parts i. and ii. by the Hakluyt Society, 1854, 1855). The valuable writings of the learned lawyer Polo de Ondegardo, which discuss the polity and administrative rule of the Yncas, have been edited in Spanish, and one of his interesting reports has been translated and issued by the Hakluyt Society. Cristoval de Molina, the priest of the hospital of Cuzco, has described the rites, ceremonies, and ritual of the Yncas in great detail; he wrote in 1680, but his manuscript was not translated and issued (by the Hakluyt Society) until 1872. It has since been ably edited in Spanish, at Madrid. Miguel Balboa, who was in the country from 1666 to 1686, wrote an excellent historical work, which is translated into French in the series of *M. Ternaux Compagny. The Natural History of the Indies*, by the Jesuit José de

Acosta, is a work of considerable repute, first published in 1600. An English version, which originally appeared in 1604, was reprinted and edited for the Hakluyt Society in 1880. The famous commentaries of Garcilasso de la Vega were published in 1609; and the first part, relating to the Ynca, was translated and issued by the Hakluyt Society in 1850. The *Suma y Narración de los Yncas*, by Juan de Betanzos, is certainly one of the most valuable of the earlier authorities, as the author was an excellent scholar, well acquainted with the Ynca language, and a citizen of Cuzco. But most of his work is lost. The remainder was edited in Spanish by Señor Espada in 1880. The works of Ayala, Arriaga, and Ramos give accounts of local superstitions and beliefs soon after the conquest. In the 17th century valuable labours on Ynca history were given out by Fernando Montesinos, whose work was translated into French in the *Revue des Deux Mondes*, and by a native named Juan de Santa Cruz Salcamayhua. The latter curious narrative has been edited in Spanish recently, and issued in a translated form by the Hakluyt Society. General accounts of Ynca civilization have been written by Robertson, Prescott, and Hays, none of whom, however, were acquainted with more than a portion of these authorities, or with the native languages, and none had been in the country. A valuable modern work on Peruvian antiquities is the *Antigüedades Peruanas*, by Don Mariano Rivera, published at Vienna in 1851, and translated into English at New York. Markham's *Cuzco and Lima* (1856) contains the results of a personal visit to the coast and to the ruins in and round Cuzco. O'Drigny has described the ruins near Lake Titicaca; but the best modern work treating of architectural remains throughout Peru, as they may be seen, is E. G. Squier's *Peru* (1877). Perot de Bolivia, by Charles Wiener (1850), is also a valuable work. The language and literature of the Yncas have been treated of by Rivero, who gives a list of earlier grammars and vocabularies; in the *Quichua grammar and dictionary*, and the translation of the *Quichua*, by Markham; in Dr Von Tschudi's *Kecksch Specks* (1853); in his subsequent critical work published in 1875; and by Gavino Negras in the fourth volume of *Collection Linguistique Americaine* (1875). Don Vicente Lopez de Buenos Ayres has also written a learned work on the subject entitled *Encas Argemina*.

The career of Pizarro and the conquest of Peru are recounted in the general histories of Herrera and Gomara, and in Garcilasso de la Vega (part ii.). The best accounts of the first part of the conquest are by Francisco de Xerxes, the conqueror's secretary, and by Fernando Pizarro. Both latter are in English, and issued by the Hakluyt Society. The narrative of Pedro Pizarro has only recently been edited at Madrid, and, as the author was one of the conquerors and an eye-witness, it is very important. Agustín de Zarate, who was employed in Peru very soon after the conquest, wrote a history which is valuable, especially the latter portion relating to events of which he was an eye-witness. The history of the Quito war by Cieza de Leon remained in manuscript until 1877, when it was admirably edited by Señor Espada. These authorities (excepting the last) were made use of by Robertson, Prescott, and Hays. But none of the three brings the narrative down to the conclusion of the civil war in Peru and the settlement of the country. An account of the last rebellion, led by Francisco Hernandez Girón, and of the final settlement, is given by the Palencian Diego Fernandez in his history of Peru (Seville, 1671). There is no translation of this work. There is no history of the colonial period; there are, however, abundant materials for it in the laws and ordinances, in the detailed reports of successive viceroys, in the histories of religious orders, and in innumerable memoirs, biographies, and reports both printed and in manuscript. In his narrative (8 vols., 1822), gives some account of the last years of viceregal government. A mass of documents relating to the great rebellion of the Ynca Tupac Amaru was published by Don Pedro de Angella at Buenos Ayres in 1856. The work of Don Gregorio Funes, dean of Cordova, published in 1817, contains further information, and the diary of the governor of La Paz, while besieged by the Indians, will be found in Temple's *Peru*. There are narratives of the rebellion in the *Voyages* and *Journal de Bolivie* in Peru, Italy, and in the *France in Peru and India* (1822) by Markham. The events which led to the final achievement of Peruvian independence have been traced out in an interesting work by Don Benjamin Vicuña Mackenna, entitled *La Historia de la Independencia del Peru, 1800-1819* (Lima, 1860). The events of the war of independence are narrated by the Spaniards Garcia Camba and Terrazas, and in English in the charming *Memoirs of General Miller*, and as regards naval affairs, in the autobiography of the same general. Some volumes of the history of the rebellion have been published by Dr Don Pas Soldan. There are useful materials for history in the two anonymous volumes published in 1856 and signed "Fruvencos," in the lives of Lamar by Villaran, of slavery by Bilbao, and in the history of the campaign of Yungay by Flacoena. The works of Colonel Espinosa, especially his *Diccionario Repúblicano*, and of Dr Villal are also important. Histories of the war between Peru and Chili have been hurriedly published by two Chileans, Diego Barros Arana and Vicuña Mackenna. The former is a more particular and judicious of no value as a history. The latter, though prejudiced, is honestly written, and is useful as containing many original documents. Another history will be written by Pas Soldan; and meanwhile narratives have been published in English by Markham, and in Italian by Calvano.

The most valuable geographical and topographical works on Peru are by Peruvians, including the writings of Cosme Bueno and Usante, articles in the *Mercurio Peruano*, and the works already mentioned of Dr Pas Soldan. Some papers by Eschsch, Miller, Bollart, Batmoundi, Pentland, and Markham will be found in the *Journal of the Royal Geographical Society*. But the most important of all is the great official work by Don Antonio Batmoundi, three volumes of which have already appeared, besides the same author's geographical account of the department of Arequipa. The natural history of Peru has been described in the German works of Dr Von Tschudi, and briefly in the English translation of his travels (1847). The first great work on Peruvian antiquities was the *Peru*, by Buns and Favre, followed by the *Chloris Andine* of Dr Weddell, which forms two volumes of the great work of Castelnau. In his *zoológico*, Weddell describes the quinine-yielding cinchona trees of Peru and Bolivia, and further information on the cinchona genus, as well as on coca cultivation, Cuzco maize, and quinoa, will be found in Markham's *Peruvian Book* (1860). Besides the works already mentioned, Dr A. Smith published a book giving useful information respecting the climate of Lima and other parts of Peru useful Peru see it (1860); and there are some other books of travel of no special value. (C. R. M.)

PERU, a city of the United States in La Salle county, Illinois, lies 68 miles above Peoria at the head of navigation on the Illinois river, is a station on the Chicago, Rock

Island, and Pacific Railroad, and is connected by a tramway (1 mile) with La Salle, the terminus of the Illinois and Michigan Canal. Flour-mills, a plough-factory, and zinc-works are among the chief industrial establishments; coal-

<sup>1</sup> The succession of presidents of Peru, since the establishment of peace by Castilla in 1844, has been as follows:—1845-51, Ramon Castilla; 1851-55, José Rufino Echenique; 1855-62, Ramon Castilla; 1862-68, Miguel San Roman (died 2d April 1868); 1868-69, José Antonio Peset (vice-president); 1869-69, Mariano Ignacio Prado;

1868-72, José Balta; 1872-76, Manuel Pardo; 1876-79, Mariano Ignacio Prado; 1879-81, Nicolas de Pierola (supreme chief); 1881 (12th March), Francisco Garcia Calderon; 1883 (20th October), General Iglesias.

mining is largely prosecuted in the vicinity; and 125,000 tons of ice are yearly despatched to the southern markets. The population was 3132 in 1860 and 4632 in 1880 (township, 5053).

PERUGIA, a city of Italy, the chief town of the province of Perugia (formerly Umbria), lies 1550 feet above the sea on a beautiful and green-clad hill, which affords a magnificent view over a wide sweep of the Apennines and the great Umbrian plain through which the Tiber flows. The railway station at the foot of the ascent, more than a mile from the city-gate, is  $48\frac{1}{2}$  miles south-east of Arezzo and 152 miles north of Rome. The walls, which follow a very irregular ground-plan, have a circuit of 8300 yards, and the length from Sant' Angelo in the north-west to Porta San Costanzo in the south-east is 2500 yards. Of the forty-two towers which could be counted in the 14th century only three or four—the Torre degli Scalzi, &c.—remain; but away from the line of the present enceinte there are several relics of the ancient Etruscan and Roman fortifications, notably the so-called arch of Augustus, a magnificent gateway in the Piazza Grimana, with the ancient inscription AVGVSTA PERVIA on the archivolt and a beautiful Renaissance loggia boldly crowning one of its towers. The Cittadella Paolina—a great fortress erected by Paul III. on a site previously occupied by ten churches, two monasteries, the palaces of the Baglioni, and a number of private houses—was destroyed by the citizens in 1848, and its place has been partly taken by a substantial block of public offices (the museum, &c.). In modern Perugia the great centre of interest is the Piazza del Duomo at the north end of the Corso. On one side stands the cathedral of San Lorenzo, a Gothic structure of the 14th and 15th centuries, in the plan of a Latin cross; on the other side is the Palazzo Pubblico, presenting a fine Gothic façade of the first half of the 14th century with the figures of the Perugian griffin and the Guelf lion above the outside stair; and in the centre rises the great marble fountain constructed about 1277 by Bevignate, Frate Alberto (both Perugians), and Boninsegni (a Venetian), and adorned by statues and statuettes sculptured by Niccolò and Giovanni Pisano. The cathedral contains the burial-place of the three popes, Innocent III., Urban IV., and Martin IV., and a reputed relic of great celebrity in Italy—the Virgin's wedding-ring; and at the north-west corner, in the Piazza del Papa, is a sitting statue<sup>1</sup> of Pope Julius III. by Vincenzo Danti, erected about 1555 by the people of Perugia in gratitude for the restoration of their civic privileges. On the decoration of the Sala del Cambio or old exchange, contiguous to the Palazzo Pubblico, PERUGINO (*q.v.*) put forth the full force of his genius. Most of the movable paintings for which Perugia is famous have since 1863 been collected in the Pinacoteca Vannucci, established in the same Monte Morcino monastery of the Olivetans which now accommodates the university; besides a considerable number of pieces by Perugino, there are specimens of Pinturicchio, Niccolò Alunno, Bonfigli, &c. This centralization has somewhat impaired the interest of several of the churches; but others remain with undiminished wealth. San Domenico, a Gothic edifice originally designed by Giovanni Pisano, but rebuilt in 1632, contains that artist's magnificent monument of Pope Benedict XI., and in its east front a beautiful stained-glass window by Bartolommeo da Perugia. San Pietro de' Casinensi (outside the Porta Romana) is a basilica with a triple nave, founded in the beginning of the 11th century by Vincioli, and remarkable for its conspicuous spire, its granite and marble columns, its walnut stall-work designed by Raphael, and its numerous pictures (by Perugino, Parmigiano, Raphael, &c.). The Chiesa Nuova (formerly San Giovanni

Rotondo) possesses the tombs of Baldassare Ferri, the Perugian musician, and Vermiglioli, the leading Perugian antiquary. The university, which is not one of the "royal universities," though it dates from 1307 and has faculties of law, science, and medicine, numbers only seventy-nine students (1881-82). Other educational and benevolent institutions are a botanical garden, a meteorological observatory, a commercial library founded in 1582 by Prospero Podiani,<sup>2</sup> the Santa Margherita lunatic asylum, and the hospital of Santa Maria. Woollens, silks, wax candles, and liqueurs are manufactured on a small scale. The population of the city was 16,708 in 1871, and 17,395 in 1881; that of the commune 49,503 and 51,354 respectively.

A notice of ancient Perugia (Perusia) has been given under ETRURIA, vol. viii. p. 635. After the disasters of the Perugia war (41 B.C.) the city was rebuilt by Augustus and took the title Augusta; and at a later date it became a regular colony, *Colonia Vibia*. Its recovery from the Goths by Belisarius in 537, its protracted siege and sack by Totila (549), its restoration to the Eastern empire by Narses in 552, and its long occupation by the Lombards are the main points in the history of Perugia previous to the 9th century. At that time, with the consent of Charles the Great and Louis the Pious, it passed under the supremacy of the popes; but for many centuries the papal authority existed rather in name than in reality, and the city continued to maintain an independent and enterprising life, warring against its enemies and subduing many of the neighbouring lands and cities,—Foligno, Assisi, Spoleto, Montepulciano, &c. It remained true for the most part to the Guelphs. On various occasions the popes found a personal asyle within its walls, and it was the meeting-place of the conclave which elected Honorius II. (1124), Honorius IV. (1285), Celestin V. (1294), and Clement V. (1305). But Perugia had no mind simply to subserve the papal interests. At the time of Biondi's unfortunate enterprise it sent ten ambassadors to pay him honour, and, when papal legates sought to coerce it by foreign soldiers, or to exact contributions, they met with vigorous resistance. In the 15th century the real power, after passing from despot to despot, was at last concentrated in the Baglioni family, who, though they had no legal position as rulers or magistrates, defied all other authority, and filled the streets of the city with their broils and butcheries. Gian Paolo Baglioni was lured to Rome in 1520, and beheaded by Leo X.; and in 1534 Rodolfo, who had slain a papal legate, was defeated by Pier Luigi Farnese, and the city, captured and plundered by his soldiery, was deprived of its privileges and given over to the "worse tyranny of priests and bastards." In 1797 Perugia was occupied by the French; in 1832, 1838, and 1854 it was visited by earthquakes; in May 1849 it was seized by the Austrians; and, after a futile insurrection in 1850, it was finally united, along with the delegation, to Piedmont in 1860.

See R. Rossi Scotti, *Guida di Perugia*; Bonazzi, *Storia di Perugia* (1875, &c.); J. A. Symonds, *Sketches in Greece and Italy* (1874).

PERUGINO, PIETRO (1446-1524), whose correct family name was VANNUCCI, one of the most advanced Italian painters immediately preceding the era of Leonardo da Vinci and Raphael, was born in 1446 at Città della Pieve in Umbria, and belongs to the Umbrian school of painting. The name of Perugino came to him from Perugia, the chief city of the neighbourhood. Pietro was one of several children born to Cristoforo Vannucci, a member of a respectable family settled at Città della Pieve. Though respectable, they seem to have been poor, or else, for some reason or other, to have left Pietro uncared for at the opening of his career. Before he had completed his ninth year the boy was articulated to a master, a painter at Perugia. Who this may have been is very uncertain; the painter is spoken of as wholly mediocre, but sympathetic for the great things in his art. Benedetto Bonfigli is generally surmised; if he is rejected as being above mediocrity, either Fiorenzo di Lorenzo or Niccolò da Foligno may possibly have been the man. Pietro painted a little at Arezzo; thence he went to the headquarters of art, Florence, and frequented the famous Brancacci Chapel in the church of the Carmina. It appears to be sufficiently established that he studied in the atelier of Andrea del Verrocchio, where Leonardo da Vinci was also a pupil. He may have learned perspective, in which he particularly

<sup>1</sup> See Hawthorne's description in the *Marble Faun*.

<sup>2</sup> See the curious history in *The Fortnightly Review*, 1866.



excelled for that period of art, from Pietro della Francesca. The date of this first Florentine sojourn is by no means settled; some authorities incline to make it as early as 1470, while others, with perhaps better reason, postpone it till 1479. Pietro at this time was extremely poor, and his prospects of rising in his art, save by the exercise of incessant diligence day and night, were altogether dim; he had no bed, but slept on a chest or trunk for many months, and, bent upon making his way, resolutely denied himself every creature-comfort.

Gradually Perugino rose into notice, and in the course of some years he became extremely famous not only throughout all Italy but even beyond her bounds. He was one of the earliest Italian painters to practise oil-painting, in which he evinced a depth and smoothness of tint which elicited much remark; he transcended his epoch in giving softness to form and a graceful spaciousness to landscape-distances; and in perspective he applied the novel rule of two centres of vision. The Florentine school advanced in amenity under his influence. Some of his early works were extensive frescos for the Ingesati fathers in their convent, which was destroyed not many years afterwards in the course of the siege of Florence; he produced for them also many cartoons, which they executed with brilliant effect in stained glass. Though greedy for gain, his integrity was proof against temptation; and an amusing anecdote has survived of how the prior of the Ingesati doled out to him the costly colour of ultramarine, and how Perugino, constantly washing his brushes, obtained a surreptitious hoard of the pigment, which he finally restored to the prior to shame his stingy suspiciousness. Another (and possibly apocryphal) anecdote, to show that he was not incapable of rising superior to all sordid considerations, is that he painted some excellent frescos for the oratory annexed to S. Maria de' Bianchi and would only accept an omelette as a gratuity. A third anecdote (but it belongs to a late period of his life) is that, as he would trust no one, he was accustomed to carry his money about with him in travelling after he had received a payment, and on one occasion was robbed and had a narrow escape of his life; eventually, however, the bulk of the money was recovered. A good specimen of his early style, in tempera, is the circular picture in the Louvre of the Virgin and Child enthroned between Saints.

Perugino returned from Florence to Perugia, and thence, towards 1483, he went to Rome. The painting of that part of the Sistine Chapel which is now immortalized by Michelangelo's Last Judgment was assigned to him by the pope; he covered it with frescos of the Assumption, the Nativity, and Moses in the Bulrushes. These works were ruthlessly destroyed to make a space for his successor's more colossal genius, but other works by Perugino still remain in the Sistine Chapel,—Moses and Zipporah (often attributed to Signorelli), the Baptism of Christ, and Christ giving the keys to Peter. This last work is more especially noted, and may be taken as a typical example both of Perugino's merits and of his characteristic defects,—such as formal symmetry of composition, set attitudes, and affectation in the design of the extremities. Pinturicchio accompanied the greater Umbrian to Rome, and was made his partner, receiving a third of the profits; he may probably have done some of the Zipporah subject.

Pietro, now aged forty, must have left Rome after the completion of the Sistine paintings in 1486, and in the autumn of that year he was in Florence. Here he figures by no means advantageously in a criminal court. In July 1487 he and another Perugian painter named Aulista di Angelo were convicted, on their own confession, of having in December waylaid with staves some one (the name does not appear) in the street near S. Pietro

Maggiore. Perugino limited himself, in intention, to assault and battery, but Aulista had made up his mind for murder. The minor and more illustrious culprit was fined ten gold florins, and the major one exiled for life. The next recorded incident in his career is also not wholly honourable to Perugino,—that of his undertaking but not fulfilling a contract to paint in Orvieto; as the commission fell through we need not pursue the details.

Between 1486 and 1499 Perugino resided chiefly in Florence, making one journey to Rome and several to Perugia. He had a regular shop in Florence, received a great number of commissions, with proportionate gain and fame, and continued developing his practice as an oil-painter, his system of superposed layers of colour being essentially the same as that of the Van Eycks. One of his most celebrated pictures, the *Pietà* in the Pitti Gallery, belongs to the year 1495. From about 1498 he became increasingly keen after money, frequently repeating his groups from picture to picture, and leaving much of his work to journeymen. In 1499 the guild of the Cambio (money-changers or bankers) of Perugia asked him to undertake the decoration of their audience-hall, and he accepted the invitation. This extensive scheme of work, which may have been finished within the year 1500, comprised the painting of the vault with the seven planets and the signs of the zodiac (Perugino doing the designs and his pupils most probably the executive work), and the representation on the walls of two sacred subjects—the Nativity and Transfiguration—the Eternal Father, the four Virtues of Justice, Prudence, Temperance, and Fortitude, Cato as the emblem of wisdom, and (in life-size) numerous figures of classic worthies, prophets, and sibyls. On the mid-pilaster of the hall Perugino placed his own portrait in bust-form. It is probable that Raphael, who in boyhood, towards 1496, had been placed by his uncles under the tuition of Perugino, bore a hand in the work of the vaulting; but, besides Raphael, the master had many and distinguished scholars acting as his assistants. The Transfiguration in this series has often been spoken of as the latest work of eminent excellence produced by Perugino, and from about 1500 he declined in a marked degree; this, however, is not to be accepted as true without some qualification, as we shall see in the sequel. It may have been about this time (though some accounts date the event a few years later) that Vannucci married a young and beautiful wife, the object of his fond affection; he loved to see her handsomely dressed, and would often deck her out with his own hands. He was made one of the priors of Perugia in 1501.

While Perugino, though by no means stationary or unprogressive as an executive artist, was working contentedly upon the old lines, and carrying out, almost to their highest point of actual or potential development, the ancient conceptions of subject-matter, treatment, style, and form, a mighty wave of new art flooded Florence with its rush and Italy with its rumour. Michelangelo, twenty-five years of age in 1500, following after and distancing Leonardo da Vinci, was opening men's eyes and minds to possibilities of achievement as yet unsurmised. Vannucci in Perugia heard Buonarroti bruted abroad, and was impatient to see with his own eyes what the stir was all about. In 1504 he allowed his apprentices and assistants to disperse, and he returned to Florence. It was not in the nature of things that he should simply swell the chorus of praise. Though not openly detracting, he viewed with jealousy and some grudging the advances made by Michelangelo; and Michelangelo on his part replied, with the intolerance which pertains to superiority, to the faint praise or covert dispraise of his senior and junior in the art. On one occasion, in company, he told Perugino to

his face that he was "a bungler in art" (*goffo nell' arte*). This was not to be borne, and Vannucci brought, with equal indiscretion and ill success, an action for defamation of character. Put on his mettle by this mortifying transaction, he determined to show what he could do, and he produced the chef-d'œuvre of the Madonna and Saints for the Certosa of Pavia. The constituent parts of this noble work have now been sundered. The only portion which remains in the Certosa is a figure of God the Father with cherubim. An Annunciation has disappeared from cognizance; three compartments—the Virgin adoring the infant Christ, St Michael, and St Raphael with Tobias—are among the choicer treasures of the London National Gallery. The current story that Raphael bore a hand in the work is not likely to be true. This was succeeded in 1505 by an Assumption, in the Cappella dei Rabatta, in the church of the Servi in Florence. The painting may have been executed chiefly by a pupil, and was at any rate a failure: it was much derided; Perugino lost his scholars; and towards 1506 he once more and finally abandoned Florence, going to Perugia, and thence in a year or two to Rome.

Pope Julius II had summoned Perugino to paint the Stanza in the Vatican, now called that of the Incendio del Borgo; but he soon preferred a younger competitor, that very Raphael who had been trained by the aged master of Perugia; and Vannucci, after painting the ceiling with figures of God the Father in different glories, in five medallion-subjects, found his occupation gone; he retired from Rome, and was once more in Perugia from 1512. Among his latest works one of the best is the extensive altar-piece (painted between 1512 and 1517) of S. Agostino in Perugia; the component parts of it are now dispersed in various galleries.

Perugino's last frescoes were painted for the monastery of S. Agnese in Perugia, and in 1522 for the church of Castello di Fontignano hard by. Both series have disappeared from their places, the second being now in the South Kensington Museum. He was still at Fontignano in 1524 when the plague broke out, and he died. He was buried in unconsecrated ground in a field, the precise spot now unknown. The reason for so obscure and unwonted a mode of burial has been discussed, and religious scepticism on the painter's own part has been assigned as the cause; the fact, however, appears to be that, on the sudden and widespread outbreak of the plague, the panic-struck local authorities ordained that all victims of the disorder should be at once interred without any waiting for religious rites. This leads us to speak of Perugino's opinions on religion. Vasari is our chief, but not our sole, authority for saying that Vannucci had very little religion, and was an open and obdurate disbeliever in the immortality of the soul. Gasparo Celio, a painter of the 16th century, cites Niccolò delle Pomarance (whose wife was related to Perugino's wife) as averring that the aged master on his deathbed rejected the last sacraments, and refused to confess, saying he was curious to know the final fate of an unconfessed soul, and therefore he was buried in unconsecrated ground. For a reader of the present day it is easier than it was for Vasari to suppose that Perugino may have been a materialist, and yet just as good and laudable a man as his orthodox Catholic neighbours or brother-artists; still there is a sort of shocking discrepancy between the quality of his art, in which all is throughout Christian, Catholic, devotional, and even pietistic, and the character of an anti-Christian contemner of the doctrine of immortality. It is difficult to reconcile this discrepancy, and certainly not a little difficult also to suppose that Vasari was totally mistaken in his assertion; he was born twelve years before Perugino's death, and must have talked

with scores of people to whom the Umbrian painter had been well known. We have to remark that Perugino in 1494 painted his own portrait, now in the Uffizi Gallery of Florence, and into this he introduced a scroll lettered "Timete Deum." That an open disbeliever should inscribe himself with "Timete Deum" seems odd; one's first impression is either that he cannot have been a disbeliever or else that he must have been a hypocrite as well, which, however, is still inconsistent with Vasari's account of the facts. It is possible, after all, that a man might fear God and yet have no confidence in immortality, or in many of the things which seemed in 1494 to be essentials of religion. The portrait in question shows a plump face, with small dark eyes, a short but well-cut nose, and sensuous lips; the neck is thick, the hair bushy and frizzled, and the general air imposing. The later portrait in the Cambio of Perugia shows the same face with traces of added years. Perugino died possessed of considerable property, leaving three sons.

The character of Perugino's art is, as we have just said, throughout religious, although, in some instances already indicated, he strayed outside the circle of Christian history and tradition. His art is reserved, self-contained, not demonstrative, yet conspicuously marked by a tendency to posing and balance, and to little artifices wherein the graceful merges in the affected. He had a particular mastery over abstracted purism of expression; this appears constantly in his works, and, while it carries the finer of them to a genuinely ideal elevation, it leaves upon many a mincing and mawkish taint which it is not easy to view without some impatience. Perugino did not recruit his strength from study of the antique; his drawing, though frequently solid and able, is unequal, and there is a certain littleness of style in his forms, especially (with rare exceptions) the nude. His technical attainment was exceptional, and in colour he may be regarded as standing first in his generation in central Italy if we except Francia. Perugino does not leave upon us the impression of personal greatness; he does not seem to have had struggling within him a profounder message to convey than he succeeded in conveying. There is neither massiveness of thought, nor novel initiative, nor glowing intensity, though there is some fervour of inspiration. Still, within his own province, he is a rare and excellent master.

Among the very numerous works of Perugino a few not already named require mention. Towards 1501 he produced the picture of the marriage of Joseph and the Virgin Mary (the "Spozializio") now in the museum of Casen; this served indisputably as the original, to a great extent, of the still more famous Spozializio which was painted by Raphael in 1504, and which forms a leading attraction of the Brera Gallery in Milan. A vastly finer work of Perugino's than his Spozializio is the Ascension of Christ, which, painted a little earlier for S. Pietro of Perugia, has for years past been in the museum of Lyons; the other portions of the same altar-piece are dispersed in other galleries. In the chapel of the Disciplinati di Città della Pieve is an Adoration of the Magi, a square of 21 feet containing about thirty life-sized figures; this was executed, with scarcely credible celerity, from the 1st to the 25th March (or thereabouts) in 1505, and must no doubt be in great part the work of Vannucci's pupils. In 1507, when the master's work had for years been in a course of decline and his performances were generally weak, he produced, nevertheless, one of his best pictures—the Virgin between St Jerome and St Francis, now in the Palazzo Pansa. In S. Onofrio of Florence is a much-lauded and much-debated fresco of the Last Supper, a careful and blandly correct but not inspired work; it has been ascribed to Perugino by some connoisseurs, by others to Raphael; it may more probably be by some different pupil of the Umbrian master.

On account of Perugino follows in its main lines that given by Crowe and Cavalcaselle in their *History of Painting in Italy*, vol. III. Vasari is, as usual, by far the most graphic narrator, but lax in his facts (though not so much so as in several other instances). Other leading authorities are Orlandi, *Vita di S. Pietro Perugino e degli Scolari*, 1804, and Mazzanotta, *Vita di Pietro Vannucci*, 1836. (W. M. B.)

PERUVIAN BARK. See CINCHONA and QUININE.

PERUZZI, BALDASSARE (1481-1536), architect and painter of the Roman school, was born at Ancajano, in the diocese of Volterra, and passed his early life at Siena, where his father resided. While quite young Peruzzi went to Rome, and there studied architecture and painting; in the latter he was at first a follower of Perugino. The choir-frescoes in San Onofrio on the Janiculum Hill, usually attributed to Pinturicchio, are by his hand. One of the first works which brought renown to the young architect was the villa on the banks of the Tiber in Rome now

known as the Farnesina, originally built for the Siennese Agostino Chigi, a wealthy banker. This villa, like all Peruzzi's works, is remarkable for its graceful design and the delicacy of its detail. It is best known for the frescos painted there by Raphael and his pupils to illustrate the stories of Psyche and Grlatea. One of the *loggie* has frescos by Peruzzi's own hand,—the story of Medusa, a work of considerable decorative beauty. On account of his success in this building Peruzzi was appointed by Leo X. in 1520 architect to St Peter's at a salary of 250 scudi, a handsome sum for that time; his design for its completion was not, however, carried out. During the sack of Rome in 1527 Peruzzi was taken prisoner, and barely escaped with his life, on condition of his painting the portrait of Constable de Bourbon, who had been killed during the siege (see Vasari). From Rome he escaped to his native city Siena, where he was made city architect, and designed fortifications for its defence, a great part of which still exist. Soon afterwards he returned to Rome, where he made designs for a palace for the Orsini family, and built the palaces Massimi and Vidoni, as well as others in the south of Italy. He died in 1536, and was buried by the side of Raphael in the Pantheon.

Peruzzi was an eager student of mathematics and the science of perspective; he was also a fair classical scholar, and was much influenced by the treatise of Vitruvius. Like many of the great artists of his time, he was remarkable for the varied extent of his knowledge and skill. A most able architect, a fair painter, and a scientific engineer, he also practised minor arts, such as stucco-work in relief, sgraffito, and the decorative painted arabesques which the influence of Raphael did so much to bring into use. His best existing works in fresco are in the Castel di Belcaro and the church of Fontegiusti in Siena. For Siena cathedral he also designed a magnificent wooden organ-case, painted and gilt, rich with carved arabesques in friezes and pilasters; he also designed the high altar and the Cappella del Battista.

His chief pupil was the architect Serlio, who, in his work on architecture, gratefully acknowledges the great debt he owed to Peruzzi's instruction. The English National Gallery possesses an interesting drawing by his hand (No. 167). The subject is the Adoration of the Magi, and it is of special value, because the heads of the three kings are portraits of Michelangelo, Raphael, and Titian. The Uffizi and the library at Siena contain a number of Peruzzi's designs and drawings, many of which are now of priceless value to the student of Roman antiquities, as they show ancient buildings which have been destroyed since the 16th century.

Vasari, *Vita di Baldassarre Peruzzi* (Milanesi's ed., vol. iv. p. 489, 1832); Milizia, *Memoria degli Architetti* (1781, vol. i. pp. 210-215); Della Valle, *Lettere Senesi* (1782-86); Gaye, *Carteggio inedito d'Artisti* (1839-40); Lanzi, *Storia Pittorica* (1804); and Platner, *Beschreibung der Stadt Rom* (1830-42).

PERVIGILIIUM. See VIGIL.

PERVIGILIIUM VENERIS, the Vigil of Venus, a short Latin poem, in praise of spring as the season of love and flowers. Written professedly in early spring on the eve of a three-nights' festival (Vigil) in honour of Venus (probably April 1-3), it describes in warm and poetical language the annual awakening of the vegetable and animal world in spring through the all-pervading influence of the foam-born goddess, whose birth and connexion with Rome and the Cæsars are also touched upon. The joyous tone which runs through the poem passes suddenly at the close into one of lyric sadness: "The nightingale is singing, but I am silent. When comes my spring?" It consists of ninety-three verses in trochaic tetrameter catalectic and is divided into strophes of unequal length by the refrain, "Cras amet qui nunquam amavit; quique amavit

cras amet." The author, date, and place of composition are unknown. Formerly it was ascribed to Catullus, but from its late Latinity, approximating in some points to Italian,<sup>1</sup> it can hardly have been earlier, and was probably later, than the latter half of the 2d century A.D. It is certainly earlier than Fulgentius (about 480-550 A.D.), who imitated it. The references to Hybla and Etna (or Enna), from which some have thought that the poem is Sicilian, need be no more than poetical allusions to Sicily as the flowery land. Virgil's description of spring (*Georg.*, ii. 323-342) is imitated somewhat closely; compare especially verse 62 with Virgil's 327; again, v. 85 is a copy of *Æneid*, xi. 458. This seems to disprove Bernhardy's conjecture that the poem is a translation from the Greek. From its exuberant rhetoric Orelli ascribes it to an African poet of the 3d or 4th century A.D. Bücheler places it between Florus and Nemesianus, i.e., in the 2d or 3d century A.D. Wernsdorf suggested as its author Annus Florus in the time of Hadrian; Heidtmann conjectured Appuleius; Bæhrens refers it to Tiberianus, a poet of the 4th century. But there are not data enough to determine the authorship.

The *Pervigilium* is preserved in the Paris MSS. 10818 (*Codex Salmastianus*) and 8071 (*Codex Theanensis* or *Pichoisanus*); the former (the better of the two) belongs to the 7th or beginning of the 8th century, the latter to the 9th or beginning of the 10th. They differ too much to have been copied from the same original. The age of the MSS. refutes the theory, sometimes broached, that the poem is modern. The first edition was published by Læpæus at Antwerp in 1611; and there are modern editions by Wernsdorf (*Poeta Latini Minores*, vol. iii.), Orelli (1832), Bücheler (1859), Bæhrens (1877). There are translations into English verse by Thomas Stanley (1651) and Farnall, into prose by W. K. Kelly; a French translation by Sanadon; a German one by Kirchner.

PESARO, a city and seaport of Italy, the capital of the province of Pesaro and Urbino, lies on the coast of the Adriatic 36 miles north of Ancona and 20½ south of Rimini on the right bank of the Foglia, the ancient Pisaurus. The ground on which it is built is only from 10 to 40 feet above the sea, but it is surrounded by hills,—on the east by Monte Ardizio, on the west by Monte Accio or San Bartolo, which derives one of its names from the Roman dramatist L. Attius, born and buried on the spot. The city walls, which were strengthened by bastions and moat and made a circuit of about a mile, were in 1830 transformed into a public promenade. Besides the ancient cathedral of the Annunciation (restored since 1860) the more conspicuous buildings are the prefecture (a palace originally erected by the Sforza, and restored by Francesco Maria della Rovere), the seminary, the Rossini theatre (opened in 1818), the fortress or Rocca Costanza (built by Costanzo Sforza in 1474), the harbour-fort (due to Napoleon I.), and the large lunatic asylum. Rossini, who was a native of Pesaro, left all his fortune to found a musical lyceum in the city, and his statue by Marochetti (1864) stands near the railway station. The Olivieri library (established by the antiquary of that name, author of *Marmorata Pisarenensis*, &c.) contains about 14,000 volumes, MSS. of Tasso's, &c., various antiquities, and a fine collection of majolica from the old Urbino manufactory. Among the industries of Pesaro are the growing, spinning, and weaving of silk, tanning, iron-founding, and the manufacture of glass and pottery. The harbour is of no great importance, and the aggregate burden of the 437 vessels entering or clearing in 1883 was less than 12,000 tons. The population of the city and port in 1870 was 11,952 and in 1880 12,913; that of the commune 19,691 and 20,909 in the same years.

The ancient Pisaurum in the territory of the Galli Senones became a Roman colony in 184 B.C. and soon grew to be a flourishing

<sup>1</sup> Thus *de* is very frequently used like Italian *di*; *totus* (v. 22) instead of *omnes*, Ital. *tutti*; and *mane* (ib.) in the sense of "to-morrow" Ital. *domani*.

ing town. It was recruited with a body of military colonists by Mark Antony, and after the disastrous earthquake of 31 A.C. received another accession from Augustus and took the title *Colonia Julia Felix*. Destroyed by Vitiges the Goth, it was restored and strengthened by Belisarius, and afterwards along with Ancona, Fano, Sinigaglia, and Rimini formed the Pentapolis Maritima. In the course of the 13th century Pesaro was sometimes under the government of the popes, sometimes under that of the emperors; but the Malatesta family, which first took root in the city about 1285, gradually became the real masters of the place. In 1445 they sold their rights to Francesco Sforza; and in 1512, through the influence of Julius II., the Sforza were supplanted by his nephew Francesco Maria, duke of Urbino. Leo X. took the city away from Francesco and gave it to Lorenzo de' Medici; but on Lorenzo's death Francesco was restored and Pesaro became the ordinary residence of the dukes of Urbino till the death of Francesco Maria II. in 1631, when it reverted to the States of the Church. It has formed part of the present kingdom of Italy since 1860. Teuzazio Mamiani della Rovere, poet and statesman, was born at Pesaro in 1800.

**PESHAWAR**,<sup>1</sup> or **PESHAWUR**, a district in the lieutenant-governorship of the Punjab, with an area of 2504 square miles, situated in the extreme north-western corner of British India, between 33° 50' and 34° 30' N. lat. and 71° 30' and 72° 50' E. long. Except on the south-east, where the Indus flows, it is encircled by mountains, and is bounded on the N. by the Mohmand, Utman Khel, and other hills, E. by the Indus, S. by the Khatak and Afridi Hills, and W. by the Khyber Mountains. It forms an important part of the frontier of the Punjab, being crossed by the great route from India to Cabul. The only hills of any consequence in the district are the Khatak Hills, a continuation of the Afridi Hills, which are themselves a spur of the great Sufed Koh range. The plain consists of alluvial deposits of silt and gravel, and throughout the whole valley its surface is studded with water-worn shingle or boulders. The district presents, especially in its western and central portions, an appearance of great beauty: it is covered with luxuriant vegetation, which is relieved by the meanderings of the numerous canals and set off by its bare stony surroundings and the far distant snowy peaks. Its rivers, all tributaries of the Indus, are the Cabul, Swat, Bara, Budni, and Ludnal. The district is naturally fertile and well watered, and the valley is entirely drained by the Cabul river. The temperature ranges from a minimum of 17° in February to a maximum of 137° in July. The average rainfall is about 14 inches.

According to the census of 1881 the population was 592,674, of whom 329,524 were males and 263,150 females. The people are mostly Afghans and almost entirely of the Moslem religion, no less than 546,117 being Mohammedans, while Hindus numbered only 39,821, Christians 4088, Sikhs 2103, and others 45. The largest tribe in the district is that of the Pathans, of whom in 1881 there were 276,656. The Moslem portion of the population is occupied chiefly in agriculture and the rearing of cattle, while the Hindus are engaged in trade as bankers, merchants, and shopkeepers. The prevailing languages are the Urdu and Pushtu.

Out of the total area of 2504 square miles 1414 are cultivated and 470 are returned as cultivable. The chief products are wheat, barley, maize, millet. Peshawar also produces some of the finest rice in the world, known as "Bara rice," named after the river by which the ground yielding it is irrigated. Since the district came into British possession its trade has increased considerably. The principal foreign markets with which it deals are Cabul and Bokhara; the imports from the former are chiefly silk, nuts and fruits, skins, timber, dyes, and spices, and from the latter gold bullion and gold thread, which go principally to Bombay. The exports consist mainly of piece goods, tea, fancy wares, sugar, salt, and spices. The chief manufactures are Peshawar scarves, celebrated throughout India for their fine texture and tasteful colouring, leather goods, cutlery, the preparation of snuff, and a great deal of broadcloth. The gross revenue of the district in 1882-83 was £95,931, of which the land revenue contributed £68,201.

Peshawar in 1881 had five towns with a population exceeding 5000, namely Peshawar (see below); Nowshera, 12,963; Tangi, 9087; Maira Parang, 8874; and Charasadda, 5363.

<sup>1</sup> The division of this name comprises the three districts of Peshawar, Kohat, and Hazara, with an area of 8381 square miles. In 1881 it had a population of 1,181,289—males 649,509, females 531,780. By religion 1,101,096 were Moslems, 68,992 Hindus, 6724 Sikhs, 4390 Christians, and 88 others.

*History.*—The first authentic record of the tribes seated about Peshawar is in the time of Mahmud. What little is heard of them before then points to their being a bold and independent race. Buddhism was introduced into the district in the reign of Asha, 263 A.C., and one of his rock edicts still exists. From this time Sabuktigin, governor of Khorasan, in 978 A.D., who took possession of the country up to the Indus, Peshawar became the scene of fierce contests. Mahmud, his son, was the first Moslem conqueror of Hindustan, and succeeded in converting the Pathans to the Mohammedan faith; and this tribe remained true to him in all his subsequent engagements with the infidels. The last decisive battle of Mahmud with the Hindus was fought on the plains of Chach in Rawal Pindi, where he totally defeated Amang Pal, the last champion of the Hindu creed and nationality in the north. For a century and more after Mahmud's death (1028) Peshawar continued to be a province of Ghazni; and under his numerous successors it acquired great importance, becoming the centre of their dominions, which were extended to Lahore. Timur's invasion of India at the close of the 13th century did not disturb the district or the tribes about it, but a century later the Khalkhai Pathans, a body of roaming adventurers, invaded the district in three main clans—the Yusufai, Giginai, and Muhammadai—and obtained permission from the Dilazaki, who then held it, to settle on a portion of their waste lands. Quarrelling with the Dilazaki, they routed them and swept them into the neighbouring district of Hazara. The Giginai then settled in the fertile strip of land about the confluence of the Swat and the Cabul; the Muhammadai took Hashtnagar, and the Yusufai the remainder of the country north of the Cabul river. For some time these tribes remained unmolested, but in 1519 Babur, fifteen years after his capture of Cabul, allied himself with the injured Dilazaki and subdued the Afghans of Peshawar. After his death in 1530 the country was the scene of constant feuds, which ended in the Dilazaki being completely ousted. The year 1557 marks the last immigration of Afghans into the district. In 1587 Akbar came to the throne. During the next three reigns the valley rendered an unwilling allegiance to the central authority, and in the reign of Aurangzeb the Pathans succeeded in freeing themselves from Mogul supremacy. In 1738 Nadir Shah held possession of the district, and under the succeeding Durani dynasty it was often the residence of the Cabul court. On the death of Timur Shah in 1793 the throne was left to be contended for by his sons, whose adventurous enterprises and varied fortunes form a romantic page in Oriental history. In 1818 the Sikhs advanced into the valley and overran the whole district to the foot of the hills; and the country continued to be ravaged by them until it last fell into their hands, when they ruled it with their usual severity. In 1843 the district became an integral portion of British India, and, except for its connexion with the mutiny in 1857, has little else of importance to notice.

**PESHAWAR**, chief town in the above district, situated in 34° 2' N. lat. and 71° 37' E. long., is about 14 miles east of the Khyber Pass, and distant from Lahore 276 miles and from Cabul 190 miles. Its population in 1881 was 79,982 (50,322 males, 29,660 females). It is built on a plain 1068 feet above the sea, and is surrounded by a mud wall 10 feet high. Among the chief buildings of the town are the Ghor Khatri, originally a Buddhist monastery, afterwards rebuilt as a Hindu temple, and now used as a serai. Peshawar is commanded by a mud-fort to the north-west, built on the ruins of Bala Hisar; and it is well watered, and said to be one of the best-drained cities in the Punjab.

**PESSIMISM** is a word of very modern coinage, employed to denote a mode of looking at and estimating the world, and especially human life, which is antithetical to the estimate designated by the term (a much older one) "Optimism." Both terms have a general as well as a special application. In their non-technical usage they denote a composite and ill-defined attitude of mind which gives preponderating importance to the good or to the evil, to the joys or to the sorrows, respectively, in the course of experience. The optimist sees everything in *couleur de rose*; the pessimist always turns up the seamy side of things. But in their special and technical employment, optimism and pessimism denote specific theories elaborated by philosophers,—the former to show that the world is the work of an author of infinite goodness and wisdom, and is, all things considered, conducive to the happiness of its sentient life; the latter, that existence, when summed up, has as

enormous surplus of pain over pleasure, and that man in particular, recognising this fact, can find real good only by abnegation and self-sacrifice. As a speculative theory optimism is chiefly associated with the *Traédicié* of Leibnitz (1710), while pessimism is the work of Schopenhauer (*Die Welt als Wille und Vorstellung*, 1st ed. 1819) and Von Hartmann (*Philosophie des Unbewussten*, 1st ed. 1869). In either case, however, the modern doctrines have their predecessors. The Stoics and the Neoplatonists were earlier labourers in the cause of optimism, in their attempt to exhibit the adaptations in nature for the welfare of its supreme product man. And in the metaphysical dogmas of Brahmanism, as well as in the practical philosophy of the Buddhists, the creed of the modern pessimist, that the world is vanity and life only sorrow, is found preluded with startling sameness of tone.

Though later as a philosophical creed in the European world, pessimism is far earlier than optimism as a mood of feeling in mankind at large. The ordinary human being, so long as he is engrossed with action and identified with his immediate present, is neither optimist nor pessimist. But in proportion as reflexion awakens—as the fulness of life and vigour of will give place to the exhaustion of age or to brooding thoughtfulness—there comes a sense of doubt as to the value of the aims on which energy is spent and as to the issue of the struggle with nature. It is failure that excites meditation: the obvious disproportion between desire and attainment impresses the poet and thinker, as they scan the page of human life, with the predominant darkness of the record. The complaint is heard from every land and in every language that the days of man are few and evil, that the best lot of all is not to be born at all, and next in order is the fate of those cut off by early death. Even the great king himself (says Socrates in the *Apology*, xxxii.), far less any private man, as he reviews the course of his past life, cannot point to any better or happier time than a night of dreamless sleep; and Byron bids us—

“Count o'er the joys thine hours have seen,  
Count o'er thy days from anguish free,  
And know, whatever thou hast been,  
’Tis something better not to be.”

In a religious form this pessimism appears as a belief that man is a creature at the mercy of more potent agents, to whom his wishes and fears are of slight importance. Called into existence by instrumentalities over which he has no control, he is involved in a lifelong conflict with forces, natural and supernatural, which work out their inevitable issues with utter indifference to his weal or woe. The wheels of the universe are deaf to the cry of human hearts. There is a hopeless sense of inequality in the struggle between the petty self-centred will of man and the capricious and irresistible forces of nature.

This natural and instinctive pessimism is contemporaneous with the non-theistic religions of the world,—with all the forms of nature-worship, from the grossest and most trivial polytheism to the abstrusest schemes of naturalistic pantheism. In such a state of belief man tries to obtain relief from the burden of troubles in various ways. There is first of all the vulgar method of adulation and sacrifice. The powers of the unknown which lie ready to thwart the plans of man, and which he conceives in the likeness of beings with vaster forces but with passions and susceptibilities like his own, may be bribed by gifts or placated by flattery. Hence the common practices of superstitious worship. A second means of escape from the burden of life is given by what may be called Epicureanism. While not denying the divine, it explains away the gods of popular religion, and at the same time rejects the attempt to transform the idea of necessary connexion from a principle for

the explanation of phenomena into a controlling agency at the summit of the universe. Within the limits fixed by his natural conditions it represents man as free to work out his own welfare without interference from superior powers. But it is forced to admit that the happiness which man can obtain is after all only negative,—all pleasure is but the withdrawal of pain, and the utmost range of pleasure lies in varying the methods of such deliverance. Epicureanism is pessimistic; but it is an egoistic pessimism which is content to aim at the maximum of painlessness for the individual, and which ignores the metaphysics of universal pain and of universal relief from that pain.

The third method of relief from the troubles of existence has a closer analogy with the pessimism of modern times. It is the Buddhism of the East. Buddhism, whatever be the uncertainty attaching to its founder's personal story, is to all intents a shoot which has been cut off from the main tree of Brahmanism. Its theory rests on the metaphysics of the Brahmanical schools; its scheme of life is one out of the many phases of Hindu asceticism. Buddhism left the parent stock of Hindu religion at a time when the metaphysicians had carried up the polytheism of their country into a unified pantheism, when the philosophy of the Upanishads had worked up the comparatively rude theology of the Vedic hymns into a compact doctrine. The fundamental dogma presented by this system is the contrast between the true self or permanent reality of the world and the changes and plurality of the phenomenal scene in which men live or seem to live. On the one hand is Brahma, or *Atman*: from one side, the universe, the All, and everything,—from another, the true self, the Ego, the absolute, whose name is the *No, No*, because no words can describe him, the very reality of reality. On the other hand is the world of growth and decay, of sorrow and death,—the world, as it was subsequently called, of illusion, *Máyá*, where the semblance of firm reality is deceitfully assumed by the phantoms of creation. And as in the universe, so is the contrast in the human soul. There is the unredeemed soul, which desire and action (the will *in posse* and *in esse*) hold fast in the bonds of changeable existence, in the mutations of metempsychosis; there is also the redeemed soul, which by ascetic virtues, by renunciation of domestic ties, by the continued practice of self-denial and mortification, has found its way from the world of illusory semblances to its true and abiding self.

It is on some such conception of the world, in which over against Brahma in his eternal quiet there stands man suffering and yearning for relief, that Buddhism ultimately reposes. But, while the speculative theories of the Brahmans put in the foreground the august mystery of the All-one, Buddha starts from the other side of the picture, from the actual experience of life. The four truths of Buddhism, which are the foundation of its religious creed and the recurring burden of its teachings, leave the metaphysical basis out of sight. All life is sorrow, says the first: birth, age, disease, death, is sorrow; and the cause of this sorrow, adds the second truth, is the thirst which leads from birth to birth,—the thirst for pleasures, for existence, for power. The third is, that sorrow can only be removed by the complete annihilation of desire; and the fourth prescribes the means of word and act forming the eight parts of the way which frees from sorrow. The practical need is everything; the theoretical basis, the Brahma, which the orthodox schools presented as the sole reality, is so completely lost sight of that the modern critics are at variance with each other as to how far the goal of Buddhist endeavour can be described as anything positive. That all life is pain is the one perpetual refrain of Buddhism. The search for pleasure is vain and ends in increased misery. But the true Buddhist does not allow the per-

ception of this fact to cause, still less to perpetuate, a feeling of melancholy. It only urges him to have compassion on his suffering brothers, and to look forward joyously to the goal of release which he has set before himself.

For further details reference may be made to the article on BUDDHISM. It is enough to say here that the chief point of Buddhist theory is to see in all apparent being only a process of becoming: events happen, nothing is; the only permanence can be the law of their occurrence. The cosmic philosophy of Buddha is like that of Heraclitus. "All things flow; nothing abides"; only this flux of everything serves to emphasize the fact that the happiness of man is thereby rendered vain. The end which Buddha seeks is the redemption of man from this toilsome world of birth and death. It is not absorption in the unity of Brahma, not felicity in a higher and better world: It is, to cast off the conditions which trammel existence, the consciousness which leads to desire and action, the body and all its appurtenances; it is, to attain death in life, to have so mortified flesh and spirit that the individual can no longer be in the ordinary sense said to exist. He has attained, when so perfected, what is called Nirvāna, "the land of peace where transitoriness finds rest."

Before discussing the development of this pessimistic ethics in modern days, it remains to notice a fourth issue from the evil that is in the world. This view of life and of the universe is specially connected with Hebrew monotheism and its later developments in Mohammedan as well as Christian doctrine under the potent stimulus of Greek philosophy. It is in the belief of a moral God—a good and wise creator and governor of the universe—that the optimistic problem and theory finds its chief origin. When the idea of God has been purged of its naturalism and identified with the ideal of wisdom, goodness, and justice, there soon arises for thinking minds the necessity of a "théodicée,"—a justification of providence. Can the evil and misery found upon earth, the disproportion between merit and recompense, be explained on the hypothesis of a wise and beneficent ruler in heaven? One of the most familiar and typical instances of such a feeling is given by the book of Job. In the later times of Israel, when the vigour of creative faith was undermined by a critical spirit, born of bitter fates and foreign influences, voices were heard, like those of the writer of Ecclesiastes, giving utterance to pessimistic doubt. The story of Job is another and more edifying presentation of the same theme. How, it is asked, can the misfortunes of the just man be harmonized with the idea of a righteous God? Is suffering the penalty of sin, and must virtue be always paid its wages in pleasure?

The difficulty, it is evident, arises with the perception of the antagonism between the natural and the moral, and implies a desire to bridge over the gulf between them. With the gradually deepening conviction that the central principle of the universe is a moral principle, the need is felt for explaining the immorality (so to speak) of the natural laws, for reconciling the unconditional imperative of the word of duty with the indifference to right and wrong displayed in the facts of life. Sometimes we are referred for answer to another world, which shall compensate for the mistakes of the present. At other times it is suggested that physical evil has the function of a moral discipline, that suffering teaches nobility, that misfortunes are blessings in disguise.

The optimism of Leibnitz is of a different cast, and goes more boldly to face the real difficulty of the situation. It argues against the common estimate of moral and physical evil, and seeks to reduce them both to little more than privations of good,—to mere absence of good, to a defect rather than a blemish, to what is called metaphysical evil.

The world, it is admitted, is far from perfect, but it is as good as it could be made if all the good which it contains was to be realised. Like everything else, it is not free from the defects of its qualities. It is, we may be sure, the best of possible worlds. But this is far from saying that it is a good world. Ignorant as we are of the limits of what is possible, it is not for us to say that the quality of the best, under the given circumstances, is at all distinguishable from what is really very bad. The defence of theism which Leibnitz thus undertook against the sceptical suggestions of Bayle is only the common argument that the work must be judged as a whole, that it is unfair to pronounce judgment on an isolated event or thing apart from the question how it is affected by its interdependence. But, unfortunately, in the case before us, in the problem of the universe, we do not know the whole, and can only grope our way tentatively from point to point, feebly endeavouring to forecast the plan of the total structure.

But Leibnitz goes farther than this assertion of interconnexion or adaptation. It is the ultimate assumption of his argument that the forces of the universe are in the hands of a perfectly wise intelligence, that, as in man there is a rational power of initiation and guidance, so in the world as a macrocosm there is a primal reason which governs its movements and co-ordinates them to a desirable end. The actual phases of existence only carry out in palpable shape and successive or simultaneous manifestations an ideal or rational plan, which is their original and sufficient reason. The world at large is somewhat of a machine, or a congeries of machines, which run down according to their own internal and innate conditions of existence; but these machines are wound up by one supreme machinist, who has predetermined the aim and object of their combined movements. Thus the doctrine of the pre-established harmony, while on the one hand it is an apotheosis of logic by the emphasis it lays on the necessary causal interdependence of the several partial movements, is on the other hand, by its principle of sufficient reason—the *principe du meilleur* or *de convenance*—a doctrine of teleology, whereby an ideal principle of design interpolates the contingent and subordinates necessity to freedom. The world is not a mere group of causes and effects governed by the logic of contradiction and identity; over and above the necessitarian logic is a mind which looks behind and before, and combines all events, not recklessly or necessarily, but in the hands of reciprocal subservience to the greatest good of which they admit.

In this argument Leibnitz is open to the criticism of Kant, that he has passed from a legitimate conception presiding over the synthesis of phenomena to the illegitimate idea of a self-subsistent and personal principle, which, far from being a mere ideal of complete synthesis, itself creates and predetermines that synthesis. To the logical scientist the phenomena are merely connected by a formal unity; to the theist like Leibnitz this unity is identified with a cosmical mind, an intelligent power which regulates the evolution of things and subordinates them all to the fulfilment of its original plan. Leibnitz thus manipulates two ideas, the logical and the religious, as if they were interchangeable, though in reality they lie in different planes. The reason which at one time is treated as an abstract principle of self-consistency is at another time clothed in the concrete mental life associated with it under its human aspects. Mere reason, says Aristotle, can initiate no change; it neither chooses nor commands, but simply asserts. But human reason is always (in the technical sense) practical, and only for moments of abstraction ever merely theoretical. Thus the reason in the universe was



spoken of as God, and conceived anthropomorphically after the pattern of human personality.

The optimism of Leibnitz found its well-sounding but somewhat misleading phrase that all is for the best in this best of possible worlds bitterly satirized in Voltaire's *Candide*, and painfully commented upon by the earthquake of Lisbon. But the real object of the Frenchman's wit was the baser optimism of the age which sheltered its vulgar features under the mask of the Leibnitian *Theodicee*. An easy-going generation had settled down in the pleasing faith that their barns were filled with good things for many years, and that they might eat, drink, and be merry. The creed found in England a prophet of solemn pomp in Pope, whose *Essay on Man* has fixed in pregnant lines the main half-truths of the Leibnitian theory, which the poet had probably learned from Bolingbroke. The same optimism appears in Shaftesbury ("Tis good which is predominant"), and shows its presence in Paley. Some opposition to the current eudæmonism is found in the well-weighed and all but sceptical judgments pronounced by Butler, as well as in the cynical pessimism that tried to raise its voice in Mandeville. But the great instance against the comfortable view of life is the striking passage which Hume in his *Dialogues concerning Natural Religion* has put in the mouth of Demea, beginning "The whole earth, believe me, Philo, is cursed and polluted. A perpetual war is kindled amongst all living creatures," &c.

In Germany, under the head of Natural Theology, the ordinary optimism flourished apace. The whole range of creation was ransacked to show how well man had been provided for by God. The poetry of Brockes (the translator of Pope) is full of the theme,—the laudation of the many gifts we owe to Providence, of the multifarious uses to which each animal and plant can be put. It is an anthropocentric optimism which thus makes man's welfare the main end of the creation, and which, above all, finds that welfare in what we eat and drink and wherewithal we are clothed. The good which Leibnitz had spoken of was understood as material prosperity, comfort, happiness. God's goodness was measured by the amount of worldly wellbeing which He bestows upon us.

The great Kant, as late as 1759, when he printed a short sketch *On Optimism*, was still inclined to keep terms with this base caricature of a great theory, and spoke with full agreement of that theory itself. But here as elsewhere Hume's influence was potent upon him, and in a paper published in 1791 (*On the Failure of all Philosophical Attempts in Theodicy*) he had altered his tone. Our intelligence, he argues, is absolutely powerless to discover the proportion in which the world, at least as known to us in experience, stands to the supreme wisdom. And to the grounds adduced to prove that the pleasures of life far exceed its pains his reply is: take a man of sound mind, who has lived long enough and thought enough on the value of life to be able to form a judgment on the subject, and ask him whether he would like to play out the game of life once more (not on the same terms, but) on any terms he pleases, be it only in this terrestrial world of ours, and not in fairy land. In one direction indeed Kant may be called optimist (or at least meliorist),—in his belief in the ample possibilities of moral and political improvement, and in his enthusiastic hopes for the cessation of some chief causes of human misery.

But in one way Kant had laid the axe to the chief root of optimism. That root is the utilitarian or eudæmonistic theory of conduct,—the theory which seeks to explain morality away into a sort of magnified selfishness, and regards the authority of moral rules as due to their origin in counsels of prudence. The moral law, said Kant, is the one clear utterance of the Absolute. And the lesson

thus taught bore fruit. At first indeed idealism with its optimistic interpretations returned. The double-faced dictum of Hegel, that the real is the rational and the rational the real, was often understood to justify the principle that, whatever is, is right. The net of Hegelian thought seemed to grasp everything; everything fell as it were naturally into its place, and seemed to be justified by the symmetry of its position in the logical evolution. For in idealism we find the true home of optimism. The world as experienced in sense and feeling is full of discords and defects, and the more we abstract each part of the whole into its "beggary elements," the greater seems the weakness and the triviality. But, when we rise in thought to the contemplation of the unity and order, these real discords pale before the spectacle of ideal harmony. The formal symmetry carries the day. The corpse may be hideous and yet the theory of the anatomist has its beauty. The sorrows of the hero do not make impossible the pleasure of the spectator in the drama. Just as the hardships long ago endured are sweet to remembrance, so the individual sufferings are lost in the conception of the universal ends they subserve. The real pain is compatible with a formal pleasure; reason can find commendable and good what is torment to flesh and blood.

But, while the life-work of Hegel had been to show that at bottom the principle of being and the principle of thought were the same, that nature and history were the incarnations of reason, the succeeding philosophy of Schopenhauer reverted to the distinction of Kant, which it emphasized, between thought and existence. Schopenhauer dethroned reason and claimed to have discovered the real root of that being which we know as an idea. This root of existence is what he called Will. The source of the reality which we cognize—the secret essence which is objectified in the forms of the universe as it presents itself to our conceptions—is Will. By this Will he meant a blind but irresistible effort to exist, a craving of inexpugnable strength towards life and objective being, an unconscious lusting after the pleasure of manifesting itself as something acting here and now. It is something less than Will, as we know will, and yet something more than force. Under every known kind of actions and phenomena in space-and-time—phenomena, known by their reciprocal relations—there is an unknown but felt something, an endless, aimless, limitless struggle to be upraised into the light of existence. This ultimate basis of will-force we must assume as the fact presupposed by all specific causal explanations. But in its generic basis the Will has no definite aim; it is the will to be everything in general and nothing in particular,—the will to be, to do, to act. End or purpose supervenes only with the rise of consciousness. Intelligence comes forward at first as a mere organ in the service of the Will; it is only a means for the preservation of the individual and the species. It is observable first in the animal, where the purely instinctive stimuli fail to procure sufficient material for subsistence, where the food has to be selected, and the motions of the animal are accordingly dependent on motives, i.e., on conceptions of objects to be attained. It is this need which occasions the development of the brain; with the brain intelligence rises upon the scene; and thus the world now comes to see itself, not in its reality, but in its phenomenal objectification, as the realm of causes and effects in the element of space and time. This conscious knowledge, which at first consists merely in momentary and individual perceptions, attains higher powers, as abstract and general reason, by the aid of speech.

Now intelligence, which originally came with the formation of brain-tissue as a mere tool of the Will in the more complex forms of its objectification, may rise at length, according to Schopenhauer, to be the liberator of the

human race from the restless tyrant which works in them now, as it erewhile brought them to the birth. For, firstly, knowledge in its own character emancipates; it lets its possessor know that he suffers and why he suffers. Such is the first prerogative of reason. But, secondly, in the occasional intervals when the storm of Will is laid to rest, the mind, instead of striving in the interests of practical intelligence to detect the causal relations of things, can concentrate itself exclusively on a single isolated object. A transformation is thus accomplished whereby the object, ceasing to be a mere particular, becomes the type-idea, the eternal form, the generic and adequate embodiment of Will in a special grade; while, on the other hand, the individual who has become absorbed in such contemplation is no longer a mere individual, but has become the "will-less, painless, timeless subject of knowledge." It is this power of rising above the prosaic requirements which science gratifies, of seeing the permanent and one reality in the dependant and disunited phenomena of the particulars, which what we call Art imitates by production. The artist produces the eternal types which the blind Will only realizes in many imperfect and particular adumbrations; he conquers nature by fixing in a single image the traits which constitute the true and permanent meaning confusedly presented by her in many exemplars. For the mind which can see that idea in the natural forms, or which beholds it in the works of art, for him who contemplates without reference to the Will, "the wheel of Ixion stands still; freed from the prison-house of blind desire, he enjoys the sabbath of æsthetic beatitude."

But the relief obtained in art is only for blessed moments. Perennial consolation can be found only in the ethical life, and in an ethics of asceticism and self-sacrifice. True life begins only when we have learnt that happiness is impossible by means of gratifying the cravings of desire. Each satisfaction of the will is only a starting-point for fresh effort; the achievement of the desired object suggests a new want. "Alles Leben ist Leiden." At every point desires are thwarted; even when they gain their end the satisfaction is merely negative. The weary Titan of humanity knows no repose; his feeble pleasures are drops in a sea of pain. Thus the central principle of pessimism asserts that in the order of nature, *i. e.*, so long as the will to live remains unbroken, happiness in the true sense is impossible. Life as life necessarily involves misery. No doubt the man of the world may turn round and declare that notwithstanding this he means to gather the rose without the thorn. Undismayed by the analysis of the consequences involved in will, he affirms the will to life. Adopting the principles of the Cyrenaic hedonists, he closes his eyes to far-reaching eventualities and lives in the moment; he turns life in every portion into art; he revels in the inspiring sense of action without care for past obligations and future anxieties. It is otherwise with the man who has surveyed all the issues of things, who looks at the net result of life as a whole and in all individuals. For him it is a duty to deny and abjure this will to life. He must, in other words, renounce the works of egoism and of injustice. He must see through the illusion of the *principium individuationis*, must recognize that his very self, his will, is identical in essence with every creature, even with the suffering. When he has done this, and is in love and sympathy with all around him, "the veil of Maya" has for him become transparent. In every way he proceeds (over and above cultivating in active love compassion for others) to deny the exercise of the will to life in his individual case, in his own body. He will, above all, according to Schopenhauer, perpetually keep the vow of chastity; he will by fasting and penance so mortify his body that the will to life shall be utterly broken in him.

"And," adds Schopenhauer (§ 67), "I think I may assume that along with the highest manifestation of will the feeble counterpart of it in the animal kingdom would also disappear." Man, by ascetic mortification of the will, and by sanctity of beneficence, becomes the redeemer even of the rest of the animated creation.

The contrast between nature and grace, between the physical and the moral, the life of the flesh and the life of the spirit, stands out in these outlines as the central doctrine of pessimism. It is in essentials the same doctrine which was preached by Buddha, which is put into the mouth of Socrates in the *Phædo* (philosophy is a rehearsal of death: *μελέτημα θανάτου*); it is the doctrine which stands indelible in the early archives of Christianity, and was proclaimed as the better and more excellent way by myriads of the noblest Christian teachers for more than ten centuries of the church. The pessimistic ethics of Schopenhauer casts aside the feeble compromises by which it is alternately asserted that morality makes for happiness and happiness is morality; it rejects the postulates by which Kant tried to lighten for human nature the burden of imperative duty; it goes behind the social sanctions which see in good conduct acts subservient to the good of a human community. In pessimistic ethics—and the pessimism of Schopenhauer has essentially an ethical aim—we have the wreck left on the wastes of time by Hegelianism. Hegelianism had taught, or seemed to teach, that God was in the beginning by Himself as a Logos, or self-evolving idea, which uttered itself in the unconscious forms of nature, till in the conscious spirit of man He gradually realized Himself in moral and intellectual life, in art and religion. Schopenhauer stripped this cycle of its first period. There was no idea, no logical machinery, at the basis of things; nature began out of a blind impulse; and it was only in man's intelligence that the vague longing of the heaving world knew itself to be. But that intelligence has for its supreme aim—not, as in Hegel, to enter into and carry on the great process which is the absolute, but—to deny its creator and annihilate the principle of being. The world of Will, in its process of objectification, has thus given birth to a child which in the fulness of time will destroy the womb that bore it.

It will be apparent that in Schopenhauer's system we can distinguish two parts,—the first, the doctrine of the positivity of pain, and that life is always and only pain; the second, the ethical condemnation of the principle of such a world, and the method for correcting the evil which it had introduced. In the latter lies his chief and characteristic achievement,—in what we may call his metaphysic of ethics. Man by morality (ascetical morality) is to be the redeemer of the world. In this conviction Schopenhauer shows himself the descendant of the metaphysical systems of the past, which find in man the key to the mystery of the universe. It is a strange and a weary way of redemption which he delineates; the cross is heavier than humanity seems able to bear. Yet the suggestion to deliver ourselves shows that the old belief in human spontaneity, in the primacy of the moral principle, in the possibility of noble deeds and of a victory over egoism, was still vigorous in his mind. Another pessimism neglects this ethical element altogether. To this ignoble pessimism man is in truth only an animal like the rest, and the distinction on which he prides himself—his moral nature—is but a confused and illusory product of simpler animal experiences. He has knowledge of wider range, it is true; but knowledge is powerless to change his nature. His acts in every case are necessarily determined; his fancied freedom is found on examination to be no whit more spontaneous than the fall of the unsupported stone. The necessitarianism of evolution did away with the independ-

ent existence of morality, and reduced it to conventional stereotyping of natural symbols, with forgetfulness and misinterpretation of their meaning and applications.

To an age so minded the consolations of pessimism sounded faint and unreal. They had lost the old *σὺ στυγῆ*,—the optimistic creed that man was the undisputed head of creation. They saw themselves no longer a select race, favourites of God, but as-engaged in the struggle for life with thousands of other species. The rôle of saviour of the world was not for them. And so, turning a deaf ear to the high words of Schopenhauer, they sought easier consolations in the common and casual pursuits and pleasures in the world; they determined to make the best of this vale of tears,—even in Pandemonium there might be shady spots and cool retreats. A few spirits who had drunk more deeply at the wells of suffering, and who were alike without the mental energy of Schopenhauer and the comfortable inconstancy of the mass of men, could not rise beyond the ever-present sense of the emptiness and infelicity of life. There are many such types in literature; but perhaps no more perfect expression has been given to the strange abysmal melancholy of a withered life than by the Italian poet-scholar Leopardi. At one time dallying lovingly with the idea of death, at another finding only deception and illusion in love, liberty, progress, and all human ideals, and almost always with irony, bitterness, and hopelessness living in the sense of an inexorable destiny, a malign nature, which calmly motions man to destruction, Leopardi presents pessimism in its naked terrors. For him there are no consolations, either base or noble. Man is at the mercy of a pitiless nature; he must endure a thousand deaths daily. This mood of Leopardi's, however he himself protested against the suggestion, was unquestionably to a main extent due to the tremendous disproportion in which his mental and aesthetic nature stood to the circumstances of his life, and not a little to the general political condition of his country.

When the first edition of Schopenhauer's great work appeared in 1819 it did not attract much immediate attention. Pessimism was in the air: the Romantic school in Germany, and especially Heine and Lenau, Byron in England, and Chateaubriand in France,—not to mention many other names,—all in their several ways gave expression to the "Weltschmerz." Yet it was not till 1844 that a second and much enlarged edition of the work appeared, followed by a third in 1859. By this time the doctrines of Schopenhauer had found many enthusiastic followers, and a flood of literary works poured from the press in criticism or support of them. With the year 1866 the title "Pessimism" began to show itself in books which discuss his views. And in 1869 appeared the *Philosophy of the Unconscious*, by E. von Hartmann. The popularity of this work was enormous. In the ten years which elapsed between its publication and that of Hartmann's next systematic work (*The Phenomenology of the Moral Consciousness*) it had run through eight editions. The lesser works of Hartmann, his articles in reviews, the pamphlets by friends and opponents during the last fifteen years, are truly named legion. The question "Is life worth living?" has become a question of the day, to which the problems of socialism, liberalism, and religion contribute their quota. The novels of Turgenieff and Sacher-Masoch are full of the ideas of Schopenhauer's pessimism.

Hartmann's first work was written when its author was twenty-five. It bears traces of the paradox and exaggeration which sometimes go with youthful talent, and occasionally pays the tribute of imitation to the naturalistic pruriency and sensationalism of the contemporary novel. The style is cumbersome and pretentious. And yet its popularity proves that its author has the faculty of directing

with no unskilful or incompetent hand the vague and incoherent tendencies of the cultivated masses. The world which has lost hold of, and perhaps broken with, the faith of its fathers is on the look-out for a "Weltanschauung"; it wants to know the metaphysical inferences to be gathered from the recent advances of scientific theory. Not merely had Darwinism, as may be seen from the character of Häckel's *Natural History of Creation*, caught the public ear more widely in Germany than in England, but the deductions from its principles had been carried to far greater lengths. Amid the decay of distinctively Christian beliefs, and even of theism, the doctrine of pessimism attracted a sort of religious fervour. The prevalent sense of dissatisfaction and baffled endeavour was met by a theory that the principle of the universe was radically perverse, and could not be amended. And, if it be urged that it is difficult to believe in the genuineness of a pessimism when its professors take their ease and mirthfully jeer the stranger who expected to find people not clad in soft raiment nor dwelling in kings' houses, it may be replied that pessimism is not the only temporizing creed. The moral indignation (*Entrüstungs-Pessimismus*) of a Carlyle or a Juvenal, which pours its vials of scorn on the selfish meanness of mankind, and the churchly exhibition of the sores and frailties of human flesh and blood in which books like the *De Contemptu Mundi* of Innocent III. revel, alike overshoot their mark and leave the world unconvinced of its nothingness.

It is out of place here to enter into any lengthened exposition of Hartmann's metaphysics. This world, according to him, is the work of an Unconscious, a being which is at once will and intelligence,—a will urging to be and to do somewhat and an intelligence which adapts means to ends. But the will is only instinct, and the intelligence is the unconscious reason which guides the somnambulist or the clairvoyant. Thus there is wisdom in the frame of the world, but the original resolution to exist was the work of a blind will. Reason did not prompt the initial act, yet at every movement towards existence an unconscious reason effectively correlates the elements into united action. The various individuals seem indeed to be acting of themselves: they pursue aims of their own; but they are only puppets in the hand of nature, the unconscious intelligence and will. Apparently, there are many agents, each in some degree independent; really, there is only one source of action, the union of will and idea in instinctive adaptation and unwitting design.

With man at length consciousness awakes, and the possibility is laid for a new relation between the two elements in the universal principle. Knowledge, however, is not an end in itself; it is not enough to know the process of the world. The consciousness which is generated at length by the unconscious reason out of the workings of will has its function marked out for it beforehand by its unconscious author. Its final purpose is to revoke the effects of that irrational step by which the unconscious will in its eagerness to exist dragged the idea with it in its service. The hour of vengeance may come some day. The intelligence which has become conscious in man may at length induce his will to take the backward step, to retire into non-existence even as it erewhile rose into existence. In that day when the force of will has been mainly accumulated in the province where intelligence prevails, it is probable that a successful act of suppression of the will to life on the part of human reason would entail the utter prostration and annihilation of the will to life throughout the universe. By the act of its intelligent portion, in which the major part both of the cosmical will and intelligence has been gradually accumulated, the world, as a whole, will commit suicide.

But Hartmann is not merely a metaphysician; he proposes to supply inductive proof for his propositions. The question of the preponderance of pleasure or pain in the world is to be worked out by observation of facts and summation of figures. So far differing from Schopenhauer, he admits the positivity of pleasure, but maintains nevertheless that pleasure and pain are representable by quantities of the same denomination, prefaced respectively by the *plus* or *minus* sign. When the accounts of debt and credit are drawn out, it appears that the balance is enormously on the side of pain. To him who has once perceived the surplus of pain it is an obvious duty to extinguish the source whence sprang the unmitigated evil. Yet mankind in the past has shrunk from the acceptance of this conclusion, and sought refuge in three successive illusions: (1) the naive illusion of the natural mind that happiness is to be found in this present world; (2) the illusion that happiness, though a failure here, will be realized in the world beyond the grave; (3) the illusion which puts its hopes on the amelioration of humanity in the future history of the world. One after another these illusions are shown to be vanity. A little taste of pleasure, amid the insipidity and bitterness of life, is snatched by a select few from the consolations of art and science. But at last, as wisdom grows and the hopeless monotony of grief is more acutely felt by the race, humanity will rise up boldly to the last great act of despairing suicide, and reduce the unconscious to its primeval nullity.

If we pass from this grandiose drama of the birth and destruction of the universe to consider the ethical doctrine which Hartmann supposes himself to base upon his metaphysical theory, we find ourselves on safer ground. For, apart from the method by which he reaches it, his moral principle is not very different from the general view on such subjects. The basis of morality in his theory is the relation of the individual consciousness to the Absolute in which consists its true being. It is in this ultimate identity of the individual with the All-one—not merely in the preservation of his phenomenal welfare, or of the welfare of the society he belongs to, or the furtherance of some one ideal good—that the obligation to be moral is to be sought. On the other hand, there is nowhere in the universe a surplus of pleasure; and therefore the moral agent cannot either here or elsewhere look for happiness in a positive sense as the reward of his virtue. Egoism of every range—from the more materialistic to the more religious pleasures—is incompatible with genuine virtue. The aim of morality is the redemption of the whole world from the evil into which its initial act has plunged it. And in this act of redemption—the result of which will not be joy, but rest, the quietude of the universe—man by his intelligence and will is the main worker, the fellow-worker of the Absolute; it is by him that God works out the redemption of himself and of the universe. "Real existence," so closes the *Phenomenology of the Moral Consciousness*, "is the incarnation of the God-head; the world-process is the story of the Passion of the God who has become flesh, and at the same time the way to the redemption of Him who is crucified in the flesh; but morality is the co-operation towards shortening this way of suffering and redemption."

It would be vain to criticize in detail these speculations, out of which a few principal points have been adduced, and which, besides being in themselves vague, are pliable in the hands of their author. But a few remarks may be made on some main issues involved in the dispute. It may be admitted in the first place that the doctrine of the origin of existence in an a-logical principle is but an extravagant way of stating that the intelligence when it awakes to consciousness finds itself in presence of another world of

nature and custom which seems irrational and antagonistic—a world which is outside of us and seems to mock our puny individual efforts for its improvement. Secondly, it may be admitted that there is no evidence for the thesis that the world was intended to suit the convenience of man, or of any species whatever. As a matter of fact, there is abundance of misery in the world. But, quite apart from the reducibility of the amount by the application of intelligent means, it seems certain that no attempt to draw up a balance-sheet of absolute cosmic misery or happiness is ever likely to be successful. It is as irrational to pronounce this to be the worst of all possible worlds as the best. The superlatives employed in the terms "optimism" and "pessimism" betray a passionate estimate of things. Life, one has said, would be tolerable but for its pleasure. Even those who, like Leopardi, have declared themselves in love with death, show, by still electing to live, that life has something not measurable by pleasure, yet chosen even amid mental tortures and extreme ill-health. As Aristotle said long ago, we are not unbiassed judges as to Pleasure v. Pain. Thirdly, if it were worth while, it might be urged that the main terms of the pessimists are extremely vague. The "Will" and the "Unconscious" cannot be tied down to a definite meaning without losing their power; the contrast between the positivity and negativity of pleasure and pain shows an ignorance of logic; and, above all, the habit of transferring the terms of religion to express what are supposed to be analogous ideas in pessimistic metaphysics is misleading.

The pessimistic theories of modern times are in part a commendable protest against the common compromises which slur over the antithesis between the moral and the natural. They show tolerably conclusively that the world is not a felicitous institution, and that he who makes happiness the aim of his life is on the wrong tack. But, when they proceed to dogmatize that existence has a root of bitterness and life is a burden of pain, they fall into the common error of exaggerating a statement relatively true into an absolute principle. You cannot tell if life is worth living, so long as life is held to be the sum or difference of pains and pleasures. If pains and pleasures were only and always such, the argument might be admitted; if they were permanent real entities, not liable to be transformed into each other, not constantly associated in the same act, it might be possible to treat them as ultimate and irreversible standards for our estimate of life and the guidance of our conduct. If pleasure and pain are unequally and unfairly distributed, it is probable that this is a fault which human agency can cure to an unspeakable degree, quite without the desperate remedy of self-torture or cosmic suicide. If pessimism can teach the world that the highest reward of virtue is self-respect, and that there is no pleasure available anywhere to bribe us to be good, it has done well. It has also done well if it points out the barriers to happiness in this world, so long as these barriers prevent true life and can be removed by wise methods. But in the meanwhile, till the burden of existence has become universally unbearable, it may be well to remember that we shall be as likely to benefit the Absolute by doing our work well as by macerating ourselves, and that the sum of existence is a big thing, of which it were rash to predicate either that it is altogether and supremely good or altogether and supremely bad.

The works on pessimism have been numerous lately. Most of them, however, deal with it mainly in connection with the two German philosophers, and of these several treat exclusively of the special metaphysical and psychological theories. For Buddhism, see *BUDDHISM*, vol. iv, p. 424 *sq.*, and also Oldenberg's *Buddhism* (1881), since translated into English. An account of Schopenhauer was given by R. Adameon in *Mind* for 1876, and in *Miss Zimmerman's Life of Schopenhauer* (1876); the first account of Hart-

mann to English readers was given in an article by E. Wallace in the *Westminster Review* (1876). In 1877 there was published a full discussion of the subject by J. Sully, *Pessimism: a History and a Criticism*. There are chapters on the question in many recent works; among the latest Tulloch, *Modern Theories in Philosophy and Religion* (1884). In France we have Ribot, *Schopenhauer* (1874); Caro, *Le Pessimisme au XIX<sup>e</sup> Siècle* (1878), who gives an account of Leopardi, Schopenhauer, Hartmann. In Italian may be mentioned Barzelotti, *Il pessimismo dello Schopenhauer* (1878). The books published in Germany are countless, e.g., Dühring, *Der Werth des Lebens* (1865); Bahnsen, *Zur Philosophie der Geschichte* (1872) and *Pessimisten-Brevier* (1879); Hartmann, *Philosophische Abhandlungen* (1872); Meyer, *Weltleid u. Wollschmerz* (1872); Taubert, *Der Pessimismus und seine Gegner* (1878); Volkelt, *Das Unbewusste u. der Pessimismus* (1878); E. Pfeiderer, *Der Moderne Pessimismus* (1876); Gass, *Optimismus u. Pessimismus* (1876); Huber, *Der Pessimismus* (1876); Rehmke, *Die Philosophie des Welt-schmerzes* (1876); Sommer, *Der Pessimismus und die Sittenlehre* (1883); Plümacher, *Der Pessimismus in Vergangenheit u. Gegenwart, gesch. u. kritisch* (1884). There is a list of books on the subject up to 1880 in Laban's *Schopenhauer Litteratur*. For LEOPARDI, see vol. xiv. p. 464 *sq.* Schopenhauer's *Will as Will's und Vorstellung* is in course of translation by Haldane and Kemp (vol. I., 1883); and Hartmann's *Philosophie des Unbewussten* has been translated by W. Coupland, 3 vols. (1883). (W. W.)

**PESINUS**, or **PESINUS** (Πεσινούσ, Πεισινούσ), an ancient city of Galatia in Asia Minor, situated on the southern slope of Mount Dindymus. It stood on the left bank of the river Sangarius, about 150 stadia (17 miles) from its source, and 16 miles south of Germa on the road from Ancyra to Amorium. It was the capital of the Tolistobogii and the chief commercial city of the district. It was famous for its worship of the mother of the gods (Cybele), who here went by the name of Agdistia. Her priests were anciently princes as well, but in the time of Strabo (1st century B.C.) their privileges were much diminished. The kings of Pergamum built a new temple adorned with porticos of white marble. The image of the goddess, a stone (or piece of wood) said to have fallen from heaven, was taken to Rome in 204 B.C., in compliance with an oracle in the Sibylline books to the effect that the foreign foe could be driven from Italy if the Idæan Mother (Cybele) were brought from Pessinus to Rome. But the goddess continued to be worshipped in her old home as well as at Rome; her priests, the Galli, went out to meet Manlius on his march in 189 B.C., and at a later age the temple was visited by Julian the Apostate. In the division of the empire under Constantine, Pessinus was made the capital of the province Galatia Salutaris. It was also the seat of a metropolitan bishopric. After the 6th century the town disappears from history. The ruins discovered by Texier occupy three hills near the village of Bala-Hissar, 9 or 10 miles south-east of Sevri-Hissar. They include a theatre in partial preservation and numerous fragments of marble columns, friezes, &c. The modern town of Sevri-Hissar is built at the height of about 3000 feet on the southern base of a steep granite rock, half-way up which are the ruins of a castle.

**PESTALOZZI, JOHANN HEINRICH** (1746-1827). See **EDUCATION**, vol. vii. p. 677.

**PESTH**, the chief town of Hungary and the second of the Austrian-Hungarian monarchy, is situated on the left bank of the Danube, 140 miles to the south-east of Vienna, in 47° 29' 10" N. lat. and 19° 2' 56" E. long. Since 1873 it has formed one municipality with **BUDA** (*q.v.*) on the opposite bank, and the joint city, officially styled Budapest (Ger. *Pest-Ofen*), is the capital of Hungary, the second residence of the Austrian emperor, the seat of the Hungarian ministry, diet, and supreme courts, and the headquarters of the commander of the Honvéds or Hungarian landwehr.

The imposing size of the Danube, here somewhat wider than the Thames at London, and the sharp contrast of the two banks, place Budapest among the most finely-situated

of the larger towns of Europe. On the one side is a flat sandy plain in which lies Pesth, modern of aspect, regularly laid out, and presenting a long frontage of handsome white buildings to the river. On the other the ancient town of Buda straggles capriciously over a series of small and steep hills, commanded by the fortress and the Blocksberg, and backed by spurs of the vine-clad mountains beyond. The Danube is crossed by three bridges; the fine suspension bridge constructed by the brothers Clark in 1842-49, at a cost of £440,000; the iron Margarethenbrücke, a little farther up, dating from 1872-76; and a long railway bridge at the lower end of the town.

Budapest is divided into ten municipal districts, three of which are on the right bank and belong to Buda. The nucleus of the town on the left bank is formed by the inner town or old Pesth on the Danube, in a semicircle round which lie the districts of Leopoldstadt, Theresienstadt, Elisabethstadt, Josephstadt, and Franzstadt, while

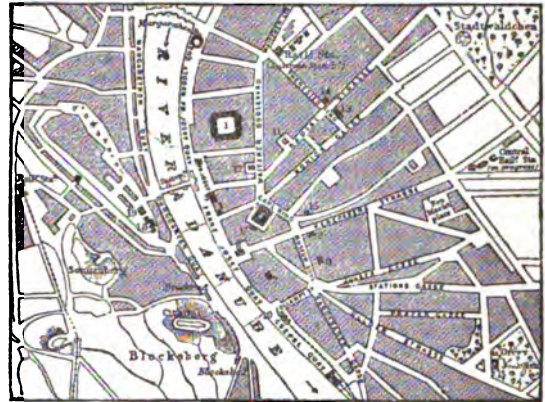

Plan of Pesth.

- |                      |                      |                       |
|----------------------|----------------------|-----------------------|
| 1. New Building.     | 7. Town House.       | 13. Academy of Music. |
| 2. Academy.          | 8. National Museum.  | 14. Exhibition.       |
| 3. Exchange.         | 9. National Theatre. | 15. Ludovicum.        |
| 4. Bedouls.          | 10. Custom House.    | 16. Synagogue.        |
| 5. Carl's Barraacks. | 11. Opera House.     | 17. Post Office.      |
| 6. Parish Church.    | 12. Leopold Church.  | 18. Palace.           |
|                      | 19. Arsenal.         |                       |

to the east of these is the outer district of Steinbruch. Perhaps the most attractive part of Pesth is the line of broad quays on the Danube, which extend for a distance of 2½ miles, from the Margarethenbrücke to the custom-house, and are lined with imposing white buildings. The inner town, part of which is somewhat irregularly built, is separated from the other quarters by a ring of spacious boulevards on the site of the old wall, and the lines of demarcation between the different districts also consist of wide tree-shaded streets, mostly paved with asphalt. Most of the larger public buildings are in the Leopoldstadt, which shares in the fine frontage on the Danube, or in the handsome new Radial Strasse, which traverses the Theresienstadt, with a width of 100 to 150 feet. Pesth covers more ground than most towns of a similar population on account of the large number of one-storied houses, which form 70 per cent. of its buildings (as compared with 8 per cent. in Paris, 3 per cent. in Leipzig, &c.).

Though of ancient origin, Pesth has nothing to show in the shape of venerable buildings; and the modern edifices may perhaps be described as more noticeable for the general air of prosperity they diffuse than for marked individual merit. The oldest ecclesiastical edifice is the parish church, dating from 1500, while the university church and those of the Leopoldstadt and the Franzstadt are the best of the more modern structures. The synagogue, however, is finer in many respects than any of its Christian rivals. The long range of substantial buildings fronting the Danube



includes the new houses of parliament, the academy, the exchange, the redoute, a large structure in a mixed Romanesque and Moorish style, erected for balls and other social purposes, the Greek church, the parish church, the old town-house, the extensive custom-house at the lower end of the quays, and several fine hotels and insurance offices. In the Radial Strasse are the new opera-house, the academy of music, the exhibition building, and the national drawing-school. The largest building in Pesth is the so-called New Building, in the Leopoldstadt, erected by Joseph II., and covering as much ground as an ordinary London square. It is at present used as artillery barracks; and the Carl's Barracks in the inner town, also used for housing troops, are little inferior in size. Another large military establishment is the Ludovicum, or officers' college, at the south-east end of the town. The remaining buildings remarkable for their size or interest are the new town-house, the post-office, the national museum, the theatres (of which there are about half a dozen), and the palaces of several of the Hungarian magnates. To the south-east of the town lie the new slaughter-houses, which are admirably fitted up, and, with the adjacent cattle-market, cover nearly 30 acres of ground.

The artistic and scientific culture of Pesth, and indeed of Hungary, finds its most conspicuous outward expression in the academy of sciences and the national museum, two large and handsome modern buildings. The academy, founded for the encouragement of the study of the Hungarian language and the various sciences, possesses a library of 100,000 volumes, and harbours the national picture gallery, a good collection of 700 to 800 works, formed by Prince Esterházy, and purchased for £130,000. The national museum contains extensive collections of antiquities, natural history, and ethnology, a gallery of mediocre paintings, and a library of 150,000 printed volumes and 12,000 documents. Pesth also possesses numerous societies for the cultivation of science and art, most of which, however, limit their usefulness by publishing their proceedings in the Magyar tongue alone. The university of Pesth, the only one in Hungary proper, was established at Tyrnau in 1635, removed to Buda in 1777, and transferred to Pesth in 1783. It is attended by upwards of 2000 students, and possesses the usual medical and scientific collections, an admirable chemical laboratory, a botanic garden, and a library of 120,000 volumes. Pesth also contains a Protestant theological college and a rabbinical institute. The second place among the educational establishments of the town is taken by the Polytechnic Institute, with its three faculties of applied chemistry, engineering and architecture, and mechanics; it is attended by about 1000 students. The other schools comprise six gymnasia, six normal seminaries, and a large number of special and elementary schools, in spite of which 32 per cent. of the adult population were unable to read or write in 1880. The charitable institutions of the city are on a liberal scale. Characteristic of Budapest is the large number of its public baths, the most interesting of which are at Buda.

In commerce and industry Budapest is by far the most important town in Hungary, and in the former, if not also in the latter, it is second to Vienna alone in the Austrian-Hungarian monarchy. The chief articles of manufacture are machinery, railway plant, carriages, gold and silver wares, chemicals, cutlery, starch, tobacco, and the usual articles produced in large towns for home consumption. The great staple of trade is grain, of which about 4½ million bushels are brought into the town annually. One-fourth of this amount merely passes through Pesth, while most of the remainder is ground into flour and exported in this form. Other important articles of commerce are wine, wool,

cattle, timber, hides, honey, wax, and "slivovitz," an inferior spirit made from plums. The imports, so far as they do not belong to the transit trade, consist chiefly of manufactured articles and colonial produce. The four annual fairs, formerly attended by many thousand customers, have now lost much of their importance. The swine market of Steinbruch is the largest in Hungary, about half a million animals being annually disposed of. The trade of Pesth is in great part carried on by the Danube, the navigation of which has increased enormously since the introduction of steamboats in 1830; but the town is also connected by railway with all the chief places of Austria and Hungary.

The largest and most popular of the public gardens and promenades in Pesth itself is the Stadtwaldchen on the north-east side, with its pleasant lake and trees. A still more delightful resort, however, is the Margaret Island, a long narrow island in the Danube, laid out in the style of an English park, with fine trees, velvety turf, and a group of villas and bath-houses.

Few European towns have grown so rapidly as Pesth during the present century, and probably none has witnessed such a thorough transformation in the last twenty years. In 1780 Pesth was still a badly-built town of the third rank, with only 13,500 inhabitants, and it was not till 1799 that its population (29,000) surpassed that of Buda (24,000). By 1840, however, Buda had added but 14,000 souls to its population, while that of Pesth had more than doubled; and of the joint population of 270,000 in 1869 fully 200,000 fell to the share of Pesth. In 1880 the population of Budapest was 370,767 souls, including a garrison of 10,000 men, showing an increase since 1869 of 32 per cent., and since 1800 of an average of 6 per cent. per annum. Of this total 198,746 were returned as having Hungarian for their mother-tongue, 119,902 as German, and 21,581 as Slovaks. Divided according to religious sects, we find 242,981 Roman Catholics, 70,879 Jews, 42,264 Protestants, and 3014 members of the Greek Church. Of these the Jews show the greatest relative increase since 1869 (56 per cent.) and the Roman Catholics the least. Of the gross increase of population in Hungary between 1869 and 1880 no less than two-thirds are due to Budapest alone, which in the same interval rose from the twenty-third to the fifteenth place among the towns of Europe. About 2 per cent. of the population are supported by trade and industry; 2 per cent. are engaged in service, and 4 per cent. belong to the professional and official classes. Nearly 50 per cent., including women and children, are returned as belonging to the non-working class, but less than 1 per cent. are described as living on their capital property. In spite of the large proportion of one-storied houses, the ratio of inhabitants to each dwelling-house is somewhat high (33, as compared with 8 in London, 35 in Paris, and 59 in Vienna).

As Paris is sometimes said to be France, so may Pesth with almost greater truth be said to be Hungary. Its composite population is faithful reflexion of the heterogeneous elements in the empire of the Hapsburgs, and the trade and industry of Hungary are centred at Pesth in a way that can scarcely be affirmed of any other European capital. In virtue of its museum and academy it is also the scientific centre of Hungary, and nine-tenths of all books in the Magyar tongue are published here. The average rate per head of imperial taxation is five or six times as great in Pesth as in the rest of Hungary. The recent patriotic movement in favour of Magyarising all institutions has found its strongest development in Pesth, where the German names have all been removed from the streets and buildings. It is found, too, that the children of German parents born in Pesth easily become Magyarised, while a survey of Hungary at large during the last sixty years shows a relative increase of barely 1 per cent. in the Hungarian as opposed to the German tongue. The inhabitants are good-natured, hospitable, and fond of luxury and display. The upper classes are much addicted to sports of all kinds, and cultivate horse-racing, fox-hunting, and rowing with energy and success. Almost the only popular festival of importance is that of St Stephen on the 20th August, when thousands of people flock to inspect the relics of that saint in the palace-church of Buda.

*History.*—The origin of Pesth proper is obscure, but the name apparently derived from the old Slavonic "pestj," a stove (like Ofen, the German name of Buda), seems to point to an early Slavonic settlement. The Romans never gained a foothold on this side of the river, though Aquincum, on the site of old Buda, is believed from the extant remains, to have contained about 80,000 inhabitants. When it first appears in history Pesth was essentially a German settlement, and a chronicler of the 13th century describes it as "Villa Teutonica ditissima." Christianity was introduced early in the 11th century. In 1241 Pesth was destroyed by the Tatars, after whose departure in 1244 it was created a royal free



city by Bela IV., and re-peopled with colonists of various nationalities. The succeeding period seems to have been one of considerable prosperity, though Pesth was completely eclipsed by the sister-town of Buda with its fortress and palace. In 1526 Pesth was taken and pillaged by the Turks, and from 1541 to 1586 Buda was the seat of a Turkish pasha. Pesth in the meantime entirely lost its importance, and on the departure of the Turks was left little more than a heap of ruins. Its favourable situation and the renewal of former privileges helped it to revive, and in 1723 it became the seat of the highest Hungarian officials. Maria Theresa and Joseph II. did much to increase its importance, but the rapid growth which enabled it completely to outstrip Buda belongs entirely to the 19th century. A signal proof of its vitality was given in 1838 by the speed and ease with which it recovered from a disastrous inundation that destroyed 3000 houses. In 1848 Pesth became the seat of the revolutionary diet, but in the following year the insurgents had to retire before the Austrians under Windischgrätz. A little later the Austrians had to retire in their turn, leaving a garrison in the fortress of Buda, and, while the Hungarians endeavoured to capture this position, General Hentzi retaliated by bombarding Pesth, doing great damage to the town. The inhabitants to the number of 80,000 took refuge in the Stadtwaldchen. Between 1867 and 1878 Pesth is said to have doubled in size, and during the last four or five years the building activity has been little if at all inferior.

See Hüfner, "Budapest," *Historische Skizzen*, I. Abth. (1854); Hevel, *Budapest und seine Umgebungen* (1878); Sturm, *Kulturbilder aus Budapest* (Leipzig, 1876); Hekech, *Illustrirter Führer durch Budapest* (1885); Körösi, *Die Hauptstadt Budapest im Jahre 1881*; publications of the Statistical Bureau in Budapest. (J. F. M.)

PETAU, DKNYS (1583-1652), better known in some departments of literature under the Latin form of his name as DIONYSIUS PETAUVIUS, a highly-distinguished Catholic theologian and one of the most learned men of the 17th century, was born on 21st August 1583 at Orleans, where his father was a well-to-do merchant with some literary culture. Petau received his early education at Orleans, but finished his university course in Paris, where, after graduating in arts, he attended theological lectures at the Sorbonne. By Isaac Casaubon, who had perceived his abilities, he was introduced to the MS. treasures of the Bibliothèque Royale; and, at the suggestion of that scholar, he began to work for the edition of Synesius which he afterwards published. In 1603, before he had completed his twentieth year, he received a teaching appointment in the faculty of philosophy at the university of Bourges; here his leisure hours were devoted to his editorial labours and to a systematic study of the ancient philosophers and mathematicians. Having come under the influence of the learned Jesuit Fronton le Duc, he was induced to resign his post at Bourges in order that he might join the Society of Jesus, and in June 1605 he entered upon his novitiate at Nancy. After an interval of four years, he taught rhetoric successively at Rheims, La Flèche, and Paris, taking the four vows of the order at the last-named place in 1618; from 1621 to 1644 he was professor of positive theology in the college of the order. On account of growing infirmities and to secure leisure for his great work, to be mentioned below, he then retired from teaching duties, but retained the librarianship in the Collège de Clermont until his death, which took place on 11th December 1652.

The list of Petau's literary labours bears witness to an extraordinary and many-sided activity, and includes several works which still enjoy the recognition of scholars. He edited Synesius (1611, 2d ed. 1631, 3d ed. 1638), Themistius (1613), Julian (1630), the *Breviarium* of Nisephorus (1616), and Epiphanius (1622); his *Antimadaverstonus* on the last-named have been reprinted by Dindorf, as a still unexhausted mine of valuable material, in the 5th vol. of his *Epiphanius Opera* (1858). Carrying on and improving on the chronological labours of Scaliger, he published in two folio volumes an *Opus de doctrina temporum* (1627; frequently reprinted), followed in 1680 by *Uranologion s. cyclica variorum auctorum quæ de sphaera ac sideribus conuincunt motibus graeco commentati sunt et Variarum dissertationum ad Uranologion libri VIII.* Of the first-mentioned of these he made an abridgment, entitled *Rationariorum temporum*, which passed through numerous editions, was translated into English and French, and in a recent reprint has been brought down to the year 1849. In theology proper Petau's first appearance was polemical, and quite in the manner of that time,—a pseudonymous criticism on the recently-published com-

mentary of Salmasius on Tertullian's *De Pallo* (*Antoni Kerkoete Armerici antimadaverstonus liber*, 1622). The controversy was continued in a series of replies and rejoinders, and was renewed in connexion with other publications of his distinguished antagonist. In particular, some reference to the church doctrine as to the authority of bishops made by Salmasius in his *De fenore trumpetico* was the occasion of Petau's *Dissertationum ecclesiasticarum libri duo, in quibus de episcoporum dignitate et potestate deque alia ecclesiastica dogmatibus disputatur* (1641) and also of his *De ecclesiastica hierarchia libri V.* (1641). Petau also had his share in the Jansenist controversy, and has the honour of being twice mentioned as a Jesuit authority in the *Provinciales*. His first appearance in the dispute was against Arnauld's *De la fréquente communion*, which he met with a treatise, *De la penitence publique et de la preparation à la communion* (1648); his subsequent works, viewed in the light of the struggle then at its height, explain themselves by their titles (*De lege et gratia libri II.* (1648), *De Tridentinis concilii interpretatione et S. Augustini doctrina* (1649), *De adiutorio sine quo non ad futuram gloriam* (1651)). In his great but unfinished work, *De theologicis dogmatibus* (6 vols. fol., 1644-50), he deals with the doctrine of God, the Trinity, Creation, and the Incarnation; his design had been to complete it by an exhaustive treatment of the sacraments and of the Christian graces and virtues. Its scope, which was to free theology from the subtleties of scholasticism and to rest the science on the simple and firm basis of Scripture, the councils, and the fathers, is well enough explained by his own avowal, "nova quaerant alii, nil nisi prisca peto." The work is a treasury of well-digested learning, and justly entitles its author to the praise of Muratori, who speaks of him as "the restorer of dogmatic theology." By some of his fellow-Jesuits he was supposed to have been too ready to recognize the Jansenism of Augustine, and in various quarters his declaration that many of the ante-Nicene fathers were less orthodox than the decrees of the first council has been made a matter of reproach. But in these charges the impartial critic will recognize only proof of his candour. Petau, it may be added, was a rigid ascetic, and in particular is said to have indulged in the discipline of self-flagellation to a degree that injured his health.

PETER. Simon Peter was "an apostle of Jesus Christ" (1 Peter i. 1). His two names are both found in two forms: of the one the full form is Symeon (Συμεών, Συμεών, which is found in the speech of James, Acts xv. 14, and in most MSS. of 2 Peter i. 1), the shorter and more usual form being Simon; the other is found both in its Greek form Peter (Πέτρος) and in the Græcized form Cephas (Κηφᾶς) of the Aramaic Kepha (כֶּפֶה). Simon is the name by which he is always addressed by Jesus Christ; Peter is that by which he is most commonly spoken of in the Synoptic Gospels, the Acts of the Apostles, and subsequent ecclesiastical literature; the combined name, Simon Peter, is found once in St Matthew, once in St Luke, and frequently in St John; sometimes Peter is expressly stated to be a surname (Matt. iv. 18, x. 2; Acts x. 5, 18, 32, xi. 13); St Paul, in 1 Cor. and in Gal. i. 18, ii. 11, 14 (according to the chief uncial MSS., except D), uses Cephas, but in Gal. ii. 7, 8, he uses Peter.<sup>1</sup> The name of his father is also found in two forms, John (Ἰωάννης, Ἰωάνης, in most MSS. of John i. 42, xii. 15, 16) and Jonas (Ἰωάνης, Matt. xvi. 17, and cod. A in John). In John i. 44 he is said to have been of Bethsaida, which was possibly the place of his birth; but it appears from Mark i. 29 (= Matt. viii. 14; Luke iv. 38) that he and his brother Andrew had a house together at Capernaum. With the same brother, and with James and John as partners, he was engaged in what was probably the thriving business of a fisherman on the Lake of Genesaret; and from the fact that he went back to his business after the resurrection it has been inferred that, at least up to that time, he had never wholly left it. That he was married is clear from the mention of his wife's mother

<sup>1</sup> Throughout the New Testament the Peshito-Syriac uses Cephas where the Greek has Peter, and there is no reasonable doubt of the identity of the two names; but Clement of Alexandria, in a fragment preserved by Eusebius, *H. E.*, i. 12, 3, and the so-called "Two Ways" (Harnack, *Lehre der zwölf Apostel*, p. 225, and Hilgenfeld, *Nov. Test. critica Canonum receptum*, fasc. iv. p. 111) take them to refer to different persons, probably from an unwillingness to believe that Gal. ii. 11 really referred to Peter.

(Mark i. 30 and parallels), and that his wife accompanied him when he finally left his home to preach the gospel is implied by St Paul (1 Cor. ix. 5); there is an early tradition, which is not inconsistent with probability, that she also suffered martyrdom, and that Peter called out to her as she was being led away, "O wife, remember the Lord!"<sup>1</sup> The statement that he had children<sup>2</sup> is probably only an inference from the fact of his having been married; the alleged name of his daughter, Petronilla, is as suspicious as the story of his having cured her of the palsy<sup>3</sup>; and the majority of commentators take the expression "Mark, my son," in 1 Peter v. 13, to refer only to spiritual kinship.

Of the beginning of his discipleship there are two accounts which have sometimes (by Baur, Keim, Holtzmann, and others), though without sufficient reason, been supposed to be inconsistent with each other.

(1) According to St John, he was brought to Jesus by his brother Andrew, who had been a follower of John the Baptist, but who, after the Baptist's testimony, recognized in Jesus the promised Messiah (John i. 40-42). The fact that he was then not at Capernaum but in the Jordan valley, where John was baptizing, seems to indicate that he, like his brother, had been attracted by John's preaching. It is not stated that he at once became one of those who followed Jesus, and there is consequently room for the supposition that he returned home; and the statement that it was upon the occasion of this first meeting that he received his distinctive surname, Cephas or Peter, is not inconsistent with Mark iii. 16, Luke vi. 14, which mention the fact rather than the occasion, or with Matthew xvi. 18, which gives to an existing name a new application.

(2) According to St Matthew and St Mark, it was at the beginning of the Galilean ministry that Jesus called Simon and Andrew to become "fishers of men" (Matt. iv. 18-20; Mark i. 16-18). The manner of the call seems to imply a previous acquaintance, and is consequently not out of harmony with that of St John. It is less easy to determine whether the account in Luke v. 1-11 refers to the same or to a different incident; Schleiermacher, Neander, Bleek, and others treat it as the fuller and more accurate account, Ewald, Weiss, Keim, and others regard the miraculous draught of fishes as a reminiscence of a later tradition, and probably identical with John xxi. 5-11.

From the time of his call Peter has a place in most of the important events of the Gospel narrative. It was to his house in Capernaum that Jesus went as if to a home (Matt. viii. 14; Mark i. 14, 33; Luke iv. 38), and it is consequently sometimes spoken of as simply "the house" (Matt. ix. 28, xiii. 1, 36, xvii. 25). He formed, with his two former partners, James and John, an apostolic triumvirate, which was admitted when all others were excluded, and to whom, with Andrew, was committed the great prophecy of the last days (Mark xiii. 3). The most important incident which is recorded of him between his call and the crucifixion is that which happened at Caesarea Philippi (Matt. xvi. 13-23; Mark viii. 27-33; Luke ix. 18-22; probably recorded in substance, though in a different form, in John vi. 66-69). The incident links itself closely with the history which had immediately preceded it. The expectation which the Galilean peasantry had begun to form of Jesus had been disappointed; the miracles of healing and feeding had not been followed by the assumption of the national leadership; many of the disciples had begun to drift away, and those who were looking for the Messiah saw in Him only "one of the prophets." Those who

remained were tested by a direct question; whether the form of the question was that of the Synoptists, "Whom say ye that I am?" or that of St John, "Will ye also go away?" it was Peter who answered for the rest, in words which have an equivalent meaning, whether they were in the form "Thou art the Christ," or in the form "Lord, to whom shall we go? Thou hast the words of eternal life." The further detail which St Matthew gives, xvi. 17-19, has sometimes been thought to be a later addition, reflecting a fact of subsequent ecclesiastical history; but its absence from St Mark does not seem to be an adequate ground for rejecting it, and its substance is found in Justin Martyr (*Tryph.*, c. 100). Round the words which St Matthew records many controversies have raged; nor does it seem possible, with existing means of investigation, to fix to the sentence "upon this rock I will build My church" a meaning that will be beyond dispute. Whatever may be its precise meaning, it seems at any rate to be in harmony with other passages of the Synoptic Gospels, which indicate, not only that Peter was foremost among the apostles by virtue of natural force of character, but that he was also their ordinary leader and representative: the most important passage is Matt. x. 2, where the expression "the first," which is applied to him, cannot be restricted to mere priority of enumeration in the list. It is possible that his colleagues James and John, or their more ambitious mother, endeavoured to dispute this position with him (Matt. xx. 20, 21; Mark x. 35-37), and it has been contended (Baur, Strauss, Holtzmann) that in the Fourth Gospel John holds the place which the Synoptists assign to Peter; but even if this contention were admitted it would merely afford one more argument to show that the priority of rank was limited by natural affection as well as by the law of equality among the Christian brotherhood (Matt. xxiii. 8-11; Mark ix. 33-35; Luke xxiii. 24-27). But, although Peter was foremost in expressing the confident belief of the disciples that Jesus was the Messiah, it seems clear that in his conception of the Messiah he did not rise above the current ideas of his countrymen. "He that should come" was to be a national deliverer. This conception appears on two occasions especially—when Jesus first told the disciples of His coming sufferings, "Peter took Him and began to rebuke Him," and received the answer, "Get thee behind Me, Satan," as though this attitude of the disciples were a new temptation (Matt. xvi. 21-23; Mark viii. 31-33); and, when Jesus was actually in the power of His enemies, and no "legions of angels" appeared either to rescue or to enthroned Him, Peter's natural hopefulness gave way to complete despondency, and he more than once "denied that he knew Him."

In the earliest account of the resurrection (that of St Paul, 1 Cor. xv. 5) it is mentioned that Jesus appeared to Peter before and separately from the twelve; and the last chapter of the Fourth Gospel gives him an especial prominence: it adds one more example of the impulsive energy of his character (ver. 7); it portrays more vividly than any other passage in the Gospels the depth of his attachment to his Master (vers. 15-17); and it forecasts the manner of his death (vers. 18, 19). His prominence in the early community at Jerusalem is proved by the testimony of St Paul; for it was to visit "Cephas" that he made his first journey to Jerusalem after his conversion, and fourteen years afterwards, though James and John as well as Cephas "were reputed to be pillars," it was the latter who stood out above the rest as the special preacher of "the gospel of the uncircumcision" (Gal. i. 18, ii. 1-10). These facts undoubtedly confirm the general picture of the relations of Peter to the early church which is drawn in the Acts of the Apostles; at the same time no part of the New Testament has been more strongly attacked by modern

<sup>1</sup> Clem. Alex., *Strom.*, vii. 10, p. 869, quoted by Eusebius, *H. E.*, iii. 30, 2.

<sup>2</sup> Clem. Alex., *Strom.*, iii. 6, p. 535, quoted by Eusebius, *ibid.*

<sup>3</sup> St Augustine, *a. Adamant. Manich.*, c. 17, vol. viii. 139, ed. Ben.

writers than the first twelve chapters of that book, in which the "Acts of Peter" are contained. The attack has been made (Baur, Schwieger, Overbeck, Zeller, and others) partly on the speeches and partly on the narrative. (1) It is alleged that the Petrine speeches form no exception to the general uniformity of phraseology and style which characterizes the Acts, and that they ignore the marked differences in the conception of Christianity between Peter and Paul. It must be admitted that the coincidences are such as to render it probable that the author of the Acts dealt freely with his materials, but at the same time the peculiarities are sufficiently numerous to support the view that these speeches contain a true representation of the primitive teaching.<sup>1</sup> (2) The narrative passages which have been most keenly contested are those which relate to Simon of Samaria and to Cornelius. It is alleged that the account of the former is the mere reflex of the later legends in which the name of Simon Magnus was substituted for that of St Paul as the representative of false Christianity, and it is said of the latter that it is a mere attempt to claim for Peter the opening of the door to the Gentiles which was the special honour of Paul, and that it cannot be reconciled with the division of labour between the apostle of the circumcision and the apostle of the uncircumcision which is spoken of in the Epistle to the Galatians.<sup>2</sup> At the great crisis of early Christianity which is known as the conference or council of Jerusalem Peter advocated (according to the Acts), or accepted (according to Paul), the policy of conciliation. Afterwards he went to Antioch, where Paul had preceded him, and there he carried out his acceptance of Gentile Christianity to the further point of eating at the common meals at which Gentiles were present. For this step the members of the original community at Jerusalem were not prepared; and, when a deputation from them came to Antioch, Peter "drew back and separated himself" (Gal. ii. 12). Thereupon followed an argument and a remonstrance on the part of Paul which has been fruitful of results to both ancient and modern Christianity. Peter was "withstood to the face" because of (1) inconsistency, (2) practical calumny of Christ, (3) transgression of the law, (4) making void the gift of God (Gal. ii. 14-21). It is altogether too much to assume that this remonstrance led to a permanent alienation of the two apostles from one another; it is more probable that with a character such as Peter's, which had more energy than steadiness of resolution, it may even have been effectual. But it is upon the assumption of such an alienation that the Jewish party in the ancient church pictured Peter as the champion and hero of the faith, and Paul as its vanquished opponent, and also that in modern times the Tübingen school have endeavoured to reconstruct not only early church history but also the New Testament. This incident at Antioch is the last that is certainly known of Peter. The prophecy recorded in John xxi. 18, 19, is in harmony with early tradition in pointing to a violent death. But of the time and place of that death we know nothing with even approximate probability. The only historical mention of him for more than a hundred years afterwards is in Clement of Rome (*Ep.*, i. 5, 4), who sets before the Corinthians the example of "Peter, who through zeal undertook not one or two but numerous labours, and so having borne witness went to the place

that was due to him." It is sometimes supposed that an indication of the place in which he "bore witness" or "suffered martyrdom" is afforded by the phrase "among us," i.e., among the Romans, in the next chapter; but this, though possible, is quite uncertain. Outside this statement, which if it were more definite would be conclusive, there is only the doubtful interpretation of "Babylon" in 1 Peter v. 13 as meaning "Rome," and the echo of a vague tradition in the apocryphal *Petri et Pauli Predicatio*.<sup>3</sup> The testimony of the "presbyter" who is quoted by Papias in reference to Peter's connexion with Mark (Euseb., *H. E.*, iii. 39, 15) says nothing of the place at which they were together, and the coupling of the names of Peter and Paul by Ignatius (*Ad Roman.*, c. 4) would not, even if the early date of Ignatius were established, afford a solid argument that "in their death they were not divided." But from the beginning of the last quarter of the 2d century the testimony to the presence and death of Peter at Rome is almost uniform; the tradition, whatever may have been its foundation in fact, had firmly established itself. Dionysius of Corinth (Euseb., *H. E.*, ii. 25, 8) says that Peter and Paul founded the church at Corinth together and then proceeded to Italy. Irenæus (*Adv. Hæres.*, iii. 1) speaks of Peter and Paul as having together founded the church at Rome; the Muratorian Fragment (not earlier than the end of the 2d century) refers to the "passion of Peter" i.e., his martyrdom; the presbyter Gaius (Euseb., *H. E.*, ii. 25, 7, early in the 3d century) says that he saw the *τοποία* (whatever that may mean) of the two apostles Peter and Paul at Rome; in Tertullian (*e.g.*, *Scorp.*, c. 15; *De Præscr.*, c. 24 and 36) the tradition is fairly established; and no later Latin father expresses any doubt of it.

But, besides the fact that there is an interval of more than a hundred years between what must have been, in the ordinary course of nature even if not through violence, the approximate time of Peter's death and the first certain tradition of the place and manner of it, there are two other important considerations which render the ordinary patristic statements doubtful. (1) One stream of tradition, for the existence of which it is difficult to account if the other tradition had been uniform, represents Peter as having worked at Antioch, in Asia Minor, in Babylonia, and in the "country of the barbarians" on the northern shores of the Black Sea. This is in harmony with the geographical details of the first of the two epistles which bear his name. That epistle is addressed to the "elect who are sojourners of the dispersion in Pontus, Galatia, Cappadocia, Asia, and Bithynia," and the "Babylon" from which it is obviously written (v. 13) is best understood not as a cryptographic expression for Rome, but, like the other geographical names of the epistles of the New Testament, in a literal sense. All this, no doubt, is not inconsistent with the supposition that Peter went to Rome towards the end of his life, but it seems to exclude the theory that he made a lengthened stay there and was the founder of the Roman Church. (2) The other consideration is that the presence of Peter at Rome is almost inextricably bound up with a story of whose legendary character there can be little doubt, that of the Simon Magus of the *Clementines*.<sup>4</sup> Under the name of Simon Magnus the conservative Jewish Christians, who could never forgive the admission of the Gentiles to be "fellow-heirs" with the "children of the promise," seem to have represented Paul<sup>5</sup>; and, throwing

<sup>1</sup> The question of the relation of their language to the rest of the Acts and to the Petrine epistles is discussed in detail with various results by several writers, *e.g.*, Mayerhoff and Weiss in the works mentioned below, and more fully Kähler in *Studien u. Kritiken* for 1873, p. 492 *sq.*

<sup>2</sup> The details of the discussion will be found in most recent books which deal with the Acts; on the negative side the most convenient book for English readers is the translation of Zeller's *Contents and Origin of the Acts of the Apostles*, 1875.

<sup>3</sup> Hilgenfeld, *Nov. Test. extra Can. rec.*, fasc. iv. p. 57.

<sup>4</sup> Uhlhorn, *Die Homilien u. Recognitionen des Clemens Romanus*, Göttingen, 1852, makes an unsuccessful attempt to show that the two stories may be separated.

<sup>5</sup> For the detailed proof of this reference may be made to Baur, *Church History*, E. T., vol. i. p. 91; Zeller, *The Acts of the Apostles*, E. T., vol. i. p. 250; and Hilgenfeld, in his *Zeitschrift f. wissenschaftl. Theologie*, 1868, p. 367.

back into the 1st century, and into the personal relations between the two apostles, the violent controversies between the catholic and the Jewish parties which came to a head in the 2d century, they framed a romance of which Peter was the hero, and in which, under the mask of Simon Magus, Paul played the part of the "false apostle." The romance in its original form has perished; its substance is partly preserved and partly recast in the Clementine *Homilies* and *Recognitions*, of which the former exist in their original Greek, the latter in an incomplete Latin translation. In course of time the original identity of Paul with Simon Magus was forgotten, and in the later forms of the legend (see the *Acts of Peter and Paul* below) Peter and Paul are joined together in the combat with the pretender. But in almost all later patristic accounts of Peter Simon Magus has an important place; he is said to have gone to Rome in the time of Claudius, and Peter is said to have at once followed him in 42 A.D.; hence, as Peter lived until the Neronian persecution in 67 there was room for an episcopate of twenty-five years. This last tradition can hardly be reconciled with the facts mentioned in the New Testament of his presence at Jerusalem and at Antioch (Acts xv.; Gal. ii.); but Lipsius has endeavoured to show, not only that single points in the story must be given up, but that the whole tradition of the presence of Peter at Rome is a fiction which grew out of the Judæo-Christian attack upon Paul.

The probabilities of the case are evenly balanced; on the one hand it is difficult to account for the complete silence as to Peter in the Pauline epistles, and it is impossible with those epistles in sight to regard Peter as the founder of the Roman community; on the other hand, it is difficult to suppose that so large a body of tradition had no foundation in fact; such a supposition, besides its general improbability, would assume that the extreme form of Judæo-Christianity which the *Clementines* reflect had a much greater influence over the conceptions of the 2d century than the evidence warrants.<sup>1</sup>

<sup>1</sup> The question whether Peter was ever at Rome has been so much discussed that the following list of the chief treatises and articles on either side will be convenient for reference; it is not exhaustive. The question was at first discussed as one between Protestants and Catholics. The earliest treatise on the Protestant side is probably that of Ulrich Vehlen (Velenus) in his *Demonstratio contra Romani papæ primatus auctoritatem*, 1520, reprinted by M. Fiacius Illyricus in his *Refutatio insectans Bruni contra curtusæ historicæ ecclesiasticæ*, p. 86; it was answered at the time by Bishop Fisher of Rochester in his *Consilio calumniarum Aldrichi Veleni*, reprinted in his works, ed. Würzburg, 1597, p. 1299. The most complete account of the older arguments on the Lutheran side is that of Spanheim, *Dissertatio de Acta profectioe Patri Apostoli in urbem Romanam depus non una traditionis origine*, 1679, reprinted in his works, Leyden ed., 1708, vol. ii. p. 331. In modern times the question has been discussed chiefly on literary grounds and without reference to its bearing on the Roman controversy. It was first stated on the negative side by Baur in the *Tübinger Zeitschrift für Theologie*, 1831, p. 136, and in his *Paulus*, E. T., vol. i. p. 228. His most important follower has been Lipsius, whose two works, the *Chronologie der römischen Bischöfe*, Kiel, 1859, and *Die Quellen der römischen Petrus-Sage*, Kiel, 1873, are of great value apart from the results which they endeavour to establish; he also deals with the question more concisely in the *Jahrb. f. deutsche Theol.*, 1876, p. 561. On the same side are Mayerhoff, *Historisch-kritische Einleitung in die petrinischen Schriften*, Hamburg, 1836; Gundert, in the *Jahrb. f. deutsche Theol.*, 1869, p. 306; Holtzman, s.v. "Petrus," in Schenkel's *Bibliotheca*; Hausrath, *NTliche Zeitgeschichte*, vol. iii. p. 344; Zeller, in the *Deutsche Rundschau*, 1875, p. 215 (reprinted in his *Vorträge u. Abhandlungen*, 2te Samml., 1877), and in the *Z. f. wissenschaftl. Theol.*, 1876, p. 31. "The truth of the early tradition has been maintained in opposition to these writers by Credner, *Einleitung in das N. T.*, 1836, p. 628; Olshausen, *Römerbr.*, 1840, p. 40; Wissler, *Chronologie des apost. Zeitalters*, 1848, p. 552; Ewald, *Gesch. des Volkes Israel*, vol. vi. p. 616; Hilgenfeld, in his *Z. f. wissenschaftl. Theol.*, 1872, p. 373, 1876 p. 57 (in answer to the article of Zeller in the same number mentioned above), 1877 p. 486 (in answer to the article of Lipsius mentioned above); Deltmich, in *Stud. und Krit.*, 1874, p. 213; Reman, *E' Antechrist*, p. 166, and appendix; Boyce, in *Entdeckung*

It would be inappropriate to enter in the present article into the causes and consequences of the enormous influence which the belief that Peter founded and presided over the first Christian community at Rome has exercised upon Christianity. It was no doubt natural, considering that influence, that curiosity should be largely exercised as to the details of his life and death at Rome, and that legends of respectable antiquity should express themselves in visible memorials. Modern Rome contains many such memorials. The chapel of S. Pietro in Carcere preserves the tradition that he was imprisoned in the Tullianum, and that a spring of water issued from the ground that he might baptise his gaolers. The churches of S. Prassede and S. Pudenziana preserve the tradition that much of the later part of his life at Rome was spent in the house of Pudens on the Viminal Hill. The latest localization of a legend has built a church outside the old Porta Capena to mark the spot where, when he was fleeing from persecution, he met his Master going into Rome. "Lord, whither goest Thou?" (Domine, quo vadis!) was his question. "I go to Rome to be crucified again" was his Master's answer.<sup>2</sup> Besides these visible memorials of Petrine legends there are four annual feasts. (1) On 29th June is celebrated the Feast of St Peter and St Paul. The day is supposed to be that of their martyrdom; it is in reality that of the reburial of their supposed remains in 258, which is recorded in the *Kalendarium Liberianum* of 354 (printed by Mommsen in the *Abhandlungen der königl. sächs. Gesellschaft, phil.-hist. Classe*, 1850, p. 362). That of Peter were then reburied: "ad catacumbas," &c., in the cemetery of St Sebastian on the Appian Way; they were afterwards said to have been transferred to the basilica which Constantine erected on the Vatican. (2) On 22d February is celebrated a feast in commemoration of Peter as bishop of Antioch (*Festum Cathedrae Petri Antiochenæ*), which also is mentioned as early as the *Kalendarium Liberianum*. (3) On 18th January has been celebrated since the 8th century a feast in commemoration of his bishopric of Rome. (4) On 1st August has been celebrated since the 9th century a feast in commemoration of his imprisonment (*Festum S. Petri ad Vincula*), but whether of that by Herod which is mentioned in Acts xii. 6 of that by Nero, is uncertain.

Besides the two canonical epistles (see PETER, EPISTLES) of the following works have either been (erroneously) attributed to him or bear closely upon his history.

1. *The Gospel according to Peter*.—Eusebius (*H. E.*, vi. 12, 2f) mentions that the public use of this Gospel was at one time allowed, but afterwards disallowed on the ground of its Docetism, by Serapion, the successor of Theophilus in the bishopric of Antioch (191-213). It is mentioned by Origen (*Hom. in Matt.*, x. 17, vol. iii. p. 463), by Jerome (*De Vir. Illust.*, c. 1), and by Theodor (*Harv. Fab.*, ii. 2). Hilgenfeld (*Nov. Test. extra canon. rec.*, fasc. iv. p. 39) thinks that it held a middle place between the *Gospel according to the Hebrews* and the *Gospel of the Ebionites*. No certain fragments of it remain.

2. *The Preaching of Peter* (*Πῆρου κήρυγμα*); and

3. *The Journeys of Peter* (*Πῆρου περιόδοι*).—These two works are mentioned together in the *Epistle to James* which is prefixed to the Clementine *Recognitions*; the former appears to have been Judæo-Christian; the latter was an attack on Paul under the guise of Simon Magus. Both works underlie the Clementine *Recognitions* and *Homilies*; the patristic references to them will be found in Hilgenfeld, *l. c.*, p. 52, and *Einleitung*, pp. 42, 155, 580, 613.

4. *The Preaching of Peter and Paul*.—This, in distinction from the preceding, belongs to the period at which Pauline and Petrine tendencies had become combined. The fragments of it and references to it are collected by Hilgenfeld, *l. c.*, p. 56.

5. *The Acts of Peter and Paul*.—The history of this work is obscure; in its present form (as printed by Tischendorf, *Acta Apostolorum Apocrypha*, pp. 1-39) it is probably a late recasting of an earlier work or works. Of such earlier work or works there are traces which are collected by Hilgenfeld, *l. c.*, p. 66; in addition to these it has been thought that the *Martyrium Petri et Pauli* of Symeon Metaphrastes contains part of the original *Acts of Peter*; but the section of the great work of Lipsius, *Die apok. Apostolgesch. u. Apostolleg.*, which will probably unravel the present literary difficulties of these *Acts* has not yet (1884) appeared.

6. *The Apocalypses of Peter*.—This is mentioned as a deuterocanonical book in the Muratorian Fragment, by Clement of Alexandria (ap. Euseb., *H. E.*, vi. 14, 1), and by Eusebius (*H. E.*, iii. 25, 4). Methodius of Tyre placed it "among the inspired Scriptures" (*Sympos.*, ii. 6), and Sozomen (*H. E.*, vii. 19) says that in some churches of Palestine it was publicly read once a year. A few short

and *erste Schickale der Christengemeinde zu Rom*, 1874, p. 51; Schmid, *Petrus in Rom*, Lucerne, 1879 (which is a convenient summary of earlier literature and arguments rather than an independent contribution to the subject); Langen, *Geschichte der römischen Kirche*, 1851, p. 40; Sieffert, in Herzog-Plitt, *R. E.*, s.v. "Petrus."

<sup>2</sup> The story is first found in a sermon sometimes attributed to St Ambrose and printed in some editions of his works, e.g., ed. Paris, 1608, vol. v. p. 100.

fragments of it are collected by Grabe, *Spiell.*, i. 74, and by Hilgenfeld, *l.c.*, p. 71. (The work under the same title which was partly translated by Jacobus de Vitriaco in the 13th century, and of which there was MSS. still remain, *e.g.*, an Arabic translation in the Bodleian Library—*MSS. Arab. Christ.*, xlviii.—is a much later composition.)

7. *Epistle of Peter to James*.—This is prefixed to the Clementine *Homilies* (ed. Lagarde, p. 1); according to Photius (*Biblioth.*, cod. 43, 118) there was a similar letter, which is now lost, prefixed to the *Recognitions*. Its character and literary value are the same as those of the *Clementines* in general.

8. *The Teaching of Simon Cephas in Rome*.—This treatise exists in Syriac, and was first published and translated by Cureton, *Ancient Syriac Documents*, 1864, p. 85 (since by E. P. Pratten, in the Antislonean Library, vol. xx.). (A. H.A.)

**PETER, EPISTLES OF.** 1 *Peter*.—The first of the two canonical epistles which bear the name of St Peter is addressed "to the elect who are sojourners of the dispersion in Pontus, Galatia, Cappadocia, Asia, and Bithynia." Most commentators in both ancient and modern times (*e.g.*, of the former, Athanasius, Jerome, Epiphanius; of the latter, Lange, Weiss, and Beyschlag) have interpreted this phrase to refer primarily to Jewish Christians. But this interpretation creates a difficulty. The countries named were countries in which St Paul and his companions had been especially active, and in which they had formed many communities, chiefly from the Gentile population. If therefore "the sojourners of the dispersion" be understood to refer to Jews, it becomes necessary to suppose the existence side by side in the same countries of two sets of communities, Pauline and Petrine, and further to suppose either (with Weiss) that the latter were already in existence when Paul preached, or (with the majority of writers) that Peter followed Paul upon his own ground. Both these suppositions are improbable, and it is preferable to understand the phrase of the "children of God that are scattered abroad" whether Jews or Gentiles. That some of the latter were included in it seems clear from i. 21, ii. 10, which imply that before they were Christians they knew not God, and from iii. 6, which implies that their wives had only now become daughters of Abraham.

The epistle was evidently written at a time when the Christians of Asia Minor were both calumniated (ii. 12, iii. 16, iv. 4, 14) and persecuted (i. 6, 7, iii. 14-17, iv. 12-19). It exhorts those to whom it was addressed not only to bear their trials patiently, and even to rejoice inasmuch as they were "partakers of the sufferings of Christ" (iv. 13), but also to give no occasion to the hostile world which surrounded them to reproach them as evildoers (ii. 12, 15, iv. 14, 16), and it specializes this exhortation to well-doing by addressing separately servants (ii. 18-25), wives (iii. 1-6), and husbands (iii. 7). This fact that Christianity had come to be persecuted, and also the fact, which is manifested in its whole tone, that Christians were in danger of retrograding, show that the epistle cannot be placed in the earlier part of the apostolic age. The time of the Neronian persecution is the earliest that will satisfy the required conditions; and some (*e.g.*, Schwegler, Baur, Hilgenfeld) have thought that even this is too early for those conditions, and that it must be referred to the time of Trajan. It may, however, be said in reference to this latter view that the words of Tacitus in regard to the Christians under Nero, if they be not merely a reflexion from his own time, exactly suit the circumstances to which this epistle refers; "quos per flagitia vestros vulgus Christianos appellabat" (*Ann.*, xv. 44).

Like most documents of the apostolic age, it deals less with doctrine than with practice. But, though the doctrine is incidental, it is clear; taken in connexion with the Petrine speeches in the Acts of the Apostles, with which it is on the whole in harmony, it probably gives a faithful transcript of the original apostolic teaching. The Messiah

of whom the prophets had spoken had been revealed (i. 10-12); He had come to suffer (i. 11) for sins (ii. 24, iii. 18), and by His sufferings He had rescued the elect from their former evil life (i. 18-20) and brought them to God (iii. 18), and in His conduct under suffering left an example for them to follow (ii. 21-23). Belief in God who raised Him from the dead on the one hand is a purification of the soul and an obedience to the truth, and on the other it results in love of the brethren (i. 22); it constitutes a bond of brotherhood, like that which had existed between the children of Abraham, and made the elect, what the Jews had failed to be, "a royal priesthood, a holy nation" (ii. 9, from Exod. xix. 6). But the fulfilment of the promise is not for this world; Christians are "strangers and travellers" (ii. 11); the end of all things is at hand (iv. 7), and that is the revelation of the glory of the Messiah in which those who believe in Him will be partakers (iv. 13, v. 1).

The picture of the Christian communities which the epistle presents is of the simplest, and is in entire harmony with the general facts of the apostolic and sub-apostolic age. The organization was that of the Jewish synedria; the "elders" were as shepherds of the flock, exercising over the younger members the control of a simple discipline. The ministering to the wants of those who needed help was the common and personal duty of all who had wherewith to minister (iv. 10), and a special class of officers for the purpose was not yet needed. It is evident that "liberty of prophesying" prevailed; the only injunction on the point is, "if any man speak, let him speak as the oracles of God" (iv. 11).

The coincidences of thought and expression between some passages of this epistle and some passages in the epistle of James and in both the disputed and undisputed epistles of St Paul have given rise to much discussion. The chief coincidences are the following:—(1) between 1 Peter and James, i. 6, 7, and i. 2, 3, i. 12 and i. 25, i. 22 and iv. 8, ii. 1 and i. 21, iv. 8 and v. 20, v. 5, 9, and iv. 6, 7, v. 6 and iv. 10; (2) between 1 Peter and Romans, i. 14 and xii. 2, ii. 5 and xii. 1, ii. 6-10 and ix. 22, ii. 18 and xiii. 1, iii. 9 and xii. 17, iii. 22 and viii. 34, iv. 3, 7, and xiii. 11, 12, iv. 9 and xiii. 13, iv. 10 and xii. 6; (3) between 1 Peter and Ephesians, i. 1 *sq.* and i. 3 *sq.*, i. 14 and ii. 3, ii. 18 and vi. 5, iii. 1 and v. 22, iii. 22 and i. 20, v. 5 and v. 21. Of these coincidences several explanations have been given. Weiss (*Die patristische Lehrbegriffe*, 1856, and *Biblical Theology of the New Testament*, E. T., vol. i. p. 167) holds that this epistle preceded the other epistles and gave rise to the expressions which they contain. The Tübingen school hold that the contrary is the case, and that it represents either a late and weakened form of Paulinism (Baur, Zeller, Pfleiderer), or an attempt to mediate between the Pauline and Petrine parties by clothing the doctrines of the latter in the phraseology of the former (Schwegler). Others (notably Mayerhoff, *Einstellung in die petr. Schriften*, 1885) consider that there is no copying on either the one side or the other, but that all the coincidences of expression come from a common stock of apostolic teaching.

The epistle was used by Papias and is possibly referred to by Polycarp, and it is expressly quoted by Irenæus and Tertullian; it is not mentioned in the Muratorian Fragment, but it is translated in the Peshito version, and is included by Eusebius among the admitted books (*homologoumena*). Its genuineness was generally admitted until the present century; and some of its peculiarities have been accounted for by the hypothesis of its having been originally written in Aramaic, and translated, or possibly amplified, by Mark or Silvanus. On the other hand there are some who hold that the attacks upon it by Schwegler, Baur, Pfleiderer, Holtmann, and others have been stronger than the defence of it.

2 *Peter*.—The second epistle is addressed to a wider circle than the first, *i.e.*, to Christians in general. Its aim is mainly polemical; it is directed partly against a tendency towards libertinism, which was growing up and which took for one of its supports the Pauline doctrine of Christian freedom (ii. 1, iii. 16), and partly against the reaction which had set in against the earlier eschatology (iii. 3, 4). It protests in powerful language against the separation of Christianity from holy living, maintaining that Christianity without holy living is worse than no Christianity at

all (c. ii.); and it reasserts the reality of the Second Coming, resting it upon the reality of the supernatural evidence of the First Coming (l. 16-18).

The correspondence between this epistle, especially c. ii., and that of Jude is too strong to be a mere coincidence. It was at one time supposed to be the original which Jude imitated (so Semler and Michaelis, and more recently Luthardt and Hofmann), but the preponderance of opinion in modern times is in favour of the opposite view (not only by those who question the authenticity of this epistle but by some also of those who maintain it, e.g., Weiss). A leading argument in favour of the latter hypothesis is that 2 Peter ii. 13-17 is an amplification (and some maintain also a misapplication) of Jude 11, 12, and that 2 Peter ii. 11 requires Jude 9 for its explanation. An equally well-marked correspondence has recently been pointed out between this epistle and Josephus, and the balance of probability is in favour of the priority of the latter.<sup>1</sup>

The differences of style which distinguish the second from the first epistle have been noted since the time of Jerome (*De Vir. Illustr.*, c. 1, and *Epist. ad Hedib.*, c. 11). They are sometimes explained on the ground of the epistles having had different purposes, or having been written at different times; they are more commonly used as indications of a difference of authorship; and, although the argument from differences of style in comparatively short documents cannot be held to be decisive where the external evidence in their favour is strong, such is not the case with this epistle. The external evidence for it is singularly weak; there are no certain traces of it earlier than the 3d century, when Origen (ap. Euseb., *H. E.*, vi. 25), who is the first to mention it, also mentions that it was questioned. It is not included in either the Muratorian Fragment or the Peshito-Syriac (though it is in the later Philoxenian). Eusebius (*H. E.*, iii. 3) ranks it among the disputed books (*antilegomena*), and Jerome, although he included it in his translation (which fact probably accounts for its general acceptance in the Western churches), mentions that many rejected it. These doubts of early writers, which were revived by Erasmus and Calvin, have been shared by a large proportion of those who have written on the book in modern times; at the same time it cannot be said that there is a consensus of opinion against it.

The best editions of both the epistles are those in the commentaries of De Wette and Meyer, as revised the former by Brückner and the latter by Huther (this has been translated, with the rest of Meyer's Commentary, into English); there is a convenient short English commentary by Dean Plumptre in the *Cambridge Bible for Schools*. For the doctrinal and other questions which arise out of the two epistles reference may be made, in addition to the works mentioned in the course of the article, to Weiss, "Die petrinsche Frage," in *Stud. u. Krit.*, 1865, p. 619; Grimm, "Das Problem d. ersten Petrusbr." *Ibid.*, 1872, p. 657; Schmid, *New Testament Theology*, translated in Clark's Foreign Theological Library; Meuser, *Die Lehre der Apostel*, 1856; Farrar, *Early Days of Christianity*, vol. i. pp. 121, 174; and Siefert, a. v. "Petrus," in Herzog-Plitt's *Real-Encyclopädie*, 2d ed. vol. xi. (E. H. A.)

PETER OF BLOIS, otherwise known as PETERUS BLESSENSIS, a writer of the 12th century, was born at Blois in France about the year 1120. He studied theology at Paris, where one of his teachers was John of Salisbury, who exercised a considerable influence over him; he afterwards resided for some time as a student of law at Bologna. He was then appointed preceptor to William II. of Sicily, and in 1167 made keeper of the privy seal (sigillifer); political occurrences, however, compelled his return in the following year to France, whence he was invited into England by Henry II., who made him his private secretary. About 1176 he withdrew from court and entered the household of Richard, archbishop of Canterbury, whose chancellor he became.

This office he also held under Baldwin, Richard's successor, by whom he was sent to Rome in 1187 to support his cause in the controversy with the monks of Canterbury. Peter died about 1200.

His writings, which cover all the fields of intellectual activity then accessible, show him to have been one of the most widely and deeply learned men of his age. They include a number of allegorizing sermons and edifying tracts, a hortatory address, *De Jerusalemiana peregrinatione acceleranda*, a discourse *Contra perfidiam Judaeorum*, and, most interesting for its bearing on the political and ecclesiastical history of his time, a collection of 183 letters to Henry II., as well as to various popes, prelates, and scholars, including his old master John of Salisbury. The best edition of his works is that of Pierre de Goussainville, Paris, 1667, fol.

PETER THE HERMIT, the apostle of the first crusade, was born of good family, it is supposed, in the diocese of Amiens about the year 1050. His early history is obscure, but he appears to have seen some military service under the counts of Boulogne before his withdrawal from the world as a hermit. His crusading zeal originated in a pilgrimage he made to the Holy Sepulchre shortly before 1094, in which year he began to preach in the transalpine countries the immediate deliverance of Jerusalem from the infidel (see CRUSADES, vol. vi. p. 623 sq.). After the failure of the expedition headed by him in 1096, he founded and became first prior of the abbey of Neumoustier at Huy in the diocese of Liège, where he died on 7th July 1115.

PETER I., ALKXKIEVICH, surnamed THE GREAT (1672-1725), czar of Russia, was born at Moscow on 11th June 1672. His mother, Natalia Nariakhina, was the second wife of the czar Alexia. He was taught reading and writing, and the limited range of subjects which then constituted education in Russia, by the deacon Nikita Zotoff. He came to the throne in the year 1682, on the death of his elder brother Feodore; there was another brother, Ivan, who was six years his senior, but he was weak both in body and mind. Feodore therefore had wished Peter to succeed him, but Sophia, his sister, a woman of strong character and great ambition, was desirous that Ivan should rule, so that she might be proclaimed regent and in reality exercise the sovereignty. She therefore fomented a revolt of the "streltzi," or native militia, and the result was a compromise, whereby Ivan and Peter were to reign jointly. On the death of Ivan in 1696 Peter became sole ruler, and punished Sophia by incarcerating her for life in the Devichi monastery, where she died in 1704.

With the aid of Lefort, a Swiss adventurer, and other foreigners, Peter commenced his remarkable reforms, for which see RUSSIA. Here nothing more than a brief summary of the leading events of his life is given. In the year 1696 he besieged and took Asoff, his great object being to give Russia a seaboard. In 1697 he made his first Continental tour, on which occasion he worked at the dockyards of Zaandam and Deptford. On leaving England he took with him many ingenious men who wished to try their fortunes in a new country,—among them Perry the engineer, who has left us an interesting account of Russia at that time. From England Peter went to Vienna, where he studied the tactics of the imperial army, then enjoying a great reputation throughout Europe, and was meditating a visit to Italy when he heard of a revolt of the streltzi, fomented by the partisans of the old régime, in consequence of which he hurried back to Moscow, and on his arrival punished the rebels with the greatest severity.

In the year 1700 he joined Poland and Denmark against Sweden. Although defeated at Narva the same year, he pursued his plans unremittingly, and in 1709 won the battle of Poltava, after which Charles, the Swedish king, became a fugitive in Turkey. In 1703 the foundations of St Petersburg were laid. Peter had married in 1689

<sup>1</sup> Abbott, in the *Expositor*, 1882, p. 49, and Farrar, *The Early Days of Christianity*, vol. i. p. 190.



Eudoxia Lopukhin, but had divorced her in 1696; she bore him a son, Alexis. In 1711 he took as his second wife Martha Skavronska, whom he caused to be baptized in the Greek Church under the name of Catherine. In this year took place Peter's unsuccessful campaign in Turkey, which ended with the loss of Azoff. The well-known story of his being rescued by Catherine when on the point of being obliged to surrender to the enemy has been shown to be of very doubtful authority. In 1713 Peter had made himself master of a considerable strip of the Swedish coast. In 1716 he went on another European tour in the company of his wife; on this occasion he visited, among other places, Amsterdam, Copenhagen, and Paris. During his absence his son Alexis, who had been a constant source of trouble to him, became more rebellious and estranged from his father. He was openly leagued with the reactionary party in Russia, who looked forward to his assistance in reversing the policy of Peter, as soon as he should succeed to the throne. Peter on his return in 1718 forced his son to renounce all claim to the sovereignty. Alexis was afterwards tried for high treason and sentenced to death; soon it was given out that he had died suddenly. The fate of this wretched young man has only been ascertained in modern times; it seems tolerably clear that he sank under repeated inflictions of torture. His death is a dark stain upon the character of Peter. On 10th September 1721 the peace of Nystad was concluded, by which Sweden ceded Livonia, Esthonia, Ingria, Carelia, Viborg, and the adjacent islands to Russia. In 1724 Peter went to inspect the works on Lake Ladoga, and further weakened his constitution, which had long been in an unhealthy state on account of the continual excitement and arduous labours of his life. The czar died on 28th January 1725.

The character of Peter exhibits a strange congeries of opposed qualities. According to some he "knouted" Russia into civilization; others see in him the true "father of his country" and the founder of Russian greatness. In spite of his errors, no one will deny that he was a man of great genius; his was the "fiery soul that, working out its way," exhausted prematurely a vigorous physical organization. Although frequently cruel, on many occasions he showed humanity and tenderness, and even in his most violent fits of temper was amenable to advice, as he evinced in enduring the rebukes of Prince James Dolgoruki. All Russia seems but the monument of this strange colossal man. He added six provinces to her dominions, gave her an outlet upon two seas, a regular army, trained in European tactics in lieu of the disorderly militia previously existing, a fleet, and a naval academy, and, besides these, galleries of painting and sculpture and libraries. The title of "Great" cannot justly be refused to such a man.

PETER II., ALEXIEVICH (1715-1730), son of Alexis and grandson of Peter the Great, was born at St Petersburg in 1715, and ascended the throne in 1727. He was under the guardianship of Menshikoff, to whose daughter Mary he was betrothed. The faction of the Menshikoffs was overthrown, however, by the Dolgorukis, to a daughter of whose house the czar was now to be married. All these political plans were rudely broken by the death of Peter in January 1730. During his short reign this youth showed reactionary tendencies, and it seemed as if the capital of Russia was again to be transferred to Moscow. The young czar was buried in the cathedral of the Archangel in that city.

PETER III., FEODOROVICH (1728-1762), was son of Anna, daughter of Peter the Great, who had married the duke of Holstein. He was born at Kiel in 1728, his real names being Karl Peter Ulrich; he went to Russia in 1742 on being named heir to the throne. In 1745 he married Sophia Augusta, princess of Anhalt-Zerbst, who,

on entering the Greek Church, took the name of Catherine. They lived very unhappily together. In January 1762 the zarina Elizabeth died and Peter succeeded her. He soon became unpopular on account of his fondness for the Prussians and the introduction of German regulations in the army. His wife took advantage of his unpopularity and caused herself to be crowned empress, July 1762. Peter showed great want of energy, and only attempted to stem the insurrection when it was too late. He was removed to Ropaha in the government of St Petersburg, and, after having been forced to sign a renunciation of all rights to the throne, was strangled by Orloff and others. He was first buried in the Alexandro-Neviski monastery, but his remains were removed in 1796 by Paul to the Petropavlovski church.

PETERBOROUGH, a city and municipal and parliamentary borough, chiefly in Northamptonshire, but partly in Huntingdonshire, is situated on the river Nene, 76 miles north of London by the Great Northern Railway. The town is also a station on the London and North-Western, the Great Eastern, and the Midland systems. It is built chiefly along the river on the north side, the streets being straight and wide, and containing many good houses. The first bridge over the Nene at Peterborough was erected in 1140, the present bridge in 1872. The cathedral of St Peter is the third church that has occupied the site; the first, founded by Peada, king of the Mercians, in 656, was entirely destroyed by the Danes in 870, and the second, founded by King Edgar in 971, was accidentally burnt in 1116. The present building, founded in the following year, was, inclusive of the west front, 120 years in building, being consecrated on 4th October 1237. It is one of the three Norman cathedrals in England, and, though scarcely entitled to a place among cathedrals of the first rank, possesses special features rendering it second almost to none in point of architectural interest. It embraces in all eight periods of construction, and in no other building can the transition be better studied through the various grades of Norman to Early English, while the later addition is an admirable example of Perpendicular. The edifice proceeded as usual from east to west, and, while an increase in elegance and elaboration is observable in the later parts, the character of the earlier buildings has been so carefully kept in mind that no sense of incongruity is produced. A series of uniform Decorated windows were added throughout the church in the 14th century, and the effect has been rather to enhance than detract from the unity of design. The choir, Early Norman, was founded on 12th March 1117 (or 7th March 1118) by John de Sez, and dedicated in 1140 or 1143; the aisles of both transepts and the whole of the south transept were built by Martin of Bec, 1140-55; the remaining portions of the transepts and the central tower, of three stories, were completed by William de Waterville, 1155-75; the nave, Late Norman, was completed by Abbot Benedict, 1177-93, who added a beautiful painted roof of wood; the western transepts, Transition Norman, were the work of Abbot Andrew, 1193-1200; the western front, with its magnificent triple arch, the unique feature of the building, and one of the finest specimens of Early English extant, must have been built between 1200 and 1250; but there exists no record of its construction. The lady chapel, built parallel with the choir by William Parys, prior, was consecrated in 1290; the bell-tower was erected by Abbot Richard between 1260 and 1274; the south-west spire, the pinnacles of the flanking tower of the west portal, and the enlargement of the windows of the nave and aisles were the work of Henry de Morcot in the beginning of the 14th century; the new building or eastern chapel in the Perpendicular style, begun in 1438, was not completed till 1528. In 1541 the

church was converted into a cathedral, the abbot being made the first bishop. The extreme length of the building is 471 feet, and of the nave 211 feet, the breadth of the west front being 156; the height of the central tower, as reconstructed in the 14th century, was 150, that of the spires and tower of the west front is 156 feet. In 1643 the building was defaced by the soldiers of Cromwell, who destroyed nearly all the brasses and monuments, burnt the ancient records, levelled the altar and screen, defaced the windows, and demolished the cloisters. To obtain materials for repairs the lady chapel was taken down. In the latter part of the 18th century the church was repaired. In 1831 a new throne, stalls, and choir-screen were erected and other restorations completed. On account of the insecure state of the central tower in 1883, it was taken down; but it is now (1884) being rebuilt. Catherine of Aragon was interred in the cathedral in 1536, and Mary queen of Scots in 1588, but the body of the Scottish queen was removed to Westminster Abbey in 1612. Of the monastic buildings there are some interesting remains. The cathedral is approached by a Norman gateway, above which is the chapel of St Nicholas, built by Abbot Benedict, and now used as the music school, and on the left the chapel of St Thomas a Becket, built by Abbot Aahon in the 15th century, and now used as the grammar-school. The gateway to the bishop's palace, formerly the abbot's house, was built by Abbot Godfrey de Croiland in 1319, and the deanery gate by Abbot Kirton in 1515. One of the canonry houses is formed partly from a Lall of the 13th century. To the north of the cathedral is Touthill, said to have been erected for the defence of the monastery.

Peterborough is included for civil purposes in the parish of St John the Baptist, but for ecclesiastical purposes it is divided into four, the additional parishes being St Mary's Boongate (1857), St Mark's (1858), and St Paul's (1869). The old parish church of St John originally stood to the east of the cathedral, but was rebuilt on its present site in the centre of the city (1401-7) in the Perpendicular style. It consists of chancel, nave, aisles, and an embattled tower adorned with pinnacles. The educational establishments include the Henry VIII. grammar or chapter school; the St Peter's training college for schoolmasters for the dioceses of Peterborough, Ely, and Lincoln, erected from designs of Sir Gilbert Scott (1864), and attended by forty-six pupils; the practising school attached to the training college, attended by 250 boys; and Deacons and Ireland's charity school, established in 1721 for the clothing and educating of twenty poor boys, but lately reorganized. The principal public buildings are the market-house (1671), used as a town-hall, the corn exchange (1848) in the Italian style, the liberty jail and house of correction in the Norman style (erected in 1848 and enlarged in 1855 and 1870), the assembly rooms (1853), and the county court and probate office (1878). A cattle-market, 5 acres in extent, was opened in 1867. The benevolent institutions include the dispensary and infirmary, several almshouses, and the union workhouse. The modern prosperity and rapid growth of the town are chiefly due to the trade caused by the junction of so many railway lines. Adjoining the town are extensive works and sheds connected with the Great Northern and Midland Railways. Important cattle-markets and fairs are held, and there is a large transit of meat and cattle to London and elsewhere. An extensive trade in corn, coal, and timber is also carried on. The principal manufacture is that of agricultural implements. The entire parliamentary city of Peterborough has an area of 6553 acres (of which 6310 are in Northamptonshire), with a population of 22,894 (of whom 20,128 are in Northamptonshire). The population of the municipal borough (area, 1818 acres) in 1871 was 16,810, and in 1881 it was 21,228. Since 1841 it has more than trebled.

The ancient name of Peterborough was *Medeleshamstede*. The foundation of the great Benedictine abbey of St Peter was laid in 655 by Oswy, king of Northumbria, and Peada, the first Christian king of Mercia. It was the first of the Benedictine abbeys in Gyrwa land (Fenland). In 870 it was plundered by the Danes, after which it remained desolate till 966, when it was restored to its former splendour by Athwold, bishop of Winchester. From that time the town was called a borough, being probably then surrounded by walls; and under Abbot Leofric, nephew of Earl Leofric of Mercia, the abbey became one of the wealthiest in England. In 1169 it was plundered by Hereward. Since the first of Edward IV. the borough has returned two members to parliament. Until 1874 the city was included in the liberty or

soke of Peterborough, the government of which was vested in the lord paramount, the *custos rotulorum*, and magistrates appointed by the crown, with powers equal to those of judges of assize; a high bailiff of the city was appointed by the dean and chapter as lords of the manor, who acted as returning officer till the incorporation of the city in 1874. Peterborough is divided into three wards; for municipal and sanitary purposes it is governed by a mayor, six aldermen, and eighteen councillors, but for magisterial and sessional purposes is still included in the liberty of Peterborough.

Quoten, *History of the Church of Peterborough, 1686*; Britton, *History and Antiquities of the Abbey and Cathedral Church of Peterborough, 1822*; Paley, *Remarks on the Architecture of Peterborough Cathedral, 1849*; Swetling, *Notes on Peterborough Cathedral, 1860*.

PETERBOROUGH AND MONMOUTH, CHARLES MORDAUNT, EARL OF (c. 1658-1735), a man whose whole life was passed in the turmoil of excitement, was born about 1658. His father, John Mordaunt, was created Baron Mordaunt of Beigate, Surrey, in 1659; his mother was Elizabeth, the daughter and sole heiress of Thomas Cary, the second son of Robert Cary, earl of Monmouth. He entered upon a long career of warfare when only about sixteen years of age by joining Sir John Narborough's fleet in the Mediterranean, and won his first distinction in arms in Cloudeley Shovel's destruction of the dey's fleet under the very guns of Tripoli. On two subsequent occasions—the first in September 1678, the second in June 1680—he embarked in expeditions for the relief of Tangier, but the adventure met with little success, and that troublesome possession was soon after abandoned. His father died 5th June 1675, and Charles Mordaunt succeeded to the peerage. On his return from the second expedition to Tangier he plunged into active political life as a zealous Whig and an unswerving opponent of the duke of York. But his continued hostility to James II. forced him to retire to Holland, when he proposed to William of Orange to invade England. The disposition of the cold and cautious William had little in common with the fierce and turbulent English peer. His plan was rejected, though the prudent prince of Orange deemed it judicious to retain his fiery adherent by his side. When William sailed to Torbay his friend accompanied him, and when the Dutch prince was safely established on the throne of England honours without stint were showered upon Lord Mordaunt. He was sworn of the privy council 14th February 1689, made a lord of the bedchamber in the same month, created lord-lieutenant of Northamptonshire shortly after, and in April of the same year appointed first lord of the treasury and advanced in the peerage to be earl of Monmouth. In less than a year he was out of the treasury, but he still remained by the person of his monarch. He was with William in his dangerous passage to Holland in January 1691; and in June 1692, when crossing from England to the same country, he narrowly escaped shipwreck. Although the English king had refused his consent to a bill for triennial parliaments in the previous session, Lord Monmouth did not shrink from reintroducing it in December 1693. This led to a disagreement with the court, though the final breach did not take place until January 1697, when Monmouth was accused of complicity in Sir John Fenwick's conspiracy and of the use of "undutiful words" towards the king. He was committed to the Tower, staying in confinement until April 1697, and deprived of his employments. Some consolation for these troubles came to him in June of the same year, when he succeeded to the earldom of Peterborough. The four years after his release from the Tower were mainly passed in retirement at Paxton's Green, Fulham, at a house long since pulled down, but famous for its "extraordinary good rooms" and its spacious gardens. At the close of William's reign Lord Peterborough emerged from his suburban retreat for a time to take part in the prosecution of Lord Somers, and on the accession of Anne he plunged into political life again with avidity. His first act was to draw down on himself in February 1702, the

censure of the House of Commons for the part which he took in the attempt to secure the return of his nominee for the borough of Malmesbury. In the same year he was appointed governor of Jamaica, but he never visited the island over which he ruled, preferring to remain in a part of the world where he could play a more active part in the government of affairs. Through the fear of the ministry that his restless spirit would drive him into opposition to its measures if he stayed at home, he was appointed early in 1705 to command an expedition of English and Dutch troops in Spain. He was created sole commander of the land-forces and joint-commander with Sir Cloudeley Shovel of the fleet, and at the same time was reinstated a member of the privy council. His first exploit was to seize Denia in Valencia; then, with all the impetuosity of his character, he urged upon the Austrian claimant to the throne the expediency of dashing for Madrid, less than 250 miles distant, only to find that he was overruled by his colleagues in council. After this repulse he sailed for Barcelona (August 1705) and commenced to besiege that town. For three weeks the siege languished, until, by a sudden night-attack on 14th September, Peterborough seized the outworks of Montjuich, and three nights later captured the citadel itself. On 14th October the city was his. This was his greatest feat, and in this enterprise he showed, what was usually wanting in his character, both tact and conciliation. After this victory Catalonia declared for the Austrian prince, and Peterborough advanced into Valencia with the object of reducing it to subjection. By threats, cajolements, intrigues, and plots he obtained possession of its chief towns, but the prince for whom he was fighting allowed himself to be surrounded in Barcelona. Peterborough's advice, that Charles should travel by sea to Lisbon and march against Madrid with the allied force of 25,000 men, was disregarded, and the English commander with his little body of 2000 foot and 600 horse then advanced towards Barcelona, which was besieged by a greatly superior force of the enemy. The city was on the point of being captured, when Peterborough, warned of the approach of the English fleet—it is said that the signal of its arrival was a blank sheet of paper—put off in an open boat, and, after journeying to and fro, met with his country's vessels. On 8th May he brought the leading ships into the port of Barcelona, and three days later the French beat a retreat. Again did the English commander urge upon the Austrian claimant of the Spanish throne the expediency of immediately advancing to Madrid, and again was the advice rejected, although the capital was occupied by the allied forces under Galway and Das Minas. Charles remained at Barcelona for some weeks, and when at last he did move towards Madrid it was by a route which Peterborough disapproved of. When difficulties beset Charles on his way the earl joined him, but he soon retired to Valencia in disgust, and then left the country to raise money at Genoa. In a short time he returned to Spain once more, but during his absence the prospects of the allied forces had passed from bad to worse. The leaders of the army differed in their views, and Lord Peterborough quitted the country for ever (March 1707).

On his return to England he allied himself with the Tories, and received his reward in being contrasted, much to his advantage, with the Whig victor of Blenheim and Malplaquet. The differences between the three peers, Peterborough, Galway, and Tyrwley, who had served in Spain, formed the subject of angry debates in the Lords, when the majority declared for Peterborough; after some fiery speeches the resolution that he had performed many great and eminent services was carried, and votes of thanks were passed to him without any division. His new friends were not desirous of detaining him long on English soil,

and they sent him on a mission where he characteristically engaged the ministry in pledges of which they disapproved. His resentment at this disagreement was softened by the command of a cavalry regiment, and by his appointment as a Knight of the Garter. A few months before the close of Queen Anne's reign (November 1713) he was despatched as ambassador-extraordinary to the king of Sicily, but was recalled by the Whigs as soon as they obtained the reins of power. With the accession of George I. Lord Peterborough's influence was gone. Hatred of Marlborough became the ruling passion of his mind. His last twenty years of life were passed with the recollection of disappointed hopes and with the continual presence of disease. Worn out with suffering, he died at Lisbon, 25th October 1735. His remains were brought to England and buried at Turvey in Bedfordshire, 21st November.

Lord Peterborough was short in stature and spare in habit of body. His activity knew no bounds. He was said to have seen more kings and postillions than any man in Europe, and the whole point of Swift's lines on "Mordant" consisted in a description of the speed with which he hastened from capital to capital. Nature had bestowed many gifts upon him, but had denied him more. He was eloquent in debate and intrepid in war, but his influence in the senate was ruined through his inconsistency, and his vigour in the field was wasted through his want of union with his colleagues. He could do nothing like other men. His first wife, Carey, daughter of Sir Alexander Fraser of Mearns, died 13th May 1709, and was buried at Turvey 20th May. Some years later he married Anastasia Robinson, a dramatic singer of great beauty and sweetness of disposition; but she was unrecognized as his wife, and lived apart from him at her mother's house at Parson's Green. Nor was it until a few months before his death that she was introduced to society as the countess of Peterborough. (W. P. G.)

PETERHEAD, a seaport, market town, burgh of barony, and parliamentary burgh of Aberdeenshire, Scotland, is situated on a rocky peninsula on the North Sea, about 30 miles north-north-east of Aberdeen and 2 north of Buchan Ness. It has railway communication by a section of the Great North of Scotland line, opened in 1862. The town is built of the red granite of the district. At the extremity of the peninsula is the insular suburb of Keith-Inch. Among the principal buildings are the town-hall (1788), with a granite spire 125 feet high, the music hall, and the court-house. The reading society (1808) possesses a library with upwards of 5000 volumes, and the mechanics' institute one with about 1000 volumes. The Arbutnot Museum contains natural history specimens, a collection of coins, and objects of antiquarian interest. In front of the town-hall is a statue to Field-Marshal Keith (1696-1758), presented to the burgh by William I. of Prussia in 1868. A market cross was erected in 1832 when the town was created a parliamentary burgh. Peterhead at an early period had an extensive trade with the ports of the Baltic, the Levant, and America. Formerly it was a bonding support to Aberdeen, but was made independent in 1832. The north and south harbours lie between the town and Keith-Inch, and the isthmus dividing them is pierced by a canal, which is crossed by an iron swing-bridge. In the north harbour are two graving-docks. A new harbour was completed in 1878, and the south harbour has been deepened and enlarged. The south bay is to be converted into a national harbour of refuge. The Arctic seal and whale fishing, which in 1802 was prosecuted by only one vessel, employed in 1857 as many as 32 vessels, but since that time it has declined somewhat. The herring fishing, in which the port has long held a leading position (631 boats in 1883), was begun in 1818 by a joint-stock company. The general trade is of considerable importance. The chief exports are herrings (£180,000 in 1883), granite, cattle, and agricultural produce. In 1883 the number of vessels that entered the port with cargoes and in ballast was 864 of 87,839 tons, the number that cleared 840 of 86,318 tons. The town possesses ship and boat building

yards, saw-mills, an iron-foundry, cooperages, agricultural implement works, woollen manufactories, breweries, and a distillery. In the neighbourhood there are extensive granite and polishing works. The limits of the police burgh and the parliamentary burgh are identical, with a population in 1871 of 8535 and in 1881 of 10,922.

The town and lands of Peterhead belonged anciently to the abbey of Deir, built by William Cumming, earl of Buchan, in the 13th century. When the abbey was erected into a temporal lordship in the family of Keith, the superiority of the town fell to the earl marischal, with whom it continued till the forfeiture of the earldom in 1715. The town and lands were purchased in 1720 by a fishing company in England, and on their failure by the Merchant Maiden Hospital of Edinburgh for £3000, who are still the superiors of the town. Peterhead was made a burgh of barony in 1593 by George Keith, fourth earl marischal of Scotland. It was the scene of the landing of the Pretender, 25th December 1715. Peterhead is included in the Elgin district of burghs.

**PETERHOF**, a town of European Russia, in the government of St Petersburg, and 18 miles west of the capital, on the south coast of the Gulf of Finland, has grown up round the palace built by Peter the Great in 1711, was constituted a district town in 1848, and has increased its population from 7647 in 1866 to 14,298 in 1881. It is almost exclusively a residential town, but is garrisoned by a cavalry regiment and has the military schools lodged in its barracks for six weeks in the summer. The palace, which is still occupied by the imperial family during part of the summer, has undergone alterations and additions, but retains a distinct Petrine stamp. It is built on a height 60 feet above the sea. The gardens, which owe their magnificence to Alexander I and Nicholas I, are laid out in the Versailles style, with elaborate water-works. From the "Marly" summer-house Peter I. loved to watch his fleet beneath the Cronstadt batteries, and in that of "Mon-plaisir" he died. It was at Peterhof that the empress Alexandra used to celebrate her birthday by fêtes at which more than 100,000 persons were present. Peterhof is connected with Oranienbaum on the west and with Strelna on the east by an uninterrupted series of gardens and villas.

**PETERS**, or **PETER, HUGH** (1598-1660), a man whose name has for three centuries been rarely mentioned except in terms of infamy, was the son of Thomas Dykwoode *alias* Peters, by Martha, daughter of John Freffry of Fowey, Cornwall, and was baptised in Fowey parish church 29th June 1598. His parents were in good circumstances, and they sent him to Trinity College, Cambridge, where he took the degree of B.A. in 1616 and M.A. in 1622. About the latter date he was licensed by Dr George Montaigne, bishop of London, to the lectureship at St Sepulchre's, London, but his first definite post in the church was at Rotterdam (1623-32), as colleague of William Ames, whom he much admired, and who died "in his bosom." In October 1635 he emigrated to Boston in New England, and in the following year became the minister of the first church at Salem in Massachusetts. His abilities soon gave him a prominent place in all the civil and ecclesiastical affairs of the colony, and in 1641 his reputation was so great that he was sent to England as the best guardian of the colony's interests at home. His shrewd judgment, his ready wit, and his zeal for the cause of the Parliament endeared him to the army and its leaders; he accompanied Fairfax and Cromwell on their campaigns, and described their achievements in numerous letters to the House of Commons. To the adherents of the vanquished cause Hugh Peters always lent his good offices. He was desirous that Laud should be banished, and not executed. It was through his influence that Juxon was permitted to attend Charles after his condemnation, and his acts of kindness to some of the Royalist clergy are mentioned in Walker's *Sufferings of the Clergy*. Through the favour of the Pro-

tector he filled several important offices. He was one of the twenty-one persons appointed to consider the abuses of the national laws; he was a judge for granting probates of wills, and a trier for licensing candidates to the ministry. At the Restoration he was seized and imprisoned in the Tower of London, where he composed his affecting tract, "A Dying Father's Last Legacy to an Only Child." His trial as a regicide took place on 13th October 1660, and he was, of course, condemned to death. Four days later he was drawn on a sledge to Charing Cross and there hanged and quartered, his head being set on a pole on London Bridge. Hugh Peters suffered his cruel death without any sign of wavering. For many years after his death the grossest charges against his memory were circulated in catchpenny pamphlets by his enemies, and his name was held up to general execration; but it is clear that these accusations are but the creation of party malice. He was twice married; his first wife was Elizabeth, said to have been the daughter of Thomas Cooke of Pebmarsh, Essex, and the widow of Edmund Read, who died at Wickford in the same county November 1623. She died about 1640, and he subsequently married Deliverance Sheffield, the mother of his only child, Elizabeth Peters. The writings of Hugh Peters and the publications, in print and manuscript, relating to his life are described in the *Bibliotheca Cornubiensis*. He pleaded, in opposition to Prynne and others, for the admission of the Jews into England. The chief blot on his fame is his advocacy of the burning of the records.

**PETERSBURG**, a city and port of entry of the United States, in Dinwiddie county, Virginia, lies 23 miles south of Richmond on the south side of the Appomattox river, which is navigable for large vessels from the James river up to the falls opposite the city, and for flat boats 107 miles above the falls to Farmville. Petersburg is an important railway junction, manufactures tobacco, cotton goods, and iron wares, and carries on a very extensive shipping trade in the export of tobacco, cotton, flour, and peanuts (groundnuts). Its public buildings comprise a court-house, a custom-house, and post-office, two markets, and a theatre; there are two public libraries and a public park (Poplar Lawn). The population was 14,010 in 1850, 18,266 in 1860, 18,950 (10,185 coloured) in 1870, and 21,656 in 1880.

Petersburg was laid out at the same time with Richmond (1735) by Colonel William Byrd, on the site of an Indian village destroyed in 1676. It was first incorporated in 1748. During the Revolutionary War it was twice the headquarters of the British under General William Phillips, who died while in possession of the town in 1781. The bravery of the Petersburg volunteers on the Canadian frontier in 1813 procured it the title of Cockade City of the south. The terrible siege of Petersburg, lasting from June 1864 to 3d April 1865, was the final scene of the Civil War.

**PETERWARDEIN** (Hungarian *Petervárad*, Servian *Petrovaradin*), a town and strong fortress of Hungary, is situated on a promontory formed by a loop of the Danube, 45 miles to the north-west of Belgrade. It is connected with Neusatz on the opposite bank by a bridge of boats 800 feet long. The fortifications consist of the upper fortress, on a lofty serpentine rock rising abruptly from the plain on three sides, and of the lower fortress at the northern base of the rock. The latter includes the town, which contains (1880) 3603 inhabitants, engaged in wine-growing, agriculture, and the manufacture of liquor (rosoglio) and vinegar. The two fortresses can accommodate a garrison of 10,000 men. The arsenal contains interesting trophies of the Turkish wars.

Peterwardein, the "Gibraltar of Hungary," is believed to represent the Roman *Acuminum*, and received its present name from Peter the Hermit, who here marshalled the levies of the first crusade. It was captured by the Turks in 1526 and retained by them for 160 years. In 1716 it witnessed a signal defeat inflicted

on the Turks by Prince Eugene. During the revolutionary struggles of 1848-49 the fortress was held by the insurgents for a short time.

**PÉTION DE VILLENEUVE, JÉRÔME (1753-1794)**, was the son of a procureur at Chartres, where he was born in 1753. He himself became an avocat in his native place in 1778, and at once began to try to make a name in literature. His first printed work was an essay, *Sur les Moyens de prévenir l'Infanticide*, which failed to gain the prize for which it was composed, but pleased Brissot so much that he printed it in vol. vii. of his *Bibliothèque philosophique des Législateurs*. Pétion's next works, *Les Lois Civiles*, and *Essai sur le Mariage*, in which he advocated the marriage of priests, confirmed his position as a bold reformer, and when the elections to the States-General took place in 1789 he was elected a deputy to the Tiers État for Chartres. Both in the assembly of the Tiers État and in the Constituent Assembly Pétion showed himself a radical leader. He supported Mirabeau on 23d June, attacked the queen on 5th October, and was elected president on 4th December 1790. On 21st June 1791 he was chosen one of three commissioners appointed to bring back the king from Varennes. After the last meeting of the assembly on 30th September 1791 Robespierre and Pétion were made the popular heroes and were crowned by the populace with civic crowns. Pétion received a still further proof of the affection of the Parisians for himself on 14th November 1791, when he was elected second mayor of Paris in succession to Bailly. In his mayoralty he exhibited clearly his republican tendency and his hatred of the old monarchy, especially on 20th June 1792, when he allowed the mob to overrun the Tuileries and insult the royal family. For neglecting to protect the Tuileries he was suspended from his functions by the Directory of the department of the Seine, but the leaders of the Legislative Assembly felt that Pétion's cause was theirs, and rescinded the suspension on 13th July. On 3d August, at the head of the municipality of Paris, Pétion demanded the dethronement of the king, and on 10th August, while the monarchy was falling with the Tuileries, he patiently underwent a form of detention in his own mairie. He was still mayor of Paris when the massacres of September in the prisons took place, and must bear the blame of not having endeavoured to interfere. He was elected to the Convention for Eure-et-Loir, and became its first president. Manuel then had the folly to propose that the president of the Assembly should have the same authority as the president of the United States; his proposition was at once rejected, but Pétion got the nickname of "Roi Pétion," which contributed to his fall. His jealousy of Robespierre allied him to the Girondin party, as did also his assiduous attention at Madame Roland's salon. With the Girondins he voted for the king's death and for the appeal to the people, as one of them he was elected to the first committee of general defence in March 1793, as their representative he attacked Robespierre on 12th April, and it is no matter of wonder, therefore, that his name was among those of the twenty-two Girondin deputies proscribed on 2d June. Pétion was one of those who escaped to Caen and raised the standard of provincial insurrection against the Convention; and when the Norman rising failed he fled with Guadet, Buzot, Barbaroux, Salle, and Louvet to the Gironde, and hid in a grotto at St Emilion. At last, but a month before Robespierre's fall in June 1794, the escaped deputies felt themselves tracked down, and deserted the grotto; Louvet found his way to Paris, Salle and Guadet to Bordeaux, where they were soon taken; Barbaroux committed suicide; and the bodies of Pétion and Buzot were found in a field, half-eaten by wolves.

For Pétion's published works, see the edition of his *Œuvres*, 3 vols., 1792; for his life, see the ridiculous eulogy in J. J. Regnault-Warin's *Vie de Pétion*, 1792, and *Mémoires inédits de Pétion et*

*Mémoires de Buzot et de Barbaroux*, with an introduction by C. A. Dauban, 1866; and for his last days and death, see C. Vatal, *Charlotte Corday et les Girondins*, 3 vols., 1872.

**PETIS DE LA CROIX, FRANÇOIS (c. 1653-1713)**, the best representative of Oriental learning in France during the last decades of the 17th century and the beginning of the 18th century, was born in Paris about 1653. He was son of the Arabic interpreter of the French court, and inherited this office at his father's death in 1695, afterwards transmitting it to his own son, Alexandre Louis Marie. At an early age he was sent by Colbert to the East; during the ten years he spent in Syria, Persia, and Turkey he mastered Arabic, Persian, and Turkish, and also collected rich materials for future writings.<sup>1</sup> He found, besides, opportunity to equip himself for those diplomatic missions which the French Government entrusted to him soon after his return to Paris in 1680. Having served a short time as secretary to the French ambassador in Morocco, he accompanied as interpreter the French forces sent against Algiers, and greatly contributed to the satisfactory settlement of the treaty of peace between the two countries, which was drawn up by himself in Turkish and ratified in 1684. In a similar capacity he conducted the negotiations with Tunis and Tripoli in 1685 and those with Morocco in 1687; and the zeal, tact, and linguistic knowledge he manifested in these and other transactions with Eastern courts were at last rewarded in 1692 by his appointment to the Arabic chair in the Collège Royal de France, which he filled until his death in 1713.

He published *Contes Turcs*, Paris, 1707, and *Les Mille et un Jours*, 5 vols., Paris, 1710-12, and proved his acquaintance with the Armenian and Ethiopic languages (a powerful impulse to the study of the latter having been given just at that time by the masterly works of Hiob Ludolf) in his *Armenian Dictionary* and his *Account of Ethiopia*. But the lasting monument of his literary fame, the one standard work that has outlived many generations and still keeps a distinct merit of its own, is his excellent French version of Sharaf-uddin 'Alî Yazdî's *Zafarnâma*, or *History of Timûr* (completed 828 A.H.; 1425 A.D.), which was given to the world nine years after his death, 1722 (4 vols., Paris; translated into English by J. Darby, London, 1723). This work, renowned throughout the East as a model of elegant style, and one of the rare specimens of a fairly critical history Persia can boast of, was compiled under the auspices of Mirza Ibrâhîm Sultân, the son of Shâh Rukh and grandson of the great Timûr himself. This prince collected all the official records of Timûr's reign, both in Turkish and Persian, collated and revised them, and had then an accurate text drawn up by his secretaries, which was translated by Sharaf-uddin into elegant and refined language and revised by Ibrâhîm Sultân himself (see *Bleu's Cat. Persian MSS. in the Brit. Mus.*, i. p. 173 sq.). The only error committed by Petis de la Croix in his otherwise very correct translation is that he erroneously ascribed the important share which Ibrâhîm Sultân had in the *Zafarnâma* to Timûr himself.

PETITION is an application for redress by a person aggrieved to an authority capable of relieving him. It may be made in the United Kingdom to the crown or its delegate, or to one of the houses of parliament.

The right of petitioning the crown was recognised indirectly as early as Magna Charta in the famous clause, *Nulli vendemus, nulli negabimus aut differemus, rectum aut justitiam*, and directly at various periods later, e.g., in the articles of the Commons assented to by Henry IV., by which the king was to assign two days in the week for petitions, it being an honourable and necessary thing that his lieges who desired to petition him should be heard (*Rot. Parl.*, 8 Hen. IV., p. 585). The case of the seven bishops in 1688 confirmed the right, and finally the Bill of Rights in 1689 declared "that it is the right of the subjects to petition the king, and all commitments and prosecutions for such petitioning are illegal." Petitions to the crown appear to have been at first for the redress of

<sup>1</sup> Many of these—as the account of Jerusalem, *Modern and Ancient*, the *Travels through Syria and Persia*, the *Antiquities and Monuments of Egypt*, the translations of Pseudo-Walid's *Conquest of Syria* and of Hâjî Khalfa's *Dictionary*, and the *History of the Ottoman Empire*—still remain in manuscript.

private and local grievances, or for remedies beyond those possessed by the courts. As equity grew into a system, petitions of this kind tended to become superseded by bills in chancery (see CHANCERY). Statutes were originally drawn up by the judges at the close of the session of parliament from the petitions of the Commons and the answers of the crown. In the drawing up of the statutes frauds were at times committed, the judges not always reciting correctly the tenor of the petition or answer. To obviate this danger complete statutes in the form of bills began to be introduced into parliament in the reign of Henry VI. The crown could accept or reject them, but could not alter them (see Hallam, *Middle Ages*, ch. viii pt. 3). A relic of the old form of the statute founded upon petition still remains in the preamble of Appropriation Acts and other statutes creating a charge upon the public revenue. It runs thus: "We, your majesty's most dutiful and loyal subjects, the Commons of the United Kingdom . . . do most humbly beseech your majesty that it may be enacted; and be it enacted, &c.," from this point following the enacting words common to all statutes. Petitions to the crown from the House of Commons in other matters now usually take the form of addresses. The crown may refer petitions presented to it to be adjudicated upon by a delegated authority. This is the course pursued in the case of peerage claims, which are referred to the House of Lords, and by that House to the committee for privileges, and in the case of petitions to the crown in council, with which the judicial committee in most cases deals (see below); or the crown may delegate the power of receiving petitions in the first instance. Examples of petitions to the delegated authority are those addressed to a court of justice or those addressed to the home secretary for the pardon or mitigation of punishment of a convicted criminal. Petitions to the houses of legislature seem to have been later in origin than petitions to the crown. The political importance of petitioning dates from about the reign of Charles I. The development of the practice of petitioning had proceeded so far in the reign of Charles II. as to lead to the passing of 13 Car. II. c. 5 against tumultuous petitioning. This is still law, though it has ceased to be enforced. It provides that no petition or address shall be presented to the king or either house of parliament by more than ten persons; nor shall any one procure above twenty persons to consent or set their hands to any petition for alteration of matters established by law in church or state, unless with the previous order of three justices of the county, or the major part of the grand jury. Up to 1688 petitions usually dealt only with some specific grievance; from that time dates the present practice of petitioning with regard to general measures of public policy. Since 1833 more than 700,000 petitions on public matters have been presented to the House of Commons. Petitions to the crown need not apparently be in any particular form, but no doubt they would not be received if couched in unbecoming language. Petitions to the Houses of Lords and Commons must be framed in a prescribed form. They must be properly superscribed, and must conclude with a prayer. They must be in writing (in the Commons), must contain none but genuine signatures, and must be free from disrespectful language or imputations upon any tribunal or constituted authority. They must be presented by a member of the House, except petitions to the House of Commons from the corporation of London, which may be presented at the bar by the sheriffs, and from the corporation of Dublin, which may be presented by the lord mayor. Though a petition is made to the House, in practice petitions to the Commons are referred to the committee on public petitions, under whose directions they are classified and analysed. In the Lords receivers and triers of petitions

are still appointed, though their functions have long been obsolete. Petitions may be sent free by post to members of either house, provided they fulfil certain conditions as to weight, &c. (see May, *Parliamentary Practice*, ch. xix.)

In the United States the right of petition is secured by Art. I of the Amended Constitution, which enacts that "Congress shall make no law abridging . . . the right of the people peaceably to assemble and to petition the Government for a redress of grievances."

*Petitions to a Court of Justice.*—Strictly speaking these are no doubt an indirect mode of petitioning the crown, for in the theory of English law the crown is the fountain of justice. But it is more convenient to treat them separately, as they now form a part of the practice of the courts. Appeals to the House of Lords and the privy council are prosecuted by petition of appeal. The House of Lords has now no original jurisdiction in judicial matters; the original jurisdiction of the privy council in such matters is confined to petitions under certain statutes, such as the Endowed Schools Acts 1867 and 1873, the Public Schools Act 1868, the Universities Act 1877, and the Patents Act 1883. In most cases the petitions are referred to the judicial committee of the privy council. Petitions may be addressed to the lord chancellor in a few instances, such as the sealing of patents and the removal of coroners and county court judges. The most important use of petitions in England is in the Chancery Division of the High Court of Justice. They may be presented either as interlocutory proceedings in the course of an action, or as original proceedings where no litigation exists,—a petition being generally a more cheap and speedy form of remedy than an action. Petitions in the course of an action are usually presented to the court in which the action is brought. Examples of original petitions are those under the Lands Clauses Acts, the Trustee Acts, the Companies Acts. In a few cases they may be brought by way of appeal, e.g., under the Charitable Trusts Act 1860. Petitions are also modes of procedure in other courts with jurisdiction in equity, as the chancery courts of the county palatine of Lancaster and the county courts, in the latter only in certain cases falling within the County Courts Act 1865, 28 and 29 Vict. c. 99, s. 1 (5) and (6). They are used to initiate proceedings in bankruptcy and divorce, but are almost unknown in the Queen's Bench Division; the only case of procedure by petition in that division seems to be the petition to sue *in forma pauperis*. Evidence in support of a petition is usually given by affidavit.

In Scotland petitions in the Court of Session are either original or in a pending action. Original petitions are presented to one of the divisions of the inner house, unless they are included in any of the matters mentioned in 20 and 21 Vict. c. 56, s. 4, when they are brought before the junior lord ordinary, or unless, by special statutory provision, they may be brought before any lord ordinary, as in the case of petitions under the Conjugial Rights Act 1861, or the Trusts Act 1867. In the sheriff court actions are commenced by petition (39 and 40 Vict. c. 70, s. 6). A *petition and complaint* is a process of a quasi-criminal nature by which certain matters of extraordinary jurisdiction are brought under the notice of the Court of Session. It lies against magistrates and officers of the law for breach of duty, against parties guilty of contempt of court, &c. The concurrence of the lord advocate is necessary to a petition and complaint. A *reclaiming petition*, obsolete in the Court of Session, is a form of process of appeal in the sheriff court. See 39 and 40 Vict. c. 70, ss. 28, 30.

In the United States petitions can be presented to the courts under much the same circumstances as in England. "It is a general rule in such cases that an affidavit should be made that the facts therein contained are true as far as



known to the petitioner, and that those facts which he states as knowing from others he believes to be true" (Bouvier, *Law Dict.*).

**Election Petition.**—The article ELECTIONS must now be read subject to the Parliamentary Elections Act 1879 and the Judicature Act 1881. By the Act of 1879 the trial of an election petition is conducted before two judges instead of one, as before. If the judges differ in opinion as to whether the member petitioned against is duly elected or not, he is deemed to be duly elected. The Act of 1881 provides for the annual appointment of three judges of the Queen's Bench Division for the trial of election petitions, and makes the judgment of the High Court of Justice in election cases final unless leave be given to appeal to the Court of Appeal. No appeal lies to the House of Lords, nor can any judge who is a peer sit on the trial of an election petition.

**Petition of Right** is a term confined to English law. It is used in two senses. (1) It denotes the statute 3 Car. I. c. 1, a parliamentary declaration of the liberties of the people. (See ENGLAND, vol. viii. p. 345.) (2) It denotes a mode of prosecuting a claim against the crown by a subject. This remedy is said to owe its origin to Edward I. It lies as a rule for obtaining possession of real or personal property, or for breach of contract, not for breach of public duty, as failure to perform treaty obligations, or for trespass, or for negligence of crown servants. The remedy where the crown is in possession of property of the suppliant, and the title of the crown appears by record, as by inquest of office, is a somewhat different one, called *monstrans de droit*. The procedure on a petition of right is either at common law or by statute. At common law the petition suggests such a right as controverts the title of the crown, and the crown indorses upon the petition *Soit droit fait al partie*. Thereupon a commission is issued to inquire into the truth of the suggestion. After the return to the commission, the attorney-general pleads or demurs, and the merits are then determined as in actions between subject and subject. If the right be determined against the crown, judgment of *ousterlemain* or *amoveas manus* is given in favour of the suppliant. The Petitions of Right Act 1860 (23 and 24 Vict. c. 34, extended to Ireland by 36 and 37 Vict. c. 69) preserves to the suppliant his right to proceed at common law, but gives an alternative remedy. In proceedings under the statute the petition is left with the secretary of state for the home department for her majesty's consideration. She, if she think fit, grants her fiat that right be done, whereupon the fiat is served upon the solicitor to the treasury, and a statement of defence is put in on behalf of the crown. The proceedings are thenceforth assimilated as far as possible to those in an ordinary action. A judgment in favour of the suppliant is equivalent to a judgment of *amoveas manus*. Costs are payable to and by the crown. A petition of right is tried in the Chancery or Queen's Bench Division, unless the subject-matter of the petition arises out of the exercise of belligerent right on behalf of the crown, or would be cognizable in a prize court if the matter were in dispute between private persons. In either of these cases the suppliant may at his option intitle his petition in the Admiralty Division (27 and 28 Vict. c. 25, s. 52). (J. W.†)

PETRA († Πέρρα, in ecclesiastical writers also αἰ Πέρραι), the capital city of the NABATEANS (q.v.), and the great centre of their caravan trade, is described by Strabo (xvi. p. 779) as lying in a level place, well supplied with water for horticulture and other uses, but encircled by a girdle of rocks, abrupt towards the outer side. The surrounding country was barren, especially towards Judæa; the distance from Jericho was three to four days' journey, and from Phœnicum on the Red Sea coast five (see plate VI., vol. vii.). Accord-

ing to Pliny (*N. H.*, vi. 144) the little valley of Petra is not quite 2 miles across, and lies at the junction of two roads, from Palmyra and Gaza respectively, 600 miles from the latter. These and other ancient notices leave no doubt as to the identity of the site with the modern Wady Mûsâ in the mountains which form the eastern wall of the great valley between the Dead Sea and the Gulf of Akaba. Wady Mûsâ lies just north of the watershed between the two seas, in 30° 19' N. lat. and 35° 31' E. long.<sup>1</sup> Travellers coming up the Arabah usually approach the ruins of Petra from the south-west by a rough path, partly of artificial construction<sup>2</sup>; but the natural entrance is from the east down a narrow defile more than a mile long, called the Sîk ("shaft"). The Sîk is a contraction in the valley of a stream which comes down from the east, rising in a spring now known as the Fountain of Moses (Ain Mûsâ),<sup>3</sup> and passing between the villages of Eljî and 'Aireh (Palmer). Both these places are ancient; the latter is the fortress Wo'aira of Yâkût,<sup>4</sup> while Eljî, mentioned by Edrisi, is the "Gaia urbs juxta civitatem Petram" of the *Onomasticon*.<sup>5</sup> Below these and above the ravine the characteristic rock-cut tombs and dwellings of the Nabateans begin to appear. But to reach the city proper from these upper settlements one must traverse the whole length of the defile, which is simply a narrow waterway, in some places not more than 10 or 12 feet broad, and walled in by rich brown or red precipices rising from 60 to 120 feet (De Luynes; Stanley doubles this height) above the stream. In ancient times there was a paved path beside the channel, and remains of an arch spanning it are seen high in the air near the entrance. Towards the lower end of the gorge, a turn in the dark path and the descent of a side valley admit a sudden flood of light, and here stands the most famous ruin of Petra, the so-called Khazna, or "treasury of Pharaoh," with a rich façade of late Roman style, not built but hewn out of the rose-coloured limestone. The next turn gives room for a rock-cut theatre, and from this point the gorge begins to open out into the little plain described by Strabo, and gives perhaps the most striking view of the multiplicity of grottoes with elaborate classical façades which line the enclosing mountain-wall. The plain itself is strewn with ruins of temples and other buildings, and stairs once led up the rocky walls to higher structures, of which the most notable is now called the "convent" (Al-Deir). The grottoes are inhabited in cold weather by the Liyâthina Fellâhin, who also hold the upper part of the valley, and are so troublesome and extortionate that no thorough exploration of the district has yet been carried out. It is not even known where the torrent-bed leads on leaving the plain of Petra. De Luynes describes the water as wholly absorbed by the sands near the theatre, but there is an unexplored gorge to the south-west which is the continuation of the valley.

The Nabateans, as we see from Diodorus, used Petra as a place of refuge and a safe storehouse for their treasures of frankincense, myrrh, and silver before they gave up their nomadic habits. But Petra was not only safe and well

<sup>1</sup> The latitude and longitude are taken from De Luynes's map. Ptolemy, who, according to Olymiodorus, spent some time in Petra, and doubtless owes to this fact his excellent information about the caravan-routes in Arabia, gives the latitude, with surprising accuracy, as 30° 20'.

<sup>2</sup> Compare Diod., xix. 97, who describes the Nabatean fortress—it was not a town at the time in question (812 B.C.), for the Nabateans were still nomads when they were attacked by Antigonos—as ascended to by a single artificial path.

<sup>3</sup> This seems to be the fountain mentioned by Nowairi, ap. Quatremère's *Mémoires*, p. 84, which flowed with blood and was charged with water by Moses. The name Od-lomâ, which gave rise to this legend, may possibly be a relic of the old name of Edom.

<sup>4</sup> Perhaps also the Iram, D'Y, of Gen. xxvii. 43.

<sup>5</sup> See Tuch's *Genesis*, 2d ed., p. 271, note.

watered, it lay close to the most important lines of trade. The modern pilgrim-road from Damascus to Mecca, which has taken the place of the old incense-route, passes indeed a little to the east by Ma'an. But to touch Petra involves no great detour even on this line, and in ancient times, when Gaza was the great terminus of the Arabian trade, Petra was the place where the Gaza road branched off from that to Bostra, Palmyra, and north Syria. The route from Egypt to Damascus is also commanded by Petra, and from it too there went a great route direct through the desert to the head of the Persian Gulf. Thus Petra became a centre for all the main lines of overland trade between the East and the West, and it was not till the fall of the Nabatæan kingdom that PALMYRA (*q.v.*) superseded it as the chief emporium of north Arabia. Many Roman and other foreign merchants were settled here even in the time of Strabo, and he describes the caravans which passed between it and Leuce Come on the Red Sea coast as comparable to armies.

Petra<sup>1</sup> is a Greek name which cannot have been that used by the Semitic inhabitants, and from Josephus (*Ant.*, iv. 7, 1; 4, 7) and the *Onomastica* (ed. Lag., p. 286 *sq.*) it may be concluded that the natives called the place Rekam (רַקַּמ), a designation probably derived from the variegated colours of the rocks about Wady Mûsâ, to which all travellers refer with admiration.<sup>2</sup> But Petra had yet another ancient name familiar from the Bible. The Biblical Sela (generally with the article יְסֵלָה), a city of Edom (2 Kings xiv. 7; Isa. xvi. 1; also Judges i. 36, where E.V. has "the rock"; perhaps also Isa. xlii. 11), appears to be identified with Petra by the LXX., and certainly is so by the *Onomastica*. Petra, in fact, or the "rock," seems to be simply a translation of Sela, but a somewhat loose one,—for the Hebrew name, corresponding to the Arabic Sal', is properly a hollow between rocks, just such a place as Petra is. The fortress of Edom, according to Obadiah 3, lay "in the clefts of the Sela," and seemed impregnable. And that the name of Sela survived the Nabatæan occupation is known from Yâkût, who places a fortress Sal' in Wady Mûsâ (comp. Nöldeke in *Z.D.M.G.*, xxv. 259). Petra, therefore, was a city before the Nabatæans, and, occupying one of the few cultivable spots in the district, probably never wholly ceased to be inhabited. This identification disposes of another which was accepted alike by the Jewish and Christian Aramaic versions of the Old Testament, and, passing from the Arameans to the Arabs, has given rise to the modern names Fountain and Wady of Moses (comp. Yâkût, iv. 879). According to these versions Rkâm, Rkâm, or more precisely Rkâm of Gaiâ (that is, Eljî), is Kadeah Barnea, where flowed the waters of Strife or "well of judgment" (Gen. xiv. 7; Num. xx. 1 *sq.*, xxvii. 14), where Moses struck the rock. This view is ably supported by Greene (*The Hebrew Migration from Egypt*); others identify Kadeah with 'Ain Kadis (Kudais) on the south border of Judæa.

Petra survived the fall of the Nabatæan kingdom, and indeed most of the buildings may be dated from the 2d and 3d centuries. It appears from coins that Hadrian took it into favour and gave it his name. But Palmyra absorbed its trade with the Persian Gulf, and long before Islam the great incense-route was deserted and left Petra, like the more southern Nabatæan city of Egra (Hijr), to fall into ruin. The ruins were an object of curiosity in the Middle Ages, and were visited by Sultan Bibars (Quatremère, *l.c.*). The first European to describe them was Burckhardt, and since his time they have often been visited. See the descriptions, plans, and views of Laborde and Linnart, *Arabia Petrea* (Paris, 1830-34); the Duc de Luynes, *Voyage d'exploration à la mer morte, &c.*, Paris,

<sup>1</sup> Arabia Petrea is not properly Stony Arabia, but the Arabia of which Petra is the centre—*ἡ κατὰ Πέτρας Ἀραβία* of Agathemerus.

<sup>2</sup> The rock-hewn city of Rakim (Istakhrî, 64; *Geogr. d'Abulf.*, Fr. tr., ii. 2, 5), which Schultens (*Ind. Geog. in Vûl. Sal.*) proposes to identify with Petra, is a different place, close to 'Amman (Mokaddas, p. 175).

*&c.*; Palmer, *Desert of the Exodus*, vol. ii., 1871; Stanley, *Sinai and Palestine*; Guérin, *Terræ Sanctæ*, 1832. (W. R. S.)

PETRARCH (1304-1374). Francesco Petrarca, eminent in the history of literature both as one of the four classical Italian poets and also as the first true reviver of learning in mediæval Europe, was born at Arezzo on 20th July 1304. His father Petracco held a post of notary in the Florentine Rolls Court of the Riformagioni; but, having espoused the same cause as Dante during the quarrels of the Blacks and Whites, Petracco was expelled from Florence by that decree of 27th January 1302 which condemned the poet of the *Divine Comedy* to lifelong exile. With his wife he took refuge in the Ghibelline township of Arezzo: and it was here, on the very night when his father, in company with other members of the White party, made an unsuccessful attempt to enter Florence by force, that Francesco first saw the light. He did not remain long in his birthplace. His mother, having obtained permission to return from banishment, settled at Incisa, a little village on the Arno above Florence, in February 1305. Here Petrarch spent seven years of boyhood, acquiring that pure Tuscan idiom which afterwards he used with such consummate mastery in ode and sonnet. Here too, in 1307, his brother Gherardo was born. In 1312 Petracco set up a house for his family at Pisa; but soon afterwards, finding no scope there for the exercise of his profession as jurist, he removed them all in 1313 to Avignon. This was a step of no small importance for the future poet-scholar. Avignon at that period still belonged to Provence, and owned King Robert of Naples as sovereign. But the popes had made it their residence after the insults offered to Boniface VIII at Anagni in 1303. Avignon was therefore the centre of that varied society which the high pontiffs of Christendom have ever gathered round them. Nowhere else could the youth of genius who was destined to impress a cosmopolitan stamp on mediæval culture and to begin the modern era have grown up under conditions more favourable to his task. At Incisa and at Pisa he had learned his mother-tongue. At Carpentras, under the direction of Convennole of Prato, he studied the humanities between the years 1315 and 1319. Avignon, at a distance from the party strife and somewhat parochial politics of the Italian commonwealths, impressed his mind with an ideal of civility raised far above provincial prejudices: What Petrarch lost in depth and intensity he gained in breadth and serenity by this exile's education. That disengagement from local circumstance which marks his patriotic theories, that conception of self-culture as an end in itself which distinguishes the humanism he inaugurated, were natural to a man who had no country, and who found the spiritual city of his studies and his aspirations in all quarters of the habitable globe.

Petrarch's real name, according to Tuscan usage, was Francesco di Petracco. But he altered this patronymic for the sake of euphony, to Petrarca, proving by this slight change his emancipation from usages which, had he dwelt at Florence, would most probably have been imposed on him. It does not appear that he was attached to either his father or his mother; and, though he loved his brother Gherardo dearly, we recognise in him that type of character for which the self-chosen ties of friendship are more thrilling than the piety of domestic affection. Petracco, who was very anxious that his eldest son should become an eminent jurist, sent him at the age of fifteen to study law at Montpellier. Like Ovid and many other poets, Petrarch felt no inclination for his father's profession. His intellect, indeed, was not incapable of understanding and admiring the majestic edifice of Roman law; but he shrank with disgust from the illiberal technicalities of practice. There is an authentic story of Petracco's slight

the young student's books of poetry and rhetoric upon the fire, but saving Virgil and Cicero half-burned from the flames at his son's passionate entreaties. Notwithstanding Petrarch's firm determination to make himself a scholar and a man of letters rather than a lawyer, he so far submitted to his father's wishes as to remove about the year 1323 to Bologna, which was then the headquarters of juristic learning. There he stayed with his brother Gherardo until 1326, when his father died, and he returned to Avignon. Banishment and change of place had already diminished Petrarch's fortune, which was never large; and a fraudulent administration of his estate after his death left the two heirs in almost complete destitution. The most precious remnant of Petrarch's inheritance was a MS. of Cicero. There remained no course open for him but to take orders. This he did at once on his arrival in Provence; and we have good reason to believe that he advanced in due time to the rank of priest. A great Roman noble and ecclesiastic, Giacomo Colonna, afterwards bishop of Lombes, now befriended him, and Petrarch lived for some years in partial dependence on this patron.

On the 6th of April 1327 happened the most famous event of Petrarch's history. He saw Laura for the first time in the church of St Clara at Avignon. Who Laura was remains uncertain still. That she was the daughter of Audibert de Noves and the wife of Hugh de Sade rests partly on tradition and partly on documents which the abbé de Sade professed to have copied from originals in the last century. Nothing is now extant to prove that, if this lady really existed, she was the Laura of the *Canzoniere*, while there are reasons for suspecting that the abbé was either the fabricator of a romance flattering to his own family, or the dupe of some previous impostor. We may, however, reject the sceptical hypothesis that Laura was a mere figment of Petrarch's fancy; and, if we accept her personal reality, the poems of her lover demonstrate that she was a married woman with whom he enjoyed a respectful and not very intimate friendship.

Petrarch's inner life after this date is mainly occupied with the passion which he celebrated in his Italian poems, and with the friendships which his Latin epistles dimly reveal to us. Besides the bishop of Lombes he was now on terms of intimacy with another member of the great Colonna family, the Cardinal Giovanni. A German, Ludwig, whom he called Socrates, and a Roman, Lello, who received from him the classic name of Lælius, were among his best-loved associates. He probably owed his livelihood to the generosity of prelates, with whom he played the courtier or the secretary; for we do not hear of his having occupied any benefice at this period. Avignon was the chief seat of his residence up to the year 1333, when he became restless, and undertook his first long journey. On this occasion he visited Paris, Ghent, Liège, Cologne, making the acquaintance of learned men and copying the manuscripts of classical authors. On his return to Avignon he engaged in public affairs, pleaded the cause of the Scaligers in their lawsuit with the Rossi for the lordship of Parma, and addressed two poetical epistles to Pope Benedict XII. upon the restoration of the papal see to Rome. His eloquence on behalf of the tyrants of Verona was successful. It won him the friendship of their ambassador, Azzo di Correggio,—a fact which subsequently influenced his life in no small measure. At the same time his treatment of the papal question made him pose as an Italian patriot clinging to the ideal of Rome as the sovereign city of civilization. Not very long after these events Petrarch made his first journey to Rome, a journey memorable from the account which he has left us of the impression he received from its ruins.

It was some time in the year 1337 that he established

himself at Vacluse and began that life of solitary study, heightened by communion with nature in her loneliest and wildest moods, which distinguished him in so remarkable a degree from the common herd of mediæval scholars. Here he spent his time partly among books, meditating on Roman history, and preparing himself for the Latin epic of *Africa*. In his hours of recreation he climbed the hills or traced the Sorgues from its fountain under those tall limestone cliffs, while odes and sonnets to Madonna Laura were committed from his memory to paper. We may also refer many of his most important treatises in prose, as well as a large portion of his Latin correspondence, to the leisure he enjoyed in this retreat. Some woman, unknown to us by name, made him the father of a son, Giovanni, in the year 1337; and she was probably the same who brought him a daughter, Francesca, in 1343. Both children were afterwards legitimized by papal bulls. Meanwhile his fame as a poet in the Latin and the vulgar tongues steadily increased, until, when the first draughts of the *Africa* began to circulate about the year 1339, it became manifest that no one had a better right to the laurel crown than Petrarch. A desire for glory was one of the most deeply-rooted passions of his nature, and one of the points in which he most strikingly anticipated the humanistic scholars who succeeded him. It is not, therefore, surprising to find that he exerted his influence in several quarters with the view to obtaining the honours of a public coronation. The result of his intrigues was that on a single day in 1340, the 1st of September, he received two invitations, from the university of Paris and from King Robert of Naples respectively. He chose to accept the latter, journeyed in February 1341 to Naples, was honourably entertained by the king, and, after some formal disputations on matters touching the poet's art, was sent with magnificent credentials to Rome. There, in the month of April, Petrarch assumed the poet's crown upon the Capitol from the hand of the Roman senator amid the plaudits of the people and the patricians. The oration which he delivered on this occasion was composed upon these words of Virgil:

"Sed me Parnasi deserta per ardua dulcis  
Raptat amor."

The theme was well chosen; and the ceremony, though we cannot but regard it with a somewhat pitying smile, was symbolical of much. According to mediæval conceptions, Rome, though abandoned by her emperor and pope, was still the mistress of the world; and the poet, who upon that April day uttered the passion for Parnassus which drew him through steep and desert regions, was destined to revive the arts and sciences in the midst of a barren age. The ancient and the modern eras met together on the Capitol at Petrarch's coronation, and a new stadium for the human spirit, that which we are wont to style Renaissance, was opened.

With the coronation in Rome a fresh chapter in the biography of Petrarch may be said to have begun. Henceforth he ranked as a rhetorician and a poet of European celebrity, the guest of princes, and the ambassador to royal courts. During the spring months of 1341 his friend Azzo di Correggio had succeeded in freeing Parma from subjugation to the Scaligers, and was laying the foundations of his own tyranny in that city. He invited Petrarch to attend him when he made his triumphal entry at the end of May; and from this time forward for a considerable period Parma and Vacluse were the two headquarters of the poet. The one he called his transalpine, the other his cisalpine Parnassus. The events of the next six years of his life, from May 1341 to May 1347, may be briefly recapitulated. He lost his old friend the bishop of Lombes by death and his brother Gherardo by the entrance of the latter into a Carthusian monastery. Various

small benefices were conferred upon him; and repeated offers of a papal secretaryship, which would have raised him to the highest dignities, were made and rejected. Petrarck remained true to the instinct of his own vocation, and had no intention of sacrificing his studies and his glory to ecclesiastical ambition. In January 1343 his old friend and patron Robert, king of Naples, died, and Petrarck was sent on an embassy from the papal court to his successor João. The notices which he has left us of Neapolitan society at this epoch are interesting, and it was now, perhaps, that he met Boccaccio for the first time. The beginning of the year 1345 was marked by an event more interesting in the scholar's eyes than any change in dynasties. This was no less than a discovery at Verona of Cicero's *Familiar Letters*. It is much to be regretted that Petrarck found the precious MS. so late in life, when the style of his own epistles had been already modelled upon that of Seneca and St Augustine. No one, not even Erasmus, would have profited more by the study of those epistolary masterpieces, or would have been better able to imitate their point and ease of diction, had he become acquainted with them at an earlier period.

In the month of May 1347 Cola di Rienzi accomplished that extraordinary revolution which for a short space revived the republic in Rome, and raised this enthusiast to titular equality with kings. Petrarck, who in politics was no less visionary than Rienzi, hailed the advent of a founder and deliverer in the self-styled tribune. Without considering the impossibility of restoring the majesty of ancient Rome, or the absurdity of dignifying the mediæval Roman rabble by the name of *Populus Romanus*, he threw himself with passion into the republican movement, and sacrificed his old friends of the Colonna family to what he judged a patriotic duty. To follow the meteoric course of Rienzi through those months of mock supremacy, exile, and imprisonment at Avignon does not concern Petrarck's biographer. It will be enough to say that the poet contented himself with writing a rhetorical exhortation to the Roman people on the occasion of the tribune's downfall, giving vent, as usual, through eloquence to emotions which men of more practical character strove to express in act.

Petrarck built himself a house at Parma in the autumn of 1347. Here he hoped to pursue the tranquil avocations of a poet honoured by men of the world and men of letters throughout Europe, and of an idealistic politician, whose effusions on the questions of the day were read with pleasure for their style. But in the course of the next two years this agreeable prospect was overclouded by a series of calamities. Laura died of the plague on the 8th April 1348. Francesco degli Albizzi, Mainardo Accursio, Roberto de' Bardi, Sennucio del Bene, Luchino Visconti, the cardinal Giovanni Colonna, and several other friends followed to the grave in rapid succession. All of these had been intimate acquaintances and correspondents of the poet. Friendship with him was a passion; or, what is more true perhaps, he needed friends for the maintenance of his intellectual activity at the highest point of its effectiveness. Therefore he felt the loss of these men acutely. We may say with certainty that Laura's death, accompanied by that of so many distinguished associates, was the turning-point in Petrarck's inner life. He began to think of quitting the world, and pondered a plan for establishing a kind of humanistic convent, where he might dedicate himself, in the company of kindred spirits, to still severer studies and a closer communion with God. Though nothing came of this scheme, a marked change was henceforth perceptible in Petrarck's literary compositions. The poems written *In Morte di Madonna Laura* are graver and of more religious tone. The prose works touch on retrospective topics or deal with subjects of deep meditation. At the

same time his renown, continually spreading, opened to him ever fresh relations with Italian despots. The noble houses of Gonzaga at Mantua, of Carrara at Padua, of Este at Ferrara, of Malatesta at Rimini, of Visconti at Milan, vied with Azzo di Correggio in entertaining the illustrious man of letters. It was in vain that his correspondents pointed out the discrepancy between his professed zeal for Italian liberties, his recent enthusiasm for the Roman republic, and this alliance with tyrants who were destroying the freedom of the Lombard cities. Petrarck remained an incurable rhetorician; and, while he stigmatized the despot in his ode to Italy and in his epistles to the emperor, he accepted their hospitality. They, on their part, seem to have understood his temperament, and to have agreed to recognize his political theories as of no practical importance. The tendency to honour men of letters and to patronize the arts which distinguished Italian princes throughout the Renaissance period first manifested itself in the attitude assumed by Visconti and Carrara to Petrarck.

When the jubilee of 1350 was proclaimed, Petrarck made a pilgrimage to Rome, passing and returning through Florence, where he established a firm friendship with Boccaccio. It has been well remarked that, while all his other friendships are shadowy and dim, this one alone stands out with clearness. Each of the two friends had a distinguished personality. Each played a foremost part in the revival of learning. Boccaccio carried his admiration for Petrarck to the point of worship. Petrarck repaid him with sympathy, counsel in literary studies, and moral support which helped to elevate and purify the younger poet's over-sensuous nature. It was Boccaccio who in the spring of 1351 brought to Petrarck, then resident with the Carrara family at Padua, an invitation from the seignior of Florence to accept the rectorship of their recently-founded university. This was accompanied by a diploma of restoration to his rights as citizen and restitution of his patrimony. But, flattering as was the offer, Petrarck declined it. He preferred his literary leisure at Vaucluse, at Parma, in the courts of princes, to a post which would have brought him into contact with jealous priors and have reduced him to the position of the servant of a commonwealth. Accordingly, we find him journeying again in 1351 to Vaucluse, again refusing the office of papal secretary, again planning visionary reforms for the Roman people, and beginning that curious fragment of an autobiography which is known as the *Epistle to Posterity*. Early in 1353 he left Avignon for the last time, and entered Lombardy by the pass of Mont Genève, making his way immediately to Milan. The archbishop Giovanni Visconti was at this period virtually despot of Milan. He induced Petrarck, who had long been a friend of the Visconti family, to establish himself at his court, where he found employment for him as ambassador and orator. The most memorable of his diplomatic missions was to Venice in the autumn of 1353. Towards the close of the long struggle between Genoa and the republic of St Mark the Genoese entreated Giovanni Visconti to mediate on their behalf with the Venetians. Petrarck was entrusted with the office; and on 8th November he delivered a studied oration before the doge Andrea Dandolo and the great council. His eloquence had no effect; but the orator entered into relations with the Venetian aristocracy which were afterwards extended and confirmed. Meanwhile, Milan continued to be his place of residence. After Giovanni's death he remained in the court of Bernabò and Galeazzo Visconti, closing his eyes to their cruelties and exactions, serving them as a diplomatist, making speeches for them on ceremonial occasions, and partaking of the splendid hospitality they offered to emperors and princes. It was in this capacity of an independent man of letters,

highly placed and favoured at one of the most wealthy courts of Europe, that he addressed epistles to the emperor Charles IV. upon the distracted state of Italy, and entreated him to resume the old Ghibelline policy of imperial interference. Charles IV. passed through Mantua in the autumn of 1354. There Petrarch made his acquaintance, and, finding him a man unfit for any noble enterprise, declined attending him to Roma. When Charles returned to Germany, after assuming the crowns in Rome and Milan, Petrarch addressed a letter of vehement invective and reproach to the emperor who was so negligent of the duties imposed on him by his high office. This did not prevent the Visconti sending him on an embassy to Charles in 1356. Petrarch found him at Prague, and, after pleading the cause of his masters, was despatched with honour and the diploma of count palatine. His student's life at Milan was again interrupted in 1360 by a mission on which Galeazzo Visconti sent him to King John of France. The tyrants of Milan were aspiring to royal alliances; Gian Galeazzo Visconti had been married to Isabella of France; Violante Visconti, a few years later, was wedded to the English duke of Clarence. Petrarch was now commissioned to congratulate King John upon his liberation from captivity in England. This duty performed, he returned to Milan, where in 1361 he received news of the deaths of his son Giovanni and his old friend Socrates. Both had been carried off by plague.

The remaining years of Petrarch's life, important as they were for the furtherance of humanistic studies, may be briefly condensed. On 11th May 1362 he settled at Padua, from the neighbourhood of which he never moved again to any great distance. The same year saw him at Venice, making a donation of his library to the republic of St Mark. Here his friend Boccaccio introduced to him the Greek teacher Leontius Pilatus. Petrarch, who possessed a MS. of Homer and a portion of Plato, never acquired the Greek language, although he attempted to gain some little knowledge of it in his later years. Homer, he said, was dumb to him, while he was deaf to Homer; and he could only approach the *Iliad* in Boccaccio's rude Latin version. About this period he saw his daughter Francesca happily married, and undertook the education of a young scholar from Ravenna, whose sudden disappearance from his household caused him the deepest grief. This youth has been identified, but on insufficient grounds, with that Giovanni Malpaghini of Ravenna who was destined to form a most important link between Petrarch and the humanists of the next age of culture. The public affairs of Italy and Europe continued to interest him; nor was he ever idle in composing letters and orations, some of which were not without political importance, while all of them contributed to form a style that had the greatest influence over successive generations of Italian chancellors and secretaries. Gradually his oldest friends dropped off. Azzo di Correggio died in 1362, and Lælius, Simonides, Barbato, in the following year. His own death was reported in 1365; but he survived another decade. Much of this last stage of his life was occupied at Padua in a controversy with the Averroists, whom he regarded as dangerous antagonists both to sound religion and to sound culture. A curious treatise, which grew in part out of this dispute and out of a previous duel with physicians, was the book *Upon his own Ignorance and that of many others*. At last, in 1369, tired with the bustle of a town so big as Padua, he retired to Arquà, a village in the Euganean hills, where he continued his usual train of literary occupations, employing several secretaries, and studying unremittingly. All through these declining years his friendship with Boccaccio was maintained and strengthened. It rested on a solid basis of mutual affection and of common studies, the

different temperaments of the two scholars securing them against the disagreements of rivalry or jealousy. One of Petrarch's last compositions was a Latin version of Boccaccio's story of Griselda. On 18th July 1374 his people found the old poet and scholar dead among his books in the library of that little house which looks across the hills and lowlands toward the Adriatic.

When we attempt to estimate Petrarch's position in the history of modern culture, the first thing which strikes us is that he was even less eminent as an Italian poet than as the founder of Humanism, the inaugurator of the Renaissance in Italy. What he achieved for the modern world was not merely to bequeath to his Italian imitators masterpieces of lyrical art unrivalled for perfection of workmanship, but also, and far more, to open out for Europe a new sphere of mental activity. Standing within the threshold of the Middle Ages, he surveyed the kingdom of the modern spirit, and, by his own inexhaustible industry in the field of scholarship and study, he determined what we call the revival of learning. By bringing the men of his own generation into sympathetic contact with antiquity, he gave a decisive impulse to that European movement which restored freedom, self-consciousness, and the faculty of progress to the human intellect. The warm recognition which he met with in his lifetime and the extraordinary activity of his immediate successors prove indeed that the age itself was ripe for this momentous change. Yet it is none the less certain that Petrarch stamped his genius on the spirit of the time, that he was the hero of the humanistic effort. He was the first man to collect libraries, to accumulate coins, to advocate the preservation of antique monuments, and to collate MSS. Though he knew no Greek, he was the first to appreciate its vast importance; and through his influence Boccaccio laid the earliest foundations of its study. More than this, he was the first to approach the great authors of antiquity with intelligence. It was not the extent but the lucidity of his erudition, not the matter but the spirit of his scholarship, that placed him at an immeasurable distance of superiority above his predecessors. When we compare the use which even Dante made of classical knowledge in his *De Monarchia* with Petrarch's touch upon the ancients in his numerous prose works, we perceive that we have passed from the mediæval to the modern conception of literature. For him the authors of the Greek and Latin world were living men,—more real, in fact, than those with whom he corresponded; and the rhetorical epistles he addressed to Cicero, Seneca, and Varro prove that he dwelt with them on terms of sympathetic intimacy. So far-reaching were the interests controlled by him in this capacity of humanist that his achievement as an Italian lyricist seems by comparison insignificant.

Petrarch's ideal of humanism was essentially a noble one. He regarded the orator and the poet as teachers, bound to complete themselves by education, and to exhibit to the world an image of perfected personality in prose and verse of studied beauty. Self-culture and self-effectuation seemed to him the highest aims of man. Everything which contributed to the formation of a free, impassioned, liberal individuality he regarded as praiseworthy. Everything which retarded the attainment of that end was contemptible in his eyes. The authors of antiquity, the Holy Scriptures, and the fathers of the church were valued by him as one common source of intellectual enlightenment. Eminently religious, and orthodox in his convictions, he did not seek to substitute a pagan for the Christian ideal. This was left for the scholars of the 15th and 16th centuries in Italy. At the same time, the Latin orators, historians, and poets were venerated by him as depositaries of a tradition only second in importance to revelation. For

him there was no schism between Rome and Galilee, between classical genius and sacred inspiration. Though the latter took the first rank in relation to man's eternal welfare, the former was necessary for the perfection of his intellect and the civilization of his manners. With this double ideal in view, Petrarch poured scorn upon the French physicians and the Italian Averroists for their illiberal philistinism, no less than for their materialistic impiety. True to his conception of independent intellectual activity, he abstained from a legal career, refused important ecclesiastical office, and contented himself with paltry benefices which implied no spiritual or administrative duties, because he was resolved to follow the one purpose of his life,—self-culture. Whatever in literature revealed the hearts of men was infinitely precious to him; and for this reason he professed almost a cult for St Augustine. It was to Augustine, as to a friend or a confessor, that he poured forth the secrets of his own soul in the book *De Contemptu Mundi*.

In this effort to realize his truest self Petrarch was eminently successful. Much as he effected by restoring to the world a sound conception of learning, and by rousing that genuine love and curiosity which led to the revival, he did even more by impressing on the age his own full-formed and striking personality. In all things he was original. Whether we regard him as a priest who published poem after poem in praise of an adored mistress, as a plebeian man of letters who conversed on equal terms with kings and princes, as a solitary dedicated to the love of nature, as an amateur diplomatist treating affairs of state with pompous eloquence in missives sent to popes and emperors, or again as a traveller eager for change of scene, ready to climb mountains for the enjoyment of broad prospects over spreading champaigns; in all these diverse manifestations of his peculiar genius we trace some contrast with the manners of the 14th century, some emphatic anticipation of the 16th. The defects of Petrarch's character were no less striking than its qualities, and were indeed their complement and counterpart. That vivid conception of intellectual and moral self-culture which determined his ideal took the form in actual life of all-absorbing egotism. He was not content with knowing himself to be the leader of the age. He claimed autocracy, suffered no rival near his throne, brooked no contradiction, demanded unconditional submission to his will and judgment. His friends were treated by him as subordinates and vassals with exacting magnanimity. The preoccupation with himself, which makes his letters and prose treatises a mine of autobiographical information, rouses a certain contempt when we watch it degenerating into vanity, appetite for flattery, intrigues for the poet's crown, restless change from place to place in search of new admirers, desire for ceremonial pomp, and half-concealed detraction of superior genius. Petrarch was made up of contradictions. Praising solitude, playing the hermit at Vauluse, he only loved seclusion as a contrast to the society of courts; while he penned dissertations on the futility of fame and the burden of celebrity, he was trimming his sails to catch the breeze of popular applause. No one professed a more austere morality, and few mediæval writers indulged in cruder satire on the female sex; yet he passed some years in the society of a concubine, and his living masterpiece of art is the apotheosis of chivalrous passion for a woman. These discords of an undecided nature displayed themselves in his political theories and in his philosophy of conduct. In one mood he was fain to ape the antique patriot; in another he affected the monastic saint. He was clamorous for the freedom of the Roman people; yet at one time he called upon the popes to re-establish themselves in the Eternal City; at another he besought the emperor to make it his

headquarters; at a third he hailed in Rienzi the founder of a new republic. He did not perceive that all these plans were incompatible. His relations to the Lombard nobles were equally at variance with his professed patriotism; and, while still a housemate of Visconti and Correggi, he kept on issuing invectives against the tyrants who divided Italy. It would not be difficult to multiply these antitheses in the character and the opinions of this singular man. But it is more to the purpose to remark that they were harmonised in a personality of potent and enduring force. Petrarch was essentially the first of the moderns, the ancestor of Hamlet and Faust, Rousseau and Childe Harold. That strange spirit of unrest and melancholy, of malady and isolation, which drove him from time to time into the desert, where he sought companionship with the great writers of the past, was the inner witness to an irresolvable contradiction between himself and the age in which he lived.

The point to notice in this complex personality is that Petrarch's ideal remained always literary. As philosopher, politician, historian, essayist, orator, he aimed at lucid and harmonious expression,—not, indeed, neglecting the importance of the material he undertook to treat, but approaching his task in the spirit of an artist rather than a thinker or a man of action. This accounts for his bewildering versatility, and for his apparent want of grasp on conditions of fact. Viewed in this light Petrarch anticipated the Italian Renaissance in its weakness,—that philosophical superficiality, that tendency to ornate rhetoric, that preoccupation with stylistic trifles, that want of profound conviction and stern sincerity, which stamp its minor literary products with the note of mediocrity. Had Petrarch been possessed with a passion for some commanding principle in politics, morality, or science, instead of with the thirst for self-glorification and the ideal of artistic culture, it is not wholly impossible that Italian humanism might have assumed a manlier and more conscientious tone. But this is not a question which admits of discussion; for the conditions which made Petrarch what he was were already potent in Italian society. He did but express the spirit of the period he opened; and it may also be added that his own ideal was higher and severer than that of the illustrious humanists who followed him.

As an author Petrarch must be considered from two points of view,—first as a writer of Latin verse and prose, secondly as an Italian lyricist. In the former capacity he was speedily outstripped by more fortunate scholars. His eclogues and epistles and the epic of *Africa*, on which he set such store, exhibit a comparatively limited command of Latin metre. His treatises, orations, and familiar letters, though remarkable for a prose style which is eminently characteristic of the man, are not distinguished by purity of diction. Much as he admired Cicero, it is clear that he had not freed himself from current mediæval Latinity. Seneca and Augustine had been too much used by him as models of composition. At the same time it will be conceded that he possessed a copious vocabulary, a fine ear for cadence, and the faculty of expressing every shade of thought or feeling. What he lacked was that insight into the best classical masterpieces, that command of the best classical diction, which is the product of successive generations of scholarship. To attain to this, Giovanni da Ravenna, Colluccio Salutato, Poggio, and Filelfo had to labour, before a Poliziano and a Bembo finally prepared the path for an Erasmus. Had Petrarch been born at the close of the 15th instead of at the opening of the 14th century there is no doubt that his Latinity would have been as pure, as versatile, and as pointed as that of the witty stylist of Rotterdam.

With regard to his Italian poetry Petrarch occupies a



very different position. The *Rime in Vita e Morte di Madonna Laura* cannot become obsolete, for perfect metrical form has here been married to language of the choicest and the purest. It is true that even in the *Canzoniere*, as Italians prefer to call that collection of lyrics, Petrarch is not devoid of faults belonging to his age, and affectations which have imposed themselves with disastrous effect through his authority upon the literature of Europe. He appealed in his odes and sonnets to a restricted audience already educated by the chivalrous love-poetry of Provence and by Italian imitations of that style. He was not careful to exclude the commonplaces of the school, nor anxious to finish a work of art wholly free from fashionable graces and from contemporary conceits. There is therefore a certain element of artificiality in his treatment; and this, since it is easier to copy defects than excellencies, has been perpetuated with wearisome monotony by versifiers who chose him for their model. But, after making due allowance for peculiarities, the abuse of which has brought the name of Petrarchist into contempt, we can agree with Shelley that the lyrics of the *Canzoniere* "are as spells which unseal the inmost enchanted fountains of the delight which is the grief of love." That is to say, Petrarch in this monumental series of odes and sonnets depicted all the mood of a real passion, and presented them in a style of such lucidity, with so exquisite a command of rhythmical resources, and with humanity of emotion so simple and so true, as to render his portrait of a lover's soul applicable to all who have loved and will love for ages. If space sufficed much might be written about the peculiar position held by Petrarch between the metaphysical lyrists of Tuscany and the more realistic amorists of succeeding generations. True in this respect also to his anticipation of the coming age, he was the first Italian poet of love to free himself from allegory and mysticism. Yet he was far from approaching the analysis of emotion with the directness of a Heine or De Musset. Though we believe in the reality of Laura, we derive no clear conception either of her person or her character. She is not so much a woman as woman in the abstract; and perhaps on this very account the poems written for her by her lover have been taken to the heart by countless lovers who came after him. The method of his art is so generalizing, while his feeling is so natural, that every man can see himself reflected in the singer and his mistress shadowed forth in Laura. The same criticism might be passed on Petrarch's descriptions of nature. That he felt the beauties of nature keenly is certain, and he frequently touches them with obvious appreciation. Yet he has written nothing so characteristic of Valcluse as to be inapplicable to any solitude where there are woods and water. The *Canzoniere* is therefore one long melodious monody poured from the poet's soul, with the indefinite form of a beautiful woman seated in a lovely landscape, a perpetual object of delightful contemplation. This disengagement from local circumstance without the sacrifice of emotional sincerity is a merit in Petrarch, but it became a fault in his imitators. Lacking his intensity of passion and his admirable faculty for seizing the most evanescent shades of difference in feeling, they degenerated into colourless and lifeless insipidities made insupportable by the frigid repetition of tropes and conceits which we are fain to pardon in the master.

Petrarch did not distinguish himself by love-poetry alone in the Italian language. His odes to Giacomo Colonna, to Cola di Rienzi, and to the princes of Italy display him in another light. They exhibit the oratorical fervour, the pleader's eloquence in its most perfect lustre, which Petrarch possessed in no less measure than subjective passion. Modern literature has nothing nobler, nothing more

harmonious in the declamatory style than these three patriotic effusions. Their spirit itself is epoch-making in the history of Europe. Up to this point Italy had scarcely begun to exist. There were Florentines and Lombards, Guelfs and Ghibellines; but even Dante had scarcely conceived of Italy as a nation, independent of the empire, inclusive of her several component commonwealths. To the high conception of Italian nationality, to the belief in that spiritual unity which underlay her many discords and divisions, Petrarch attained partly through his disengagement from civic and local partisanship, partly through his large and liberal ideal of culture. It was the function of the Renaissance to bring all parts of the Italian peninsula into an intellectual harmony by means of common enthusiasm for arts and letters. But it remained for the present century to witness the political consolidation of the Italian people under a single government.

The materials for a life of Petrarch are afforded in abundance by his letters, collected and prepared for publication under his own eyes. These are divided into *Familiar Correspondence*, *Correspondence in Old Age*, *Diverse Letters*, and *Letters without a Title*; to which may be added the curious autobiographical fragment entitled the *Epistle to Posterity*. Next in importance rank the epistles and eclogues in Latin verse, the Italian poems, and the rhetorical addresses to popes, emperors, Cola di Rienzi, and some great men of antiquity. For the comprehension of his character the treatise *De Contemptu Mundi*, addressed to St Augustine and styled his Secret, is invaluable. Without attempting a complete list of Petrarch's works, it may be well to illustrate the extent of his erudition and his activity as a writer by a brief enumeration of the most important. In the section belonging to moral philosophy we find *De Remedii Utriusque Fortunae*, a treatise on human happiness and unhappiness; *De Vita Solitaria*, a paenegyric of solitude; *De Otio Religiosorum*, a similar essay on monastic life, inspired by a visit to his brother Gherardo in his convent near Marseilles. On historical subjects the most considerable are *Rerum Memorandarum Libri*, a miscellany from a student's commonplace-book, and *De Viris Illustribus*, an epitome of the biographies of Roman worthies. Three polemical works require mention: *Contra cujusdam anonymi Galli calumnias Apologia*, *Contra Medicum quendam Invektivarum Libri*, and *De sui ipsius et multorum Ignorantia*,—controversial and sarcastic compositions, which grew out of Petrarch's quarrels with the physicians of Avignon and the Averroists of Padua. In this connexion it might also be well to mention the remarkable satires on the papal court, included in the *Epistole sine Titulo*. Five public orations have been preserved, the most weighty of which, in explanation of Petrarch's conception of literature, is the speech delivered on the Capitol upon the occasion of his coronation. Among his Latin poems *Africa*, an epic on Scipio Africanus, takes the first place. Twelve *Eclogues* and three books of *Epistles* in verse close the list. In Italian we possess the *Canzoniere*, which includes odes and sonnets written for Laura during her lifetime, those written for her after her death, and a miscellaneous section containing the three patriotic odes and three famous poetical invectives against the papal court. Besides these lyrical compositions are the semi-epical or allegorical *Trionfi*,—Triumphs of Love, Chastity, Death, Fame, Time, and Divinity, written in terza rima of smooth and limpid quality. Though these Triumphs, as a whole, are deficient in poetic inspiration, the second canto of the *Trionfo della Morte*, in which Petrarch describes a vision of his dead love Laura, is justly famous for reserved passion and pathos tempered to a tranquil harmony.

The complete bibliography of Petrarch forms a considerable volume. Such a work was attempted by Domenico Rossetti (Trieste, 1859). It will be enough here to mention the Basel edition of 1561, in folio, as the basis for all subsequent editions of his collected works. Two editions of the *Canzoniere* deserve special notice,—that of Marsand (Padua, 1820) and that of Leopardi in Le Monnier's collection. Nor must Fracassetti's Italian version of the *Letters* (published in 5 vols. by Le Monnier) be neglected. De Sade's *L'A* of the poet (Amsterdam, 1764-67) marks an epoch in the history of his numerous biographies; but this is in many important points untrustworthy, and it has been superseded by Gustav Koerting's exhaustive volume on *Petrarch's Leben und Werke* (Leipzig, 1875). Georg Voigt's *Wiederbelebung des classischen Alterthums* (Berlin, 1859) contains a well-estimated estimate of Petrarch's relation to the revival of learning. Masini's *Petrarchus* (1868) is a monograph of merit. English readers may be referred to a little book on Petrarch by Henry Reeve, and to vols. II. and IV. of Symonds's *Renascence in Italy*. (J. A. S.)

PETREL, the name applied in a general way to a group of Birds (of which more than 100 species are recognized) from the habit which some of them possess of apparently walking on the surface of the water as the apostle St Peter (of whose name the word is a diminutive form) is recorded (Matt. xiv. 29) to have done. For a long while the Petrels were ranked as a Family, under the name of *Procell-*

*arida*,<sup>1</sup> and thought to be either very nearly allied to the Gulls, *Laridæ*, or intermediate between that Family and the *Steganopodes*; but this opinion has gradually given way, and it is now hard to resist the conclusion that they and to be regarded as an "Order," to which the name *Tubinæres* has been applied from the tubular form of their nostrils, a feature possessed in greater or less degree by all of them, and by which each may at a glance be recognized. They have usually been subdivided into three groups or Sub-families, (1) *Pelecanoidinæ* (or *Halodrominæ*), containing some three or four species known as Diving-Petrels, with habits very different from others of the Family, and almost peculiar to high southern latitudes from Cape Horn to New Zealand; (2) *Procellariinæ*, or Petrels proper; and (3) *Diomedeinæ*, or Albatrosses (cf. MALLEMUCK, vol. xv. p. 334). Recently, however, the anatomy of the group has been subjected to very close examination by Garrod and W. A. Forbes, the latter of whom has summed up the results obtained by himself and his predecessor in an elaborate essay, forming part ix. of the *Zoology of the voyage of the "Challenger,"* which show determinations that differ greatly from any that had been reached by prior systematists. According to these investigators, the *Tubinæres* are composed of two Families, *Procellariidæ* and *Oceanitidæ*, whose distinctness had never before been suspected<sup>2</sup>—the latter consisting of four genera not very much differing in appearance from many others, while the former includes as Subfamilies the Albatrosses, *Diomedeinæ*, with three genera, *Diomedea*, *Thalassiarache*, and *Phaebetria*, and the true Petrels, *Procellariinæ*, in which last are combined forms so different externally and in habit as the Diving-Petrels, above noticed, the Storm-Petrels, *Procellaria*, the Flat-billed Petrels, *Prion*, the FULMAR (vol. ix. p. 817), the SHEARWATERS (*q.v.*), and others. Want of space forbids us here dwelling on the characters assigned to these different groups, or the means which have led to this classification of it, set forth at great length in the essay cited, where also will be found copious references to previous studies of the Petrels, among which may here be especially mentioned those of MM. Hombron and Jacquinot (*Comptes Rendus*, 1844, pp. 353-358, and *Zool. Voy. au Pol Sud*, vol. iii.), Prof. Coues (*Proc. Acad. Philadelphia*, 1864, pp. 72-91, 116-144, and 1866, pp. 25-33, 134-137), and Mr Salvin (*Orn. Miscellany*, ii. pp. 223-238, 249-257; and *Zoology, Voy. "Challenger,"* pt. viii. pp. 140-149).

Petrels are dispersed throughout all the seas and oceans of the world, and some species apparently never resort to land except for the purpose of nidification, though nearly all are liable at times to be driven ashore, and often very far inland, by gales of wind.<sup>3</sup> It would also seem that during the breeding-season many of them are wholly nocturnal in their habits, passing the day in holes of the ground, or in clefts of the rocks, in which they generally nestle, the hen of each pair laying a single white egg, sparsely speckled in a few species with fine reddish dots. Of those species that frequent the North Atlantic, the common Storm-Petrel, *Procellaria pelagica*, a little bird which has to the ordinary eye rather the look of a Swift or Swallow, is the "Mother Carey's chicken" of sailors, and is widely believed to be the harbinger of bad weather; but seamen hardly discriminate between this and others nearly resembling it in appearance, such as Leach's or the

Fork-tailed Petrel, *Oymochorea leucorrhoa*, a rather larger but less common bird, and Wilson's Petrel, *Oceanites oceanicus*, the type of the Family *Oceanitidæ* mentioned above, which is more common on the American side. But it is in the Southern Ocean that Petrels most abound, both as species and as individuals. The Cape-Pigeon or Pintado Petrel, *Daption capense*, is one that has long been well known to mariners and other wayfarers on the great waters, while those who voyage to or from Australia, whatever be the route they take, are certain to meet with many more species, some, as *Oasifraga gigantea*, as large as Albatrosses, and several of them called by sailors by a variety of choice names, generally having reference to the strong smell of musk emitted by the birds, among which that of "Stink-pot" is not the most opprobrious. None of the Petrels are endowed with any brilliant colouring—sooty-black, grey of various tints (one of which is often called "blue"), and white being the only hues their plumage exhibits; but their graceful flight, and their companionship when no other life is visible around a lonely vessel on the widest of oceans, give them an interest to beholders, though this is too often marred by the wanton destruction dealt out by brutal or thoughtless persons who thus seek to break the tediousness of a long voyage. The distribution of the several species of Petrels in the Southern Ocean has been ably treated by Prof. A. Milne-Edwards in the *Annales des Sciences Naturelles* for 1882 (ser. 6, *Zoologie*, vol. xiii. art. 4, pp. 1-22), of which essay a translation will be found in the *Mittheilungen des Ornithologischen Vereins in Wien* for 1884. (A. N.)

PETRIE, GEORGE (1790-1866), Irish antiquary, was the son of James Petrie, a native of Aberdeen, who had settled in Dublin as a portrait and miniature painter. He was born in Dublin in January 1790, and was educated to become a painter. Besides attaining considerable reputation as a landscape painter of Irish scenes, he devoted much of his artistic skill to the illustration of the antiquities of the country. Even in boyhood his love of archaeology vied with his love of art and of nature. In 1828 he was appointed to conduct the antiquarian and historical section of the Ordnance Survey of Ireland, but this department of the work was not persevered in by the Government. In 1832 he became editor of the *Dublin Penny Journal*, a periodical designed to disseminate information among the masses, to which he contributed numerous articles on the history of the fine arts in Ireland. Petrie may be regarded as the first scientific investigator of Irish archaeology, his contributions to which are also in themselves of prime importance. His *Essay on Round Towers*, for which in 1830 he received the prize of the Irish Academy, must still rank, whether or not his opinion be accepted that the round towers served the joint purpose of belfries and fortalices, as the standard work on the subject. A second edition was published in 1845. Among his other more important contributions to Irish archaeology are his *Essay on the Military Architecture of Ireland* and his *History and Antiquities of Tara Hill*. In 1847 he received the degree of LL.D. from the university of Dublin, and in 1849 he was placed on the civil list for an annual pension of £300. He died 17th January 1866.

See the *Life and Labours in Art and Archaeology of George Petrie*, by William Stokes, 1868.

PETROLEUM. The word "petroleum" (*rock-oil*; Germ., *erdöl*, *steinöl*) is used to designate the forms of bitumen that are of an oily consistence. It passes by insensible gradations into the volatile and ethereal naphthas on the one hand and the semi-fluid malthas or mineral-tars on the other.

History.—Petroleum has been known by civilized man

<sup>1</sup> Most commonly but erroneously spelt *Procellariidæ*.

<sup>2</sup> It is due to Prof. Coues to state that in 1864 he had declared the genus *Oceanites*, of which he only knew the external characters, to be "the most distinct and remarkable" of the "*Procellariinæ*," though he never thought of making it the type of a separate Family.

<sup>3</sup> Thus *Estrelata hirsuta*, the Capped Petrel, a species whose proper home seems to be Guadeloupe and some of the neighbouring West-Indian Islands, has occurred in the State of New York near Boulogne, in Norfolk, and in Hungary (*Ibis*, 1884, p. 202)!

from the dawn of history. Herodotus wrote of the springs of Zacynthus (Zante), and the fountains of Hit have been celebrated by the Arabs and Persians. Pliny and Dioscorides describe the oil of Agrigentum, which was used in lamps under the name of "Sicilian oil," and mention is made of petroleum springs in China in the earliest records of that ancient people. The abundance of petroleum and the fire-temple at Baku on the Caspian have been frequently described by travellers who have gone overland from Europe to India, from the time of Marco Polo to recent years. Petroleum in North America was first mentioned by a Franciscan missionary, Joseph de la Roche d'Allion, in a letter written in 1629 and published in Sagard's *Histoire du Canada* in 1636. Peter Kalm described the springs on Oil Creek in his book of travels in North America, published in London in 1772. In 1760 the French commander at Fort Duquesne described them in a letter to General Montcalm, and later, towards the close of the last century, frequent mention is made of oil-springs in correspondence relating to what is now western Pennsylvania, Ohio, West Virginia, and Kentucky. In 1765 and 1826 the British Government sent embassies to the court of Ava, in the reports of which mention is made of the petroleum springs and wells near Rangoon on the Irawadi. During the early years of the present century the occurrence of bitumen, and particularly of its liquid forms, was noticed by scientific men and travellers in various localities. In Europe, Boussingault's researches upon the petroleum of Bechelbronn (Lower Alsace) and the discovery of paraffin by Reichenbach attracted much attention. Petroleum was observed and described as early as 1814 in Washington county, Ohio, in wells at that time being bored for brine. In 1819 a well bored for brine in Wayne county, Kentucky, yielded so much black petroleum that it was abandoned. It has continued to yield small quantities until the present time. In 1829 a well drilled for brine near Burkesville, Cumberland county, Kentucky, yielded such a flow of petroleum that it was regarded as a wonderful natural phenomenon. This well is estimated to have yielded, up to 1860, 50,000 barrels of oil, the larger part of which was wasted. Of the rest a few barrels were bottled and sold as a liniment in the United States and Europe under the name of "American oil."

About the year 1847 E. W. Binney of Manchester, England, called attention to the petroleum discovered at Riddinga, near Alfreton in Derbyshire, and a few years later he, together with James Young and others, commenced the manufacture of illuminating and other oils from it. The supply of crude material from this source soon became inadequate, and they then commenced distilling the Boghead mineral that had been found near Bathgate in Scotland. The success attending this enterprise soon attracted attention in the United States of America, and a number of establishments were in operation in the course of a few years, some of them being licensed under Young's patents. In 1851, when petroleum on Oil Creek was worth 75 cents a gallon in the crude state, it was tested as a crude material for the manufacture of illuminating oil by Messrs William and Luther Attwood, and Joshua Merrill, at the United States Chemical Manufacturing Company's works at Waltham, near Boston, Massachusetts, and its merits for that purpose fully established. But its scarcity at that time prevented its use in commercial quantities, and the establishments at Boston and Portland, Maine, under the charge of Messrs Merrill and William Attwood, continued to use Boghead mineral and albertite for a number of years after petroleum was produced in sufficient quantity. Petroleum was refined and offered for sale in Pittsburgh, Pennsylvania, as early as 1855, but the quantity was too small to influence even the local trade; it, however, created a small demand for the

crude oil. The well-known fact that brine-wells often produced petroleum led those who sold the "American oil" to embellish the label on the bottles with a derrick and other accompaniments of a brine-well; and the story is told that the projector of the first well drilled exclusively for petroleum was led to undertake it through reflecting upon this picture. Some oil from one of the natural springs near Titusville, Pennsylvania, was sent to Professor B. Silliman, junior, of Yale College, and he made a report upon it which has become a classic in the literature of petroleum. This report was so satisfactory that a company was organized in New Haven, and E. L. Drake was sent to drill a well upon land that was leased in the valley of Oil Creek, a short distance below the spot where the city of Titusville now stands. The region was then almost a wilderness, and many delays were experienced before he succeeded in getting his men and machinery in operation. He was at first thwarted by quicksands and water, but he finally drove an iron pipe 36 feet down to the rock. This device, said to have been original with Drake, has been of great value in artesian boring ever since he used it. After drilling 33 feet on the 28th of August 1859, the drill fell suddenly 6 inches into a crevice, and was left until the next day, when the drill-hole was found to be nearly filled with petroleum. No spot in the entire territory where petroleum has since been obtained could have been selected where the oil was to be obtained nearer the surface. The success of this enterprise led to the immediate drilling of other wells, first in the valley of Oil Creek and its tributaries, and later over the higher land between Oil Creek and the Alleghany river below Tidioute. As this territory began to be exhausted, the region of the lower Alleghany, in Butler and Clarion counties, yielded wells of great richness, and finally the Bradford field in McKean county became the centre of production. A careful comparison of the situations of some of the most productive wells led to the discovery that the areas yielding oil were not irregular in outline, but extended across the country in narrow belts, without regard to the present configuration of the surface. The areas of these belts were in general parallel, and extended in a north-east and south-west direction, 15° to 20° from the meridian. As the exhaustion of the oil-fields of Butler and Clarion counties led producers to seek a more productive locality, lines were run by compass on the supposed axis of the oil-belt over forest-covered hills for many miles, until they reached the town of Bradford, near which wells had previously been drilled without success. Deeper wells were drilled, and oil was obtained, resulting in the development since 1875 of about 68,000 acres of the most uniformly productive and extensive oil-territory yet discovered.

In the province of Ontario, Canada, principally in the vicinity of Enniskillen, a territory of limited extent but great productiveness has been under development for the last twenty years. In the region about Baku and in the valley of the Kuban, at the eastern and western extremities of the Caucasus, petroleum has been obtained for an unknown period, and is now being produced from artesian borings in large quantities. In Galicia and Roumania it is also obtained in commercial quantities. These regions with the United States furnish the petroleum of commerce. Japan, China, Burmah, and Italy have yielded petroleum in quantities sufficient to supply a local demand, but the vast quantity of the American oil and low price at which it is furnished have rendered the production in these countries unprofitable.

*Geographical Distribution.*—Petroleum "was found about one hundred years since in making the duke of Bridgewater's tunnel at Worsley, at Wigan and West Leigh in the Lancashire coal-fields, at Coalbrookdale and Wellington

in Shropshire and Riddings in Derbyshire, two other coal-fields; also in a peat-bog at Down Holland, near Ormskirk, in Lancashire, but never in commercial quantities. The greatest supply has not been more than fifty gallons a day, and even that soon diminished." A tar-spring was known at Coalport, in Shropshire, early in the present century. Although there are extensive deposits of solid bitumen in eastern France and Switzerland, the petroleum springs that occur at Saint Boès, Bazes Pyrénées, are unimportant. In Alsace, at Lobsann and Bechelbronn, petroleum has been obtained for many years for local use. Although reported from many localities in Germany, the only point that has promised to be of any importance is the Lüneburg heath, south of Hamburg. Petroleum is also reported near Hölle, in Dithmarchen, Schleswig-Holstein. On the eastern shores of the Adriatic—in Dalmatia and Albania—and in the Ionian Islands, petroleum springs have been mentioned by the writers of classical antiquity. In Armenia and Persia petroleum has been used for unknown centuries, and it appears to be widely distributed in the mountains that surround the tableland of Iran. In Algeria, Egypt, Kashmir, the Punjab, Assam, Java, and other East Indian islands petroleum is reported. In North America the successful development of the petroleum-fields of north-west Pennsylvania following the completion of Drake's well led in a few years to the drilling of wells in a great many localities where petroleum-springs had been observed. The following so-called "petroleum-fields" have produced oil in commercial quantities more or less valuable.

Name.	Maximum production in	Yield in barrels to 1860.
Oil Creek, Venango county, Pennsylvania	1862	85,617,297
Pithole, " "	1866	8,816,289
Central Alleghany, " "	1871	6,182,900
Lower Alleghany, Butler and Clarion counties	1874	87,842,978
Tidioute, Venango and Warren counties	1874	4,674,345
Bullion, Venango county	1877	2,312,090
Bradford, M'Kean county	1881	44,674,921
Warren, Warren county	1878	448,313
Smith's Ferry, Beaver county	1879	389,681
Mecca, Trumbull county, Ohio		
Grafton, Lorain county, " "		
Mackburg, Washington county, " "		
Horse Neck, Pleasant county, W. Virginia		
Volcano, Wood county, " "		
Burning Spring, Wirt county, " "		
Glasgow, Barren county, Kentucky		
Santa Clara Valley, Ventura county, California		

A continuous small production since 1865. No record.

Besides these localities petroleum has been observed over an area 1500 miles long by an unknown breadth in the valley of the Mackenzie and its tributaries, and in New Brunswick, Newfoundland, and other portions of eastern Canada. It also occurs at many different points along the Appalachian system of mountains from Point Gaspé on the St Lawrence to northern Alabama. It has been noticed in Kansas, Missouri, Wyoming, Colorado, and Texas in the United States, in southern Mexico, in the West India Islands, and in the northern states of South America. Petroleum is one of the most widely distributed substances occurring in nature, but an examination of the geographical localities in which it chiefly occurs will show them to be intimately connected with the principal mountain-chains of the world.

*Geological Relations.*—It has been frequently remarked that petroleum occurs in all geological formations, from the Silurian up to the Tertiary. While this is true as a general statement, it is misleading, for petroleum is not uniformly distributed through all formations, but occurs principally in two epochs of geological history; these are

the Silurian and the lower half of the Tertiary. The vast accumulations along the principal axis of occurrence in the western hemisphere are found in Silurian and Devonian rocks; the most productive axis of occurrence in the eastern hemisphere lies in the Eocene and Miocene of the Carpathians, Transylvania, and the Caucasus. In England the small quantity of petroleum that has been observed has sprung from the Coal-measures. In the valley of the Rhone and in Savoy it is in Jurassic limestones. The bitumen of the Apennines, of Dalmatia and Albania, of Roumania, Galicia, and the Caucasus, issues for the most part from rocks that are Eocene. But little is known respecting the geology of the bitumen of Asia Minor and Persia; the Punjab is also Eocene, and the little that is known of the deposits in Burmah and the East Indian Islands indicates that they are of the same age. East of the Mississippi river petroleum has been reported from localities that describe an ellipse upon the border of the Cincinnati anticlinal, which consists of an elevation of Silurian rocks extending from central Kentucky to Lake Erie, with the city of Cincinnati nearly in its centre, sloping beneath the newer formations in all directions. Starting at Great Manitoulin Island, in the northern part of Lake Huron, it is next reported at Port Huron, Michigan; Chicago, Illinois; Terre Haute, and in Crawford county, Indiana; Henderson, Cloverport, Bowling Green, and Glasgow, Kentucky; and around Nashville, and south-eastwards to Chattanooga, Tennessee, where the Silurian rocks again reach the surface. Turning north, the line extends almost unbroken through the eastern counties of Kentucky into Ohio and West Virginia, into Pennsylvania and New York, the ellipse being completed by the petroleum-fields of Canada. At Great Manitoulin Island petroleum was obtained in the Trenton limestone, at Chicago and Terre Haute in the Niagara limestone, both of which are Silurian. The Kentucky geologists regard the great Devonian black slate as the source of the oil in that State. There it is found saturating sandstones at Glasgow, and in crevices at Burkesville and other points on the Cumberland river. In the neighbourhood of Nashville, where the Lower Silurian rocks reach the surface, petroleum occurs within geodes, which are enclosed in the solid mass of the blue limestone. North-east of Nashville the present location of the oil is found to be in rocks that lie in an ascending series. Around Burkesville it is found in the Upper Silurian, immediately beneath the Devonian black slate. Farther north it lies in the Devonian and Subcarboniferous sandstones, which, in Johnson county, Kentucky, are now partly above the drainage-level of the country. The so-called "oil-break" of West Virginia and Ohio yields petroleum from sandstones that lie within the Coal-measures. Still farther to the north-east, in Pennsylvania and New York, the oil-sands are all found beneath the Coal-measures in the Upper Devonian, while in Canada they again descend to the Lower Devonian. "Petroleum exists in the Cretaceous rocks which extend along the eastern slope of the Rocky Mountains from British Columbia to Mexico, and in many of the interior valleys." The bitumen of the Pacific slope, of Mexico, the West India, and South America, is Miocene in California and Eocene in Trinidad, and Peru. From these statements it will be seen that there is a vast area in the Mississippi valley, estimated at 200,000 square miles, beneath which petroleum has been obtained, the formations of which are nowhere more recent than the Coal-measures. Another vast area, extending from California through Mexico to Peru, and including the West India Islands, yields petroleum from Tertiary rocks; while on the eastern continent a belt of country extends from the North Sea to Java, the bitumen-bearing rocks of which are Tertiary so far as is known. At present

the bulk of petroleum produced issues from rocks older than the Carboniferous, while the formations yielding bitumen, in by far the greater number of localities, are of Eocene age. In the great "oil-region" of the United States petroleum occurs in crevices to a very limited extent. In Canada and West Virginia it occurs beneath the crowns of anticlinals, and in Pennsylvania it saturates the porous portions of formations that lie far beneath the influence of superficial erosion, like sand-bars in a flowing stream or detritus on a beach. These strata are not of any particular geological age, but run through a vast accumulation of sediments embraced in all the formations between the Lower Devonian and Upper Carboniferous. They lie conformably with the enclosing rocks, and slope gently to the south-west. The Bradford field in particular resembles a sheet of coarse-grained sandstone 100 square miles in extent, by from 20 to 80 feet in thickness, lying with its south-western edge lowest and submerged in salt water, and its north-eastern edge highest and filled with gas under an extremely high pressure. In Galicia the sandstones holding the oil are very much disturbed, while in the Caucasus the deposits of sand are erratic both in regard to position and extent, and lenticular in outline, being enclosed in a formation consisting of stiff blue clay.

**Chemistry.**—The first chemical research upon petroleum was conducted by Vauquelin in 1817 upon the naphtha of Amiano. Prior to the discovery of petroleum in commercial quantities, a number of European chemists had made determination of the atomic constitution of several different varieties, and it had become generally understood that the oil consisted of an equal number of atoms of carbon and hydrogen. It has since been determined that some varieties of petroleum contain nitrogen and others contain sulphur and oxygen. These last-named elements are, however, to be properly considered as components of impurities. The proximate principles of petroleum have been determined and examined chiefly by Schorlemmer in England, Pelouze and Cahours in France, and C. M. Warren and S. P. Sedtler in the United States. Many other chemists have contributed valuable assistance to the work. These researches have established the fact that Pennsylvania petroleum consists chiefly of two homologous series of isomeric compounds having the general formula  $C_nH_{2n+2}$  at one extremity of which marsh gas is found and solid paraffin at the other (see PARAFFIN). This oil also contains a smaller proportion of the olefine series, having the formula  $C_nH_{2n}$ , with traces in the Bradford oil of the benzole series. Rangoon petroleum contains a larger proportion of both the olefine and the benzole series than Pennsylvania oil. It has been shown that Caucasian petroleum contains the additive compounds of the benzole group which have the same percentage composition as the olefines and furnish an illuminating oil containing more carbon than Pennsylvania oils of the same specific gravity. The residues from the manufacture of petroleum have been shown to contain very dense solids and liquids of high specific gravity, having a large proportion of carbon and possessed of remarkable fluorescent properties. Some petroleums are easily oxidized into asphaltum and kindred products. Colourless illuminating oils under the action of light absorb oxygen, which is converted into ozone, and they become yellow and viscid and of greatly impaired quality when the action is prolonged.

**Origin.**—The origin of petroleum has been a subject of speculation among scientific men during the last half century. It is a subject involved in much greater obscurity than the origin of coal, for, unlike coal, it has no organic structure; hence it can only be inferred upon circumstantial evidence that it is of organic origin; yet such evidence is so slight that few competent judges have ventured to decide

otherwise. The arguments in favour of a chemical origin have been advanced almost wholly by a school of French chemists during the last twenty years. They are based upon the results of a class of experiments first inaugurated by Berthelot, in which powerful deoxidizing agents like the alkali metals or iron at a white heat are caused to react with steam and carbonic acid. The hydrogen of the water and the carbon of the carbonic acid, having been deprived of their oxygen, unite in the nascent state to form a mixture of oily fluids closely resembling petroleum. Sufficient quantities of these oils have been prepared to prove their identity with each other and with crude petroleum. Before concluding from this circumstance that petroleum is the product of similar reactions, it is necessary to assume a condition of the earth's interior concerning which we know nothing; and, while the theoretical chemistry of the earth, based upon the nebular hypothesis, does not forbid such possibilities, there are other considerations relating to the origin of petroleum based upon the known rather than the possible that render the assumption that petroleum is of mineral origin forced and unnecessary. It is found that, when shale, coal, peat, wood, or animal matter, in fact any recent or fossil organic matter, is subjected to destructive distillation at low temperatures, there is obtained among other products an oily fluid which chemistry shows to consist chiefly of the same compounds of carbon and hydrogen as are found in Pennsylvania petroleum. There are other petroleums, however, occurring in Canada, Tennessee, and other localities somewhat different in composition, which are often found under conditions that make it extremely difficult to account for their origin upon any hypothesis that does not regard them as a product of the decomposition of animal remains. They fill the cavities of fossil corals and orthoceratites in Canada and of geodes in Tennessee, in all of which the oil appears to be hermetically sealed until the rock-mass is broken. The formation in which these oils occur consists of thickly-bedded Silurian limestones that were probably deposited in a deep sea at a somewhat high temperature, in which vast quantities of sea-animals perished and became buried. It is therefore most strictly in accordance with observed facts to assume that these oils, in whatever manner they may have been produced from the original animal remains, are indigenous to the rocks in which they are found. These indigenous oils do not occur locally in considerable quantity, although the aggregate amount scattered through any formation in which they occur can easily be shown to be large.

In those localities, notably north-western Pennsylvania and eastern Ohio, where petroleum occurs in large quantity, it occurs quite uniformly, saturating heavy beds of uncemented sandstone. This sandstone is overlaid with an impervious shell of slate, containing much silica, that holds down both the oil and gas within the sandstone under great pressure, not locally in cavities but over wide areas. The sandstone is also, so far as can be ascertained, overlaid with a vast formation of shale more than 1000 feet in thickness, containing large numbers of fossil animals and such a quantity of fossil sea-weeds that Dr J. S. Newberry has suggested that the Silurian ocean here contained a veritable sargasso sea. This shale, so filled with the remains of fucoids, has been several times submitted to destructive distillation, and has yielded as high as 50 gallons to the ton of distillate oil that was in many respects scarcely to be distinguished from crude petroleum. During the present century the French chemical geologists have held that all forms of bitumen are the product of metamorphism. Prominent among these may be mentioned Daubrée, who in his *Observations sur le Métamorphisme* has shown the strict correspondence between his laboratory experiments, in which all forms of bitumen were produced, and the opera-

tions of nature. No evidence appears to be lacking to show that those operations of nature in which heat, pressure, and steam have joined, usually denominated by physicists "metamorphism," when acting upon strata containing organic remains, are an adequate origin for petroleum as it occurs in the oil-regions of Pennsylvania and in Galicia. Petroleum occurs on the western slope of the Appalachian system from Point Gaspé on the Gulf of St Lawrence to northern Alabama, and there it is most abundant in the neighbourhood of strata in which there is the greatest accumulation of organic remains. The accumulations of sediment from which this mountain-system was constructed were deposited in a current whose course was parallel with the axis of the system, and, as has been so fully shown by Professor James Hall (*Paleontology of New York*, vol. iii., Introduction), these sediments were deposited in great thickness and of very coarse materials in the north-east, gradually thinning and increasing in fineness as they reached the Mississippi valley in the south-west. From the latest conclusions of American geologists it may be inferred that originally the eastern border of these deposits lay over a region now covered by the Atlantic Ocean. When the elevation took place that brought the metamorphic rocks of New England, New York, Pennsylvania, and Virginia to the surface, the eastern border remained submerged, while the western border was brought above the sea-level. The facts that concern petroleum are found in the comparatively undisturbed and nearly level position of this western border, in which the rocks holding the petroleum lie at present, like sand-bars in a current, and the further evidence that they afford that the metamorphic action which has altered nearly all the formations of the eastern border became extinct along a plane that descended deeper and deeper from the surface as the western slope of the system is traversed. This evidence further shows that along the western borders of the system, although the rocks and the coal that they enclose are unaltered near the surface, at the same time vast areas of the fucoidal shale and even limestones containing indigenous petroleum may have been invaded by the heat-action and their volatile contents distilled at great depths. This distillate, being forced up by heat and hydrostatic pressure, would naturally accumulate in any overlying bed of rock porous enough to receive it. In Galicia, Roumania, and Transylvania the metamorphic core of the Carpathians is flanked by beds of fucoidal shale rich in the remains of marine animals, which are intercalated with the beds of sandstones that contain the oil. This hypothesis, which regards petroleum as a distillate, includes the facts as thus far observed, is in harmony with scientific possibilities, and is reasonable, as it does not require any extraordinary assumption of either chemical or geological conditions. While the maintenance of any particular theory concerning the origin of petroleum is primarily of very little practical value, it is indirectly of value to conclude whether by some deep-seated chemical action the oil is at present being prepared in the laboratories of nature, or whether its generation has been long since completed. If a correct interpretation of the phenomena observed in relation to petroleum leads to the hypothesis that the fluid is in most instances a distillate, and especially in those localities where it is most abundant, then the conclusion is inevitable that the generation of petroleum is practically completed, and the deposits are vast natural storehouses which when once emptied are as completely removed from future production as a worked-out bed of coal.

*Methods of Production.*—While petroleum has been produced for an immemorial period in Persia, China, Japan, Burmah, Baku, and Galicia, and while the primitive

methods employed in each country in its production furnish interesting subjects for study, it is scarcely possible in this article to do more than indicate in a general manner how the vast quantities produced at the present time in the United States and Canada are brought to the surface, stored, and transported. In both Galicia and the Caucasus, which, with Canada and the United States, now furnish the petroleum of commerce, the ancient methods of production are being rapidly superseded by those employed in America. In the United States the development of oil-territory has acquired a habit that has become well defined, and has been repeatedly exemplified during the last twenty years. The first step is the sinking of a test or "wild-cat" well outside the limits of any proved productive territory, the progress of such well being eagerly watched not only by those who pay for it but also by many others who hope to profit by the experiment. The striking of oil in such a well is the signal for a grand rush, and a speculative floating population invades the place. After a time the speculative phase is succeeded by that of settled development. The oil-territory has become outlined. The sagacious ones have secured control of the most profitable tracts, while the floating element has moved on to a new field. Between the period of active development and absolute exhaustion comes that of decay, when the derricks are rotting and falling to wreck, and when property that has ceased to be productive has been sold at an extravagant price, and after accumulating debts has been abandoned. Finally the wave passes over and nature restores as she restores after the ruin of battle-fields. A visit to Pithole city, which in 1865 was, next to Philadelphia, the largest post-office in Pennsylvania, showed in 1881 fields of maize and timothy where some of the most famous wells had been, and of the city a score of houses tumbling to decay and not an inhabitant. It is not to be inferred, however, that any of the sections into which the oil-regions have been divided entirely cease to produce oil. There are wells now producing within sight of the spot where Drake drilled the first well; but large tracts cease to be centres of speculative investment, the old wells cease to be remunerative, and the new wells no longer hold out the possibilities of a grand lottery.

Wells are sometimes drilled by the owners of the land, but the larger part are drilled under leases. These leases are drawn up with a great variety of conditions, but they usually stipulate that the lessor shall pay to the lessee a certain portion of the oil produced, the amount varying from one-tenth to one-fourth in proportion to the supposed richness of the territory. One well to five acres is considered as many as a judicious arrangement will allow, but many wells have been drilled much closer, and in some instances several wells have been drilled on one acre. The oil-sand of different localities varies as it occupies different geological horizons. The Venango oil-sand extends from Tidioute in Warren county to Herman Station in Butler county, Pennsylvania, a distance of 62 miles. It is uniformly a conglomerate of smooth white quartz pebbles, from a quarter to three-quarters of an inch in thickness. In other districts of the United States, Canada, and Galicia the oil-sand is a true sandstone of varying colour and texture. In the Caucasus the sand is fine, and resembles a quicksand, as it rises with the oil and accumulates around the wells.

When the location of a well has been determined, a derrick or "rig" is built, which consists of the derrick itself and a small house for an engine, with the necessary foundation for both. This foundation is made of heavy timbers dovetailed and keyed together. The derrick consists of a framework firmly braced in the form of a truncated pyramid, and about 70 feet high. At its base are two large reels, upon one of which the drilling cable is coiled and upon the other the sand-pump rope. At one side of the derrick a heavy post, called the Samson post, is framed into the main sill, upon the top of which rests the walking-beam, one end of it being connected with the engine of from 12 to 15 horse-power, whilst the other supports the drill. When the engine is in motion the walking-beam alternately raises and drops the drill. The boiler is made like the tubular boilers usually employed on locomotives, and is placed at a distance from the well to prevent the ignition of the gas that often accompanies the oil. The engine should be reversible, and so





and which is held down by 2000 feet of motionless air, must be followed by an expansion into the porous rock that drives both oil and gas before it, until a point of maximum tension is reached. The resistance then becomes greatest within the rock, and, reaction following, oil and gas are driven out of the rock and out of the well until the expansive force is expended.

Fig. 2 and 3 show the general arrangement of pumping and flowing wells. After the well is torpedoed it is prepared for flowing. A section of 2-inch pipe, perforated with holes, which serves as a strainer, is lowered into the well and other sections coupled to it, until a sufficient length is introduced to reach from the bottom to a point above the oil-sand. An indiarubber packer is then attached in such a manner that within it the pipe that is above it slides in that which is below it, and the rubber is forced against the sides of the drill-hole with the weight of 1200 to 1800 feet of 2-inch pipe, thus making a gas-tight joint. The pressure of the gas within the oil-sand and below the packer forces the oil to the surface. As the flow diminishes, a pump-barrel is introduced to the bottom of the well and the oil is lifted to the surface. Gas-pumps are also used to remove the pressure of the atmosphere from the well and rock. In some of the older districts from twelve to forty wells are attached to one engine, and pumped by what is called a "sucker-rod" connexion. In West Virginia five different horizons of sandstone have yielded oil. A well was put down there in 1865 to the "first white oak sand," 255 feet in depth, and pumped at intervals for fifteen years; it was then reamed out to 8 inches in diameter, and from the bottom of the old well was carried down 4½ inches in diameter to the third sand. A tube was inserted with a packer at the bottom of the 8-inch hole to stop off the heavy oil of the first sand. Through this oil of a specific gravity .79 (45° B.) was pumped from the third sand, and through a second tube, introduced beside the first to the bottom of the old well, oil of a specific gravity .88 (27° B.) was pumped from the first sand, both pumps being simultaneously worked by the same walking-beam. The first sand oil was worth seven dollars a barrel, while the third-sand oil was worth only one dollar a barrel.

The average duration of the profitable production of an oil-well is estimated at five years. This period is subject to great fluctuations, as there are wells in the Cole Creek district of the Bradford field that were abandoned in two years, while wells on Triumph Hill, Venango county, where the sand is 125 feet thick, have been pumped fifteen years. The yield of some single wells has been enormous. A well in Donégal township, Butler county, Pennsylvania, produced more

than 110,000 barrels in ten years, and twelve wells, of which this was one, on the same farm produced over 750,000 barrels.

In Burma and other Eastern countries petroleum was stored and transported in flasks and jars. In the United States it was for many years transported in barrels made tight for oil by being coated on the inside with a stiff solution of glue. Later, it was transported on the rivers in bulk barges, and on the railroads in tanks upon cars. These tanks were at first made of wood, but they have lately been made of iron. The usual form is a plain cylinder, 24 feet 6 inches long and 66 inches in diameter, having a capacity of from 4000 to 5000 gallons. These cars are also used in the Caucasus. At the present time, in all the regions producing petroleum in commercial quantities, the bulk of the crude oil is transported through pipe-lines, which consist of lines of pipe carried across the country, often for hundreds of miles, through which the oil is forced by powerful pumps under a pressure of from 1000 to 1600 lb to the square inch. Each well has a tank into which the oil flows from the well, and from which it is carried in a 2-inch pipe by gravity to a pumping station, where it is pumped into the "main line." Main lines run out of the oil-regions of Pennsylvania to Cleveland (Ohio), Pittsburgh (Pennsylvania), Buffalo (New York), and New York, Philadelphia, and Baltimore on the Atlantic coast. They are constructed of 6-inch pipe, the joints of which are screwed into couplings like sections of gas-pipe. During recent years the production of petroleum in excess of any demand for it has led to the storage of vast quantities (30,000,000 barrels in 1883) in iron tanks of enormous size. Many of these tanks are owned by private individuals, but the majority belong to the pipe-lines. There are 1375 iron tanks connected with the united pipe-lines, ranging in capacity from 1000 to 38,000 barrels, and representing a total storage capacity of 38,000,000 barrels. These tanks are frequently fired by lightning or other accidents, and when burning present a spectacle of unsurpassed grandeur.

The bulk of the trade in crude petroleum in the United States is conducted through the pipe-lines and their certificates. When oil is received into the line from a well, the amount is ascertained and passed to the credit of the well-owner on the books of the company, less 3 per cent. to cover loss in handling. This oil is held like a bank-deposit, subject to transfer on a written order. When such an order has been "accepted" by an officer of the company it becomes an "acceptance" or "certificate," and is then negotiable like a certified cheque. As the exchanges deal only in certificates of 1000 barrels they are made of that amount so far as is possible. When oil is delivered by the pipe-lines a pipage charge of 20 cents per barrel is paid and a storage fee of \$13.50 per 1000 barrels per month must be paid at least once in six months. The issuing of certificates by the pipe-lines has made speculation in oil, brokerage, and exchanges possible to an extent vastly beyond the requirements of any actual trade in the oil itself.

About 250,000,000 barrels of petroleum have been produced in the United States and Canada from 1859 to 1884. No reliable statistics are to be had of the production in other regions, but of late years the Caucasian fields have yielded about 5,000,000 barrels per annum. The total annual production for 1883 cannot be far from 35,000,000 barrels.

**Technology.**—The technology of petroleum is quite simple. In the crude state it enters largely into mixtures with other oils, tallow, lead, soap, graphite, &c., that are chiefly used for lubrication. Crude petroleum is also filtered through charcoal. Crude oils that are too fluid for lubrication are reduced to the required consistence by partial evaporation, both by exposure to the sun in shallow tanks and also by distillation of the more volatile portion in stills. Such oils are called "reduced oils." In the technology of petroleum by distillation a great variety of details are employed by different manufacturers, but in general they may be treated under the three heads of destructive distillation or "cracking," distillation with superheated steam, and distillation *in vacuo*. The stills used vary greatly in respect of form and capacity. Formerly stills holding 80,000 gallons were used, but recently they have been constructed of a capacity of from 40,000 to 48,000 gallons. They are ordinarily made either in the form of plain cylinders 30 feet in length and 12 feet 6 inches in diameter, and set horizontally in banks of three or more, or there may be an upright cylinder 30 feet in diameter and 9 feet in height, set vertically with numerous fire-boxes arranged around the circumference. Another form of still is an upright cylinder holding about 1000 gallons, heated from beneath and furnished with a steam-coil immersed in the body of the oil. In this coil the steam is superheated to the temperature of the oil, and is then allowed to escape into it, by which means the overheating of the oil is prevented and the distillation assisted by the mechanical action of the steam in lifting the oil-vapour out of the still. Another form of still is a vacuum still, in which a partial vacuum is maintained by a pump. The top of the still is usually constructed with a high dome, into which the vapours rise and from which they escape into the condensers. The condensers usually consist of a large number of 2-inch pipes immersed in water contained in a long trough. The distillation

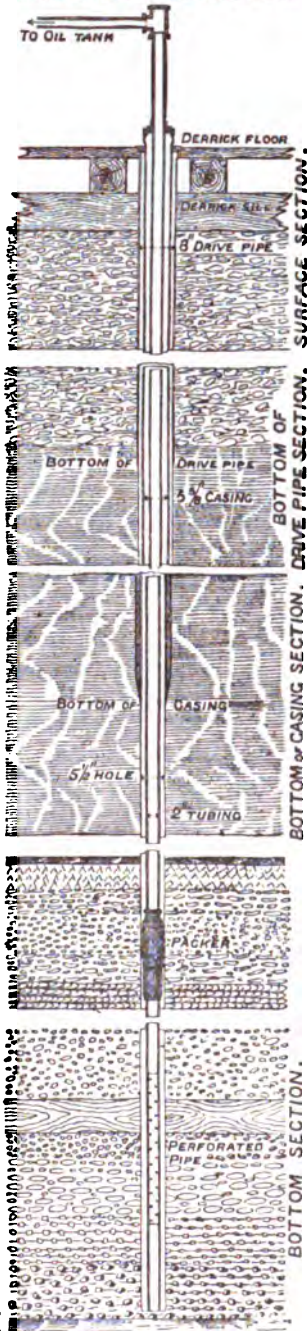

Fig. 3.—Flowing Well.

commences at a very low temperature and proceeds at a constantly rising temperature, the distillate steadily increasing in specific gravity. The last portions distil at nearly a red heat, and are nearly solid at ordinary temperatures, with a specific gravity above 900.

The oil is first allowed to settle in large tanks, when about 1 per cent. of water and sediment is removed. It is then pumped to stills into which "live" steam is introduced. Distillation commences at once and is allowed to proceed until the specific gravity of the distillate reaches '74 (60° B.). The oil in this condition is called "gas-oil" and is used to a limited extent in the manufacture of illuminating gas. The distillate is crude naphtha, and is redistilled and divided into (1) rhigolene or cymogene, having a specific gravity of '63 and boiling at 65° Fahr.; (2) gasolene, specific gravity '66 (90° to 80° B.); (3) C naphtha, specific gravity '70 (80° to 68° B.); (4) B naphtha, specific gravity '72 (68° to 64° B.); and (5) A naphtha, specific gravity '74 (64° to 60° B.). Below 60° goes to illuminating oil. The crude oil from which the naphtha has been removed is then put into a suitable still and distilled until the distillate has a specific gravity of '81 (40° B.). This distillate is crude illuminating oil. The oil remaining in the still may then be "cracked" by destructive distillation, or may be distilled for lubricating oil. If it is to be "cracked" the fires are slacked and the distillation allowed to proceed slowly, in consequence of which the vapours of the heavy oil are repeatedly condensed upon the dome of the still and made to fall back upon the hot oil beneath. The result is the production of a large volume of permanent gas, chiefly marsh gas and hydrogen, a distillate of suitable specific gravity for illuminating oil, and a heavy tarry residue, called "residuum," that remains in the still. By this method of manipulation the crude oil is converted into crude naphtha, crude illuminating oil, and residuum, while the gas is burned as a waste product. The residuum is run out of the still and sold to manufacturers of lubricating oil. If the oil is not to be cracked, the heavy oil, from which the illuminating oil and naphtha have been removed, is often distilled with superheated steam and treated for lubricating oil. If simply distilled and treated with chemicals after removal of the paraffin, the oil is called in the United States "paraffin oil." The crude paraffin oil is placed in barrels in an ice-house, and, after it has been several days at rest, paraffin crystallises from it. The paraffin is removed by pressure, and may be purified by any of the methods described under PARAFFIN (p. 242 above). The oil from which the paraffin has been pressed may be subjected to a further distillation in a steam-coil or other suitable still, and deprived of certain oils that boil at a high temperature but have a pungent and offensive odour. When drawn off, the oil remaining in the still is found to be light-coloured and nearly tasteless and odourless. It is called "deodorized neutral heavy hydrocarbon oil," and is found to be a very valuable lubricating oil. The distillate above mentioned after treatment is called "mineral sperm," and is used as an illuminating oil on cars and steamboats, where a more volatile oil would be objectionable. Any of these distillates, from gasolene to the most dense lubricating oil, may be purified by filtration or by treatment with acids and alkalis. Filtration is usually applied to the different grades of naphtha to deprive them of disagreeable odour, for which purpose gravel and both wood and animal charcoal are used, either separately or together. Lubricating oils are often filtered through animal charcoal to deprive them of both colour and odour. The dense vacuum residues recently prepared under the name of cosmoline, vaseline, &c., are filtered through animal charcoal while hot and perfectly fluid. Oils are treated with chemicals in high cylindrical tanks of small diameter, where they are thoroughly mingled by means of air forced into the bottom of the tank under pressure. These agitators often hold 50,000 gallons. The illuminating oils are usually treated with 5 per cent. of oil of vitriol at a temperature of about 60° Fahr. The acid "sludge," consisting of the oil of vitriol combined with the impurities of the oil and forming a black tarry liquid, settles to the bottom of the tank and is drawn off. The oil is then agitated with water, then treated with a solution of caustic soda, and finally washed with water containing caustic ammonia. Hydrochloric acid is used to a limited extent, and nitric and chromic acids are used to destroy fluorescence in dense oils. These illuminating oils especially that are prepared by cracking are thrown after treatment, and while warm, in a thin spray into a large tank. This causes a small amount of very volatile oil produced by cracking to be evaporated, and brings the oil up to test. Finally the oil is exposed under a skylight in large shallow tanks until it has become perfectly clear from settling of all impurities. The acid "sludge" is for the most part sold to manufacturers of commercial fertilisers or restored by evaporation and used over again. More than 45,000 tons of oil of vitriol were used in 1880 by the manufacturers of petroleum in the United States. The alkali sludge is thrown away. The following table shows the average percentage of commercial products obtained from crude petroleum of '79 (45° B.) from Pennsylvania, Ohio, &c.—

	Per cent.
Gasolene .....	1 to 1½
"C" naphtha .....	10
"B" naphtha .....	24
"A" naphtha .....	2 to 2½
	16½
Illuminating oil .....	80 to 84
Lubricating oil .....	17½
Paraffin wax—4½ lb per barrel .....	2
Loss .....	10
	100

If the oil is "cracked," the yield is—

Naphthas .....	16½
Illuminating oil .....	70
Residuum .....	2
	88½
Loss .....	11½
	100

**Lubricating Oils.**—Crude petroleum and the heavy distillates from petroleum, finished either by treatment or by filtration, have been slowly winning their way with consumers of lubricating oils for the last twenty years, and may now be said to have a recognized value. This result has been due as much to improved processes of manufacture, and consequently to improved quality of the products, as to a recognition of their merits. When properly prepared, and exempt from volatile matter and offensive odour, they are found to be possessed of great endurance, to be free from a tendency to gum, and to be incapable of spontaneous combustion. When mixed with animal and vegetable oils liable to spontaneous combustion these oils prevent it. They are therefore now in large demand, a demand which is likely to increase as new applications are found for them and their quality is improved.

**Illuminating Oils.**—Oils of this class manufactured from petroleum have nearly superseded the use of other illuminating fluids throughout the world. They are largely sold in Great Britain under the name of "paraffin oils"; in the United States they are called "kerosene," and on the European continent "refined petroleum." The different qualities are known as "water white," "standard," and "prime," and are further distinguished as "low test" and "high test" oils. The characters chiefly relied on in the trade are "colour" and "test." The colour should be as light and free from opalescence as possible. Colour is, however, a matter of little importance except as it indicates unskilful manufacture of the oil. The "test" is of paramount importance, and indicates the temperature Fahr. at which the oil will give off a sufficient amount of vapour to ignite explosively when the oil is properly tested. While the methods of testing petrolum vary greatly, the apparatus used for that purpose may be divided into three classes. The first class is designed to ascertain the tension of the vapour given off by a given sample at a certain fixed temperature; these are chiefly used in France. The others are designed to show at what temperature a given amount of oil, usually half a pint, will give off a sufficient amount of vapour to form an explosive mixture with the air above the oil. These are divided into "open testers," in which the oil is heated in an open vessel, and "closed testers," in which the oil is heated in a closed vessel. The tester invented by Sir F. A. Abel (see PARAFFIN, p. 239) has been adopted in Great Britain and her colonies, while in the United States and on the Continent a great variety are in use. The numerous accidents, many of a frightful nature, and involving great loss of property and often of human life, that have followed the use of illuminating oils which had not been properly freed from the volatile products of the petroleum, have led in most European countries and many of the American States to the enactment of stringent laws forbidding the sale or use of oils the test of which does not come within the prescribed legal limits. Very valuable researches on the flashing of oils have been made by Dr C. F. Chandler of New York, and by other American chemists. Dr Chandler showed that oils burning in lamps of ordinary construction in a room the temperature of which was below 90° Fahr. failed to reach an average temperature of 100° Fahr. In metal lamps, particularly "student lamps," the average temperature was several degrees higher than in glass lamps, a fact which shows glass lamps to be safest in this respect. Dr C. B. White of New Orleans has examined illuminating oils with respect to the amount of volatile material that, when added to good oil, will render it dangerous. He found that from 1 to 5 per cent. of the ordinary naphthas of commerce would render illuminating oil of the best quality extremely dangerous. Five per cent. of crude naphtha reduced the flashing point from 118° to 70° Fahr. These researches have all demonstrated the wisdom of English legislation on this subject, but unfortunately have not been productive of equally good results in the United States. Petroleum legislation is there in a very unsatisfactory condition. The very worthless law passed by Congress in 1867 has long been repealed, and no other has been substituted for it. A number of the States (seventeen in 1880) are without legislation in reference to this subject, while legislation in other States is based upon local influence rather than fixed principles, and ranges in its



requirements from extreme laxity to unreasonable exaction, in consequence of the lack of intelligent national Governmental action. Nearly all the nations of continental Europe have petroleum laws in the main based upon an intelligent appreciation of the subject, and but little inferior to English legislation.

**The Uses of Naphtha.**—The lightest products obtained from petroleum are rhygiene, which is used in surgery, and cymogene, which is used as the volatile fluid in ice-machines. Gasolene is the lightest fluid obtained in considerable quantity, and is used in automatic gas-machines for the carburation of gas or air. The question of increasing the illuminating power of gas (see GAS, vol. 2, p. 101), by causing it to absorb fluid hydrocarbons, was discussed as early as 1832, but it was only after petroleum furnished a cheap and suitable fluid that inventors succeeded in securing results of any value. While hundreds of machines have been patented in England, America, and continental Europe for accomplishing this purpose, it is only quite recently that an American inventor, Dr Walter M. Jackson, has succeeded in constructing a machine that satisfactorily meets all the requirements of the problem. His metrical carburettor measures both the fluid and the gas or air in such a manner that the least amount of the hydrocarbon fluid required to produce the effect sought is furnished to the gas, and the whole is immediately absorbed. By this means a uniform carburation is secured, furnishing a gas of uniform quality, that never contains a sufficient amount of fluid to admit of condensation in any part of the apparatus. Both crude petroleum and the products of its manufacture have been used as a material for the manufacture of gas by distillation. The different qualities of naphtha are used in mixing paint, in the manufacture of oil-cloths for floors and of varnishes, as a solvent for gums and resins, in the preparation of alkaloids, in the manufacture of India-rubber, in washing wool, and in removing oils and greases from seeds and textile fabrics.

**Petroleum as Fuel.**—In the region of the Caucasus and on the Caspian Sea, where other fuel is scarce and dear and petroleum is plentiful and cheap, the latter is used with complete success on both steamships and locomotives. Petroleum and its products have been used with practical success in the manufacture of iron in the United States. Both illuminating oil and naphtha are now very widely used in stoves; but naphtha-stoves are extremely dangerous, and their use should be prohibited by law. In the valley of the Euphrates, near Mosul, petroleum is used as a fuel in burning lime.

**Petroleum in Medicine.**—Although petroleum has been used as a remedial agent for an unknown period in the countries where it is a natural product, its physiological effects have never been very fully investigated. Barbados tar, Haarlem oil, Seneca oil, and American oil, all consisting wholly or in large part of crude petroleum, were sold by apothecaries for years before petroleum was obtained by boring. They were mainly used as liniments for external application, particularly in rheumatism. The oil of the Alleghany valley early had a local reputation as an internal remedy for consumption, and it has lately been prescribed for bronchitis. The most volatile product of petroleum obtained by distillation, called rhygiene, has been used to produce local insensibility, by means of the intense cold resulting from its rapid evaporation; and the same fluid when inhaled as vapour or the gas escaping from fresh oil will produce an intoxication or insensibility resembling the effects of laughing-gas, resulting in death if its action is prolonged. The products of petroleum that have proved most valuable in medicine are the filtered paraffin residues sold under the names of cosmoline, vaseline, &c., that are now so widely used as ointments, either plain or medicated. They are of about the consistency of butter, with very little taste or odour, and will keep indefinitely without becoming rancid. These valuable properties have caused them to almost entirely supersede all other preparations containing animal or vegetable fats.

Looking towards the past, it may be said that petroleum has attained universal diffusion as a lighting agent; it is fast displacing animal and vegetable oils as a lubricator on all classes of bearings, from railroad-axles to mule-spindles, and also where other oils are liable to spontaneous combustion; it is very largely used as fuel for stoves, both for heating and cooking; it is very successfully used for steam purposes when other fuel is scarce and petroleum plentiful; it is likely to be used for the production of pure iron for special purposes; and it has become a necessity to the apothecary as petroleum ointment. Looking towards the future, what assurance have we that these varied wants, the creation of a quarter of a century, will be satisfied? While it is not probable that the deposits of petroleum in the crust of the earth are being practically increased at the present time, there is reason to believe that the supply is ample for an indefinite period. Yet the fact is worthy of serious consideration that the production of petroleum as at present conducted is everywhere wasteful in the extreme.

There are very few works that treat exclusively of petroleum. An article in the *Bull. de la Soc. Géol. de France*, xvii., gives the best résumé of the mention made by classical writers. Travellers overland to India and Persia have usually described Baku (see KAMPERT, 1718; HANWAY, 1743; FOSTER, 1794; KINLER, 1846). On the occurrence of petroleum in Burma, see *Journals of the Embassy to the Court of Ava*, SYMES (1795), CRAWFORD (1836), YULE (1866); in Persia,

Carl Ritter's *Brdl. u. Asten*, 1840; in Japan, R. S. LYMAN'S *Report, Geol. Survey of Japan*, 1874-75; in Galicia, Von HANAU (1855), POLONIA (1854, 1864, 1865, 7, 8, 9, 1875), BRUNN WALTER (1855), in the *Journal of the Geological Society*; in Romania, Von HANAU, *Geologie Sibabirgians*, 1858; H. COQUAND, *Bull. Soc. Géol. de France*, xiv., 604, 1887; in Canada, T. STARRY HUNT, in *Report of Geol. Survey of Canada* of various dates, 1858-73; in Pennsylvania, J. F. CURT, *Report*, I., II., and III., with maps, *Second Geological Survey of Pennsylvania*, 1874-1880. On the chemistry of petroleum, see C. M. WARREN, in *American Journal of Science and Chemical News*; *Shortmann*, in *Quar. Journal of the Chemical Society*; *Falouts and Oubours* in *Ann. de Chimie et de Physique*; *Berthelot* in the same, all at various dates, 1853-1860. On the origin of petroleum, see *Lampson*, in *Trans. Am. Phil. Soc.*, xiii., 1868; J. S. NEWBERRY, in *Ohio Geol. Report*, 1867; T. STARRY HUNT, in *Chem. News*, vi., 5 et seq.; *Byrnes*, in *Russ. Industrielle*, 1871; *Mandeloff*, in *Bull. Soc. Chim. de Paris*, 1872. On testing petroleum, see *John Atfield*, in *Chem. News*, xiv., 267; F. CRAIG CALVERT, *Chem. News*, xli., 80; G. F. CHANDLER, in *American Chemist*, II., 400; *Boverton Redwood*, in *English Mechanic and World of Science*, xxii., 325, 1875; F. A. ABEL, in *Chem. News*, xxxv., 71. On the general subject, see T. STARRY HUNT, "History of Petroleum or Rock Oil," in *Canadian Naturist*, [1], vi., 245; *Chem. News*, vi., 5; *Report of Smithsonian Institution*, 1852; T. LEVENE SMITH, in *Report to the Judges of the Centennial Exposition, Philadelphia*, 1876; S. F. FOCKHAM, monograph on petroleum, including bibliography of petroleum and allied subjects to 1851, in *Report of the Tenth Census of the United States*. See also, for an account of wells at Baku, *Engineering*, 23d February to 16th May 1864, London. (S. F. J.)

## PETROLOGY. See ROCKS.

**PETRONIUS.** Petronius Arbitr, although excluded from the list of classical writers available for the purposes of education, is one who enjoyed a great reputation, especially in France, at a time when Latin authors were more read as literature than they are in the present day. A recent critic<sup>1</sup> of Petronius has stated, though with evident exaggeration, that no ancient writer except Aristotle has found so many interpreters. But there is perhaps none about whose history and era there has been so much controversy, nor is the controversy yet settled with absolute certainty. He hides himself so completely behind the mask of his fictitious personages that we learn nothing of his fortunes, position, or even of the century to which he belonged, directly from himself. He does not belong to any of the classes of "viri illustres" (poets, orators, historians, philosophers, grammarians, and rhetoricians; whose lives were written by Suetonius. Though he is mentioned by critics, commentators, and grammarians of a late date (such as Macrobius, Servius, and Priscian), the only hint we have of anything bearing on his personal position is contained in two lines of Sidonius Apollinaria, a writer of the latter part of the 5th century A.D., who associates him with the masters of Latin eloquence, Cicero, Livy, and Virgil, in the lines—

"Et te, Maecilianum per hortos  
Sacer stiptis, Arbitr, colorem  
Hallepentiaco parem Priapo."

If these lines are to be construed as implying that Petronius lived and wrote his work at Marseilles, this inference could hardly be reconciled with the indirect evidence which leads to the identification of the author of the *Satires* with the C. Petronius of whom Tacitus has painted so vivid a picture in the sixteenth book of the *Annals* (ch. 18, 19). His place of residence in his later years at least was not Marseilles but Rome. There is nothing, however, in what Tacitus says incompatible with the supposition that Marseilles was his birthplace; or perhaps the allusion might be explained by the supposition—supported by a note of Servius on Virgil, *Æn.*, iii., 57—that the scene in the early part of the long novel, of which two fragmentary books have been preserved, was laid at Marseilles. The chief personages of the story, as they appear in these fragments of books xv. and xvi., are evidently strangers in the towns of the south of Italy where the adventures in which they share are supposed to take place. Their Greek-sounding names (Encolpius, Ascyltos, Giton, &c.), and their literary training also, accord with the characteristics of the old Greek colony in the 1st century A.D. The high position among Latin writers assigned by Sidonius to Petronius, and the mention of him by Macrobius in juxtaposition with Manilius, when compared with the absolute silence of such writers as Quintilian,

<sup>1</sup> J. N. M. De Gozria, *Recherches Scientifiques sur le Satirique.*

Juvenal, and Martial, who might have been expected to have taken some notice of him if he had flourished immediately before their own day, seem adverse to the generally received opinion that the *Satiræ* was a work of the age of Nero. Yet the silence of Quintilian may be explained by the fact that Petronius is not one of those writers who were capable of being turned to use in the education of an orator. The silence of Martial and Juvenal may be accidental. Even if it is to be explained on the ground of want of appreciation, this would prove nothing more than that a work so abnormal in form and substance was more highly prized by later generations than by the author's contemporaries.

But, if we pass from these faint traces of external evidence to that afforded by the style of the book and the state of manners described in it, we are led to the inference that there is no other age to which it can be assigned on better grounds than the age of Nero. If, again, we compare the impression we form of the character, genius, and habits of the writer with the elaborate picture which Tacitus paints of a man who, so far as he played any part in history, is merely one of the victims of an abortive conspiracy, we find grounds of probability for identifying them with one another. Tacitus does not tell us that he was the author of any important work, and this has been urged as conclusive on the question. But Tacitus does not think it necessary in what he tells us of Germanicus or Claudius to mention their poetical and historical works. In introducing Silius Italicus as the witness of a particular occurrence he does not add that he was the author of the poem on the Punic War. He mentions that the poetical gifts and reputation of Lucan and Seneca were among the causes that excited Nero's jealousy, but he does not mention the *Pharsalia* of the one or the *Tragedies* of the other. The prominence which Tacitus gives to the portrait of Petronius points to his enjoyment of greater notoriety than was due to the part he played in history. He paints him with the keen and severe eye with which he fastens on the traits of character and the manner of life illustrative of the moral corruption of the time, but at the same time with that appreciation of intellectual power which forces him to do justice to men who in other respects were detestable. Such a work as the *Satiræ* he could, from a moral point of view, have regarded with no other feelings than those of detestation; yet he could not have refused his admiration to the unmistakable proof it affords of easy careless power, and of a spirit, if not courageous in any good sense, yet indifferent to death, and capable of meeting calamity with Epicurean irony.

The account he gives of C. Petronius is "that he spent his days in sleep, his nights in attending to his official duties or in amusement, that by his dissolute life he had become as famous as other men by a life of energy, and that he was regarded as no ordinary profligate, but as an accomplished voluptuary. His reckless freedom of speech, being regarded as frankness, procured him popularity. Yet during his provincial government, and later when he held the office of consul, he had shown vigour and capacity for affairs. Afterwards returning to his life of vicious indulgence, he became one of the chosen circle of Nero's intimates, and was looked upon as an absolute authority on questions of taste ('arbiter elegantiæ') in connexion with the science of luxurious living." This excited the jealousy of Tigellinus, and led to his condemnation. Petronius's death is then described, which was in keeping with his mode of life and character. He selected the slow process of opening his veins and having them bound up again, while in conversing with his friends he avoided the serious subjects natural at such a time, and listened to their recitation of light odes and trifling verses. He then dined luxuriously, slept for some time, and, so far from

imitating the practice of others by flattering Nero or Tigellinus in his will, he wrote, sealed, and sent to the emperor a document which professed to give, with the names of the partners of his vices, a detailed account of the scandalous life of the court.

That this portrait, drawn with such characteristic lines, and painted in such sombre colouring, is sketched from the life in Tacitus's most graphic manner is unquestionable. A fact confirmatory of its general truth is added by the elder Pliny (who calls him T. Petronius), who mentions that just before his death he destroyed a murrhine vase of great value to prevent its falling into the hands of Nero. The question arises whether there is ground for identifying the author of the fragment which we possess under the name of *Satiræ* with the person so minutely and faithfully described by Tacitus. Do the traits of this picture agree with that impression of himself which every writer of marked individuality unconsciously leaves on his work? Further, is there any reason for supposing, as some have maintained, that in this fragment we possess the actual document sent to Nero? The last question may be at once dismissed. The only fragments connected by any kind of continuity which we possess profess to be extracts of the fifteenth and sixteenth books of a work that must have extended to a great length. It would have been impossible to have composed one-tenth part even of this fragment in the time in which Petronius is said to have composed his memorial to Nero. Those who find in the representation of the vulgar, ostentatious, illiterate, but tolerably good-natured Trimalchio a satire on Nero or Tigellinus are capable of finding any meaning they desire in any literary work of a past age.<sup>1</sup> But at the same time it is legitimate to note that the author of the banquet of Trimalchio and of the lives of Encolpius and Giton had both the experience and the literary gifts which would enable him to describe with scathing mockery the

"Luxuriam imperii veterem noctesque Neronis,"

and that he was not one to be restrained by any prudery from describing them in their most revolting details.

On the other hand, the arguments against identifying the writer of the fragment with the original of the portrait of Tacitus, based on the silence of the historian as to his authorship, may be explained by reference to the historian's practice in regard to the authors of other literary works. Unless these works had any bearing on the part which their authors played in history, he did not feel himself called upon to mention them; and such a work as the *Satiræ* he would have regarded as especially beneath the dignity of history, of which he had so proud a consciousness. The impression of his personality produced by the author corresponds closely with that of the Petronius of the *Annals*, not only in the evidence it affords of intimate familiarity with the vices of the age, but in the union of an immoral sensualism with a rich vein of cynical humour and an admirable taste, which we should expect to find in one who rose to favour by his social and convivial qualities, and who received the title of "elegantissimus arbiter." The Epicurean maxims, such as—

"Vivamus dum licet esse bene,"

quoted by his actors, and the frequent introduction of short poems into their conversations, are in conformity with the opinions and tastes of one who in his last hours "audiebat referentes nihil de immortalitate animæ et sapientium placitis, sed levia carmina et faciles versus." Further, the name "Arbiter," by which he is mentioned in later writers, is not an ordinary Latin cognomen, but may have been bestowed on him by his contemporaries from the fact that his judgment was regarded as the criterion

<sup>1</sup> The supposition of M. Gaston Boissier that the individual mentioned is Pallas, the freedman of Claudius, is much more probable.

of good taste, and Tacitus, in the phrase he perpetuates, may have fixed this as his designation for later writers.

The style of the work, where it does not purposely reproduce the solecisms, colloquialisms, and slang of the vulgar rich—for the most part freedmen of foreign origin—is recognized by the most competent critics as written in the purest Latin of the Silver Age. Coincidences of expression and thought with passages in the satires of Persius are not infrequent.<sup>1</sup> The false taste in literature and expression fostered by the false style of education is condemned by Persius and Petronius on the same grounds. When the latter speaks of the "mellitos verborum globulos" he may possibly have had Seneca in his eye. Again, there would have been no point in putting into the mouth of the old poet whom the adventurers pick up verses on the capture of Troy and the Civil War at any other era than that in which the *Troica* of Nero and the *Pharsalia* of Lucan were the fashionable poems. The pertinacity of the reciting poet, which is exposed with such quiet humour by Petronius, is a feature of the age, common to it with the age of Martial and Juvenal. But we learn from Tacitus that the luxury of the table, which appears so profuse and extravagant in the "dinner of Trimalchio," reached its highest pitch under Nero, and afterwards fell out of fashion (*Tac., Ann.*, iii. 55).

The internal evidence based on the style and character of the work thus appears to favour the opinion that the book was written in the time of Nero; nor is there any one more likely to have been its author than the C. Petronius whose manner of life and whose death are so elaborately described by Tacitus.

The work, of which there have been preserved 141 sections or chapters of a narrative, in the main consecutive, although interrupted by frequent gaps, must have been one of great originality as regards form, subject-matter, and mode of treatment. The name *Satira*, by which it is designated in the best MSS., indicates that it claims to be of the type of the original "satira" or "miscellany" to which Varro, in imitation of the Greek writer Menippus, had given the character of a medley of prose and verse composition. But, while in the title and form of the work it belonged to a familiar type, yet from another point of view it is to be regarded as the earliest extant specimen of an original and most important invention in Roman literature. We find in it indeed not only a medley of prose and verse composition, in which the former is much the most prominent element, but also much desultory matter, disquisitions on art and eloquence, stories and anecdotes, &c. But the novelty of form recognized in Petronius consists in the string of fictitious narrative by which these are kept together. The original Italian satira, superseded by the Latin comedy, had developed into the poetical satire of Lucilius and Horace, and into the miscellaneous prose and verse essays of Varro. In the hands of Petronius it assumed a new and most important phase in its development. The careless prodigal who gave his days to sleep and his nights to pleasure was so happily inspired in his devices for amusing himself as to introduce into Roman literature, and thereby transmit to modern times, the novel

based on the ordinary experience<sup>2</sup> of contemporary life,—the precursor of such novels of adventure and character as *Gil Blas* and *Roderick Random*. There is no evidence of the existence of a regular plot in the *Satira*; but we find one central figure, Encolpius, who professes to narrate his adventures, and to describe all that he saw and heard, while allowing various other personages to exhibit their peculiarities and express their opinions dramatically. From the nature of the adventures described there seems no reason why the book should not have gone on to an interminable length.

The fragment opens with the appearance of the hero, Encolpius, who seems to be an itinerant lecturer travelling with a companion named Ascytus and a boy Giton, in a portico of a Greek town, apparently in Campania. Encolpius delivers a lecture, full of admirable sense, on the false taste in literature, resulting from the prevailing system of education, which is replied to by a rival declaimer, Agamemno, who shifts the blame from the teachers to the parents. The central personages of the story next go through a series of questionable adventures, in the course of which they are involved in a charge of robbery. A day or two after they are present at a dinner given by a freedman of enormous wealth, Trimalchio, who had risen, as he boasted, "from a penny," and who entertained with ostentatious and grotesque extravagance a number of men of his own rank, who had not been so prosperous in life. We see actually in flesh and blood specimens of those "Cappadocian knights" to whom we have many pointed references in Martial and Juvenal. We witness their feats of gluttony; we listen to the ordinary talk of their guests about their neighbours, about the weather, about the hard times, about the public games, about the education of their children. We recognize in a fantastic and extravagant form the same kind of vulgarity and pretension which the satirist of all times delights to expose by pen or pencil in the illiterate and ostentatious millionaires of the age. Next day Encolpius separates from his companions in a fit of jealousy, and, after two or three days' sulking and brooding on his revenge, enters a picture gallery, where he meets with an old poet, who, after talking sensibly on the decay of art and the inferiority of the painters of the age to the old masters, proceeds to recite in a public portico some verses on the capture of Troy, till his audience take to stoning him. The scene is next on board ship, where Encolpius finds he has fallen into the hands of some old enemies. They are shipwrecked, and Encolpius, Giton, and the old poet get to shore in the neighbourhood of Crotona, where, with the view of attracting the attention of the inhabitants, notorious fortune-hunters, the adventurers set up as men of fortune. The fragment ends with a new set of questionable adventures, in which prominent parts are played by a beautiful enchantress named Circe, a priestess of Priapus, and a certain matron who leaves them her hair, but attaches a condition to the inheritance which even Encolpius might have shrunk from fulfilling.<sup>3</sup>

What, then, may be said to be the purpose of the book, and what is its ethical and literary value? It can hardly be called a satire in the ordinary, and certainly not in the Roman sense of the word. There is no trace of any purpose of exposing vice with any wish to correct it. If we can suppose the author to have been animated by any other motive than the desire to amuse himself, it might be that of convincing himself that the world in general was as bad as he was himself. Juvenal and Swift are justly regarded as among the very greatest of satirists, and their estimate of human nature is perhaps nearly as unfavourable as that of Petronius; but their attitude towards human degradation is not one of complacent amusement but of indignant condemnation. They too, like Petronius, take pleasure in describing things most repugnant to all sense of delicacy with the coarsest realism, but theirs is the realism of disgust, not, like that of Petronius, a realism of sympathy. It might have been thought difficult to sink lower in the cynical tolerance of immorality than Martial occasionally has sunk. But there is all the difference in the world between Martial and Petronius. Martial does not gloat over the vices of which he writes with cynical frankness. He is perfectly aware that they are vices, and that the reproach of them is the worst that can be cast on any one. But further, Martial, with all his faults, is, in his affections, his tastes, his relations to others, essentially human, friendly, generous, true. There is perhaps not a single sentence in Petronius which implies any knowledge of or sympathy with the existence of affection, conscience, or honour, or even the most elementary goodness of heart, or of that amount of mutual confidence which is necessary to keep a band of brigands or a circle of

<sup>1</sup> E.g., compare Persius, ii. 9, 10—.

<sup>2</sup> "O si Ebulliat patrus, proclarum funus, et O si Sub nastro crepet argenti mihi seris dextro Hecale!"

with *Satira* 88, "Alius domum promittit, si propinquum divitem extulerit, alius si thesaurum effoderit," &c. The "ebulliat patrus" may be compared with a phrase in the dinner of Trimalchio, "homo bellus tam bonus chrysanthus animam ebullit." Persius has the phrase "Dives arat Caribus quantum non milvus oberat," which is a close parallel to Petr., 37, "fundos habet qui milvi volant." Again, both Persius and Petronius use the rare word "baro," which occurs only two or three times elsewhere.

<sup>3</sup> In this respect the work of Petronius seems to have differed from the Greek romances.

<sup>4</sup> Omnes qui in testamentis meo legati habent preter libertos ræco, hæc condicione percipient que dedi, si corpus primum in partes occiderint et astante populo comederint (141).



swindlers together. In estimating such a work, which in its spirit not less than in its form and its literary execution is essentially abnormal, it is necessary to bear in mind that it has reached us in so fragmentary and mutilated a shape that we may altogether have missed the key to it, and that it may have been intended by its author to be a sustained satire, written in a vein of reserved and powerful irony, of the type realized in our modern *Jonathan Wicks* or *Barry Lyndon*. But, if this is not the explanation, we must fall back on the more obvious but still difficult solution that, in the entire divorce of intellectual power and insight from any element of right human feeling, the work is an exceptional phenomenon in literature. From an ethical and human point of view it is valuable only as a gauge of the degradation in which much of Roman society was sunk in the age when Persius wrote his satires—a work more pervaded by a spirit of moral purity than any other in Latin literature—and Christianity made its first converts in Rome.

But, as a work of original power, of humorous representation, of literary invention and art, the fragment deserves all the admiration which it has received. We recognize the "arbitrarius elegantissimus" in the admirable sense of the remarks scattered through it on education, on art, on poetry, and on eloquence. Though a better critic than a poet, yet he can write verse not only with good taste and simplicity, rare among the poets of that age, but with a true feeling of nature, as, for instance, in his description of a grove of plane-trees, cypresses, and pines—

"Has inter ludebat aquis errantibus annis  
Spumens et querulo venabat rore-lapillo."

And in some of his shorter pieces he anticipates the terseness and elegance of Martial. The long fragment on the Civil War does not seem to be written so much with the view of parodying as of entering into rivalry with the poem of Lucan, but he has caught the tone and style of the author whom he censures. In the epigram extemporized by Trimalchio late on in the banquet,

"Quod non expectas, ex transverso fit—  
Et supra nos Fortuna negotia curat,  
Quare da nobis vite Falerna, puer."

we have probably a more deliberate parody of the style of verses produced by the illiterate aspirants to be in the fashion of the day. We might conjecture that the chief gift to which Petronius owed his social and his literary success was that of humorous mimicry, in which the most intellectual and at the same time sensual among the Romans—as, for instance, Sulla—took a great delight. The man who could describe the dinner of Trimalchio and mimic the talk and peculiarities of the various guests with such humorous zest was just the man to keep the table in a roar during the prolonged revels in the palace of Nero. If the old "vexata questio" of the distinction between wit and humour were to be revived, the critic who could determine by analysis what is the essence of the talent of Martial on the one hand and of Petronius on the other would go very near to solving it. He would have, however, to abandon the theory that humour is more essentially humane and sympathetic than wit. Petronius is perhaps the most strictly humorous among Latin writers, and humour is in him combined with the rarer gift of conceiving and representing character. In Trimalchio and his various guests, in the old poet, in the cultivated, depraved, and moody Encolpius, in the Chrysis, Quartilla, Polyxenia, &c., we recognize in living examples the play of those various appetites, passions, and tendencies which satirists deal with in abstract qualities. Another gift he possesses in a high degree, which must have availed him in society as well as in literature,—he gift of story-telling; and some of the stories which first appear in the *Satire*—e.g., that of the Matron of Ephesus—have enjoyed a great reputation in later times. His style, too, is that of one who must have been an excellent talker, who could talk sense when sense was wanted, who could have discussed questions of taste and literature with the most cultivated men of any time as well as amused the most dissolute society of any time in their most reckless revels. One phrase of his is often quoted by many who have never come upon it in its original context, "Horatii curiosa felicitas."

Perhaps next after a day spent in the ruins of Pompeii nothing so makes us feel so near the actual daily life of the Roman world as all its petty details in the 1st century A.D. as this fragment of Petronius. Another obvious observation that is suggested by it is that of the superiority of the novel over any other form of literature for the purpose of literally reproducing the commonplace experience of actual life in every age. Opinions may differ as to the value or interest of the literal reproduction of the customs and manners of such an age as that of Nero.

Compared with the amount of attention which was given to Petronius both by scholars and men of letters in the 17th and 18th centuries, comparatively little has been done for him in recent times. The only good critical edition of a fragment is that of Böhler. An interesting chapter is devoted to him in Gaston Boissier's *L'Opposition sous l'Empire*. For those who wish to read him a modern translation, the French version by M. H. De Guérin is the one to be recommended. (W. Y. B.)

**PETROPAVLOVSK**, a district town of western Siberia, the government of Akmolinsk, is situated on the right bank of the Ishim river, 185 miles to the west of Omsk.

The old fort occupies a hill about 100 feet high, which slopes abruptly to the Ishim, while the wooden houses and the broad, unpaved, but regular streets of the town occupy partly the declivities of the hill and partly the (sometimes inundated) banks of the river. The fertile steppes to the east, west, and south of the town largely supply it with corn and cattle, and at the same time give great facilities for trade with the Kirghiz, with Turkestan, and with Bokhara. Its exports passing through the custom-house are estimated at an annual value of about £200,000, the chief items being cottons (upwards of £100,000), woollen stuffs, corn, metals, metallic wares, and spirits. The value of the cattle imports exceeds £150,000 annually, and the aggregate value of the skins, cotton-goods, furs, tea, and wool imported reaches the same figure. The town has several tallow-melting houses, tanneries, and glue and soap works; and its industries are steadily increasing. The population (7850 in 1865) now exceeds 11,500.

The small fort of Petropavlovsk, consisting of an earthen palisaded wall, was founded in 1752, and was the military centre of the Ishim line of fortifications. It became at once a place of trade with the Kirghiz, and in 1771 had a population of 914 inhabitants. It received municipal institutions in 1807.

PETROPAVLOVSK is also the name of a Russian seaport in Kamchatka, on the eastern shore of the Bay of Avatcha in 53° N. lat. and 158° 44' E. long. Its beautiful harbour, one of the best on the Pacific, is but little frequented, and the town consists merely of a few huts with some 500 inhabitants. Its naval institutions were transferred to Nikolaiovsk after the attack of the allies in 1854.

**PETROPOLIS**, a town of Brazil, in the province of Rio de Janeiro, lies at a height of 2400 feet above the sea on a beautiful and healthy plateau, surrounded by the wooded heights of the Serra da Estrella, which lie between it and the coast region. It is about 25 miles almost due north from Rio de Janeiro, and is reached by a railway (22 miles) from Maua; the last 10½ miles are on the Rigi system. Founded by the emperor of Brazil as a colony for distressed German immigrants, Petropolis has grown into an elegant and thriving town of 8000 or 10,000 inhabitants, and, besides the royal palace and park, has a number of good hotels and public buildings.

PETROVSK, a town of European Russia, in the province of Saratoff, lies on both banks of the Medveditzka, a tributary of the Don, 64 miles north-north-west of Saratoff on the Volga by the highway to Moscow. It was founded by Peter I. in 1698 to defend the district from the encroachments of the Kuban Tatars, and by the beginning of the 19th century it had become a place of 6921 inhabitants, with ten churches and a monastery (St Nicholas). In 1864 the population was 10,128, and it has since increased to upwards of 15,000.

This Petrovsk must not be confounded with (1) Petrovsk, a seaport town of from 4000 to 5000 inhabitants in northern Daghestan, which possesses one of the best roadsteads on the west coast of the Caspian; nor (2) with the crown iron-works of this name in Transbaikalia, deserving mention for its convict establishment, where the "Decembrists" were kept for several years.

PETROZAVODSK, a town of Russia, capital of the government of Olonetz, lies on the western shore of Lake Onega, 300 miles to the north-east of St Petersburg. The small river Loosinka divides it into two parts,—the town proper and the iron-works. Two cathedrals built towards the end of last century, two lyceums for boys and girls, a mining school, an ecclesiastical seminary, and several primary schools are the chief public buildings and institutions. The Government cannon-foundry can turn out annually more than 5000 tons of pig-iron, and the same weight of guns, gun-carriages, and ammunition, but its actual production is subject to great fluctuations. Within the district there are a few private iron-works as well as important saw-mills. The inhabitants engage in agriculture and fishing, and there is some trade with St Petersburg,—timber, fish, and furs being exported in exchange for corn, groceries,

and manufactured wares. The population (11,027 in 1865) was 11,970 in 1881.

Peter I., who was the first to give attention to the mineral resources of Olonetz, founded an iron-works, Petrovskii Zavod, on the Lososinka river, in 1703; the "zavod" prepared guns and arms, and within its walls a small palace and a church were built for the czar. The iron-works continued in operation for only twenty-four years; a copper-works, and subsequently a private iron-works, founded by Frenchmen, had no better success. The Government cannon-foundry was instituted in 1774; the settlement that sprang up was called Petrovsk, and received municipal institutions in 1777. Petrozavodsk became capital of the government of Olonetz in 1802.

PETTY, SIR WILLIAM (1623-1687), statistician and political economist, and author of the *Down Survey of Irish Lands*, was born on 26th May 1623. He was the son of a clothier at Romsey in Hampshire, and received his early education at the grammar-school there. About the age of fifteen he went to Caen (Normandy), taking with him a little stock of merchandise, on which he traded, and so maintained himself whilst learning French, improving himself in Latin and Greek, and studying mathematics and other sciences. On his return to England he seems to have had for a short time a place in the royal navy. He went abroad again in 1643, and remained for three years in France and the Netherlands, pursuing his studies at Utrecht, Leyden, Amsterdam, and Paris. In the last-named city he read Vesalius with the celebrated Hobbes. The philosopher was then preparing his *Tractatus Opticus*, and it is said that Petty drew the diagrams for him. In 1647 Petty obtained a patent for the invention of double writing, or, in other words, of a copying machine. In politics he espoused the side of the Parliament. His first publication was a letter to Samuel Hartlib in 1648, entitled *Advice for the Advancement of some Particular Parts of Learning*, the object of which was to recommend such a change in education as would give it a more practical character. In the same year he took up his residence at Oxford, where he was made deputy professor of anatomy, and where he gave instruction in that science and in chemistry. In 1649 he obtained the degree of doctor of physic, and was soon after elected a fellow of Brasenose College. He gained some notoriety in 1650 by restoring to life a woman who had been hanged for infanticide. In 1651 he was made professor of anatomy at Oxford, and also became professor of music at Gresham College. In 1652 he went to Ireland, having been appointed physician to the army in that country. In 1654, observing that the admeasurement and division of the lands forfeited in 1641 and granted to the soldiers had been (to use his own words) "most inefficiently and absurdly managed," he entered into a contract to execute a fresh survey, which he completed in thirteen months. By this he gained £9000, and part of the money he invested profitably in the purchase of soldiers' debentures. He thus became possessor of so large a domain in the county of Kerry that, according to Aubrey, he could behold from Mount Mangerton 50,000 acres of his own land. He set up iron-works in that neighbourhood, opened lead-mines and marble-quarries, established a pilchard-fishery, and commenced a trade in timber. In Macaulay's *History of England* there is an account of the settlement which he founded at Kenmare. Besides the office of commissioner of distribution of the lands he had surveyed, he held that of secretary to the lord lieutenant, Henry Cromwell, and was also during two years clerk of the council. In January 1658 he was elected to Richard Cromwell's parliament as member for West Looe in Cornwall. He was accused by Sir Jerome Sankey before the House of Commons of malversation and fraud in the conduct of his survey; but the matter did not come to an issue in consequence of the dissolution of the parliament, and Petty afterwards published tracts in his defence. After the Restoration he returned to England

and was favourably received and knighted by Charles II., who was "much pleased with his ingenious discourses," and who, it is said, intended to create him earl of Kilmora. He obtained from the king a new patent constituting him surveyor-general of Ireland. In 1663 he attracted much notice by the success of his invention of a double-bottomed ship, which twice made the passage between Dublin and Holyhead, but was afterwards lost in a violent storm. He was one of the first members of the Royal Society, and sat on its council. He died at London on the 16th of December 1687, and was buried in the church of his native place. His will, a curious and characteristic document, is printed in Chalmers's *Biographical Dictionary*.

Petty was a man of remarkable versatility, ingenuity, and resource. Evelyn declared he had "never known such another genius," and said of him, "If I were a prince I would make him my second councillor at least." His character does not seem to have been an elevated one, though Henry Cromwell, who knew him well, appears to have esteemed him highly.

The survey executed by Petty was, somewhat whimsically, called the "Down Survey," because the results were set down in maps; it is called by that name in Petty's will. He left in MS. a full account of the proceedings in connexion with it, which was edited by the late Major-General Sir Thomas A. Larcom for the Irish Archaeological Society in 1851. The maps, some of which were injured by a fire in 1711, are preserved in the Public Record Office, Dublin. The survey "stands to this day," says Larcom, "with the accompanying books of distribution, the legal record of the title on which half the land of Ireland is held; and for the purpose to which it was and is applied it remains sufficient." Petty's name is associated with the foundation, or, as it is safer to say, the successful prosecution of what has been somewhat too ambitiously termed "the science of political arithmetic." It is essentially the same with what is called comparative statistics. In Petty's time trustworthy numerical expressions of social facts could seldom be directly obtained, and thus large room was left for more or less probable inference from the available data. As we might have expected from his intellectual character, the expedients to which he resorts in seeking to arrive at determinations of this kind are very ingenious, but often unsatisfactory and even delusive. Whilst, however, he sometimes makes too much of the defective materials he could command, he strongly insists on accurate and continued observation as the only sure basis.

Petty was not merely a statistician, he was also a political economist, and one of no mean rank. He is one of the first in whom we find a tendency to a view of industrial phenomena which was at variance with the then dominant mercantilist ideas, and he exhibits a statesmanlike sense of the elements in which the strength of a nation really consists. Roscher names him as having, along with Locke and Dudley North, raised the English school to the highest point it attained before the time of Hume. His *Treatise of Taxes and Contributions* has been recently pronounced to be "the first great work on economic theory, which it may fairly be said to have founded." However this may be, it certainly contains a clear statement of the doctrine that price depends on the labour necessary for production. Petty is much concerned to discover a fixed unit of value, and he thinks he has found it in the necessary sustenance of a man for a day. He understands the cheapening effect of the division of labour. He states correctly the notion of "natural and true" rent as the remainder of the produce of land after payment of the cost of production; but he seems to have no idea of the "law of diminishing returns." He has much that is just on the subject of money; he sees that there may be an excess of it as well as a deficiency, and regards the prohibition of its exportation as contrary to sound policy. But he errs in attributing the fall of the rate of interest which takes place in the progress of industry to the increase in the quantity of money. He protested against the fetters imposed on the trade of Ireland, and advocated a union of that country with Great Britain. Whilst the general tendency in his day was to represent England as in a state of progressive decline—an opinion put forward particularly in the tract entitled *Britannias Linguens*—Petty declared her resources and prospects to be not inferior to those of France.

A complete list of his works is given in the *Athenæ Coniunctæ*. The most important are: the *Treatise of Taxes and Contributions* (1662, 1667, and 1685); *Political Arithmetic*, presented in MS. to Charles II., but because it contained matter likely to be offensive to France, kept unpublished till 1801, when it was edited by Petty's son Charles; *Quantulumcumque*, or a *Treatise concerning Money* (1682); *Observations upon the Dublin Bill of Mortality in 1691, and the State of that City* (1699); *Essay concerning the Multiplication of Mankind* (1696); *Political Anatomy of Ireland* (1697). Several papers appeared in the *Philosophical Transactions*. It is much to be regretted, as McCulloch long since remarked, that a complete and uniform edition of his writings has not been published.

PETUNIA. See HORTICULTURE, vol. xii. p. 264.

PEUTINGER, CONRAD (1465-1547), a prominent and

useful citizen of Augsburg, remembered for his services to the new learning. He was one of the first to publish Roman inscriptions (see vol. xiii. p. 124), and his name remains associated with the famous *Tabula Peutingeriana* (see MAPS, vol. xv. p. 517), which was in his hands when he died, and was found again among his MSS. in 1714. This important Roman itinerary table was first published as a whole by Scheyb (Vienna, 1753); the most elaborate edition is by Desjardins (Paris, 1869 and following years).

PEWTER<sup>1</sup> is a generic term for a variety of alloys, which all agree in this, that tin forms the predominating component. The finest pewter (sometimes called "tin and temper") is simply tin hardened by the addition of a trifle of copper. Ordinary pewter is tin alloyed with lead, which latter ingredient is added chiefly on account of its cheapness, and therefore often in excessive proportion. The law of France restricts the percentage of lead to 16·5, with a toleration of 1·5 per cent. of error, an alloy of this or a higher degree of richness in tin being, according to an old investigation by Vauquelin, as proof against sour wine or vinegar as pure tin is. Higher percentages of lead are dangerous, and besides spoil the appearance of the alloy. The composition of an alloy containing only these two components can be ascertained approximately by determining the specific gravity (see METALS, vol. xvi. p. 67 sq.).

Plates pewter is a hard variety much used for plates and dishes; a good quality is composed of 100 parts of tin, 8 of antimony, 2 of bismuth, and 2 of copper. Closely allied to it is the silver-white alloy called "Britannia metal," which is much used in Great Britain for the making of teapots more especially. To give an idea of its very variable composition the following two analyses may be quoted:—

Tin.....	85·7	81·9
Antimony.....	10·4	16·2
Copper.....	1·0	0·0
Zinc.....	2·9	1·9
	100·0	100·0

Pewter wares are shaped chiefly in three ways. Measures and spoons are cast in moulds of brass made of two closely-fitting but detachable halves, the surface of the mould being powdered over with sandarach, or painted over with white of egg or oil, before use to prevent adhesion. Plates and dishes are made preferably by hammering. In large establishments milk-jugs and similar articles are often produced by "spinning," i.e., by pressing a flat plate of pewter against a rapidly-revolving blunt tool, and thus raising it into the desired shape. (Cf. LEAD, vol. xiv. p. 378.)

PFÄFF, CHRISTIAN HEINRICH (1773-1852), chemist and physicist, younger brother of J. F. Pfaff noticed below, took his degree as doctor of medicine at Stuttgart in 1793. He travelled with a noble family as physician, and practised or a time at Heidenheim; but he afterwards became professor (extraordinary in 1797, ordinary in 1801) of medicine, physics, and chemistry at the university of Kiel. He was a most prolific author of memoirs on sanitary and medical, and especially on chemical and physical, subjects. His work in chemistry was chiefly analytical and mineralogical. In physics he was distinguished as one of the earlier experimenters with the voltaic current, and had a considerable share in the experimental investigation of its properties. He also made important researches on the varying power of magnets, more particularly on the effect of the extent of the attracting surface. Comparatively few of his memoirs are now quoted, owing to the fact that one of his results contained any capital discovery; nevertheless he deserves to be remembered as one of the energetic workmen who aided in raising the stately pile of modern experimental science.

PFÄFF, JOHANN FRIEDRICH (1765-1825), German mathematician, was born on 22d December 1765 at Stuttgart. He received his early education at the Carlsschule, where Schiller, afterwards his life-long friend, was a school-companion. His mathematical capacity was early noticed; and after leaving school he pursued his studies in that department at Göttingen under Kästner, author of a *History of Mathematics*; and in 1787 he went to Berlin and studied practical astronomy under Bode. In 1788 Pfaff became professor of mathematics in Helmstädt, and so continued until that university was abolished in 1810. From that time till his death (20th April 1825) he held the chair of mathematics at Halle. Pfaff's researches bore chiefly on the theory of series, to which he applied the methods of the so-called Combinatorial School of German mathematicians, and on the solution of differential equations. His two principal works are *Disquisitiones analytice maxime ad calculum integralem et doctrinam serierum pertinentes* (4to, vol. i., Helmstädt, 1797) and "Methodus generalis, æquationes differentiarum particularum, nec non æquationes differentiales vulgares, utrasque primi ordinis inter quotcumque variables, complete integrandi" in *Abh. d. Berl. Acad.* (1814-15). The former work contains Pfaff's discussion of the equation  $(a + bx^m) x^2 dy/dx^2 + (c + ex^n) x dy/dx + (f + gx^r) y = X$ , which generally bears his name, but which had originally been treated in a less complete manner by Euler. The latter work contains an important addition to the theory of partial differential equations as it had been left by Lagrange.

An interesting review of Pfaff's memoir was published by Gauss in the Göttingen *Gelehrte Anzeigen* for 1815 (republished in vol. iv. of his complete works). For fuller details regarding Pfaff and his work, consult Gerhardt, *Teschichte der Mathematik in Deutschland* (Munich, 1877, p. 198), and Pfaff's correspondence, edited by C. H. Pfaff.

Another brother of this family, JOHANN WILHELM ANDREAS PFÄFF (1774-1835), was professor of pure and applied mathematics successively at Dorpat, Nuremberg, Würzburg, and Erlangen.

PFÄLZBURG, a town of German Lorraine, lies high on the west slopes of the Vosges, 25 miles to the north-north-west of Strasburg. In 1880 it contained 3379 (mainly Roman Catholic) inhabitants. The principality of Pfalz-burg, originally a part of Luxemburg, afterwards belonged in turn to the bishop of Metz, the bishop of Strasburg, and the duke of Lorraine, and passed into the possession of France in 1661. The town was of importance as commanding the passes of the Vosges, and was strongly fortified by Vauban in 1681. The works resisted the Germans for four months in 1870, but have since been razed.

PFEIFFER, FRANZ (1815-1868), an eminent writer on mediæval German literature and on old forms of the German language, was born at Solothurn on the 27th of February 1815. Having studied at the university of Munich, he went to Stuttgart, where in 1846 he became librarian at the royal public library. In 1857, having established his fame as one of the foremost authorities on his special subject, he was appointed professor of German literature and language at the university of Vienna; and in 1860 he was made a member of the Imperial Academy of Sciences. He died on the 29th of May 1868.

As an editor of mediæval literature Pfeiffer was unsurpassed among the scholars of his day, and by his work in this department he did much to foster the critical study of writers who before his time were known only to specialists. Among the many writings edited by him may be mentioned the works of the German mystics of the 14th century, the *Buch der Natur* of Conrad of Megenberg, the *Predigten* of Berthold of Ratibon, the *Edelstein* of Ulrich Boner, the *Barlaam* and *Josaphat* of Rudolf of Ems, and the poems of Walther von der Vogelweide. Of his independent writings the most important are *Zur deutschen Literaturgeschichte*, *Ueber Wesen und Bildung der höfischen Sprache in mittelhochdeutscher Zeit*, *Der Dichter des Nibelungenliedes*, *Forschung und Kritik auf dem Gebiete des deutschen Alterthums*, and *Alldeutsches Übungsbuch*. Pfeiffer's style is clear and vigorous; and on every

<sup>1</sup> Old Fr. *peuvre*; Ital. *pellro*; comp. Eng. *speller*.

subject which he discussed he was able to throw fresh light. A biographical sketch of him by Bartsch occurs in Uhland's *Brigwessel mit Freiherrn von Lamsberg*, which Pfeiffer edited.

PFEIFFER, IDA LAURA (1797-1858), traveller, was born at Vienna, the daughter of a merchant named Beyer, 14th October 1797. Ida was the only sister of six brothers, and in her youth acquired masculine habits. Her training was Spartan, and accustomed her to the endurance of hardships and deprivations. On 1st May 1820 she married Dr Pfeiffer, a prosperous advocate of Lamsberg, twenty-four years older than herself. Through over-zeal in denouncing abuses her husband incurred official persecution, and in a few years after his marriage was reduced to the greatest poverty. Ida, living mostly apart from her husband, underwent great drudgery, but, through her own exertions, managed to educate her two sons. After being relieved of this responsibility she resolved to indulge her intense longing to travel, and, with the most limited means, succeeded in making a series of journeys which, in extent, are probably unparalleled in the case of any other woman. In 1842 Madame Pfeiffer visited Egypt and Palestine, and, with considerable hesitation, published an account of her journey in three small volumes, *Reise einer Wienerin in das Heilige Land*, in 1845. In the same year she set out again, this time to Scandinavia and Iceland, describing her tour in two volumes, *Reise nach dem Scandinavischen Norden und der Insel Island* (Pesth, 1846). In 1846 she started on her first journey round the world, visiting Brasil, Chili, and other countries of South America, Tahiti, China, India, Persia, Asia Minor, and Greece, and reaching home in 1848. The results were published in three volumes at Vienna in 1850, under the title *Eine Frauenfahrt um die Welt*. For her next and most extensive journey she received the support of the Austrian Government to the small extent of £150. Starting in 1851, she went by London to South Africa, her purpose being to penetrate into the interior; but, this proving impracticable, she proceeded to the Malay Archipelago, spending eighteen months in the Sunda Islands and the Moluccas. After a visit to Australia, Madame Pfeiffer proceeded to California, Oregon, Peru, Ecuador, New Granada, the Misiones Territory, and north again to the American lakes, reaching home in 1854. Her narrative, *Meine sechs Weltreise*, was published in four volumes at Vienna in 1856. In May of the same year Ida set out to explore Madagascar, where at first she was cordially received by the queen. Unfortunately, she unwittingly allowed herself to be involved in the plot of a Frenchman to overthrow the government, and, with brutal treatment, was expelled from the country. After being detained by her sufferings in Mauritius for some months, Ida returned by England to Vienna, where she died 27th October 1858. The *Reise nach Madagascar* was issued in 1861, with a biography by her son.

All Madame Pfeiffer's narratives have been translated into English as well as other languages, and have maintained a steady popularity up to the present time. Although Ida Pfeiffer can hardly be said to have broken up new ground in her travels, she certainly did much to increase our knowledge of countries about which our information was most meagre. Moreover, her scientific collections—for she was as good a collector as an observer—were of considerable extent, and great value and novelty, and were regarded as important acquisitions by the Vienna museum. She was made an honorary member of the Berlin and Paris Geographical Societies, and received from the king of Prussia the gold medal of science and art. Her travels altogether covered 150,000 miles by sea and 20,000 by land. Ida Pfeiffer was short in stature, and latterly slightly bent; her manners were simple, unassuming, and womanly.

PFORZHEIM, one of the chief industrial towns in the grand-duchy of Baden, is pleasantly situated at the confluence of the Nagold, the Würm, and the Enz, on the northern margin of the Black Forest, 15 miles to the south-east of Carlsruhe. The most prominent buildings are the old palace of the margraves of Baden-Durlach and

the Schlooskirche, the latter an interesting edifice of the 12th to the 15th centuries, containing the tombs and monuments of the margraves. The staple industry is the manufacture of gold and silver ware and jewellery, which gives employment to nearly 10,000 workmen, besides which there are iron and copper works, and manufactures of chemicals, paper, leather, cloth, and other articles. A briak trade is maintained in timber, cattle, and agricultural produce. In 1880 the population was 24,037, having almost doubled itself in twenty years. Four-fifths of the inhabitants are Protestants.

Pforzheim (Pforta Hercynia) is of Roman origin, and has belonged to Baden for 600 years. From about 1800 down to 1565 it was the seat of the margraves of the Baden-Durlach-Ernestine line, now extinct. The town was taken by the troops of the Catholic League in 1624, and was destroyed by the French in 1689. The story of the 400 citizens of Pforzheim who sacrificed themselves for their prince after the battle of Wimpfen (1632) has been relegated by recent historical research to the domain of legend. The humanist Reuchlin was born at Pforzheim in 1465.

PHÆDRUS, the author of five books of Latin fables in verse, lived in the reigns of Augustus, Tiberius, Caligula, and Claudius. To his literary vanity we owe most of our scanty knowledge of his life. He was born on the Pierian Mountain in Macedonia, but seems to have been brought at an early age to Italy, for he mentions that he read a verse of Ennius as a boy at school. According to the heading of the chief MS. he was a slave and was freed by Augustus. He incurred the wrath of Sejanus, the powerful minister of Tiberius, but on what grounds is not known. Devoting himself to literature, he lived in poverty and died at an advanced age. The first two books of his fables were published together; the third, fourth, and fifth appeared later, each by itself. The third book is dedicated to Eutychna, a wealthy man of business and probably a freedman, to whom the poet appeals for promised help. The fourth book is dedicated to Particulon, who seems to have dabbled in literature. From the fact that Seneca, writing in 43 or 44 A.D. (*Consol. ad Polyb.*, 27), knows of no Latin writer of fables we may infer that Phædrus published his fables after that time, but the exact date is unknown. His work shows little or no originality; he simply versified (in iambic trimeters) the fables current in his day under the name of "Æsop," interpersing them with anecdotes drawn from daily life, history, and mythology. He tells his fable and draws the moral with business-like directness and simplicity; his language is classical, neat, and clear, but thoroughly prosaic, though it occasionally attains a dignity bordering on eloquence. He is fond of abstract words. From a literary point of view Phædrus is far inferior to those masters of fable-writing, Babrius and La Fontaine; he lacks the quiet picturesqueness and pathos of the former, and the exuberant vivacity and humour of the latter. Though he frequently refers to the envy and detraction which pursued him, Phædrus seems to have attracted little attention in antiquity. He is mentioned by Martial (*ii*, 20, 5), who imitated some of his verses, and by Avianus. Prudentius must have read him, for he imitates one of his lines (*Prud., Cath.*, vii. 115; cp. Phædrus, iv. 6, 10).

The first edition of the five books of Phædrus was published by Pithou at Troyes in 1596. But, from the gaps in the books as well as from the disproportionate shortness of some of them, it is plain that this collection is incomplete. In the beginning of the 18th century there was discovered at Parma a MS. of Perotti (1430-1480), archbishop of Siponto, containing sixty-four fables of Phædrus, of which thirty-two were new. These new fables were first published at Naples by Casitto in 1808, and afterwards (much more correctly) by Jannelli in 1811. Both editions were superseded by the discovery of a much

better preserved MS. of Parotti in the Vatican, which was published by Angelo Mai in 1831. For some time the authenticity of these new fables was disputed, but they are now generally accepted, and with justice, as genuine fables of Phædrus. They do not form a sixth book, for we know from Avianus that Phædrus wrote five books only, but it is impossible to assign them to their original places in the five books. They are usually printed as an appendix. Even thus it is probable that we have not the whole of Phædrus.

In the Middle Ages Phædrus exercised a considerable influence through the prose versions of his fables which were current, though his own works and even his name were forgotten. Of these prose versions the oldest existing seems to be that known as the "Anonymus Hilaniannus," so called because first edited by Nilant at Leyden in 1709 from a MS. of the 10th or beginning of the 11th century. It approaches the text of Phædrus so closely that it was probably made directly from it. Of the sixty-seven fables which it contains thirty are derived from lost fables of Phædrus. But the largest and most influential of the prose versions of Phædrus is that which bears the name of "Romulus." It contains eighty-three fables, is as old as the 10th century, and seems to have been based on a still earlier prose version, which, under the name of "Æsop," and addressed to one Rufus, may have been made in the Carolingian period. The preface of Romulus, in which he professes to have translated the fables from the Greek, is a mere fiction of the copyist; no such Romulus as this ever existed, although in the Middle Ages he was sometimes thought to have been a Roman emperor, and has still a place in the *Biographie Universelle* (1863). The collection of fables in the Weissenburg (now Wolfenbüttel) MS. is based on the same version (the *Æsopus ad Rufum*) as Romulus. These three prose versions contain in all one hundred distinct fables, of which fifty-six are derived from the existing and the remaining forty-four presumably from lost fables of Phædrus. Some modern scholars, as Burmann, Dressler, and L. Müller, have tried to restore these lost fables by verifying the prose versions.

The collection bearing the name of Romulus became in its turn the source from which, during the second half of the Middle Ages, almost all the collections of Latin fables in prose and verse were wholly or partially drawn. A version of the first three books of Romulus in elegiac verse enjoyed a wide popularity, even into the Renaissance. Its author (generally referred to since the edition of Névelet in 1610 as the Anonymous of Névelet) was long unknown, but Hervieux has lately shown grounds for identifying him with Walther of England, chaplain to Henry II. and afterwards archbishop of Palermo. The version dates from the latter part of the 12th century. It was especially popular in Italy, where the Italian translation of Accio Zuccho (Verona, 1470) was frequently reprinted. Another version of Romulus in Latin elegiacs was made by Alexander Neckam, born at St Albans in 1157, and towards the end of his life (early part of 13th century) abbot of the Augustinian monastery at Exeter. Neckam knew and copied Walther's version, but his own never had the same popularity. Amongst the collections partly derived from Romulus the most famous is probably that in French verse by MARIE DE FRANCE (q. v.). About 1200 a collection of fables in Latin prose, based partly on Romulus, was made by the Cistercian monk Odo of Sherrington; they have a strong mediæval and clerical tinge. In 1370 Gerard of Minden wrote a poetical version of Romulus in Low German.

Since the first edition of Phædrus by Pithou in 1636 the editions and translations have been very numerous; among the editions may especially be mentioned those of Burmann (1718 and 1737), Bentley (1726), Schwabe (1806), Berger de Xivry (1830), Orelli (1832), Eysenhardt (1867), L. Müller (1877), Hervieux, in his work *Les Fabulistes Latins depuis le siècle d'Auguste jusqu'à la fin du moyen âge*, Paris, 1884. For the mediæval versions of Phædrus and their derivatives see L. Roth, in *Philologus*, l. p. 223 sq.; H. Oesterley, *Romulus die Paraphrasen des Phædrus und die aecopsche Fabel im Mittelalter*, 1070 (untrustworthy); E. Grosse, in *Jahrb. f. class. Philol.*, vol. cv. (1873); and especially the learned work of Hervieux, who gives the Latin texts of all the mediæval imitations (direct and indirect) of Phædrus, some of these texts being printed for the first time. (G. G. B.)

PHAETHON ("the shining one"), in Homer an epithet of the sun, and used by later writers as a name for the sun, is more generally known in classical mythology as a son of the Sun and the ocean nymph Clymene. He persuaded his father to let him drive the chariot of the sun across the sky, but he lost control of the horses, and driving too near the earth scorched it; mountains were set on fire, rivers and seas dried up, Libya became a desert, and the Ethiopians were blackened by the heat. To save the earth from utter destruction Zeus killed Phaethon with a thunderbolt. He fell to earth at the mouth of the Eridanus, a river of northern Europe (identified in later times with the Po), on the banks of which his weeping sisters

were transformed into poplars and their tears into amber. This part of the legend points to the mouth of the Oder or Vistula, where amber abounds. Phaethon was the subject of a drama of Euripides, of which some fragments remain. The suggestion that the legend of Phaethon is a mythical expression of vast increases of temperature produced at long intervals by changes in the relative position of the earth and the heavenly bodies was made by Plato (*Timæus*, 22 C, D).

PHALANGER. Among the anonymous additions to Charles l'Écluse's posthumous work *Cursu posteriora; seu plurimarum non ante cognitarum aut descriptarum . . . animalium novæ descriptiones*, published at Leyden in 1611, occurs the following:—

"In our third expedition, under Admiral Van der Hagen, there was seen at Amboyna a rare and truly marvellous animal. The 'cousa,' as it is called by the natives, is a reddish animal, a little larger than a cat, which has under its belly a kind of pouch in which the mammae are placed, and in this the young are born, and remain there hanging firmly on until large enough to be turned out by their mother. They return, however, continually to the pouch until sufficiently developed to follow their mother and to find food for themselves. These animals live on grass, green leaves, and other vegetable food, and their flesh is eaten by the Portuguese and other native Christians, but not by the Mohammedans, who consider the cousa to be an unclean and forbidden animal, mainly on account of its want of horns."

This early account forms the first mention of any of the numerous marsupials of the eastern hemisphere, as there can be no doubt that the animal called the cousa by the natives of Amboyna nearly 300 years ago was the Grey Cuscus (*Cuscus orientalis*), a member of the only marsupial genus occurring in any Eastern land then known to Europeans. About a hundred years afterwards the same animal was seen by the Dutch traveller Valentyn, also at Amboyna, and still later Buffon gave to a pair of cuscuses examined by him the name that heads this article, "Phalanger," on account of the peculiar structure of the second and third toes of the hind feet, which are united in a common skin to the nails, a character now known to be present in a large proportion of the Australian marsupials. Later, Captain Cook in 1770 and 1777, Governor Phillip in 1788, and J. White in 1790 discovered various different kinds of phalangers, and now we know of not less than ten genera, with about thirty-five species, forming the sub-family *Phalangistinae* of the family *Phalangistidae*, whose general characters have already been noticed in the article MAMMALIA (vol. xv. p. 382).

Phalangers as a whole are small woolly-coated animals, with long, powerful, and often prehensile tails, large claws, and, as in the American opossums, with opposable nailless great toes. Their expression seems in the day to be dull and sleepy, but by night they appear to decidedly greater advantage. They live mostly upon fruit, leaves, and blossoms, although some few feed habitually upon insects, and all relish, when in confinement, an occasional bird or other small animal. Several of the phalangers possess flying membranes stretched between their fore and hind limbs, by the help of which they can make long and sustained leaps through the air, like the flying squirrels; but it is interesting to notice that the possession of these flying membranes does not seem to be any indication of special affinity, the characters of the skull and teeth sharply dividing the flying forms, and uniting them with other species of the non-flying groups. Their skulls (see fig. 1) are as a rule broad and flattened, with the posterior part swollen out laterally, owing to the numerous air-cells situated in the substance of the squamosa. The dental formula is very variable, especially as regards the premolars, of which some at least in each genus are reduced to mere functionless rudiments, and may even vary in number on the two sides of the jaw of the same individual. The

incisors are always  $\frac{1}{1}$ , the lower one very large and proclivous, and the canines normally  $\frac{1}{1}$ , of which the inferior



FIG. 1.—Skull of Naked-eared Cuscus (*Cuscus gymnotis*). After Peters.

is always minute, and in one genus generally absent. The true molar number either  $\frac{1}{4}$  or  $\frac{3}{4}$ .

The genera, of which not less than ten must be allowed as valid, may be arranged as follows.

- I. Molars with curved crests,  $\frac{4}{2}$ .
- (A.) Pm.<sup>1</sup> minute or absent; pm.<sup>1</sup> and pm.<sup>2</sup> functional, the latter standing obliquely.
- a. Canines separated from incisors; tail hairy.....1. *Phalangeria*.  
 b. Canines close to incisors; tail naked, scaly.....2. *Cuscus*.
- (B.) Pm.<sup>1</sup> functional; pm.<sup>2</sup> forming an even series with the molars.
- a. Without a flying membrane; first two anterior toes opposite to rest; tail prehensile.....3. *Pseudochirus*.  
 b. With a flying membrane; toes normal; tail bushy, non-prehensile.....4. *Petaurista*.
- II. Molars with round or pointed cusps.
- (C.) Molars  $\frac{4}{4}$ . Functional premolars  $\frac{1}{2}$  or  $\frac{2}{2}$ .
- a. Lower premolar row interrupted; upper  $\frac{1}{1}$  directed forwards; pm.<sup>2</sup> functionless.....5. *Dactylopsila*.  
 b. Lower premolar row continuous; upper  $\frac{1}{1}$  directed downwards; pm.<sup>2</sup> functional.
- a. A flying membrane.....6. *Petaurus*.  
 b. No flying membrane.....7. *Gymnobelides*.
- (D.) Molars  $\frac{3}{3}$ .
- a. Functional premolars  $\frac{1}{1}$  or  $\frac{1}{0}$ ; tail round; no flying membrane.....8. *Dromicola*.  
 b. Functional premolars  $\frac{2}{2}$ ; tail distichous; no flying membrane.....9. *Distodromus*.  
 c. Functional premolars  $\frac{3}{3}$ ; tail distichous; a flying membrane.....10. *Acerobates*.

### I. *Phalangeria*, Ouv.

Upper incisors forming a semicircular series. Upper  $i^1$  scarcely larger than the others, parallel, its anterior surface flattened, point transversely truncated. Canines some way from and shorter than incisors, in front of the premaxillary-maxillary suture.\* Pm.<sup>1</sup> small, some way separated both from canine and pm.<sup>2</sup>; pm.<sup>2</sup> suppressed; pm.<sup>3</sup> large, obliquely placed. Molars large, quadrangular, their summits with distinct crescentic ridges. Lower incisors large; canines very small, but persistent; pm.<sup>1</sup> and pm.<sup>2</sup> small, or, commonly, absent; pm.<sup>3</sup> large and obliquely placed; molars like the upper ones.

Dental formula.— $i \frac{1.2.3}{1.0.1} c \frac{1}{1} pm \frac{1.0.3}{1.1.2.3} m \frac{1.2.3.4}{1.1.2.3} \times 2 = 34$  to 38.

Skull low, without frontal sinuses; bulls scarcely inflated; premaxillary long; the anterior palatine foramina almost confined to the premaxilla; mandible with no trace of an external opening into the inferior dental canal.

Feet normal; tail long and bushy, only naked for a few inches along the under-side of the tip.

Range.—The whole of Australia and Tasmania; not yet found in New Guinea.

This genus, by its somewhat elongated premaxilla, restriction

\* At the point of exit from the bone, but the roots are of course situated in the maxilla.

In this special dental formula, necessitated by the peculiar development of the teeth of the phalangers, the numbers are those of each individual tooth,—the larger numbers representing fully-developed functional teeth, and the smaller the minute and functionless ones. An asterisk to one of the latter shows that the tooth is sometimes or commonly absent, though it should be remarked that the presence or absence of these minute teeth is not of any systematic importance.

of the palatine foramina to the latter bones, and by the shape of its upper pm.<sup>2</sup>, shows a certain tendency towards the kangaroo (*Macropodidae*), the family to which the *Phalangeriidae* are undoubtedly most nearly allied.

The true phalangers, or opossums as they are called by the Australian colonists, consist of four or five hardly separable species, of which the best known is the Vulpine Phalanger (*Ph. vulpina*), so common in zoological gardens, where, however, it is seldom seen, owing to its nocturnal habits. It is of about the size and general build of a small fox, whence its name; its colour is grey, with a yellowish white belly, white ears, and a black tail. It is a native of the greater part of the continent of Australia, but is replaced in Tasmania by the closely allied Brown Phalanger (*Ph. fuliginosa*). Its habits are very similar to those of the Yellow-bellied Flying Phalanger (*Petaurus australis*) described below,—except that, of course, it is unable to take the wonderful flying leaps so characteristic of that animal. Like all the other phalangers, its flesh is freely eaten both by the natives and by the lower class of settlers.

### 2. *Cuscus*, Lacép.

Upper incisor row angular in front. Upper  $i^1$  considerably longer than the others, round, pointed. Canines close against the last incisors, longer than any of the other teeth, placed apparently on the suture. Pm.<sup>1</sup> well developed; pm.<sup>2</sup> minute or absent; pm.<sup>3</sup> large, rounded, its axis slightly oblique. Molars and all the lower teeth much as in *Phalangeria*, but rather larger in proportion.

Dental formula.— $i \frac{1.2.3}{1.0.1} c \frac{1}{1} pm \frac{1.0.3}{1.1.2.3} m \frac{1.2.3.4}{1.1.2.3} \times 2 = 34$  to 44.

Frontal region of skull in adult animals markedly convex, owing to the presence of large frontal sinuses; bulls not inflated; premaxillary bones very short; palatine foramen entering the maxilla; no external opening into the inferior dental canal.

Feet normal; tail long, naked and scaly for its terminal two-thirds, prehensile.

Range.—From Celebes to the Solomon Islands, and southwards through New Guinea to North Queensland.

The cuscuses are curious sleepy-looking animals, which inhabit the various islands of the East Indian archipelago as far west as Celebes, being the only marsupials found west of New Guinea. As already noted, it was a member of this genus, the Grey Cuscus (*C. ornata*), a native of Amboyna, Timor, and the neighbouring islands, which was the first Australian marsupial known to European naturalists. There are altogether about eight species known, all of about the size of a large cat; their habits resemble those of other phalangers, except that they are said to be somewhat more carnivorous.

### 3. *Pseudochirus*, Ogilb.

Upper incisor row angular. First upper incisor but little longer than the others, but nevertheless the longest tooth in the jaw. Canine small, behind suture. Pm.<sup>1</sup> rather small; pm.<sup>2</sup> and pm.<sup>3</sup> larger, each with two roots, neither placed at all obliquely. Molar quadrangular, with very distinct crescentic ridges; all the teeth from the incisors backwards forming a nearly continuous series. Lower pm.<sup>2</sup> only forming part of the molar series.

Dental formula.— $i \frac{1.2.3}{1.0.1} c \frac{1}{1} pm \frac{1.2.3}{1.1.2.3} m \frac{1.2.3.4}{1.1.2.3} \times 2 = 36$  to 44.

Skull without frontal sinuses; palatine foramina entering maxilla, as in all the following genera except *Dactylopsila*; bulls inflated; palate generally complete; a minute external opening into the inferior dental canal generally present in the position of the large vacuity characteristic of the *Macropodidae*.

Ears large; fore-feet with the first two toes together opposite to the remaining three; tail thinly-haired, prehensile.

Range.—Tasmania, Australia, and New Guinea.

There are about four species of this genus known, of which the commonest is Cook's Ring-tailed Phalanger (*Pseudochirus cooki*), an animal discovered by Captain Cook during his first voyage, at Endeavour river, North Queensland.

### 4. *Petaurista*, Desm.

Teeth almost exactly as in *Pseudochirus*, except that the lower canine is generally absent, as well as the minute first and second premolars.

Dental formula.— $i \frac{1.2.3}{1.0.1} c \frac{1}{1} pm \frac{1.2.3}{1.1.2.3} m \frac{1.2.3.4}{1.1.2.3} \times 2 = 34$  to 44.

Bulls inflated, but small; palate generally incomplete from the level of the second molar; a distinct external opening into the inferior dental canal.

Sides of the body with a broad flying membrane stretching from the elbow to just below the knee; ears large and hairy; claws long and sharp; tail bushy, round, and non-prehensile.

Habitat.—New South Wales.

The only species belonging to this genus is the large black flying Phalanger (*P. colmani*), an animal very similar to certain of the large Indian flying squirrels, and which fully agrees in its habits with the Yellow-bellied Flying Phalanger described below. In its affinities it seems to be, so to speak, a highly-specialized



*Pseudochirus*, in which the teeth have become somewhat further diminished and the flying membrane has been developed.

5. *Dactylopsila*, Gray.

Upper  $i^1$  very long, directed forwards. Canine shorter than  $i^2$ , close to it.  $Pm^2$  minute or absent;  $pm^2$  oval, in line with molars. Molars square-sided, forming a straight line, the third as long as the second. All lower premolars small and deciduous.

Dental formula.— $i \frac{1.2.3}{1.0.0} c \frac{1}{1} pm \frac{1.2.3}{1.2.3} m \frac{1.2.3.4}{1.2.3.4} \times 2 = 32$  to 40.

Palatal foramen in premaxilla; palate complete; bullae small; no external opening into inferior dental canal.

Form normal; fourth fore-toe very much longer than the others; tail bushy, rounded.

Range.—From the Aru Islands through New Guinea to North Queensland.

Of this genus two closely-allied species are described. They are beautifully striped down the back with white and grey, and are said to be insectivorous in their habits.

6. *Petaurus*, Shaw.

Upper  $i^1$  very long, directed downwards. Canine intermediate in length between  $i^2$  and  $i^3$ .  $Pm^2$  the smallest, but yet functional. Molars much rounded, as are those of all the succeeding genera;  $m^2$  much smaller than  $m^3$ . Lower premolars, though small, yet permanent and forming an uninterrupted series.

Dental formula.— $i \frac{1.2.3}{1.0.0} c \frac{1}{1} pm \frac{1.2.3}{1.2.3} m \frac{1.2.3.4}{1.2.3.4} \times 2 = 40$ .

Palatal foramen entering maxilla; bullae inflated; a small external opening into the inferior dental canal.

Sides of body with a flying membrane stretching from the outside of the tip of the anterior fifth toe to the ankle; tail bushy; ears large and nearly naked.

Range.—From New Ireland to South Australia, but not Tasmania.

This genus contains about five species, the largest of which is the Yellow-bellied Flying-Phalanger (*P. australis*), whose habits are recorded by Mr Gould as follows. "This animal is common in all the brushes of New South Wales, particularly those which stretch along the coast from Port Philip to Moreton Bay. In these vast forests trees of one kind or another are perpetually flowering, and thus offer a never-failing supply of the blossoms upon which it feeds; the flowers of the various kinds of gums, some of which are of great magnitude, are the principal favourites. Like the rest of the genus, it is nocturnal in its habits, dwelling in holes and in the spouts of the larger branches during the day, and displaying the greatest activity at night while running over the small leafy branches, frequently even to their very extremities, in search of insects and the honey of the newly-opened blossoms. Its structure being ill adapted for terrestrial habits, it seldom descends to the ground except for the purpose of passing to a tree too distant to be



FIG. 2.—Squirrel Flying-Phalanger (*Petaurus sciuroides*)

obtained by springing from the one it wishes to leave. The tops of the trees are traversed by this animal with as much ease as the most level ground is by such as are destined for terra firma. If

chased or forced to flight it ascends to the highest branch and performs the most enormous leaps, sweeping from tree to tree with wonderful address; a slight elevation gives its body an impetus which with the expansion of its membrane enables it to pass to a considerable distance, always ascending a little at the extremity of the leap; by this ascent the animal is prevented from receiving the shock which it would otherwise sustain."

A second species, *P. sciuroides*, in some ways one of the most beautiful of all mammals, has been chosen for the accompanying cut (see fig. 2).

7. *Gymnobelideus*, M<sup>c</sup>Coy.

Like *Petaurus* in every respect, but without any trace of a flying membrane.

Habitat.—Victoria.

8. *Dromicia*, Gray.

First upper incisor and canine very long.  $Pm^1$  and  $pm^2$  very minute;  $pm^3$  large. Molars rounded; their series bowed inwards. Lower canine and first two premolars very small but persistent;  $pm^3$  either large and functional or minute.

Dental formula.— $i \frac{1.2.3}{1.0.0} c \frac{1}{1} pm \frac{1.2.3}{1.2.3} m \frac{1.2.3}{1.2.3} \times 2 = 32$  to 36.

Palate incomplete; bullae very large and inflated.

No flying membrane; claws short, exceeded in length by the pads under them; toes subequal; tail thinly haired, prehensile.

Five species of Dormouse Phalangers are recorded, ranging from New Guinea to Tasmania.

9. *Distoachurus*, Peters.

Upper teeth much as in *Acrobata*, but  $pm^2$  reduced, shorter than molars, and crowded obliquely out of the molar series. Lower teeth also as in *Acrobata*, but  $pm^2$  is entirely suppressed.

Dental formula.— $i \frac{1.2.3}{1.0.0} c \frac{1}{1} pm \frac{1.2.3}{1.2.3} m \frac{1.2.3}{1.2.3} \times 2 = 34$ .

Skull as in *Acrobata*.

No flying membrane; tail distichous; ears very short; claws well developed.

Habitat.—New Guinea only, whence a single species is known.

10. *Acrobata*, Desm.

Upper  $i^1$  long. Canine proportionally more developed than in any other phalanger, pressed close against last incisor. Premolars all long, narrow, sharply pointed, and two-rooted. Lower  $pm^2$  minute, but always present;  $pm^3$  and  $pm^4$  functional, shaped like the upper ones.

Dental formula.— $i \frac{1.2.3}{1.0.0} c \frac{1}{1} pm \frac{1.2.3}{1.2.3} m \frac{1.2.3}{1.2.3} \times 2 = 36$ .

Palate incomplete; bullae low and small; palatal foramen nearly all in the maxillary; a well-marked external opening into the inferior dental canal; squamosals but little swollen by air-cells.

A flying membrane present, stretching from the elbow to the knee, but very narrow in its centre; tail distichous, probably slightly prehensile; toes subequal; claws small and far surpassed by the very remarkable toe-pads, which are broad and ribbed, resembling those of a gecko, and evidently have a very definite adhesive power.

Range.—South and eastern Australia.

There is only one species in this genus, the beautiful little Pigmy Flying-Phalanger, not so big as a mouse, which feeds on the honey it can abstract from flowers, and on insects. Its agility and powers of leaping are exceedingly great, and it is said by Mr Gould to make a most charming little pet. (O. T.)

PHALARIS, a Greek tyrant, who ruled Agrigentum (Agragas) in Sicily for sixteen years (probably between c. 571 and 549 B.C.). He was the son of Laodamas, and his family belonged to the Dorian island of Astypalea, near Cnidus. As a leading man in the new city (for Agrigentum had been founded by the neighbouring city of Gela only a few years before, 582 B.C.) Phalaris was entrusted with the building of the temple of Zeus Atabyrius on the citadel, and he took advantage of his position to make himself master of the city. Under his rule Agrigentum seems to have attained a considerable pitch of external prosperity. He supplied the city with water, adorned it with fine buildings, and strengthened it with walls. His influence reached to the northern coast of the island, where the people of Himera elected him general, with absolute power, in spite of the warnings of the poet Stesichorus. Eastward on the coast he had fortified posts at Ecnomus and Phalarium, and he is said to have conquered Leontini; but that he ruled the whole of Sicily, as Suidas asserts, is unlikely. He was at last overthrown, apparently by a combination of the noble families, headed by the rich and distinguished Telamachus, and he was burned, along with his mother

and friends, in the brazen bull. A decree was carried that no one should thereafter wear a blue dress, as blue had been the tyrant's livery.

After ages have held up Phalaris to infamy for his excessive cruelty. In his brazen bull, invented, it is said, by Perilaus of Athens, and presented by him to Phalaris, the tyrant's victims were shut up and, a fire being kindled beneath, were roasted alive, while their shrieks, conveyed through pipes in the beast's nostrils, represented the bellowing of the bull. Perilaus himself is said to have been the first victim. There is hardly room to doubt that we have here a tradition of human sacrifice in connexion with the worship of the Phœnician Baal, such as prevailed at Rhodes, where Zeus Atabyrius was no other than Baal; when misfortune threatened Rhodes the brazen bulls in his temple bellowed. The Rhodians brought this worship to Gela, which they founded conjointly with the Cretans, and from Gela it passed to Agrigento. Human sacrifices to Baal were common; and, though in Phœnicia proper there is no proof that the victims were burned alive (see *MOLOCH*), the Carthaginians had a brazen image of Baal, from whose down-turned hands the children slid into a pit of fire; and the story that Minos had a brazen man who pressed people to his glowing breast points to similar rites in Crete, where the child-devouring Minotaur must certainly be connected with Baal and the favourite sacrifice to him of children. So, too, we have the fire-spitting bull of Marathon which burned Androgeus. The stories that Phalaris threw men into boiling cauldrons and vessels filled with fire, and that he devoured sucklings, all tell the same tale. From this point of view we may perhaps reconcile with history the apparently contradictory tradition which seems to have prevailed in later times, that Phalaris was a naturally humane man and a patron of philosophy and literature. This is the view of his character which we find in the declamations ascribed to Lucian, and in the letters which bear Phalaris's own name. Plutarch, too, though he takes the unfavourable view, mentions that the Sicilians gave to the severity of Phalaris the name of justice and a hatred of crime. It is recorded that he once pardoned two men who had conspired against him. Phalaris may thus have been one of those men, not unknown in history, who combine justice and even humanity with a religious fanaticism which shrinks from no horrors believed to be demanded by the cause of God.

The letters bearing the name of Phalaris (148 in number) are now chiefly remembered for the crushing exposure they received at the hands of Bentley in his controversy with the Hon. Charles Boyle, who had published an edition of them in 1695. The first edition of Bentley's *Dissertation on Phalaris* appeared in 1697, and the second edition, replying to the answer which Boyle published in 1698, came out in 1699. From the mention in the letters of towns (Phintia, Alessa, and Tauromenium) which did not exist in the time of Phalaris, from the imitations of authors (Herodotus, Democritus, Euripides, Callimachus) who wrote long after he was dead, from the reference to tragedies, though tragedy was not yet invented in the lifetime of Phalaris, from the dialect, which is not Dorian but Attic, say, New or Late Attic, as well as from absurdities in the matter, and the entire absence of any reference to them by any writer before Stobæus (who lived apparently about 500 A.D.), Bentley sufficiently proved that the letters were written by a sophist or rhetorician hundreds of years after the death of Phalaris. Suidas admired the letters, which he thought genuine, and in modern times, before their exposure by Bentley, they were admired by some, e.g., by Sir William Temple, though others, as Politian and Erasmus, perceived that they were not by Phalaris.

There are editions of the epistles of Phalaris by Lennep and Valkensker, Groningen, 1777 (re-edited, with corrections and additions, by Schaefer, Leipzig, 1823), and by R. Hercher, in *Epistolographi Græci*, Paris, 1873. The latest edition of Bentley's *Dissertation* is that with introduction and notes by W. Wagner, London, 1883.

PHARAOH (פִּרְעוֹן; *Pharao*), which the Old Testament often uses as if it were a proper name, applicable to any king of Egypt, though sometimes such a distinguishing name as Hophra (Apries; Jer. xlv. 30) or Nechoh (Nekos) (2 Kings xxiii. 29) is added, is really an Egyptian title of the monarch (Perâa or Phuro), often found on the monuments. Apart from Hophra and Necho the Biblical Pharaohs cannot, in the present state of Hebrew and Egyptian chronology, be identified with any certainty.

PHARISEES (פְּרִישִׁי, *Pharisæoi*), the Jewish party of the scribes, the opponents of the Sadducees. See ISRAELI, vol. xiii. p. 423 *sq.*, and MESSIAH.

PHARMACOPŒIA (lit. the art of the *φαρμακοποιός*, or drug-compounder) in its modern technical sense denotes a book containing directions for the identification of simples and the preparation of compound medicines, and

published by the authority of a Government or of a medical or pharmaceutical society. The name has also been applied to similar compendiums issued by private individuals. The first work of the kind published under Government authority appears to have been that of Nürnberg in 1542; a passing student named Valerius Cordus showed a collection of medical receipts, which he had selected from the writings of the most eminent medical authorities, to the physicians of the town, who urged him to print it for the benefit of the apothecaries, and obtained for his work the sanction of the *senatus*. An earlier work, known as the *Antidotarium Florentinum*, had been published, but only under the authority of the college of medicine of Florence. The term "pharmacopœia" first appears as a distinct title in a work published at Basel in 1561 by Dr A. Foes, but does not appear to have come into general use until the beginning of the 16th century. Before 1542 the works principally used by apothecaries were the treatises on simples by Avicenna and Serapion; the *De Synonymis* and *Quid pro Quo* of Simon Januensis; the *Liber Servitoris* of Bulchasim Ben Aberazerim, which described the preparations made from plants, animals, and minerals, and was the type of the chemical portion of modern pharmacopœias; and the *Antidotarium* of Nicolaus de Salerno, containing Galenical compounds arranged alphabetically. Of this last work there were two editions in use,—Nicolaus magnus and Nicolaus parvus; in the latter, several of the compounds described in the large edition were omitted and the formulæ given on a smaller scale.

Until 1617 such drugs and medicines as were in common use were sold in England by the apothecaries and grocers. In that year the apothecaries obtained a separate charter, and it was enacted at the same time that no grocer should keep an apothecary's shop. The preparation of physicians' prescriptions was thus confined to the apothecaries, upon whom pressure was brought to bear, in order to make them dispense accurately, by the issue of a pharmacopœia in May 1618 by the College of Physicians, and by the power which the wardens of the apothecaries received in common with the censors of the College of Physicians of examining the shops of apothecaries within 7 miles of London and destroying all the compounds which they found unfavourably prepared. This, which was the first authorised *London Pharmacopœia*, was selected chiefly from the works of Mesue and Nicolaus de Salerno, with a few additions from those of other authors then in repute, but it was found to be so full of errors that the whole edition was cancelled, and a fresh one was published in the following December. At this period the compounds employed in medicine were often heterogeneous mixtures, some of which contained from 20 to 70, or more ingredients, while a large number of simples were used in consequence of the same substance being supposed to possess different qualities according to the source from which it was derived. The crabs' eyes, pearls, oyster-shells, and coral were supposed to have different properties. Among other disgusting ingredients entering into some of these formulæ were the excrements of human beings, dogs, mice, geese, and other animals, calculi, human skull and moss growing on it, blind puppies, earthworms, &c. Although other editions of the *London Pharmacopœia* were issued in 1621, 1632, 1639, and 1677, it was not until the edition of 1721, published under the auspices of Sir Hans Sloane, that any important alterations were made. In this issue many of the ridiculous remedies previously in use were omitted, although a good number were still retained, such as dog's excrement, earthworms, and moss from the human skull; the botanical names of herbal remedies were for the first time added to the official ones; the simple distilled waters were ordered

of a uniform strength; sweetened spirits, cordials, and ratifias were omitted as well as several compounds no longer used in London, although still in vogue elsewhere. A great improvement was effected in the edition published in 1746, in which only those preparations were retained which had received the approval of the majority of the pharmacopœia committee; to these was added a list of those drugs only which were supposed to be the most efficacious. An attempt was made to simplify further the older formulae by the rejection of the superfluous ingredients which had been introduced during a succession of ages, and by retention of the known active ingredients. In the edition published in 1788 the tendency to simplify was carried out to a much greater extent, and the extremely compound medicines which had formed the principal remedies of physicians for 2000 years were discarded, while a few powerful drugs which had been considered too dangerous to be included in the *Pharmacopœia* of 1765 were restored to their previous position. In 1809 the French chemical nomenclature was adopted, and in 1815 a corrected impression of the same was issued. Subsequent editions were published in 1824, 1836, and 1851.

The first *Edinburgh Pharmacopœia* was published in 1699 and the last in 1841; the first *Dublin Pharmacopœia* in 1807 and the last in 1850.

The preparations contained in these three pharmacopœias were not all uniform in strength, a source of much inconvenience and danger to the public, when powerful preparations such as dilute hydrocyanic acid were ordered in the one country and dispensed according to the national pharmacopœia in another. This inconvenience led to the insertion of a provision in the Medical Act of 1858, by which it was ordained that the General Medical Council should cause to be published under their direction a book containing a list of medicines and compounds, and such other matters and things relating thereto, as the General Council should think fit, to be called the *British Pharmacopœia*, which should for all purposes be deemed to be a substitute throughout Great Britain and Ireland for the several above-mentioned pharmacopœias. Hitherto these had been published in Latin. The first *British Pharmacopœia* was published in the English language in 1864, but gave such general dissatisfaction both to the medical profession and to chemists and druggists that the General Medical Council brought out a new and amended edition in 1867. This dissatisfaction was probably owing partly to the difficulty met with in selecting a due proportion of formulae from each pharmacopœia so as to avoid giving offence to national susceptibilities, and partly to the fact that the majority of the compilers of the work were men not engaged in the actual practice of pharmacy, and therefore competent rather to decide upon the kind of preparations required than upon the method of their manufacture. The necessity for this element in the construction of a pharmacopœia is now fully recognized in other countries, in most of which pharmaceutical chemists are duly represented on the committee for the preparation of the legally recognized manuals.

National pharmacopœias now exist in the following countries:—Austria, Belgium, Denmark, France, Germany, Great Britain, Greece, Holland, Hungary, India, Mexico, Norway, Portugal, Russia, Spain, Sweden, and the United States of America. The Argentine Republic, Chili, and Japan have each a pharmacopœia in preparation. All the above-mentioned were issued under the authority of Government, and their instructions have the force of law in their respective countries, except those of the United States and Mexico, which were prepared by commissioners appointed by medical or pharmaceutical societies, and have no other authority, although generally accepted as the national text-books. Italy has no national pharmacopœia, the authorities used in the different states prior to the unification being still retained. Sardinia, for example, has a pharmacopœia dating from 1853; Modena, Parma, and Piacenza have one in common, published in 1839; in the States

of the Church as well as in Tuscany and Lucas an unofficial compilation is in use entitled *Orologio Farmacologico tecnico pratico ovvero Farmacologia Italiana*; Naples has its *Biscattario Farmacopœico Napoletano* (1856); and Lombardy and Venice use the Austrian pharmacopœia. Although Switzerland has a national pharmacopœia, this does not possess Government authority, the French *Codex* being recognized in Geneva, and the canton of Ticino having a pharmacopœia of its own.

The French *Codex* has probably a more extended use than any other pharmacopœia outside the limits of its own country, being, in connexion with Dorvault's *L'Officine*, the standard for druggists in a large portion of Central and South America; it is also official in Turkey. The sum-total of the drugs and preparations it contains is about 2000, or more than double the average of other modern pharmacopœias. The progress of medical knowledge during the last two hundred years has led to a gradual but very perceptible alteration in the contents of the various pharmacopœias. The original very complex formulae have been gradually simplified until only the most active ingredients have been retained, and in many cases the active principles have to a large extent replaced the crude drugs from which they were derived. From time to time such secret remedies of druggists or physicians as have met with popular or professional approval have been represented by simpler official preparations.

*International Pharmacopœia*.—The increased facilities for travel during the last fifty years have brought into greater prominence the importance of an approach to uniformity in the formulae of the more powerful remedies, such as the tinctures of aconite, opium, and nux vomica, in order to avoid danger to patients when a prescription is dispensed in a different country from that in which it was written. Attempts have been made during the last few years by international pharmaceutical and medical conferences to settle a basis on which an international pharmacopœia could be prepared, but, owing to national jealousies and the attempt to include too many preparations in such a work, it has not as yet been produced. At the fifth International Pharmaceutical Congress held in London in 1881, however, a resolution was passed to the effect that it was necessary that such a pharmacopœia should be prepared, and a commission consisting of two delegates from each of the countries represented was recommended to be appointed in order to prepare within the shortest possible time a compilation in which the strength of all potent drugs and their preparations should be equalized,—the work, when complete, to be handed over to their respective Governments or to their pharmacopœia committees. It appears probable that such a work will be presented for consideration by the commission at the forthcoming meeting of the congress at Brussels in 1885.

Several unofficial universal pharmacopœias have been published from time to time in England and in France, which serve to show the comparative strength of parallel preparations in different countries; but the results of discussions which have taken place at the international conferences above alluded to indicate that the production and acceptance of an international pharmacopœia will be a work of time, and that in such a work the numerous drugs and preparations intended to meet an unprofessional demand rather than the wants of physicians will have to be omitted. The advances that have been made in this direction are as follows. The metric or decimal mode of calculation and the centigrade scale of temperature are adopted in all pharmacopœias except those of Great Britain, of India, and in some instances of Greece. The majority omit chemical formulae. An alphabetical arrangement is followed in all except the French, Spanish, and Greek. The great increase of medical literature and international exchange of medical journals has led to the adoption in almost every country of all the really valuable remedial agents, and the more extended use of active principles has given rise to an approximation in strength of their solutions. The difficulty of nomenclature could probably be overcome by a list of synonyms being given with each article, and that of language by the use of Latin. The greatest stumbling-blocks in the way of uniformity are the tinctures and extracts,—a class of preparations containing many very powerful drugs, but in which the same name does not always indicate the same thing; thus, extract of aconite signifies an extract of the root in the pharmacopœias of the United States, Austria, Hungary, and Russia, extract of the leaves in the Danish and Portuguese, inspissated juice of the fresh leaves in the British, Indian, Spanish, and Greek, and dry extract of the leaves with sugar of milk in the Norwegian pharmacopœias. It appears probable, however, that the growth of pharmaceutical chemistry will indicate clearly, in course of time, which of those in use form the most active and reliable preparations, while the general adoption of the metric system will lead to clearer approximation of strength than hitherto. The method adopted by the Portuguese pharmacopœia comes nearest to that uniformity which is so desirable in such preparations, as the tinctures of the fresh plants are all prepared with equal parts of the drug and alcoholic menstruum; simple tinctures in general, with unfortunately a few exceptions, with one part of the drug in five parts of alcohol of given

strength; ethereal tinctures are in the proportion of one part in ten; and the tinctures of the alkaloids and their salts contain one part of the alkaloid in ninety-nine of menstruum.

Homoeopathic and eclectic practitioners as well as dentists have also their special pharmacopias.

See Bell and Redwood, *Progress of Pharmacy* (London, 1890); Scherer, *Literature Pharmacopœorum* (Leipzig and Bonn, 1872); Flint, *Report on the Pharmacopias of all Nations* (Washington, 1833); *Report of the Proceedings of the Fifth International Pharmaceutical Congress* (1881). (E. M. H.)

**PHEASANT**, Middle-English *Fesant* and *Fesoun*, German *Fasan* and anciently *Fasant*, French *Faisan*—All from the Latin *Phasianus* or *Phasiana* (*sc. avis*), the Bird brought from the banks of the river Phasis, now the Rioni, in Colchia, where it is still abundant, and introduced by the Argonauts, it is said, in what passes for history, into Europe. As a matter of fact nothing is known on this point; and, judging from the recognition of the remains of several species referred to the genus *Phasianus* both in Greece and in France,<sup>1</sup> it seems not impossible that the ordinary Pheasant, the *P. colchicus* of ornithologists, may have been indigenous to this quarter of the globe. If it was introduced into England, it must almost certainly have been brought hither by the Romans; for, setting aside several earlier records of doubtful authority,<sup>2</sup> Bishop Stubbs has shown that by the regulations of King Harold in 1059 "*unus phasianus*" is prescribed as the alternative of two Partridges or other birds among the "*pitantias*" (rations or commons, as we might now say) of the canons of Waltham Abbey, and, as Prof. Dawkins has remarked (*Ibis*, 1869, p. 358), neither Anglo-Saxons nor Danes were likely to have introduced it into England. It seems to have been early under legal protection, for, according to Dugdale, a licence was granted in the reign of Henry I. to the abbot of Amesbury to kill hares and pheasants, and from the price at which the latter are reckoned, in various documents that have come down to us, we may conclude that they were not very abundant for some centuries, and also that they were occasionally artificially reared and fattened, as appears from Upton,<sup>3</sup> who wrote about the middle of the 15th century, while Henry VIII. seems from his privy purse expenses to have had in his household in 1532 a French priest as a regular "*fesant breder*," and in the accounts of the Kytsons of Hengrave in Suffolk for 1607 mention is made of wheat to feed Pheasants, Partridges, and Quails.

Within recent years the practice of bringing up Pheasants by hand has been extensively followed, and the numbers so reared vastly exceed those that are bred at large. The eggs are collected from birds that are either running wild or kept in a mew,<sup>4</sup> and are placed under domestic Hens; but, though these prove most attentive foster-mothers, much additional care on the part of their keepers is needed

<sup>1</sup> These are *P. archiaci* from Piskermi, *P. altus* and *P. medius* from the lacustrine beds of Samsan, and *P. demoyeri* from Touraine, see A. Milne-Edwards, *Ois. Juss. de la France* (ii. pp. 229, 239-243).

<sup>2</sup> Among these perhaps that worthy of most attention is in Probert's translation of *The Ancient Laws of Cambria* (ed. 1823, pp. 367, 368), wherein extracts are given from Welsh triads, presumably of the age of Howel the Good, who died in 948. One of them is "There are three barking hunts: a bear, a squirrel, and a pheasant." The explanation is "A pheasant is called a barking hunt, because when the pointers come upon it, and chase it, it takes to a tree, where it is hunted by baying." The present writer has not been able to trace the manuscript containing these remarkable statements so as to find out what is the original word rendered "Pheasant" by the translator; but a reference to what is probably the same passage with the same meaning is given by Ray (*Synops. Meth. Animalium*, pp. 213, 214) on the authority of Liwyd or Lloyd, though there is no mention of it in Wotton and Clarke's *Leges Wallicæ* (1730). A charter (Kemble, *Cod. Diplom.*, iv. p. 236), professedly of Edward the Confessor, granting the wardenship of certain forests in Essex to Ralph Peperking, speaks of "*fesant hen*" and "*fesant cocke*," but is now known to be spurious.

<sup>3</sup> In his *De studio militari* (not printed till 1654) he states (p. 195) that the Pheasant was brought from the East by "Palladius ancorista."

<sup>4</sup> The writer is informed that, in 1833, 134,000 Pheasants' eggs were sold from one estate in Suffolk.

to ensure the arrival at maturity of the poults; for, being necessarily crowded in a comparatively small space, they are subject to several diseases which often carry off a large proportion, to say nothing of the risk they run by not being provided with proper food, or by meeting an early death from various predatory animals attracted by the assemblage of so many helpless victims. As they advance in age the young Pheasants readily take to a wild life, and indeed can only be kept from wandering in every direction by being plentifully supplied with food, which has to be scattered for them in the coverts in which it is desired that they should stay. Of the proportion of Pheasants artificially bred that "come to the gun" when the shooting season arrives it is impossible to form any estimate, for it would seem to vary enormously, not only irregularly according to the weather, but regularly according to the district. In the eastern counties of England, and some other favourable localities, perhaps three-fourths of those that are hatched may be satisfactorily accounted for; but in many of the western counties, though they are the objects of equally unremitting or even greater care, it would seem that more than half of the number that live to grow their feathers disappear inexplicably before the coverts are beaten. The various effects of the modern system of Pheasant-breeding and Pheasant-shooting need here be treated but briefly. It is commonly condemned as giving encouragement to poaching, and, especially under ignorant management, as substituting slaughter for sport. Undoubtedly there is much to be said on this score; but in reply to the first objection it has been urged that as a rule the poacher does not like visiting coverts that he knows to be effectively preserved, and that coverts containing a great stock of Pheasants, whose rearing has cost a considerable sum of money, are probably the most effectively preserved. As to the second objection it is to be observed that what constitutes sport is in great measure a matter of individual taste, and that the reasonable limit of a sportsman's "bag" is practically an unknown quantity. One man likes shooting a Pheasant rising at his feet or sprung by his spaniels, as it flies away from him through the trees and is still labouring to attain its full speed; another prefers shooting one that has mounted to its greatest height, and, assisted perhaps by the wind, is traversing the sky at a pace that almost passes calculation. If skill has to be considered in the definition of sport there can be no doubt as to which of these cases most requires it. In regard to cruelty—that is, the proportion of birds wounded to those killed—there seems to be little difference, for the temptation to take "long shots" is about equal in either case. The Pheasant whose wing is broken by the charge, if at a great height, is often killed outright by the fall, whereas, if nearer the ground, it will often make good its escape by running, possibly to recover, or more possibly to die after lingering in pain for a longer or shorter time. On the other hand, high-flying Pheasants, having their vital parts more exposed, are often hit in the body, but not hard enough to bring them down, though the wound they have received proves mortal, and the velocity at which they are travelling takes them beyond reach of retrieval.

Formerly Pheasants were taken in snares or nets, and by hawking; but the crossbow was also used, and the better to obtain a "sitting shot," for with that weapon men had not learnt to "shoot flying"; dogs appear to have been employed in the way indicated by the lines under an engraving by Hollar, who died in 1677:—

"The Pheasant Cocke the woods doth most frequent,  
Where Spaniels spring and perche him by the sent."<sup>5</sup>

<sup>5</sup> Quoted by the writer (Broderip!) of the article "Spaniel" in the *Penny Cyclopædia*. The lines throw light on the asserted Welsh practice mentioned in a former note.

The use of firearms has put an end to the older practices, and the gun is now the only mode of taking Pheasants recognised as legitimate.

Of the many other species of the genus *Phasianus*, two only can be dwelt upon here. These are the Ring-necked Pheasant of China, *P. torquatus*, easily known by the broad white collar, whence it has its name, as well as by the pale greyish-blue of its upper wing-coverts and the light buff of its flanks, and the *P. versicolor* of Japan, often called the Green Pheasant from the beautiful tinge of that colour that in certain lights pervades almost the whole of its plumage, and, deepening into dark emerald, occupies all the breast and lower surface that in the common and Chinese birds is bay barred with glossy black scallops. Both of these species have been to a considerable extent introduced into England, and cross freely with *P. colchicus*, while the hybrids of each with the older inhabitants of the woods are not only perfectly fertile *inter se*, but cross as freely with the other hybrids, so that birds are frequently found in which the blood of the three species is mingled. The hybrids of the first cross are generally larger than either of their parents, but the superiority of size does not seem to be maintained by their descendants. White and pied varieties of the common Pheasant, as of most birds, often occur, and with a little care a race or breed of each can be perpetuated. A much rarer variety is sometimes seen; this is known as the Bohemian Pheasant, not that there is the least reason to suppose it has any right to such an epithet, for it appears, as it were, accidentally among a stock of the pure *P. colchicus*, and offers an example analogous to that of the jappaned Peafowl already noticed (*PHACOCK*, *supra*, p. 443), being, like that breed, capable of perpetuation by selection. To a small extent two other species of Pheasant have been introduced to the coverts of England—*P. reevesi* from China, remarkable for its very long tail, white with black bars,<sup>1</sup> and the Copper Pheasant, *P. amherstii*, from Japan. The well-known Gold and Silver Pheasants, *P. pictus* and *P. sybhemorus*, each the type of a distinct section or sub-genus, are both from China and have long been introduced into Europe, but are only fitted for the aviary. To the former is allied the still more beautiful *P. amherstii* and to the latter about a dozen more species, most of them known to Indian sportsmen by the general name of "Kaleegs." The comparatively plain Pucras Pheasants, *Pucrasia*, the magnificent Monauls, *Lophophorus*, and the fine Snow-Pheasants, *Crossoptilus*—of each of which genera there are several species—must, for want of space, be only mentioned here. All the species known at the time are beautifully figured from drawings by Mr Wolf in Mr Elliot's grand *Monograph of the Phasianide* (2 vols., fol., 1870-72)—the last term being used in a somewhat general sense. With a more precise scope Mr Tegetmeier's *Pheasants: their Natural History and Practical Management* (4to, ed. 2, 1881) is to be commended as a very useful work (A. N.)

**PHENOL.** See CARBOLIC ACID, vol. v. p. 85.

**PHERECRATES**, one of the chief poets of the Old Attic Comedy, was a contemporary of Cratinus, Crates, and Aristophanes, being older than the last and younger than the two former. At first an actor, he seems to have gained a prize for a play in 438 B.C. The only other ascertained date in his life is 420, when he produced his play *The Wild Men*. Like Crates, whom he imitated, he abandoned personal satire for more general themes. Still in some of the fragments of his plays we find him attacking Alcibiades and others. He was especially famed for his inventive imagination, and the elegance and purity

of his diction are attested by the epithet *ἀττικώτατος* ("most Attic") applied to him by Athenæus and the sophist Phrynichus. However, Meineke has shown from his remains that his language deviated considerably from the standard observed by the other comic poets of the day. There is genuine feeling in his address to old age (preserved by Stobæus, *Flor.*, 116, 12). He was the inventor of a new metre, which was called, after him, *Pherecrætan*,<sup>2</sup> and frequently occurs in the choruses of Greek tragedies and in Horace.

Pherecrates is variously stated by ancient authorities to have composed eighteen and sixteen plays; Meineke reduces the list of his undoubted plays to thirteen. None of them are extant, but a considerable number of fragments have been preserved. These are given in Meineke, *Fragmenta Comœorum Græcorum*, vol. ii. (1839), and in Bothe, *Frag. Com. Gr.* (Paris, 1855).

**PHERECYDES** or **SYROS**, one of the earliest Greek philosophers, was the son of Babus and a native of the island of Syros. The dates of his life are variously stated, but there seems to be no doubt that he lived in the 6th century B.C.; amongst his contemporaries were Thales and Anaximander. He was sometimes reckoned one of the Seven Wise Men, and a very uniform tradition represented him as the teacher of Pythagoras. Many wonderful tales were told of him, e.g., that from drinking water drawn from a well he was able to predict an earthquake three days before it took place. The accounts of his death are very discrepant, but the commonest was that he died of the *morbus pediculæus*. But, if the minute description which Hippocrates gives of the death of Pherecydes refers to the philosopher, he would seem to have died of a virulent fever, perhaps spotted typhus. He is said to have been the first Greek author who wrote in prose, but perhaps the chronicler Cadmus of Miletus preceded him. The statements of late writers, that he drew his philosophy from secret writings of the Phœnicians, and that he was a disciple of the Egyptians and Chaldeans, deserve little attention, made as they were at a time when it was the fashion to regard all wisdom as derived from the East. He was credited with having originated the doctrine of metempsychosis, while Cicero and Augustine even assert that he was the first to teach the immortality of the soul. Of his astronomical studies he left a proof in the "heliotropion," a cave at Syros which served to determine the annual turning-point of the sun, like the grotto of Posillipo at Naples.

In his book, to which Suidas gives the name of *ἐπιταφιαία* *ἢ θεογονία*, he enunciated a system in which philosophy and mythology were blended. In the beginning, according to Pherecydes, were Zeus, Chronos (Time) or Cronus, and Chthon (Earth); Chronos begat Fire, Wind, and Water, and these three begat numerous other gods.

Another **PHERECYDES** of Athens, an early Greek historian, was a native of the island of Leros, and lived in the former half of the 5th century B.C. Amongst his contemporaries were Hecataeus and Herodotus. Of his works "On Leros," "On Iphigenia," "On the festivals of Dionysus" nothing remains; but numerous fragments of his great work on mythology, in ten books, have been preserved, and are collected by C. Müller in his *Fr. Hist. Gr.*, vol. i.

**PHIDIAS** (*Φειδίας*), the most famous of Greek sculptors, was born about 500 B.C., and began his artistic career, probably under the guidance of his father, Charmides of Athens, with the study of painting, an art which at that time had attained a singular largeness and dignity of style, while in sculpture these qualities were as yet being sought for with only a somewhat bold and rude result, as may be seen from the remains of it now at Olympia. To do justice to the art of sculpture in this direction there was need of a far greater mastery of technical methods, and we may suppose it to have been with this end in view that Phidias, when he had determined to

<sup>1</sup> The introduction of this species by Lord Tweedmouth near Gateshead in Inverness-shire is said to have been remarkably successful.

<sup>2</sup> — — — — — or, as it may be otherwise divided, — — — — —

devote himself to sculpture, became a pupil of Ageladas of Argos. It is tempting to believe that it was still under the influence of this master that he executed (between 469 and 463) the Athenian monument at Delphi commemorating the battle of Marathon; for Ageladas had sculptured at Delphi also a monumental group serving a similar purpose. In the group of Phidias was a portrait statue of Miltiades, and from this circumstance it is rightly inferred that the work had been commissioned at the time when Cimon, the son of Miltiades, was at the head of affairs in Athens. It was apparently at this same period that Phidias was employed to execute for the acropolis of Athens a statue of Athena. This statue, known in after times as "the Lemnian" and also as "the beauty," seems to have represented the goddess in the attitude of standing at rest, helmet in hand, as in a terra-cotta statuette from Cyprus in the British Museum.<sup>1</sup> When Pericles succeeded to the administration of affairs, and it was determined to erect new temples and other public buildings worthy of the new glory which Athens had acquired in the Persian wars, it was to Phidias that the supervision of all these works was entrusted, with an army of artists and skilled workmen under him. By 438 the Parthenon was completed, with its colossal statue of Athena in gold and ivory by Phidias himself, and with its vast extent of sculpture in marble, executed at least under his direction and reflecting in most parts his genius.<sup>2</sup> Meantime the enormous expense of these undertakings had involved Phidias in the public discontent which was growing up round Pericles (Aristoph., *Peace*, 605). The story related by Plutarch (*Pericles*, 31) is that Menon, a former assistant of Phidias, had brought a charge against him of having appropriated part of the gold and ivory allowed him for the statue of Athena, and that, being acquitted on this charge, he was next denounced for introducing portraits of himself and of Pericles on the shield of Athena, and in consequence of this charge died in prison, either a natural death or by poison. But these statements cannot be reconciled with the tradition that, after completing his Athena, he was invited to undertake at Olympia what proved to be the grandest work of his life, the colossal gold and ivory statue of Zeus in the newly-erected temple. According to this same tradition he died at Olympia, and it may be inferred that he died much honoured there from the fact that his workshop was preserved in after times as a show-place for visitors, and that his descendants obtained an hereditary right to look after the great statue of Zeus. As a means of reconciling these conflicting statements it has been supposed that the charge of appropriating the gold had been made before he went to Olympia, and the charge of sacrilege when he had returned thence to Athens. Others again prefer to accept the story of Plutarch as it stands, and to assign the stay of Phidias in Olympia to an early period of his life—previous to 455. As to the charge of theft, it could never have reached a public trial, because every one acquainted with the management of the public treasures knew that the gold of the Athena was so sculptured that it could be removed annually and weighed by the officials of the treasury. Pericles told the Athenians (Thuc., ii. 13) that it could be removed and utilized for the war. The other charge of having placed portraits of himself as a bald-headed old man (438) and of Pericles on the shield of Athena is incredible. Pericles with the helmet which he always wore was almost an ideal Greek in appearance. Among the Greeks fighting with the

Amazons on the shield of Athena it was probably easy to find a figure not unlike him. The same may be said of the bald-headed old man who was identified with Phidias. But there is a wide difference between idle gossip and a criminal charge. It is true that there is in the British Museum a marble fragment of what professes to be a copy of the shield, and on it there are portraits of Phidias and of Pericles; but these portraits answer so minutely to the description of Plutarch that there can hardly be a doubt of their having been produced subsequently to illustrate some current story on which that description was founded. The workmanship is several centuries later than Phidias, and it would be strange if the portraits for which he had paid with his life had been left for so long a time on the shield, or had even been allowed at any moment to be perpetuated in a copy. In answer to this objection it was fabled that the portraits had been so fixed on the shield that they could not be removed without bringing down the whole work!

To obtain something like a fair judgment of the style of Phidias it is to the sculptures of the Parthenon now in the British Museum that we must turn (see *ARCHAEOLOGY*, vol. ii. p. 356). Though executed in what was to him an inferior material, marble, it yet happened that the elevated position which these sculptures were to occupy on the temple was such as to give scope for the highest power of composition, and so far they may be regarded as a worthy monument of his genius. Alike in the frieze, the metopes, and the remaining figures of the pediments we have the same perfect rendering of the true effects of light and shade, which above all reveals the artist who can compose his figures and his groups so as to make the spectator feel that nature would not have done otherwise had nature been a sculptor. For composition of this kind there was necessary a most complete knowledge of form in all its details, since no part was so minute as not to affect the aspect of the whole. In this respect Phidias was famed in antiquity, and the Parthenon sculptures justify that fame. He must, however, have found finer opportunities in the colossal statues of gold and ivory, where the greater difficulty of duly distributing light and shade was rewarded with greater splendour of effect. In these statues the nude parts, such as the face, hands, and feet, were of ivory, the drapery of gold; and in the statue of Zeus at Olympia the gold was enriched with enamelled colours, and the impression of the whole is described by ancient writers with unbounded praise (see vol. ii. p. 355, and A. S. Murray, *Gr. Sculpt.*, ii. p. 123). Of the Athena in the Parthenon there exist two small copies in marble found in Athens, but so rude in execution as to be of no service in conveying a notion of the style of the original. On the acropolis, and not far from the Parthenon, stood a colossal bronze statue of Athena Promachos by Phidias, the attitude and to some extent the type of which may be gathered from the small bronze found at Athens, and figured in vol. ii. p. 355. In Elis he executed a statue of Aphrodite in gold and ivory, and at Plataea a colossal Athena of wood gilt, with the face, hands, and feet of Pentelic marble. Bright but simple colours had been traditional in art before the time of Phidias. It is not supposed that he had sought to refine upon them as a colorist. What he did was to combine with their simplicity and brightness the ideal largeness and dignity of conception which he shared with the great painters of his day, and the perfection of execution which he shared with the greatest of contemporary sculptors. (A. S. M.)

PHIGALIA (*Φιγᾶλία*, also called *Φαλιά*), a city in the south-west angle of Arcadia, situated on an elevated rocky site, among some of the highest mountains in the Peloponnese,—the most conspicuous being Mount Coty-

<sup>1</sup> See A. S. Murray, *Greek Sculpt.*, ii. pl. 17; compare the Greek inscription from the base of a statue of Athena in Cyprus, which says that she was made after the Phidian model, and had laid aside her arms, Hirschfeld, *Tivoli statuar.*, No. 178, or *C. I. Gr.*, No. 2073.

<sup>2</sup> See A. S. Murray, *op. cit.*, ii. p. 98 sq.



lium and Mount Elaeum; the identification of the latter is uncertain.

In 659 B.C. Phigalia was taken by the Lacedaemonians, but soon after recovered its independence; it was on the whole unfortunate during the Peloponnesian War; and, in common with the other cities of Arcadia, it appears from Strabo to have fallen into utter decay under the Roman rule. The notices of it in Greek history are rare and scanty. Though its existing ruins of city-wall and forts and the description of Pausanias show it to have been a place of considerable strength and importance, yet no autonomous coins of Phigalia are known. Nothing now remains above ground of the temples of Artemis or Dionysus and the numerous statues and other works of art which still existed at the time of Pausanias's visit, about 170 A.D. A great part of the city-wall, built in fine Hellenic "isodorous" masonry, and a large square central fortress with a circular projecting tower, are the only remains now traceable,—at least without the aid of excavation. The walls, once nearly 2 miles in circuit, are strongly placed on rocks, which slope down to the little river Neda.

One very important monument of the wealth and artistic taste of the Phigalians still exists in a fairly perfect state; this is a temple dedicated to Apollo Epicurius (the Preserver), built, not at Phigalia itself, but at the village of Bassæ, 5 or 6 miles away, on one of the peaks of Mount Cotylus; it commemorates the aid rendered by Apollo in stopping the progress of a plague which in the 5th century B.C. was devastating Phigalia. This temple is mentioned by Pausanias (viii. 41) as being (next to that at Tegea) the finest in the Peloponnesus, "from the beauty of its stone and the symmetry of its proportions." It has also a special interest in having been designed by Ictinus, who, with Callicrates, was joint architect of the Parthenon at Athens. Though visited by Chandler, Dodwell, Gall, and other English travellers, the temple was neither explored nor measured till 1811-12, when Chas. Rob. Cockerell and some other archaeologists spent several months in making excavations there. After nearly fifty years' delay, Professor Cockerell published the results of these labours, as well as of his previous work at Ægina, in *Temples of Ægina and Bassæ* (1860), one of the most careful and beautifully illustrated archaeological works that has ever been produced. The labours of Professor Cockerell and his companions were richly rewarded; not only were sufficient remains of the architectural features discovered to show clearly what the whole design had been, but the internal sculptured frieze of the cella was found almost perfect. This and other fragments of its sculpture are now in the British Museum.

Fig. 1 shows the plan of the temple, which is of the Doric order, but has an internal arrangement of its cella quite unlike that of any other known temple. It stands on an elevated and partly artificial plateau, which commands a most glorious and extensive view of the oak-clad mountains of Arcadia, reaching away to the blue waters of the Messenian Gulf. Unlike other Doric temples, which usually stand east and west, this is placed north and south; but it has a side entrance on the east. It is hexastyle, with fifteen columns on its flanks; thirty-four out of the thirty-eight columns of the peristyle are still standing, with the greater part of their architrave, but the rest of the entablature and both pediments have fallen, together with the greater part of the internal columns of the cella. It will be seen from the plan that these are very strangely placed, apparently without symmetry, as regards the interior, though they are set, for what reason it is hard to say, regularly opposite the voids in the peristyle.

With the exception of one at the south end, which is Corinthian, the internal columns are of the Ionic order, and are built, not free, but engaged with the cella-wall, forming a series of recesses, which may have been designed to contain statues. Another peculiarity of this interior is that these columns reach to the top of the cella in one order, not in two ranges of columns, one over the other, as was the usual Doric fashion. These inner columns carried an Ionic entablature, of which the frieze now in the British Museum formed

a part. The pediments and external metopes of the peristyle appear to have contained no sculpture, but the metopes within the peristyle on the exterior of the cella had sculptured subjects; only a few fragments of these were, however, discovered. The position occupied by the great statue of Apollo is a difficult problem. Cockerell, with much probability, places it in the vestibule of the cella, opposite the eastern side door, so that it would be lighted up by the rays of the rising sun. The main entrance is at the northern end through the pronaoe, once defended by a door in the end of the cella and a metal screen, of which traces were found on the two columns of the pronaoe. There was no door between the posticum and the cella. The general proportions of the fronts resemble those of the Theseum at Athens, except that the entablature is less massive, the columns thicker, and the diminution less,—all proportionally speaking. In plan the temple is long in proportion to its width,—measuring, on the top of the stylobate, 125 feet 7 inches by 48 feet 2 inches, while the Theseum (built probably half a century earlier) is about 104 feet 2 inches by 45 feet 2 inches.

The material of which the temple is built is a fine grey limestone (once covered with painted stucco), except the roof-tiles, the capitals of the cella columns, the architraves, the *lacunaria* (ceilings) of the posticum and pronaoe, and the sculpture, all of which are of white marble. The roof-tiles, specially noticed by Pausanias, are remarkable for their size, workmanship, and the beauty of the Parian marble of which they are made. They measure 2 feet 1 inch by 8 feet 6 inches, and are fitted together in the most careful and ingenious manner. Unlike those of the Parthenon and the temple of Ægina, the *apud* or "joint-tiles" are worked out of the same piece of marble as the flat ones, at a great additional cost of labour and material, for the sake of more perfect fitting and greater security against wet.

Traces of painting on various architectural members were found by Professor Cockerell, but they were too much faded for the colours

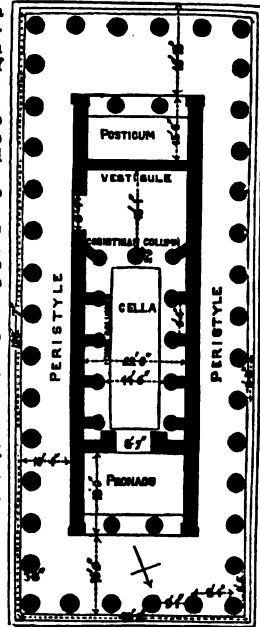

FIG. 1.—Plan of the Temple at Bassæ.



FIG. 2.—One slab of the Bassæ frieze; combat of Greeks and Amazons.

to be distinguished. The designs are the usual somewhat stiff and monotonous Greek patterns,—the fret, the honeysuckle, and the egg and dart.

The sculpture is of the greatest interest, as being an important example of the school of Phidias, designed to decorate one of the finest buildings in the Peloponnesus in the latter half of the 5th century B.C.; see *Phigalians Marbles*, Brit. Mus. Publications.

The frieze, now in the British Museum, is quite complete; it is nearly 101 feet long by 2 feet high, carved in relief on twenty-three slabs of marble  $4\frac{1}{2}$  to 5 inches thick (see fig. 2). The subjects are the battle of the Lapithæ and the Centaurs, and that between the Amazons and the Greeks, the two favourite subjects in Greek plastic art of the best period. They are designed with wonderful fertility of invention, and life-like realism and spirit; the composition is arranged so as to form a series of diagonal lines or zigzags  $\backslash$ , thus forming a pleasing contrast to the unbroken horizontal lines

of the cornice and architrave. The various groups are skillfully united together by some dominant line or action, so that the whole subject forms one unbroken composition.

The relief is very high, more than  $3\frac{1}{2}$  inches in the most salient parts, and the whole treatment is quite opposite to that of the Parthenon frieze, which is a very superior work of art to that at Bassæ. Many of the limbs are quite detached from the ground; the drill has been largely used to emphasize certain shadows, and in many places, for want of due calculation, the sculptor has had to cut into the flat background behind the figures. From this it would appear that no finished clay-model was prepared, but that the relief was sculptured with only the help of a drawing. The point of sight, more than 20 feet below the bottom of the frieze, and the direction in which the light fell on it have evidently been carefully considered. Many parts, invisible from below, are left comparatively rough. The workmanship throughout is unequal, and the hands of several sculptors can be detected. On the whole, it must be admitted that the execution is not equal to the beauty of the design, and the whole frieze is somewhat marred by an evident desire to produce the maximum of effect with the least possible amount of labour,—very different from the almost gem-like finish of the Parthenon frieze. Even the design is inferior to the Athenian one; most of the figures are ungracefully short in their proportions, and there is a great want of refined beauty in many of the female hands and faces. It is in the fire of its varied action and its subtlety of expression that this sculpture most excels. The noble movements of the heroic Greeks form a striking contrast to the feminine weakness of the wounded Amazons, or the struggles with teeth and hoofs of the brutish Centaurs; the group of Apollo and Artemis in their chariot is full of grace and dignified power. The marble in which this frieze is sculptured is somewhat coarse and crystalline; the slabs appear not to have been built into their place but fixed afterwards, with the aid of two bronze bolts driven through the face of each.

Of the metopes, which were 2 feet 8 inches square, only one exists nearly complete, with eleven fragments; the one almost perfect has a relief of a nude warrior, with floating drapery, overcoming a long-haired bearded man, who sinks vanquished at his feet. The relief of these is rather less than that of the frieze figures, and the work is nobler in character and superior in execution. The other pieces are too fragmentary to show what were their subjects.

No modern Greek village exists now on the site either of Bassæ or of Phigalia.

In addition to the works mentioned in the text the following may be consulted:—Leake, *Morea* (vol. i. p. 490, and ii. p. 319); Curtius, *Peloponnesos* (i. 319); Ross, *Reisen in Peloponnesos*; Staackelberg, *Der Apollo-Tempel zu Bassæ* (1826); Lenormant, *Bas-reliefs du Parthenon et de Phigalie* (1834); and Friederichs, *Geschichte der griechischen Plastik* (1868). (J. H. M.)

**PHILADELPHIA**, the name of several cities of antiquity, of which the two most important have been noticed under **ALA-SHEER** vol. i. p. 443, and **AMMONITES** vol. i. p. 743.

**PHILADELPHIA**, the chief city of Pennsylvania, and the second city in the United States of America, is situated ( $39^{\circ} 57' 7.5''$  N. lat.,  $75^{\circ} 9' 23.4''$  W. long.) on the west bank of the Delaware river, 96 miles from the Atlantic and in a direct line 125 miles north-east of Washington, D.C., and 85 miles south-west of the city of New York. Its greatest length north-north-east is 22 miles, its breadth from 5 to 10 miles, and its area 82,603 acres, or about 129 square miles (greater than that of any other city in America). The surface of the city between the rivers Delaware and Schuylkill—the latter running parallel with the Delaware and dividing the city about in half, east and west—is remarkably level. It varies, however, in elevation from  $24\frac{1}{2}$  feet above the sea to 440 feet, the latter in the northern and suburban sections. The eastern and western sections of the city are connected by eight bridges. The length of river-front on the Delaware is nearly 20 miles, and the length of wharves 5 miles. On both sides of the Schuylkill, to Fairmount dam, the front is 16 miles and the length of wharves 4 miles. The mean low-water mark of the Delaware is 24 feet, and the tide rises 6 feet, while the average depth of water at the city wharves is 50 feet. The wharf-line, which varies from 14 feet to 68 feet, gives extraordinary accommodation for shipping. The Delaware is navigable at all seasons of the year for vessels of the heaviest burden, and Philadelphia affords one of the best protected harbours in the country. The

substratum of the city is a clay soil mixed with more or less sand and gravel.

The site of the present Philadelphia was originally settled by the Swedes, and so Penn found it when he came to lay

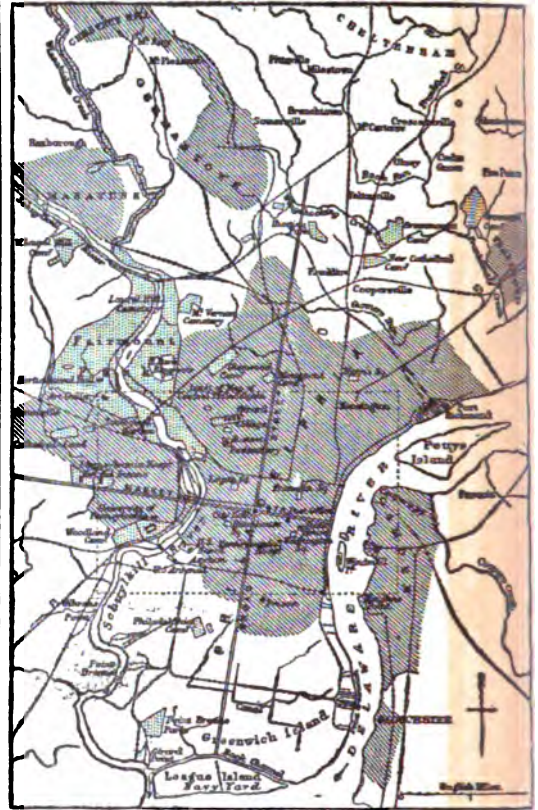

General Plan of Philadelphia.

out the city; and many of the original patentees for town lots under him were descendants of these first settlers. The original city limits were from east to west 10,922 feet 5 inches, and from north to south 5370 feet 8 inches, or more than 2 square miles. The boundaries were Vine street on the N., Cedar (now South) street on the S., the Delaware river on the E., and the Schuylkill river on the W. And this was the city of Philadelphia from its foundation until the 2d day of February 1854, when what is known as the Consolidation Act was passed by the legislature of the State, and the old limits of the city proper were extended to take in all the territory embraced within the then county of Philadelphia. This legislation abolished the districts of Southwark, Northern Liberties, Kensington, Spring Garden, Moyamensing, Penn, Richmond, West Philadelphia, and Belmont; the boroughs of Frankford, Germantown, Manayunk, White-Hall, Bridesburg, and Aramingo; and the townships of Passyunk, Blockley, Kingsessing, Roxborough, Germantown, Bristol, Oxford, Lower Dublin, Moreland, Bybery, Delaware, and Penn; and it transferred all their franchises and property to the consolidated city of Philadelphia under one municipal government. The present boundaries of the city are: on the E. the Delaware, on the N.E. Bucks county, on the N.N.W. and W. Montgomery county, and on the W. and S. Delaware county and the Delaware. The greater part is laid out in parallelograms, with streets at right angles to each other. Each main parallelogram contains about 4 acres, or is 400 feet on each





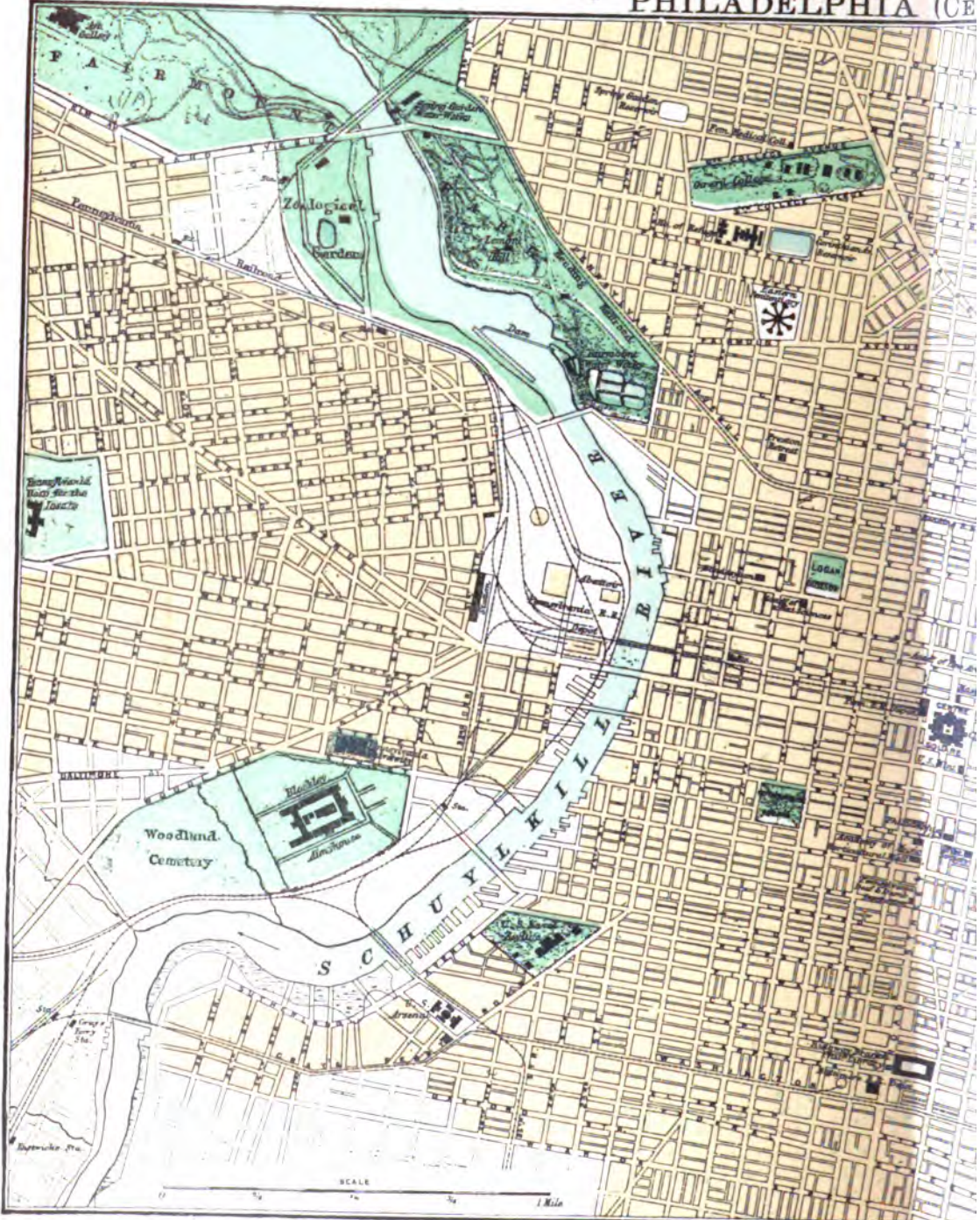





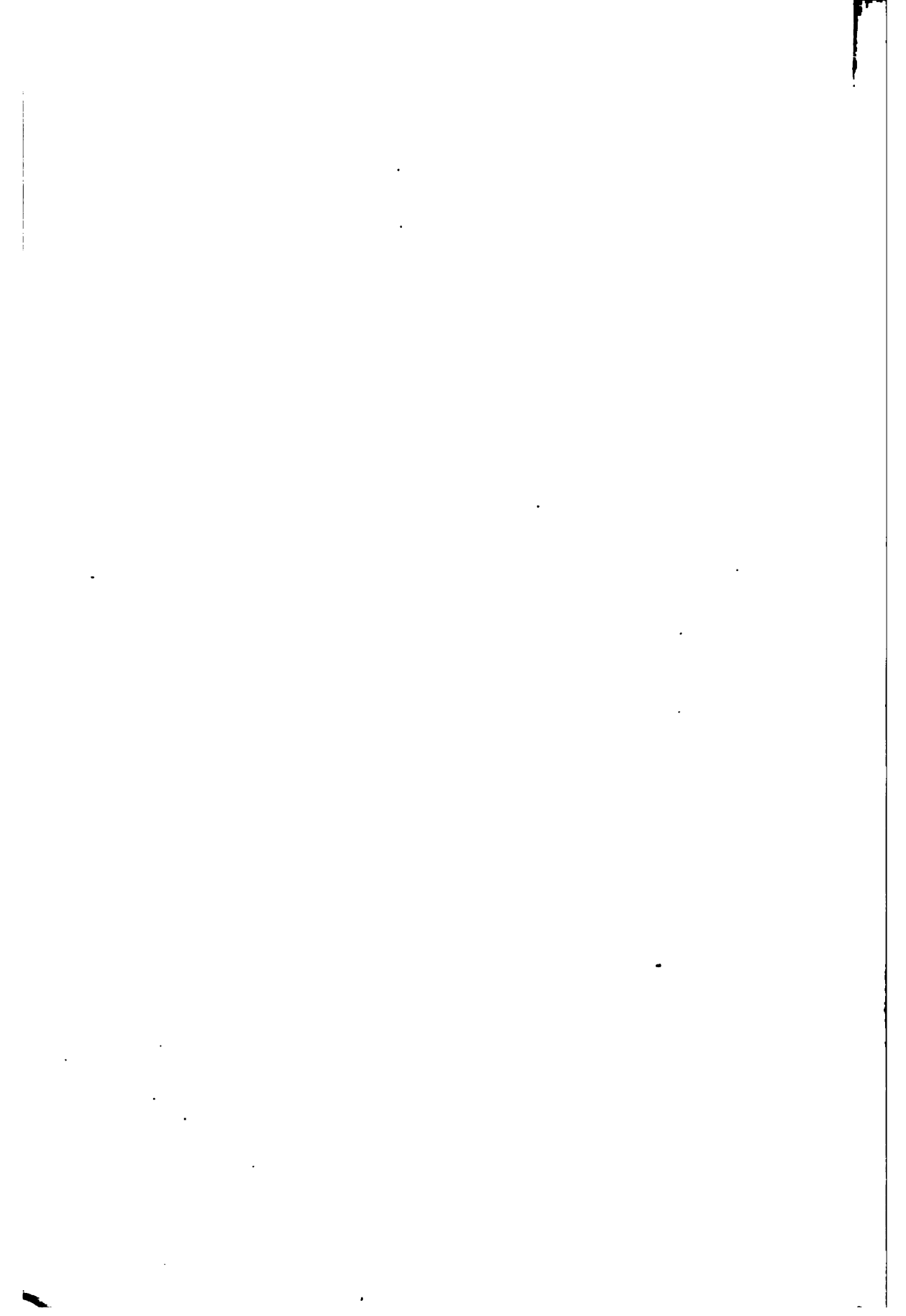



of its sides, divided by one or more small thoroughfares. Upon the city plans there are plotted 191,928 separate town lots. The main streets running north and south are numbered from First or Front to Sixty-third streets, and those running east and west were formerly named after the trees and shrubs found in the province. Thus, while the principal street in the city is named Market street, other main streets are named Chestnut, Walnut, Spruce, Pine, &c.<sup>1</sup> The main streets of Philadelphia are 50 feet wide, with some few exceptions: Broad or Fourteenth street is 113 feet wide, and Market street is 100 feet wide. The streets are generally paved with rubble stone, although square or Belgian blocks of granite are being extensively introduced. There are laid down on the city plans upwards of 2000 miles of streets, but at present (1884) only 1060½ miles are opened, of which 573.54 miles are paved and 44.28 macadamized. The pavements are chiefly of brick, but some of the more prominent streets have flagstone sidewalks. Market street and Chestnut street, below Eighth street, and Front street are the localities where the main wholesale business of the city is conducted. Most of the retail stores are situated in the upper part of Chestnut street and Eighth street. The principal banking institutions are in Chestnut street, between Second and Fifth streets, and in Third street between Walnut and Chestnut streets. Walnut street in the southern section of the city, and Spring Garden and Broad streets in the northern section of the city, are the chief streets for large and luxurious private residences. There is not a street of any consequence which has not a tramway along it; and the tramway system has done a great deal to increase building, until now Philadelphia is emphatically "the city of homes." There are upwards of 160,000 dwelling-houses, of which at least 110,000 are owned by the occupants. According to the returns for the census of 1880, there were 146,412 dwelling-houses in the city, which, taking the population as given by that census, 847,170, gave 5.79 persons to each house, while the number of dwellings in New York to the population gave 16.37 to each house. On the original plan of the city five squares, equidistant, were reserved for public parks. One of these, called Centre square, situated at the intersection of Broad and Market streets, has been taken for the erection of the city-hall, and the remaining four, situated at Sixth and Walnut, Sixth and Race, Eighteenth and Walnut, and Eighteenth and Race, and named respectively Washington, Franklin, Rittenhouse, and Logan, have a combined area of 29.06 acres. There are six other public squares in the city, with a total area of 18.90 acres. In addition to these public squares, Fairmount Park, with an area of 2791½ acres, including 373 acres of the water-surface of the Schuylkill river, is the most extensive public park in the United States. It lies in the north-western section of the city, and the Schuylkill river and Wissahickon creek wind through the greater portion of it.<sup>2</sup> In the park Horticultural Hall and Memorial Hall remain

<sup>1</sup> The geometrical laying out of the city into parallelograms made easy the adoption of the decimal system of numbering for the houses, which is readily understood and greatly helps strangers and citizens in finding their way about the streets. The houses in streets running east and west are numbered by hundreds, beginning at the Delaware and going west. Thus, from Delaware river to Front street the houses are numbered from 1 to 100; from Front street to Second street from 100 to 200; above Second street 200; above Third street 300; and so on. The even numbers are placed on the south side of the street and the odd numbers on the north side of the street. Market street is taken as a dividing line between north and south, and all the main streets stretching north and south, which lie north of Market street, are in the same way numbered running northerly, and those which lie south of Market street are numbered running southerly. The west side is given the even numbers and the east side the odd numbers.

<sup>2</sup> There are 34.27 miles of footwalk, 30.46 miles of carriage-drives, and 7.73 miles of bridle-paths within the boundaries of the park.

as mementoes of the Centennial Exhibition held there in 1876. The garden of the Zoological Society, covering 33 acres, on the outskirts of the park, was opened 1st July 1874, as the pioneer of such enterprises in the United States.<sup>3</sup> Until within the last score of years the buildings in Philadelphia bore a singular resemblance to each other, especially the dwelling-houses. The predominant material for building was, and is, red brick, the soil affording the finest clay for brick found in the United States. The desire for uniformity in buildings, both in style and material, has happily undergone a change in recent years, although the danger now is of running to the other extreme, and thus giving the streets a decidedly bizarre appearance. There are 238¾ miles of sewers in Philadelphia, but the drainage of the city is wholly inadequate. The streets are lighted by 12,805 gas-lamps, and Chestnut street by the electric light. There are 748 miles of gas main, and the average daily consumption is 10,624,000 cubic feet.

*Buildings.*—The old brick Swedes Church in Swanston street in the extreme south-eastern section, dedicated on the first Sunday after Trinity 1700, is the oldest building of character now standing in the city. When it was completed it was looked upon as a great masterpiece, and nothing was then equal to it in the town. The four other colonial buildings of importance still standing are Christ (Protestant Episcopal) Church, the old State House (Independence Hall), the Pennsylvania Hospital, and Carpenter's Hall, all of them built of red brick with black glazed headers. Dr. John Kearsley, a physician, was the architect of the first-mentioned, and Andrew Hamilton, a lawyer, the architect of the second. Christ Church stands on the west side of Second street between Market and Arch streets, and its erection was begun in 1727, but it was not finished, as it now appears with tower and spire, until 1754. It was built on the site of a still older Christ Church, which was also of brick, erected in 1695. Queen Anne in 1708 presented a set of communion plate to the church, which is now used on great occasions. During his presidency Washington worshipped at this church, and his pew is still preserved, as is also that of Franklin. In 1882 the interior of the church was restored to its ancient character at an expense of about \$10,000. The nave is 75 feet long by 61 feet in width and 47 feet high; the chancel is 15 feet by 24; and the spire is 196 feet 9 inches high. The old State House or Independence Hall, on the south side of Chestnut street between Fifth and Sixth streets, was commenced in 1731, and was ready for occupancy by the Assembly towards the close of 1735. It was the scene of almost all the great civil events of the Revolutionary War. It is 100 feet in length on Chestnut street by 44 feet in depth; and prior to the centennial celebration its exterior and interior were restored as nearly as possible to their original appearance. The Pennsylvania Hospital occupies the square of ground bounded by Spruce, Pine, Eighth, and Ninth streets, and the corner-stone of the building was laid on 28th May 1755. Carpenter's Hall, where the first Congress met, stands back from Chestnut street, east of Fourth street, and was begun in January 1770. These four buildings are all very simple in their construction, but substantial and imposing, and are interesting specimens of colonial architecture. Among the notably fine buildings in Philadelphia are the old United States bank, now the United States custom-house, the Girard bank, the United States mint, and the Girard College, all of which, with the exception of the last-named, were built more than half a century ago. They are all of white marble and of the different orders of Grecian architecture, with porticos and high fluted columns. Other fine build-

<sup>3</sup> The collection numbers 678 specimens,—mammals 251, birds 372, reptiles and batrachians 50, valued at \$46,726.

ings are the Masonic Temple, the Ridgway branch of the Philadelphia library, the Pennsylvania Academy of Fine Arts, and the Academy of Natural Sciences. There are also very many beautiful churches. The two newest buildings of magnitude are the new United States post-office, at the corner of Ninth and Chestnut streets, which is just completed (1884) at a cost of \$8,000,000, and the new municipal buildings for the city of Philadelphia at the intersection of Broad and Market streets, which are in course of construction. The post-office, which is Romanesque, is of granite, and was more than ten years in building, from October 1873 to March 1884. It has a frontage of 425 feet, a depth of 175 feet, and a height of 164 feet. The carrier delivery of the Philadelphia post-office covers the greatest territory of any city in the world, excepting London; it employs 900 men, of whom 448 are letter-carriers. The annual sales of stamps amount to \$1,600,000. About half a million of letters, &c., pass through the post-office each day. The new public buildings, as they are called, or city-hall, were begun in August 1871, and when completed will be the largest single building in America. It covers an area, including courtyards, of nearly  $4\frac{1}{2}$  acres, the dimensions being 470 feet east and west and 486 feet north and south. The building will contain 520 rooms, and the topmost point of the dome, on the tower, will be 537 feet 4 inches above the courtyard, or the highest artificial construction in the world. The exterior structure is now roofed in and completed, with the exception of the tower. The total amount expended on this building to 31st December 1883 was \$9,731,488.81, and the estimated total cost is \$13,000,000. The architecture is rather rococo in character.

**Population.**—Previous to the census of 1830 Philadelphia was the most populous American city, but since then New York has taken the first place. In 1683 it was estimated that Philadelphia had 80 houses and 500 inhabitants. The next year the population increased 2000, and by the beginning of the last century there were 700 dwelling-houses and 4500 people. In 1800 there were 9868 dwellings and 81,009 inhabitants, and in 1820, the last census when Philadelphia stood first, she had a population of 119,325. By the census of 1880 the population of the city is placed at 847,170 (males 405,989, females 441,181), while in 1870 it was 674,022, and in 1860 565,529. About one-third of the population in 1880 were foreign born. In 1883 there were 21,237 births, of which 11,102 were males and 10,135 females. The number of emigrants landed in the year at Philadelphia was 23,473, of whom 13,899 were males and 9574 females,—a decrease of 9778 from 1882. Of these emigrants 7304 were from England, 6023 from Ireland, 5232 from Sweden and Norway, and 2991 from Germany. The mayor of Philadelphia in his annual message to councils in April 1884 places the population of the city at 1,023,000, while the Board of Health estimate it at 907,041. The death-rate of the city in 1883 was 22.13 per thousand. By the census of 1880 41 per cent. of the population were engaged in gainful occupations. In 1884 there were in Philadelphia 1294 lawyers and 1637 physicians. The city has 622 places of worship, viz., Baptist 83, Hebrew 11, Lutheran 32, Methodist 131, Moravian 5, Presbyterian 110, Protestant Episcopal 96, Quaker 15, Reformed Dutch 20, Reformed Episcopal 10, Roman Catholic 47, Swedenborgian 3, Unitarian 3, Universalist 4, and 52 among 23 other different denominations. There are 53 cemeteries and burial-grounds in the city.

**Municipal Government.**—By Penn's charter of 25th October 1701 Philadelphia was first created a borough city with a government of its own, separate from that of the province and county. Under this charter, with many modifications, the city was governed until the Act of the legislature of the State incorporating the city was

passed, 11th March 1789. This is the fundamental law governing the city to-day, but with such changes as have become necessary by the altered condition of affairs and the development of the entire country. The most important change was the Consolidation Act of 21 February 1854, already mentioned, whereby the old county of Philadelphia became the city of Philadelphia, the county of Philadelphia being at the same time continued as one of the counties of the State. The city is divided territorially and politically into thirty-one wards, and is governed by a mayor, elected by the people for three years, and by two bodies, called the select and common council. The upper branch is composed of one member from each ward elected for three years, who must have attained the age of twenty-five years and have been a citizen and inhabitant of the State for four years next before his election, and the last year thereof an inhabitant of the ward for which he shall be chosen. Each ward has a member of common council, elected for two years, for every 2000 taxable inhabitants; he must be twenty-one years of age and have the other qualifications required for the upper body. The mayor is the executive head of the city and the councils are the law making power. The mayor has the right of veto upon the acts of the councils. Councils in joint meeting appoint all heads of departments not elected, establish the rate at which all taxes shall be levied that are authorized by law, and fix the salaries of all municipal officers elected by the people, as well as those they appoint. The city can make no binding contract or incur any debt unless authorized by law or ordinance and an appropriation sufficient to pay the same be previously made by councils. The sanitary care of the city is vested in a board of health composed of nine members appointed by the judges of the Courts of Common Pleas of the county, who have charge of the sanitary condition of the city and its citizens. Among the duties of the board is that of keeping an accurate record of all births, marriages, and deaths. The poor of the city are under the charge of a board of twelve guardians elected by councils. These several bodies, councils, board of health, and guardians of the poor all serve without pecuniary compensation. Edward Shippen was named in the charter of 1701 as first mayor of the city. The last mayor under the English crown was Samuel Powel, elected 3d October 1775, and he was also the first mayor under the United States, being re-elected 13th April 1789. During the interim of the Revolutionary War the municipal government was suspended, and the affairs of the city were carried on by the councils of safety and other local bodies.

**Police, Fire, Water.**—The mayor is the nominal head of the police of the city, and all the appointments and removals are in his hands. The force consists of 1415 men, of whom 1225 are patrolmen. There are four captains and one chief of police; and the fire marshal is attached to the police department. The number of arrests made in 1883 was 45,612, and the number of commitments to the county prison 23,245.

The fire department is governed by a board of fire commissioners elected by councils, and consists of a chief engineer, six assistant engineers, and four hundred men. They are divided into twenty-nine steam-engine companies and five hook and ladder companies, with the addition of hose and hose-carriage to each. In 1883 there were 804 fires.

The largest portion of Philadelphia is supplied with water from the Schuylkill, and it was in great part for the preservation of the purity of this water-supply that Fairmount Park was created. The park has not, however, served its purpose in this respect, and the water supplied to the city is most impure. The supply also is hardly adequate to the demand, and many other sources have been suggested. The capacity of the present waterworks allows a daily average pumpage of 90,000,000 gallons, and the seven reservoirs have a total capacity of 191,224,560 gallons. The total number of gallons of water pumped in 1883 was 25,182,775,641, or a daily average of about 69,000,000. There are 784 miles of pipe underground to supply at least 170,000 buildings, of which 151,098 are (January 1884) dwelling-houses. The dwellings are charged for water according to the number and character of appliances in use, irrespective of the amount of water used or the number of the occupants of the house. The streets have a number of fountains erected by the Philadelphia Fountain Society, for the use of horses, dogs, and men; and there are also 5752 hydrants for the use of the fire department; but these are wholly insufficient to protect the city.

**Finances.**—On 1st January 1884 the funded debt of the city of Philadelphia was \$66,365,591.24, and the floating debt \$689,355.54 or a total indebtedness of \$67,054,946.60. The city assets at the same period were \$28,096,394.75, so that the excess over assets was \$38,958,551.85. This is a reduction of the city's debt from its highest point, 1st January 1880, when it amounted to \$72,264,595.54. The assessed valuation of real estate in the city of Philadelphia, 1st January 1884, was \$583,613,683, and the annual tax for the year amounted to \$10,833,381.84. In 1883 the receipts from all sources for municipal purposes were \$13,632,842.38. The various trust funds of the city are under the control of a board of directors of city trusts, composed of twelve prominent citizens appointed by the judges of the Courts of Common Pleas. The board has charge of the

Girard Fund; the Wills Hospital Fund, for the relief of indigent blind and lame; the Franklin Fund, for aiding young married artificers; and cundry funds for furnishing the poor with fuel and other purposes,—amounting in the aggregate, on 31st December 1833, to \$11,000,320-92.

There are thirty-two national banks in Philadelphia with an aggregate capital of \$17,578,000, and for the week ending 30th June 1884 their loans and discounts were \$78,525,885, deposits \$74,433,411, and circulation \$8,416,013. Their surplus on 31st December 1883 was \$3,712,308. In addition to the national banks there are six banks chartered by the State with an aggregate capital of \$714,600; eight trust and safe deposit companies, whose deposits are received and a *guarant* banking business done, with a total capital of \$3,625,000, and a surplus on 31st December 1883 of \$4,589,732; and three saving funds without any capital, but where all the depositors are interested in the profits, with total deposits on 31st December 1883 of \$28,563,200-98. Philadelphia has fourteen joint-stock fire insurance companies, with a capital of \$3,950,000; five joint-stock fire and marine companies, with a capital of \$4,860,000; six mutual fire insurance companies; and six life insurance companies. In addition to these there are a real estate title insurance company and a plate-glass insurance company, their objects being expressed in their titles.

**Commerce.**—Until within the last sixty years Philadelphia was the commercial emporium of the United States, but since that time her commerce has been gradually declining, until now she ranks fifth in the order of ports, being preceded by New York, Boston, San Francisco, and New Orleans. At the same time her manufactures have been steadily increasing, until she has become the great manufacturing centre of the country. On 30th June 1884 there were registered as belonging to the port of Philadelphia 854 vessels, having a tonnage of 197,491 tons, 295 being steamers. For the year ending 31st December 1883 724 coast-wise vessels having a tonnage of 418,625 tons entered, and 1213 with a tonnage of 576,719 tons cleared. During the same period there entered 1066 foreign vessels with a tonnage of 813,706 tons, and 942 cleared with a tonnage of 732,333 tons. For the six months ending 30th June 1884 there entered 290 American vessels with a tonnage of 134,807 tons, and 199 cleared with a tonnage of 101,908 tons. In the same period 285 foreign vessels entered with a tonnage of 263,577 tons, and 246 cleared with a tonnage of 238,929 tons. Statistics of the exports and imports of the city have been kept since 1821; and they show that the greatest exports in any one year were in 1870, the centennial year, when they amounted to \$50,539,450. The greatest imports (\$38,933,832) were in 1880. For 1883 the exports were \$38,662,434 and the imports \$32,811,045. For the six months ending 30th June 1884 the exports were \$17,605,271, and the imports \$18,245,733. The total receipts for duties at this port for the year 1883 were \$11,834,014-55, and for the six months ending 30th June 1884 \$6,917,376-71. Lines of steamers run to Liverpool, Glasgow, New York, Boston, Baltimore, Savannah, Charleston, and other ports. Philadelphia is also the centre of the three great internal carrying lines of the State, the Pennsylvania Railroad, the Lehigh Valley Railroad, and the Reading Railroad. The last two are principally coal-roads from the great anthracite coal-fields of Pennsylvania, while the first, with its numerous branches, is the main artery from the west for the transportation of its agricultural products. The gross receipts for 1883 of the Pennsylvania Railroad, from all lines connecting directly with Philadelphia, were \$57,612,766-36. The total tonnage moved over these same lines was 57,379,115 tons, and the number of passengers for the same period was 36,584,435, and the pieces of baggage 1,774,192. The tonnage of the other two roads is proportionately large.

**Industries.**—The largest single classes of manufactures are the iron and steel and the textile industries. The first-named, which includes all forms of machinery and of iron and steel articles, employed in 1883 31,917 persons in 712 establishments, producing articles valued at \$58,608,781. The manufacturers of wool, cotton, silk, &c., employed 60,897 persons in 1018 establishments, producing textile fabrics to the value of \$102,087,128; and these figures are rather below than above the actual facts. In the carpet manufacture alone, for which there are 216 establishments, there are 35,000,000 yards of carpet made annually. The census for 1830 gave Philadelphia 8567 manufacturing establishments, with a capital of \$187,148,857, employing 185,527 hands and producing articles valued at \$324,342,935 per annum. The seven classes producing over \$10,000,000 a year were—sugar-refineries (11), \$24,294,929; factories of woollen goods (89), \$21,349,810; men's clothing manufactories (426), \$18,506,748; cotton-mills (145), \$14,268,698; carpet manufactories (170), \$14,263,510; foundry and machine shops (226), \$13,455,238; drugs and chemicals manufactories (54), \$11,804,793. Since then, however, Philadelphia has made great strides, and the close of 1882 showed 12,063 manufacturing establishments, employing 147,137 men, 67,050 women, and 28,296 children under sixteen years of age, or a total of 242,483, and yielding products of the value of \$481,226,309. The large and important industry of brick-making, for which there are 63 yards,

produces annually about 350,000,000 bricks, of a market value of at least \$3,500,000. The fine "pressed brick" of Philadelphia is used in all parts of the country, and of late years moulded bricks of various designs and of any size have been extensively and successfully made.

**Charities.**—There are not less than 300 charities proper in Philadelphia, leaving out institutions of learning which come within the legal definition of the word. A few of them are municipal, but the majority are wholly private in their origin and conduct. Among the former may be classed the Blockley Almshouse for the care of the indigent poor of the city, and the house of correction, employment, and reformation at Holmesburg. This last is a mixed institution, being a workhouse both for criminals and paupers, and in 1883 there were received into it 7290 men, women, and children. On 31st December 1883 there were 1236 inmates, of whom 197 were females. The city bath-houses are another important municipal charity. There are twenty-two hospitals in Philadelphia, the most important being the Pennsylvania Hospital, projected in 1751 by Benjamin Franklin and Dr Thomas Bond. It is governed principally by the Quakers, and is supported wholly by voluntary contributions. It has a capacity for 230 patients, and recent accident cases are always admitted. The insane department of this hospital is located on Haverford road, and was opened in 1841, since which time to January 1884 there have been 8852 patients. In addition to this hospital for the insane there is an insane department attached to the City Hospital at the Almshouse, and a Friends' Asylum for the Insane at Frankford. Other important charities are the Philadelphia Dispensary, Home for Consumptives, Home for Incurables, Preston Retreat (lying-in charity), Orphans' Society, Philadelphia Working Home for Blind Men, Sheltering Arms for Infants, the Sick Diet Kitchen, and the House of Refuge for Juvenile Delinquents. This last receives children committed by the court of Oyer and Terminer upon conviction of a criminal offence, also vagrant, incorrigible, or vicious children committed by magistrates on complaint of the parent or any other person that the parent or guardian is incapable or unwilling to control them.

**Education.**—Penn in his frame of government provided that a committee of manners, education, and art should be appointed, so that all "wicked and scandalous living may be prevented, and that youth may be trained up in virtue, and useful arts and knowledge." The first school in Philadelphia of which we have knowledge was opened the year following the foundation of the colony. At a meeting of the provincial council held in Philadelphia "ye 26th of 10th month 1683" the governor and council, "having taken into serious consideration the great necessity there is of a schoolmaster for the instruction—and sober instruction—of youth in the town of Philadelphia, sent for Enoch Flower, an inhabitant of the said town, who for twenty years past hath been exercised in that care and employment in England," and engaged him to instruct the youth of the city. In the year 1689 the first public school in Pennsylvania was established at Philadelphia under the care of the celebrated George Keith. It was incorporated by the provincial council 12th February 1698, and was entitled "The Overseers of the Public Schools founded in Philadelphia at the request, costs, and charges of the people of God called Quakers," and in 1711 received a charter from Penn. This school, although supported by the Quakers, was open to all, and for more than sixty years continued to be the only public place for instruction in the province. It thrived and was held in high estimation, and its legitimate successor is still in operation in Philadelphia, where it maintains its ancient reputation. In 1749 Franklin published his *Proposals Relative to the Education of Youth in Pennsylvania*, which resulted the next year in the establishment of the academy and charitable school, which became a college in 1755, and in 1779 was incorporated as the university of Pennsylvania. The university at present occupies a site in Woodland avenue, in what was formerly West Philadelphia, and gives instruction in ten departments (Arts, Music, Medicine, Law, Dentistry, Philosophy, Auxiliary of Medicine, Veterinary Medicine, Towne Scientific School, and Wharton School of Finance and Economy). The faculty consists of 132 professors, lecturers, and instructors in the various departments, and for the college year 1883-84 there were 1000 students.

The public school system of Pennsylvania was not really firmly fixed until 1818, when by an Act of the legislature Philadelphia was made the first school district of Pennsylvania with a distinct educational system from that of the State in general. This district is governed by a board of public education composed of 31 members, one from each ward of the city, who are appointed, one-third each year for three years, by the judges of the Courts of Common Pleas of the county. They have the financial control and general supervision of schools, the selection of the books to be used, the oversight of the teachers, and the building of the schoolhouses. In addition to this board there are the directors of the public schools, twelve from each ward, who have the local supervision of the schools in their respective sections. They are elected by the people, one-third each year for three years. The schools are divided into primary, secondary, and grammar schools, in addition to which

there is a central high school, a finishing school for boys, and a normal school which is a finishing school for girls, and where they can also be qualified to become teachers. There are 465 public schools in Philadelphia and 236 school-buildings of a value of \$4,186,200. In 1883 the city appropriated \$1,637,651.04 to education. During the same period 105,424 children attended the public schools, at an average cost per pupil of \$15.35, and 82 male and 2086 female teachers are employed in their instruction. Another noted educational institution in Philadelphia is Girard College for orphans, endowed by Stephen Girard in 1831 for the benefit of poor white male orphan children. By the will a preference is given first to orphans born in Philadelphia, second to those born in Pennsylvania, third to those born in New York city, and fourth to those born in New Orleans. To be qualified for admission the orphans must be between six and ten years of age; and a child without a father, while the mother is living, is held to be an orphan entitled to admission. The buildings cost \$1,938,821.78, and were formally opened in January 1848. The total value of the estate applicable to the purposes of the college was on 31st December 1883 \$10,133,268.10, and the gross receipts of income for the year 1883 were \$976,961.06. During the same period there were 1105 boys inmates of the college. At Philadelphia are also the Pennsylvania Institution for the Instruction of the Deaf and Dumb; the Pennsylvania Institution for the Instruction of the Blind; the Pennsylvania Academy of the Fine Arts, founded in 1805, and the first art school in America; the School of Design for Women; the Pennsylvania Museum and School of Industrial Art; and the Jefferson Medical College.

**Libraries.**—Philadelphia was for many years not only the first city commercially in the country, but it was also the seat of letters. When the poet Moore visited America in 1804 he wrote to his mother, of Philadelphia, "it is the only place in America that can boast of a literary society." Unfortunately it has much degenerated in this respect in eighty years, and to-day but little attention is paid, by its people to letters and literature. To Franklin, again, its first library is due. It grew out of the Junto, and in 1781 the Library Company of Philadelphia was established. In 1769 it absorbed the Union Library Company, which had been formed some few years before; and in 1799 the Loganian Library, a valuable collection of classical and other works, provided for under the will of James Logan, a friend of Penn, was transferred to the Philadelphia Library. It subsequently acquired, by bequest, the libraries of the Rev. Samuel Preston of London and of William Mackenzie of Philadelphia. Among the rarities in the latter was a copy of Caxton's *Golden Legend*, 1486. In 1869 it was made the beneficiary, under the will of Dr James Rush, of an estate valued at over a million dollars. It has two library buildings and possesses about 145,000 volumes, as well as valuable manuscripts and broadsides. The Mercantile Library Association is the popular circulating library of the city, and contains 149,000 volumes. Other libraries are the Athenæum, Apprentices' Library, Library of the Law Association, and Friends' Library.

**Learned Societies.**—The American Philosophical Society is the oldest organized body for the pursuit of philosophical investigation in its broadest sense in America. It was founded also by Franklin, 26th May 1743, and incorporated 15th March 1780, with its founder as president. It began the publication of its transactions in 1773, and the 22d volume has been recently issued. The publication of the proceedings of this society was commenced in 1838, and still continues. Its library contains about 23,000 volumes, and the society also possesses valuable manuscript correspondence of Franklin. The Academy of Natural Sciences was organized in 1812, and its ornithological collection, which contains over 25,000 specimens, is claimed to be the finest in the world. It has a fine library of works on the natural sciences, and publishes a journal and its proceedings. The Franklin Institute for the promotion of the mechanic arts started in 1824. It has a valuable library of over 20,000 volumes devoted to mechanics and kindred subjects, and has ever since its organization published a monthly journal. The Historical Society of Pennsylvania was founded in 1824, and is devoted to the preservation of material relating to the history of the State. Its collections are of great historical value, and its library contains more than 20,000 volumes. The Numismatic and Antiquarian Society of Philadelphia, founded in 1858, was the first organization on the American continent to engage in the pursuit of numismatic science. It has a fine collection of coins and a good library. Another notable body is the College of Physicians and Surgeons, with a medical library of 28,000 volumes and a fine museum of prepared specimens.

**Newspapers.**—The *American Weekly Mercury* was the first newspaper published in Philadelphia and the third in the colonies. It was started on 22d December 1719 by Andrew Bradford, a son of William Bradford, the first printer in the middle colonies, and this paper was the first newspaper in the same section. On 21st September 1784 the first daily newspaper in the United States was issued at Philadelphia. It was the *American Daily Advertiser*, subsequently published as *Poulson's Daily Advertiser*, and later

merged into the *North American and United States Gazette*, which is thus by succession the oldest daily newspaper in the United States. There are at present (July 1884) twenty daily newspapers published in Philadelphia, eight of them being afternoon papers, with an average circulation of \$75,000, and seventy-seven weekly newspapers, chiefly religious and Sunday secular papers.

**Social Life.**—Among Philadelphia's claims to priority she has in her midst one of the oldest purely social clubs in existence,—the Colony or State in Schuylkill, which was formed in 1732. The other purely social clubs in the city are the Philadelphia Club, Social Art Club, and University Club. The Union League (Republican) and Commonwealth (Democratic) are mixed social and political clubs. There are some organizations of a mixed social and charitable character, such as the St George Society (1772), the St David Society (1729), the St Andrew's Society (1749), and the Sons of St Patrick or Hibernian Society (1771). The First Troop of Philadelphia City Cavalry, formed in 1774, is a military organization of high social standing. There are also a gentlemen's driving park or racetrack and innumerable cricket and boat clubs. There is an opera-house capable of accommodating 3500 persons, and five first-class theatres, but Philadelphia as a community seems not to be a theatre-going people.

**History.**—Down to the War of Independence the history of Philadelphia is virtually that of PENNSYLVANIA (q. v.). The patent granted to William Penn (see PENN, p. 495) for the territory embraced within the present Commonwealth of Pennsylvania was signed by Charles II. on the 24th of March 1681, and in the autumn of that year Penn appointed three commissioners to proceed to the new province and lay out a great city. This seems to have been his chief thought in settling the province, and his instructions to his commissioners were to select a site on the Delaware where "it is most navigable, high, dry, and healthy; that is where no ships can best ride, of deepest draught of water, if possible to land or unload at the bank or key side without boating or lightering of it." These commissioners were William Crispen, Nathaniel Allen, John Bezar, and William Heage. Crispen, who was a kinsman of the proprietor, died on the voyage out, and the remaining commissioners arrived toward the close of the year. They had been preceded by Penn's cousin, Captain William Markham, as deputy-governor, and were soon followed by the surveyor-general of the province, Thomas Holme, who, as may be understood from his office, was one of the most important men in the early history of the city and State. The site of the city was speedily determined upon, and Holme proceeded to lay it out according to the medical instructions of Penn, and his *Portraiture of the City of Philadelphia in the Province of Pennsylvania in America* was published and sold by Andrew Sowle in Shoreditch, London, in 1683. This plan shows the old part of the city as it is to-day, covering between 1200 and 1800 acres. Unfortunately no date can be fixed, even approximately, for the founding of the city; nor is the date known of Penn's first visit to the capital of his province. He landed at Newcastle on the Delaware on 27th October 1682, and two days later came up as far as Upland, now Chester, 13 miles south of Philadelphia. He doubtless did not remain long so near his scheme without viewing it, but when he did first come to Philadelphia is now unknown.<sup>1</sup>

The seat of government was fixed in Philadelphia by the meeting of the governor and council on the 10th of March 1683, and the General Assembly met two days later. For 117 years the city continued to be the capital of Pennsylvania, and was the most important town, commercially, politically, and socially, in the colonies during nearly the whole of this period. In October 1685 the first printing press established in the middle colonies was set up here by William Bradford; the earliest specimen of his work which has survived to our day is his *Kalendarium Pennsylvaniae or America's Messenger, being an Almanack for the year of Our 1688*. The printing press was followed in 1690 by a paper-mill, erected by William Rittenhouse, a Mennonite preacher, on the Wissahickon creek, a locality which has ever since remained a favourite for the manufacture of paper. The one man, next to William Penn, whose influence was most deeply impressed upon Philadelphia as upon the affairs of the colony, was Benjamin Franklin, whose power was felt almost on his first landing in October 1723, when in his eighteenth year, and its impress is to-day. Four years after he settled here he formed a club of mutual improvement, which he called the "Junto," out of which subsequently grew the American Philosophical Society for the promotion of useful knowledge and the Library Company of Philadelphia. He also originated the present university of Pennsylvania, organized the first fire-engine company in the city, and was instrumental in founding the Pennsylvania Hospital. In March 1776

<sup>1</sup> In Philadelphia for many years stood a famous elm tree, known as the treaty tree, and when it was blown down in 1810 a stone was placed to mark the spot. Tradition had it that under this tree Penn, on his first coming to Philadelphia, held a treaty of amity and friendship with the Indians—a tree not sworn to and never broken. The light of investigation has dispelled the tradition and relegated it to the category of mythology, along with the story of William Tell and Captain Smith and Pocahontas.

the first Arctic expedition ever sent out from America sailed from Philadelphia. The vessel, called the "Argo," was commanded by Captain Swaine, but her voyage accomplished nothing of importance. In 1770 the first factory for the manufacture of fine porcelain in the colonies was established at Philadelphia by a Swiss and an Englishman, but the difficulty of obtaining competent workmen forced its abandonment two years later. During the war of the revolution Philadelphia was the virtual capital of the colonies and the scene of all the prominent civil events of those stirring times. The first Congress met at Carpenter's Hall on 4th September 1774; on 24th May 1776 Congress reconvened in the old State house and here continued its sittings, except when the city was threatened by the enemy and in his possession. On 2d July 1776 the "resolutions respecting independency" were passed, and on the 4th July 1776 Philadelphia was the scene of the adoption of the Declaration of Independence; and the old State house became ever afterwards Independence Hall. On 9th July 1778 "the articles of confederation and perpetual union between the independent States of America" were here adopted and signed, and in the same place the convention to frame a constitution for the United States of America met on 14th May 1787, with Washington as presiding officer, and continued its sessions until 17th September, when the work was finished and the fundamental law of the land given to the world. The affairs of state were thus placed on a firm foundation, while the affairs of the church had received the attention of the people the previous year. In June 1786 the clerical and lay delegates from the Protestant Episcopal churches in the United States met in Philadelphia and formally organized "the Protestant Episcopal Church in North America." The Congress of the United States had held its opening session in New York, but in December 1790 it reassembled at Philadelphia; and for ten years the seat of government was at Philadelphia, until it was permanently removed to the District of Columbia. Here Washington delivered his farewell address to the people of the United States, and here he retired from public life. As in Philadelphia the first bank in the colonies had been opened—the bank of North America in 1781—so in Philadelphia the first mint for the coinage of the money of the United States was established in 1792. Both of these institutions are still in full operation. In April 1816 Congress incorporated the bank of the United States, which was the second banking institution of that name chartered by the Government, and fixed it at Philadelphia. The affairs of this institution form a very important chapter in the history of the city, as indeed in the history of the whole country. It had an unsettled existence, until the final blow came from President Jackson, towards the close of his first term of office, in 1833. Being opposed to the continuance of the bank, he withdrew the public deposits, amounting to about \$8,000,000, the result of which was widespread ruin and business depression, not only in Philadelphia but elsewhere.

The two events of greatest note which have taken place in the city in recent years have been the centennial celebration of the independence of the colonies in 1876, and the bi-centennial celebration of the landing of William Penn in 1822. The centennial celebration was of the greatest moment, owing to the Exposition of the Industries of All Nations, which was open from 10th May to 10th November; the total admissions reached the number of 9,910,966 persons. (C. H. H.)

PHILÆ. See EGYPT, vol. vii. p. 783 *qy*.

PHILEMON, the oldest poet of the New Attic Comedy, was the son of Damon, and was born at Soli in Cilicia, or, according to others, at Syracuse; but early in life he settled at Athens. Since he died in 262 B.C. at an age variously stated at from 96 to 101 years, he must have been born somewhere about 360. He was thus older than his contemporary and great rival Menander, whom he frequently vanquished in poetical contests, and whom he long survived. Posterity, however, reversed the judgment of their contemporaries and assigned the palm to Menander. Philemon's first play was put on the stage about 330, while Menander did not exhibit until 321. It appears that, once being worsted in a poetical competition, Philemon went into exile. He certainly made a journey to the East, but whether on the occasion of his exile or in compliance with the invitation of Ptolemy, king of Egypt, we cannot say. On this journey, being driven by a storm to the coast of Cyrene, he was treated with cool contempt by Magna, king of Cyrene, whom he had satirized. From the various legends told about his death he would seem to have died in the full enjoyment and use of his poetical power. Of the ninety-seven plays which he is said to have composed none are extant; the titles of fifty-three

have been preserved, but some of these may have been the work of his son, the younger Philemon, who is said to have composed fifty-four comedies. *The Merchant* and *The Treasure* of Philemon were the originals respectively of the *Mercator* and *Trinummus* of Plautus. The New Attic Comedy, of which Philemon was in a sense the founder, dealt mainly with subjects drawn from private life, which were worked up in elaborate plots and treated in a prosaic style, to the exclusion, on the whole, of the political tendency, stinging personal satire, and warm poetical colouring, which had marked the Old Attic Comedy. These characteristics of the New Comedy had already appeared, though in a less degree, in the Middle and even in the Old Attic Comedy; so that to Philemon belongs the credit, not of inventing, but of developing a style which had occasionally been employed before. In its absence of poetical idealism and restriction to the prosaic realism of daily life the New Comedy stands to the Old somewhat as the comedies of Molière or Sheridan stand to those of Shakespeare. Its repertoire was limited to a few stock characters—the imprudent lover, the designing fair, the stingy father, the greedy parasite, the blustering swashbuckler—and its plots rang the changes on the well-worn theme of thwarted but faithful love, rescued from its difficulties by the discovery of a long-lost relative and ending in marriage. In the many fragments of Philemon preserved by Stobæus, Athenæus, and other writers there is much wit and good sense.

The fragments have been collected and edited by Meineke, *Menandri et Philemonis Reliquiæ*, Berlin, 1823; and again in his *Fragmenta Comicorum Græcorum*, vol. iv., Berlin, 1841. They are also appended to the Didot edition of Aristophanes (Paris, 1839).

PHILEMON, EPISTLE TO. This, which is the shortest of the extant epistles of St Paul, stands to the other books of the New Testament in a relation similar to that of the book of Ruth to the other books of the Old Testament. It is an idyl of domestic life. Onesimus, the slave of one of Paul's converts in Asia Minor, had run away from his master, probably, as was often the case with runaways, after stealing some of his money. He had come to Paul, more probably at Rome than, as some have thought, at Cæsarea, and Paul had converted him. Paul sends him back to his master, begging that he may be kindly treated as being now a brother Christian, and formally undertaking to repay what he owed. The epistle is addressed not only to Philemon but to Apphia, who was probably his wife, to Archippus (possibly the head of the community at Colossæ or Laodicea, Col. iv. 17), and to the community which either, like some of the Roman *collegia*, consisted of Philemon's household or held its meetings in his house. It has sometimes been regarded as an appendix to the epistle to the Colossians on the grounds (1) that Onesimus was sent with both letters (Col. iv. 9; Philem. 10-12), (2) that in both letters salutations are sent to Archippus (Col. iv. 17; Philem. 2), and (3) that the same persons are mentioned in both letters as being with Paul at the time of writing (Col. i. 1, iv. 7-14; Philem. 1, 23, 24). This apparent connexion with the epistle to the Colossians is the basis of the chief arguments which have been used against its genuineness. Baur (*Paul*, E. T., vol. ii. p. 84) thinks that this "attractive, graceful, and friendly letter" is merely a practical commentary, in the form of a fiction, on the general conception of the relations of masters to Christian slaves which is set forth in Col. iv. 1. But this view has few supporters. The genuineness of the epistle is almost universally admitted. The best modern works upon it are Bishop Lightfoot's *Colossians and Philemon* (3d ed., London, 1879) and Holtzmann's essay, "Der Brief an Philemon," in the *Zeitschr. f. wissenschaftl. Theol.*, 1873, p. 428.

**PHILETAS**, a distinguished poet and critic of the Alexandrian school, was the son of Telephus and a native of the island of Coa. He lived in the reigns of Philip, Alexander the Great, and Ptolemy I. of Egypt, the last of whom appointed him tutor to his son Ptolemy Philadelphus. His life thus fell in the latter part of the 4th and early part of the 3rd century B.C. He was a contemporary of Menander, a friend of the poet Hermesianax of Coa, and lived into the time of Aratus. Amongst his pupils were Theocritus and Zenodotus. He was sickly and so thin that he was said to carry lead in his shoes to keep himself from being blown away. The story runs that he died from the excessive assiduity with which he sought the answer to the sophistical problem called "The Liar."<sup>1</sup> A bronze statue of him was erected in Coa.

The fame of Philetas rested chiefly on his elegiac verses, in which, however, he was esteemed inferior to the younger poet Callimachus. He is frequently mentioned by the Latin elegiac poets Propertius and Ovid. From Hermesianax and Ovid we gather that his verses were amatory and celebrated the praises of the fair Bittis or Battis, but her name does not occur in the existing fragments, which are of a melancholy rather than an amatory tone. In one of his poems (*Demeter*) he depicted the grief of Demeter for the loss of Proserpine; in another (*Hermes*) the love of Polymela for Ulysses. The latter poem appears from the fragments to have been composed in hexameter verse. Further, he wrote epigrams and poems called *Italyia*. There is no evidence that he wrote bucolic poems, for the passage in Moschus formerly quoted to prove this is an interpolation of Mussena. Some iambic verses are attributed to him, probably by a mistake arising from a common confusion between names beginning with *Phil*. Besides his poems, Philetas was the author of a vocabulary explaining the meanings of rare and obscure words, including words peculiar to certain dialects. He also wrote notes on Homer. The work on *Naxos* (*Naxos*), sometimes attributed to him, was perhaps rather by Philetas. The fragments of Philetas have been edited by Kayser, Göttingen, 1793, and by Bach, Halle, 1829.

**PHILIDOR**, FRANÇOIS ANDRÉ DANICAN (1726-1795). See *CHESS*, vol. v. p. 601.

**PHILIP**, one of the twelve apostles, mentioned fifth in all the lists (Matt. x. 3; Mark iii. 18; Luke vi. 14; Acts i. 13), is a mere name in the Synoptists, but a figure of some prominence in the Fourth Gospel. There he is said to have been "of Bethsaida, the city of Andrew and Peter," and to have received his call to follow Jesus at Bethany, having previously been, it would seem, a disciple of the Baptist (John i. 43, 44). Philip was at that time the means of bringing Nathanael to Jesus (John i. 45), and at a later date he, along with Andrew, carried the request of the inquiring Greeks to the Master (John xii. 22). Philip and Andrew alone are mentioned by name in connexion with the feeding of the five thousand (John vi. 5, 7), and Philip is also one of the few interlocutors in John xiv. After the resurrection he was present at the election of Matthias as successor to Judas, but he does not again appear in the New Testament history; it is, however, implied that he still continued in Jerusalem after the outbreak of the first persecution.

According to Polycrates, bishop of Ephesus, in his controversial letter written to Victor of Rome towards the end of the 2d century (ap. Euseb., *H. E.*, iii. 31, v. 24), the graves of Philip, "one of the twelve," and of his two aged virgin daughters were in (the Phrygian) Hierapolis; a third daughter, "who had lived in the Holy Ghost," was buried at Ephesus. Proclus, one of the interlocutors in the "Dialogue of Caius," a writing of somewhat later date than the letter of Polycrates, mentions (ap. Euseb., *H. E.*, iii. 31) "four prophetesses, the daughters of Philip at Hierapolis in Asia, whose tomb and that of their father are to be seen there." But Eusebius himself proceeds expressly to identify this Philip with the Philip mentioned in the Acts of the Apostles as living in Caesarea; and in another place he alludes to Philip "the apostle" as having preached the gospel to the Ethiopian eunuch (*H. E.*, ii. 1). Clement of Alexandria also (*Strom.*, iii. 6 [52]) incidentally speaks of "Philip the apostle" as having begotten children and as having given daughters in marriage. In another place (*Strom.*, iv. 9 [73]) Clement quotes, with concurrence, a passage from the Gnostic

<sup>1</sup> The problem was this: If a man says he is telling a lie, does he speak truly or falsely? | 4

Heraclion, in which it is expressly said that Matthew, Philip, Thomas, and others died without "confession of the voice," or, in other words, were not, properly speaking, confessors or martyrs. A later stage of the tradition regarding Philip appears in various late apocryphal writings which have been edited by Tischendorf in his *Acta Apostolorum Apocrypha*, and in his *Apocalypses Apocrypha*. According to the *Acta Philippi*, this apostle, along with Bartholomew and Mariamme, the sister of the latter, came to Ophioromya or Hierapolis, where the success of their preaching, and more particularly the conversion and miraculous healing of Nicanora, the wife of the governor, provoked bitter hostility. Philip was crucified head downwards, and invoked curses on his persecutors. His imprecations were heard, but the Lord Jesus immediately afterwards appeared to him and rebuked him for his want of meekness, further announcing his approaching death, and that on account of his sin he would be kept back forty days from the gates of paradise. The *Acta Philippi in Hellade* (i.e., "in the city of Athens, called Hellas") are still more fantastical. An apocryphal book, under the title *Actus Philippi*, is condemned in the canon of Gelasius. Since the 6th century Philip has been commemorated in the West, along with St James the Less, on 1st May, their relics being deposited in the same church in Rome; in the Eastern Church Philip's day is 14th November, and that of James the Less 23d October.

**PHILIP**, "the evangelist," is first mentioned in the Acts (vi. 5) as one of "the seven" who were chosen to attend to certain temporal affairs of the church in Jerusalem in consequence of the murmurings of the Hellenists against the Hebrews. After the martyrdom of Stephen he went to Samaria, where he preached with much success, Simon Magus being one of his converts. He afterwards instructed and baptized the Ethiopian eunuch on the road between Jerusalem and Gaza; next he was "caught away" by the Spirit and "found at Azotus" (Ashdod), whence "passing through he preached in all the cities till he came to Caesarea" (Acts viii.). Here some years afterwards, according to Acts xxi. 8, 9, he entertained Paul and his companion on their way to Jerusalem; at that time "he had four daughters which did prophesy." At a very early period he came to be confounded with the subject of the preceding notice (*q.v.*); the confusion was all the more easy because, while he undoubtedly could in a certain well-understood sense of the word be called an "apostle," writers naturally refrained from applying to him the more ambiguous designation of "evangelist." "Philip the deacon" is commemorated on 6th June.

**PHILIP**, tetrarch of Iudæa. See *HEROD PHILIP*, vol. xi. p. 755.

**PHILIP**, the name of five kings of Macedon. The greatest of these was **PHILIP II.** (382-336 B.C.), the first founder of the **MACEDONIAN EMPIRE** (*q.v.*). After the death of Alexander the Great, Arrhidaeus, a bastard of Philip II., reigned as **PHILIP III.**, till he was put to death by Olympias in 317. **PHILIP IV.**, son of Cassander, reigned only for a few months in 296. **PHILIP V.**, the last but one of the kings of Macedon and son of Demetrius II., was born in 237, and came to the throne on the death of his uncle, Antigonus Doseon, in 220. In the course of the next three years he acquired a brilliant reputation by his exploits against the *Ætoli*ans and their allies in the Peloponneseus in the Social War; but after this, though his whole career was marked by military and even political ability, the bad sides of his character became predominant, and he appeared more and more as a perfidious, morose, and cruel tyrant, thus alienating the affections of the Greeks and ultimately even of his own subjects. His life was full of ambitious schemes, but he made the cardinal error of siding with Carthage against Rome. His character made it easy for the Romans to raise against him a powerful coalition of his neighbours, but Philip held his ground with vigour till the armies of the republic themselves appeared on the field. How he was finally driven out of Greece has been related under **FLAMINIUS**. After 191 Philip for some time accepted his reverses and sought the friendship of Rome, helping the republic against Antiochus;



but his ambition and the jealousy of the senate gradually led to fresh complications, and a new war was imminent when Philip died in 179, mainly of remorse for the death of his younger son Demetrius, the favourite of Rome, whom he had executed on an accusation forged by his elder son and heir Perseus.

PHILIP I (1052-1108), king of France, was the son of Henry I and Anne of Russia, and was born in 1052. He was associated with his father on the throne in 1059, the consecration taking place at Rheims (23d May), and he succeeded to the undivided sovereignty in the following year (4th August 1060), first under the regency of his mother, and afterwards, from 1063 to 1067, under that of Baldwin V., count of Flanders. In 1072 he married Bertha, daughter of Robert the Frisian, at whose hands he had sustained a shameful defeat at Cassel in the preceding year. His jealousy of William the Conqueror led him into an act of overt hostility in 1075, when his troops raised the siege of Dol, and a state of war, interrupted by inconsiderable intervals, continued thenceforward to subsist until the death of William. Philip afterwards supported, but ineffectually, the pretensions of Robert of Normandy against William Rufus. In 1092 he brought himself into collision with the church by shutting up his wife Bertha with her three children in the castle of Montreuil, and espousing Bertrada of Montfort, whom he had induced to leave her husband, Fulk of Anjou. The marriage was indeed sanctioned after Bertha's death by a subservient council at Rheims in 1094, but led to the king's excommunication by the council of Autun in the same year—a censure which was renewed by Pope Urban II. at Clermont in 1095. Having dismissed Bertrada early in 1097, he was forthwith absolved, but on a repetition of the offence three years afterwards the sentence was renewed, at Poitiers, and only removed by Paschal II. after Philip had once more submitted himself to the church. In 1100 he made his son Louis (afterwards Louis VI.) joint king, and his death took place at Melun on 29th July 1108. See FRANCE, vol. ix. pp. 537-539.

PHILIP II. (1165-1223), surnamed "Augustus, king of France, was the son of Louis VII., and was born in August 1165. When fifteen years old he was crowned joint king at Rheims on 1st November 1179. In the following year he was again crowned along with his newly-wedded wife, Margaret of Hainault, at St Denis (29th May 1180); the death of his father took place a few months afterwards. For an account of Philip II.'s character and of the leading events of his reign the reader is referred to FRANCE, vol. ix. pp. 540-542. He died at Mantes on 14th July 1223.

PHILIP III. (1245-1285), surnamed "the Rash," king of France, was born in 1245 and succeeded his father Louis IX. on 25th August 1270, at Tunia, where, after continuing the siege for some time, he made a truce of ten years and embarked for France in the following November. He was twice married, first to Isabella of Aragon in 1268, and subsequently to Mary of Brabant. He died at Perpignan on 5th October 1285. See FRANCE, vol. ix. p. 544.

PHILIP IV. (1268-1314), surnamed "the Fair," son of the preceding, was born at Fontainebleau in 1268, was married to Joanna, queen of Navarre, in 1284, accompanied his father into Aragon in 1285, and was proclaimed king of France at Perpignan on 6th October of that year. See FRANCE, vol. ix. pp. 544-545. He died at Fontainebleau on 29th November 1314.

PHILIP V. (1293-1322), surnamed "the Tall," second son of the preceding, succeeded his elder brother, Louis X., in January 1317, and was succeeded by his younger brother Charles IV. in January 1322.

PHILIP VI. (1293-1350) was the eldest son of Charles, count of Valois, the younger brother of Philip IV., and

was born in 1293. He succeeded his cousin Charles IV. in 1328, and died at Nogent-le-Roi near Chartres on 22d August 1350. See FRANCE, vol. ix. pp. 545-546.

PHILIP I. (1478-1506), of Castile and Aragon, surnamed "the Handsome," was the son of the emperor Maximilian I. and Mary, the only child of Charles the Bold, last prince of the house of Burgundy, and was born at Bruges on 22d July 1478. He succeeded his mother in 1482, Maximilian being recognized as governor and guardian during the minority by all the provinces, except Flanders, the burghers of which took possession of Philip, and carried on the government in his name. This arrangement subsisted until 1489, when a long struggle resulted in the triumph of Maximilian, who henceforth had the guardianship uncontrolled. In 1494 Philip received the homage of the various states of the Netherlands, and in 1496 he was married to Joanna (Juana la Loca), second daughter of Ferdinand and Isabella of Castile and Aragon. On the early death of the other children of these sovereigns the succession vested in Joanna, and Philip as her husband proceeded to Spain, where he was recognized as heir-presumptive by the cortes of Toledo and Saragossa (representing Castile and Aragon respectively) in 1502. He returned, however, to Flanders before the close of the year, and was still absent when, on the death of Isabella in November 1504, Ferdinand caused Joanna and Philip to be proclaimed sovereigns of Castile, but at the same time assumed the regency to himself. It was only with difficulty that Ferdinand was induced to retire to Aragon and so make way for the new king in June 1506. Philip died three months afterwards (25th September 1506) at Burgos. His children by Joanna were Charles V., emperor, and king of Spain; Ferdinand I., emperor; Isabella, queen of Denmark; Leonora, queen of Portugal and afterwards of France; Mary, queen of Hungary and governor of the Netherlands; and Catharine, queen of Portugal.

PHILIP II. (1527-1598), king of Spain, was the son of the emperor Charles V. and Isabella of Portugal, and was born at Valladolid on 21st May 1527. He was brought up in Castile under the care of his mother, who died when he was twelve years old. As Philip grew up, his father, though he rarely saw his son, watched carefully over his education and strove to fit him for political life. In 1543 Philip married Mary of Portugal, who died in 1545, soon after the birth of a son, Don Carlos. In 1548 Charles V. summoned Philip to Brussels, that he might gain some experience of the peoples whom he would be called upon to rule. He was not, however, popular with his future subjects. He had already formed his character upon the model of Spanish haughtiness. He was cold, reserved, punctilious about decorum, and wanting in geniality. The Italians did not care for him; the Flemings disliked him; the Germans hated him. His appearance and manner did not further his father's plan of securing his election to the empire. The scheme failed, and Philip's presence was in no way helpful. In 1551 he returned to the more congenial task of governing Spain.

The death of Edward VI. of England opened out to Charles V. new prospects for his son. Queen Mary regarded the emperor as her only friend, and submitted herself entirely to his guidance. She received with joy a proposal for her marriage with Philip. The English opposition broke down with the failure of Wyatt's rebellion, and in 1554 Philip came to England to claim his bride. Charles V. resigned to him Naples and Sicily that he might not come as a needy prince. Philip was well supplied with Spanish gold, and was charged by his father to spare no pains in conciliating the English. He tried his best; but his cold, ungenial manner was a hopeless obstacle to his success. Mary was devotedly attached to her hus-

band, who exercised a moderating influence over the queen's zeal for the re-establishment of Catholicism. Charles V. wished to secure England as an ally, and subordinated religious to political considerations. Philip was not naturally fitted for conciliatory action, and was not happy in England. He found that his wife was destined to be childless and that he had no prospect of succeeding to the English crown. At the end of 1555 he joyfully obeyed his father's summons to go to Brussels. Charles V., worn out by the fatigue of a long reign, resolved to abdicate in favour of his son, and this he did on 16th January 1556.

Philip II. was now king of Spain, Naples, and Sicily, duke of Milan, lord of Franche-Comté and the Netherlands, ruler of Tunis and the Barbary coast, the Canaries and Cape de Verd Islands, the Philippines and Spice Islands, large colonies in the West Indies, and the vast territories of Mexico and Peru. These great dominions had fallen into his father's hands and were united only by their dependence on their ruler. It was Philip's task to give them an organic unity and combine them into a system. First he had to face a threatening league against his power. Pope Paul IV., a Neapolitan, was imbued with hatred of the Spanish rule, and formed an alliance with Henry II. of France. Philip sent the duke of Alva, who speedily reduced the intractable pope. But Philip was too good a Catholic to press his victory. He was content to leave the pope powerless, and Alva on his knees asked pardon for bearing arms against the church. The war against France was pursued with equal success and greater results. Philip's army, led by Philibert of Savoy, entered Picardy and besieged St Quentin. The French were defeated in an attempt to relieve the city, and St Quentin was stormed. The French retaliated by seizing Calais from England, and thence advanced into Flanders, where they were again defeated in the bloody battle of Gravelines. Both Philip II. and Henry II. were destitute of resources and wished for peace; but Philip II. was the better diplomatist. The treaty of Cateau Cambresis in 1559 restored to him all that France had won by its long warfare against Charles V. in Italy and the Netherlands.

Thus Philip began his reign with glory, and Europe saw that Charles V. had no unworthy successor. Yet Philip was not anxious for military glory. His finances were embarrassed and he felt the need of a period of peace. For the purpose of maintaining his political supremacy he proposed to continue his English alliance by marrying Elizabeth when she succeeded Mary on the English throne. Elizabeth did not at once reject the proposal; but she gradually entered upon a religious policy which made marriage with Philip impossible. The Spanish king rapidly changed his plans and cemented his alliance with France by a union (24th June 1559) with Isabella, daughter of Henry II. He made arrangements for the government of the Netherlands, and at the end of 1559 returned to Spain, where he remained for the rest of his life.

The policy of Philip was steadily directed towards welding his dominions together in dependence on himself and extending his influence over Europe. The power of Charles V. had had no definite centre. The emperor had recognized the claims of his separate dominions upon him, and had striven to be neither German, Spanish, Flemish, nor Italian. Philip identified himself entirely with Spain. Castile was to be the seat of his monarchy, and that monarchy was to be absolute. He was devoted to Catholicism, and during his reign superseded the pope as the head of the Catholic party in Europe. But the interests of Catholicism were in his mind identified with his own personal interests, and under the cover of zeal for the church he pursued the aggrandisement of Spain. In Spain itself his care for the maintenance of the Catholic

faith accorded with the temper of the people. The long continuance of war against the Moors had identified orthodoxy with purity of race, and heresy was regarded as a taint in the blood. The rigour of the Inquisition preserved the national honour; the auto-da-fé was a means of ridding the land of dangerous elements. This uncompromising spirit of Spain in religious matters its king wished to extend to the rest of his dominions.

Philip had none of his father's personal activity. Though his mind was always engaged in the business of the state, he did not care for the excitement of personal conflict. He was no warrior, and never took the field. He felt himself best qualified to direct his policy from afar. He was resolved to make the fullest use of others, yet to keep the guidance of affairs in his own hands. He increased the number of councils for the management of the business of the different provinces of his realm, and in these councils natives of the various provinces had seats. But the general direction of affairs was in the hands of a privy council, entirely composed of Spaniards. At first this council consisted chiefly of the members of Philip's household, the men whom he had known in early days. Foremost amongst them were the duke of Alva and Buy Gomes de Silva, prince of Eboli. Alva was a general, Gomes a courtier, and the two men were in permanent opposition. This exactly suited Philip's views. He was never present in person at the sittings of the council. All questions on which he wished for its opinion were reduced to writing and laid before it. Its recommendations were similarly submitted to the king in writing. There was no initiative except by his pleasure, no decision which was not due to his personal approval. He gained all the advantages of opposing views amongst his ministers without identifying himself with any. No minister could become a necessity to him, and he could withdraw his favour at will. Philip's regents and ministers in the several provinces had large authority, but were never allowed to forget their dependence on the central power. Every land was submissive except the Netherlands, where the nobles resented their exclusion from the government, and saw with alarm the steady advance of Philip's system. A new ecclesiastical organization increased the number of bishops, who were all dependent on the king, and diminished the revenues of the monasteries, which furnished provisions for the younger members of the noble families. The introduction of the Spanish Inquisition threatened to destroy entirely the political importance of the nobles. In the general discontent the Protestant feeling of the towns made common cause with the national jealousy of the nobles. A strong opposition was formed, and in 1566 the Netherlands were in revolt. For a time Philip wavered between a policy of conciliation and a policy of repression. At last he listened to the advice of the duke of Alva, and sent him to reduce the rebels. Alva treated the revolted provinces with merciless severity; he crushed, but he could not subdue. The Netherlands were still unpacified, while Alva's cruelty destroyed their commerce. Their wealth had been the chief source of revenue to Charles V.; Philip II. no longer found it flow into his coffers. For seven years Alva resolutely tried his policy of repression; but the spirit of the Netherlands remained unbroken, and round their alumbering revolt all the enemies of the Spanish monarchy began to gather. Alva was recalled and fell into disgrace. A more pacific successor, Don Luis de Requesens, was sent to try a more conciliatory policy.

In domestic life, meanwhile, Philip was unhappy. His son Don Carlos developed an ungovernable temper, and did not hesitate to condemn his father's caution as unworthy of the traditions of his house. He wished to distinguish himself, and was on the point of quitting

Spain when his father, as a measure of precaution, had him imprisoned. In prison Don Carlos yielded to sullen despair, and gave way to excesses, which Philip did not try to check. In consequence of this unwholesome life Don Carlos died in 1568, and it was a bitter blow to the haughty king to inform foreign princes of the facts. It would seem that Philip was glad to be rid of one whom he could not manage; he did not hasten the death of Don Carlos, but he took no steps to prevent it. A few months later died Queen Isabella, leaving Philip without a male heir. In 1570 he married his fourth wife, Anne of Austria, his niece, who died in 1580. Only one of her sons survived to manhood, and he succeeded his father as Philip III.

Meanwhile the hopes of Spain were fixed on Philip's half-brother, Don John of Austria, who first showed his military skill by putting down a serious revolt of the Moriscos in the Alpujarras, and was then sent to command the Spanish fleet in the joint expedition of the Mediterranean powers against the Turk. He commanded at the decisive battle of Lepanto in 1571, which stemmed the tide of Turkish conquest. Brave and ambitious, Don John longed for a kingdom, and offered to undertake the conquest of the African coast. But Philip did not wish his brother to gain too much military glory. He sent him in 1576 to succeed Requesens in the Netherlands. Don John was full of great schemes,—to pacify the Netherlands, invade England, release Mary Queen of Scots, and become her husband. But the Spanish treasury was exhausted. Philip would send no more supplies, and left Don John to temporize with the Netherlanders, a task for which he was entirely unfit. Overwhelmed with disappointment and the sense of failure, Don John died in 1578, leaving the work which he could not accomplish to be undertaken by the patient genius of Alexander Farnese.

Don John had had the art of impressing his great schemes on those around him. He sent his secretary, Escovedo, to urge his wishes on Philip, whose jealous mind was filled with suspicion. Escovedo awakened the personal dislike of Antonio Perez, and was murdered by that minister's instrumentality (see PEREZ). The fall of the old parties in the council brought forward new men and inaugurated a new policy. Cardinal Granvolla, Juan Idiaguez, and Christoval de Moura became the king's chief advisers. They were men who depended solely on his favour, and were not connected with the old nobility of Castile. Hitherto Philip's policy had been in the main pacific. He had aimed at the internal consolidation of the monarchy, and had striven by every means to overcome the revolt of the Netherlands. But the resolute temper of the Netherlanders was encouraged by hopes of foreign help. England, France, and even Austria in turn displayed their jealousy of Philip's power by helping to keep alive the insurrection. Around the revolt of the Netherlands centred the chief questions of European politics. Philip at length determined to make the subjection of the rebellious provinces part of a great scheme to extend the power of Spain over Europe. In the second period of his reign he came forward as the disturber of European peace, determined to reduce Western Christendom to religious unity under his own rule. He interfered in the internal politics of every country and seized on every opportunity for pursuing his own schemes. His first step in the career of aggrandizement was taken in 1580 by the reduction of Portugal, when he claimed the vacant crown by right of his mother. The duke of Alva overran the country before any other power had time to interfere. The last of the great Spanish nobles, who had already felt the weight of the king's displeasure, was still a willing instrument in extending the royal despotism. Philip succeeded in impressing on Spain an unreasoning loyalty, which took

the place of its old chivalrous patriotism. In the Netherlands he put William of Orange under the ban, and the assassination of William was the first sign of the fanatical bitterness which Philip was ready to encourage and to use. In France he resolved to check the power of the court and obtain an influence over French affairs. The strongly Catholic party resented the favour shown by Henry III. to the Huguenots, and was anxious about the succession to the crown. Headed by the Guises, they formed a league with Philip in January 1585, which plunged France into long and bitter warfare. The rapid advance of the League in France and the successes of Alexander Farnese in the Netherlands awakened the alarm of England. Troops were sent to the Netherlands, and the English privateers redoubled their attacks upon the treasure-ships of the Indies in the Spanish Main. Resolved to remove all hindrances from his path, Philip undertook the reduction of England. He trusted to the strength of the Spanish navy, the military skill of Alexander Farnese, and the discontent of the English Catholics. In 1588 the French king had become a mere instrument of the League, and Philip sent against England the "Invincible Armada." Its failure involved the failure of all his schemes, though this fact was not at first obvious. Philip bore his loss with resignation. "I sent my ships," he said, "against men, not against the billows. I thank God that I can place another fleet upon the sea." But he was never able to renew his attack upon England. The murder of Henry III. of France raised the question of the succession to the French crown, and Philip's protectorate over the titular Charles X. was admitted. On the death of Charles the Catholic party were willing to recognize Philip's daughter Isabella as their queen. But the resolute bearing of Henry of Navarre kindled anew the national feeling, and the discussions about Isabella's future husband brought political questions into the foreground and weakened the cohesion of the League. The death of Alexander Farnese in 1592 deprived Philip of the great general who alone could hold in check Henry of Navarre, and Henry's change of religion and absolution by the pope in 1593 did much to remove the religious difficulty to his recognition by all parties in France. Philip's schemes for a general European ascendancy entirely failed. He could not even recover the Netherlands for the Spanish monarchy. The northern provinces, banded together as the United Netherlands, made good their independence. The southern provinces returned to their obedience, but were ceded by Philip to his daughter Isabella and her husband Albert of Austria. The English cruisers became more and more dangerous in the Spanish Main, and in 1596 the English fleet sacked Cadiz. Philip II.'s reign ended in general failure. His resources were exhausted, and in 1597 he repudiated his debts. His economic policy was disastrous. He checked commerce by unwise taxes, trusted unduly to the wealth of the Indies, and encouraged the indolent haughtiness of the Castilians. He raised Spain to a high position, but left it with a ruinous system of government, which could only end in financial decay. Yet he was resolute and persevering to the end. He bore with constancy a painful and lingering illness, and his last words were, "I die like a good Catholic, in faith and obedience to the Holy Roman Church." But he knew that he left a feeble successor. His jealous temper showed itself in the narrow education and secluded life which he prescribed for his son, and thereby intensified the boy's natural timidity. "God has not been pleased," he sadly said at the last, "to grant me a successor capable of ruling my great realm." He died at the Escorial in September 1598.

Philip II.'s character is impressed on the great archi-

tectural monument of his reign, the Escorial, built in the solitude of the Guadarrama hills. The mighty mass of buildings contained a monastery, a burying-place for the royal house, and a palace for the king. It was built in consequence of a vow made at the battle of St Quentin. The battle was fought on St Lawrence's day 1557, and this fact was commemorated by arranging the building in the form of a gridiron. The cloister of the monastery supplied the bars, and the royal palace projected like the handle. Philip loved solitude. It harmonized with his habits of quiet industry. He governed his dominions by means of despatches, as a merchant seated in his office transacts commercial business in different quarters of the globe. All that could be done by patient industry, without political insight, Philip II. did. His strength lay in his steady persistency. During his reign he was the foremost figure in European history, but the only work which he accomplished was the formation of the Spanish character into the definite shape in which it influenced European culture.

*Literature.*—Cabrera, *Filipe Segundo*; Leti, *Vita di Filippo II.*; Sepúlveda, *De Rebus Gestis Philippi II.*; Albari, *Relaciones Venetas*; Weiss, *Papiers & Etat de Cardinal Granvelle*; Gachard, *Correspondances de Philippi II.*, and *Don Carlos et Philippi II.*; *Calendar of State Papers, Mary and Elizabeth*; *Documentos inéditos para la Historia de España*; Preecott, *History of Philip II.*; Mignet, *Antonio Perez et Philippi II.*; Motley, *The Rise of the Dutch Republic*, and *The United Netherlands*; Froude, *History of England under Mary and Elizabeth*; Banks, *Geschichte Frankreichs*, and *Fürsten und Völker von Süd-Europa*; Raumer, *History of the Sixteenth and Seventeenth Centuries*; Fornerson, *Histoire de Philippi II.*; Stirling-Maxwell, *Don John of Austria*. (M. C.)

PHILIP III. (1578-1621), king of Spain, son of Philip II. by his fourth wife, Anne of Austria, was born at Madrid on 14th April 1578, succeeded his father on 13th September 1598, married Margaret of Austria on 18th April 1599, and died at Madrid on 31st March 1621. In personal character he was weak and indolent, and his time was mostly spent at the Escorial in hunting and other pursuits of a private country gentleman, while the conduct of public affairs was left almost entirely in the hands of the duke of Lerma, who held the office of first minister from the king's accession until October 1618. See SPAIN.

PHILIP IV. (1605-1665), king of Spain, son of Philip III., was born at Valladolid on 8th April 1605, was married to Isabella of France on 25th November 1615, succeeded his father on 31st March 1621, and died on 17th September 1665. From 1621 to 1643 the well-known duke of Olivares held the reins of real power in the Peninsula; he was afterwards succeeded by the duke of Carpio. See SPAIN.

PHILIP V. (1683-1746), king of Spain, was the second son of the French dauphin, Louis, by his wife Maria Anna of Bavaria, and was born at Versailles on 19th December 1683. In 1700 Philip, at that time duke of Anjou, was called by the testament of the childless Charles II. to the throne of Spain. Quitting Versailles to take possession of his inheritance on 4th December, he arrived at the Buen-Retiro palace in Madrid on 18th February of the following year. At their parting his grandfather, Louis XIV., who a few months previously had concluded with England and Holland a treaty for the partition of the Spanish dominions, exhorted him to be a good Spaniard, but never to forget that he had been born a Frenchman; it was on the same occasion that he uttered the famous *mot*, "Mon fils, il n'y a plus de Pyrénées." Philip's recognition as king by the other European powers did not take place until the war of the Spanish succession was brought to an end by the treaty of Utrecht in 1713. In 1702 he married Maria Louisa, daughter of Victor Amadeus, duke of Savoy; shortly after her death in February 1714, which he felt deeply, he married Elizabeth Farnese (December), a step to which he was advised by the then

all-powerful *princesse des Ursins*. The disgrace of the princess immediately followed, and her place in the royal counsels was taken by ALBRONI (*q.v.*), who remained in power till December 1719. In 1724 Philip, under the influence of a profound melancholy which had seized him, resigned the crown by royal decree, dated 14th January 1724, in favour of his eldest son, Louis, who, however, died after a short reign of only seven months. Philip died on 9th July 1746 and was succeeded by his son, Ferdinand VI. See SPAIN.

PHILIP. For the dukes of Burgundy of this name, surnamed respectively "the Bold" (1342-1404) and "the Good" (1396-1467), see BURGUNDY, vol. iv. p. 536, and FRANCE, vol. ix. p. 548. For Archduke Philip, "the Handsome," see PHILIP I. of Castile and Aragon (p. 743).

PHILIP OF SWABIA (*c.* 1170-1208), rival of the emperor OTHO IV. (*q.v.*), younger son of the emperor Frederick I., was born about 1170. He was originally intended for the church, and, after being-provost of Aix-la-Chapelle, was chosen bishop of Würzburg in 1191; but in 1195 his elder brother brought about his marriage with a Byzantine princess, Irene, on which occasion he was named duke of Tuscany and Spoleto. In the following year he received also the duchy of Swabia. On the death of his elder brother he was elected king by a large body of princes and prelates at Mühlhausen (March 1198); this, however, was not acquiesced in by those opposed to the continuance of the imperial crown in the house of Hohenstaufen, whose choice fell on Otho. The coronation of the latter at Aix-la-Chapelle in July was soon followed by that of his rival at Mainz, and a civil war ensued, which, carried on with varying fortunes for ten years, was only brought to an end by the murder of Philip by Otho of Wittelsbach at Bamberg on 21st June 1208.

PHILIPPI, a city of ancient Macedonia, on a steep hill near the river Gangites (now the Angista), overlooking an extensive plain and at no great distance from the coast of the Ægean, on the highway between Neapolis (Kavala) and Thessalonica. Originally called Cranidea, or "Fountains," it took the name by which it has become famous from Philip of Macedonia, who made himself master of the neighbouring gold-mines of the Hill of Dionysus, and fortified the city as one of his frontier-towns. Octavius and Antony having in 43 B.C. gained a great victory over Brutus and Cassius in the plain of Philippi, the place received a Roman colony, *Colonia Julia Philippensis*, which was probably increased after the battle of Actium (*Col. Aug. Julia Phil.*). The inhabitants received the Jus Italicum, and Philippi was one of the cities specially designated as "first cities" (*πρώτη . . . πόλις*, Acts xvi. 12; see Marquardt, *Röm. Staatsverwaltung*, vol. i. p. 187). It was the scene of a striking incident in the life of St Paul, and it was to his converts here that he addressed the epistle noticed below. The site of the city, now altogether uninhabited, is marked by a number of ruins—the substructions of an amphitheatre, parts of a great temple of Claudius, &c.—which have furnished a variety of interesting inscriptions. At a little distance to the east is a huge stone monument, known to the Turks as Dikalitash and to the Greeks as the Manger of Bucephalus.

See Clarke's *Travels*, iii.; Hacket, in *Bible Union Quarterly*, 1860; Henzey, *Mission arch. en Macédoine*, and *C. I. L.*, iii. 1.

PHILIPPIANS, EPISTLE TO THE. This is one of the most characteristic of the letters of St Paul. It was addressed to the community at Philippi (see above), the first important European city which St Paul had visited, where he had formed a community with the apparently new organization of "bishops" and "deacons," and with which he had relations of especial intimacy. The immediate occasion of his writing the letter was his receipt of money

which the Philippians had sent by Epaphroditus to supply St Paul's personal wants. They were probably wealthier than some of the other communities which he had founded, and consequently he had not the reluctance which he felt elsewhere to receive money from them; the money so sent was no doubt part of the offerings of the community which constituted the Christian sacrifice (iv. 18),—a fund which was administered by the officers of administration, i.e., the bishops and deacons. It was consequently to those officers that he specially addressed his acknowledgment of it.

He begins by a warm recognition of their steadfastness in the faith and of their sympathy with him (i. 3-7), and, as he is certain that their steadfastness will continue, so he prays that their love may abound more and more in enlightened well-doing (i. 9-11). He proceeds to tell them about himself and about other preachers of the gospel at Rome: as for himself, he is full of hope because his imprisonment has tended to make the gospel known, and has emboldened others to "speak the word of God without fear"; as for other preachers (probably the Jewish Christians who denied his apostleship and disparaged his special teaching), though some of them preach insincerely and controversially, yet, whatever be their motive, "Christ is proclaimed," and therein he finds cause of rejoicing (i. 12-18). His position is critical, for he may be condemned to death; but, whether he lives or dies, Christ will be glorified through him, so that he cannot tell which he would prefer; for himself it would be far better "to depart and to be with Christ," but for the Philippians it is better that he should "abide in the flesh" (i. 19-24). Hence he feels confident that he will live, and that he will see the Philippians again; and hence also he exhorts them not to be discouraged by persecutions, and to be at unity among themselves (i. 25, ii. 2). The reason for this second exhortation is uncertain: it may be that the differences of race at Philippi, the mingling of Romans and Greeks, of Europeans and Asiatics, had led to the factious assertion by each race of its own superiority, or it may be, though less probably, that there is elsewhere the feud raged between Gentile and Jewish Christians. And, since faction comes of self-assertion, he urges as its antidote the cultivation of "lowliness of mind," which he enforces by the great example of Jesus Christ, who, so far from asserting the divinity which belonged to Him, emptied Himself of it and took the form of a bond-servant; to this St Paul adds a strong appeal on his own account, that his work among them may not seem to have been in vain (ii. 3-18). He then, with an expression of regret that some of his fellow-workers are no longer with him, announces that he hopes to send Timothy to them as soon as he knows the issue of his coming trial; and he is hopeful that he may be able to go himself; however that may be, he sends back their own messenger, Epaphroditus, who after coming to Rome had almost sacrificed his life in the energy of his work (ii. 19-30). Then follows an abrupt transition to another subject, which has sometimes been thought to mark the commencement of a new letter. He suddenly begins to warn the Philippians in strong terms against false teachers, either Judaizing Christians, or, more probably, Jews, who were preaching the necessity of circumcision. Holsten thinks that there is a reference to the murder of James the Just; he maintains that, although he was himself a "Hebrew of Hebrews," and therefore possessed whatever "confidence in the flesh" such a one might aim, yet he counted it all as "loss" in order that he might gain "the righteousness which is of God by faith"; and borrowing a metaphor from the Greek games he regards this as a prize which has to be won by a continuous effort (iii. 2-16). He urges the Philippians to follow in this struggle towards moral perfection, in contrast

either to the Christians who had lapsed into Epicureanism or, as some think, to the antinomian Jews (iii. 17, iv. 1). He then gives some personal messages to Euodia and Syntyche (whom Schwegler considers to be personifications of the Jewish and heathen Christian parties respectively), and to Synzygus (or, if the word be not a proper name, an anonymous "yoke-fellow" who has been variously supposed to be Paul's wife, Clement of Rome, St Peter, Lydia the purple-seller, or Epaphroditus), and mentions "Clement," about whom it has been much discussed, but to little purpose, whether he was a Philippian or a Roman, and, if the latter, whether he was the same person who figures in early legends as bishop of Rome, or whether, as Baur thinks, the name is really that of the Flavius Clemens who was condemned under Domitian for "atheism." The personal messages are followed by general exhortations to joyfulness, forbearance, trustfulness, and steadfastness in Christian virtue; and then comes that which was probably the special occasion of writing, an acknowledgment of the money which they had sent to him (iv. 4-20).

It is the more probable opinion that the epistle was written from Rome, and not from Cæsarea; whether it was written in the earlier or the later period of his stay there is a question which has been much discussed, but which the scantiness of the evidence respecting that stay does not allow of being satisfactorily answered; most writers (De Wette, Wieseler, Wiesinger, Meyer) place it in the later period, others (Bleek, Ewald, Beytschlag, Lightfoot) in the earlier; the latter view is more probable on account of the general agreement of this epistle with the epistle to the Romans. It throws an interesting light on St Paul's external relations. He was a prisoner, probably in charge of the prefect of the prætorian guard, and consequently with opportunities of making the gospel known among the soldiers; and the mention of Cæsar's household, though no doubt that term covered a large number of scattered individuals, makes it possible that he was lodged near the imperial palace on the Palatine.

The genuineness of the epistle was attacked by Baur on three grounds, which he himself states to be (1) the appearance of gnostic ideas in ii. 6-11, (2) the want of anything distinctively Pauline, (3) the questionableness of some of the historical data.<sup>1</sup> The attack has been renewed by one section of his followers; but it is generally admitted even by critics who reject the epistles to the Ephesians and Colossians<sup>2</sup> that the attack upon this epistle has failed. The supposed gnosticism of ii. 5-11 is not proved; the supposed identification of Clement (iv. 3) with Flavius Clemens, the cousin of Domitian, is merely an arbitrary guess; and the list of expressions which are not found in other epistles of St Paul is not greater than may reasonably be expected from the differences in the subject-matter.<sup>3</sup>

The doctrinal importance of the epistle is considerable, for it contains a passage which, if it could be certainly understood, would be at once the key and the summary of St Paul's Christology. In 2 Corinthians viii. 9 he had

<sup>1</sup> Paul, E. T., vol. ii. p. 45; *Theol. Jahrb.*, 1849, 501, which is partly reprinted as an addendum in Paul, E. T., vol. ii. p. 64.

<sup>2</sup> E.g., Hilgenfeld, *Einleitung*, p. 333; Renan, *St Paul*, p. 6; Pfleiderer, *Paulinismus*, E. T., vol. i. p. 29.

<sup>3</sup> Baur was followed in this attack by Schwegler (*Das nachapost. Zeitalter*, vol. ii. p. 135) and Volkmar (in the *Theol. Jahrb.*, 1856, p. 309); and he was answered by Länemann (*Pauli ad Philipp. Epist. . . . defendit*, Göttingen, 1847), Bruckner (*Epist. ad Philipp. . . vindicata*, Leipzig, 1848), Hilgenfeld (in the *Zeitschr. f. wissenschaftl. Theol.*, 1871, p. 309). A new attack was made by Hirsch in the same *Zeitschrift*, 1873, p. 59 (articled by Hilgenfeld, *ibid.*, p. 179), and by Holsten in the *Jahrb. f. prot. Theol.* (1875, p. 425; 1876, p. 58), which has been met by the important treatise of P. W. Schmidt, *Neutestamentliche Hyperkritik*, Berlin, 1880.

said of Christ that "though He was rich yet for your sakes He became poor"; in Philipians ii. 5-7 this<sup>1</sup> is expanded into the explicit declaration that "being in the form of God He counted it not a prize (φ) to be equal with God, but emptied Himself, taking the form of a servant, being made in the likeness of men." Each phrase of the passage is of great significance, but it is also of great uncertainty of meaning: the main points of uncertainty are (1) whether the subject of the sentence is the incarnate or the pre-incarnate Christ; (2) what is implied by the phrase "in the form of God," and what is its relation to the phrase "to be equal with God," some thinking that it implies an identity, others an inferiority of status; (3) what is meant by the word here rendered "prize" (*ἀπορραγμός*), some thinking that this is the right rendering, and that the meaning is "He did not tenaciously cling to His divinity but surrendered it," others thinking that it should be rendered "an act of robbery," and that the meaning is "He did not think it a usurpation to assert His divinity"; (4) what is meant by "emptied Himself," whether He only divested Himself of the outward semblance of divinity, or whether He reduced Himself to the bare consciousness of personality in becoming incarnate; this last question, that of the nature of the *kenosis*, has bearings of especial importance on the general doctrine of the Person of Christ.

Discussions of these questions from various points of view will be found not only in commentaries on the passage (*e.g.*, Lightfoot) and works on New Testament theology (*e.g.*, Weiss), but more particularly in Baur, *Paul*, E. T., vol. ii. p. 46 (who thinks that the conceptions are gnostic and un-Pauline); Ernesti, in *Studien u. Kritiken*, 1848, p. 889, and 1851, p. 602 (who thinks that *ἀπορραγμός* refers by way of contrast to the first Adam, who tried to seize what was not his own); Hilgenfeld, in the *Zeitschr. f. wissenschaftl. Theol.*, 1871, p. 192, and *ibid.*, 1873, p. 178; Grimm, *ibid.*, 1873, p. 33; Hirsch, *ibid.*, 1873, p. 59; E. Schmidt, *Paulinische Christologie*, 1870, p. 163 (whose explanation deserves especial consideration); Pfeiderer, *Paulinismus*, E. T., vol. i. p. 146; and more recently Weiffenbach, *Zur Auslegung der Stelle Phil. ii. 5-11*, Karlsruhe, 1884. For the question as to the nature of the *kenosis*, see Gess, *Die Lehre von der Person Christi*, Basel, 1856, pp. 81, 294.

The best modern editions of the epistle are those of B. Weiss, *Der Philippbrief ausgelegt*, Leipzig, 1859, and Lightfoot, *The Epistle to the Philipians*, 8d ed., London, 1873. (R. H. A.)

PHILIPPICUS, or PALAIPICUS, emperor of Constantinople from December 711 to June 713, was the son of the patrician Nicophorus, and became distinguished as a soldier under Justinian II. His proper name was Bardanes. Relying on the support of the Monothelete party, he made some pretensions to the throne on the outbreak of the first great rebellion against Justinian; these led to his relegation to Cephalaria by Tiberius Abaimarus, and subsequently to his banishment, by order of Justinian, to Cherson. Here Bardanes, taking the name of Philippicus, successfully incited the inhabitants to revolt against a prince who had made them the objects of one of his most vindictive expeditions, and on the assassination of Justinian in Asia Minor he at once assumed the purple. Among his first acts were the deposition of Cyrus, the orthodox patriarch of Constantinople, in favour of John, a member of his own sect, and the summoning of a "conciliabulum" of Eastern bishops which abolished the canons of the sixth general council, and restored to the diptychs the names of Sergius and Honorius. Meanwhile Terbelis, king of the Bulgarians, attacked Constantinople, burning some of its suburbs and carrying off many prisoners and much booty, while shortly afterwards the Saracens made similar inroads from the Asiatic side. The short reign of Philippicus was brought to a close through a conspiracy headed by two of his generals, who caused him to be blinded in the hippodrome in June 713. Of the remainder of his life nothing is known. He was succeeded by his secretary, Artemius, known as Anastasius II.

PHILIPPINE ISLANDS (Span. *Islas Filipinas*), or PHILIPPINES, an archipelago in the south-east of Asia, extending from 4° 40' to 20° N. lat., and from 116° 40' to 126° 30' E. long. On the west and north-west it is separated by the China Sea from China and the Indo-Chinese peninsula; towards the east lies the Pacific; on the north a number of smaller islands stretch out towards Formosa; and on the south, while a double connexion with Borneo is formed by the lines of the Palawan and Balabac and the Sulu Islands, the basin of the Celebes Sea, with a central depth of from 1000 to 2600 fathoms, extends, for a distance of 300 miles, between its southernmost island (Mindanao) and Celebes. As the number of the Philippines is believed to exceed 1400, and the larger islands are in several cases only beginning to be properly explored, it is impossible to give a definitive statement of their aggregate land-area. A measurement on Domann's map (1882) resulted in 114,356 square miles. Nor is it in regard to the area alone that our knowledge is defective. Though for three centuries the greater part of the territory has been nominally in Spanish possession, the interior of some of the larger islands has never been surveyed; several of the native tribes, especially in Mindanao, are altogether independent; the geology of Luzon, the best known of all the archipelago, is to a large extent matter of conjecture; and the visit of a passing botanist or naturalist is enough to add facts of primary importance to the register of flora and fauna. While none of the summits, with the exception perhaps of Apo<sup>1</sup> in Mindanao, exceeds 9000 feet—the loftiest probably being Halcon in Mindoro (8865 feet), Malindang in Mindanao (8685 feet), Mayon in Luzon (8275 feet), and Malaspina in Negros (8190 feet)—all the islands may be described in general as mountainous and hilly. The principal ranges have a tendency to run north and south, with a certain amount of deflexion east or west, as the case may be, so that the orographic diagram of the archipelago as a whole would have a certain similarity to a fan with northern Luzon as its centre of radiation. The geologist finds his task in the Philippines exceptionally difficult, owing to so much of the surface being covered with a dense vegetation, which often obliges him to be contented with no better indication than the pebbles of the alluvium. Nowhere, almost, are there cuttings or excavations to open up the records of the rocks. It seems certain, from the frequency not only of large tracts of coral reef along the coasts but of raised beaches at a considerable distance and elevation inland, containing shells similar to those of the adjacent seas, that much of the archipelago has been heaved from below the sea-level within comparatively recent times. As the neck of land between the Bay of Sogod and the Bay of Ragay or Guinayangan and that between this latter bay and the Bay of San Miguel consist of alluvium, tuffs, and marls, with modern shells, it appears probable that the southern parts of Luzon were at no very distant date separate islands. According to Draache, southern and central Luzon comprises (1) a group of chloritic slates and gneiss; (2) diabases and gabbros; (3) Eocene limestones; (4) volcanic minerals and tuffs; (5) recent formations with marine fossils—tuffs, limestones, clays, and marine and fluvial alluviums. In his travels through the more northern parts of the island the same geologist verified the existence of (1) diorite, gneiss, protogine and chloritic slates; (2) an extensive system of stratified conglomerates and sandstones; (3) modern volcanic rocks (quartzose trachyte, amphiboliferous and sanidine

<sup>1</sup> According to the Spanish hydrographic maps, the height of this mountain is 8818 feet; but the barometer of Rajal and Montano's expedition (which ascended to the top in 1880) indicated 10,370 feet, and that used by Schadenberg and Koch in 1882 no less than 10,822 (see *Bull. Soc. de Géogr.*, Paris, 1881, p. 546).





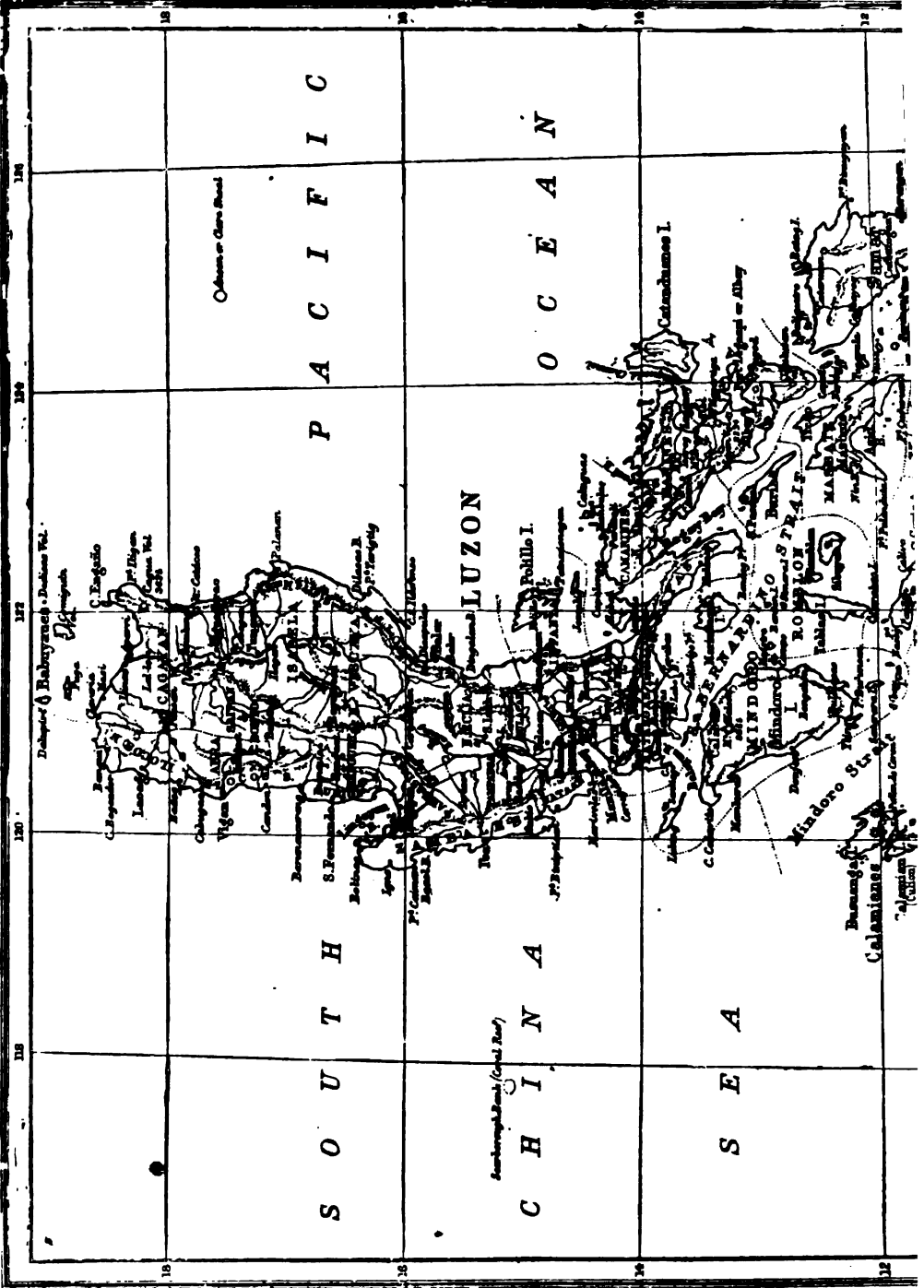

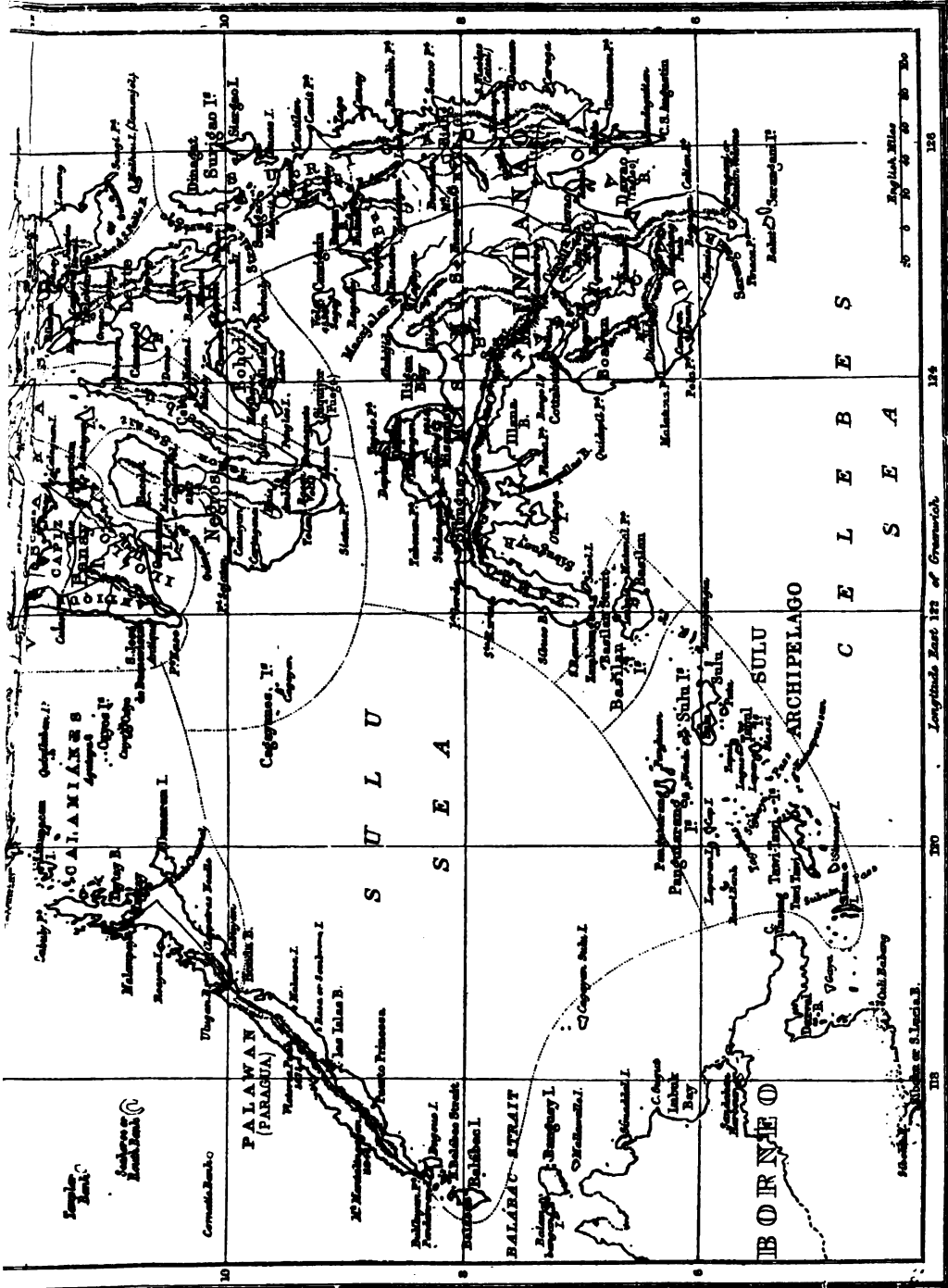

ENCYCLOPEDIA BRITANNICA, NINTH EDITION.

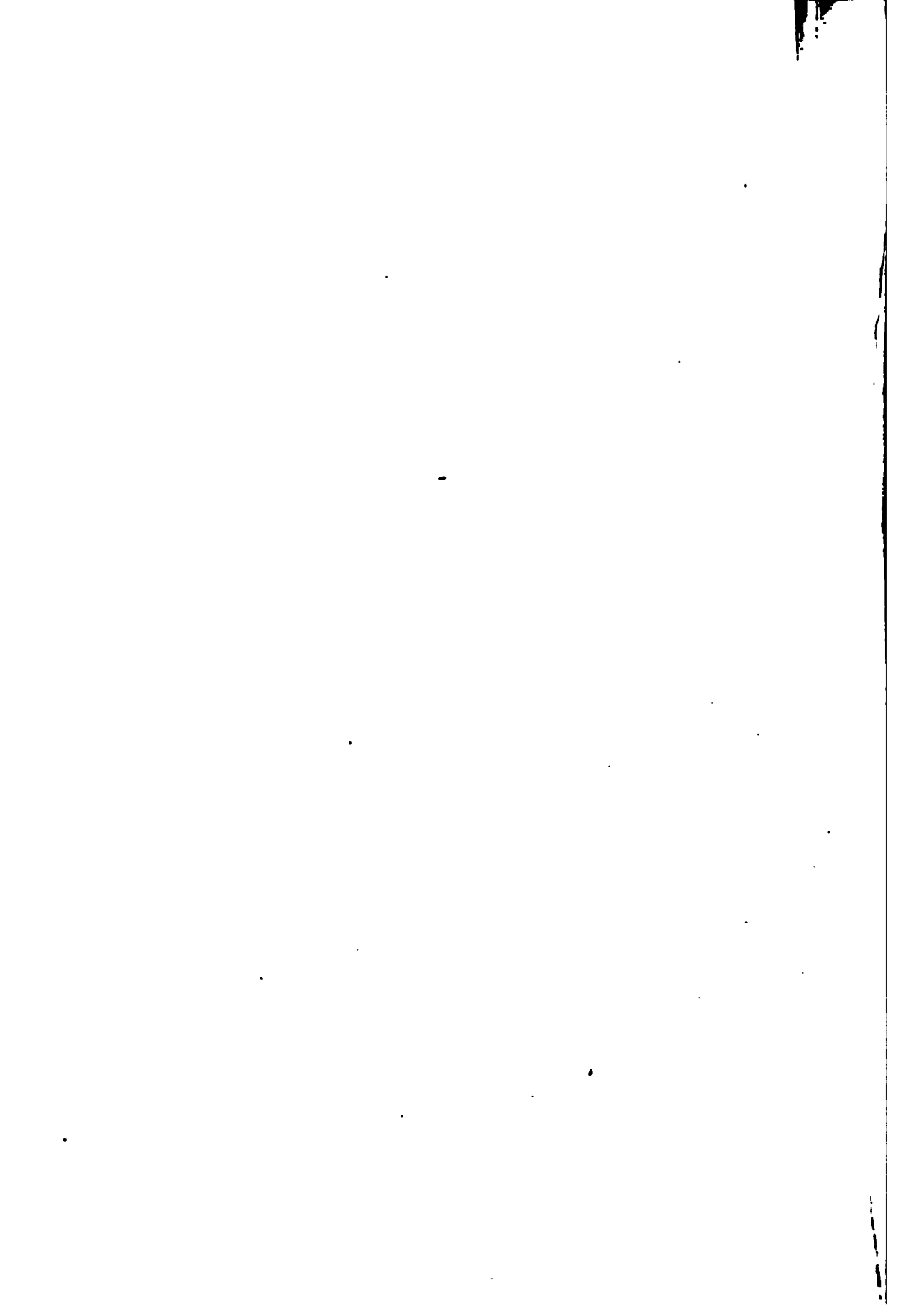

trachyte, amphiboliferous andesite and dolerite); (4) tuffs and tufaceous sandstones, with banks of limestone and marl; (5) banks of coral and breccia of coraliferous limestone, and recent volcanic products. The late origin of the coraliferous limestone is shown by the corals belonging to genera still existing in the Indian Ocean—*Galaxea*, *Favia*, *Meandrina*, *Porites*, and *Astracopora*—and being specifically similar, though not identical. A remarkable feature is the stratification of the limestone.

Volcanic forces, as has been already implied, have had a great share in shaping the archipelago, and a large number of the mountains bear the stamp of their former activity. But those that still have the credit of being working volcanoes are comparatively few.

Monte Cagua (8910 feet), discovered by Claudio Montero on the north-easterly promontory of Luzon, appears to discharge smoke continually, and the Babuyan group (to the north of Luzon) contains several offices belonging to the same centre of eruption,—a regular volcano in Babuyan Claro, a solfatara in the Didica rocks, and a volcanic island thrown up in 1856. Of greater importance are the three burning mountains of southern Luzon—Taal, Albay, and Bulusan. Taal lies 45 miles almost due south of Manila. Being only 850 feet high, it is remarkable as one of the lowest volcanoes in the world. The present craters are situated in a small triangular island in the middle of Lake Bombon or Bongbong. A tradition exists (and has been accepted without question by many writers) that this lake, covering an area of 100 square miles, and having in the south and east a depth of 109 fathoms, was formed in 1700 on occasion of a terrible eruption, which undermined the whole mass of a gigantic mountain, 8000 or 9000 feet high; and, whether (for this is extremely doubtful) the event took place within historic times or not, the vast deposits of porous tuff in all the surrounding country appear to show that such a volcano must have existed. The water in the lake is now sweet, but tradition again asserts that it was at one time salt, possibly through direct communication with the sea. As it is exposed to strong evaporation and discharges into the sea by the Panapit without being recruited by any considerable affluent, it is probably fed by subterranean sources. To the east of Lake Bombon stands the extinct volcano of Maquiling, at whose foot are the hot springs of Los Baños; and about 15 miles farther east is Majajai (7020 feet), of which the last eruption was in 1730. Away in the south-east of Luzon there is quite a series of high volcanic cones,—Isarog, Iriga, Mazaraga, and Albay or Mayon. The last, one of the most active volcanoes in the archipelago, is extremely regular in form, rising gradually from a base about 50 miles in circuit. The first partial ascent was made by Esteban Solis in 1592, and the first complete ascent by Paton and Stewart, two young Scotchmen, in 1858. A terrible eruption on 1st February 1814 partially destroyed Camalig, Budiao, Albay, Guinobatan, and Daraga, and proved fatal to 12,000 persons, the matter thrown out forming vast deposits deep enough in some places near the mountain to bury the loftiest trees. A similar fate befell the same district during the eruptions that occurred between 20th July and 24th October 1867. On 31st October 1876 one of the terrible storms for which the Philippines are notorious burst on the mountain; the floods, pouring down the sides of Mayon and sweeping along with them the loose volcanic débris, brought destruction on Manilao, Camalig, Guinobatan, Ligao, Osa, Polangin, Libon, and other places, filling up the roads, breaking down the bridges, and completely ruining upwards of 6000 houses. During 1881 and 1882 the eruptive forces were again exceedingly active. Still farther to the south, in the very extremity of Luzon, stands the volcano of Bulusan, which, after being for a long time apparently extinct, began again to smoke in 1852. According to Jagor (*Reisen*, p. 66), it repeats in striking fashion the forms of Vesuvius, having two peaks,—in the west a bell-shaped dome, the eruption cone, and in the east a high ridge similar to Monte Somma, probably the remains of a great circular crater. As in Vesuvius, the present crater is in the centre of the extinct one. In the island of Negros, 150 miles south-south-west of Bulusan, there is the volcano of Malaspina or Canlaon (8190 feet); the island of Fuego probably takes its name from its volcanic phenomenon; and about 90 miles farther to the south-east a new volcano burst out in 1876 in the island of Camiguin (not to be confounded, as it sometimes is, with Camiguin off the north coast of Luzon), near the village of Catarman. In the great island of Mindanao we have the three volcanoes of Macaturing<sup>1</sup> (Sugut, Polloc, or Cottabató), inland from Illana Bay, and Apo and Sangul (Sarangani or Butulan), both in the central cordilleras and the latter almost at its southern terminus. Though the last great eruption of Cottabató was in 1856, it is still active at intervals, and in 1871 the town of the same name was

partially destroyed by earthquakes. Apo, according to Schenberg and Koch, has three summits, in the midst of which lies the great crater, now extinct and filled with water. Considerable energy is still displayed by the solfataras and boiling springs lower down.

It is difficult to say how these various volcanoes are related to each other; José Centeno suggests with considerable probability that they form two lines of activity, an eastern comprising Isarog, Albay, Bulusan, Camiguin, Apo, and Butulan, and a western Buguias (extinct), Arayat (extinct), Taal, Canlaon, Macaturing. Three only of the larger islands, it will be observed, contain actual centres of eruption, and some of the larger volcanoes appear to be in the later stages of their activity,—Albay generally discharging an incoherent form of lava, whilst Taal and others discharge nothing but ashes. Other phenomena usually associated with volcanic activity are common enough throughout the archipelago: there is a great deposit of sulphur in the middle of the island of Leyte; inflammable gas bursts out in the south of Panay; and there are hot springs at Buguias, at Los Baños or Maynit, already mentioned, at Pagsaingan, at San Luis or Maynit in Batangas, in the Taysan Mountains, at Tibi or Tivi, &c. At Los Baños there was a regular bathing establishment erected by the Franciscans in 1671; but it was burned down in 1727, and, though rebuilt by public subscription in 1880, may be said to be in a chronic state of decay. The Tibi springs, described in detail by Jagor (*Reisen*, pp. 114, 115), are remarkable for beautiful cones produced by the deposit of siliceous material. The water in some cases is hot enough to cook food. They are situated on the east coast of Luzon on Lagonoy Bay.

**Earthquakes.**—Earthquakes are sufficiently frequent and violent in the Philippines to affect the style adopted in the erection of buildings; in 1874, for instance, they were very numerous throughout the archipelago, and in Manila and the adjacent provinces shocks were felt daily for several weeks. The most violent earthquakes on record in the Philippines occurred in July 1880, when the destruction of property was immense, both in the capital and in other important towns of central Luzon.

**Minerals.**—Though hitherto little advantage has been taken of its existence, there appears to be in several of the islands a fair amount of mineral wealth. Two coal-fields are known to exist, one beginning in Caransan in the south of Luzon, and probably extending southwards across the Strait of San Bernardino to Catbalogan in Samar, and another occupying the western slopes of Cebu and the eastern slopes of Negros, and thus probably passing under the Strait of Tañon. In the first basin there is a bed from 10 to 20 feet thick cropping out at Gatbo, which has given good results as a fuel for steamboats; in the second Centeno reports at least five beds of varying thickness and quality. The first discovery of the mineral was made in Cebu in 1827. Hitherto little success has attended the schemes of exploitation. Iron-ore of excellent purity occurs in various parts of Luzon, in Laguna, Bulacan, Pampanga, Camarines Norte, and notably in the Camachin Mountains between the Bulacan and the Garlan; but, with the exception of a few small foundries in Bulacan province, there are no iron-works in the country. In this department there was actually more activity a century ago. Copper-mines are worked at Mancayan, Suyuc, Buncunc, and Agbao in the province of Lepanto, by the Cantabro-Philippine Company, founded in 1862; and the heathen natives of that region (perhaps having learned the art from Chinese or Japanese strangers) appear to have long been accustomed to manufacture copper utensils for their own use and for sale in the Christian settlements. The ore at Mancayan contains upwards of 16 per cent. of copper, 24 of sulphur, 5 of antimony, and 5 of arsenic. For a short time after 1847 copper-mines were worked

<sup>1</sup> It was supposed till quite recently that there were two mountains in this district,—one being Macaturing, the other Sugut, Polloc, or Cottabató.

at Assit in the inland of Masbate; and it is known that copper ores exist in the provinces of Tayabas and Camarines Sur (Luzon), Antique (Panay), and the island of Capul. Gold is very generally distributed throughout the archipelago, but mostly in insignificant quantities. From the deposits in Camarines Norte (in Paracala, Mambulao, Labo), where it occurs in placers and in quartz and other rocks, about 30 oz. per month are obtained. Much more important are the gold-washings of Misamis and Surigao in Mindanao, the former of which yield about 150 oz. per month. Neither the mercury nor lead veins discovered at different times have proved of economic value.<sup>1</sup>

*Climate.*—As the north part of Luzon is as far from the south of the Sulu Islands as the north of England from the south of Italy, and as the archipelago is divided by the line of the ecliptic, the climate of one region differs considerably from that of another, though the general characteristics are everywhere tropical. The northern islands lie in the region of the typhoons. Three seasons are usually recognized,—a cold, a hot, and a wet. The first extends from November to February or March; the winds are northerly, and, though there is no need for fire, woollen garments can be worn with comfort in the mornings; the sky is for the most part clear and the atmosphere bracing; and Europeans look forward to this period as the most enjoyable of the year. The hot season lasts from March to June, and the heat becomes very oppressive before the beginning of the southerly monsoon. Thunderstorms, often of terrific violence, are of frequent occurrence in May and June. The wet season is usually ushered in by the heavy rains locally known as “collas.” During July, August, September, and October the rain comes down in torrents and large tracts of the lower country are flooded. According to the observations of the Jesuits at Manila during the eight years 1870 to 1877 the total rainfall (distributed over 113 days) amounted to 66.6 inches.

		Cold.	Hot.	Wet.
Manila	Mean temperature.....	72° 32	87° 26	84° 56
	Rainfall .....inches	8 95	10 47	36 01
Cebu	Mean temperature.....	75° 02	86° 23	75° 86
	Rainfall .....inches	12 84	9 29	26 90
Davao	Mean temperature.....	86° 90	88° 70	87° 11
	Rainfall .....inches	16 53	39 27	32 15
Sulu	Mean temperature.....	81° 98	82° 97	83° 03
	Rainfall .....inches	15 74	33 85	35 43

*Fauna.*—The mammals of the Philippines are strikingly few, especially when contrasted with those of such an island as Java; but their number may yet be slightly increased, and nine-tenths of them are peculiar species. Since *Cynopithecus niger* was struck out of the list, the only monkey known to science is *Macacus cynomolgus* (chongo of the Tagals), found in all the islands; but there are also pure white monkeys (not albinos) in Mindanao, and specimens are occasionally sold at Manila. The lemuroids are represented by the strange little *Tarsius spectrum*, the insectivora proper by *Galeopithecus philippensis* and a “tupaia,” or squirrel-shrew. Of carnivora there are three species, two civets and a wild cat, as well as the ordinary domestic animal. The rodents comprise only a few squirrels, *Sciurus philippensis*, &c., a porcupine, and two or three rats. Of bats there are between twenty and thirty species. The wild boar is regularly hunted in all the islands; the natives throughout the archipelago keep large numbers of black

pigs; and the Babuyanes group take their name from *babuy*, “a pig.” Of deer there are three species, *Cervus marianus*, *C. philippensis*, and *C. Alfredi*; and a chevrotain or mouse-deer (*Tragulus*) is found, more especially in Bataan. Tapa, or sun-dried deer’s flesh, is a favourite food with the natives. The statement that the horse has become wild in the interior of several islands is founded on a mistake. The ordinary domestic variety, probably of Spanish, Chinese, and Japanese origin, is “generally small, but well-shaped and hardy, the largest and best breeds coming from Batangas, Albay, and Camarines, the smallest and probably the hardest from Ilocos” (D. M. Forbes). For all kinds of field work the buffalo (“carabao”) is employed; ordinary cattle and goats are common enough, and some of the former are of great excellence. As there is a Tagalog name for it, it has been supposed that the elephant was at one time to be met with in the Philippines; and in the Sulu Islands, at least, it is said to have existed in the 17th century.

The birds of the Philippines proper show the isolated character of the group by the absence of a large number of ordinary Malayan forms, and at the same time there is a considerable proportion of genera from Australia, India, and China. Viscount Walden (*Trans. Zool. Soc.*, vol. ix., 1877) found the known species numbered 219, and R. B. Sharpe, by the assistance of Professor Steers’s collections, brought the total up to 287 species, of which 151 were peculiar to the Philippines. To these must be added several species hitherto only found in the Sulu Islands. Palawan has a strong Bornean element. It is enough here to mention a number of peculiar woodpeckers, beautiful little parakeets (*Loriculus*), a number of pigeons (including at least one peculiar genus, *Phapitreron*), cockatoos, mound-builders, and a peculiar hornbill, *Penelopides*, known from its note as “calao” to the natives, who frequently tame it. The principal game bird is the jungle-fowl (*Gallus bankiva*).<sup>2</sup>

Alligators abound in some of the lakes and rivers; and turtles, tortoises, and various kinds of lizards are familiar enough forms; one of the last, the “chacón,” is believed by the natives to be a defence against earthquakes. The beauty and variety of the butterflies and the destructiveness of the termites are obtrusive features of the insect life; the land-shells are peculiar, numerous, and remarkable for delicacy of form and colour. Some of the molluscs attain gigantic dimensions; the “taclobo” shell sometimes weighs 200 lb, and is used for baptismal fonts. One of the most valuable kinds of fish is the “dalag” (*Ophiocephalus vagns*), and one of the most peculiar the *Hemiramphus viripara*.

*Flora.*—The flora of the Philippines is essentially Malayan, intermixed with a Chinese element, but with sufficient individuality to constitute a sub-region. According to Llanos’s edition of Manuel Blanco’s *Flora de Filipinas*,<sup>3</sup> 4479 species are known belonging to 1223 genera and 155 orders. Among the dicotyledons the orders most abundantly represented are: *Leguminosae* (77 genera), *Rubiaceae* and *Compositae* (each 41), *Euphorbiaceae* (32), *Urticaceae* (25), *Acanthaceae* (28), *Apocynaceae* (22), *Asclepiadaceae* (20), *Sapindaceae* (20); and among the monocotyledons *Orchidaceae* (80), *Palmæ* (28), *Araceae* (27), *Graminaceae* (72). Of ferns there are 60 genera. The forests contain more than 200 kinds of wood thought worthy of trial in the arsenal at Manila. Among them may be mentioned the teak-like molave (*Vitex altissima* and *geniculata*); the dongos (*Sterculia cymbiformis*); the ipel (*Eperua decandra*), greatly prized for its hardness; the luman or lawaan (*Dipterocarpus thurifer*), a light stringy wood, often used by the Malays for their canoes; and the bolongaeta (*Diocypnos pilocantha*), employed for fine kinds of furniture.

<sup>1</sup> The best resumé of geological facts in regard to the Philippines is J. Roth, “Ueber die geologische Beschaffenheit der Philippinen,” published as an appendix to Jagor’s *Reisen*, but, like the other appendices, left out in the untrustworthy English translation. Drasche gives a good deal of fresh material in *Fragmente zu einer Geologie der Insel Luzon*, reproduced in *Boletín de la Comisión del Mapa Geológico de España*, vol. viii., 1881. Ferrey has collected information about the Philippine earthquakes in *Mém. de l’Acad. de Dijon*, 1860, &c.

<sup>2</sup> See Wallace, *Geogr. Distr. of Animals, and Island Life*.  
<sup>3</sup> First ed., Manila, 1837; second ed., 1845; Llanos’s ed., 4 vols. 1877-80 (summary in vol. II.).



**Products.**—Mangoes, plantains, mangosteen, jack-fruit, medlars, and in general most of the Malayan fruits are to be met with; the lanson occurs in the north, and the durian in the south, more especially in the Sulu Islands. Rice is the staple food of the natives, but, though it is extensively cultivated, the supply is not always equal to the demand. Sweet potatoes (camote), a kind of yam (palawan), the ground-nut, and gourds are pretty generally grown, as well as occasionally peas, potatoes, and in the higher regions even wheat. The plants which are of primary commercial importance are tobacco, Manila-hemp, sugar-cane, coffee, and cocoa.

Tobacco was made a Government monopoly by Captain General José Basco y Vargas in 1781, and remained so till 1st July 1882. Though it was free to any one to grow the plant to any extent he pleased, the Government was the only purchaser, fixed its own price, and, paying its debts according to its own convenience, was sometimes three or four years in arrear. Besides, certain districts were bound to furnish a certain quantity of the leaf, and the peasant was thus often forced under severe penalties to devote himself to the tobacco crop when he would have obtained better results from something else. The best tobacco comes from the provinces of Isabela and Cagayan, and it is there that the cultivation is most systematically carried on; but the plant is also grown in other provinces of Luzon (Union, Iloocos, Lepanto, &c.) as well as in the Visayas Islands. The average production in the ten years 1872-81 was 214,400 quintals (each 101.43 English lb), of which 114,400 were from Isabela and Cagayan. About 25,000 quintals were sent to Spain as tribute, and another portion was sold by public auction for foreign export. For tobacco of the first class from Cagayan and Isabela the Government paid in recent years between 13 and 14 dollars per quintal, for the second class between 10 and 11, for the third between 7 and 8, and for the fourth between 6 and 7. About 280 million cigars were manufactured annually in six factories employing 20,000 hands, 95 millions for foreign export and the rest for home consumption. Of the foreign cigars 50 millions went to Singapore, Java, the Moluccas, and India, 30 millions to China and Japan, 4 millions to Australia, and 11 millions to Europe. Hitherto tobacco-planting has been carried on (with few exceptions) only by people of small means; but since the abolition of the monopoly several companies have been started, and the whole condition of the industry will probably soon be greatly modified. Abaca or MANILA-HEMP (*g.z.*) is best grown in the south-east of Luzon, in Samar, Leyte, and Bohol. Its cultivation requires little trouble, and the plantations, usually small, are each the property of a native family. Hand-labour and a few simple machines of native construction are all that is required in the preparation of the fibre. The abaca districts are generally very poor. Coffee was introduced, probably from Brazil, in the latter part of the 18th century, but the first plantation on a large scale was formed only in 1826. The cultivation is now pretty extensive. Philippine coffee appears in the European markets as Manila or Zamboanga coffee. The former, which comes from Batangas, Cavite, and Laguna to the amount of 70,000 piculs (a Spanish picul = 140 lb) per annum, is a small but well-flavoured berry; the latter, principally grown in Mindanao and Sulu, which send a good deal of their produce direct to Singapore, is in less repute, because, while the berry is larger, less care is bestowed on the gathering and sorting. France was at one time the only great purchaser of Philippine coffee, but about two-thirds of the crop now finds its way to Spain, England, the Netherlands, and Austria. In general far too little care is given to the plantations. Sugar is extensively cultivated, and the export has increased from 1,899,434 piculs in 1871 to 3,882,664 in 1881. About a third of the whole is produced by Pampanga; and Cavite, Laguna, Pangasinan, Bulacan, and Batangas also contribute. About 1,200,000 piculs are exported from Iloilo, which collects from Panay and Negros, &c. The finest is probably that from Capiz in Panay, where, as in this southern district generally, the violet-coloured cane is grown. Most of the larger plantations (some exceeding 1000 acres) are mechanic property, and are leased out to Chinese half-breeds, who are said to succeed better than Europeans. The smaller are cultivated by the proprietors with the assistance of their families and relatives, and less frequently of bond or hired labourers. A tendency has shown itself since 1870 to create larger estates, and to import better machinery; but it will be some time before the Philippine sugar-crop is generally treated according to scientific methods. The finest Manila quality is sent to Spain, and the secondary qualities to England; for the Iloilo sugars the United States are the principal destination.

**Trade.**—Before the conquest there was considerable commercial intercourse between the Philippines and China and Japan, but this, which would naturally have developed enormously if the Spanish trade between Manila and America (Navidad and Acapulco) had been left free, was interrupted, and at times almost completely stopped, by a series of absurd restrictions, devised in the supposed interest of the trade between Spain and America. For a long period only a single galleon, under Government supervision, was allowed to proceed yearly from Manila to Acapulco, the value of the cargo each way being bound not to exceed a certain sum. Direct trade

with Europe *via* the Cape was commenced in 1764; but, as if the exclusion of all except Spanish ships was not sufficient, a practical monopoly of this field of enterprise was in 1785 bestowed on the Royal Company of the Philippines. With the close of the 18th century a certain amount of liberty began to be conceded to foreign vessels; the first English commercial house was established at Manila in 1809; and in 1834 the monopoly of the Royal Company expired. Manila remained the only port for foreign trade till 1842, when Cebu was also opened; Zamboanga (Mindanao), Iloilo (Panay), Sual (Luzon), Legaspi or Albay (Luzon), and Tacloban (Leyte) are now in the same category, but only Manila, Iloilo, and Cebu have proved of real importance, as they are the only ports where foreign-bound vessels have hitherto loaded. The following table shows how rapidly the trade of the country has recently developed.

	Entered.		Cleared.		Spanish.		British.	
	Vessels.	Tons.	Vessels.	Tons.	Vessels.	Tons.	Vessels.	Tons.
1875	841	225,418	815	222,618	293	87,506	545	138,068
1876	811	216,735	811	224,449	284	86,001	541	138,681
1877	856	251,417	851	249,649	298	104,846	556	147,565
1878	445	308,430	445	306,168	369	178,491	314	224,848
1879	458	317,069	478	325,096	396	231,432	318	212,695
1880	548	449,987	534	459,145	454	291,512	338	201,906

The American trade increased in this period from 101 vessels (129,439 tons) to 164 (202,658). The value of the imports rose from \$11,987,162 to \$25,493,819 and of the exports from \$14,837,796 to \$23,450,285. In 1883 333 vessels (270,000 tons) entered at Manila alone, the Spanish numbering 110 (93,000 tons) and the British 132 (93,000 tons); the exports in the same year were valued at \$29,996,000.

The manufactures of the Philippines consist of a variety of textile fabrics (pita fibres, silk, cotton), some of great excellence and beauty, hats, mats, baskets, ropes, furniture, coarse pottery, carriages, and musical instruments.

**Islands and Provinces.**—The *Batanes* and *Babuyanes*, the most northerly of the Philippines, have an area of only 280 square miles, with 8700 inhabitants, who pay no tribute. The rearing of horses is the principal occupation. The chief settlement is San José de Ibana in the island of Batan. Camiguin, the southernmost of the Babuyanes, is about 39 miles from the coast of Luzon.

**Luzon or Luzon**, with an area of 40,885 square miles, is the largest island in the whole archipelago, and as the seat of the Government at Manila it is the most important. The northern trunk, so to speak, extends north and south for 340 miles. From the mountains known as Carabalos de Balar or Nueva Ecija two ranges bifurcate and stretch northward—the Sierra Oriental, skirting the eastern coast till it ends at Cape Engaño, and the Sierra Occidental, keeping all the way at a distance of 25 or 30 miles from the western. Between these ranges lies the basin of the Rio Grande de Cagayan, which with its numerous affluents (Bangag, Nayon, Mayat, Pongul, Ibulac, &c., from the east; Calao, Cabagan, Pinacananauang, and Tulay from the west) forms the largest river-system in the whole archipelago. On the western slopes of the Sierra Occidental rise two other large rivers—the Abra, which reaches the sea at Vigan or Villa Ferdinandia, and the Agno, which after a winding course falls into the Gulf of Lingayan. To the south-west of the mountains extends a comparatively flat region, which continues southwards to the Bay of Manila and forms one of the richest agricultural districts in the island. It is watered by the lower part of the Agno and its lower tributaries, and the Rio Grande de Pampanga with its affluents, which ultimately discharge into Manila Bay, and thus forms a convenient water-way for conveying produce to the capital. There are also in these lowlands a number of extensive lagoons, such as that of Candava. To the west of the flat region the country rises into the considerable Cordillera de Zambales, which contains a number of peaks 5000 or 6000 feet high, and terminates northwards in a great peninsula forming the Gulf of Lingayan and southwards in a similar promontory (Sierra de Mariweles) which helps to form the Bay of Manila. To the east and south of this bay the general configuration is again hilly and even mountainous; but the large area of 850 square miles is occupied by the Laguna de Bay, connected with Manila by the Pasig, on which small steamers ply. The depth of this basin, though the southern side is bordered by a semicircular range of extinct volcanoes 6000 or 7000 feet high, seldom exceeds 4 fathoms. Two long capes project from the northern side, the western one being continued by the island of Talim. From the south-east corner of the trunk of Luzon there extends for 180 miles a very irregular peninsula formed by a series of cordilleras running in a north-westerly and south-easterly direction. The following are the provinces and districts into which Luzon is divided, with their chief towns: *Manila* (258,274 inhabitants<sup>1</sup> in 1877), *Manila*; *Bulacanes* (252,149), *Bulacan*; *Pampanga* (226,809), *Bacolor*; *Principes* (4158),

<sup>1</sup> The figures of the censuses may be trusted for the provinces of Luzon, &c., but often give no idea of the actual native population of the remoter districts.

Baler; *Bataan* (49,999), *Balanga*; *Zambala* (94,551), *Iba*; *Pan-gasinan* (293,291), *Lingayen*; *Union* (113,370), *S. Fernando*; *Iloco Sur* (201,049), *Vigan*; *Iloco Norte* (156,715), *Laocag*; *Abra* (42,647), *Bangued*; *Cagayan* (72,697), *Tuguegarao*; *Isabela* (38,516), *Tumauini*; *Nueva Vizcaya* (16,107), *Bayombong*; *Nueva Ecija* (123,771), *San Isidro*; *Laguna* (182,504), *Santa Cruz*; *Cavite* (182,064), *Cavite*; *Batangas* (275,075), *Batangas*; *Tayabas* (53,668), *Tayabas*; *Camarines Norte* (30,861), *Daet*; *Camarines Sur* (156,400), *Nueva Caceres*; *Albay* (257,583), *Albay*.

To the south-east of Luzon lie the *Visayas*—*Samar*, *Leyte*, *Bohol*, *Cebu*, *Negros*, and *Panay*, with various smaller islands.

*Samar* (area, 4367 square miles) is separated from the *Albay* peninsula by the Strait of San Bernardino, 10 miles across. From north-west to south-east it is 120 miles long; its greatest breadth is 60 miles. The provincial capital is *Catbalangan* on the west coast, on a bay difficult of access. The island is watered by a number of considerable streams—the *Catubig*, *Loquillooc* or *Ulut*, *Suribao*, &c. At *Nipa-Nipa* on the south-west coast there is a remarkable series of rock-caves in which the people were wont to deposit their dead in coffins.<sup>1</sup> The narrow but extremely beautiful Strait of *S. Juanico* separates *Samar* from the island of *Leyte*. The lesser islands of *Buat*, *Parasan*, &c., are included in the province of *Samar* (178,890 inhabitants). *Leyte* (2716 square miles) is 100 miles long and 30 miles wide. The chief town and port, *Tacloban*, lies at the eastern entrance of the Strait of *S. Juanico*. Sulphur for the Manila powder-factory is obtained from the solfataras at *Monte Manacagan*. According to *Jagor*, the east coast is rising and the west is suffering from the encroachments of the sea at *Ormos* to the extent of fifty yards in six years. South-west of *Leyte* is *Bohol* (area, 1496 square miles); the chief town is *Tagbilaran*, at the south-west corner. The province (226,546 inhabitants) comprises *Siquijor* and other islands. The important island of *Cebu* (2418 square miles; provincial population, 408,405) is 135 miles long from north to south, but only 30 miles broad at the west. The chief town, *Cebu*, is the capital of the *Visayas* group and is next to *Iloilo* in the matter of commerce. It is only along the coast that cultivation is easy, and none of the villages lie far inland. Parallel with *Cebu* and separated from it by a strait 15 miles wide, is *Negros* (4570 square miles; population, 204,669), with large sugar plantations, but only one large town, *Jimamaylan*, and no good ports. *Bacolod* is the administrative centre. North-west of *Negros* lies *Panay* (4633 square miles), which is divided into the three provinces of *Antique* (124,103), *Iloilo* (410,430), and *Capiz* (243,244), in accordance with its physical conformation. *Iloilo* is the chief town and the seat of the see of *Jaro*. Off the south-east coast of *Panay* lies the island of *Guimaras* (215 square miles).

In a line with the peninsula of *Tayabas* (*Luzon*) and the island of *Leyte* is *Burias* (190 square miles), which forms a province by itself (128 inhabitants), and *Mabute* (1211 square miles) and *Ticao* (121 square miles), which, comparatively sterile and thinly peopled (17,170), are united together. West of these islands is a considerable cluster, *I. de Tablas* (327 square miles), *Sibuyan* (159 square miles), *Bombon*, &c., constituting the province of *Romblon* (28,154). *Mindoro* (8984 square miles), one of the largest of the Philippines, lies only 10 miles south of *Luzon*, but its interior, peopled by about 30,000 *Mangianes*, a race of doubtful affinity, is practically unexplored, and its eighteen "Spanish" villages are scattered along the coast at great distances from each other and with no proper means of communication. The principal settlement is *Calapan*, on the north-east coast. *Marinduque* (848 square miles), included in the province of *Mindoro* (58,128), is a flourishing island with 48,000 inhabitants exporting various staples. South-west of *Mindoro* are the *Calamianes* (17,041 inhabitants), a great cluster of very small islands, the two largest being *Busuanga* (416 square miles) and *Calamian*; and beyond these extends for 230 miles in a south-westerly direction the island *Palawan* or *Paragu* (4576 square miles), which nowhere exceeds a width of 30 miles and sometimes narrows to 10. It is little visited, and apart from *Puerto Princesa*, the chief town (878 inhabitants), there are few Spanish posts. The *Sulu* or *Jold Archipelago*<sup>2</sup> (948 square miles; about 100,000 inhabitants), annexed by Spain in 1878, consists of about 150 islands divided into the *Balangui*, *Sulu*, *Tapul*, *Kecaputusan*, *Tawi-Tawi*, *Tagbaba*, and *Pangutarang* groups. Many of the smaller islands are uninhabited, but the larger are occupied by an industrious Mohammedan population. They formerly constituted, along with a portion of northern Borneo, an independent state with an hereditary sultan and a regular nobility of great political influence. The highest hill in the principal island, *Buat Timantangia*, or *Hill of Tears*, is so called because it is the last point visible to the natives as they sail away from their native land. *Sulu*, the present capital, lies on the north coast of the island of *Sulu*.<sup>3</sup>

The whole chain of the *Sulus* is practically a continuation of the south-western promontory of *Mindanao* or *Maguindanao* 37,256 square miles, the second largest island of the archipelago, containing the Spanish provinces of *Surigao* (56,246), *Misamis* (88,376), *Zamboanga* (14,144), *Davao* (1695), *Cotabato* (1282). Since about 1876 much light has been thrown on this interesting island<sup>4</sup> by the Jesuit missionaries. It is remarkably mountainous, and appears to be divided by the *Rangaya* or *Sugut* Cordillera, which runs north-west and south-east, and is continued throughout the great western peninsula of *Zamboanga*, and, at the other extremity, bends south to form the peninsula of *Butuan*. Between the *Rangaya* range and that of the *Tiruray* lies the valley of the *Rio Grande*, a river navigable as far as *Matingcahun* (70 or 80 miles) and connected with two great lakes, *Linganasan* and *Buluan*, which during the rainy season merge, or nearly merge, into one. On the north side of the *Rangaya* range and connected with the sea by the river *Iligan* is the great crater-lake of *Lanao*, which with its little group of secondary crater-lakes probably gave rise to the name of the island, *Maguindanao*, "Land of Lakes." Towards the east and sloping northwards extend the valleys of the *Cagayan*, the *Togoloan*, and the *Agusan*. This last is the largest river in the whole island. Rising in the *Kinabuan* Mountains in the south-east, it pursues a very sinuous course for more than 300 miles and falls into *Butuan* Bay; in the lower regions it is navigable for craft of considerable burden. *Mindanao* is throughout well peopled, much of it being occupied by independent Mohammedan sultanates.

*Administration*, &c.—The Philippines are subject to a governor-general with supreme powers, assisted by (1) a "junta of authorities" instituted in 1850, and consisting of the archbishop, the commander of the forces, the admiral, the president of the supreme court, &c.; (2) a central junta of agriculture, industry, and commerce (dating from 1866); and (3) a council of administration. In the provinces and districts the chief power is in the hands of alcaldes mayores and civico-military governors. The chief magistrats of a commune is known as the *gobernadorcillo* or *capitan*; the native who is responsible for the collection of the tribute of a certain group of families is the *cabeza de barangay*. Every Indian between the ages of 16 and 60 subject to Spain has to pay tribute to the amount of \$1.17—descendants of the first Christians of *Cebu*, new converts, *gobernadorcillos*, &c., being exempted. Chinese are subject to special taxes; and by a law of 1833 Europeans and Spanish half-castes are required to pay a poll-tax of \$3.50.

Ecclesiastically the Philippines comprise the archbishopric of *Manila* and the suffragan bishoprics of *Nueva-Caceres*, *Nueva-Segovia*, *Cebu*, and *Santa Isabel de Jaro*, which were all constituted by the bull of *Clement VIII.*, 14th August 1595, with the exception of the last, whose separation from *Cebu* dates only from the bull of *Pius IX.*, 27th May 1865. The *Agustinos* *Calzados* were established in the Philippines in the year 1565, the first prelate being *Andres Urdaneta*, and they have convents in *Manila*, *Cebu*, and *Guadalupe*. The *Franciscans* date from 1577, and have convents at *Manila* and *San Francisco del Monte*; the *Dominicans* (1587) at *Manila* and *San Juan del Monte*; the *Recollects* or *Strict Franciscans* (1606) at *Manila*, *Cavite*, and *Cebu*. The *Jesuits*, restored in 1862, maintain the missions of *Mindanao* and *Sulu*; and they have charge in *Manila* of the municipal atheneum, the normal school for primary teachers, and an excellent meteorological observatory. There are also sisters of charity, and nuns of the royal monastery of *San Clara*, founded in 1621.

*Education*.—A good deal has been done for the diffusion of primary education among the natives (every pueblo is bound to have a school), but the standard is not a high one. The press is under strict civil and ecclesiastical control, and all discussion of Spanish or general European politics is forbidden. Several daily papers, however, are published at *Manila*, *El Diario de Manila* dating from 1848.

*Population*.—As far as is known, the original inhabitants of the Philippines were the *Astas* or *Negritos*,<sup>5</sup> so called from their dark complexion. They still exist sporadically, though in limited numbers (perhaps 25,000), throughout most of the archipelago, the *Batanes*, *Babuyan*, *Samar*, *Leyte*, *Bohol*, and *Sulu* excepted. Their headquarters are the northern part of *Nueva Ecija*, the provinces of *Principe*, *Isabela*, and *Cagayan*. To their presence in *Isla de Negros* the island owed its name. They are dwarfish (4 feet 8 inches being the average stature of the full-grown man), thin and spindle-legged, have a head like a Negro's, with flattish nose, full lips, and thick frizzled black hair, and possess an extraordinary prehensile power in their toes. They tattoo themselves, and wear very little clothing. Cigars they often smoke with the burning end between the teeth—a practice occasionally observed among the civilized Indians. They have no fixed abodes. Honey, gams, fish, wild fruits, palm-cabbages, and roots of arums, &c., constitute their food; they sell wax to Christians and Chinese in exchange for betel and tobacco. The dog is their only domestic animal.

<sup>1</sup> For the antiquities discovered there, see *Z. für Ethnol.*, Berlin, 1869.

<sup>2</sup> See for full description in *Geographisch Magazine*, 1876, and *Bot. de la Soc. Geo. de Madrid*, 1878.

<sup>3</sup> See the elaborate accounts of *Koner* in *Z. für Ethn.*, Berlin, 1867, pp. 106, 145, and of *Gerin* in *Bot. de la Soc. Geo. de Madrid*, 1881, as well as the old report of *Dairymple* in *Oriental Repository*.

<sup>4</sup> See *Montano* in *Bull. Soc. de Geogr.*, Paris, 1882, and *Blumentritt's* map and map in *Zetisch. der Ges. für Ethn.*, Berlin, 1884.

<sup>5</sup> In *Mindanao* they appear as *Mansuwa*.

The Negritos<sup>1</sup> seem to have been driven into the more inaccessible parts by successive invasions of those Malay tribes who in very different stages of civilization and with considerable variety of physical appearance now form the parti-coloured but fairly homogeneous population of the islands.

First among these rank the Tagala. They are by preference inhabitants of the lowlands, and generally fix their pile-built dwellings near water. In Manila, Cavite, Batangas, Bulacan, Morong, Infanta, Tayabas, and Bataan they form the bulk of the population, and they also appear in Zambales, Principe, Isabela, Nueva Ecija, Mindoro, Marinduque, Polillo, &c. Their language (Tagalog) especially has made extensive encroachments on the other Philippine tongues since the conquest. The Tagal is physically well developed, has a round head, high cheek bones, flattish nose, low brow, thickish lips, and large dark eyes. The lines from the nose to the mouth are usually strongly marked. The power of smell is of extraordinary acuteness. A pair of trousers and a shirt worn outside constitute the dress of the men; that of the women differs by the substitution of the saya or gown for the trousers. Agriculture, and especially the cultivation of rice, is the Tagal's staple means of living; they are also great fishers and keep swine, cattle, and vast numbers of ducks and fowls. Externally they are mostly Roman Catholics; but abundant traces of their old superstitions may still be observed. Cock-fighting and theatrical entertainments are in great favour with the Tagals; they have quite a passion for playing on musical instruments, and learn to execute European pieces with great success. Before the arrival of the Spaniards they had an alphabet of their own (see Stanley's translation of Morga), and they still possess a body of lyrical poetry and native melodies. On the death of an adult a feast is sometimes held among the better families, but the funeral itself is conducted after the ordinary Roman Catholic fashion.

The Visayas inhabit all the islands to the south of Luzon, Masbate, Burias, Ticao, and Mindoro, and to the north of Borneo, Sulu, and Mindanao. In the 15th and 16th centuries they were called "Pintados" (i.e., painted people) by the Spaniards. Though they had attained a considerable degree of civilization before the conquest, they readily accepted Christianity and assisted in the subjugation of the Tagala. The mountains in the interior of some of the Visaya Islands are occupied by savage Visayas, generally styled Infeles, Montesinos, or Cimarrones. The Calamianes, who inhabit the islands of that name, and the Caragus, who inhabit the east coast of Mindanao from Cape Surigao to Cape St Augustin, are usually classed with the Visayas.

The Igorrotes or Igolotes proper (for the name is by many writers very loosely applied to all the pagan mountain tribes of Luzon) inhabit the districts of Bangued, Lepanto, Tiagan, Bontoc. From their cranial characteristics they seem to be distinct from the Tagals and other "Malay" tribes, and they are said to show traces of Chinese and even Japanese intermixture. Dirty and savage-like in person, they are none the less industrious agriculturists—laying out their fields on artificial terraces on the mountain sides, and constructing irrigation canals with remarkable skill; and they also excel as miners and workers in metal. In the matter of sexual morality they form a striking contrast to the licentious Malays; they are monogamists, allow no divorce, and inflict severe punishment for infidelity. Though an attempt to subdue the Igorrotes was made as early as 1660, it was not till 1829 that Spanish supremacy was acknowledged.

For details in regard to the other tribes of the Philippines—the Ilocanos, Pampangos, Pangasinanes, Ibanags or Cagayans, Tingyanes (Itanegas or Tingues), Apayanos, Catalanganes, Vicolis, &c.—the reader is referred to Professor Ferd. Blumentritt's monograph, *Versuch einer Ethnographie der Philippinen*, Götting, 1832. No fewer than thirty languages are officially recognized. In 1865 it was estimated that Visaya was spoken by upwards of 2,000,000 persons, Tagalog by 1,300,000, Cebuano by 386,000, &c.

Chinese immigrants, in spite of massacres and administrative restrictions, form a powerful element in the Philippines; in Manila alone they numbered 30,000 in 1880, and there is hardly a pueblo of any size in which one or more of them is not to be found. The petty trade and banking are nearly all in their hands. Chinese mestizos or half-breeds (Mestizos de Sangley, or Mestizos Chinos) are numerous enough to form separate communities; in 1867 they were said to be 211,000 strong. The European element has never been numerically important—some 6000 or 9000 at the most; but there has grown up a considerable body of European mestizos. Traces of Indian sepoys are still seen in the neighbourhood of Manila, where sepoy regiments were quartered for about eighteen months after the conquest of Manila by the English. Owing partly to Philip II.'s prohibition of slavery the Negro is conspicuous by his absence.

There are no accurate statistics of the whole population of the Philippines; and even the number of the Spanish subjects was up till 1877 only estimated according to the number of those who paid tribute. Diar Arenas in 1833 stated the total at 3,153,290, the

ecclesiastical census of 1876 at 6,173,632, and the civil census of 1877 at 5,561,232; Moya y Jimenez, founding on certain calculations by Del Pan, and admitting an annual increase of 2 per cent., brings the number up to 10,426,000 in 1882.

*History.*—The Philippine, or, as he called them, the St Lazarus Islands were discovered by Magellan on 12th March 1521, the first place at which he touched being Jomonjol, now Malhou, an islet in the Strait of Surigao between Samar and Dinagat. By 27th April he had lost his life or the island of Maotan off the coast of Cebu. The surrender of the Molucnas by Charles V. in 1529 tended to lessen the interest of the Spaniards in the Islas de Popiente, as they generally called their new discovery, and the Portuguese were too busy in the southern parts of the Indian Archipelago to trouble about the Islas de Oriente, as they preferred to call them. Villalobos, who sailed from Navidad in Mexico with five ships and 370 men in February 1543, accomplished little (though it was he who suggested the present name of the archipelago by calling Samar Filipina); but in 1565 Legaspi founded the Spanish settlement of San Miguel at the town of Cebu, which afterwards became the Villa de Santissimo Nombre de Jesus, and in 1571 determined in large measure the future lines of conquest by fixing the capital at Manila. It is in a letter of Legaspi's in 1567 that the name Islas Filipinas appears for the first time. The subjugation of the islands, thanks to the exertions of the Roman Catholic missionaries and to the large powers which were placed in their hands by Philip, was effected, not of course without fighting and bloodshed, but without those appalling massacres and depopulations which characterized the conquest of South America. Contests with frontier rebellious tribes, attacks by pirates and reprisals on the part of the Spaniards, combine with volcanic eruptions, earthquakes, and tornadoes to break the comparative monotony of the subsequent history. Manila was captured by the English under Draper and Cornish in 1762, and ransomed for £1,000,000; but it was restored in 1764.

Professor Blumentritt published a *Bibliographie der Philippinen* in 1863; minor lists of authorities will be found in his *Versuch einer Ethnographie*, in Moya y Jimenez, &c. It is enough to mention Morga, *Sucesos de las Islas Filipinas*, Mexico, 1609 (English translation by Henry E. Stanley, Hakluyt Soc., 1869); Chirino, *Relacion de las I. F.*, Rome, 1604; Combes, *Hist. de las Islas de Mindanao, Jolo, &c.*, Madrid, 1667; Agustin, *Conquista de las I. F.*, Madrid, 1698; Juan de la Concepcion, *Hist. general de Philipinas*, Sumpaloc, 1788; Eulogia, *Hist. de Philipinas*, Sumpaloc, 1803 (English partial translation by John Mavor, 1814); Comyn, *Estado de las I. F.*, en 1820, Madrid, 1820 (new edition, 1877); Mas, *Informe sobre el Estado de las I. F.*, en 1844, Madrid, 1843; Mallat, *Les Philippines*, Paris, 1846; Diaz Arenas, *Memorias Hist. y estad.*, Manila, 1850; Buzeta and Bravo, *Diccionario estad.*, &c., de las I. F., Madrid, 1850; La Gironniere, *Pingt aux Philippines*, 1853; Semper, *Die Philippinen* (die Bewohner Würzburg, 1859; Ferrando, *Hist. de los PP. Dominicanos en las I. F.*, &c., Madrid, 1870; Jager, *Leben in den Philippinen*, Berlin, 1874; Scheidnager, *Las Colonias Espanolas de Asia*, Madrid, 1880; Calamague, *Las Islas Filipinas*, Madrid, 1880; Cavada, *Guia de Filipinas*, 1881; Francisco Javier de Moya y Jimenez, *Las I. F.* en 1688, Madrid, 1883. (H. A. W.)

**PHILIPPOLIS**, FILIPOPOLIS, and (Turkish) FKLIBE, a city of Thracia, previous to 1878 the chief town of a sanjak in the Turkish vilayet of Adrianople, and now the capital of the independent province of Eastern Roumelia and the chief town of one of the six departments, lies 112 miles west-north-west of Adrianople by rail and thus 309 miles from Constantinople, mainly on the right bank of the Maritza (the ancient Hebrus). The railway runs farther up the river to Sarambey and Simcina, but has no direct connexion with the other railway systems of Europe. Highways, however, from Bulgaria, Serbia, and Macedonia meet at Philippopolis, which, besides being the centre of an extensive trade, carries on considerable manufactures of silk, cotton, and leather. The city is built partly on a striking group of granite eminences (whence the old Roman name, Trimontium) and partly on the low grounds along the river, which in the outskirts are occupied by rice-fields. On the left side of the river and connected with the city by a long bridge is the suburb of Karshiaka. The population, estimated at 24,000 to 28,000, consists of Bulgarians, and, in smaller proportions, of Greeks, Turks, Armenians, Jews, and Gipsies. A Greek archbishop has his see in the city, and among the public buildings are a number of Greek churches and a Greek lyceum (1868).

Eumolpia, a Thracian town, was captured by Philip of Macedon and made one of his frontier posts; and, though the soldiers seem to have given it the title of "Poneropolis," or City of Hardships, and it was not long afterwards recovered by the Thracians, the name of Philip's City has stuck to it ever since. Under the Romans Philippopolis or Trimontium became the capital of Thracia; and, even after its destruction by the Goths, when 100,000 persons are said to have been slain, it continued to be a flourishing city till it was again laid in ruins by Joannes Romaiconus, the Bulgarian king. It passed under Turkish rule in 1360; in 1818 it was

<sup>1</sup> See Meyer, in *Z. f. Ethn.*, vols. v., vi., vii.

destroyed by an earthquake; and in 1846 it suffered from a severe conflagration. During the war of 1877-78 the city was occupied by the Russians.

**PHILIPPSBURG**, a small town of the grand-duchy of Baden, situated on a sluggish arm of the Rhine, 15 miles to the north of Carlsruhe, was formerly an important fortress of the German empire, and played a somewhat conspicuous part in the wars of the 17th century. It originally belonged to the ecclesiastical principality of Spire, and was named Udenheim, but in 1618 it was fortified and re-christened by Bishop Philip von Sötern. At the peace of Westphalia (1648) the French remained in military possession of Philippsburg, but in 1679 it was restored to Germany, and though again captured by the French in 1688 it was once more restored in 1697. In 1734 the dilapidated fortress fell an easy prey to the French under Marshal Berwick, who, however, lost his life beneath its walls, and in 1800 the works were razed. The town was assigned to Baden in 1803. The population in 1880 was 2549.

**PHILIPS, AMBROSE** (1671-1749), English man of letters, was born of a good Leicester family in 1671. While at St John's College, Cambridge, he gave evidence of literary taste and skill, in verses forming part of a memorial tribute from the university on the death of Queen Mary. Going to London on the completion of his studies, Philips speedily became "one of the wits at Button's," and thereby a friend of Steele and Addison. He began to write for Tonson, working at such heterogeneous subjects as translated "Persian Tales" and a summary of Hacket's *Life of Archbishop Williams*. The first product really characteristic of the author, after his settlement in London, is the series of *Pastorals* which opened the sixth volume of Tonson's *Miscellanies* (1709). Pope's *Pastorals*, curiously enough, closed the same volume, and the emphatic preference expressed in the *Guardian*, in 1713, for Philips's pastoral style over all other successors to Spenser gave rise to Pope's trenchant ironical paper in No. 40 of the same periodical. The breach between these two wits speedily widened, and Philips was at length concerned in the great quarrel between Pope and Addison. He had come to be a man of some note both for literary work and political activity. The *Spectator* had loaded with praises the drama of *The Distress'd Mother*, which Philips adapted from Racine's *Andromaque* and brought upon the stage in 1712, and he was thus a recognized member of Addison's following. There is some doubt as to the particular part he played in the notorious contest of the two chiefs, but, whether he threatened to beat Pope or not (with the rod which he is said to have hung up at Button's for that purpose), there is ample evidence to show that both Pope and his friends had a bitter feeling towards him. Not only is he honoured with two separate lines in the *Dunciad*, but he figures for illustrative purposes in *Martinus Scriblerus*, and he receives considerable attention in the letters of both Pope and Swift. The latter found occasion for special allusion to Philips during Philips's stay in Ireland, whither he had gone as secretary to Archbishop Boulter. He had done good work in the *Freethinker* (1711) along with Boulter, whose services to the Government in that paper gained him preferment from his position as clergyman in Southwark, first to the bishopric of Bristol and then to the primacy of Ireland. Up to this time Philips had shown disinterested zeal in the Hanoverian cause, though he had received no greater reward than the positions of justice of peace and commissioner of the lottery (1717). He had also written some of his best epistles, while in 1722 he published two more dramatic works—*The Briton* and *Humphry, Duke of Gloucester*—neither of which has had the fortune, like their predecessor, to be immortalized by

romantic criticism. It was, no doubt, a grateful change for Philips to go to Ireland under the patronage of Archbishop Boulter, and to represent, through the same influence, the county of Armagh in the Irish Parliament, while his sense of his own political worth must have been flattered when he became secretary to the lord chancellor in 1726, and in 1733 judge of the prerogative court. After the archbishop's death he by and by returned to London, and dedicated a collected edition of his works to the duke of Newcastle. He died in 1749.

While it can hardly be said that Philips's *Pastorals* show poetic quality of a high order, they must be commended—and perhaps the third in particular—for ease and fluency and rhetorical vigour. In these features they are not surpassed by the pastorals in *The Shepherd's Week* which Gay wrote, at Pope's instigation, as a burlesque on Philips's work; but the grasp of rustic simplicity and the exquisite play of fancy possessed by Gay are manifest advantages in his performance. The six epistles evince dexterous management of the heroic couplet, an energetic directness of purpose, and (particularly the "winter piece" addressed to the earl of Dorset) a noticeable appreciation of natural beauty. Similar felicitous diction and sympathetic observation, together with a determined bias towards weakness of sentiment, are characteristic of the poet's odes, some of which—addressed to children—gave occasion for various shafts from both Swift and Pope, as well as for the nickname of "Nemby-Pamby," coined by Henry Carey as a descriptive epithet for Philips. The epigrams, and the translations from Pindar, Anacreon, and Sappho, need merely be named as completing the list of the author's works.

See Johnson's *Lives of the Poets*; Spence's *Annotations*; the *Spectator*; the *Works* (especially the correspondence) of Pope and Swift; Stephen's *Pope and Courthope's Addison*, in *English Men of Letters*.

**PHILIPS, JOHN** (1676-1708), English man of letters, son of Dr Stephen Philips, archdeacon of Salop, was born at Bampton in Oxfordshire in 1676. After receiving private education at home, he went to Winchester School, and in due course became a student of Christ Church, Oxford. At school he showed special aptitude for exact scholarship, and at the university, under Dean Aldrich, he became one of the most remarkable men of his time. He was an ardent and successful student of the ancient classics, and took special pleasure in making himself thoroughly familiar with Virgil. At the same time he was diligent in his scientific pursuits preparatory to the medical profession he intended to follow, and, although the botany and other branches he made himself familiar with were never actually turned to account in the business of life, his acquired knowledge gave him material for literary purposes. But, over and above these studies Philips was a careful and critical reader of the English poets that fell in with his tastes, and devoted much time to Chaucer, Spenser, and Milton. When he began to write, the influence of the two former told to some extent on his diction, and he was so enamoured of the strenuous movement and the resonant harmonies of Milton's blank verse that he adapted the form of all his original English writings to that supreme model. Were it for nothing else, John Philips will be remembered as the first to have a genuine literary appreciation of Milton. He was well known in his college for scholarship, taste, and literary resource long before publishing any of his writings, but the appearance of *The Splendid Shilling*, about the year 1703, at once brought him under the favourable notice of critics and readers of poetry. The *Tatler* (No. 250) hailed the poet as the writer of "the best burlesque poem in the British language," nor will the modern reader care to detract much from this verdict, even granting that the model and the imitation, mutually constituting a great revelation to the literary dictators of the period, would cause them considerable surprise. Philips in this poem showed the dexterous ease that comes of long study and perfect familiarity, combined with fertility of resource and humorous ingenuity of application. One important result of the work was the interested notice of the earl of Oxford and Lord Bolingbroke. The poet went to London, and

was asked to celebrate the victory of Blenheim, which he did in his favourite manner, but without conspicuous success. The *Blenheim*, published in 1705, lacks, of course, the element of burlesque, and it is difficult to resist the impression that the poet must have felt himself restrained and hampered by the stern necessity of being seriously sublime. A year later (1706) Philips published, in two books, his didactic poem entitled *Cyder*, which is his most ambitious work and is written in imitation of Virgil's *Georgica*. While there is no denying the poet's admirable familiarity with his original, or his skilful employment of the Miltonic blank verse, or the sustained energy and grace of some of the episodes in the second part, or even his intimate knowledge of the minute details connected with the management of fruit, it cannot be said that the work is a notable contribution to English poetry. It is streaked with genius, but, like the Latin *Ode to St John* (and, for that matter, the author's other works as well), it is little more than the expression of a poetical scholar feeling his way outwards into life. Philips never got beyond the enjoyment of his pipe and his study, both of which figure prominently in all his poems. He was meditating a still further work on the Last Day, when he was cut off by consumption, in 1708, at the early age of thirty-two. His friend Edmund Smith, himself a distinguished scholar and poet, wrote an elegy on the occasion, which Johnson says "justice must place among the best elegies which our language can show." Philips was buried at Hereford, and a monument to his memory, with an inscription from the pen of Atterbury, was erected between those of Chaucer and Drayton in Westminster Abbey.

See Johnson's *Lives of the Poets*, including Smith's *Prefatory Discourse*; Sewall's *Life of Mr John Philips*; the *Tattler*, &c.

PHILIPPUS, M. JULIUS, Roman emperor from 244 to 249 A.D., often called "Philip the Arab," was a native of Bostra or the Trachonitis, who, exchanging the predatory life of the Arabs who hung on the desert borders of the empire for Roman military service, rose to be pretorian prefect in the Persian campaign of Gordian III, and, inspiring the soldiers to mutiny and to slay the young emperor, was raised by them to the purple (244). Of his reign little is known except that he celebrated the secular games with great pomp in 248. A rebellion broke out among the legions of Moesia, and Decius, who was sent to quell it, was forced by the troops to put himself at their head. Philip was defeated near Verona and perished in or after the battle, leaving a very evil reputation. Eusebius knows a current opinion that Philip was a Christian; Jerome and later writers state this as a fact. But at best his Christianity must have been merely nominal and had no effect on his life or reign. With Philip perished his son and colleague, then a boy of twelve, who is known as Philippus II.

PHILISTINES (פְּלִשְׁתִּים), the name of a people which, in the latter part of the age of the Judges and up to the time of David, disputed the sovereignty of Canaan with the Israelites (see ISRAEL, vol. xiii. p. 402 sq.). The Philistine country (פְּלִשְׁתִּים, *Palastina*; the authorized version still uses the word in this its original sense as equivalent to Philistia) embraced the rich lowlands on the Mediterranean coast (the Shephelah) from somewhere near Joppa to the Egyptian desert south of Gaza, and was divided between five chief cities, Ashdod or AZOTUS (*q.v.*), GAZA (*q.v.*), and Ashalon (Ashkelon, ASCALON, *q.v.*) on or near the coast, and GATH (*q.v.*) and EKRON (*q.v.*) inland. The five cities, of all of which except Gath the sites are known,<sup>1</sup> formed a confederation under five "lords" (Seranim).<sup>2</sup>

Ashdod was probably the foremost city of the confederation in the time of Philistine supremacy; for it heads the list in 1 Sam. vi. 17, and it was to the temple of Dagon in Ashdod that the ark was brought after the battle of Aphek or Ebenezer (1 Sam. v. 1). Hebrew tradition recognizes the Philistines as immigrants into Canaan within historical times, like the Israelites and the Arameans (Amos ix. 7), but unlike the Canaanites. They came, according to Amos, from Caphtor (comp. Jer. xvii. 4), and Deut. ii. 23 relates that the Caphtorim from Caphtor displaced an earlier race, the 'Avvim, who were not city-dwellers like the Canaanites, but lived in scattered villages. The very name of Philistines probably comes from a Semitic root meaning "to wander"; the Septuagint calls them Ἀλλόφυλοι, "aliens." The date of their immigration cannot be determined with certainty.<sup>3</sup> We are scarcely entitled to take Gen. xxi. xxvi., as proving that the inhabitants of Gerar in patriarchal times were identical with the later Philistines, and the other references in the Pentateuch and Joshua are equally inconclusive. The first real sign of the presence of the Philistines is when the Danites, who in the time of Deborah were seated on the sea-coast (Judges v. 17), were compelled—obviously by the pressure of a new enemy—to seek another home far north at the base of Mount Hermon (Judges xviii.). This marks the commencement of the period of Philistine aggression, when the foreigners penetrated into the heart of the Israelite country, broke up the old hegemony of Ephraim at the battle of Ebenezer, and again at the battle of Mount Gilboa destroyed the first attempt at a kingdom of all Israel. The highest power of the Philistines was after the death of Saul, when David, who still held Ziklag, and so was still the vassal of Gath, reigned in Hebron, and the house of Saul was driven across the Jordan. But these successes were mainly due to want of union and discipline in Israel, and when David had united the tribes under a new sceptre the Philistines were soon humbled. After the division of the kingdom the house of Ephraim appears to have laid claim to the suzerainty over Philistia, for we twice read of a siege of the border fortress of Gibeon by the northern Israelites (1 Kings xv. 27, xvi. 15); but the Philistines, though now put on the defensive, were able to maintain their independence. Philistia was never part of the land of Israel (2 Kings i. 3, viii. 2; Amos vi. 2), and its relations with the Hebrews were embittered by the slave trade, for which the merchants of Gaza carried on forays among the Israelite villages (Amos i. 6). On the other hand, the trading relations between Gaza and Edom (Amos, *et sup.*) probably imply that in the 8th century Judah, which lay between the two, was open to Philistine commerce (comp. Isa. ii. 6); Judah under Uzziah had reopened the Red Sea trade, of which the Philistine ports were the natural outlet.<sup>4</sup> Soon, however, all the Palestinian states fell under the great empire of Assyria, and Tiglath-Pileser, in 734 B.C., subdued the Philistines as far as Gaza. But the spirit of the race was not easily broken; they were constantly engaged in intrigues with Egypt, and had a share in every conspiracy and revolt against the great king. Of two of these revolts, first against Sargon in 711, and afterwards against Sennacherib on Sargon's death (705), a memorial is preserved in Isa. xx., xiv. 29 sq. In the latter revolt Heskiah of Judah was also engaged; it was to him that

<sup>1</sup> For some Egyptian evidences, see PREHISTORICAL.

<sup>2</sup> The Chronicler, who represents the relations of Judah and Philistia as generally unfriendly, makes Uzziah subdue the latter country as well as Edom, assuming perhaps that he was the fulfiller of the prophecy in Amos i., in which, however, it is the Assyrians who are really pointed to as the ministers of divine justice. The old history has no trace of pretensions of Judah to sovereignty in Philistia till the time of Heskiah. Comp. Wellhausen, *Prolegomena*, p. 217.

<sup>3</sup> Their modern names are Ashdod, Gaza, Ashkelon, Ekron.

<sup>4</sup> The word *seren*, pl. *seranim*, means an axle, and seems to be applied metaphorically like the Arabic *jeff*.

radi, kinglet of Ekron and a partisan of Assyria, was delivered for custody by the rebels. In 701 Sennacherib marched westward and reduced the rebel cities of Ascalon and Ekron; kinglets faithful to his cause were established in both places, and the territories of these Philistine princes and of those of Gaza and Ashdod were enlarged at the cost of Judah. The Philistine war of Hezekiah spoken of in 2 Kings xviii. 8 was probably undertaken to regain the lost territory after the disaster of Sennacherib's army. Under Esarhaddon and Assurbanipal the inscriptions still speak of the cities of Philistia as governed by kinglets tributary to Assyria; and, as the power of Nineveh declined and the monarchs of Egypt began to form plans of aggrandizement in Syria, the Philistine fortresses were the first that opposed their advance. According to Herodotus (ii. 157) Psammetichus besieged Ashdod for twenty-nine years, from which we may at least conclude that the Shephelah was the scene of a protracted conflict between the two great powers. The prophecy of Zephaniah ii. 4 sq. has by some been held to point to these events; but most recent writers prefer to connect it with the invasion of the Scythians, who in the reign of Psammetichus ravaged the Phœnician coast and plundered the famous temple of Aphrodite Urania (Astarte) at Ascalon (Herod., i. 105). The next king of Egypt, Necho, also made war in the Philistine country and smote Gaza (Jer. xlvii.), an event recorded also by Herodotus, who gives to Gaza (Ghazzat, Assyrian Khaziti) the name of Cadytis (Herod., ii. 159, comp. iii. 5).<sup>1</sup> Amidst all these calamities Philistia, like the other countries of Syria in the Assyrio-Babylonian period, must have lost great part of its old individuality. The Philistine towns continued to be important, and Gaza in particular became a great seat of international commerce—Herodotus estimates Cadytis as being almost as large as Sardis—but we can hardly speak further of a Philistine people. After the captivity Nehemiah speaks not of Philistines but of Ashdodites (iv. 7), speaking an "Ashdodite" dialect (xiii. 24), just as Strabo regards the Jews, the Idumeans, the Gazans, and the Ashdodites as four cognate peoples having the common characteristic of combining agriculture with commerce. In southern Philistia at least the population was modified by Arabian immigration. In the time of Cambyses the Arabs touched the sea immediately south of Gaza (Herod., iii. 5), and this perhaps had something to do with the fact that Gaza was the only Syrian city that resisted Cyrus, just as the Persian and Arab garrison of Gaza offered to Alexander the only resistance that he found on his march from Tyre to Egypt.

We have still to consider the much-veiled question of the origin of the Philistines. That they were a Semitic or at least a thoroughly Semitized people can now hardly be made matter of dispute. The short list of proper names derived from the Bible has been considerably enlarged from the Assyrian monuments, and suffices to prove that before as after the captivity their language was only dialectically different from that of the Israelites. The religion too was Semitic, and of that older type when the gods were not yet reduced to mere astral powers, but had individual types and special relations to certain animals. Thus Ekron had its local "Fly-Baal" (Baal-Zebub, 2 Kings i. 2 sq.), the fame of whose oracle in the 9th century B.C. extended as far as Samaria. The more famous Dagon, who had temples at Ashdod (1 Sam. v.; 1 Mac. x. 83) and Gaza (Judges xvi. 21 sq.), seems to have been more than a mere local deity; there was a place called Beth-Dagon in Judæa (Josh. xv. 41) and another on the borders of Asher (Josh. xix. 27). The name Dagon seems to come from דָּג, "fish," and

that his idol was half-man half-fish is pretty clear from 1 Sam. v. 4, where, however, the text is hardly sound, and we ought probably to read, omitting one of two consecutive *asas*, "only his fish-part was left to him."

There are two other views about Dagon. (1) Philo Byblius (Müller, *Fr. Hist. Græc.*, iii. 567 sq.) makes Dagon the inventor of corn and the plough, whence he was called Ζεὺς Ἀπόρροος. This implies an etymology of a very improbable kind from the Hebrew and Phœnician דָּג, "corn." But it is probable that, at least in later times, Dagon had in place of, or in addition to, his old character that of the god who presided over agriculture; for in the last days of paganism, as we learn from Marcus Diaconus in the *Life of Porphyry of Gaza* (§ 19), the great god of Gaza, now known as Marna (our Lord), was regarded as the god of rains and invoked against famine. That Marna was lineally descended from Dagon is probable in every way, and it is therefore interesting to note that he gave oracles, that he had a circular temple, where he was sometimes worshipped by human sacrifices, that there were wells in the sacred circuit, and that there was also a place of adoration to him situated, in old Semitic fashion, outside the town. Certain "marmora" in the temple, which might not be approached, especially by women, may perhaps be connected with the threshold which the priests of Dagon would not touch with their feet (1 Sam. v. 5; Zeph. i. 9). (2) Schrader (*K. A. T.*, 2d ed., p. 181 sq.) identifies Dagon with the Assyrian god Dakan, and believes that the word is Accadian. We are here in a region of pure conjecture; the attributes of Dakan are unknown, save only that Berosus speaks of an Assyrian merman-god *Dakano*.

To the male god Dagon answers in the Bible the female deity Astarteth, whose temple spoken of in 1 Sam. xxxi. 10 is probably the ancient temple at Ascalon, which Herodotus regarded as the oldest seat of the worship of Aphrodite Urania. This Astarteth is the Derketo of Diodorus (ii. 4) and Lucian (*De Dea Syr.*, 14), the Atargatis of Xanthus (*Fr. Hist. Græc.*, i. 155), whose sacred enclosure and pool were near Ascalon, and whose image had a human head, but was continued in the form of a fish.<sup>2</sup> The association of Astarteth with sacred pools and fish was common in Syria, and the sacred doves of Ascalon mentioned by Philo (ed. Mangey, ii. 646) belonged to the same worship.<sup>3</sup> Of the details of Philistine religion in the Biblical period we know almost nothing.<sup>4</sup> Their gods were carried into battle (2 Sam. v. 21), a usage found among other Semites; their skill in divination is alluded to in Isa. ii. 6, and we have already seen that oracles were a feature in their shrines. The whole record shows a religion characteristically Semitic in type; and it is also noteworthy that at the earliest date when the Philistines appear in history the great sanctuaries are all on the coast with deities of a marine type. This raises a presumption that the Philistines came from over the sea, and that Caphtor, their original home, was an island or maritime country.<sup>5</sup> In point of fact the Philistines must have entered their later seats either by sea or from the desert between Canaan and Egypt. In the latter case they come from Egypt, for a city-building people, which supplanted a race of villagers, cannot have been a tribe of Arabs. And so the theories about the origin of the Philistines reduce themselves to two, one class of writers holding that Caphtor must be sought across the Mediterranean, another placing it in the

<sup>1</sup> The name Atargatis is a later compound, of which the first half is the Aramaic form of Astarte (Attar), and the second is *ATU*.

<sup>2</sup> The Aphrodite of Gaza in Marcus, *Vit. Porph.*, § 59, is rather Aphrodite Pandemos. She gave oracles by dreams in matters relating to marriage.

<sup>3</sup> Schrader thinks that traces of Jehovah (Jahveh) worship among the Philistines are to be found in the Philistine names Padi, Mifimti, Sidai, &c., on the Assyrian inscriptions (see also Friedrich Delitzsch, *Neu. u. alt. Perudias*, p. 169 sq.). It is probable enough that Sidai at least is a shortened form of a name in which the second element was that of a god; but such Phœnician names as Kalbi (side by side with Kalbiak: Hanno, Abdā or Bodo, &c.), show that the shortening does not in the least imply that the divine name was Jahveh.

<sup>4</sup> The expression "isle" (or coastland, Hebrew *Yot*) of Caphtor in Jer. xlvii. is generally cited as conclusive to this effect; but in the context it is by no means clear that it means anything more than the coastland of Philistia.

<sup>5</sup> The reference to Necho and Gaza is not in the Septuagint of Jer. xlvii. 1, and it would be more natural to think of Chaldaea as the enemy from the north whom Jeremiah describes.



Delta. Ancient tradition gives no help; for it takes Caphtor to be Cappadocia, led, it would seem, merely by a superficial similarity of the names. Of the two main theories the former is that which has recently found most support, and it has a definite point of attachment in the fact that the Philistines, or a part of them, are also called in the Bible Cherethites (1 Sam. xxx. 14; Esak. xxv. 16; Zeph. ii. 5), while David's Philistine guards are in like manner called the Cherethites and Pelethites (2 Sam. viii. 18, xv. 18, &c.). Cherethites (Krētim) can hardly be anything but Cretans, as the LXX. actually renders it in Ezekiel and Zephaniah, and Caphtor would thus be the island of Crete,—an identification which seems to satisfy the conditions of a reasonable hypothesis. For, though the points of contact between Crete or Cretan religion and the Philistine coast which have been sought in Greek and Latin writers (chiefly in Steph. Byzant., s.v. "Gaza") are very shadowy, there is no doubt that Crete had an early connexion with Phœnicia and received many Semitic inhabitants and a Semitic civilisation before the Greeks gradually asserted themselves in the Ægean and forced back the tide of Semitic influence (for details, see the article PHœNICIA). These facts give a reasonable explanation of the settlement on the Philistine coast within historical times of a maritime people, cognate to the Phœnicians in so many points and yet having certain distinct characters, such as would naturally be produced in a place like Crete by the grafting of a Semitic stock and culture on ruder races not Semitic (the Eteocretans).<sup>1</sup> The opposite view, which places Caphtor in the Delta, rests on more complicated but less satisfactory arguments. There were certainly many Semites in the Delta of Egypt, and so long as the history of the Hyksos (who were no doubt Semites) remains in its present obscurity it is always possible to suppose that their expulsion from Egypt explains the settlement of the Philistines in Canaan. But it is very questionable if the dates will fit; the name Caphtor is connected with the Delta by no historical testimony, but only by elaborate hypotheses, as that Caphtor may mean in Egyptian Great Phœnicia, and that this again may have been a name for the Egyptian coast, where there was a large Semitic population;<sup>2</sup> and the characteristic Philistine peculiarity of uncircumcision, intelligible enough on the Cretan theory is scarcely conceivable in a race which had been long settled in Egypt. The mainstay of the Egyptian hypothesis is found in Gen. x. 13, 14,—verses which belong to the older part of the chapter (see NOAH), and reckon in the very obscure list of descendants of Mizraim or Egypt "Caaluhim" (whence came forth Philistim) and Caphtorim." This account places Caphtorim in some relation to Egypt, but not necessarily in a very close relation, for the Ludim, who are also made descendants of Egypt, are scarcely different from Lud or Lydia, which appears at ver. 22, in the later part of the chapter, in another connexion. But further, if the text as it stands is sound, it gives a new account of the origin of the Philistines, which can be reconciled with the other Biblical evidence only by making Caaluhim a halting-place of the Philistines on their way from Caphtor to Canaan. Accordingly the advocates of the Egyptian theory propose to identify Caaluhim with the arid district of Mount Casius on the coast of the Egyptian desert. But this is false etymology. Mount Casius is named from the temple of Jupiter Casius, that is, the well-known Semitic

God ʾAsp,<sup>3</sup> whose name as written in Semitic letters has no possible affinity to Caaluhim. And in truth the statement that the Philistines came from Caaluhim, presented without a hint as to their connexion with Caphtorim, which is mentioned immediately afterwards, lies under strong suspicion of being a gloss, originally set on the margin by a copyist who meant it to refer to Caphtorim.<sup>4</sup> In this case the original author will have meant Caphtorim to denote, or at least include, the Philistines (who, as they are not Canaanites, and had close relations with Egypt in historical times, fall readily enough under the Egyptian group), and tells us nothing about the origin of the race.

*Literature.*—Hitzig, *Urgeschichte . . . der Philistiner*, 1846, where the now untenable hypothesis of a Pelasgic origin of the Philistines is maintained; Ewald, *Gesch. des V. Israel*, i. 248 sq., and in general the books on Hebrew history and commentaries on Gen. x. and on Amos. A useful monograph is Stark's *Gaza und die philistische Küste*, Jena, 1852. For the Assyrian evidence see especially Schrader, *Kleinigkeiten und Altes Testament*, 2d ed., Glessen, 1888. (W. R. S.)

PHILLIP, JOHN (1817-1867), subject and portrait painter, was born at Aberdeen, Scotland, on 19th April 1817. His father, an old soldier, was in humble circumstances, and the son became an errand-boy to a tinmith of the place, and was then apprenticed to a painter and glazier. Meanwhile he was employing in the pursuit of art all the time he could spare from his daily duties, and, having received some technical instruction from a local artist named William Mercer, he began, at the age of about fifteen, to paint portraits. In 1834 he was enabled to make a very brief visit to London, where he studied with delighted interest in the Royal Academy Exhibition and the National Gallery. At this time, or shortly afterwards, he became assistant to James Forbes, an Aberdeen portrait-painter, under whose tuition he made considerable progress. Previously, however, he had gained a valuable patron. Having been sent to repair a window in the house of Major P. L. Gordon, his interest in the works of art which hung on the walls attracted the attention of their owner. He brought the young artist under the notice of Lord Panmure, who bought several of his productions, and in 1836 sent the lad to London, promising to bear the cost of his art-education. At first Phillip was placed under T. M. Joy, but he soon entered the schools of the Royal Academy, where he worked diligently, but with no exceptional promise or success, for two years. In 1839 he figured for the first time in the Royal Academy Exhibition with a portrait and a landscape, and in the following year he was represented by a more ambitious figure-picture of Tasso in Disguise relating his Persecutions to his Sister. For the next ten years he supported himself mainly by portraiture and by painting subjects of national incident, such as Presbyterian Catechising, Baptism in Scotland, and the Spawwife. His productions of this period, as well as his earlier subject-pictures, are reminiscent of the practice and methods of Wilkie and the Scottish genre-painters of his time, often possessing considerable grace of form, executed in a thin delicate style of painting, inclining to brownish tones of colour, and with the more powerful pigments introduced cautiously and with reserve. The Letter-writer of Seville, shown in the Royal Academy of 1854, marks a distinct change of both style and subject. Three years previously the artist's health had shown signs of delicacy, and his medical advisers had recommended a residence in a warmer climate. Spain was selected, and a fresh potency came to his art as well as to his physical frame. He was brought face to face for the first time with the brilliant sunshine and the splendid colour of the South, and it was in coping

<sup>1</sup> In 2 Sam. xx. 23, Ktfr, and 2 Kings xl. 4, 19, the foreign mercenaries are called not Kretim but Krt, perhaps Carians. The Cretan seamen and pirates had also a strong Semitic strain, and were at bottom the same race with the Eteocretans.

<sup>2</sup> So Ebers, *Ägypten und die Acker Mose*, where the theory is supported by a very long and complex argument. Another etymology in support of the theory is given by Dietrich in *Mora's Archiv*, i. 518 sq.

<sup>3</sup> See De Vogüé, *Syrie Centrale: Inscr. Sem.*, p. 108 sq.

<sup>4</sup> So Olshausen, and Budde, *Biblische Urgeschichte*, p. 251, note. A mere transposition (so Ewald, *Urch.*, &c.) is much less probable.

with these that he first manifested his artistic individuality and finally displayed his full powers. In the Letter-writer, commissioned by the Queen at the suggestion of Sir Edwin Landseer, who had been greatly impressed by some of Phillip's Spanish sketches, we see the change of method in its initial stages rather than in its complete triumph. The artist is struggling with new difficulties in the portrayal of unwonted splendours of colour and light, the draperies are somewhat crude and textureless, and the picture may justly be charged with a want of complete harmony and of a due sense of the finer gradations of nature. In 1857 Phillip was elected an associate of the Royal Academy, and in 1859 a full member. In 1855 and in 1860 other two visits to Spain were made, and in each case the painter returned with fresh materials to be embodied with increasing power and subtlety in the long series of works with which his name is exclusively associated in the popular mind, and which has won for him the title of "Spanish Phillip." His highest point of execution is probably reached in the *La Gloria* of 1864 and a smaller single-figure painting of the same period entitled *El Cigarillo*. These Spanish subjects were varied in 1860 by a rendering of the *Marriage of the Princess Royal with the Crown Prince of Germany*, executed by command of the Queen, and in 1863 by a picture of the House of Commons, subjects presenting extreme artistic difficulties, but treated with much skill and dexterity. During his last visit to Spain Phillip occupied himself in a careful study of the art of Velasquez, and the copies which he made after that artist fetched large prices after his death, examples having been secured by the Royal and the Royal Scottish Academies. The year before his death he visited Italy and devoted much attention to the works of Titian. The results of this study of the old masters are visible in such of Phillip's works as *La Loteria Nacional*, left uncompleted at his death. This and several other of his later works exhibit symptoms of a fresh change of method, and show signs that his art was again about to take a fresh departure. During this period he resided much in the Highlands, and seemed to be returning to his first love for Scottish subjects, painting several national scenes, and planning others that were never completed. His health had been always delicate, and his strength had been taxed by severe domestic affliction and by the very exceptional rapidity and quantity of his artistic production. In the end of 1866 his excessive application to work for the next year's exhibition induced an attack of bilious fever, which was succeeded by paralysis, and the genial and talented artist expired at London on 27th February 1867 at the age of fifty.

In execution Phillip was singularly direct, forcible, and rapid. He was a noble colourist, a painter in the first and simplest sense of the word, concerning himself mainly with the visible and sensuous beauties of his subjects, their purely artistic problems of colour, tone, lighting, and texture. His art dealt with the appearances of things, a sufficiently legitimate sphere for the painter, and was seldom permeated with any very deep human or dramatic interest. His works were collected in the International Exhibition of 1873, and many of them have been excellently reproduced by the engravings of T. Oldham Barlow. In addition to the paintings which we have already specified the following are among the more important:—*Life among the Gipsies of Seville* (1853), *El Paseo* (1855), *Collection of the Offertory in a Scotch Kirk* (1855), *a Gipsy Water-carrier in Seville* (1855), *the Prayer of Faith shall save the Sick* (1856), *the Dying Contrabandist* (1856), *the Prison Window* (1857), *a Huff* (1859), *Early Career of Murillo* (1865), *a Chat round the Brazero* (1866).

PHILLIPS, JOHN (1800-1874), one of the foremost of the early geologists of England, was born 25th December 1800 at Marden in Wiltshire. His father belonged to an old Welsh family, but settled in England as an officer of excise and married the sister of William Smith, the "Father of English Geology." Both parents dying when

he was a child, Phillips passed into the care of his uncle. Before his tenth year he had attended four schools, until he entered the old school at Holt Spa, Wiltshire, where he remained for five years, gaining among other acquisitions that taste for classical learning which remained one of his distinguishing traits to the end. From school he went to the house of the Rev. B. Richardson, an accomplished naturalist, in whose charge he remained a year, and from whom he obtained not only much knowledge but the strong bent towards the study of nature which thenceforth became the master-pursuit of his life. His uncle, "Strata Smith," at that time lived in London, where he exercised the profession of a civil and mining engineer, though a very large part of his time and earnings was given to the preparation of those maps of England and the English counties on which his fame now rests. In his zeal for geological pursuits Smith often neglected his proper professional work, until, as his nephew said, "he had thrown into the gulf of the Strata all his patrimony and all his little gains." Eventually he gave up his London house and wandered about the country, as the requirements of his maps led him. From the time that young Phillips joined his uncle in London he remained constantly with him, sharing in every piece of professional work, in the preparation of every book and map, and in every tour for fresh geological information. A youth so trained could not fail to become a geologist. In the spring of 1824 Smith went to York to deliver a course of lectures on geology, and his nephew accompanied him. This was the starting-point in Phillips's career. His extensive knowledge of natural science and especially of fossils was now turned to account. He accepted engagements in the principal Yorkshire towns to arrange their museums and give courses of lectures on the collections contained therein. York became his residence, where he obtained the situation of keeper of the Yorkshire Museum and secretary of the Yorkshire Philosophical Society. From that centre he extended his operations to other towns beyond the county; and in 1831 he included University College, London, in the sphere of his activity. In that year the British Association for the Advancement of Science was founded at York, and Phillips was one of the active minds who organized its machinery. He became the assistant general secretary, a post of great labour and proportionate usefulness, which he held for upwards of thirty years. In 1834 he accepted the professorship of geology at King's College, London, but retained his post at York, coming up to London every year to give a course of lectures there. This arrangement lasted for six years, until, in 1840, he resigned his charge of the York Museum and was appointed one of the staff of the Geological Survey of Great Britain under De la Beche. In this connexion he spent some time in studying the Paleozoic fossils of Devon, Cornwall, and west Somerset, of which he published descriptions and illustrations. Thereafter he made a detailed survey of the region of the Malvern Hills, of which he prepared the elaborate account that appears in vol. ii. of the *Memoirs of the Survey*. His direct connexion with the National Survey was but of short duration, for in 1844 he accepted the professorship of geology in the university of Dublin. Nine years later, on the death of Strickland, who had acted as substitute for Dr Buckland in the readership of geology in the university of Oxford, Phillips succeeded to the post of deputy, and eventually, at the dean's death, became himself reader, a post singularly congenial to him, and which he held up to the time of his own death, which was almost tragic in its suddenness. He dined at All Souls' College on 23d April 1874, but a retiring slipped and fell headlong down a flight of stairs. Paralysis at once ensued, and he expired on the afternoon

of the next day. In 1864 he had been elected president of the British Association.

Phillips was distinguished among his contemporaries for the sweetness and bright cheerfulness of his nature. He had great fluency as a speaker, and always spoke in so pleasant and interesting a manner as to make him a welcome and indeed indispensable interlocutor at the annual gatherings of the British Association. His social gifts were not less conspicuous than his attainments in science. But he was not a mere geologist. His sympathies went actively forth into the whole domain of science, and he himself contributed largely to astronomical literature as well as to meteorology.

From the time when he wrote his first paper in 1826 "On the Direction of the Diluvial Currents in Yorkshire" down to the last days of his life Phillips continued a constant contributor to the literature of his science. The pages of the *Journal of the Geological Society*, the *Geological Magazine*, and other publications of the day are full of valuable essays by him. He was also the author of numerous separate works, some of which had an extensive sale and were of great benefit in extending a sound knowledge of geology. Among these may be specially mentioned: *Illustrations of the Geology of Yorkshire* (1835); *A Treatise on Geology* (1837-39); *Memoirs of William Smith, the Father of English Geology* (1844); *The Rivers, Mountains, and Sea-Coast of Yorkshire* (1853); *Manual of Geology, Practical and Theoretical* (1855); *Life on the Earth: its Origin and Succession* (1860); *Vesuvius* (1869); *Geology of Oxford and the Thames Valley* (1871). To these should be added his monographs in the *Memoirs of the Geological Survey* and the publications of the Palaeontographical Society, and his geological sections and maps.

PHILLIPS, SAMUEL (1815-1854), an industrious and successful *littérateur*, was the son of a Jewish tradesman in Regent Street, London, and was born in 1815. A somewhat precocious talent for mimicry and recitation had disposed his parents to train him for the stage; but they were afterwards induced, through the advice of the duke of Sussex, to send the lad to University College, London. After remaining a year at that institution Phillips proceeded to the university of Göttingen. Having renounced the Jewish faith, he returned shortly afterwards to England and entered Sidney Sussex College, Cambridge, with the design of taking orders. His father's death, however, altered his plans; and, after an unsuccessful attempt, in conjunction with his brother, to carry on his father's business, he in 1841 took to literature as a profession. His first work, the novel of *Caleb Stukeley*, appeared originally in the pages of *Blackwood's Magazine*, and he subsequently contributed other anonymous tales to that and to other periodicals. In 1845 he began, through the interest of Lord Stanley, to write political leaders for the *Morning Herald*; and about the same time he obtained an appointment as literary critic on the staff of the *Times*. In the following year he purchased the *John Bull* newspaper, which he edited for only a year; for, finding his strength, which was slowly wasting under the influence of confirmed consumption, quite unequal to such laborious work, he was constrained to abandon the undertaking. From that period till his death Phillips worked cheerfully and courageously as literary critic for the *Times*, and also wrote an occasional review for the *Literary Gazette*. Two anonymous volumes of *Essays from the Times* were published by him in 1852 and 1854. They are written in a light, dashing, picturesque style, sometimes eloquent, frequently bitter, and with a tolerable show of fairness. Phillips took an active part in the formation of the Crystal Palace Company. He was appointed their literary director; he wrote their *Guide to the Crystal Palace and Park*, and the *Portrait Gallery of the Crystal Palace*. In 1852 the university of Göttingen conferred upon him the honorary degree of LL.D. He died at Brighton on the 14th of October 1854.

PHILLIPS, THOMAS (1770-1845), portrait and subject painter, was born at Dudley in Warwickshire on 18th October 1770. Having acquired the art of glass-painting at Birmingham, he visited London in 1790 with an intro-

duction to Benjamin West, who found him employment on the windows in St George's chapel at Windsor. In 1792 Phillips painted a view of Windsor Castle, and ere the two succeeding years had passed he exhibited the Death of Talbot, Earl of Shrewsbury, at the Battle of Castillon, Ruth and Naomi, Elijah restoring the Widow's Son, Cupid disarmed by Euphrosyne, and other pictures of that class. From the year 1796, however, he seems to have mainly confined himself to portrait-painting; and it was in this walk that he was destined to acquire his reputation as an artist. It was not long before he became the chosen painter of men of genius and talent, notwithstanding the rivalry of Hoppner, Owen, Jackson, and Lawrence; and he has left behind him portraits of nearly all the illustrious characters of his day. His works of this kind are distinguished by simplicity, careful and finished handling, and truth of portraiture, but in colour they are commonly cold and feeble. In 1804 he was elected associate and four years later member of the Royal Academy. In 1824 Phillips succeeded Fuseli as professor of painting to the Royal Academy, an office which he held till 1832. During this period he delivered ten *Lectures on the History and Principles of Painting*, which were published in 1833. He likewise wrote a large number of the articles on the fine arts in Rees's *Cyclopædia*. He died on the 20th of April 1845.

PHILLIPS, WILLIAM (1775-1838), an able mineralogist and geologist, who did much to foster in Britain the study of the sciences to which he was devoted, was born in May 1775. His *Outline of Mineralogy and Geology* was published in 1815 and passed through several editions. His *Introduction to the Knowledge of Mineralogy*, published in 1816, was for upwards of forty years one of the standard text-books in that science. Successive editions of it were brought out under different editors after his death. It was specially distinguished by its elaborate crystallographic details, based upon measurements with Wollaston's reflecting goniometer. But it is chiefly the services rendered by Phillips to the science of geology, then in its infancy, that entitle his name to grateful recollection. In addition to the first work above-named, he published in 1818 a most useful digest of English geology, under the title of *A Selection of Facts, from the best Authorities, arranged so as to form an Outline of the Geology of England and Wales*. This little volume contained a geological map of the country, based on that of W. Smith and some horizontal sections. Its importance in geological literature is to be found mainly in the fact that it formed the foundation of the larger work undertaken by Phillips in conjunction with W. Conybeare, of which only the first part was published, entitled *Outlines of the Geology of England and Wales; and comparative Views of the Structure of Foreign Countries* (1822). This volume made an era in geology. As a model of careful original observation, of judicious compilation, of succinct description, and of luminous arrangement it has been of the utmost service in the development of geology in Britain. Phillips was a member of the Society of Friends. He was a Fellow of the Royal, Geological, and other learned societies. He died in 1828.

PHILO, often called ΦΙΛΟ ΤΟΥΤΟΣ, Jewish philosopher, appears to have spent his whole life at Alexandria, where he was probably born c. 20-10 B.C. His brother Alexander was alabarch or arabarch (that is, probably, chief farmer of taxes on the Arabic side of the Nile), from which it may be concluded that the family was influential and wealthy (Jos., *Ant.*, xviii. 8, 1). Jerome's statement (*De Vir. Ill.*, 11) that he was of priestly race is confirmed by no older authority. The only event of his life which can be exactly dated belongs to 40 A.D., when Philo, then a man of advanced years, went from Alexandria to Rome,

at the head of a Jewish embassy, to persuade the emperor Caius to abstain from claiming divine honour of the Jews. Of this embassy Philo has left a full and vivid account (*De Legatione ad Caium*). Various fathers and theologians of the church state that in the time of Claudius he met St Peter in Rome;<sup>1</sup> but this legend has no historic value, and probably arose because the book *De vita contemplativa*, falsely ascribed to Philo, in which Eusebius already recognized a glorification of Christian monasticism, seemed to indicate a disposition towards Christianity.

Though we know so little of Philo's own life, his numerous extant writings give the fullest information as to his views of the universe and of life, and his religious and scientific aims, and so enable us adequately to estimate his position and importance in the history of thought. He is quite the most important representative of Hellenistic Judaism, and his writings give us the clearest view of what this development of Judaism was and aimed at. Since the time of Alexander many Jews had been led to settle beyond Palestine either with commercial objects or attracted by the privileges conferred by the diadochi on the inhabitants of the cities they founded. In the great towns of Syria, Asia Minor, and Egypt there were Jewish communities many thousands strong, but the Jews were most numerous in Alexandria, where from its first foundation they formed a considerable part of the population. The development of Judaism in the diaspora differed in important points from that in Palestine, where, since the successful opposition of the Maccabees to the Hellenization which Antiochus Epiphanes had sought to carry through by force, the attitude of the nation to Greek culture had been essentially negative. In the diaspora, on the other hand, the Jews had been deeply influenced by the Greeks; they soon more or less forgot their Semitic mother-tongue, and with the language of Hellas they appropriated much of Hellenic culture. They were deeply impressed by that irresistible force which was blending all races and nations into one great cosmopolitan unity, and so the Jews too on their dispersion became in speech and nationality Greeks, or rather "Hellenists." Now the distinguishing character of Hellenism is not the absolute disappearance of the Oriental civilizations before that of Greece, but the combination of the two with a preponderance of the Greek element. So it was with the Jews, but in their case the old religion had much more persistence than in other Hellenistic circles, though in other respects they too yielded to the superior force of Greek civilization. This we must hold to have been the case not only in Alexandria but throughout the diaspora from the commencement of the Hellenistic period down to the later Roman empire. It was only after ancient civilization gave way before the barbarian immigrations and the rising force of Christianity that rabbinism became supreme even among the Jews of the diaspora. This Hellenistic-Judaic phase of culture is sometimes called "Alexandrian," and the expression is justifiable if it only means that in Alexandria it attained its highest development and flourished most. For here the Jews began to busy themselves with Greek literature even under their clement rulers, the first Ptolemies, and here the law and other Scriptures were first translated into Greek; here the process of fusion began earliest and proceeded with greatest rapidity; here, therefore, also the Jews first engaged in a scientific study of Greek philosophy and transplanted that philosophy to the soil of Judaism. We read of a Jewish philosopher Aristobolus in the time of Ptolemy VI. Philometor, in the middle of the 2d century B.C., of whose philosophical commentary on the Pentateuch fragments

<sup>1</sup> Euseb., *H. E.*, li. 17, 1; Jer., *ut supra*; Phot., *Bibl.*, Cod. 105; Buid., s. v. "Φιλωπ."

have been preserved by Clement of Alexandria and Eusebius. So far as we can judge from these, his aim was to put upon the sacred text a sense which should appeal even to Greek readers, and in particular to get rid of all anthropomorphic utterances about God. Eusebius regards him as a Peripatetic. We may suppose that this philosophical line of thought had its representatives in Alexandria between the times of Aristobolus and Philo, but we are not acquainted with the names of any such. Philo certainly, to judge by his historical influence, was the greatest of all these Jewish philosophers, and in his case we can follow in detail the methods by which Greek culture was harmonized with Jewish faith. On one side he is quite a Greek, on the other quite a Jew. His language is formed on the best classical models, especially Plato. He knows and often cites the great Greek poets, particularly Homer and the tragedians, but his chief studies had been in Greek philosophy, and he speaks of Heraclitus, Plato, the Stoics, and the Pythagoreans in terms of the highest veneration. He had appropriated their doctrines so completely that he must himself be reckoned among the great philosophers; his system was eclectic, but the borrowed elements are combined into a new unity with so much originality that at the same time he may fairly be regarded as representing a philosophy of his own, which has for its characteristic feature the constant prominence of a fundamental religious idea. Philo's closest affinities are to Plato, the later Pythagoreans, and the Stoics.<sup>2</sup> Yet in all this Philo remained a Jew, and a great part of his writings is expressly directed to recommend Judaism to the respect and, if possible, the acceptance of the Greek. He was not a stranger to the specifically Jewish culture that prevailed in Palestine; in Hebrew he was not proficient, but the numerous etymologies he gives show that he had made some study of that language.<sup>3</sup> His method of exegesis is in point of form identical with that of a Palestinian scribe, and in point of matter coincidences are not absolutely rare.<sup>4</sup> But above all his whole work proves on every page that he felt himself to be throughly a Jew, and desired to be nothing else. Jewish "philosophy" is to him the true and highest wisdom; the knowledge of God and of things divine and human which is contained in the Mosaic Scriptures is to him the deepest and the purest.

If now we ask wherein Philo's Judaism consisted, we must answer that it lies mainly in the formal claim that the Jewish people, in virtue of the divine revelation given to Moses, possesses the true knowledge in things religious. Thoroughly Jewish is his recognition that the Mosaic Scriptures of the Pentateuch are of absolute divine authority, and that everything they contain is valuable and significant because divinely revealed. The other Jewish Scriptures are also recognized as prophetic, i. e., as the writings of inspired men, but he does not place them on the same line with the law, and he quotes them so seldom that we cannot determine the compass of his canon. The decisive and normative authority is to him the "laws" of Moses, and this not only in the sense that everything they contain is true but that all truth is contained in them. Everything that is right and good is in

<sup>2</sup> The fathers of the church have specially noticed his Platonism and Pythagoreanism; an old proverb even says, with some exaggeration,  $\delta$  Ιδαίως φιλοσοφῆσαι ἢ Φίλων πλεονεξῆσαι (Jerome, Photius, and Buid., *ut supra*). Clement of Alexandria directly calls him a Pythagorean. Eusebius (*H. E.*, li. 4, 3) observes both tendencies. Recent writers, especially Zeller, lay weight also on his Stoic affinities, and with reason for the elements which he borrows from Stoicism are as numerous and important as those derived from the other two schools.

<sup>3</sup> See the list of these in Vallarsi's edition of Jerome (*lib.* 731-74), and compare Siegfried, "Philonische Studien," in *Morze's Archiv*, 143-163 (1872).

<sup>4</sup> See Siegfried, *Philo*, pp. 142-159.

doctrines of the Greek philosophers had already been quite as well, or even better, taught by Moses. Thus, since Philo had been deeply influenced by the teachings of Greek philosophy, he actually finds in the Pentateuch everything which he had learned from the Greeks. From these premises he assumes as requiring no proof that the Greek philosophers must in some way have drawn from Moses,—a view indeed which is already expressed by Aristobolus. To carry out these presuppositions called for an exegetical method which seems very strange to us, that, namely, of the allegorical interpretation of Scripture. The allegorical method had been practised before Philo's day in the rabbinical schools of Palestine, and he himself expressly refers to its use by his predecessors, nor does he feel that any further justification is requisite. With its aid he discovers indications of the profoundest doctrines of philosophy in the simplest stories of the Pentateuch.<sup>1</sup>

This merely formal principle of the absolute authority of Moses is really the one point in which Philo still holds to genuinely Jewish conceptions. In the whole substance of his philosophy the Jewish point of view is more or less completely modified—sometimes almost extinguished—by what he has learned from the Greeks. Comparatively speaking, he is most truly a Jew in his conception of God. The doctrine of monotheism, the stress laid on the absolute majesty and sovereignty of God above the world, the principle that He is to be worshipped without images, are all points in which Philo justly feels his superiority as a Jew over popular heathenism. But only over popular heathenism, for the Greek philosophers had long since arrived at least at a theoretical monotheism, and their influence on Philo is nowhere more strongly seen than in the detailed development of his doctrine of God. The specifically Jewish (i.e., particularistic) conception of the election of Israel, the obligation of the Mosaic law, the future glory of the chosen nation, have almost disappeared; he is really a cosmopolitan and praises the Mosaic law just because he deems it cosmopolitan. The true sage who follows the law of Moses is the citizen not of a particular state but of the world. A certain attachment which Philo still manifests to the particularistic conceptions of his race is meant only "in majorem Judæorum gloriam." The Jewish people has received a certain preference from God, but only because it has the most virtuous ancestry and is itself distinguished for virtue. The Mosaic law is binding, but only because it is the most righteous, humane, and rational of laws, and even its outward ceremonies always disclose rational ideas and aims. And lastly, outward prosperity is promised to the pious, even on earth, but the promise belongs to all who turn from idols to the true God. Thus, in the whole substance of his view of the universe, Philo occupies the standpoint of Greek philosophy rather than of national Judaism, and his philosophy of the world and of life can be completely set forth without any reference to conceptions specifically Jewish.

His doctrine of God starts from the idea that God is Being absolutely bare of quality. All quality in finite beings has limitation, and no limitation can be predicated of God, who is eternal, unchangeable, simple substance, free, self-sufficient, better than the good and the beautiful. To predicate any quality (*ποιότης*) of God would be to reduce Him to the sphere of finite existence. Of Him we can say only that He is, not *what* He is, and such purely negative predications as to His being appear to Philo, as to the later Pythagoreans and the Neo-Platonists, the only way of securing His absolute elevation above the world. At bottom, no doubt, the meaning of these negations is that God is the most perfect being; and so, con-

versely, we are told that God contains all perfection, that He fills and encompasses all things with His being.

A consistent application of Philo's abstract conception of God would exclude the possibility of any active relation of God to the world, and therefore of religion, for a Being absolutely without quality and movement cannot be conceived as actively concerned with the multiplicity of individual things. And so in fact Philo does teach that the absolute perfection, purity, and loftiness of God would be violated by direct contact with imperfect, impure, and finite things. But the possibility of a connexion between God and the world is reached through a distinction which forms the most important point in his theology and cosmology; the proper being of God is distinguished from the infinite multiplicity of divine Ideas or Forces: God himself is without quality, but He disposes of an infinite variety of divine Forces, through whose mediation an active relation of God to the world is brought about. In the details of his teaching as to these mediating entities Philo is guided partly by Plato and partly by the Stoics, but at the same time he makes use of the concrete religious conceptions of heathenism and Judaism. Following Plato, he first calls them Ideas or ideal patterns of all things; they are thoughts of God, yet possess a real existence, and were produced before the creation of the sensible world, of which they are the types. But, in distinction from Plato, Philo's ideas are at the same time efficient causes or Forces (*δυνάμεις*), which bring unformed matter into order conformably to the patterns within themselves, and are in fact the media of all God's activity in the world. This modification of the Platonic Ideas is due to Stoic influence, which appears also when Philo gives to the *ιδέαι* or *δυνάμεις* the name of *λόγοι*, i.e., operative ideas,—parts, as it were, of the operative Reason. For, when Philo calls his mediating entities *λόγοι*, the sense designed is analogous to that of the Stoics when they call God the *Logos*, i.e., the Reason which operates in the world. But at the same time Philo maintains that the divine Forces are identical with the "demons" of the Greeks, and the "angels" of the Jews, i.e., servants and messengers of God by means of which He communicates with the finite world. All this shows how uncertain was Philo's conception of the nature of these mediating Forces. On the one hand, they are nothing else than Ideas of individual things conceived in the mind of God, and as such ought to have no other reality than that of immanent existence in God, and so Philo says expressly that the totality of Ideas, the *κόσμος νοητός*, is simply the Reason of God as Creator (*Θεοῦ λόγος ἢ δὴ κοσμοποιῶντος*). Yet, on the other hand, they are represented as hypostases distinct from God, individual entities existing independently and apart from Him. This vacillation, however, as Zeller and other recent writers have justly remarked, is necessarily involved in Philo's premises, for, on the one hand, it is God who works in the world through His Ideas, and therefore they must be identical with God; but, on the other hand, God is not to come into direct contact with the world, and therefore the Forces through which He works must be distinct from Him. The same inevitable amphiboly dominates in what is taught as to the supreme Idea or *Logos*. Philo regards all individual Ideas as comprehended in one highest and most general Idea or Force—the unity of the individual Ideas—which he calls the *Logos* or Reason of God, and which is again regarded as operative Reason. The *Logos*, therefore, is the highest mediator between God and the world, the firstborn son of God, the archangel who is the vehicle of all revelation, and the high priest who stands before God on behalf of the world. Through him the world was created, and so he is identified with the creative Word of God in Genesis (the Greek *λόγος* meaning both "reason" and "word").

<sup>1</sup> For details, see Gfrörer, *Philo*, l. 68 sq.; Zeller, *Phil. der Gr.*, 3d ed., vol. III, pt. II, 346-352; Siegfried, *Philo*, 160 sq.

and "word"). Here again, we see, the philosopher is unable to escape from the difficulty that the Logos is at once the immanent Reason of God, and yet also an hypostasis standing between God and the world. The whole doctrine of this mediatorial hypostasis is a strange intertwining of very dissimilar threads; on one side the way was prepared for it by the older Jewish distinction between the Wisdom of God and God Himself, of which we find the beginnings—even in the Old Testament (Job xxviii. 12 sq.; Prov. viii., ix.), and the fuller development in the books of Ecclesiasticus and Wisdom, the latter of which comes very near to Philo's ideas if we substitute for the term "wisdom" that of (divine) "Reason." In Greek philosophy, again, Philo, as we have seen, chiefly follows the Platonic doctrines of Ideas and the Soul of the World, and the Stoic doctrine of God as the λόγος or Reason operative in the world. In its Stoic form the latter doctrine was pantheistic, but Philo could adapt it to his purpose simply by drawing a sharper distinction between the Logos and the world.

Like his doctrine of God, Philo's doctrine of the world and creation rests on the presupposition of an absolute metaphysical contrast between God and the world. The world can be ascribed to God only in so far as it is a cosmos or orderly world; its material substratum is not even indirectly referable to God. Matter (ὕλη, or, as the Stoics said, οὐσία) is a second principle, but in itself an empty one, its essence being a mere negation of all true being. It is a lifeless, unmoved, shapeless mass, out of which God formed the actual world by means of the Logos and divine Forces. Strictly speaking, the world is only formed, not created, since matter did not originate with God.

Philo's doctrine of man is also strictly dualistic, and is mainly derived from Plato. Man is a twofold being, with a higher and a lower origin. Of the pure souls which fill airy space, those nearest the earth are attracted by the sensible and descend into sensible bodies; these souls are the Godward side of man. But on his other side man is a creature of sense, and so has in him a fountain of sin and all evil. The body, therefore, is a prison, a coffin, or a grave for the soul which seeks to rise again to God. From this anthropology the principles of Philo's ethics are derived, its highest maxim necessarily being deliverance from the world of sense and the mortification of all the impulses of sense. In carrying out this thought, as in many other details of his ethical teaching, Philo closely follows the Stoics. But he is separated from Stoical ethics by his strong religious interests, which carry him to very different views of the means and aim of ethical development. The Stoics cast man upon his own resources; Philo points him to the assistance of God, without whom man, a captive to sense, could never raise himself to walk in the ways of true wisdom and virtue. And as moral effort can bear fruit only with God's help, so too God Himself is the goal of that effort. Even in this life the truly wise and virtuous is lifted above his sensible existence, and enjoys in ecstasy the vision of God, his own consciousness sinking and disappearing in the divine light. Beyond this ecstasy there lies but one further step, viz., entire liberation from the body of sense and the return of the soul to its original condition; it came from God and must rise to Him again. But natural death brings this consummation only to those who, while they lived on earth, kept themselves free from attachment to the things of sense; all others must at death pass into another body; transmigration of souls is in fact the necessary consequence of Philo's premises, though he seldom speaks of it expressly.

Philo's literary labours have a twofold object, being directed either to expound the true sense of the Mosaic law, &c., the philosophy which we have just described, to his Jewish brethren, or to convince

heathen readers of the excellence, the supreme purity and truth, of the Jewish religion whose holy records contain the deepest and most perfect philosophy, the best and most humane legislation. Thus as a literary figure Philo, in conformity with his education and views of life, stands between the Greeks and the Jews, seeking to gain the Jews for Hellenism and the Greeks for Judaism, yet always taking it for granted that his standpoint really is Jewish, and just on that account truly philosophical and cosmopolitan.

The titles of the numerous extant writings of Philo present at first sight a most confusing multiplicity. More than three-fourths of them, however, are really mere sections of a small number of larger works. Three such great works on the Pentateuch can be distinguished.

(I.) The smallest of these is the *Ἐπιφάνεια καὶ Λόγος* (*Questions et solutions*), a short exposition of Genesis and Exodus, in the form of question and answer. The work is cited under this title by Eusebius (*H. E.*, ii. 18, l. 5; *Præp. Ev.*, vii. 15), and by later writers, but the Greek text is now almost wholly lost, and only about one-half preserved in an Armenian translation. Genesis seems to have occupied six books.<sup>1</sup> Eusebius tells us that Exodus filled five books. In the Armenian translation, first published by the learned Mechtarist Aucher in 1826, are preserved four books on Genesis and two on Exodus, but with lacuna. A Latin fragment, about half of the fourth book on Genesis (*Phil. Jud. CIL. quæst. . . super Gen.*), was first printed at Paris in 1520. Of the Greek we have numerous but short fragments in various Florilegia.<sup>2</sup> The interpretations in this work are partly literal and partly allegorical.

(II.) Philo's most important work is the *Ἠθικὴ ἐπιφάνεια* (*Euseb.*, *H. E.*, ii. 18, l. 1; *Phot.*, *Bibk.*, Cod. 103), a vast and copious allegorical commentary on Genesis, dealing with chap. ii.-iv., verse by verse, and with select passages in the later chapters. The readers in view are mainly Jews, for the form is modelled on the rabbinic Midrash. The main idea is that the characters which appear in Genesis are properly allegories of states of the soul (*ἡρώτων τῆς ψυχῆς*). All persons and actions being interpreted in this sense, the work as a whole is a very extensive body of psychology and ethics. It begins with Gen. ii. 1, for the *De sensu opificio*, which treats of the creation according to Gen. i., ii., does not belong to this series of allegorical commentaries, but deals with the actual history of creation, and that under a quite different literary form. With this exception, however, the *Ἠθικὴ ἀλληγορία* includes all the treatises in the first volume of Mangey's edition, viz. —

*Ἠθικὴ ἐπιφάνεια ἀλληγορία πῶτον τῶν μετὰ τὴν ἑξήγησιν* (*Legum ab antiquis, lib. I.*, M. I. 48-65), on Gen. ii. 1-17. (2) *Ἠθικ. ἐπιφ. ἀλλ. δεύτερη* (*Leg. alt.*, lib. II., M. I. 66-80) on Gen. ii. 18-iii. 1a. (3) *Ἠθικ. ἐπιφ. ἀλλ. τρίτη* (*Leg. alt.*, lib. II., M. I. 87-107), on Gen. iii. 8b-19. The commentaries on Gen. iii. 10-24, 30-25 are lost. (4) *Ἠθικὴ τῶν χειροποιήτων καὶ τῆς φύσεως ἡμοιωτικὴ καὶ τῶν ἐπιθετικῶν πῶτον ἐξ ἀσθητικῶν Κἀδ* (*De cherubin et hominis gladio*, M. I. 128-167), on Gen. iii. 24 and iv. 1. (5) *Ἠθικὴ τῶν ἡεροποιήτων "Δεβὴ" καὶ Κἀδ* (*De sacrificiis Abelis et Cain*, M. I. 168-190), on Gen. iv. 2-4. The commentaries on Gen. iv. 5-7 are lost. (6) *Ἠθικὴ τῶν τῶν χειροποιήτων φιλῶν ἐπιθετικῶν* (*Quod dicitur potiori iudicari solent*, M. I. 20-225), on Gen. iv. 8-16. (7) *Ἠθικὴ τῶν ἀσθητικῶν Κἀδ ἑγγύθεν καὶ μετὰ τὴν ἑξήγησιν* (*De potioribus Cain*, &c., M. I. 226-261), on Gen. iv. 14-25. This book, which is wanting in editions prior to Mangey's, is inaccurately cited by him, but much more correctly by Tischendorf *Biblen*, pp. 24-142. One of the preceding is mentioned by its special title by Euseb., *H. E.*, ii. 18, who cites all that follow by their titles. The reason must be that all up to the point, and no further, are included by him in the *Ἠθικὴ ἐπιφάνεια ἀλληγορία*; agreeing with this we find that these and these only are cited under that general title in the Florilegia, especially the so-called *Johnnes Monachus* (inserted in Mangey's notes before each book). We may therefore conclude with confidence that Philo published the continuous commentaries on Gen. ii.-iv. under the title *Allegoriae de Sacris Legibus*, and the following commentaries on select passages under special titles, though the identity of literary character entitles us to regard the latter as part of the same great literary plan with the former. (8) *Ἠθικὴ γένεσιν* (*De significationibus*, M. I. 262-272), on Gen. vi. 1-4. (9) *Ὅτι ἐργον τὸ θεῖον* (*Quod Deus sit immutabilis*, M. I. 273-290), on Gen. vi. 4-11. (10) *Ἠθικὴ γένεσιν* (*De agnitionibus*, M. I. 300-326), on Gen. ix. 20a. (11) *Ἠθικὴ φυτόποιίας* *Ἠθικὴ τῶν δέντρων* (*De plantationibus Nos*, M. I. 326-365), on Gen. i. 20b. (12) *Ἠθικὴ πόθου* (*De sobrietate*, M. I. 367-391), on Gen. ix. 21; the introduction shows that this book was preceded by another which put together the views of the philosophers about drunkenness. (13) *Ἠθικὴ τῶν ἐξέστησιν* *Ἠθικὴ ἀσθητικῶν*, M. I. 392-406), on Gen. ix. 24. (14) *Ἠθικὴ ἐργασίας* *ὁμοιωτικῶν* (*De consuetudinibus Naturarum*, M. I. 404-428), on Gen. xi. 1-9. (15) *Ἠθικὴ ἀσθητικῶν* (*De migrationibus Abrahami*, M. I. 429-472), on Gen. xi. 1-4. (16) *Ἠθικὴ τῶν τῶν τῶν θεῶν προφητικῶν κληρονομῶν* (*Quæ sunt divinationes hærentes ad*, M. I. 473-519), on Gen. xv. 1-18. (17) *Ἠθικὴ εἰς τὰ προφαιδόμενα οὐδὴν* (*De congruis querendis eruditionis causis*, M. I. 519-545), on Gen. xvi. 1-4. (18) *Ἠθικὴ φυτόποιίας* (*De profugis*, M. I. 546-577), on Gen. xvi. 6-14. (19) *Ἠθικὴ τῶν μεταμορφώσεων καὶ ἐξ ἑνὸς μεταμορφώσεων* (*De mutationibus nominum*, M. I. 578-619), on Gen. xvii. 1-22; in this work Philo mentions that he had

<sup>1</sup> See, especially *Mal. Script. vet. nov. coll.*, vol. vii. pt. i. pp. 100, 106, 108.

<sup>2</sup> See Opp., ed. Mangey, ii. 648-680; *Mal. op. vet.*, vol. vii. pt. i. 96 sq.; *Euseb., Præp. Ev.*, vii. 12. A fragment on the cherubim, Exod. xxv. 18, has been published by *Mal. Class. Antiq.*, iv. 430 sq. by Grossmann (1856), and by Tischendorf (p. 144 sq.).



written two books, now wholly lost, *Περὶ διαθηκῶν* (M. I. 686). (30) *Περὶ τοῦ θεομύστου εἰς τοὺς εὐδαίμονας* (De somniis, lib. I., M. I. 690-698), on the dreams of Jacob, Gen. xxxvii. and xxxd. (31) Book II. of the same (M. I. 696-699), on the dreams of Joseph, the chief butler, the chief baker, and Pharaoh, Gen. xxxvii. and xl., xli. Eusebius makes Philo the author of five books on dreams; three, therefore, are lost.

(III.) A work of a very different kind is the group of writings which we may call "An Exposition of the Mosaic law for Gentiles," which, in spite of their very various contents, present on nearer examination indubitable marks of close connexion. In them Philo seeks to give an orderly view of the chief points of the Mosaic legislation in the Pentateuch, and to recommend it as valuable to Gentile readers. The method of exposition is somewhat more popular than in the allegorical commentaries, for, though that method of interpretation is not wholly excluded, the main object is to give such a view of the legislation as Philo accepted as historical. This work has three main divisions: (a) an Account of the Creation (*ἀσμεναια*), which Moses put first, to show that his legislation was conformed to the will of nature, and that therefore those who followed it were true cosmopolitans; (b) the Biographies of the Virtuous,—being, so to speak, the living unwritten laws which, unlike written laws, present the general types of moral conduct; (c) Legislation Proper, in two subdivisions—(α) the ten principal chapters of the law, (β) the special laws belonging to each of these ten. An appendix adds a view of such laws as do not fall under the rubrics of the decalogue, arranged under the headings of certain cardinal virtues.

The treatises which belong to this work are the following. (1) *Περὶ τῆς Μωϋσέως κοσμοποιίας* (De mundi opificio, M. I. 1-42). This work does not fall within the number of the allegorical commentaries. On the other hand, the introduction to the treatise De Abrahamo makes clear its immediate connexion with the De mundi opificio. The position of the De mundi opificio at the head of the allegorical commentaries, which is at present usual in the editions, seems indeed to go back to a very early date, for even Eusebius cites a passage from it with the formula ἀπὸ τοῦ πρώτου τῶν εἰς τὸν νόμον (Præp. Ev., vii. 13 fin., ed. Gaisford). The group of the *Βίαι σοφῶν* is headed by (2) *Βίαι σοφῶν τῶν γὰρ ἀβραάμην γέλωθθῶτον ἢ περὶ νόμων ἀνθρώπων* [1], ἢ ἐστὶ περὶ Ἀβραάμ (De Abrahamo, M. II. 1-40). Abraham is here set forth as the type of ἀδικακλή ἀρετή, i.e., of virtue as a thing learned. This biography of Abraham was followed by that of Isaac as a type of φρονή ἀρετή, i.e., of innate or natural virtue, which in turn was succeeded by that of Jacob as representing ἀσχυρή ἀρετή, i.e., virtue acquired by practice; but both these are now lost. Hence in the editions the next treatise is (3) *Βίαι τοῦ κυρίου θεοῦ τῶν ἰσραήλ* (De Josepho, M. II. 41-79), where Joseph is taken as the pattern of the wise man in his civil relations. The Biographies of the Virtuous are followed by (4) *Περὶ τῶν θεῶν λογίων* & *κεφάλαια νόμων εἰς τὸν δεκάλογον* (De decalogis, M. II. 180-200) and (5) *Περὶ τῶν ἀναφορῶν μὲν καὶ εἰς νόμον εἰς τὴν συντάξιν κεφάλαια τῶν θεῶν λόγων* (De specialibus legibus; the unbridled title is given by Eusebius, H. E., II. 18, 5). Here under the rubrics of the ten commandments a systematic review of the special laws of the Mosaic economy is given; for example, under the first and second commandments (divine worship) a survey is taken of the entire legislation relating to priesthood and sacrifice; under the fourth (i.e., the Sabbath law, according to Philo's reckoning there is a survey of all the laws about fœces; under the fifth (adultery) an account of matrimonial law; and so on. According to Eusebius (H. E., II. 18, 6) the second book, which, as we have reached its entire, but in the editions have been perversely broken up into a considerable number of separate treatises. (a) The first book (on the first and second commandments) includes the following: De *εὐσεβείαις* (M. II. 210-215); De *μοναρχίαι*, lib. I. (II. 218-223); De *μοναρχίαι*, lib. II. (II. 223-225); De *πρεσβυτερίαις* (II. 225-227); De *εὐλαίαις* (II. 227-250); De *συνταξίαις*, or De *viciniis opificiis* (II. 251-254); De *σεραπείαις* (II. 254-259). (b) The second book (on the third, fourth, and fifth commandments, i.e., in perjury, Sabbath observance, and filial piety) is incomplete in Mangey (II. 270-298), the section De *εὐσεβείαις* (on the Sabbath and feasts in general) being imperfect, and that De *εὐλαίαις* *σεραπείαις* being entirely wanting. Next to a large extent made good the defect (De *εὐλαίαις* *σεραπείαις*, Milan, 1816), but Tischendorf was the first to edit the full text (Philonus, pp. 1-82). (c) The third book relates to the sixth and seventh commandments (adultery and murder; M. II. 299-324). (d) To the fourth book (relating to the last three commandments) almost all that is found in Mangey, II. 328-374, that is to say, not merely the tractates De *justitiis* (II. 344-348) and De *concupiscentiis* (II. 348-358), but also those De *justitiis* (II. 358-361) and De *orationis principibus* (II. 361-374). The last-named is, properly speaking, only a portion of the De *superstitione*, which, however, certainly belongs to the fourth book, of which the superscription expressly bears that it treats also *περὶ διακοσμήσεως*. With this tractate begins the appendix to the work De *specialibus legibus*, into which, under the rubric of *εὐσεβείαις*, the various laws are brought together as could not be dealt with under any of the decalogue rubrics. The continuation of this appendix forms a book by itself. (5) *Περὶ τῶν ἀρετῶν ἢ περὶ ἀβραάμ* and *φιλανθρωπίας καὶ μετάνοιας* (De fortitudine, M. II. 375-388); De *caritate*, II. 388-408; De *patientia*, II. 408-407. Finally, in less intimate connexion with this entire work is another treatise still to be mentioned, (7) *Περὶ ἀφ᾽ αὐτοῦ καὶ ἀντιπύλου* (De somniis a patre, M. II. 408-428) and *Περὶ ἀφ᾽ αὐτοῦ* (De somniis a matre, M. II. 428-457), two parts which constitute a single whole and deal with the promises and threatenings of the law.

(IV.) Besides the above-named three great works on the Pentateuch, Philo was the author of a number of isolated writings, of which the following have reached us either in their entirety or in fragments. (1) *Περὶ τῆς Μωϋσέως (Vita Moysi)*, lib. I.-III., M. II. 80-179). It is usual to group this, as being biographical in its character, with the *Βίαι σοφῶν*, and thus to incorporate it immediately after the De Josepho with the large work on the Mosaic legislation. But, as has been seen, the *Βίαι σοφῶν* are intended to represent the general types of morality, while Moses is by no means so dealt with but as a unique individual. All that can be said is

that the literary character of the *Vita Moysi* is the same as that of the larger work. As in the latter the Mosaic legislation, so in the former the activity of the legislator himself, is delineated for the benefit of Gentile readers. (2) *Περὶ τοῦ πάλαιου εὐδαίμονος εἰς ἀεθέρησιν* (Quod omnis probus liber, M. II. 445-470). In the introduction to this treatise reference is made to an earlier book which had for its theme the converse proposition. The complete work was still extant in the time of Eusebius (H. E., II. 18, 6): *Περὶ τοῦ δουλοῦ εἰς πάλαιον φάσμα ἢ ἐξ ἑστῶτος ἢ περὶ τοῦ πάλαιου εὐδαίμονος ἀεθέρησιν*. The genuineness of the writing now possessed by us is not undisputed; but see Lucian, *De Boetismis* (1881), pp. 13-23. (3) *Εἰς Ἐδάκων (Adversus Flaccum, M. II. 517-544)* and (4) *Περὶ ἀρετῶν καὶ πρεσβείας πρὸς Πάλλον* (De legatione ad Caium, M. II. 545-600). These two works have a very intimate connexion. In the first Philo relates how the Roman governor Flaccus in Alexandria, towards the beginning of the reign of Caligula, allowed the Alexandrian mob, without interference, to insult the Jews of that city in the grossest manner and even to persecute them to the shedding of blood. In the second he tells how the Jews had been subjected to still greater sufferings through the command of Caligula that divine honours should be everywhere accorded to him, and how the Jews of Alexandria in vain sought relief by a mission to Rome which was headed by Philo. But both together were only parts of a larger work, in five books, of which the first two and the last have perished. For it is clear from the introduction to the *Adversus Flaccum* that it had been preceded by another book in which the Jewish persecutions by Sejanus, under the reign of Tiberius, were spoken of, and the *Chronicon* of Eusebius (ed. Schoene, vol. II. pp. 150, 151) informs us that these persecutions of Sejanus were related in the second book of the work now under discussion. But from the conclusion of the *Legatio ad Caium*, which we still possess, we learn that it was also followed by another book which exhibited the *σαλευσῖς*, or change of Jewish fortunes for the better. Thus we make out five books in all,—the number actually given by Eusebius (H. E., II. 5, 1). (5) *Περὶ ἰσραήλ (De providentiis)*. This work has reached us only in an Armenian translation, which has been edited, with a Latin translation, by Ancher (see below). It is mentioned by its Greek title in Eusebius (H. E., II. 18, 6; Præp. Ev., vii. 30 fin., vii. 13 fin., ed. Gaisford). The Armenian text gives two books, but of these the first, if genuine at all, at any rate appears only in an abridged and somewhat revised state.<sup>1</sup> Eusebius (Præp. Ev., vii. 14) quotes from the second book to an extent that amounts to a series of excerpts from the whole. The short passage in Præp. Ev., vii. 21, is also taken from this book; and it appears that Eusebius knew nothing at all about the first. (6) *Ἀλλήλων ἢ περὶ τοῦ λόγου ἔχων τὸ Δαγία ἰδία* (De Alexandro et quod proprium rationem multa animalia habent; so Jerome, *De Vr. III.*, c. 11); the Greek title is given in Euseb., H. E., II. 18, 6. This also now exists only in an Armenian translation, which has been edited by Ancher. Two small Greek fragments occur in the *Florilegium* of Leontius and Johannes (Mai, *Scr. vet. nov. coll.*, vii. 1, pp. 99, 100a). (7) *Ἐπιθεσίαις*, a writing now known to us only through fragments preserved in Euseb., Præp. Ev., viii. 6, 7. The title, as Bernays<sup>2</sup> has shown, means "Counsels," "Recommendations," the reference being to such laws of the Jews as can be recommended also to non-Jewish readers. (8) *Περὶ ἰουδαίων*, a title met with in Euseb., H. E., II. 18, 6. The writing is no doubt the same as *Ἡ ἐπιτῆ ἰουδαίων ἀπολογία*, from which a quotation is given in Euseb., Præp. Ev., viii. 11. To this place also, perhaps, belongs the De *nobilitate* (M. II. 487-444), which treats of that true noblesse of wisdom in which the Jewish people also is not wanting.<sup>3</sup>

(V.) *Ἰσραήλιος* works ascribed to Philo. (1) *Περὶ βίαις θεομύστου ἢ ἱερῶν ἀρετῶν* (De vita contemplativa, M. II. 471-486). That the Therapeutic life here praised is that of Christian monks was seen by Euseb., H. E., II. 17 (who, however, accepted the book as Philo's), and the same view was long prevalent in the church.<sup>4</sup> But, if the Therapeutics are monks, the book cannot be genuine; see especially Lucian, *Die Therapeuten und ihre Stellung in der Gesch. der Askese*, Strasburg, 1879. There are, however, so many other objections to its genuineness that the book is now given up even by such as do not admit that the Therapeutics are monks. (2) *Περὶ ἀβραάμ* *νόμων* (De incorruptibilitate mundi, M. II. 487-516). Bernays, who first showed that the received text is disordered by misplacement of leaves (*Monast. Berl. Acad.*, 1868, p. 34 sq.), published a corrected text with German version in *Abh. Berl. Acad.*, 1876. An unfinished commentary of the same critic was posthumously published in the Berlin *Abhandlungen*, 1882. (3) *Περὶ νόμων* (De mundo, M. II. 601-624). That this collection of extracts from Philo, and especially from the De *incor. mundi*, is spurious has been long recognised. (4) Two orations, *De Somponis* and *De Jona*, pub-

1 See Diels, *Dionysographi Græci*, 1876, pp. 1-4; Keller, *Phil. d. Gr.*, III. 2, p. 340 (2d ed.).  
2 *Monast. d. Berl. Acad.* (1878), pp. 590-600.  
3 This conjecture is DeWine's, *Theol. Stud.*, c. 21-2 (1885), pp. 900, 1067.  
4 So still Montfaucon, the learned notes to whose French translation are still valuable (Paris, 1760).  
5 Nicetas in *Scr. Patris*, Lezardus, 1828, p. 26 sq.; Krieger, *Goldblatt*, II. 440-444; Weingarten, "Mikchiam," in Herzog-Platz, II. 2, x.

lished from the Armenian by Aucher in 1826, are generally held to be spurious.<sup>1</sup> (5) The lexicon of Hebrew proper names with Greek interpretations (*Ἑβραϊστικὰ ὀνόματα ἑλληνιστῶν*), which Origen completed by adding the New Testament names, and which Jerome rewrote, was often ascribed to Philo. It appears from ancient testimonies that it bore no author's name, so that Philo's part in it is at least very problematical; nor does its original form seem to be extant (see Orig., *Comm. in Joann.*, vol. ii. c. 27; Euseb., *H. E.*, ii. 18, 7; Jerome in the preface to his recension of the book). Various Greek and Latin recensions are given by Vallart and in Lagarde's *Onomastica sacra*, 1870; see also on this class of literature as a whole Fabricius-Harles, *Bib. Gr.*, iv. 742 sq., vi. 199 sq., vii. 226 sq. (6) On a Latin work, *De biblicis antiquitatibus*, ascribed to Philo, see Fabr.-Harl., iv. 743. (7) For the pseudo-Philonian *Breviarium temporum*, a forgery of Annianus of Vitarbo, see *ibid.* (8) The book *On Virtue*, published as Philo's by Mai (*Phil. Jud. de virt. ejusque partibus*, 1816), is a work of Gemistus Pletho.

*Religion*.—The first, very imperfect, edition of the Greek text of Philo is by Turnebus (Paris, 1552). Some additional pieces were given by Hoeschel (Frankfurt, 1687; Augsburg, 1614). Other editions are those of Geneva, 1613; Paris, 1640; Frankfurt, 1691 (a page-for-page reprint of the Paris edition); but the best is still that of Mangey (2 vols., London, 1742), which alone is based on a number of MSS. and gives a critical apparatus. Pfeiffer's unfinished edition, vols. I.-v., appeared at Erlangen in 1785-95, 2d ed. 1820. An important supplement to Mangey is given by Aucher's publications from the Armenian—*Phil. Jud. sermoses tres inediti*, Venice, 1522. *Phil. Jud. paraphrasen*, Arnhem, Venice, 1828. The Greek pieces newly published since Mangey are less extensive. The editions by Mai, Grossmann, and Tischendorf have been already noticed. Aucher's publications and Mai's of 1818 are contained in the convenient edition of Richter (Leipzig, 1828-50) and in the Tauchnitz stereotype edition (1851-53). Of editions of particular works, J. G. Müller's *De Judo Philo Buch e. d. Welterschöpfung* (Berlin, 1841), with commentary, claims special notice. Compare further for the editions and versions, Purst, *Bibl. Jud.*, v. Grasse, *Trésor de l'Israël sur le principe*, v. 269-271 (1864); and Eng. tr. by Yonge, 4 vols., London, 1854-58.

*Literature*.—(A.) On Philo's writings in general. Fabricius-Harles, *Bib. Gr.*, iv. 741-750. On the order of Philo's works, Gröner, *Philo und die alexandrinische Theosophie*, I. (1831); Dahne, in *Stud. und Krit.*, 1833, p. 984 sq.; Grossmann, *De Phil. Jud. operum constantia serie et ordine chronol.*, pts. I., II., Leipzig, 1841-42. On the text, Crusier, in *Stud. und Krit.*, 1839, p. 3 sq. J. G. Müller, *Textkritik der Schr. des Judo Philo*, Basel, 1859, reprinted in his edition of the *Welterschöpfung*, 1841. On Philo's language, method, and influence on posterity, see Siegfried, *Philo von Alex. als Ausleger des A. T.*, Jena, 1876. On his knowledge of Palestinian legal tradition, B. Ritter, *Philo und die Halacha*, Leipzig, 1879. (B.) On Philo's teaching. Gröner, *op. cit.*; Dahne, *Geach. Darstellung der jud.-alex. Religionsphilosophie*, Halle, 1834; Zeller, *Phil. d. Griechen*, pt. III, sect. II. (3d ed., 1881).—This is on the whole the best general sketch; Gröner and Dahne give fuller material. On special points, see Kefertstein, *Philo's Lehre von dem göttlichen Mittelwasser*, Leipzig, 1846; Heineze, *Lehre vom Logos*, 1872; Boulier, *La doctrine de Logos chez Philon*, Turin, 1874. (Z. B.)\*

**PHILO.** A Jewish Hellenist of this name is the author of an epic poem in Greek hexameters on the History of Jerusalem, and lived at an earlier date than the philosopher, Alexander Polyhistor quoting several passages of his book about 80-60 B.C. From Alexander Eusebius derives these extracts from the poem (*Præp. Ev.*, ix. 20, 24, 37). This is probably the Philo who is mentioned by Clemens Alexandrinus (*Strom.*, i. 21, 141) and Josephus (*C. Ap.*, i. 23). See Philippon's work on the Jewish poets Ezechiel and Philo (1830) and Müller, *Fr. Hist. Gr.*, iii. 213 sq.

**PHILO BYBLIUS**, s. c., Philo of Byblus (Gabal, Jubeil), was born, according to Suidas, in 42 A.D., and lived into the reign of Hadrian, about which he wrote a book now wholly lost. He was a grammarian by profession and author of many books, of which those oftenest cited are: (1) a work *About Cities and the Famous Men they have produced*, which was epitomized by Serenus, and (2) *Phœnician History*. Of the latter there are very considerable fragments, chiefly preserved by Eusebius in the *Præparatio Evangelica*, and presenting a Euhemeristic *réchauffé* of Phœnician theology and mythology which is represented as translated from the Phœnician of Sanchuniathon. The fragments of Philo are collected in Müller, *Fr. Hist. Gr.*, iii. 560 sq. To the literature there cited add Ewald's essay in the *Abhandlungen of the Royal Society of Göttingen*, vol. v. (1853); Renan's in *Mém. Acad. des Inscriptions*, vol. xxxiii. (1858); and Baudissin, *Studien sur semitischen Religionsgeschichte*, i. 3 sq.

**PHILO OF BYZANTIUM**, author of a treatise on mechanics, of which only two books now remain, flourished in the 2d or 3d century A.D. The extant books, which refer to machines used in war and to siege works, are

edited with a German translation in Köchly and Rüstow's *Griechische Kriegskunstler*, vol. i. (Leipzig, 1853).

For a list of other Philos, see Fabricius, *Bib. Græc.*, iv. p. 750 sq., ed. Harl.

**PHILOLAUS**, next to Archytas the most illustrious of the Pythagorean philosophers, was born at Tarentum or, according to Diogenes Laertius, at Crotona.<sup>2</sup> He is said to have been intimate with Democritus, and was probably one of his teachers. After the death of Pythagoras great dissensions prevailed in the cities of lower Italy, which were allayed only after the lapse of many years through the intervention of the Achæans. According to some accounts Philolaus was obliged to flee, and over his escape to his youthful energy. He took refuge first in Lucania, then in Greece; he lived at Thebes, where he had for pupils Simmias and Cebes, who subsequently, being still young men (*νεανίσκοι*), were present at the death of Socrates. Prior to this Philolaus had left Thebes and returned to Italy, where he was the teacher of Archytas. Pythagoras published nothing, nor did the other early Pythagoreans; the members of the brotherhood, more or less, referred their discoveries back to their master, hence many doctrines have been attributed to Pythagoras which were first propounded later in the school. He entered deeply into the number-theory, which constituted the distinctive feature of the Pythagorean philosophy, and in particular dwelt on the properties inherent in the *des*—the sum of the first four numbers, consequently the fourth triangular number, the tetractys—which he held great, all-powerful, and all-producing. The discovery of the regular solids is attributed to Pythagoras by Eudæus, and Empedocles is stated to have been the first who maintained that there were four elements. Philolaus, connecting these ideas, held that the elementary natural bodies depended on their form, and assigned the tetrahedron to fire, the octahedron to air, the icosahedron to water, and the cube to earth; the dodecahedron assigned to a fifth element, æther, or, as some think, the universe. This theory indicates considerable knowledge of geometry on the part of its author; it gave moreover, a great impulse to the study of that science and many important results were arrived at, so that Aristæus, who lived before Euclid, was able to write a book on the comparison of the five regular solids.

Philolaus was the first to propound the doctrine of the motion of the earth; some, however, attribute this doctrine to Pythagoras, but there is no evidence in support of this view. Philolaus supposed that the sphere of the fixed stars, the five planets, the sun, moon, and earth, all revolved round the central fire, which he called the hearth of the universe, the house of Zeus, and the mother of the gods, but as these made up only nine revolving bodies he conceived, in accordance with his number-theory, a tenth which he called counter-earth, *ἀντίχθων*. He was the first who published a book on the Pythagorean doctrine, a treatise of which Plato made use in the composition of his *Timæus*. This work of the Pythagorean, to which the mystical name *Βάκχας* is sometimes given, seems to have consisted of three books: (1) *Περὶ κόσμου*, containing a general account of the origin and arrangement of the universe; (2) *Περὶ φύσεως*, an exposition of the natural numbers; (3) *Περὶ ψυχῆς*, on the nature of the soul.

See Boeckh, *Philolaos des Pythagoreers Lehrbuch nach den Bruchstücken seines Werkes* (Berlin, 1819); also Fabricius, *Bibliotheca Græca*; Zeller, *History of Greek Philosophy*; and Chaignet, *Pythagore et la Philosophie Pythagoricienne, conté sur les Fragments de Philon et d'Archytas* (1878).

\* Boeckh places his life between the 70th and 98th Olympiad (496-396 B.C.). He was a contemporary of Socrates and Democritus but senior to them, and was probably somewhat junior to Empedocles so that his birth may be placed at about 460.

<sup>1</sup> See Dahne, *Stud. und Krit.*, 1833, p. 987 sq.; Freudenthal, *Die Fl. Joseph, beilegte Schrift über die Herrschaft der Vernunft*, 1869, pp. 9 sq., 141 sq.

## PHILOLOGY

## PART I.—SCIENCE OF LANGUAGE IN GENERAL.

**PHILOLOGY** is the generally accepted comprehensive name for the study of the word; it designates that branch of knowledge which deals with human speech, and with all that speech discloses as to the nature and history of man. Philology has two principal divisions, corresponding to the two uses of "word" or "speech," as signifying either what is said or the language in which it is said, as either the thought expressed—which, when recorded, takes the form of literature—or the instrumentality of its expression: these divisions are the literary and the linguistic. Not all study of literature, indeed, is philological: as when, for example, the records of the ancient Chinese are ransacked for notices of astronomical or meteorological phenomena, or the principles of geometry are learned from the text-book of a Greek sage; while, on the other hand, to study Ptolemy and Euclid for the history of the sciences represented by them is philological more than scientific. Again, the study of language itself has its literary side: as when the vocabulary of a community (say of the ancient Indo-Europeans or Aryans) is taken as a document from which to infer the range and grade of knowledge of its speakers, their circumstances, and their institutions. The two divisions thus do not admit of absolute distinction and separation, though for some time past tending toward greater independence. The literary is the older of the two; it even occupied until recently the whole field, since the scientific study of language itself has arisen only within the present century. Till then, literary philology included linguistic, as a merely subordinate and auxiliary part, the knowledge of a language being the necessary key to a knowledge of the literature written in that language. When, therefore, instead of studying each language by itself for the sake of its own literature, men began to compare one language with another, in order to bring to light their relationships, their structures, their histories, the name "comparative philology" naturally enough suggested itself and came into use for the new method; and this name, awkward and trivial though it may be, has become so firmly fixed in English usage that it can be only slowly, if at all, displaced. Continental usage (especially German) tends more strongly than English to restrict the name philology to its older office, and to employ for the recent branch of knowledge a specific term, like those that have gained more or less currency with us also: as *glottic*, *glossology*, *linguistics*, *linguistic science*, *science of language*, and the like. It is not a question of absolute propriety or correctness, since the word philology is in its nature wide enough to imply all language-study, of whatever kind; it is one, rather, of the convenient distinction of methods that have grown too independent and important to be any longer well included under a common name.

Philology, in all its departments, began and grew up as classical; the history of our civilization made the study of Greek and Latin long the exclusive, still longer the predominant and regulating, occupation of secular scholarship. The Hebrew and its literature were held apart, as something of a different order, as sacred. It was not imagined that any tongue to which culture and literature did not lend importance was worthy of serious attention from scholars. The first essays in comparison, likewise, were made upon the classical tongues, and were as erroneous in method and fertile in false conclusions as was to be expected, considering the narrowness of view and the controlling prejudices of those who made them; and the

admission of Hebrew to the comparison only added to the confusion. The change which this century has seen has been a part of the general scientific movement of the age, which has brought about the establishment of so many new branches of knowledge, both historical and physical, by the abandonment of shackling prejudices, the freedom of inquiry, the recognition of the dignity of all knowledge, the wide-reaching assemblage of facts and their objective comparison, and the resulting constant improvement of method. Literary philology has had its full share of advantage from this movement; but linguistic philology has been actually created by it out of the crude observations and wild deductions of earlier times, as truly as chemistry out of alchemy, or geology out of diluvianism. It is unnecessary here to follow out the details of the development; but we may well refer to the decisive influence of one discovery, the decisive action of one scholar. It was the discovery of the special relationship of the Aryan or Indo-European languages, depending in great measure upon the introduction of the Sanskrit as a term in their comparison, and demonstrated and worked out by the German scholar Bopp, that founded the science of linguistic philology. While there is abundant room for further improvement, it yet appears that the grand features of philologic study, in all its departments, are now so distinctly drawn that no revolution of its methods, but only their modification in minor respects, is henceforth probable. How and for what purposes to investigate the literature of any people (philology in the more proper sense), combining the knowledge thus obtained with that derived from other sources; how to study and set forth the material and structure and combinations of a language (grammar), or of a body of related languages (comparative grammar); how to co-ordinate and interpret the general phenomena of language, as variously illustrated in the infinitely varying facts of different tongues, so as to exhibit its nature as a factor in human history, and its methods of life and growth (linguistic science),—these are what philology teaches. The first two subjects are mainly disposed of in this work in the various articles devoted to countries and races, with their literatures and dialects; the last was briefly touched upon in the article **ANTHROPOLOGY**, but requires fuller treatment here, along with a general view of the classification of languages, as thus far effected.

The study of language is a division of the general science of anthropology, and is akin to all the rest in respect of its objects and its methods. Man as we now see him is a twofold being: in part the child of nature, as to his capacities and desires, his endowments of mind and body; in part the creature of education, by training in the knowledge, the arts, the social conduct, of which his predecessors have gained possession. And the problem of anthropology is this: how natural man has become cultivated man; how a being thus endowed by nature should have begun and carried on the processes of acquisition which have brought him to his present state. The results of his predecessors' labours are not transmuted for his benefit into natural instincts, in language or in anything else. The child of the most civilized race, if isolated and left wholly to his own resources, aided by neither the example nor the instruction of his fellows, would no more speak the speech of his ancestors than he would build their houses, fashion their clothes, practise any of their arts, inherit their knowledge or wealth. In fact, he would

possess no language, no arts, no wealth, but would have to go to work to acquire them, by the same processes which began to win them for the first human beings. One advantage he would doubtless enjoy: the descendant of a cultivated race has an enhanced aptitude for the reception of cultivation; he is more cultivable; and this is an element that has to be allowed for in comparing present conditions with past, as influencing the rate of progress, but nothing more. In all other respects, it is man with the endowments which we now find him possessed of, but destitute of the gradually accumulated results of the exercise of his faculties, whose progress we have to explain. And it is, as a matter of necessity, by studying recent observable modes of acquisition, and transferring them, with due allowance for different circumstances, to the more primitive periods, that the question of first acquisition or origin is to be solved, for language as for tools, for arts, for family and social organization, and the rest. There is just as much, and just as little, reason for assuming miraculous interference and aid in one of these departments as in another. If men have been left to themselves to make and improve instruments, to form and perfect modes of social organization, by implanted powers directed by natural desires, and under the pressure of circumstances, then also to make and change the signs that constitute their speech. All expressions, as all instruments, are at present, and have been through the known past, made and changed by the men who use them; the same will have been the case in the unknown or prehistoric past. And we command now enough of the history of language, with the processes of its life and growth, to determine with confidence its mode of origin—within certain limits, as will appear below.

It is beyond all question, in the first place, that the desire of communication was the only force directly impelling men to the production of language. Man's sociality, his disposition to band together with his fellows, for lower and for higher purposes, for mutual help and for sympathy, is one of his most fundamental characteristics. To understand those about one and to be understood by them is now, and must have been from the very beginning, a prime necessity of human existence; we cannot conceive of man, even in his most undeveloped state, as without the recognition of it. Communication is still the universally recognized office of speech, and to the immense majority of speakers the only one; the common man knows no other, and can only with difficulty and imperfectly be brought to see that there is any other; of the added distinctness and reach of mental action which the possession of such an instrumentality gives him, he is wholly unconscious: and it is obvious that what the comparatively cultivated being of to-day can hardly be made to realize, can never have acted upon the first men as a motive to action. It may perhaps be made a question which of the two uses of speech, communication or the facilitation of thought, is the higher; there can be no question, at any rate, that the former is the broader and the more fundamental. That the kind and degree of thinking which we do nowadays would be impossible without language-signs is true enough; but so also it would be impossible without written signs. That there was a time when men had to do what mental work they could without the help of writing, as an art not yet devised, we have no difficulty in realizing, because the art is of comparatively recent device, and there are still communities enough that are working without it; it is much harder to realize that there was a time when speaking also was an art not yet attained, and that men had to carry on their rude and rudimentary thinking without it. Writing too was devised for conscious purposes of communication only; its esoteric uses, like

those of speech, were at first unsuspected, and incapable of acting as an inducement; they were not noticed until made experience of, and then only by those who look beneath the surface of things. There is no analogy closer and more instructive than this, between speech and writing. But analogies are abundant elsewhere in the history of human development. Everywhere it is the lower and more obvious inducements that are first affective, and that lead gradually to the possession of what serves and stimulates higher wants. All the arts and industries have grown out of men's effort to get enough to eat and protection against cold and heat—just as language, with all its uses, out of men's effort to communicate with their fellows. As a solitary man now would never form even the beginnings of speech, as one separated from society unlearns his speech by disuse and becomes virtually dumb, so early man, with all his powers, would never have acquired speech, save as to those powers was added sociality with the needs it brought. We might conceive of a solitary man as housing and dressing himself, devising rude tools, and thus lifting himself a step from wildness toward cultivation; but we cannot conceive of him as ever learning to talk. Recognition of the impulse to communication as the efficient cause of language-making is an element of primary importance in the theory of the origin of language. No one who either leaves it out of account or denies it will, however ingenious and entertaining his speculations, cast any real light on the earliest history of speech. To inquire under what peculiar circumstances, in connexion with what mode of individual or combined action, a first outburst of oral expression may have taken place, is, on the other hand, quite futile. The needed circumstances were always present when human beings were in one another's society; there was an incessant drawing-on to attempts at mutual understanding which met with occasional, and then ever more frequent and complete success. There inheres in most reasoning upon this subject the rooted assumption, governing opinion even when not openly upheld or consciously made, that conceptions have real natural names, and that in a state of nature these will somehow break forth and reveal themselves under favouring circumstances. The falsity of such a view is shown by our whole further discussion.

The character of the motive force to speech determined the character of the beginnings of speech. That was first signified which was most capable of intelligible signification, not that which was first in order of importance, as judged by any standard which we can apply to it, or first in order of conceptional development. All attempts to determine the first spoken signs by asking what should have most impressed the mind of primitive man are and must be failures. It was the exigencies and possibilities of practical life, in conditions quite out of reach of our distinct conception, that prescribed the earliest signs of communication. So, by a true and instructive analogy, the beginnings of writing are rude depictions of visible objects; it is now thoroughly recognized that no alphabet, of whatever present character, can have originated in any other way; everything else is gradually arrived at from that—as, indeed, in the ingeniously shaping hands of man, from any central body of signs, though but of small extent, all else is attainable by processes of analogy and adaptation and transfer. Now what is it that is directly signifiable in the world about us? Evidently, the separate acts and qualities of sensible objects, and nothing else. In writing, or signification to the eye, the first element is the rude depiction of the outline of an object, or of that one of the sum of its characteristic qualities which the eye takes note of and the hand is capable of intelligibly reproducing; from that the mind understands the whole

complex object itself, and then whatever further may in the circumstances of its use be suggested by it. So, for example, the picture of a tree signifies primarily a tree, then perhaps wood, something made of wood, and so on; that of a pair of outstretched wings signifies secondarily flight, then soaring, height, and whatever else these may lead to. No concrete thing is signifiable in its totality, or otherwise than by a facile analysis of its constituent qualities, and a selection of the one which is both sufficiently characteristic in itself and capable of being called up by a sign before the mind addressed.

And what quality shall be selected depends in great measure upon the instrumentality used for its signification. Of such instrumentalities, man are possessed of a considerable variety. We must leave out of account that of depiction, as just instanced, because its employment belongs to a much more advanced state of cultivation, and leads the way to the invention not of speech but of the analogous and auxiliary art of writing. There remain gesture, or changes of position of the various parts of the body, especially of the most mobile parts, the arms and hands; grimace, or the changes of expression of the features of the countenance (in strictness, a variety of the preceding); and utterance, or the production of audible sound. It cannot be doubted that, in the first stages of communicative expression, all these three were used together, each for the particular purposes which it was best calculated to serve. The nearest approach to such action that is now possible is when two persons, wholly ignorant of one another's speech, meet and need to communicate—an imperfect correspondence, because each is trained to habits of expression, and works consciously, and with the advantage of long experience, towards making himself understood; yet it is good for its main purpose. What they do, to reach mutual comprehension, is like what the first speechless men, unconsciously and infinitely more slowly, learned to do: face, hands, body, voice, are all put to use. It is altogether probable that gesture at first performed the principal part, even to such extent that the earliest human language may be said to have been a language of gesture-signs; indeed, there exist at the present day such gesture-languages, as those in use between roving tribes of different speech that from time to time meet one another (the most noted example is that of the gesture-languages, of a very considerable degree of development, of the prairie tribes of American Indians); or such signs as are the natural resort of those who by deafness are cut off from ordinary spoken intercourse with their fellows. Yet there never can have been a stage or period in which all the three instrumentalities were not put to use together. In fact, they are still all used together; that is even now an ineffective speaking to which grimace and gesture ("action," as Demosthenes called them) are not added as enforcers; and the lower the grade of development and culture of a language, the more important, even for intelligibility, is their addition. But voice has won to itself the chief and almost exclusive part in communication, inasmuch that we call all communication "language" (i.e. "tonguiness") just as a race of mutes might call it "headiness," and talk (by gesture) of a handiness of grimace. This is not in the least because of any closer connexion of the thinking apparatus with the muscles that act to produce audible sounds than with those that act to produce visible motions; not because there are natural uttered names for conceptions, any more than natural gestured names. It is simply a case of "survival of the fittest," or analogous to the process by which iron has become the exclusive material of swords, and gold and silver of money: because, namely, experience has shown this to be the material best adapted to this special use. The advantages of voice are numerous

and obvious. There is first its economy, as employing a mechanism that is available for little else, and leaving free for other purposes those indispensable instruments the hands. Then there is its superior perceptibility: its nice differences impress themselves upon the sense at a distance at which visible motions become indistinct; they are not hidden by intervening objects; they allow the eyes of the listener as well as the hands of the speaker to be employed in other useful work; they are as plain in the dark as in the light; and they are able to catch and command the attention of one who is not to be reached in any other way. We might add as the third advantage a superior capability of variation and combination on the part of spoken sounds; but this is not to be insisted on, inasmuch as we hardly know what a gesture-language might have become if men's ingenuity in expression had been expended through all time upon its elaboration; and the superiority, however real, can hardly have been obvious enough to serve as a motive: certainly, there are spoken languages now existing whose abundance of resources falls short of what is attainable by gesture. Oral utterance is the form which expression has inevitably taken, the sum of man's endowments being what it is; but it would be a mistake to suppose that a necessity of any other kind is involved in their relation. The fundamental conditions of speech are man's grade of intellectual power and his social instinct; these being given, his expression follows, availing itself of what means it finds best suited to its purpose; if voice had been wanting, it would have taken the next best. So, in certain well-known cases, a marked artistic gift, on the part of individuals deprived of the use of hands, has found means of exercise in the feet instead. But men in general have hands, instruments of exquisite tact and power, to serve the needs of their intellect; and so voice also, to provide and use the tools of thought; there is no error in maintaining that the voice is given us for speech, if only we do not proceed to draw from such a *dictum* false conclusions as to the relation between thought and utterance. Man is created with bodily instruments suited to do the work prescribed by his mental capacities; therein lies the harmony of his endowment.

It is through imitation that all signification becomes directly suggestive. The first written signs are (as already noticed) the depictions of visible objects, and could be nothing else; and, by the same necessity, the first uttered signs were the imitations of audible sounds. To reproduce any sound of which the originating cause or the circumstances of production are known, brings up of course before the conception that sound, along with the originator, or circumstances of origination, or whatever else may be naturally associated with it. There are two special directions in which this mode of sign-making is fruitful: imitation of the sounds of external nature (as the cries of animals, and the noises of inanimate objects when in motion or acted on by other objects) and imitation of human sounds. The two are essentially one in principle, although by some held apart, or even opposed to each other, as respectively the imitative or onomatopoeic and the exclamatory or interjectional beginnings of speech; they differ only in their spheres of significance, the one being especially suggestive of external objects, the other of inward feelings. There are natural human tones, indicative of feeling, as there are natural gestures, poses, modes of facial expression, which either are immediately intelligible to us (as is the warning cry of the hen to the day-old chicken), or have their value taught us by our earliest experiences. If we hear a cry of joy or a shriek of pain, a laugh or a groan, we need no explanation in words to tell us what it signifies, any more than when we see a sad face or a drooping attitude. So also the characteristic cry

or act of anything outside ourselves, if even rudely imitated, is to us an effective reminder and awakener of conception. We have no reason to question that such were the suggestions of the beginnings of uttered expression. The same means have made their contributions to language even down to our own day; we call words so produced "onomatopoeic" (i.e., "name-making"), after the example of the Greeks, who could not conceive that actually new additions to language should be made in any other way. What and how wide the range of the imitative principle, and what amount of language-signs it was capable of yielding, is a subject for special investigation—or rather, of speculation, since anything like exact knowledge in regard to it will never be attained; and the matter is one of altogether secondary consequence; it is sufficient for our purpose that enough could certainly be won in this way to serve as the effective germs of speech.

All the natural means of expression are still at our command, and are put to more or less use by us, and their products are as intelligible to us as they have been to any generation of our ancestors, back to the very first. They are analogous also to the means of communication of the lower animals; this, so far as we know, consists in observing and interpreting one another's movements and natural sounds (where there are such). But language is a step beyond this, and different from it. To make language, the intent to signify must be present. A cry wrung out by pain, or a laugh of amusement, though intelligible, is not language; either of them, if consciously reproduced in order to signify to another pain or pleasure, is language. So a cough within hearing of any one attracts his attention; but to cough, or to produce any other sound, articulate or inarticulate, for the purpose of attracting another's attention, is to commit an act of language-making, such as in human history preceded in abundance the establishment of definite traditional signs for conceptions. Here begins to appear the division between human language and all brute expression; since we do not know that any animal but man ever definitely took this step. It would be highly interesting to find out just how near any come to it; and to this point ought to be especially directed the attention of those who are investigating the communication of the lower animals in its relation to human communication. Among the animals of highest intelligence that associate with man and learn something of his ways, a certain amount of sign-making expressly for communication is not to be denied; the dog that barks at a door because he knows that somebody will come and let him in is an instance of it; perhaps, in wild life, the throwing out of sentinel birds from a flock, whose warning cry shall advertise their fellows of the threat of danger, is as near an approach to it as is anywhere made.

But the actual permanent beginnings of speech are only reached when the natural basis is still further abandoned, and signs begin to be used, not because their natural suggestiveness is seen in them, but by imitation, from the example of others who have been observed to use the same sign for the same purpose. Then for the first time the means of communication becomes something to be handed down, rather than made anew by each individual; it takes on that traditional character which is the essential character of all human institutions, which appears not less in the forms of social organization, the details of religious ceremonial, the methods of art and the arts, than in language. That all existing speech, and all known recorded speech, is purely traditional, cannot at all be questioned. It is proved even by the single fact that for any given conception there are as many different spoken signs as there are languages—say a thousand (this number is rather far within than beyond the truth), each of them intelli-

gible to him who has learned to use it and to associate it with the conception to which it belongs, but unintelligible to the users of the nine hundred and ninety-nine other signs, as these are all unintelligible to him; unless, indeed, he learn a few of them also, even as at the beginning he learned the one that he calls his own. What single sign, and what set of signs, any individual shall use, depends upon the community into the midst of which he is cast, by birth or other circumstances, during his first years. That it does not depend upon his race is demonstrated by facts the most numerous and various; the African whose purity of descent is attested by every feature is found all over the world speaking just that language, or jargon, into the midst of which the fates of present or former slavery have brought his parents; every civilized community contains elements of various lineage, combined into one by unity of speech; and instances are frequent enough where whole nations speak a tongue of which their ancestors knew nothing: for example, the Celtic Gauls and the Germanic Normans of France speak the dialect of a geographically insignificant district in central Italy, while we ourselves can hardly utter a sentence or write a line without bringing in more or less of that same dialect. There is not an item of any tongue of which we know anything that is "natural" expression, or to the possession of which its speaker is brought by birth instead of by education; there is even very little that is traceably founded on such natural expression; everywhere *θίεϊς* or human attribution reigns supreme, and the original *φύεϊς* or natural significance has disappeared, and is only to be found by theoretic induction (as we have found it above). It seems to some as if a name like *cuckoo* (one of the most striking available cases of onomatopoeia) were a "natural" one; but there is just as much *θίεϊς* in it as in any other name; it implies the observation of an aggregate of qualities in a certain bird, and the selection of one among them as the convenient basis of a mutual understanding when the bird is in question; every animal conspicuous to us must have its designation, won in one way or another; and in this case, to imitate the characteristic cry is the most available way. If anything but convenience and availability were involved, all our names for animals would have to be and to remain imitations of the sounds they make. That the name of *cuckoo* is applied also to the female and young, and at other than the singing season, and then to related species which do not make the same sound—all helps to show the essentially conventional character of even this name. An analogous process of elimination of original meaning, and reduction to the value of conventional designation merely, is to be seen in every part of language, throughout its whole history. Since men ceased to derive their names from signs having a natural suggestiveness, and began to make them from other names already in use with an understood value, every new name has had its etymology and its historical occasion—as, for example, the name *quarantine* from the two-score (*quarantaine*) of days of precautionary confinement, or *volume* from its being rolled up, or *book* from a beech-wood staff, or *copper* from Cyprus, or *leucacy* from a fancied influence of the moon, or *priest* from being an older (*ἄρσβύρεπος*) person, or *butterfly* from the butter-yellow colour of a certain common species: every part of our language, as of every other, is full of such examples—but, when once the name is applied, it belongs to that to which it is applied, and no longer to its relatives by etymology; its origin is neglected, and its form may be gradually changed beyond recognition, or its meaning so far altered that comparison with the original shall seem a joke or an absurdity. This is a regular and essential part of the process of name-making in all human speech, and from



the very beginning of the history of speech: in fact (as pointed out above), the latter can only be said to have begun when this process was successfully initiated, when uttered signs began to be, what they have ever since continued to be, conventional, or dependent only on a mutual understanding. Thus alone did language gain the capacity of unlimited growth and development. The sphere and scope of natural expression are narrowly bounded; but there is no end to the resources of conventional sign-making.

It is well to point out here that this change of the basis of men's communication from natural suggestiveness to mutual understanding, and the consequent purely conventional character of all human language, in its every part and particle, puts an absolute line of demarcation between the latter and the means of communication of all the lower animals. The two are not of the same kind, any more than human society in its variety of organization is of the same kind with the instinctive herding of wild cattle or swarming of insects, any more than human architecture with the instinctive burrowing of the fox and nest-building of the bird, any more than human industry and accumulation of capital with the instinctive hoarding of bees and beavers. In all these cases alike, the action of men is a result of the adaptation of means at hand to the satisfaction of felt needs, or of purposes dimly perceived at first, but growing clearer with gradually acquired experience. Man is the only being that has established institutions—gradually accumulated and perfected results of the exercise of powers analogous in kind to, but greatly differing in degree from, those of the lower animals. The difference in degree of endowment does not constitute the difference in language, it only leads to it. There was a time when all existing human beings were as destitute of language as the dog; and that time would come again for any number of human beings who should be cut off (if that were practicable) from all instruction by their fellows: only they would at once proceed to re-create language, society, and arts, by the same steps by which their own remote ancestors created those which we now possess; while the dog would remain what he and his ancestors have always been, a creature of very superior intelligence, indeed, as compared with most, of infinite intelligence as compared with many, yet incapable of rising by the acquisition of culture, through the formation and development of traditional institutions. There is just the same *saltus* existent in the difference between man's conventional speech and the natural communication of the lower races as in that between men's forms of society and the instinctive associations of the lower races; but it is no greater and no other; it is neither more absolute and characteristic nor more difficult to explain. Hence those who put forward language as the distinction between man and the lower animals, and those who look upon our language as the same in kind with the means of communication of the lower animals, only much more complete and perfect, fail alike to comprehend the true nature of language, and are alike wrong in their arguments and conclusions. No addition to or multiplication of brute speech would make anything like human speech; the two are separated by a step which no animal below man has ever taken; and, on the other hand, language is only the most conspicuous among those institutions the development of which has constituted human progress, while their possession constitutes human culture.

With the question of the origin of man, whether or not developed out of lower animal forms, intermediate to the anthropoid apes, language has nothing to do, nor can its study ever be made to contribute anything to the solution of that question. If there once existed creatures above the apes and below man, who were extirpated by primitive

man as his especial rivals in the struggle for existence, or became extinct in any other way, there is no difficulty in supposing them to have possessed forms of speech, more rudimentary and imperfect than ours. At any rate, all existing human speech is one in the essential characteristics which we have thus far noted or shall hereafter have to consider, even as humanity is one in its distinction from the lower animals; the differences are in non-essentials. All speech is one in the sense that every human being, of whatever race he may be, is capable of acquiring any existing tongue, and of using it for the same purposes for which its present possessors use it, with such power and effect as his individual capacity allows, and without any essential change in the mental operations carried on by means of speech—even as he may acquire any other of the items of culture belonging to a race not his own. The difference between employing one language and another is like that between employing one instrument and another in mechanical arts; one instrument may be better than another, and may enable its user to turn out better work, but the human ingenuity behind both is the same, and works in the same way. Nor has the making of language anything whatever to do with making man what he is, as an animal species having a certain physical form and intellectual endowment. Being what he is by nature, man has by the development of language and other institutions become what he is by culture. His acquired culture is the necessary result of his native endowment, not the contrary. The acquisition of the first stumbling beginnings of a superior means of communication had no more influence to raise him from a simian to a human being than the present high culture and perfected speech of certain races has to lift them up to something more than human, and specifically different from the races of inferior culture. It cannot be too absolutely laid down that differences of language, down to the possession of language at all, are differences only in respect to education and culture.

How long man, after he came into being such as he now is, physically and intellectually, continued to communicate with imitative signs of direct significance, when the production of traditional signs began, how rapidly they were accumulated, and how long any traces of their imitative origin clung to them—these and the like questions it is at present idle to try to answer even conjecturally: just as it is to seek to determine when the first instruments were used, how soon they were shaped instead of being left crude, at what epoch fire was reduced to service, and so on. The stages of development and their succession are clear enough; to fix their chronology will doubtless never be found practicable. There is much reason for holding, as some do, that the very first items of culture were hardest to win and cost most time, the rate of accumulation (as in the case of capital) increasing with the amount accumulated. Beyond all reasonable question, however, there was a positively long period of purely imitative signs, and a longer one of mixed imitative and traditional ones, the latter gradually gaining upon the former, before the present condition of things was reached, when the production of new signs by imitation is only sporadic and of the utmost rarity, and all language-signs besides are traditional, their increase in any community being solely by variation and combination, and by borrowing from other communities.

Of what nature, in various respects, this earliest language-material was is sufficiently clear. The signs, in the first place, were of the sort that we call "roots." By this is only meant that they were integral signs, significant in their entirety, not divisible into parts, of which one signified one thing and another another thing, or of which one gave the main significance, while another was an added sign of kind or relation. In a language of

developed structure like our own, we are mainly by an artificial stripping-off of the sign which almost every word still has, or can be shown to have once had. In *un-cost-li-ness*, for example, *cost* is the centrally significant element; cluster a whole body of forms and derivatives; if we could follow its history no farther, it would be to us an ultimate root, as much so as *bind* or *sing* or *mean*. But we can follow it up, to the Latin compound *con-sta*, a root *sta* with a prefixed formative element in them all the same significance "stand," is an Aryan root, and to us an ultimate one, because we can follow its history no farther; but there always remains the possibility that it is as far from being actually original as is the English root *cost*: that is to say, it is not within our power ever to get back to the really primitive elements of speech, and to demonstrate their character by positive evidence. The reason for accepting a primitive root-stage of language is in great part theoretical: because nothing else is reconcilable with any acceptable view of the origin of language. The law of the simplicity of beginnings is an absolute one for everything of the nature of an institution, for every gradually developed product of the exercise of human faculties. That an original speech-sign should be of double character, one part radical meaning this and another part that, or one part radical and the other formative, is as inconceivable as that the first instruments should have had handles, or the first shelters a front room and a back one. But this theoretical reason finds all the historical support which it needs in the fact that, through all the observable periods of language history, we see formative elements coming from words originally independent, and not from anything else. Thus in the example just taken, the *-li-* of *costliness* is a suffix of so recent growth that its whole history is distinctly traceable; it is simply our adjective *like*, worn down in both form and meaning to which it was appended, and then added freely as a suffix to any word from which more often, a derivative adjective—*ness* is much older (though only Germanic), and its history of demonstrable origin; but there are equivalent later suffixes, as *ship* in *hardship* and *dom* in *wisdom*, whose derivation from independent words (*shape*, *doom*) is beyond question. The *ness* of *uncostliness* is still more ancient (being Aryan), and its probably pronominal origin hardly available as an illustration; but the comparative *-ly* or *-li-* from *like*, by the same process as *-ly* or *-li-* from *like*, comes from *like*, which has contributed its part to the making of the quasi-root *cost* "with." By all the known facts of later preposition *cum* "with." By all the known facts of later language-growth, we are driven to the opinion that every formative element goes back to some previously existing independent word; and hence that in analysing our present words we are retracing the steps of an earlier synthesis, or following up the history of our formed words toward the unformed roots out of which they have grown. The doctrine of the historical growth of language-structure leads by a logical necessity to that of a root-stage in the history of all language; the only means of avoiding the latter is the assumption of a miraculous element in the former.

Of what phonetic form were the earliest traditional speech-signs is, so far as essentials are concerned, to be inferred with reasonable certainty. They were doubtless

and reproduced by another; all dialects are representable by alphabet sounds, consonant and vowel, in all; though every dialect readily definable and imitable in a single group of languages, or in a single group of articulate sounds are such as are capable of distinct yet connected utterance. The name "articulate" belongs to this utterance, as distinguished from inarticulate human sounds, and from the sounds made by the lower animals. The word itself is Latin, by translation to designate all articulates, though very widely misunderstood, and even differently misapplied in some languages to designate all of whatever kind, uttered by any living creature, is "jointed," or broken up into successive parts, like or stem; the joints are the syllables; and the structure is mainly effected by the alternation of consonant sounds with opener or vowel sounds. The simplest syllabic combination (as the facts of phonology show) is that of a single consonant with a following and there are languages even now existing which that the first speech-signs will have had this phonetic and been monosyllabic, or dissyllabic only by (reduplication) of one syllable, such as the speech of young children shows to have a peculiar ease and neatness. The point, however, is one of only second importance, and may be left to the further progress of study to settle, if it can; the root-theory, at least, not bound to any definite form or extent of development, denies that there can have been any grammatical structure in language except by development in experience, and how many, made up the first speech-signs, and also a matter of conjecture merely; the history of language is also a matter of conjecture, and the value of the evidence has been the closest consonants and the most medial utterances their significant value by the experience of those who have denoted those physical signs must have denoted those directly significant human beings which are directly apprehensible by the senses, because these alone are directly significant to our own day, is full of examples of physical terms and phrases; and the whole history of language, as having read the history of any term till we have traced it back to a line without giving illustrations of the growth. So pervading is it, that we never been any difficulty in providing the latter by the names of things and more refined thought by putting and grosser materials of speech. As a matter of course, whatever simple expressions for simple ac-



was intended to be signified through the first speech-signs by the users of them. But to us, with our elaborated apparatus of speech, the sentence, composed of subject and predicate, with a verb or special predicative word to signify the predication, is established as the norm of expression, and we regard everything else as an abbreviated sentence, or as involving a virtual sentence. With a view to this, we must have "parts of speech": that is, words held apart in office from one another, each usable for such and such a purpose and no other, and answering a due variety of purposes, so that when they are combined they fit together, as parts composing a whole, and the desired meaning is made clear. Inflections, too, lend their aid; or else auxiliary words of various kinds answering the same purpose—namely, of determining the relations of the members of the sentence. But all our success in understanding the earliest stages of language depends upon our power to conceive a state of things where none of these distinctions were established, where one speech-sign was like another, calling up a conception in its indefinite entirety, and leaving the circumstances of the case to limit its application. Such a language is far below ours in explicitness; but it would suffice for a great deal of successful communication; indeed (as will be shown farther on), there are many languages even now in existence which are little better off. So a look of approval or disgust, a gesture of beckoning or repulsion, a grunt of assent or inquiry, is as significant as a sentence, means a sentence, is translatable into a sentence, and hence may even in a certain way be called a sentence; and in the same way, but only so, the original roots of language may be said to have been sentences. In point of fact, between the holophrastic gesture or uttered sign and the sentence which we can now substitute for it—for example, between the sign of beckoning and the equivalent sentence, "I want you to come here"—lies the whole history of development of inflective speech.

What has been this history of development, how the first scanty and formless signs have been changed into the immense variety and fulness of existing speech, it is of course impossible to point out in detail, or by demonstration of facts, because nearly the whole process is hidden in the darkness of an impenetrable past. The only way to cast any light upon it is by careful induction from the change and growth which are seen to have been going on in the recent periods for which we have recorded evidence, or which are going on at the present time. Of some groups of related languages we can read the life for three or four thousand years back, and by comparison can infer it much farther; and the knowledge thus won is what we have to apply to the explanation of periods and languages otherwise unknown. Nothing has a right to be admitted as a factor in language-growth of which the action is not demonstrable in recorded language. Our own family of languages is the one of whose development most is known, by observation and well-warranted inference; and it may be well here to sketch the most important features of its history, by way of general illustration.

Apparently the earliest class-distinction traceable in Aryan speech is that of pronominal roots, or signs of position, from the more general mass of roots. It is not a formal distinction, marked by a structural difference, but, so far as can be seen, is founded only on the assignment by usage of certain elements to certain offices. Formal distinction began with combination, the addition of one element to another, their fusion into a single word, and the reduction of the one part to a subordinate value, as sign of a certain modification of meaning of the other. Thus, doubtless by endings of pronominal origin, were made the first verb-forms, or words used only when predication was intended (since that is all that makes a verb),

conveying at first a distinction of persons only, then of persons and numbers, while the further distinctions of tense and mode were by degrees added. To the nouns, which became nouns by the setting up of the separate and special class of verbs, were added in like manner distinctions of case, of number, and of gender. With the separation of noun and verb, and the establishment of their respective inflexion, the creative work of language-making is virtually done; the rest is a matter of differentiation of uses. For the noun (noun substantive) and the adjective (noun adjective) become two parts of speech only by a gradually deepened separation of use; there is no original or formal distinction between them; the pronouns merely add the noun-inflexion to a special set of stems; adverbs are a part of the same formation as noun-cases; prepositions are adverbs with a specialized construction, of secondary growth; conjunctions are the products of a like specialization; articles, where found at all, are merely weakened demonstratives and numerals.

To the process of form-making, as exhibited in this history, belong two parts: the one external, consisting in the addition of one existing element of speech to another and their combination into a single word; the other internal, consisting in the adaptation of the compound to its special use and involving the subordination of one element to the other. Both parts appear also abundantly in other departments of language-change, and throughout the whole history of our languages; nothing has to be assumed for the earliest formations which is not plainly illustrated in the latest. For example, the last important addition to the formative apparatus of English is the common adverb-making suffix *-ly*, coming, as already pointed out, from the independent adjective *like*. There was nothing at first to distinguish a compound like *godly* (*godlike*) from one like *storm-loosed*, save that the former was more adaptable than the other to wider uses; resemblance is an idea easily generalized into appurtenance and the like, and the conversion of *godlike* to *godly* is a simple result of the processes of phonetic change described farther on. The extension of the same element to combination with adjectives instead of nouns, and its conversion to adverb-making value, is a much more striking case of adaptation, and is nearly limited to English, among the Germanic languages that have turned *like* into a suffix. A similar striking case, of combination and adaptation, is seen in the Romanic adverb-making suffix *mente* or *ment*, coming from the Latin ablative *mente*, "with mind." So, to make a Romanic future like *donnerai*, "I shall give," there was needed in the first place the pre-existing elements *donner*, "to give," and *ai*, "I have," and their combination; but this is only a part; the other indispensable part is the gradual adaptation of a phrase meaning "I have [something before me] for giving" to the expression of simple futurity, "*donabo*." So far as the adaptation is concerned, the case is quite parallel to that of *jai donné*, "I have given," &c. (equivalent phrases or combinations are found in many languages), where the expression of possession of something that is acted on has been in like manner modified into the expression of past action. Parallel in both combination and adaptation is the past tense *loved*, from *love-did*, while we have again the same adaptation without combination in the equivalent phrase *did love*.

That these are examples of the process by which the whole inflective structure of Aryan language was built up admits of no reasonable question. Our belief that it is so rests upon the solid foundation that we can demonstrate no other process, and that this one is sufficient. It is true that we can prove such an origin for our formative elements in only a small minority of instances; but this is just what was to be expected, considering what we know

of the disguising processes of language-growth. No one would guess in the mere *y* of *ably* (for *able-ly*) the presence of the adjective *like*, any more than in the altered final of *sent* and the shortened vowel of *led* the effect of a *did* once added to *send* and *lead*. The true history of these forms can be shown, because there happen to be other facts left in existence to show it; where such facts are not within reach, we are left to infer by analogy from the known to the unknown. The validity of our inference can only be shaken by showing that there are forms incapable of having been made in this way, or that there are and have been other ways of making forms. Of the former there is evidently but small chance; if a noun-form meaning "with mind" can become the means of conversation of all the adjectives of a language into adverbs, and a verb meaning "have" (and, yet earlier, "seize") of signifying both future and past time, there is obviously nothing that is impossible of attainment by such means. As regards the latter, no one appears to have even attempted to demonstrate the genesis of formative elements in any other way during the historical periods of language; it is simply assumed that the early methods of language-making will have been something different from and superior in spontaneity and fruitfulness to the later ones; that certain forms, or forms at certain periods, were made out-and-out, as forms; that signs of formal distinction somehow exuded from roots and stems; that original words were many-membered, and that a formative value settled in some member of them—and the like. Such doctrines are purely fanciful, and so opposed to the teachings both of observation and of sound theory that the epithet absurd is hardly too strong to apply to them. If the later races, of developed intelligence, and trained in the methods of a fuller expression, can only win a new form by a long and gradual process of combination and adaptation, why should the earlier and comparatively untrained generations have been able to do any better? The advantage ought to be, if anywhere, on our side. The progress of language in every department, accompanying and representing the advance of the race, on the whole, in the art of speaking as in other arts, is from the grosser to the more refined, from the physical to the moral and intellectual, from the material to the formal. The conversion of compounds into forms, by the reduction of one of their elements to formative value, is simply a part of the general process which also creates auxiliaries and form-words and connectives, all the vocabulary of mind, and all the figurative phraseology that gives life and vigour to our speech. If a copula, expressive of the grammatical relation of predication, could be won only by attenuation of the meaning of verbs signifying "grow," "breathe," "stand," and the like; if our auxiliaries of tense and mode all go traceably back to words of physical meaning (as *have* to "seize," *may* to "be great or strong," *shall* to "be under penalty," and so on); if *of* comes from the comparatively physical *off*, and *for* from "before, forward"; if relative pronouns are specialized demonstratives and interrogatives; if *right* means etymologically "straight," and *wrong* means "twisted"; if *spirit* is "blowing," and *intellect* a "picking out among," and *understanding* a "getting beneath," and *development* an "unfolding"; if an event *takes place* or *comes to pass*, and then *drops out* of mind and is *forgotten* (opposite of *gotten*)—then it is of no avail to object to the grossness of any of the processes by which, in earlier language or in later, the expression of formal relations is won. The mental sense of the relation expressed is entirely superior to and independent of the means of its expression. He who, to express the plural of *man*, says what is equivalent to *man-man* or *heap-man* (devices which are met with in not a few languages) has just as good a sense of plurality

as he who says *men* or *homines*; that sense is no more degraded in him by the coarseness of the phrase he uses to signify it than is our own sense of eventuality and of pastness by the undiagnosed coarseness of *take place* and *have been*. In short, it is to be laid down with the utmost distinctness and confidence, as a law of language-growth, that there is nothing formal anywhere in language which was not once material; that the formal is made out of the material, by processes which began in the earliest history of language and are still in action.

We have dropped here the restriction to our own or Aryan language with which we began, because it is evident that what is true of this family of speech, one of the most highly organized that exist, may also be true of the rest—must be true of them, unless some valid evidence be found to the contrary. The unity of human nature makes human speech alike in the character of its beginnings and in the general features of its after-history. Everywhere among men, a certain store of expression, body of traditional signs of thought, being given, as used by a certain community, it is capable of increase on certain accordant lines, and only on them. In some languages, and under peculiar circumstances, borrowing is a great means of increase; but it is the most external and least organically important of all. Out-and-out invention (which, so far as we can see, must be of the kind called by us onomatopoeic) is found to play only a very insignificant part in the historical periods of language,—clearly because there are other and easier modes of gaining new expression for what needs to be expressed. In the course of phonetic change, a word sometimes varies into two (or more) forms, and makes so many words, which are differently turned to account. Everything beyond this must be the product of combination; there is no other way, so far as concerns the externals of speech. Then, partly as accompanying and aiding this external growth, partly as separate from and supplementing it, there is in all language an internal growth, making no appearance in the audible part of speech, consisting in multiplication of meanings, their modification in the way of precision or comprehensiveness or correctness, the restriction of words to certain uses and so on. Along with these, too, a constant change of phonetic form constitutes an inseparable part of the life of language. Speech is no more stable with respect to the sounds of which it is composed than with respect to its grammatical forms, its vocabulary, or the body of conceptions signified by it. Even nearly related languages differ as much in their spoken alphabets and the combinations of sounds they admit, and in their uttered forms of words historically the same, as in any other part; and the same is true of local dialects, and of class dialects within the same community. Phonetic change has nothing whatever to do with change of meaning; the two are the product of wholly independent tendencies. Sometimes, indeed, they chance to coincide, as in the distinction of *small* "small," and *minutes* "moment"; but it is only by chance. As the spoken accordance of *second* in its two meanings ("next" and "sixtieth of a minute") shows; words that maintain their identity of value most obstinately, like the numerals, are liable to vary indefinitely in form (so *four*, *štvor*, *quatuor*, *τέσσαρες*, &c., from an original *kateršve*, *šve*, *quinque*, *πέντε*, *coic*, &c., from *penka*—while, on the other hand, *two* and *three* show as striking an accordance of form as of meaning through all the same languages: what is far the most common is that the word becomes very unlike its former self in both respects, like *priest* from the Greek *πρεσβύτερος* (*presbyter*), literally "older man." Human convenience is, to be sure, the governing motive in both changes; but it is convenience of two different kinds: the one mental, depending on the fact

(pointed out above) that a name when once applied belongs to the thing to which it is applied, to the disregard of its etymological connexions, does not need to be changed when the thing changes, and is ready for new application to anything that can be brought into one class with the latter; and the other physical, depending on the organs of speech and their successive movements, by which the sounds that make up the word are produced. Phonetic convenience is economy of effort on the part of those organs; and to no other law than that of economy of utterance have any of the phenomena of phonetic change been found traceable (though it is also to be noted that some phenomena have not hitherto been successfully brought under it, and that the way of effecting this is still unclear). "Euphony," which used to be appealed to as explanation, is a false principle, except so far as the term may be made an idealized synonym of economy. The ear finds that agreeable which the organs of utterance find facile. Economy in utterance is no isolated tendency; it is the same that plays its part in all other kinds of human action, and in language appears equally in the abbreviation of the sentence by leaving out parts that can be spared without loss of intelligibility. It is an insidious tendency, always lying in wait, like gravitation, to pull down what is not sufficiently held up,—the holding-up force in language being the faithfulness of tradition, or accurate reproduction by the learner and user of the signs which he has acquired. No generation of men has any intention to speak otherwise than as its predecessor has spoken, or any consciousness that it is doing so; and yet, from generation to generation, words are shortened, sounds are assimilated to one another, and one element passes out of use while a new one is introduced. Abbreviation and assimilation are the most conspicuous departments of phonetic change, and those in which the nature of the governing tendency is most plainly seen. Taken by itself, one sound is as easy as another to the person who has accustomed himself to it from childhood; and those which the young child most easily acquires are not those which in the history of speech are least liable to alteration; it is especially in the combinations and transitions of rapid speaking that the tongue, as it were, finds out for itself easier ways of performing its task, by dropping and slurring and adapting. To trace out the infinitely varied items of this change, to co-ordinate and compare them and discover their reasons, constitutes a special department of language-study, which is treated under the head of *СРЕКН СОВУДС*. It only needs to be pointed out here that phonetic change plays a necessary part in the structural development of language, by integrating compound words through fusion and loss of identity of their component parts, and, what is of yet more importance, by converting them into forms, through disguise of identity of one of the parts and its phonetic subordination to the other part. It is this that turns, for example, the compound *god-like* into the derivative *godly*, the compound *love-did* into the verbal form *loved*. And yet one further result sometimes follows: an internal change is wrought by phonetic influence in the body of a word, which change then *mc.*7 in the further history of the word be left as the sole means of distinction between one form and another. It is thus that, in the most recent period, the distinction of *led* from *lead* and *met* from *meet* and so on has been made; the added auxiliary which originally made these preterites induced a shortening of the root-vowel, and this was left behind when the auxiliary disappeared by the usual process of abbreviation. It is in the same way that the distinctions of *men* from *man*, of *were* from *was*, of *set* from *sit*, with all their analogues, were brought about: by a modification of vowel-sound (Ger. *Umlaut*) occasioned by the presence

in the following syllable of an *i*-vowel, which in the older stages of the language is still to be seen there. And the distinctions of *sing*, *sang*, *sung*, *sing*, *song*, of *bind*, *bund*, *band*, and *bond*, are certainly of the same kind, though they go back so far in the history of our family of languages that their beginnings are not yet clearly demonstrable; they were in their origin phonetic accidents, inorganic, mere accompaniments and results of external combinations which bore the office of distinction of meaning and were sufficient to it; in some of our languages they have been disregarded and effaced, in others they have risen to prominent importance. To regard these internal changes as primary and organic is parallel with assuming the primariness of the formative apparatus of language in general; like this, it ignores the positive evidence we have of the secondary production of such differences; they are, like everything else in linguistic structure, the outcome of combination and adaptation.

Borrowing, or the taking-in of material out of another language, has been more than once referred to above as sometimes an important element in language-history, though less deep-reaching and organic than the rest. There is nothing anomalous about borrowing; it is rather in essential accordance with the whole process of language-acquisition. All our names were adopted by us because they were already in use by others; and a community is in the same way capable of taking a new name from a community with which it comes in contact as an individual from individuals. Not that it seeks or admits in this way new names for old things; but it accepts new things along with the names that seem to belong to them. Hence any degree of intercourse between one community and another, leading to exchange of products or of knowledge, is sure to lead also to some borrowing of names; and there is hardly a language in the world, except of races occupying peculiarly isolated positions, that does not contain a certain amount of foreign material thus won, even as our English has elements in its vocabulary from half the other tongues in the world. The scale of borrowing is greatly increased when one people becomes the pupil of another in respect of its civilization: hence the abundant classical elements in all the European tongues, even the non-Romanic; hence the Arabic material in Persian and Turkish and Malay; hence the Chinese in Japanese and Korean; and, as a further result, even dead languages, like the Greek and Latin and the Sanskrit, become stores to be drawn upon in that learned and conscious quest of new expression which in the school-stage of culture supplements or even in a measure replaces the unconscious growth of natural speech. So, in mixture of communities, which is a highly-intensified form of contact and intercourse, there follows such mixture of speech as the conditions of the case determine; yet not a mixture on equal terms, through all the departments of vocabulary and grammar; the resulting speech (just as when two individuals learn to speak alike) is essentially that of the one constituent of the new community, with more or less material borrowed from that of the other. What is most easily taken in out of another language is the names of concrete things; every degree of removal from this involves additional difficulty—names of abstract things, epithets, verbs, connectives, forms. Indeed, the borrowing of forms in the highest sense, or forms of inflexion, is well-nigh or quite impossible; no example of it has been demonstrated in any of the historical periods of language, though it is sometimes adventurously assumed as a part of prehistoric growth. How nearly it may be approached is instanced by the presence in English of such learned plurals as *phenomena* and *strata*. This extreme resistance to mixture in the department of inflexion is the ground on which some deny the possibility of mixture in

language, and hence the existence of such a thing as a mixed language. The difference is mainly a verbal one; but it would seem about as reasonable to deny that a region is inundated so long as the tops of its highest mountains are above water. According to the simple and natural meaning of the term, nearly all languages are mixed, in varying degree and within varying limits, which the circumstances of each case must explain.

These are the leading processes of change seen at work in all present speech and in all known past speech, and hence to be regarded as having worked through the whole history of speech. By their operation, every existing tongue has been developed out of its rudimentary radical condition to that in which we now see it. The variety of existing languages is well-nigh infinite, not only in their material but in their degree of development and the kind of resulting structure. Just as the earlier stages in the history of the use of tools are exemplified even at the present day by races which have never advanced beyond them, so is it in regard to language also—and, of course, in the latter case as in the former, this state of things strengthens and establishes the theory of a gradual development. There is not an element of linguistic structure possessed by some languages which is not wanting in others; and there are even tongues which have no formal structure, and which cannot be shown ever to have advanced out of the radical stage. The most noted example of such a rudimentary tongue is the Chinese, which in its present condition lacks all formal distinction of the parts of speech, all inflexion, all derivation; each of its words (all of them monosyllables) is an integral sign, not divisible into parts of separate significance; and each in general is usable wherever the radical idea is wanted, with the value of one part of speech or another, as determined by the connexion in which it stands: a condition parallel with that in which Aryan speech may be regarded as existing prior to the beginnings of its career of formal development briefly sketched above. And there are other tongues, related and unrelated to Chinese, of which the same description, or one nearly like it, might be given. To call such languages radical is by no means to maintain that they exhibit the primal roots of human speech, unchanged or only phonetically changed, or that they have known nothing of the combination of element with element. Of some of them, the roots are in greater or less part dissyllabic; and we do not yet know that all dissyllabism, and even that all complexity of syllable beyond a single consonant with following vowel, is not the result of combination or reduplication. But all combination is not form-making; it needs a whole class of combinations, with a recognized common element in them producing a recognized common modification of meaning, to make a form. The same elements which (in Latin, and even to some extent in English also) are of formal value in *constant* and *pre-dict* lack that character in *cost* and *preach*; the same *like* which makes adverbs in *truly* and *rightly* is present without any such value in *such* and *which* (from *so-like* and *who-like*); *cost* and *preach*, and *such* and *which*, are as purely radical in English as other words of which we do not happen to be able to demonstrate the composite character. And so a Chinese monosyllable or an Egyptian or Polynesian dissyllable is radical, unless there can be demonstrated in some part of it a formative value; and a language wholly composed of such words is a root-language. Neither is the possibility to be denied that a language like Chinese may have had at some period of its history the weak beginnings of a formal development, since extinguished by the same processes of phonetic decay which an English have wiped out so many signs of a formal character, and brought back so considerable a part of the

vocabulary to monosyllabism; but it remains thus far a possibility merely; and the development would need to have been of the scantiest character to be so totally destroyed by phonetic influences. In languages thus constituted, the only possible external alteration is that phonetic change to which all human speech, from the very beginning of its traditional life, is liable; the only growth is internal, by that multiplication and adaptation and improvement of meanings which is equally an inseparable part of all language-history. This may include the reduction of certain elements to the value of auxiliaries, particles, form-words, such as play an important part in analytical tongues like English, and are perhaps also instanced in prehistoric Aryan speech by the class of pronominal roots. Phrases take the place of compounds and of inflexions, and the same element may have an auxiliary value in certain connexions while retaining its full force in others, like, for instance, our own *have*. It is not easy to define the distinction between such phrase-collocations and the beginnings of agglutination; yet the distinction itself is in general clearly enough to be drawn (like that in French between *donnerai* and *ai donné*), when the whole habit of the language is well understood.

Such languages, constituting the small minority of human tongues, are wont to be called "isolating," i.e., using each element by itself, in its integral form. All besides are "agglutinative," or more or less compounded into words containing a formal part, an indicator of class-value. Here the differences, in kind and degree, are very great; the variety ranges from a scantiness hardly superior to Chinese isolation up to an intricacy compared with which Aryan structure is hardly fuller than Chinese. Some brief characterization of the various families of language in this respect will be given farther on, in connexion with their classification. The attempt is also made to classify the great mass of agglutinating tongues under different heads: those are ranked as simply "agglutinative" in which there is a general conservation of the separate identity of root or stem on the one hand, and of formative element, suffix or prefix, on the other; while the name "inflective," used in a higher and pregnant sense, is given to those that admit a superior fusion and integration of the two parts, to the disguise and loss of separate identity, and, yet more, with the development of an internal change as auxiliary to or as substitute for the original agglutination. But there is no term in linguistic science so uncertain of meaning, so arbitrary of application, so dependent on the idiosyncrasy of its user, as the term "inflective." Any language ought to have the right to be called inflective that has inflexion: that is, that not merely distinguishes parts of speech and roots and stems formally from one another, but also conjugates its verbs and declines its nouns; and the name is sometimes so used. If, again, it be strictly limited to signify the possession of *inner flexion* of roots and stems (as if simply agglutinated forms could be called "inflective"), it marks only a difference of degree of agglutination, and should be carefully used as so doing. As describing the fundamental and predominant character of language-structure, it belongs to only one family of languages, the Semitic, where most of the work of grammatical distinction is done by internal changes of vowel, the origin of which thus far eludes all attempts at explanation. By perhaps the majority of students of language it is, as a generally descriptive title, restricted to that family and one other, the Indo-European or Aryan; but such a classification is not to be approved, for, in respect to this characteristic, Aryan speech ranks not with Semitic but with the great body of agglutinative tongues. To few of these can the name be altogether denied, since there is hardly a body of related dialects in existence that does



not exhibit some items of "inflective" structure; the Aryan is only the one among them that has most to show. Outside the Semitic, at any rate, one should not speak of inflective and non-inflective languages, but only of languages more inflective and less inflective.

To account for the great and striking differences of structure among human languages is beyond the power of the linguistic student, and will doubtless always continue so. We are not likely to be able even to demonstrate a correlation of capacities, saying that a race which has done this and that in other departments of human activity might have been expected to form such and such a language. Every tongue represents the general outcome of the capacity of a race as exerted in this particular direction, under the influence of historical circumstances which we can have no hope of tracing. There are striking apparent anomalies to be noted. The Chinese and the Egyptians have shown themselves to be among the most gifted races the earth has known; but the Chinese tongue is of unsurpassed jejuneness, and the Egyptian, in point of structure, little better, while among the wild tribes of Africa and America we find tongues of every grade, up to a high one, or to the highest. This shows clearly enough that mental power is not measured by language-structure. But any other linguistic test would prove equally insufficient. On the whole, the value and rank of a language are determined by what its users have made it do. The reflex action of its speech on the mind and culture of a people is a theme of high interest, but of extreme difficulty, and apt to lead its investigators away into empty declamation; taking everything together, its amount, as is shown by the instances already referred to, is but small. The question is simply one of the facilitation of work by the use of one set of tools rather than another; and a poor tool in skilful hands can do vastly better work than the best tool in unskilful hands—even as the ancient Egyptians, without steel or steam, turned out products which, both for colossal grandeur and for exquisite finish, are the despair of modern engineers and artists. In such a history of development as that of human speech a fortunate turn may lead to results of unforeseen value; the earlier steps determine the later in a degree quite beyond their own intrinsic importance. Everything in language depends upon habit and analogy; and the formation of habit is a slow process, while the habit once formed exercises a constraining as well as a guiding influence. Hence the persistency of language-structure: when a certain sum and kind of expression is produced, and made to answer the purposes of expression, it remains the same by inertia; a shift of direction becomes of extreme difficulty. No other reason can at present be given why in historical time there has been no marked development out of one grade of structure into another; but the fact no more shakes the linguistic scholar's belief in the growth of structure than the absence of new animal species worked out under his eyes shakes the confidence of the believer in animal development. The modifying causes and their modes of action are clearly seen, and there is no limit to the results of their action except what is imposed by circumstances.

It is in vain to attempt to use dates in language-history, to say when this or that step in development was taken, and how long a period it cost, especially now that the changed views as to the antiquity of man are making it probable that only a small part of the whole history is brought within the reach even of our deductions from the most ancient recorded dialects. At any rate, for aught that we know or have reason to believe, all existing dialects are equally old; every one alike has the whole immeasurable past of language-life behind it, has reached its present condition by advance along its own line of growth and

change from the first beginnings of human expression. Many of these separate lines we clearly see to converge and unite, as we follow them back into the past; but whether they all ultimately converge to one point is a question quite beyond our power to answer. If in this immensity of time many languages have won so little, if everywhere language-growth has been so slow, then we can only differ as to whether it is reasonably certain, or probable, or only possible, that there should have been a considerable first period of human existence without traditional speech, and a yet more considerable one before the fixation of so much as should leave abiding traces in its descendants, and that meanwhile the race should have multiplied and scattered into independent communities. And the mere possibility is enough to exclude all dogmatic assertion of the unity of origin of human speech, even assuming unity of origin of the human race. For to prove that identity by the still existing facts of language is utterly out of the question; the metamorphosing effect of constant change has been too great to allow it. In point of fact, taking languages as they now exist, only those have been shown related which possess a common structure, or have together grown out of the more primitive radical stage, since structure proves itself a more constant and reliable evidence than material. And this is likely ever to be the case; at any rate, to trace all the world's languages so far back toward their beginnings as to find in them evidences of identity is beyond the wildest hope. We must be content with demonstrating for those beginnings a unity of kind as alike a body of formless roots. But, on the other hand, since this unity is really demonstrated, since all structure is the result of growth, and no degree of difference of structure, any more than of difference of material, refuses explanation as the result of discordant growth from identical beginnings, it is equally inadmissible to claim that the diversities of language prove it to have had different beginnings. That is to say, the question of the unity of speech, and yet more that of the unity of the race, is beyond the reach of the student of language; the best view he can attain is the hypothetical one, that, if the race is one, the beginnings of speech were perhaps one—but probably not, even then. This negative conclusion is so clearly established as to leave no excuse for the still oft-repeated attempts to press language into service on either side of the controversy respecting human unity of race.

That all making and changing of language is by the act of its speakers is too obvious to call for discussion. No other force capable of acting and of producing effects is either demonstrable or conceivable as concerned in the work. The doctrine that language is an organism, growing by its own inherent powers, exempt from the interference of those who use it, is simply an indefensible paradox. Every word that is uttered is so by an act of human will, at first in imitation of others, then more and more by a formed and controlling habit; it is accessible to no change except by influences working in the speaker's mind, and leading him to make it otherwise. Not that he is aware of this, or directs his action knowingly to that end. The whole process is unconscious. If any implication of reflective or intended action can be shown to inhere in any doctrine of linguistic science, it vitiates that doctrine. The attitude of the ordinary speaker towards his language is that of unreasoning acceptance; it seems to him that his names for things are their real names, and all others unintelligent nicknames; he thinks himself to possess his speech by the same tenure as his sight or hearing; it is "natural" to him (or, if he reasons about it, he attributes it to a divine origin, as races beginning to philosophize are wont to ascribe their various social institutions to their

gods); he knows nothing of its structure and relations; it never occurs to him to find fault with it, or to deem it insufficient and add to or change it; he is wholly unaware that it does change. He simply satisfies his social needs of communication by means of it; and if he has anything to express that is different from what has been expressed before, he takes the shortest way to a provision for the need; while any relaxation of the energy of utterance tends to a variation in the uttered combinations; and thus changes come by his act, though without his knowledge. His sole object is, on the basis of what language he has, to make known his thought in the most convenient way to his fellow; everything else follows with and from that. Human nature and circumstances being what they are, what follows actually is, as already shown, incessant growth and change. For it we have not to seek special disturbing causes in the history of the speakers, although such may come in to heighten and quicken the change; we know that even in a small community, on a narrow islet, cut off from all intercourse with other communities, the speech would grow different—as certainly, if not as rapidly, as anywhere in the world—and only by the action of its speakers: not that the speakers of a language act in unison and simultaneously to produce a given change. This must begin in an individual, or more or less accidentally in a limited number of individuals, and spread from such example through the community. Initiation by one or a few, acceptance and adoption by the rest,—such is the necessary method of all linguistic change, and to be read as plainly in the facts of change now going on among ourselves as in those of former language. The doctrine of the inaccessibility of language to other action than that of its speakers does not imply a power in the individual speaker to create or alter anything in the common speech, any more than it implies his desire to do so. What he suggests by his example must be approved by the imitation of his fellows, in order to become language. The common speech is the common property, and no one person has any more power over it than another. If there are, for example, a thousand speakers of a certain dialect, each one wields in general a thousandth part of the force required to change it—just with so much more as may belong to his excess of influence over his fellows, due to recognized superiority of any kind on his part. His action is limited only by their assent; but this is in effect a very narrow limitation, insuring the adoption of nothing that is not in near accordance with the already existing; though it is also to be noted that he is as little apt to strike off into startling change as they to allow it; since the governing power of already formed habits of speech is as strong in him as in them. That change to which the existing habits naturally lead is easy to bring about; any other is practically impossible. It is this tendency on the part of the collective speakers of a language to approve or reject a proposed change according to its conformity with their already subsisting usages that we are accustomed to call by the fanciful name “the genius of a language.”

On the relation of the part played in language-change by the individual to that by the community, in combination with the inevitableness of change, rests the explanation of the dialectic variation of language. If language were stable there would of course be no divarication; but since it is always varying, and by items of difference that proceed from individuals and become general by diffusion, there can be uniformity of change only so far as diffusion goes, or as the influences of communication extend. Within the limits of a single community, small or large, whatever change arises spreads gradually to all, and so becomes part of the general speech; but let that community become divided into two (or more) parts, and then

the changes arising in either part do not spread to the other, and there begins to appear a difference in linguistic usage between them. It is at first slight, even to insignificance; not greater than exists between the dialects of different localities or ranks or occupations in the same community, without detriment to the general unity of speech. This unity, namely, rests solely on mutual intelligibility, and is compatible with no small amount of individual and class difference, in vocabulary, in grammar, and in pronunciation; indeed, in the strictest sense, each individual has a dialect of his own, different from that of every other, even as he has a handwriting, a countenance, a character of his own. And every item of change, as it takes place, must have its season of existence as a local or class or trade peculiarity, before it gains universal currency; some of them linger long in that condition, or never emerge from it. All these differences in the speech of different sub-communities within the same community are essentially dialectic; they differ not in kind, but only in degree, from those which separate the best-marked dialects; they are kept down by general communication within the limit of general mutual intelligibility. Where that restraining influence ceases, the limit is gradually but surely overpassed, and real dialects are the result. From what we know of the life of language we can say positively that continued uniformity of speech without continued community is not practicable. If it were possible to divide artificially, by an impassable chasm or wall, a people one for ages, and continuing to occupy the same seats, the language of the divided parts would at once begin to be dialectically different; and after sufficient time had elapsed, each would have become unintelligible to the other. That is to say, whenever a community of uniform speech breaks up, its speech breaks up also; nor do we know of any other cause of dialectic diversity.

In applying this explanation of dialectic growth we have to allow for modifying circumstances of various nature, which alter not indeed the fact but the rate and kind of divarication. Some languages grow and change much more rapidly than others, with a corresponding effect upon divarication, since this is but a result of discordant growth. Usually, when there is division of a community, the parts get into different external circumstances, come in contact or mingle with different neighbouring communities, and the like; and this quickens and increases their divergence of speech. But the modifying factor of by far the highest importance, here as elsewhere in the history of language, is civilization. Civilization in its higher forms so multiplies the forces of communication as to render it possible that the widely-divided parts of one people, living in circumstances and under institutions of very different character, should yet maintain a substantial oneness of speech; of this there is no more striking example than the two great divisions of the English-speaking people on opposite sides of the Atlantic. On the other hand, a savage people cannot spread even a little without dialectic disunity; there are abundant examples to be met with now of mutually unintelligible speech between the smallest subdivisions of a race of obviously kindred tongue—as the different clusters of huts on the same coral islet. It is with linguistic unity precisely as it is with political unity, and for the same reasons. Before the attainment of civilization the human race, whether proceeding from one centre of dispersion or from several, was spread over the earth in a state of utter disintegration; but every centre of civilization becomes also a centre of integration; its influences make for unity of speech as of all other social institutions. Since culture has become incontestably the dominant power in human history, the unifying forces in language have also been

stronger than the diversifying; and with culture at its full height, and spread equally to every land and race, one universal language, like one universal community, is not an absurdity or theoretic impossibility, but only a Utopian or millennial dream.

Dialectic variation is thus simply a consequence of the movements of population. As the original human race or races, so the divisions or communities of later formation, from point to point through the whole life of man on the earth, have spread and separated, have jostled and interfered, have conquered and exterminated or mingled and absorbed; and their speech has been affected accordingly. Hence something of these movements can be read in the present condition of languages, as in a faithful though obscure record—more, doubtless, than can be read in any other way, however little it may be when viewed absolutely. Dialectic resemblances point inevitably back to an earlier unity of speech, and hence of community; from what we know of the history of speech, they are not to be accounted for in any other way. The longer the separation that has produced the diversity, the greater its degree. With every generation, the amount of accordance decreases and that of discordance increases; the common origin of the dialects is at first palpable, then evident on examination, then to be made out by skilled research, then perhaps no longer demonstrable at all; for there is plainly no limit to the possible divergence. So long, now, as any evidence of original unity is discoverable we call the languages "related dialects," and combine them into a "family." The term "family" simply signifies a group of languages which the evidence thus far at command, as estimated by us, leads us to regard as descended by the ordinary processes of dialectic divarication from one original tongue. That it does not imply a denial of the possibility of wider relationship is obvious from what has been said above. That there is abundant room for error in the classification represented by it is also clear, since we may take purely accidental resemblances, or the results of borrowing, for evidence of common descent, or may overlook or wrongly estimate real evidences, which more study and improved method will bring to light. Grouping into families is nothing more than the best classification attainable at a given stage in the progress of linguistic science; it is in no small part provisional only, and is always held liable to modification, even sweeping, by the results of further research. Of some families we can follow the history by external evidences a great way back into the past; their structure is so highly developed as to be traced with confidence everywhere; and their territory is well within our reach: such we regard with the highest degree of confidence, hardly allowing for more than the possibility that some other dialect, or group, or now-accepted family even, may sometime prove its right to be added on. But these are the rare exceptions; in the great majority of cases we have only the languages as they now exist, and in more or less scanty collections, of every degree of trustworthiness; and even their first grouping is tentative and incomplete, and involves an adjournment of deeper questions to the day of more light. To complete and perfect the work of classification by relationship, or the establishment of families and their subdivisions, is the first object of the comparative study of languages. No other classification has a value in the least comparable with it; that by grade of structure is a mere recreation, leading to nothing; that by absolute worth is of no account whatever, at any rate in the present state of our knowledge. On genetic relationship, in the first place, is founded all investigation of the historical development of languages; since it is in the main the comparison of related dialects, even in the case of families having a long recorded history, and

elsewhere only that, that gives us knowledge of their earlier condition, and enables us to trace the lines of change. In the second place, and yet more obviously, with this classification is connected all that language has to teach as to the affinities of human races; whatever aid linguistic science renders to ethnology rests upon the proved relationships of human tongues.

That a classification of languages, to which we have now to proceed, is not equivalent to a classification of races, and why this is so, is evident enough from the principles which have been brought out by our whole discussion of languages, and which, in their bearing upon this particular point, may well be recapitulated here. No language is a race-characteristic, determined by the special endowments of a race; all languages are of the nature of institutions, parallel products of powers common to all mankind—the powers, namely, involved in the application of the fittest available means to securing the common end of communication. Hence they are indefinitely transferable, like other institutions—like religions, arts, forms of social organization, and so on—under the constraining force of circumstances. As an individual can learn any language, foreign as well as ancestral, if it be put in his way, so also a community, which in respect to such a matter is only an aggregate of individuals. Accordingly, as individuals of very various race are often found in one community, speaking together one tongue, and utterly ignorant of any other, so there are found great communities of various descent, speaking the dialects of one common tongue, which at some period historical circumstances have imposed upon them. The conspicuous example, which comes into every one's mind when this subject is discussed, is that of the Romanic countries of southern Europe, all using dialects of a language which, 2500 years ago, was itself the insignificant dialect of a small district in central Italy; but this is only the most important and striking of a whole class of similar facts. Such are the results of the contact and mixture of races and languages. If language-history were limited to growth and divarication, and race-history to spread and dispersion, it would be a comparatively easy task to trace both backward toward their origin; as the case is, the confusion is inextricable and hopeless. Mixture of race and mixture of speech are coincident and connected processes; the latter never takes place without something of the former; but the one is not at all a measure of the other, because circumstances may give to the speech of the one element of population a greatly disproportionate preponderance. Thus, there is left in French only an insignificant trace of the Celtic dialects of the predominant race-constituent of the French people; French is the speech of the Latin conquerors of Gaul, mixed perceptibly with that of its later Frankish conquerors; it was adopted in its integrity by the Norse conquerors of a part of the land, then brought into Britain by the same Norsemen in the course of their further conquests, this time only as an element of mixture, and thence carried with English speech to America, to be the language of a still further mixed community. Almost every possible phase of language-mixture is traceable in the history of the abundant words of Latin origin used by American negroes. What events of this character took place in pre-historic time we shall never be able to tell. If any one chooses to assert the possibility that even the completely isolated dialect of the little Basque community may have been derived by the Iberian race from an intrusive minority as small as that which made the Celts of Gaul speakers of Latin, we should have to admit it as a possibility—yet without detriment to the value of the dialect as indicating the isolated race-position of its speakers. In strictness, language is never a proof of race,

either in an individual or in a community; it is only a probable indication of race, in the absence of more authoritative opposing indications; it is one evidence, to be combined with others, in the approach towards a solution of the confessedly insoluble problems of human history. But we must notice, as a most important circumstance, that its degree of probability is greatest where its aid is most needed, in prehistoric periods and among uncultivated races; since it is mainly civilization that gives to language a propagative force disproportionate to the number of its speakers. On the whole, the contributions of language to ethnology are practically far greater in amount and more distinct than those derived from any other source.

The genetical classification of languages, then, is to be taken for just what it attempts to be, and no more: primarily as a classification of languages only; but secondarily as casting light, in varying manner and degree, on movements of community, which in their turn depend more or less upon movements of races. It is what the fates of men have left to represent the tongues of men—a record imperfect even to fragmentariness. Many a family once as important as some of those here set down has perhaps been wiped out of existence, or is left only in an inconspicuous fragment; one and another has perhaps been extended far beyond the limits of the race that shaped it,—which, we can never tell to our satisfaction.

We begin with the families of highest importance and nearest to ourselves.

1. *Aryan (Indo-European, Indo-Germanic) Family*.—To this family belongs incontestably the first place, and for many reasons: the historical position of the peoples speaking its dialects, who have now long been the leaders in the world's history; the abundance and variety and merit of its literatures, ancient and modern, which, especially the modern, are wholly unapproached by those of any other division of mankind; the period covered by its records, hardly exceeded in duration by any other; and, most of all, the great variety and richness of its development. These advantages make of it an illustration of the history of human speech with which no other family can bear a moment's comparison as to value, however important various other families may be in their bearing on one and another point or department of history, and however necessary the combination of the testimony of all to a solution of the problems involved in speech. These advantages have made Aryan language the training-ground of comparative philology, and its study will always remain the leading branch of that science. Many matters of importance in its history have been brought up and used as illustrations in the preceding discussion; but as its constitution and ascertained development call for a fuller and more systematic exposition than they have found here, a special section is devoted to the subject (see p. 781 *sq.* below).

2. *Semitic Family*.—This family also is beyond all question the second in importance, on account of the part which its peoples (Hebrews, Phœnicians, Assyrians, Syrians, Arabs, Abyssinians, &c.) have played in history, and of the rank of its literatures. For a special treatment of it see SEMITIC. Some of the peculiarities of the language have been alluded to above; in the monotony and rigidity of its trilateral roots, and in the extended use which it makes of internal vowel-change ("inflection" in the special sense of that term) for the purposes of grammatical distinction, it is more peculiar and unlike all the other known families of language than these are unlike one another. There are, and perhaps will always be, those to whom the peculiarities just mentioned will seem original; but if the views of language and its history taken above are in the main true, then that opinion is untenable; Semitic language must have grown into its present forms out of beginnings accordant in kind, if not identical in substance, with those of other families; and the only question remaining to be solved is, through what processes and under what governing tendencies Semitic speech should have arrived at its present state. And with this solution is most obviously and incontestably bound up that of the other interesting and much discussed question, whether the Semitic family can be shown to be related with other families, especially with our own Aryan. To some the possession in common of grammatical gender, or of the classification of objects in general as masculine and feminine, is of itself enough to prove such relationship; but, though the fact is a striking one, and of no small importance as an indication, this degree of value can by no means be attributed to it in the present state of our knowledge—any more than to any other single item of structure among the infinite variety

of such, distributed among the multitude of human tongues. Many others compare the Semitic and Aryan "roots" with one another, and believe themselves to find there numerous indications of identity of material and signification; but these also must pass for insufficient, until it shall prove possible by their aid to work out an acceptable theory of how Semitic structure should have grown out of such radical elements as underlie Aryan structure, or out of the accordant initial products of a structural growth that afterwards diverged into two so discordant forms. To show that, both the material and the method have been hitherto wanting, and any confident decision is at least premature; but present probabilities are strongly against the solubility of the question. While many general considerations favour the ultimate unity of these two great civilized and civilizing white races of neighbouring homes, and no discordance of speech (as was shown above) can ever be made to prove their diversity of origin, it seems in a high degree unlikely that the evidence of speech will ever be made to prove them one. As regards the often-claimed relationship of Semitic with Hamitic language, see the following section.

3. *Hamitic Family*.—The prominent importance of this family is due to a single one of its members, the Egyptian; in all other respects it is quite insignificant. It occupies the north-eastern corner of Africa, with the border-lands of that continent stretching westward along the whole shore of the Mediterranean, and southward to beyond the equator. It falls into three principal divisions: (1) the ancient Egyptian, with its descendant, the more modern Coptic (itself now for some centuries extinct; see EGYPT, COPTIC); (2) the Libyan or Berber languages of northern Africa; (3) the Ethiopic languages of eastern Africa. Its situation thus plainly suggests the theory of its intrusion from Asia, across the isthmus of Suez, and its gradual spread from that point; and the theory is strongly favoured by the physical character of the Hamites, and the historical position especially of the Egyptians, so strikingly different from that of the African races in general. Linguistic evidences of the relationship of Hamite with Semite have also been sought, and by many believed to be found; but the maintenance of the two families in their separateness is an indication that those evidences have not yet been accepted as satisfactory; and such is indeed the case. The Egyptian is a language of extreme simplicity of structure, almost of no structure at all. Its radical words are partly monosyllabic, partly of more than one syllable, but not in the latter case any more than in the former showing traceable signs of extension by formative processes from simple elements. It has no derivative apparatus by which noun-stems are made from roots; the root is the stem likewise; there is nothing that can be properly called either declension or conjugation; and the same pronominal particles or suffixes have now a subjective value, indicating use as a verb, and now a possessive, indicating use as a noun. There is no method known to linguistic science by which the relationship of such a tongue as this with the highly and peculiarly inflective Semitic can be shown, short of a thorough working out of the history of development of each family taken by itself, and a retracing in some measure of the steps by which each should have arrived at its present position from a common starting-point; and this has by no means been done. In short, the problem of the relation of Semitic with Hamitic, not less than with Aryan, depends upon that of Semitic growth, and the two must be solved together. There are striking correspondences between the pronouns of the two families, such as, if supported by evidences from other parts of their material, would be taken as signs of relationship; but, in the absence of such support, they are not to be relied upon, not till it can be shown to be possible that two languages could grow to be so different in all other respects as are Egyptian and Hebrew, and yet retain by inheritance corresponding pronouns. And the possession of grammatical gender by Aryan, Semitic, and Hamitic speech, and by them almost alone, among all human languages, though an extremely noteworthy fact, is (as was pointed out above) in the present condition of linguistic science quite too weak a basis for a belief in the original identity of the two families.

Egyptian is limited to the delta and valley of the Nile, and is the only Hamitic language which has ancient records; of the others the existing forms alone are known.

The Libyan or Berber division of the family occupies the inhabitable part of northern Africa, so far as it has not been displaced by intrusive tongues of other connexion—in later times the Arabic, which since the Mohammedan conquest has been the cultivated tongue of the Mediterranean coast, while the earlier Vandal, Latin, and Punic have disappeared, except in the traces they may have left in Berber dialectic speech. The principal dialects are the Kabyle, the Shilha, and the Turesk or Tamashek, corresponding nearly to the ancient Numidian, Mauretanian, and Gætalian respectively. Some authorities add the Hausa, from farther south, while by others this is considered a Semitic, and by yet others a negro tongue.

The third or Ethiopic division includes as its chief members the Beja or Bisharin, the Saho, the Dankali, the Somali, and the most

inland Galla; the first two lying along the Red Sea north of Semitic Abyssinia, the others south of it, to the equator. By some authorities (Lepsius, Bleek) there is added to the Hamitic family as a fourth division a group from extreme southern Africa, the Hottentot and Bushman languages. The ground of this classification is the possession by the Hottentot of the distinction of grammatical gender, and even its designation by signs closely corresponding to those used in the Ethiopic division. Others deny the sufficiency of this evidence, and rank the Hottentot as a separate group of African dialects, adding to it provisionally the Bushman, until better knowledge of the latter shall show whether it is or is not a group by itself. If the Hottentot be Hamitic, we shall have to suppose it cut off at a very remote period from the rest of the family, and forced gradually southward, while all the time suffering mixture both of speech and of blood with the negro races, until the physical constitution of its speakers has become completely metamorphosed, and of its original speech no signs are left save those referred to above; and while such exceptional phonetic peculiarities have been worked out as the use of the clicks or clacking sounds (see HOTTENTOTS); and this must be regarded as at least extremely difficult.

4. *Monosyllabic or South-eastern Asiatic Family.*—This body of languages may well enough be the next taken up; and here again (as was the case with the preceding family) on account of the prominent importance of one of its dialects and of the people speaking it—the Chinese people and language. The territory of the family includes the whole south-eastern corner of Asia: China on the north-east, Farther India in the south, and the high plateau of Tibet, with the neighbouring Himalayan regions, to the westward. The ultimate unity of all these languages rests chiefly upon the evidence of their form, as being all alike essentially monosyllabic and isolating, or destitute of formal structure; the material correspondences among them, of accordant words, are not sufficient to prove them related. The Chinese itself can be followed up, in contemporary records, to a period not far from 2000 A.C., and the language, the people, and their institutions, are then already in the main what they have ever since continued to be (see CHINA); the other leading tongues come into view much later, as they receive culture and religion from China on the one hand (the Ananites), or from India on the other (the Tibetans, Burmese, Siamese); and the territory includes great numbers of wild tribes unknown until our own times, whose race-relations and language-relations are as yet very obscure. Current opinion tends to regard the Ananites, Peguans, and Cambodians as forming a more nearly related group or division of the family, and as having been the earlier population of Farther India, in part dispossessed and driven forward by the later intrusion from the north of Siamese and Burmese, of whom the former are more nearly related to the Chinese, and the latter to the Tibetans; but these groupings rest as yet upon too slender evidence to be accepted with confidence.

The character of the languages of this family, especially as instanced by its most important member, the Chinese, has been pretty fully set forth in the general discussions above. They are languages of roots: that is to say, there is not demonstrable in any of their words a formative part, limiting the word, along with others similarly characterized, to a certain office or set of offices in the formation of the sentence. That the words are ultimate roots, come down from the first period of language-making, we have no reason whatever to believe; and they may possibly have passed through processes of growth which equipped them with some scanty supply of forms; but no evidence to that effect has yet been produced. The indications relied on to show an earlier polysyllabism in the family (though already in Chinese reduced to monosyllabism before the earliest historical appearance of the language, some 4000 years ago) are the comparatively recent loss of certain final mutes in Chinese words, and the presence on a considerable scale in Tibetan spelling of added initial and final consonants, now silent in the literary dialect, but claimed to be still uttered in some parts of the country. If the theory connecting these phenomena be established, the Tibetan will approve itself to be by far the most primitive of the dialects of the family, furnishing the key to the history of the rest.

For further details respecting the various tongues of the monosyllabic family, the articles on the different divisions of its territory (BURMAH, CHINA, SIAM, TIBET, &c.) may be consulted. The languages all alike show an addition to the resources of distinction possessed by languages in general in the use of tones: that is to say, words of which the alphabetic elements are the same differ in meaning according as they are uttered in a higher or a lower tone, with the rising or the falling inflexion, and so on. By this means, for example, the monosyllabic elements of the literary Chinese, numbering but 500 as we should write them, are raised to the number of about 1500 words.

5. *Ural-Altaic (Scythian, Turanian) Family.*—China and Tibet are bordered on the north and west by the eastern branches of another immense family, which stretches through central and

northern Asia into Europe, overlapping the European border in Turkey, and reaching across it in Russia and Scandinavia to the very shore of the Atlantic. Usage has not so definitely determined as in the case of most other families by what name it shall be called; Turanian is perhaps the commonest appellation, but also the most objectionable. Five principal branches are generally reckoned as composing the family. The two easternmost are the Tungusian, with the Manchu for its principal division, and the Mongol (see MONGOLS). Of these two the language is exceedingly simple in structure, being raised but little above the formlessness of the Chinese. The three others are: the Turkish or Tatar, the dialects of which reach from the mouth of the Lena (Yakut) to Turkey in Europe; the Samoyed, from the Altai down to the arctic shore of Asia, add along this to the White Sea—an unimportant congeries of barbarous tribes; and the Finno-Hungarian, including the tongues of the two cultivated peoples from which it takes its name, and also those of a great part of the population of northern and central Russia, to beyond the Ural Mountains, and finally the Lappish, of northern Scandinavia. The nearer relation of the Samoyed is with the Finno-Hungarian. The Turkish is a type of a well-developed language of purely agglutinative structure: that is, lacking that higher degree of integration which issues in internal change. Whether this degree is wholly wanting in Finnish and Hungarian is made a question; at any rate, the languages named have no reason to envy the tongues technically called "inflective." Of a value not inferior to that of inflective characteristics is one that belongs to all the Ural-Altaic tongues, in varying measure and form, and helps to bind them together into a single family—the harmonic sequence of vowels, namely, as between root and endings, or a modification of the vowels of the endings to agree with that of the root or its final syllable.

While the physical race-characteristics known as Mongolian are wanting in the speakers of the western dialects of this family, they are conspicuously present in the people of Japan and Corea; and hence the tendency of scholars to endeavour to connect the languages of the two latter countries, since they also are of agglutinative structure (see JAPAN and COREA), with the family now under treatment, as also with one another. Neither connexion, however, can at present be regarded as proved.

Other languages of north-eastern Asia, too little known to group, and too unimportant to treat as separate families, may be mentioned here by way of appendix to their neighbors of the most diversified and widespread Asiatic family. They are the Aino, of Yezo and the Kurile Islands with part of the neighbouring coast; the Kamchatkan; and the Yukagir and Tchukchi, of the extreme north-east.

The opinion was recently held by many scholars that the agglutinative dialects—Accadian, Sumirian, &c.—of the presumed founders of Mesopotamian culture and teachers of the Assyrian Semites (see BABYLONIA) belonged to the Ural-Altaic family, and especially to its Finno-Hungarian branch; but it is believed to be now generally abandoned. The mere possession of an agglutinative structure cannot be taken as proving anything in the way of relationship.

6. *Dravidian or South-Indian Family.*—This is an important body of nearly and clearly related tongues, spoken by about 50,000,000 people, doubtless representing the main population of all India at the time when the intrusive Aryan tribes broke in from the north-west, and still filling most of the southern peninsula, the Deccan, together with part of Ceylon. In an earlier article (see INDIA) the names of the dialects have been given, with indication of their locality and relative importance, and with some account of their leading features. They are languages of a high grade of structure, and of great power and euphony; and the principal ones have enjoyed a long cultivation, founded on that of the Sanskrit. As they obviously have no Aryan affinities, the attempt has been made to connect them also with the Ural-Altaic or Turanian family, but altogether without success, although there is nothing in their style of structure that should make such connexion impossible.

Not all the tribes that make up the non-Aryan population of India speak Dravidian dialects. The Santals and certain other wild tribes appear to be of another lineage, and are now generally known as Kolarian.

7. *Malay-Polynesian Family.*—The islands, greater and smaller, lying off the south-eastern coast of Asia and those scattered over the Pacific, all the way from Madagascar to Easter Island, are filled with their own peculiar families of languages, standing in no known relationship with those of the mainland. The principal one among them is the great Malay-Polynesian family. It falls into two principal divisions, Malayan and Polynesian. The Malayan includes, besides the Malay proper (see MALAYS), which occupies the Malaccan peninsula (yet doubtless not as original home of the division, but by immigration from the islands), the languages also of Sumatra, Java, Borneo, &c., of the Philippine Islands, of Formosa, and of Madagascar, together with the coasts of Celebes and other islands occupied in the interior by Papuans. The Polynesian division includes most of the tongues of the remaining scattered groups of

Islands, and that of New Zealand. Probably to these are to be added, as a third division, the Melanesian dialects of the Melanesian Archipelago, of which both the physical and the linguistic peculiarities would in that case be ascribed to mixture with the black Papuan races. All these languages are extremely simple in phonetic form, and of a low grade of structure, the Polynesian branch being in both respects the lowest, and some of the Malayan dialects having reached a development considerably more advanced. The radical elements are much oftener of two syllables than of one, and reduplication plays an important part in their extension and variation. Malay literature goes back as far as to the 13th century, and there are Javan records even from the early centuries of our era, the result of religion and culture introduced into that island from Brahmanic India; but none of these have yet been utilized, as they doubtless in time will be, for tracing out the special laws of historical development prevailing in the family.

8. *Other Oceanic Families.*—At least two other families, unconnected with the preceding and with one another, are found among the Pacific islands, and only there. The continental island of Australia, with its dependency Tasmania (where, however, the native tongue has now become extinct), has its own body of probably related dialects, as its own physical type. They have been but imperfectly investigated, their importance, except to the professed student of language, being nothing; but they are not destitute of a rude agglutinative structure of their own. Still less known are the Papuan or Negrito languages, belonging to the black race with frizzled hair inhabiting most of New Guinea, and found also in the interior of some of the other islands, having been driven from the coasts by superior intruders of the Malay race.

9. *Caucasian Languages.*—Of the existing languages of Asia there remain to be mentioned only those of the Caucasian mountains and highlands, between the Black and Caspian Seas, pressed upon the north by Slavonians and Turks, upon the south by Armenians and Kurds and Turks. Its situation makes of the Caucasian a natural eddy in all movements of emigration between Asia and Europe; and its linguistic condition is as if remnants of many families otherwise extinct had been stranded and preserved there. The dialects north of the principal range—Circassian, Mitjaghian, Leaghian, &c.—have not been proved to be related either to one another or to those of the south. Among the latter, the Georgian is much the most widespread and important (see GEORGIA), and, alone among them all, possesses a literature. The Caucasian dialects present many exceptional and difficult features, and are in great part of so high a grade of structure as to have been allowed the epithet inflective by those who attach special importance to the distinction thus expressed.

10. *Remnants of Families in Europe.*—The Basque people of the western Pyrenees, at the angle of the Bay of Biscay, are shown by their speech to be an isolated remnant of some race which was doubtless once much more widely spread, but has now everywhere else lost its separate identity; as such it is of extreme interest to the ethnologist. The Basque language appears to be unrelated to any other on earth. It is of a very highly agglutinative structure, being equalled in intricacy of combination only by a part of the American dialects. Limited as it is in territory, it falls into a number of well-marked dialects, so that it also may not be refused the name of a "family."

The only other case of the kind worth noting is that of the Etruscan language of northern central Italy, which long ago became extinct, in consequence of the conquest and absorption of Etruria by Rome, but which still exists in numerous brief inscriptions (see ETRURIA). Many attempts have been made to connect the language with other families, and it has even quite recently been pronounced Aryan or Indo-European, of the Italian branch, by scholars of high rank; yet it is altogether likely to be finally acknowledged, like the Basque, as an isolated fragment.

In order to complete this review of the languages of the Old World it only remains to notice those of Africa which have not been already mentioned. They are grouped under two heads: the languages of the south and those of the centre of the continent.

11. *South-African or Bantu Family.*—This is a very extensive and distinctly marked family, occupying (except the Hottentot and Bushman territory) the whole southern peninsula of the continent from some degrees north of the equator. It has been already partly described under KAFFRARIA, and will be treated more in detail under the head of ZULU. It is held apart from all other known families of language by a single prominent characteristic—the extent to which it makes use of prefixes instead of suffixes as the apparatus of grammatical distinction; its inflexion, both declensional and conjugal, is by appended elements which precede the stem or root. The most conspicuous part of this is the variety of prefixes, different in singular and plural, by which the various classes or genders (not founded on sex; the ground of classification is generally obscure) of nouns are distinguished; these then reappear in the other members of the sentence, as adjectives and verbs and pronouns, which are determined by the noun, thus producing an alliterative concord that runs through the sentence.

The pronominal determinants of the verb, both subject and object, also come before it; but the determinants of mode of action, as causative, &c., are mostly suffixed. The language in general is rich in the means of formal distinction. Those dialects which border on the Hottentots have, apparently by derivation from the latter, the clicks or clucking-sounds which form a conspicuous part of the Hottentot spoken alphabet.

12. *Central African Languages.*—The remaining languages of Africa form a broad band across the centre of the continent, between the Bantu on the south and the Hamitic on the east and north. They are by no means to be called a family, but rather a great mass of dialects, numbering by hundreds, of varying structure, as to the relations of which there is great discordance of opinion even among the most recent and competent authorities. It is no place here to enter into the vexed questions of African linguistics, or even to touch the varying views upon the subject; that would require a space wholly disproportioned to the importance of African speech in the general sum of human language. There is no small variety of physical type as well as of speech in the central belt; and, partly upon the evidence of lighter tint and apparently higher endowment, certain races are set off and made a separate division of; such is the Nuba-Fulah division of F. Müller, rejected by Lepsius. The latter regarded all the varieties of physical and linguistic character in the central belt as due to mixture between pure Africans of the south and Hamites of the north and east; but this is at present an hypothesis only, and a very improbable one, since it implies modes and results of mixture to which no analogies are quotable from languages whose history is known; nor does it appear at all probable that the collision of two races and types of speech should produce such an immense and diverse body of transitional types. It is far from impossible that the present prominence of the South-African or Bantu family may be secondary, due to the great expansion under favouring circumstances of a race once having no more importance than belongs now to many of the Central-African races, and speaking a tongue which differed from theirs only as theirs differed from one another. None of the Central-African languages is a prefix-language in the same degree as the Bantu, and in many of them prefixes play no greater part than in the world's languages in general; others show special forms or traces of the prefix-structure; and some have features of an extraordinary character, hardly to be paralleled elsewhere. One group in the east (Ologoh, &c.) has a gender distinction, involving that of sex, but really founded on relative power and dignity: things disparaged, including women, are put in one class; things extolled, including men, are put in the other. This is perhaps the most significant hint anywhere to be found of how a gender distinction like that in our own Aryan languages, which we usually regard as being essentially a distinction of sex, while in fact it includes such, may have arisen. Common among the African languages, as among many other families, especially the American, is a generic distinction between animate beings and inanimate things.

13. *American Languages.*—With these the case is closely the same as with the Central-African languages: there is an immense number of dialects, of greatly varied structure, of which as yet even the nearer groupings are only in part made out, while the grade and kind of relationship between the groups, if such there exist, is wholly unclear. Some general statements respecting American languages have been given under AMERICA, and a detailed list and classification of them in the article INDIANS; hence it is unnecessary to go over the subject again in this place. What is most need to note is the very narrow limitation of our present knowledge. Even among neighbouring families like the Algonquin, Iroquois, and Dakota, whose agreement in style of structure (polysynthetic), taken in connexion with the accordant race-type of their speakers, forbids us to regard them as ultimately different, no material correspondence, agreement in words and meanings, is to be traced; and there are in America all the degrees of polysyntheticism, down to the lowest, and even to its entire absence. Such being the case, it ought to be evident to every one accustomed to deal with this class of subjects that all attempts to connect American languages as a body with languages of the Old World are and must be fruitless; in fact, all discussions of the matter are at present unscientific, and are tolerably certain to continue so through all time to come.

*Literature.*—Many of the theoretic points discussed above are treated by the writer with more fulness in his *Language and the Study of Language* (1867) and *IA and Growth of Language* (1875). Other English works to consult are K. Müller's *Lectures on the Science of Language*; Farrar's *Chapters on Language*; Wedgwood's *Origin of Language*; Bayou's *Principles of Philology and Introduction to the Science of Language*, &c. In German, see Paul's *Principien der Sprachwissenschaft* (Halle, 1860); Delbrück's *Einführung in die Sprachwissenschaft* (Leipzig, 1881); there is also an English version; Schleichner's *Deutsche Sprache*; also the work of W. von Humboldt and of H. Steinthal. As to the classification and relationships of languages, see Hovelacque's *La Linguistique* (Paris, 1876), and I. Müller's *Grundriss der Sprachwissenschaft* (Vienna, still in progress). As to the history of the study, see Lersch's *Sprachphilosophie der Alten* (1840); Steinthal's *Geschichte der Sprachwissenschaft bei den Griechen und Römern* (1861); Benfey's *Geschichte der Sprachwissenschaft und Orientalischen Philologie in Deutschland* (1866).



## PART II.—COMPARATIVE PHILOLOGY OF THE ARYAN LANGUAGES.

The study of Aryan comparative philology has from its outset necessarily been in close connexion with the study of Sanskrit, a language unparalleled amongst its cognates in antiquity and distinctness of structure, and consequently the natural basis of comparison in this field. It is therefore not to be wondered at that we find no clear views of the mutual relationship of the individual members of the Aryan family or their position with regard to other languages until Sanskrit began to attract the attention of European philologists, or that the introduction of Sanskrit as an object of study was closely followed by the discovery of the original community of a vast range of languages and dialects hitherto not brought into connexion at all, or only made the objects of baseless speculations. We meet with the first clear conception of this idea of an Indo-European community of languages in the distinguished English scholar Sir William Jones, who, as early as 1786, expressed himself as follows: "The Sanskrit language, whatever may be its antiquity, is of wonderful structure; more perfect than the Greek, more copious than the Latin, and more exquisitely refined than either, yet bearing to both of them a stronger affinity, both in the roots of verbs and in the forms of grammar, than could have been produced by accident; so strong that no philologist could examine all the three without believing them to have sprung from some common source which, perhaps, no longer exists. There is a similar reason, though not quite so forcible, for supposing that both the Gothic and the Celtic, though blended with a different idiom, had the same origin with the Sanskrit."<sup>1</sup> But neither Sir William Jones nor any of his older contemporaries who had arrived at similar conclusions ever raised this important discovery from a brilliant *aperçu* into a valid scientific theory through a detailed and systematic comparison of the languages in question. To have achieved this is the undoubted merit of the German, Franz BOPP (*q.v.*), the founder of scientific philology of the Aryan languages, and subsequently through this example also the founder of comparative philology in general. Next to him Jacob GRIMM (*q.v.*) must be mentioned here as the father of historical grammar. The first part of his famous *Deutsche Grammatik* appeared in 1819, three years after Bopp had published his first epoch-making book, *Ueber das Conjugationssystem der Sanskritsprache*. Bopp's results were here at once utilized, yet Grimm's whole system was entirely independent of that of Bopp, and had no doubt been worked out before Grimm knew of his illustrious predecessor. In fact, their scientific aims and methods were totally different. Bopp's interest was not concentrated in comparison as such, but chiefly inclined towards the explanation of the origin of grammatical forms, and comparison to him was only a means of approaching that end.

In this more or less speculative turn of his interest Bopp showed himself the true son of a philosophical period when general linguistics received its characteristic stamp from the labours and endeavours of men like the two Schlegels and Wilhelm von Humboldt. Jacob Grimm's aims were of a less lofty character than those of Bopp, whose work, to his own mind, was crowned by his theory of the origin of inflexion through agglutination. In confining his task to a more limited range than the vast field of Aryan languages embraced in Bopp's researches, and thus fixing his attention on a group of idioms exhibiting a striking regularity in their mutual relationship, both where

they coincide and where they differ, he made it his foremost object to investigate and illustrate the continuous progress, subject to definite laws, by which these languages had been developed from their common source. He thus raised the hitherto neglected study of the development of sounds to an equal level with the study of grammatical forms, which had so far almost exclusively absorbed all the interest of linguistic research. Grimm's discovery of the so-called "Lautverschiebung," or Law of the Permutation of Consonants in the Teutonic languages (which, however, had been partly found and proclaimed before Grimm by the Danish scholar Rask), became especially important as a stimulus for further investigation in this line. Grimm's influence on comparative philology (which is secondary only to that of Bopp, although he was never a comparative philologist in the sense that Bopp was, and did not always derive the benefit from Bopp's works which they might have afforded him) is clearly traceable in the work of Bopp's successors, amongst whom Friedrich August Pott is universally judged to hold the foremost rank. In his great work, *Etymologische Forschungen auf dem Gebiete der indo-germanischen Sprachen, mit besonderem Bezug auf die Lautumwandlung im Sanskrit, Griechischen, Lateinischen, Litauischen, und Gothischen* (Lemgo, 1833-36), we find Indo-Germanic etymology for the first time based on a scientific investigation of general Indo-Germanic phonology. Amongst Pott's contemporaries Theodor Benfey<sup>2</sup> deserves mention on account of his *Griech-*

<sup>1</sup> Theodor Benfey was born on 28th January 1809 at Nörten, Hanover, the son of a Jewish tradesman who had gained some reputation as an acute and learned Talmudic scholar. At the early age of sixteen he entered the university of Göttingen (which he afterwards exchanged for Munich) to devote himself to the study of classical philology. It was not until after 1830, when he had settled in Frankfurt-on-the-Main as a private teacher, that his attention was drawn towards the study of Sanskrit. In 1834 he went back to Göttingen and began lecturing as a privat-docent. For some time his lectures extended over various branches of classical philology as well as of Oriental and comparative philology, but he soon began to concentrate himself on the latter departments. After he had joined the Christian church he received, in 1848, an extraordinary professorship, and in 1862 he was appointed ordinary professor of Sanskrit and comparative philology. He died on 26th June 1881. Benfey also began his long and brilliant literary career in the field of classics. Besides his dissertation *Observationes ad Anacreontis fragmenta genuina* (Göttingen, 1829), his translation of the comedies of Terence (Stuttgart, 1837) deserves special notice. This was followed by his *Wurzellektionen* in 1839, and his quarto volume on "India" in Ersch and Gruber's *Encyclopädie*, 1840. Through these he at once gained a position of authority both in comparative and Indian philology. Of his other writings the more important are, *Ueber die Monatsnamen einiger alten Völker, insbesondere der Perser, Cappadocier, Juden, Syrer* (written in conjunction with A. Stern), Berlin, 1836; *Ueber das Verhältniss der ägypt. Sprache zum semit. Sprachstamm*, Leipzig, 1844; *Die pers. Keilinschriften, mit Uebersetzung und Glossar*, Leipzig, 1847; *Die Hymnen des Samaveda*, Leipzig, 1848; *Vollständige Grammatik der Sanskritsprache*, Leipzig, 1852; *Chrestomathie aus Sanskritwerken*, Leipzig, 1853; *Panchatantra*, 2 vols., Leipzig, 1859; *Geschichte der Sprachwissenschaft und orient. Philologie in Deutschland*, Munich, 1869. Of his numerous contributions to the various scientific periodicals of the time, those published in the *Abhandlungen der Göttinger Gesellschaft der Wissenschaften* are especially meritorious:—"Ueber die indog. Endungen des Gen. Sing.," vol. xix.; "Einleitung in die Grammatik der ved. Sprache," vol. xix.; "Die quantitätsverschiedenheiten in den Samhita- und Padatexten der Vedan.," vol. xix., xxvii.; "Das indog. Thema des Zahlworts 'Zwei' ist 'du,'" vol. xxi.; "Hermes, Minos, Tartaros," vol. xxii.; "Aitpers. mazdäh=Zend mazdāonh=Skrt. medhān.," vol. xxviii.; "Einige Derivate des indog. Verbuns anāh=nañh.," and "Ueber einige Wörter mit dem Bindevocal i im Rigveda.," vol. xxiv.; "Behandlung des aulautendern a in ná 'wie' und ná 'nicht' im Rigveda, nebst Bemerkungen über die urspr. Aussprache und Accentuierung der Wörter im Veda.," vol. xxvi. Some of his smaller articles in the *Göttinger Gelehrte Anzeigen* were reprinted under the titles of *Vedica und Verwandtes*, Straßburg, 1877, and *Vedica und Linguistica*, ibid., 1880. As the preceding list shows, Benfey's interest had become more and more concentrated on Vedic studies towards the end of his days, and indeed he had planned, as the crowning work of his life, an extensive grammar of Vedic Sans-

<sup>2</sup> For this quotation and the following historical sketch in general see Th. Benfey, *Geschichte der Sprachwissenschaft*, p. 438, Munich, 1869, and especially B. Delbrück, *Introduction to the Study of Language*, p. 1, Leipzig, 1882 (a second German edition appeared in 1884).

*isches Wurzellericon* (Berlin, 1839), a work equally remarkable for copiousness of contents and power of combination, yet showing no advance on Bopp's standpoint in its conception of phonetic changes.

A third period in the history of Indo-Germanic philology is marked by the name of August Schleicher, whose *Compendium der vergleichenden Grammatik der indo-germanischen Sprachen* first appeared in 1861. In the period subsequent to the appearance of Pott's *Etymologische Forschungen*, a number of distinguished scholars, too large to be recorded here individually,<sup>1</sup> had devoted their labours to the different branches of Aryan philology, especially assisted and promoted in their work by the rapidly progressing Vedic (and Avestic) studies that had been inaugurated by Rosen, Roth, Benfey, Westergaard, Müller, Kuhn, Aufrecht, and others. Moreover, new foundations had been laid for the study of the Slavonic languages by Miklosich and Schleicher, of Lithuanian by Kurschat and Schleicher, of Celtic by Zeuss. Of the classical languages Greek had found a most distinguished representative in Curtius, while Corsen, Mommsen, Aufrecht, Kirchhoff, &c., had collected most valuable materials towards the elucidation of Latin and the cognate Italic idioms. In his *Compendium* Schleicher undertook and solved the difficult task of sifting down the countless details amassed since the days of Bopp and Grimm, and thus making the individual languages stand out clearly on their common background, while Bopp's attention had been especially occupied with what was common to all Indo-Germanic tongues. There are two prominent features which characterize this part of Schleicher's work,—his assumption and partial reconstruction of a prehistoric parent-speech, from which the separate Indo-Germanic languages were supposed to have sprung, and the establishment of a long series of phonetic laws, regulating the changes by which that development of the individual idioms had taken place. On Schleicher's views of and contributions towards general comparative philology (which he erroneously proposed to consider as a branch of natural science) we need not enter here.

For some time after Schleicher's premature death (in 1868) Indo-Germanic philology continued in paths indicated by him and Curtius, with the exception, perhaps, of the school founded by Benfey, who had always stood on independent ground. The difference between the two schools, however, was less strikingly marked in their writings, because it chiefly concerns general views of language and the Indo-Germanic languages in particular, although the characteristic task of the period alluded to was that of working out the more minute details of comparison; but behind all this the general interest still clung to Bopp's old glottogonic problems. Lately, however, a new movement has begun, and a younger school of linguists has sprung up who are united in their opposition to many theories of the older generation, yet often differ materially

crit. Death, however, prevented him from completing more than the above-mentioned preliminary studies by means of which he had intended to open the field for his greater work. (For fuller biographical details see Bezenberger, in his *Beiträge*, viii. 239 sq.)

<sup>1</sup> The extensive progress made in this period is best illustrated by the foundation of two periodicals especially devoted to Aryan comparative philology, Kuhn's *Zeitschrift für vergleichende Sprachforschung*, Berlin, from 1851 (now 27 vols.), and Kuhn's *Beiträge zur vergleichenden Sprachforschung*, Berlin, from 1858 (8 vols.). Benfey's school is more especially represented by the contributors to Benfey's *Orient und Occident*, Göttingen (3 vols.), from 1862, and subsequently through Bezenberger's *Beiträge zur Kunde der indogermanischen Sprachen*, Göttingen (8 vols.), from 1877. France possesses two periodicals of the same kind, the *Revue de Linguistique*, Paris, from 1868, and the *Mémoires de la Société de Linguistique de Paris*, also from 1868, while England is represented by the *Proceedings and Transactions of the Philological Society*, and America by the *Transactions of the American Philological Association* (from 1868).

both with regard to method and the solution of individual problems. In its present state this younger school (often branded with the name of Neo-Grammarians, "Junggrammatiker," by its opponents real and imaginary) is marked by certain distinct tendencies. In the first place, they are inclined more or less to abandon glottogonic problems as insoluble, if not for ever, yet for the present and with the scanty means that Aryan philology alone can furnish for this purpose. In this they are in opposition to the whole of the older school. In the second place, they object to the use of all misleading metaphorical comparisons of processes in the history of language with processes of organic development,—comparisons used at all times, but especially cherished by Schleicher. In the third place—and this has been of the greatest practical importance—they hold that our general views of language and our methods of comparison should be formed after a careful study of the living languages, because these alone are fully controllable in every minute detail, and can therefore alone give us a clear insight into the working of the different motive forces which shape and modify language, and that the history of earlier periods of language, consequently, can only be duly illustrated by tracing out the share which each of these forces has had in every individual case of change. Of these forces two are found to be especially prominent—phonetic variation and formation by analogy. They generally work in turns and often in opposition to one another, the former frequently tending to differentiation of earlier unities, the latter to abolition of earlier differences, especially to restoration of conformity disturbed by phonetic change. There are, however, other important differences in the action of the two forces. Phonetic change affects exclusively the pronunciation of a language by substituting one sound or sound-group for another. From this simple fact it is self-evident that phonetic changes as such admit of no exceptions. Pronunciation—that is, the use of certain sounds in certain combinations—is perfectly unconscious in natural unstudied speech, and every speaker or generation of speakers has only one way of utterance for individual sounds or their combinations. If, therefore, a given sound was once changed into another under given circumstances, the new sound must necessarily and unconsciously replace its predecessor in every word that falls under the same rules, because the older sound ceases to be practised and therefore disappears from the language. Thus, for instance, the sound of the short so-called Italian *a* in English has become exchanged for the peculiarly English sound in *man, hat, &c.*, which is so exclusively used and practised now by English speakers that they feel great difficulty in pronouncing the Italian sound, which at an earlier period was almost as frequent in English as in any other language that has preserved the Italian sound up to the present day. Again, the sound of the so-called long English *a* in *make, paper, &c.*, although once a monophthong, is now pronounced as a diphthong, combining the sounds of the English short *e* and *i*, and no trace of the old monophthong is left, except where it was followed by *r*, as in *hare, mare* (also *air, their, where, &c.*), where the *a* has a broader sound somewhat approaching that of the short *a* in *hat*. This last instance may at the same time serve to illustrate the restrictions made above as to sounds changing their pronunciation in certain groups or combinations, or under given circumstances only. We may learn from it that phonetic change need not always affect the same original sound in the same way in all its combinations, but that neighbouring sounds often influence the special direction in which the sound is modified. The different sounds of the English *a* in *make* and *hare* are both equivalents of the same Old English sound *ā* (= the Italian short *a*) in *macian, hāra*. The latter sound has

been split in two, but this process again has taken place with perfect regularity, the one sound appearing before *r*, the other before all other consonants. It is easy to see that the common practice of comprising the history of the Old English *d* in the one rule,—that it was changed into the sound of the *a* in *make* except when followed by an *r*,—can only be defended on the practical ground that this rule is convenient to remember, because the words exhibiting the former change are more numerous than the instances of the latter; apart from this there is nothing to justify the assumption that one of these changes is the rule and the other the exception. The fact is, that we have two independent cases of change, which ought to be stated in two distinct and independent rules according to the different positions in which the original *d* stood before the splitting began. It is also easy to observe that the variety of modifying influences may be much more manifold than in the present instance of *make* and *have*, and that the number of special phonetic rules in such cases must be increased in proportion to the progress made in the investigation of the said modifying powers. In this respect much still remains to be done, but what has been achieved is more than sufficient to prove the correctness of the statement from which we started above, that phonetic rules in themselves are without exceptions, however often phonetic processes may have been crossed and more or less effaced by non-phonetic influences in actual (especially literary) language, such as mixture of dialects, formation by analogy, and the like.

Analogical change, on the other hand, does not affect the pronunciation of a language as a whole in the way phonetic change does, but is confined to the formation and inflexion of single words or groups of words, and therefore very apt to bear an entirely arbitrary and irregular character. A few instances will be sufficient to illustrate this. In Old English a certain number of substantives formed their plurals by mutation of the root-vowels, as *fōt*—*fēt* or *bōc*—*bēc*. In Modern English this system of inflexion has been preserved in some cases, as in *foot*—*feet*, and altered in others as *book*—*books*. Now, while *foot*, *feet*, and *book* are the regular modern phonetic equivalents of the old *fōt*, *fēt*, *bōc*, the plural *books* can in no way be phonetically traced back to the old *bēc*, the phonetical equivalent of which in Modern English would be *\*beech*. The only possible explanation of a form like *books* is that the older *bēc* was at some date given up and replaced by an entirely new formation, shaped after the analogy of the numerous words with a plural in *-s* without modification of the root-vowel. That this should have been done in the case of *book*, but not in that of *foot*, is an accident, which must be accepted as a fact not allowing of any special explanation. Let us now take another instance from the English verb. In Old English the different persons of the preterite indicative in the so-called strong (irregular) verbs were generally distinguished by different root-vowels; *ridan*, "to ride," and *bindan*, "to bind," for instance, form their preterites thus: *ic rād*, *tū ride*, *hē rād*, *wē*, *gē*, *hīs ridon*, and *ic band*, *tū bunde*, *hē band*, *wē*, *gē*, *hīs bundon*. In Modern English this difference in the root-vowels has been abandoned, and *rode*, *bound* now stand for all persons, *rode* being the modern phonetic equivalent of the 1st and 3d sing. *rād*, while *bound* represents the *u*-forms of *bindan*. Inasmuch as a similar process of levelling has been carried through in all preterites of Modern English, regularity prevails even here. But when we look to its results in the individual verbs we soon find that the choice amongst the different forms which might have served as starting-points has been entirely arbitrary. It is indeed impossible to say why the old singular form should have been chosen as a model in one case, as in *rode*, and the old plural form in

another, as in *bound*. From these and numerous similar instances we must draw the conclusion that it is beyond our power to ascertain whence analogical changes may start, and to what extent they may be carried through when once begun. All we can do is to carefully classify the single cases that come under our observation, and in this way to investigate where such changes are especially apt to take place and what is their general direction. As to the latter points, it has been observed before that levelling of existing differences is one of the chief features in analogical change (as in the case of *rode* and *bound*). As to the former, it must be borne in mind that, before any analogical change can take place, some mental connexion must exist between the words or forms serving as models and those which are remodelled after the types suggested to the mind of the speakers through the former. Of such natural mental combinations two classes deserve especial notice: the mutual relationship in which the different, say inflexional, forms of the same word stand to each other, and the more abstract analogies between the inflexional systems of word-groups bearing a similar character, as, for instance, the different declensions of nouns and pronouns, or the different conjugations of verbs. The instance of *rode*, *bound* may serve to illustrate the former category, that of *books* the latter. In the first case a levelling has taken place between the different forms of the root-vowels once exhibited in the different preterite forms of *ridan* or *bindan*, which clearly constitute a natural group or mental unity in consequence of their meaning. The form of *rode* as a plural has simply been taken from the old singular, that of *bound* as a singular from the old plural. In the case of *book*—*books* for *bōc*—*bēc*, this explanation would fall short. Although we might say that the vowel of the singular here was carried into the plural, yet this would not explain the plural *-s*. So it becomes evident that the old declension of *bōc*—*bēc* was remodelled after the declension of words like *arm*—*arms*, which had always formed their plurals in *-s*. Isolated words or forms, on the other hand, which are no part of natural groups or systems, inflexional or formative, must be regarded as commonly safe from alterations through analogy, and are therefore of especial value with regard to establishing rules of purely phonetic development.

It is true that the distinction between phonetic and analogical change has always been acknowledged in comparative philology. At the same time it cannot be denied that analogical changes were for a long time treated with a certain disdain and contempt, as deviations from the only course of development then allowed to be truly "organic" and natural, namely, that of gradual phonetic change (hence the epithet "false" so constantly attached to analogy in former times). Amongst those who have recently contributed most towards a more correct evaluation of analogy as a motive-power in language, Professor Whitney must be mentioned in the first place. In Germany Professor Scherer (*Zur Geschichte der deutschen Sprache*, 1868) was the first to apply analogy as a principle of explanation on a larger scale, but in a wilful and unsystematic way. Hence he failed to produce an immediate and lasting impression, and the merit of having introduced into the practice of modern comparative philology a strictly systematic consideration of both phonetic and analogic change as co-ordinate factors in the development of language rests with Professor Leskien of Leipsic, and a number of younger scholars who had more or less experienced his personal influence. Amongst these Brugmann, Osthoff, and Paul rank foremost as the most vigorous and successful defenders of the new method, the correctness of which has since been practically acknowledged by most of the leading philologists of all shades,

who in point of fact follow it in their investigations, in spite of the lively theoretical protest which some of them continue to maintain against it, and in spite of the general feeling of hostility and inclination towards mutual distrust often but too clearly visible in recent linguistic publications, from whatever side they may come.<sup>1</sup>

From this historical sketch we may now proceed to a short examination of some of the chief results of Aryan comparative philology.

The most prominent achievement of the researches of Bopp and his followers was to prove that the majority of the European languages and dialects, together with a certain number of important languages spoken in Asia, form one great family,—that is, that they have sprung from one common source or parent-language. The name now mostly used in England for this community is *Aryan languages*. American and French scholars generally prefer to say *Indo-European languages*, while the name of *Indo-Germanic languages* is still almost universally used in Germany. It is hard to decide for or against any of these names from a scientific point of view. The word *Indo-Germanic* was not inappropriately coined by combining the names of the most easterly and westerly members of the family, the Indian and the Germanic or Teutonic group.<sup>2</sup> *Indo-European* seems to be a less lucky invention, as this combination of geographical names would erroneously point to all the languages of India and Europe as the constituents of our family, while a large number both of Indian and European idioms belong to entirely unrelated groups of languages. *Aryan* would no doubt be the best name in itself, for it seems that the primitive forefathers of the Aryan nations used the word *Ária* as a national name themselves. We find at least the Sanskrit *Árya* thus used in India, and similarly the Old Persian *Árya* (in the cuneiform inscriptions of Darius), Zend *Árya* in Persia (whence the later *Éran*, *Írán*), and perhaps *Éris*, gen. *Érens*, as the national name for Ireland.<sup>3</sup> But before the word *Aryan* came to be applied in the sense defined above it had for some time been used, and it is still largely used, in a more restricted sense as the special collective name for the languages of the Indian and Persian or Iranian groups of the Indo-Germanic family. This ambiguity renders the use of the word *Aryan* less recommendable than it would be had its meaning been properly fixed from the beginning. It seems that outside of England *Aryan* will hardly gain ground; some recent attempts to introduce the name into Germany have utterly failed, and in the same way the other nations who share in scientific research in this demesne cling to the 'older names.

This large Indo-Germanic or Aryan family, then, to refer to our principal task, consists of ten groups or sub-

families of languages, three of which are located in Asia while the rest belong to Europe.<sup>4</sup>

1. The *Indian Family*, in which Sanskrit, especially in its oldest form, preserved in the Vedic texts, stands foremost in rank. Of the older stages of the language Prakrit and Páli may be mentioned here,—the former, in its various branches being the mother of the modern Indian dialects of Aryan descent (including also the Gíly language), the latter (see above, p. 183) the idiom of the sacred books of the southern Buddhists.<sup>5</sup>

2. The *Iranian or Persian Family*, represented in the earliest period by Old Persian, scanty remnants of which have come down to us in the Achæmenian cuneiform inscriptions, and Zend, or, as it is also called, Old Bactrian, the language of the *Zend-Avesta*, the sacred books of the Zoroastrians. The chief modern representatives of this group are Persian, Afghan, Kurdish, and Ossetic.<sup>6</sup>

3. The *Armenian Family*, consisting of the different living dialects of Armenian. Armenian has but recently been proved to be an independent member of the Aryan family. It partakes of many peculiarities of the Iranian group, but at the same time shares several important characteristics of the European languages, so that it cannot be classed as a subdivision of either of these groups.<sup>7</sup>

4. The *Greek Family*, comprising the various old dialects of Greek, and the modern Romaic idioms, which have been developed out of the later *κοινή* that had gradually superseded the old dialectal varieties.<sup>8</sup>

5. A fifth family, which may once have had a far larger extension, is now only represented by one surviving member, the *Albanian language*. As we have no old sources for this idiom, and only know it in its modern state of utter decay, it is extremely difficult to obtain definite results concerning its origin and position relatively to the surrounding languages. Bopp seems to have proved, however, that Albanian actually is an Aryan idiom.<sup>9</sup> It is also certain that it belongs to the European type of Aryan, yet it is not particularly closely allied with Greek, as has often been assumed, but shows some remarkable coincidences with the northern European languages.<sup>10</sup>

6. The *Italic Family*. Its most important representative is Latin, from which the modern Romance languages have sprung. Closely connected with Latin was the Faliscan dialect, which is preserved in a few inscriptions only. A second branch of Italic is formed by Umbrian and Oscan, both of which soon became extinct through the overpowering influence of Latin, like the other less widely diffused idioms once spoken in Italy.<sup>11</sup>

<sup>1</sup> The fullest, yet now somewhat antiquated, account of all the members of the Aryan family will be found in the article "Indo-germanischer Sprachstamm," by A. F. Pott, in Ersch and Gruber's *Encyclopædie* (Leipzig, 1840). See also especially Th. Bentley, *Geschichte der Sprachwissenschaft*, pp. 601-683.

<sup>2</sup> For further particulars see *SANSKRIT*.

<sup>3</sup> See the articles *PAHLAVI* (*supra*, p. 134 sq.) and *PERSSIA* (*supra*, p. 653 sq.), and for the linguistic characteristics of this group H. Hübschmann, in *Zeitschrift für vergl. Sprachforschung*, xxiv, p. 372 sq.

<sup>4</sup> See H. Hübschmann, "Ueber die Stellung des Armenischen in Kreise der indo-germanischen Sprachen," in *Zeitschr. vergl. Sprachf.*, xiii, p. 5 sq., where further references to earlier treatments of this question are given.

<sup>5</sup> See *GREKES*, vol. xi, p. 129 sq. An exhaustive summary of all prior contributions towards linguistic elucidation of Greek is given in Gust Meyer's excellent *Griechische Grammatik*, Leipzig, 1880, which must now be considered the standard book on Greek grammar, together with the well-known works of G. Curtius, quoted at vol. xi, p. 136.

<sup>6</sup> Bopp, "Ueber das Albanische in seinen verwandtschaftlichen Beziehungen," Berlin, 1855, in *Abhandl. Berl. Akad.*

<sup>7</sup> See especially G. Meyer, "Die Stellung des Albanischen in Kreise der indo-germ. Sprachen," in *Bezenberger's Beiträge*, viii, p. 185 sq., and *Albanische Studien*, Vienna, 1883. For other references, cp. Bentley, *Geschichte der Sprachwissenschaft*, p. 643 sq.

<sup>8</sup> A sketch of the history of Latin is given under *LATIN LANGUAGE*; a list of the chief books concerning the other dialects will be found in the appendix to Bayce's *Instr. to the Science of Lang.*, vol. 2.

<sup>1</sup> The fullest systematic treatment of these questions of method will be found in Paul's *Prinzipien der Sprachgeschichte*, Halle, 1880. See also Osthoff, *Das physiologische und psychologische Moment in der sprachlichen Formenbildung*, Berlin, 1879, and Mistell, "Lautgesetz und Analogie," in *Zeitschrift für Völkerpsychologie*, xi, p. 365 sq. Of those who on principle stand in theoretical opposition, the several schools of Bentley (now especially represented by Fick), Scherer, and Johannes Schmidt may be mentioned.

<sup>2</sup> The word *Indo-Germanic*, it is true, was invented before the Celtic languages were known to belong to the same family. But even after that discovery it was unnecessary to substitute the name *Indo-Celtic* as some authors have tried to do; for certainly the most westerly branch of Indo-Germanic in Europe (disregarding the Aryan colonies in America) is Icelandic, an undoubtedly Germanic language. Other names, such as *Japhetic* or *Sanskritic*, have hardly found any use in scientific literature.

<sup>3</sup> For particulars see Professor Max Müller's *Lect. on the Science of Lang.*, lect. vi. (first series), and *ARYAN*, vol. ii, p. 672 sq.; for this etymology of *Éris* see especially H. Zimmer, "Arisch," in *Bezenberger's Beitr. u. Kunde der indogerm. Sprachen*, iii, p. 137 sq.

7. The *Celtic Family*, once covering a large part of western Europe, but now reduced to comparatively scanty remnants in the north-west of France and in the British islands. Among its extinct members the language of the Galatians in Asia Minor may be mentioned, of which little more is known than that it was Celtic. The earliest documents of Celtic speech we possess are some inscriptions in the idiom of the Gallic inhabitants of France and northern Italy. The surviving branches of Celtic show a clear division into two groups: the Northern or Gaelic group, formed by Irish, Gaelic or Scotch, and Manx, and a Southern or Brittonic group, consisting of Welsh or Cymric, Cornish (extinct since 1778), and Armorican or Bas Breton in Brittany. The fundamental authority for the comparative study of Celtic grammar is Zeuss, *Grammatica Celtica*, 1853 (2d ed. by H. Ebel, 1871). After Zeuss, Stokes and Rhŷs in England, Ascoli in Italy, Ebel, Windisch, and Zimmer in Germany, and D'Arbois de Jubainville and H. Gaidoz in France have been the chief contributors to this field of research. The last-named is also the editor of a periodical especially devoted to Celtic studies, the *Revue Celtique* (Paris, from 1870).<sup>1</sup>

8. The *Germanic or Teutonic Family*. This well-developed family is divided into two main groups, which are now commonly denoted Eastern and Western Germanic. The members of the former are Gothic (see GOTHIC LANGUAGE, vol. x. p. 852 sq.) and Scandinavian, with an eastern and a western subdivision, the former comprising Swedish and Danish, the latter Norse and Icelandic. Western Germanic, on the other hand, consists of English, Frisian (these two seem to form a separate branch), Saxon or Low German, Frankish (including Dutch), and Upper German (see article GERMAN LANGUAGE). The dialects of the numerous other Teutonic tribes not mentioned here have died out without leaving sufficient materials for linguistic classification.

9. The *Baltic Family*, comprising three distinct idioms—Prussian, Lithuanian, and Lettish. Prussian became extinct in the 16th century. The few specimens of this highly interesting language which have been preserved are collected by Nesselmann, *Die Sprache der alten Preussen* (Königsberg, 1845), and *Ein deutschpreussisches Vocabularium* (*ibid.*, 1868). The same author has also published a dictionary, *Thesaurus linguae Prusicae* (Berlin, 1873). Amongst other contributions to Prussian grammar, Bopp's essay, *Ueber die Sprache der Altpreussen* (Berlin, 1853), is especially noteworthy. Of the two other branches, Lithuanian is the more important for comparative philology. The chief grammars are those by Schleicher (*Handbuch der litauischen Sprache*, 2 vols., Prague, 1856-57) and Kurschat (*Litauische Grammatik*, Halle, 1876); the best dictionary is by Kurschat (*Wörterbuch der lit. Sprache*, 2 vols., Halle, 1878-83). Some of the oldest texts are now being reprinted by Bezzenberger.<sup>2</sup> For Lettish, Bielenstein's grammar (*Die lettische Sprache*, 2 vols., Berlin, 1863-64) and Ulmann's dictionary (*Lettisches Wörterbuch*, Riga, 1872) are the first books to be consulted.

10. The *Slavonic Family*. There are two main branches of Slavonic. The so-called Southern or South-Eastern branch embraces Russian, Ruthenian (in Galicia), Bulgarian, Servian, Croatian, and Slovenian. The second branch is generally designated by the name of Western Slavonic. It is chiefly represented by Cechish or Bohemian and Polish. With the former the Sorbian dialects spoken

in Lusatia are very closely connected. Polish, again, is subdivided into Eastern Polish or Polish Proper and Western Polish, a few remnants of which now survive in the Kasubian dialects of Prussia. About the extinct members of this last group, which are generally comprehended under the name of Polabian dialects, Schleicher's *Lauf- und Formenlehre der polabischen Sprache* (St Petersburg, 1871) and an article by Leakien in *Im neuen Reich*, ii. p. 325, may be consulted. The oldest Slavonic texts, some of which go as far back as the 10th century, are a number of books destined for the use of the church. From this circumstance the peculiar dialect in which they are written is often called Church Slavonic. Schleicher and others identify this dialect with Old Bulgarian, while Miklosich thinks it should be classed as Old Slovenian. For comparative purposes as well as for Slavonic philology this idiom is the most important. The chief grammars are Schleicher, *Formenlehre der kirchenslavischen Sprache* (Bonn, 1852); Miklosich, *Lauf- und Formenlehre der alt-slovenischen Sprache* (Vienna, 1850); and Leakien, *Handbuch der albulgarischen Sprache* (Vienna, 1871). The fundamental works on comparative Slavonic philology are Miklosich, *Vergleichende Grammatik der slavischen Sprachen* (4 vols., Vienna, 1852-68; 2d ed. of vol. i., *Lauflehre*, 1879), and *Lexicon Palaeoslovenico-Græco-Latinum* (Vienna, 1862-65). A large number of special contributions are collected in Jagić, *Archiv für slavische Philologie* (Berlin, from 1876).

The mutual relationship of these ten families may be shortly characterized by saying that they are dialects of the primitive Aryan parent-speech, which at an early period of its existence must have formed a linguistic unity, but subsequently became dissolved into these subdivisions. This fundamental view now seems to be universally admitted to be correct. But it is extremely difficult to go beyond it in attempts to trace out the history of the process of dissolution. One problem offering itself at the very outset of such an attempt (although more of an ethnological than philological character) must at once be dismissed as insoluble,—the question of the original home of our Aryan forefathers and the directions of the wanderings that brought the single members of the great original tribe to the seats occupied in historical times by the several Aryan nations. There exist indeed no means for deciding whether they came from the north-eastern part of the Iranian plateau near the Hindu-Kush Mountains, as was once generally assumed, or whether Europe may boast of being the mother of the Aryan nationality, as some authors are now inclined to believe.<sup>3</sup> The chief philological difficulty lies in the fact that some of these ten families stand in closer relationship with certain others than with the rest, so that they seem to form separate independent groups, and yet these groups cannot be severed from the rest without overlooking important linguistic facts which seem to speak for the existence of a closer connexion between single members of one group and single members or the whole of another. Before attention was drawn to this latter point it was easy enough to account for the origin of the grouping alluded to. If everything that is common to all Aryan languages must have originated in the common parent-speech—and the correctness of this assumption can hardly be doubted—then everything that is common to all the families of one particular group, but strange to the others, must be assigned to a period when these families formed a unity by themselves and were disconnected with the other stock. The fact, for instance, that all the European languages possess the three vowels *a*, *e*, *o*, where the Indian and Iranian group show the uniform *a*, which was then believed to be the primitive

<sup>1</sup> For further particulars see article CELTIC LITERATURE, and the very exhaustive critical and bibliographical study by Windisch, "Keltische Sprachen," in Erch and Gruber's *Encyclopædie*.

<sup>2</sup> *Litauische und Lettische Drucke des 16ten Jahrhunderts*, Göttingen, 1878 sq.; cp. also *Beiträge zur Geschichte der lit. Sprache*, Göttingen, 1877, by the same author.

<sup>3</sup> On this much varied question see especially O. Schrader, *Sprachvergleichung und Urgeschichte*, Jena, 1883, *passim*.

sound, seemed to indicate that the primitive Aryan stock had once been split into two halves, one of which remained in Asia and retained the primitive *a*-sound, while the other half emigrated to Europe and there developed the new vowel-system, before any new divisions took place. The Aryan parent-speech would thus appear to have been split into a European and an Asiatic "base-language." Similar facts in the history of the single European languages then led to the further assumption of a southern European base as the parent of Greek, Italic, and Celtic, and a northern European base for Germanic, Baltic, and Slavonic, and, with further subdivision, an Italo-Celtic and a Litu-Slavic base for Italic and Celtic on the one hand and for Baltic and Slavonic on the other. The prehistoric development of Aryan, according to this genealogical theory (which makes division of language dependent on division of nations), may be illustrated by the following genealogical table.<sup>1</sup>

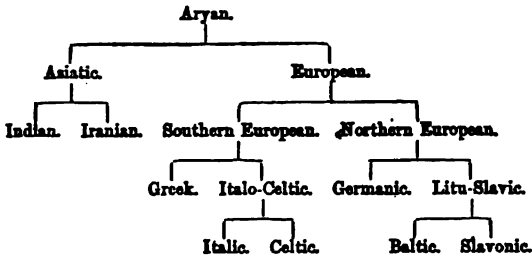

It may still be admitted that at least the mutual position of the ten families is not the same in all cases. It cannot be doubted that Indian and Iranian resemble each other more than either of them does any other family. The same may also be said of Baltic and Slavonic, and even of Italic and Celtic, however different the latter two may appear to be at first sight.<sup>2</sup> But it is impossible to carry this system of genealogical grouping through. It will be observed that not all the ten families are represented in the genealogical tree given above; Albanian and Armenian have not found a place in it, nor could they be introduced without disturbing the entire table. If we look at Armenian, for instance, we find that its structure and phonology on the whole follow the Asiatic type, and yet Armenian shares the European vowel-system alluded to before; compare, for instance, Armenian *berem*, "I bear," with Greek *φέρω*, Latin *fero*, Old Irish *berimm* (and *dobur* for \**do-beru*), Gothic *baira* (pronounced *bēra*), Lith. *berū*, Slavonic *berŭ*, against Sanskrit *bhārásmi*, Zend *barāsmi*. Armenian, then, is half European, half Asiatic, and if such an intermediate idiom exists it is impossible to make a strict distinction between Asiatic and European. Let us take another instance. All the Asiatic languages have changed the original palatal *k* into sibilants, and the same change we find again in Slavonic and Baltic, both of which otherwise clearly belong to the European type; compare, for instance, Sanskrit and Zend *daçan*, "ten," Armenian *tam*, Slavonic *desęti*, Lith. *dęsimi*, with Greek *déca*, Latin *decem*, Old

<sup>1</sup> This pedigree is the one ultimately given by Schleicher. Others have assumed more or less different degrees of relationship. Greek and Italic, for instance, were for a long time believed to be particularly near relations. A totally contrary view would come nearer the truth. Greek and Latin are about as different, both in phonology and grammatical structure, as any two members of the Aryan family; indeed there is nothing to recommend their combination but the intimate connexion in which the two nations and their literatures have stood within historical times, and the custom derived therefrom of studying the two classical languages together from our school-days.

<sup>2</sup> Amongst the characteristics of these two groups the general resemblance in the declension, and in the verb the formation of a future in *b* or *f* (Latin *amabo*, Old Irish *carfa*, *ruo charb*) and of a passive in *r* (Latin *fertur*, Old Irish *carthir*, &c.), are the most important.

Irish *deich* (for \**dekim*), Gothic *taitasa*. In a similar way Litu-Slavic and Germanic are connected by the formation of a plural dative in *as*, as in Gothic *wulfana*, Lith. *vilkams*, Slavonic *vilkomę*, against the Sanskrit *bhāyas*, Latin *bus*, Irish *-b*; and so all round. The consequence is that every attempt at grouping the Aryan families of speech on the genealogical basis must fail, because it would have to cut asunder some of the natural ties that hold the single families together. It is true that some of the coincidences falling under this head may be due to mere chance, especially those in phonology; for we often see the same phonetic processes going on in languages which stand in no connexion whatever at the time. Yet in the case before us the number of the actual coincidences is too large to allow of such an explanation, and the fact of their existence is made all the more striking from the circumstance that it is each pair of *neighbouring* families which shows these connecting links. If they prove anything (and it cannot be doubted that they do), we must necessarily come to the conclusion that every such link is a witness for at least a temporary connexion between the two languages or families it holds together. To assume such temporary connexions in the time after a true division of nations had taken place (that is, to assume, for instance, that Slavonic had come into contact with the Asiatic languages after the Europeans had migrated from Asia to Europe, or the forefathers of the present Asiatic nations from Europe to Asia, as the case may be) seems impossible. It is likewise highly improbable that connexions intimate enough to leave distinct marks in language existed at a time when the original tribe had spread over the wide regions now covered by the Aryans, even supposing this spreading to have been so gradual as not to cause any break in the continuity of the Aryan population. And, even if we concede this, how are we to account for the fact that we have no longer the supposed continuity of speech, but well-defined single languages, whose separation must, after all, be due to breaks in the continuity of intercourse between the respective speakers? These and similar reasons point to the assumption that the origin of the phenomena alluded to must be sought in a remote period, when the Aryan tribe had an extension small enough to permit continuity of intercourse, and yet large enough to allow of dialectic variations in its different districts. In other words, when the actual break-up of the Aryan tribe into different nations came to pass the Aryan parent-speech was no longer a homogeneous idiom, but the development of dialects had begun. On their following wanderings, then, those tribes or clans would naturally cling together which had until then lived in the closest connexion both of intercourse and dialect (for community of intercourse and of speech always go together), or, as we might also say, the old unity would naturally be broken up into as many parts as there had been dialectic centres. Transition dialects, which might have been spoken in the outlying parts of the old dialectic districts, would also naturally be then reduced to a common level in consequence of the general mixture of speakers that could not but have taken place on wanderings so extensive as those of the Aryan tribes must have been.

Such an assumption would indeed solve most of the difficulties mentioned above, especially the peculiar way in which the single families of Aryan are linked together. Each of these would then correspond to one of the main dialects of the parental language, and their mutual affinities would therefore be of the same kind as those of neighbouring dialects, say, of any living speech. And in this nothing is more common, nay even more characteristic, than the gradual transition from one to the other, so that each dialect of an intermediate position partakes of some



of the peculiarities of its neighbours to the right and left. In Old English the Kentish dialect, for instance, in some respects goes with West Saxon against Mercian, in others with Mercian against West Saxon, sometimes West Saxon and Mercian combine against Kentish, and sometimes each of them stands by itself, as the following table will show.

West Saxon.	Kentish.	Mercian.
hīlpð	hīlpð	hēlped (he) helps.
lēht	lēht	lēht light.
dēd	dēd	dēd deed.
hiorde	hiorde	hiorde (shep-)herd.
dēl	dēl	dēl deal.
gylden	gylden	gylden golden.
fēll	fēll	fēll (he) falls.
worpd	worpd	worpd (he) throvs.

If the inhabitants of the old kingdoms of Wessex, Kent, and Mercia had separately left their English abodes and wandered back to different parts of the Continent after their dialects had developed in the way illustrated above, would not their dialects have gradually developed into independent languages exhibiting the same characteristic features of mutual relationship as those found in the Indo-Germanic idioms? <sup>1</sup>

It remains to give a short review of the main characteristics of Indo-Germanic, both phonetic and structural.

**A. Phonology.**—The consonant system of the Aryan parent-language was chiefly characterized by the prevalence of stopped (explosive) sounds and the scarcity of spirants. The only representatives of the latter class were *s*, and in a few cases *z*, while there is no trace of sounds so common in modern languages as the English *f*, *th*, *sh*, or the German *ch*. Besides stops and spirants the system comprised nasals, liquids, and semi-vowels.

The stops were either voiceless (surd), like the English *p*, *t*, *k*, or voiced (sonant), like the English *b*, *d*, *g*, and either pure (unaspirated) or aspirated. By combining these two distinctions we arrive at four chief varieties of stops, which are generally thus symbolized: *p*, *ph*, *b*, *bh* for the labial, *t*, *th*, *d*, *dh* for the dental class, &c. Here the *p*, *t*, *k* denote unaspirated voiceless stops, *ph*, *th*, *kh* their aspirates; *b*, *d*, *g* voiced stops, and *bh*, *dh*, *gh* their aspirates. In pronouncing these sounds English readers should be careful not to give the Aryan *p*, *t*, *k* the value of the English *p*, *t*, *k*, because these are always slightly aspirated. The true unaspirated sound is still found in the Romance and the Slavonic languages, in modern Greek, &c. The aspirates *ph*, *th*, *kh* should be sounded with a strong escape of breath after the explosion of the stop, inserting a distinct *h* between the initial *p*, *t*, *k* and the following sound (as is often done in Irish pronunciation; initial *p*, *t*, *k* in Danish may also be taken as examples). In the so-called media *b*, *d*, *g* the voice should always be distinctly audible, as in French, or in English medial *b*, *d*, *g* (initial *b*, *d*, *g* in English are often voiceless). The pronunciation of the voiced aspirates *bh*, *dh*, *gh* is a very vexed question, as these sounds have disappeared from all the living Aryan languages except the modern Indian dialects, and these seem to show differences in the pronunciation of the aspirates which have not yet been sufficiently cleared up. The old Indian grammarians made their aspirates out to be voiced stops followed by a corresponding, that is, voiced, aspiration, and this description seems to correspond with the observations of Mr Alex. Ellis, <sup>2</sup> who found that in the Benares pronunciation of Sanskrit *bha*, *dha*, *gha* are distinguished from *ba*, *da*, *ga* merely by a somewhat stronger pronunciation of the vowel. It seems, however, that another pronunciation exists in the west, and that *bha*, for instance, in Bombay is actually pronounced as a distinctly voiced *b* followed by a common *h*; the voice is broken off simultaneously with the opening of the lips, so that no vocalic sound is inserted between the *b* and the *h*. If this pronunciation was not original in Aryan, it seems to have come in at an early period; for it would be extremely difficult to explain the transition of original *bh*, *dh*, *gh* into the Greek voiceless

aspirates *φ*, *θ*, *χ* (as in Greek *φίλο*, originally pronounced *p-hērō*, compared with Sanskrit *bhārāmi*), unless we start from a voiceless aspiration.

With regard to their positions, the labials *p*, *ph*, *b*, *bh* do not seem to have differed from the common European labials of the present day. The so-called dentals *t*, *th*, *d*, *dh* were really dental, that is, formed by touching the lower rim or back of the upper teeth with the tip of the tongue (in the pronunciation of the English *t*, *d* the tongue is raised towards the upper gums). This purely dental pronunciation is still preserved in most of the Asiatic and some European languages. The supradental class represented in the Indian languages by the so-called cerebrals or linguals *t̪*, *th̪*, *d̪* seems not to have existed in primitive Aryan, but was most probably imported into Indian from the Dravidian idioms of southern India, where these sounds are very common. Of back consonants Aryan possessed two distinct parallel sets, now generally symbolized by *k*, *kh*, *g*, *gh* and *k̪*, *kh̪*, *g̪*, *gh̪* respectively. <sup>3</sup> They may be characterized as front and back gutturals, or possibly as palatals and gutturals proper (compare the Semitic distinction of *Q* and *Ḍ*). The distinction of the two series is best preserved in the Asiatic languages and Litu-Slavic, where the front gutturals or palatals passed into spirants, while the back gutturals (at least originally) retained their character of explosives. In the other languages the difference is less clearly marked, as will be seen from the following table of correspondences. <sup>4</sup>

Aryan.	Sans.	Zend.	Arm.	Slav.	Lith.	Greek.	Lat.	Irish.	Germ.
k̪	g	g	g	g	aw	κ	g	c, ch	k (g)
g̪	g̪	g̪	g̪	g̪	γ	γ	g, g̪	g	k̪
kh̪	h	h	h, dh	h	χ	χ	h, g̪	g̪	kh
k̪	k, c	k, c, Oc, Ÿ	k, kh	k, c, s	k	κ, τ (r)	g, c	c, ch	kw, k (w, g)
gh̪	g, j	g̪	g̪	g̪	γ (β, θ)	γ (β, θ)	g̪	g̪	g̪
gh̪	gh, h	gh, h	gh (θ)	gh, h	χ (θ)	χ (θ)	h, g̪	g̪	g̪ w

Of nasals there were four, corresponding to the four classes of stops, *m*, *n*, and two guttural ones, which may be written *ṃ* and *ṅ*; the latter only occur before the corresponding explosives. Of liquids we find *r* and *l* in the individual languages, but frequently interchanging. It has been assumed, therefore, that Aryan had only one sound instead of the two, which was afterwards developed into either *r* or *l*. There seems to be sufficient reason, however, to believe that the later distinction of *r* and *l* was founded on some parallel distinction in Aryan; most probably we have to assume the coexistence of two varieties of *r*-sounds; the one which, at a later period, passed into *r* may have been a distinct trilled *r*, while the second, the antecedent of *l*, may have been an untrilled variety. We find a similar distinction in the semi-vowels *y* and *w*, each of which must have had two distinct varieties. The first variety of *y* is in Greek represented by *ι*, the second by *ι̪*, as in *ἴσ*, *ἴσῃ*, compared with Sanskrit *yās* and *yugdm*, &c.: from these correspondences it would seem that the first *y* was a real semi-vowel, like the English *y*—that is, a non-syllabic *i*—and the second a more spirant sound, like the North-German *j*. As to the *w*, the existence of a double sound seems to follow from the different way in which initial *w* is treated in Sanskrit reduplication; compare perfects like *wasas*, 3d plural *śas* with *varādhā*, pl. *varādhās*. <sup>5</sup> Here the transition of *w* into *u* points to a semi-vocalic pronunciation, as in English *w*. The other sound, which remains unaltered, may have been more like the spirant English *v*. The sound of the sibilant *s* cannot be fixed exactly; it may have been dental either like the French *s*, or more supradental as in English. The voiced *s* is of extremely rare occurrence; it was confined to combinations of a sibilant with a voiced mute, such as *śd*, *śdh*, *śg*; compare, for instance, Aryan *mitāho*,

<sup>1</sup> This fact was first discovered by Ascoli, *Corsi di glottologia*, 1870, p. 51 sq., and Fick, *Die chem. Spracheneinheit der Indo-germanen Europas*, p. 3 sq.; cp. also Joh. Schmidt, in *Jenais Lit.-Zeitung*, 1874, p. 201 sq., and *Zeitschr. f. vergl. Sprachf.*, xxv. p. 1 sq.; H. Hübschmann, in *Zeitschr. f. vergl. Sprachf.*, xxii. pp. 20 sq., 385 sq., xxiv. p. 372 sq.; H. Müller, *Die palatalreihe der indog. Grundsprache im Germanischen*, Leipzig, 1875; H. Collitz, in *Bezenberger's Beitr.*, iii. p. 177 sq.; F. Kluge, *Beiträge zur Geschichte der german. Conjugation*, Strasburg, 1879, p. 42 sq.

<sup>2</sup> The voiceless aspirates are left out here because they are hardly frequent enough to enable us to make out exact rules of correspondence. It may be noticed here that in Sanskrit and Greek the old aspirates have been replaced by the corresponding unaspirated sounds (that is, *b*, *d*, *g*, *j* and *r*, *r̪*, *χ* respectively) whenever they were followed by another aspirate. See especially Grassmann, in *Zeitschr. f. vergl. Sprachf.*, xii. p. 81 sq.

<sup>3</sup> Compare also the parallel of Sanskrit *śyās*, perfect of *śyas*, and Greek *ἴσῃ*, *ἴσῃ*, with initial *ι̪*. The discovery of the two *y*-sounds was first made by G. Schulze, *Ueber das Verhältniss des ι̪ zu den entsprechenden Lauten der verwandten Sprachen*, Göttingen, 1867.

<sup>1</sup> A detailed history of the different views expressed with regard to the mutual relationships of the Indo-Germanic languages has been given by O. Schrader, *Sprachvergleichung und Culturgeschichte*, p. 66 sq.; cp. especially Joh. Schmidt, *Die Verwandtschaftsverhältnisse der indog. Sprachen*, Vienna, 1872; A. Fick, *Die ehemalige Spracheneinheit der Indogermanen Europas*, Göttingen, 1873 (reviewed by Schmidt, in *Jenais Literaturzeitung*, 1874, p. 201 sq.); A. Leskien, *Die Deklination im Slavisch-Litauischen und Germanischen*, Leipzig, 1876 (Introduction); Paul, *Principien der Sprachgeschichte*, ch. xii.; K. Brugmann, "Zur Frage nach den Verwandtschaftsverhältnissen der indog. Sprachen," in *Teuchner, Internationales Zeitschrift für allgem. Sprachwissenschaft*, I. (1884), p. 226 sq.

<sup>2</sup> On Early English Pronunciation, iv. p. 1135 sq.

Sanskrit *mīḥā*, Zend *mīhāda*, Greek *μῆα*, Slavonic *mīda*, Gothic *mīzā*.<sup>1</sup>

Up to a very recent date the Aryan vowel-system was considered not to have contained more than the three "primitive" vowels *a*, *i*, *u*, and the diphthongs *ai* and *au* (regardless of quantity). The sounds of *e* and *o*, which are frequent in the European languages (and also in Armenian, as has been pointed out before), but do not occur in Sanskrit,<sup>2</sup> were regarded as later developments from the original *a*. We know now that these views were erroneous. Aryan not only had the five common vocalic sounds *a*, *e*, *o*, *i*, *u*, both long and short, but also often used the liquids and nasals *r*, *l*, *m*, *n*, *ṅ*, as vowels, that is, with syllabic value (as, for instance, in English *batle*, *bottom*, *mullion*, pronounced *bat-il*, *bot-tm*, *mull-in*), also both short and long. Besides these simple vocalic sounds, there were twelve diphthongs proper, *ai*, *ei*, *oi*, *au*, *eu*, *ou*, and *āi*, *āe*, *āu*, *īu*, *ūu*, setting aside the similar combinations of *a*, *e*, *o*, *ā*, with liquids and nasals. It will be observed at a glance that the Greek vowels and diphthongs

α	ε	ο	ι	υ	αι	υι	οι	ει	ου
αι	α	α			ει	υ	φ		
αυ	ευ	ου			ει	υ	φ		

are exactly those of the Aryan system. The only case, indeed, where Greek has changed the Aryan sounds is that of the syllabic liquids and nasals, as will be shown hereafter.

The first proofs for the priority of the European *a*, *e*, *o* in comparison with the uniform Indo-Iranian *a* were discovered independently by Amelung and Brugmann.<sup>3</sup> Since then the number of proofs has been considerably increased. The most striking of all is perhaps the observation, made independently by Verner and Collitz,<sup>4</sup> that the original back gutturals of Aryan are changed into palatals in Indo-Iranian when followed by *i*, *y*, or an *a* corresponding to a European *e*, but are preserved without alteration when followed by other sounds, especially an *a* corresponding to a European *a* or *o*. We thus find not only forms like Sanskrit *cid* corresponding to Greek *κῆ*, Latin *quid*, but also Sanskrit *ca*, *paṇca*, *janas*, &c., corresponding to Greek *κα*, *πεντε*, *γενος*, Latin *que*, *quingus*, *genus*, while the old guttural is kept in words like Sanskrit *kalava*, *garbha* = Greek *καλαρος* (Ionian *καρεπος*), Slavonic *koloryi*, Gothic *kwathar*, and German *kaib*. A special instance of this Indo-Iranian law of palatalization is exhibited in the formation of the reduplicative perfect, where initial gutturals are changed into palatals before the vowel of the reduplicative syllable, which is *e* in Greek and elsewhere; compare Sanskrit perfects like *caḥra*, *jaḥra* with Greek *καρεπος*, *Μακρα*, &c. If, then, the Indo-Iranian *a* (= European *e*) once had the same influence on preceding gutturals as the palatal vowel and semi-vowel *i* and *y*, it must necessarily itself have had a similar palatal, that is *e*-like, pronunciation distinguishing it from the other *a*'s that go along with the non-palatal European *a* and *o*. The proofs for the coexistence of *a* and *o* in primitive Aryan are no less convincing than those for the existence of the palatal "a-vowel," that is *e*, but they are too complicated to be discussed here.<sup>5</sup>

The Aryan syllabic liquids and nasals were also discovered by Brugmann. In Sanskrit the short syllabic liquids are preserved in the so-called *r*-vowel and *l*-vowel, as in *kṛdā*, *kṛpā*; the long ones have passed over into *r* or *ar*, as in *ātrā*, *pārā*, and *gārī*. These Sanskrit vocalic *r* and *l* are the only direct remnants of the whole class. In all other cases the original system has been more or less destroyed. Thus, to give only a few instances, the syllabic nasals appear as *a* in Sanskrit and Greek, as in Sanskrit *taḥa*, Greek *ταρβη* for *taḥa* (past part. of *√ten*, in Sanskrit *tanōmi*, Greek *τενω* for *\*tenw*), Sanskrit *caḥa*, Greek *καρεπος*, "hundred" (for *\*caḥa-m*); or as *a* before vowels, as in Sanskrit *taḥa*, "thin." Greek *ταρβη*, for dissyllabic *ta-ā*. In Latin and Celtic an *a* has been developed before

<sup>1</sup> See Osthoff, in *Zeitschr. f. vergl. Sprachf.*, xxiii. p. 87, and Kluge, *ibid.*, xv. p. 313.

<sup>2</sup> It must be borne in mind that the Sanskrit sounds generally transcribed by *e* and *o* were originally diphthongs, — *ai* and *au*.

<sup>3</sup> See A. Amelung, *Die Bildung der Tempusstämme durch Vocalsteigerung*, Berlin, 1871, also in *Zeitschr. f. vergl. Sprachf.*, xxii. p. 309, and *Zeitsch. f. deutschen Alterth.*, xviii. p. 161 sq.; and Brugmann, in Curtius's *Studien*, ix. pp. 287, 263. In his earlier publications Brugmann wrote *ai*, *oi*, *au* for *e*, *o*, *a* respectively; *A* was then substituted for *ai* by De Saussure; others, again, introduced *a* and *o* for Brugmann's *ai* and *oi*, and simple *a* for his *ai*. The spelling *e*, *o*, *a*, now generally adopted, was first proposed by Collitz.

<sup>4</sup> E. Collitz, in Bezenberger's *Beiträge*, iii. p. 177 sq.; Verner's discovery was communicated by Osthoff, in *Morphologische Untersuchungen*, I. p. 116, and by Hubschmann, in *Zeitschr. f. vergl. Sprachf.*, xxiv. p. 409. See also the full discussion of this problem by Joh. Schmidt, *ibid.*, xv. p. 1 sq.

<sup>5</sup> Besides the references given above, compare for this and the following especially F. Kluge, *Beitr. zur Geschichte der german. Conjugation*, Strasbourg, 1879; F. Masling, *Der Verbalstamm der griech. Vocalbildung zur Sanskritischen*, St. Petersburg, 1879; F. de Saussure, *Mémoire sur le système primitif des voyelles dans les langues indo-européennes*, Leipzig, 1879; G. Mahlow, *Die langen Vocale a, e, o in den europ. Sprachen*, Berlin, 1879; Osthoff and Brugmann, *Morphologische Untersuchungen auf dem Gebiete der indog. Sprachen*, 4 vols., Leipzig, 1878, sq.; G. Meyer, *Ortsliche Grammatik*, Leipzig, 1880; and a long series of articles by K. Verner, Brugmann, Meyer, Osthoff, Joh. Schmidt, in *Zeitschr. f. vergl. Sprachf.*, vol. xxiii sq., and by Bezenberger, Collitz, and Fick, in Bezenberger's *Beiträge*, vol. sq.; F. de Saussure, *Éléments de la grammaire primitive des voyelles dans les langues indo-européennes*, Paris, in Paul and Brunn, *Beiträge zur Geschichte der deutschen Sprache und Literatur*, vi. p. 106; E. Müller, *ibid.*, vii. p. 482.

the nasal, Latin *centum*, *centu-is*, Irish *cé* (for *\*cent*), in Germanic *u*, Gothic *hund*, Old High German *dunant*. Original syllabic *r* and *l* are in the same way represented by Greek *ρα* (*ap*) and *λα* (*al*), as in *ερακος*, *βραβις* (for *\*rapādis*), *πλατος* (= Sanskrit *adhraam*, *adhra*, *prthā*), and in Germanic by *ur*, *ul* (more seldom *ru*, *lu*), as in Gothic *thaurus*, "dry" (for *\*thaurus*), *wulfa*, "wolf" (= Sanskrit *trahā*, *trika*), and so forth.

The most brilliant result, however, of these recent researches was not the more exact fixing of the phonetic values of the single Aryan vowels, and of the rules of correspondence between these and the vowels of the individual languages, but the discovery that the system of etymological vowel-change which pervades the whole of Aryan word-formation and inflexion, and which had until then generally borne the name of vowel-gradation, was chiefly developed under the influence of stress and pitch. It is well known how the theory by which the old Sanskrit grammarians tried to explain vowel-differences in words or forms derived from the same "root" considered the shortest form of a root-syllable discernible in all its derivations as the most primitive shape of the root, and let the fuller forms be developed from it through a process of increase, which Sanskrit grammar is accustomed to call *guna* and *vādhi*. Taking, for instance, the inflexions of perfects like *veda*, *vātha*, *vāda* (originally pronounced *vāida*, &c.), plur. *vidāmi*, *vidā*, *vidā*, or *caḥra*, *caḥra*, *caḥra*, plur. *caḥra*, *caḥra*, *caḥra*, past part. *krā*, they would start from *vid* and *kr* as "roots," and say that *ved-* (*vid-*) and *kar-* in *vidā* (*caida*) and *caḥra*, &c., were derived from these through *guna*, that is, through the insertion of an *a* before the original root-vowels *i* and *r*. This doctrine has been adopted by Bopp, and thus become one of the fundamental theories of comparative philology, although the objections that can be raised against it are both numerous and obvious. Even if we pass over the difficulty of giving a satisfactory phonetic explanation of the assumed process of insertion, how are we to account for the fact that in cases like *yaḥmi*, past part. *ikṣā*, or perfect like *jaḥra*, plur. *jaḥra*, the "inserted" *a* stands after its "root-vowel" instead of before it? Or, if we look at forms like *pāpāmi*, perf. plur. of *pāmi*, "I fly," or *smā*, *sthā*, *śnā*, plur. of *smi*, "I am," must we not take *pa* and *s* as the original roots, and is it possible to imagine that such roots could ever have existed! All such difficulties disappear by assuming the new theory, that the fuller forms are more original. As the above instances show, the fuller forms appear wherever the "root-syllable" is accented, that is, stressed; the shorter ones are confined to stressless syllables. What, then, more natural than to assume that the *a* of the fuller forms was the original "root-vowel," and that it was dropped in the shorter forms on account of their being unaccentuated? Loss of stressless vowels is one of the most frequent phonetic phenomena in all languages, and we have only to look to modern English pronunciation to find the most striking analogies to the process assumed above. Every-day pronunciations like *p'itō*, *S'ptēmb* for the written *potato*, *September* are exact parallels to the Sanskrit *pa-p'itā*, and the common *mī* (*lōra*), *mī* (*lōdy*) against the usual *mi* *mā* to the Sanskrit *vidā* against *vidā*; even the *r*-vowel is quite well known in rapid speech in forms like *I p'pōs*, or *kuḥ*, *naḥra* for the written *propos*, *history*, *natural*.

So far the new theory of vowel-gradation may be summed up as follows. Every root-syllable originally contained one of the three primitive vowels *a*, *e*, *o*, either short or long; *i*, *u*, the liquids and nasals, only occurred as semi-vowels or consonants, that is, forming monosyllabic (diphthongic) combinations with these vowels, which may either precede or follow the consonants. Thus, taking the combinations with the short vowels as an instance, we get the following table—

ai	ei	oi	and	ya	ya	yo
au	eu	ou	„	ya	ya	yo
ar	er	or	„	ya	ya	yo
ar	er	or	„	na	na	no

&c. In originally stressless syllables long vowels were shortened and short vowels dropped. If the original short vowel were surrounded by mutes, the mutes would come into contact through the loss of the vowel, as in Sanskrit *pa-p'itā* from *\*pa-p'itāmi*, or Greek *ε-ρῆμ* from *ε-ρῆμα*, or *ε-γῶ* from *ε-γῶν* (for *\*εγῶν*). If, however, the root-vowel were combined with a semi-vowel (*i*, *u*, or *y*, *w*), liquid or nasal, the latter would, on account of their vowel-like character, become syllabic (that is, vocalic) if followed by another consonant, but remain consonants if followed by a vowel; compare the following instances taken from Sanskrit (for the sake of distinctness we write the original *ai*, *au* for the common *i*, *o*).

<i>vidā</i>	—	<i>vidā</i>	{	<i>tutūda</i>	—	<i>tutūda</i>	{	<i>daddra</i>	—	<i>daddra</i>
<i>yaḥmi</i>	—	<i>ikṣā</i>	{	<i>vaktum</i>	—	<i>uktā</i>	{	<i>jaḥra</i>	—	<i>jaḥra</i>
<i>jigāya</i>	—	<i>jigūya</i>	{	<i>talāna</i>	—	<i>talā</i>	{	<i>caḥra</i>	—	<i>caḥra</i>
				<i>talāna</i>	—	<i>talā</i>	{	<i>caḥra</i>	—	<i>caḥra</i>
							{	<i>caḥra</i>	—	<i>caḥra</i>
							{	<i>caḥra</i>	—	<i>caḥra</i>

In the same way we find in Greek *ἄνα*—*ἄνα*, *ἄνα*—*ἄνα*, *ἄνα*—*ἄνα*, *ἄνα*—*ἄνα* (for *\*ἄνα* = Sanskrit *adhraam*; see above), *ἄνα*—*ἄνα* (for *\*ἄνα*), &c., and correspondingly in the other languages



only two are of primitive growth, the active and the middle voice, the passive voice being a later specialization of the middle. There were three moods, an indicative, a subjunctive, and an optative; the difference of the latter two from the indicative lay partly in the inflexional endings, partly in the addition of a special mood-suffix before these terminations. There was also an imperative. The distinction of numbers was the same as in declension,—singular, dual, plural, each of which had three persons. The tenses may be divided into three groups. The first group comprises the present and perfect, the former of which is supposed to have been used originally as a general predicative form, being neither past, present, nor future, while the perfect was used to indicate the completion of the action signified by the root. The present is rarely formed direct from the root, but more generally from a special tense-stem derived from the root by the addition of some special tense suffix or infix, or reduplication. Of the different formations of the perfect met with in the individual languages only that through reduplication of the root-syllable is believed to be of Aryan origin. The second group is that of the past tenses, the imperfect and two aorists. In all these the past sense is marked by the augment. The imperfect is regularly formed from the present stem, and the

aorist either from the root simple or reduplicated (root-aorist, corresponding to the so-called second aorist in Greek), or by inserting an *s* between the root and the inflexional endings (sibilant, or sigmatic aorist, the first aorist of Greek). The existence of a pluperfect derived from the perfect in a way similar to the derivation of the imperfect from the present is doubtful and not generally admitted. The last division is formed by the future, which, like the first aorist, inserts a sibilant after the root-syllable. None of the other formations of the future occurring here and there is believed to have existed in the parent-speech. Of participles there were three sets, belonging to the present, the perfect, and the aorist respectively. An infinitive had not yet been developed; its stem in Aryan was supplied by the use of verbal nouns.

C. Comparative *Syntax*,<sup>1</sup> to conclude with, is the youngest branch of Aryan philology. Its chief object so far has been to settle the original meanings and the primitive uses of use of the different cases, moods, and tenses. Some attempts have also been recently made to fix the rules of primitive word-order. About all these questions we must refer the reader to the original investigations of the different authors who have more especially cultivated this branch of research. (E. SL.)

PHILOMELA. See NIGHTINGALE, vol. xvii. p. 499.

PHILOPEMEN, "the last of the Greeks" as he was called by an admiring Roman, was a leading champion of the Achæan League, which preserved in Peloponnesus a last shred of Greek freedom. Sprung from an illustrious Arcadian family, he was born at Megalopolis in Arcadia in 252 B.C. His father Craugis dying in his infancy, Philopemen was brought up by his father's friend Cleander, an exile from Mantinea. In his youth he associated with Ecdemus and Megalophanes, who had studied the Academic philosophy under Arcesilaus, and had proved themselves friends of freedom by helping to rid Megalopolis and Sicyon of tyrants. Philopemen soon distinguished himself in war and the chase. Hard-featured but of an iron frame, simple and hardy in his way of life, blunt and straightforward in speech and manner,<sup>2</sup> he was a born soldier, delighting in war and careless of whatever did not bear on it. Thus he would not practise wrestling because the athlete's finely-strung habit of body is ill-fitted to bear the strain of a soldier's life. He read books of a martial and stirring tone, like the poems of Homer, together with works on military history and tactics. Epaminondas was his pattern, but he could not school his hot temper into the unruffled patience of the Theban. Indeed we miss in this rugged soldier that union of refinement at home with daring in the field which had stamped the soldier-citizens of the best age of Greece. His leisure was devoted to the chase or to the cultivation of his farm, where he worked like one of his hinds. In 222, when Cleomenes king of Sparta made himself master of Megalopolis by a night attack, Philopemen secured by his valour the retreat of the main body of the citizens to Messene, and encouraged them to refuse the insidious invitation of Cleomenes to return to their homes on condition of renouncing their connexion with the Achæan League. Thus baffled, Cleomenes laid the city in ruins and retired. At the battle of Sellasia (early summer 221), where Cleomenes was defeated by the combined Achæan and Macedonian forces under Antigonus, king of Macedonia, Philopemen greatly distinguished himself by charging, without orders, at the head of the Megalopolitan cavalry and thus saving from defeat the wing on which he fought. His conduct won the admiration of Antigonus, who offered him a command in the Macedonian army, but he declined it and went to the wars in Crete. Returning after some time with fresh laurels, he was at once chosen to command the Achæan cavalry, which, from an ill-mounted, raw, and cowardly

body he soon turned into a highly-trained and thoroughly efficient force; at the head of it he overthrew the Ætolian and Elean horse, and slew their commander with his own hand (209). He was elected general of the Achæan League for the first time in 208. In this, the highest dignity of the confederacy, he infused greater vigour and independence into the councils of the League than had been shown by Aratus, who had leaned on Macedonia and trusted to diplomacy rather than the sword. Philopemen entirely changed the equipment and tactics of the troops of the League, substituting complete armour, long lances and large shields for the lighter arms hitherto in use, and adopting the Macedonian phalanx as the fighting order. But he did more: by example and precept he turned a nation of dandies into a nation of soldiers, who now spent on arms and accoutrements the wealth they had before lavished on dinners and dress. With the army thus transformed he defeated Machanidas, tyrant of Sparta, at the battle of Mantinea. The tyrant, fell by Philopemen's hand, Tegea was taken, and Laconia ravaged. A bronze statue representing Philopemen slaying Machanidas was set up at Delphi by the Achæans. At the Nemean festival which followed the battle Philopemen, then general for the second time, was hailed by the people as the liberator of Greece. Jealous of the degree of independence to which Philopemen had raised the League, Philip king of Macedonia sent emissaries to murder him, but they were foiled. So great was the terror of his name that at the bare report that he was coming the Boeotians raised the siege of Megara and fled. When Nabis, successor of Machanidas in the tyranny of Sparta, seized Messene, Philopemen, though he held no office at the time and the general of the League refused to stir, collected his fellow-townsmen and drove out the tyrant. In his third generalship (201-200) he mustered the Achæan forces with great secrecy at Tegea and, invading Laconia, defeated the troops of Nabis. The Romans were now about to cross the sea for the war with Philip of Macedonia, and Philopemen was the means of preventing the Achæans from concluding an alliance with Philip against Rome. At the expiry of his year of office he sailed once more to Crete, where he successfully led the troops of the Gortynians, beating the Cretans with their own weapons of craft and surprise. Philopemen did not return to Peloponnesus till after the Romans under Flamininus had conquered Philip. He found the Romans and Achæans making war on Nabis and was again elected to the generalship (192). Nabis was besieging Gythium, which with the other towns on the Laconian coast had been wrested from him by the Romans, handed over by them to the Spartan exiles, and attached to the Achæan League. Being defeated in an attempt to relieve Gythium

<sup>1</sup> A list of books concerning Aryan syntax will be found in the appendix to Sayce's *Introduction to the Science of Language*, vol. II.

<sup>2</sup> The simplicity of his manners is illustrated by a tale like that of Alfred and the cakes, *Plut.*, *Phil.*, 2.

by sea, Philopœmen landed and surprised a part of the tyrant's forces not far from that town, burned their camp, and slew many. After ravaging Laconia he marched on Sparta in the hope of compelling Nabis to raise the siege. But Nabis took Gythium and awaited the Achæans in a pass. Philopœmen was surprised, but by skilful generalship he not only extricated himself but routed the Spartans and cut off most of the fugitives. When Nabis was assassinated Philopœmen hastened to Sparta and induced it to join the Achæan League. In the same year (192) Antiochus, king of Asia, crossed into Greece to fight the Romans. By the advice, or at least with the concurrence, of Philopœmen the Achæans rejected the king's proposal that they should remain neutral, and declared war against him and his allies the Ætolians. In the following year Diophanes, general of the League, hearing that Sparta showed signs of revolt, marched against it accompanied by Flaminius. Philopœmen had remonstrated in vain against this step, and he now boldly threw himself into Sparta, composed the disturbances, and closed the gates against Diophanes and Flaminius. The grateful Spartans offered Philopœmen a splendid present, but he bade them keep such bribes for their enemies. In 189 Philopœmen, again general, proposed and carried in an assembly, which he summoned at Argos, a decree that the general assembly of the League should meet in all the cities of the League in rotation, instead of, as hitherto, at Ægeum only. This measure was obviously meant to deprive Achæa of its position as head of the League, and to make the allied cities more equal. In the same year the Spartans made an unsuccessful attack on one of the maritime towns occupied by the exiles. As these towns were under Achæan protection the League required Sparta to surrender the authors of the attack. Far from complying, the Spartans put to death thirty partisans of Philopœmen and renounced their connexion with the League. The Achæans declared war, and in the following spring (188) Philopœmen, having been re-elected general, marched against Sparta, which was forced to pull down its walls, to expel the foreign mercenaries and the slaves whom the tyrants had freed, to exchange the laws and institutions of Lycurgus for those of the Achæans, and, lastly, to receive back the exiles. It would seem that on this occasion Philopœmen allowed his hatred of the old enemy of Megalopolis to overpower his judgment; his conduct was as unwise as it was cruel, for it afforded the Romans—what Philopœmen had hitherto been careful not to furnish them with—a pretext for meddling in the affairs of Greece. His treatment of Sparta was censured by the senate, and Roman officers in Greece remonstrated with the League on the subject. In 183, the last year of his life, Philopœmen was general for the eighth time (his seventh generalship perhaps fell in 187, but this is uncertain). He lay sick of a fever at Argos when word came that Messene, under Dinocrates, had revolted from the League. At first he despatched his friend and partisan Lycortas to put down the revolt, then growing impatient, in spite of the fever and his seventy years, he hurried in a single day to Megalopolis, and, taking with him the cavalry of his native town, entered Messenia and routed Dinocrates. But, the enemy being reinforced, he was compelled to fall back over broken ground. In his anxiety to cover the retreat of his troopers he was left alone, and, his horse stumbling, he was thrown to the ground and taken prisoner. He was conducted with his arms pinioned through the streets of Messene and cast into a dungeon. At nightfall on the second day an executioner was sent to him with a cup of poison. Seeing the light and the executioner standing by, Philopœmen sat up with difficulty, for he was weak, and, taking the cup in his hand, he asked the man, What tidings of the

cavalry? Being told that they had mostly escaped, he bowed his head and said that it was well. Then he drained the cup and lay down to die. Swift vengeance overtook his murderers. The indignant Achæans, under Lycortas, ravaged Messenia, and when the capital surrendered all who had had part in the murder of Philopœmen were obliged to kill themselves. Dinocrates had already committed suicide. The body of Philopœmen was burned, and his bones conveyed to Megalopolis with every mark of respect and sorrow, the urn, almost hidden in garlands, being borne by his fellow-townsmen, the historian Polybius. Numerous statues were set up, and honours decreed to him in the cities of the League. After the destruction of Corinth by Mummius some one proposed to destroy the statues of a man who had been no friend of the Romans; but the Roman general rejected the base proposal.

Philopœmen's lot was cast in evil days. Hardly were the Achæans freed by him from Macedonia when they had to submit to Rome. His policy towards the Romans was marked by a prudence and moderation hardly to be expected from one of his passionate nature. He saw that the final subjugation of Greece was inevitable, but he did his best to delay it, not by a war which would only have precipitated the catastrophe, but by giving the Romans no ground for interference, and by resisting their encroachments, so far as this could be done, by an appeal to reason and justice.

Our authorities for the life of Philopœmen are Polybius, Livy, Plutarch, and Pausanias. Polybius's work on Philopœmen was in three books, but it is lost. Plutarch's biography, like the account in Pausanias (viii. 49-51), is based on Polybius. (J. G. FR.)

**PHILOSOPHY** is a term whose meaning and scope have varied very considerably according to the usage of different authors and different ages; and it would hardly be possible, even having regard to the present time alone, to define and divide the subject in such a way as to command the adhesion of all the philosophic schools. The aim of the present article will be, however, leaving controversial details as far as possible in the background, to state generally the essential nature of philosophy as distinguished from the special sciences, and to indicate the main divisions into which, as matter of historical fact, its treatment has fallen.

*Historical Use of the Term.*—The most helpful introduction to such a task is afforded by a survey of the steps by which philosophy differentiated itself, in the history of Greek thought, from the idea of knowledge and culture in general. These steps may be traced in the gradual specification of the term. The tradition which assigns the first employment of the word to Pythagoras has hardly any claim to be regarded as authentic; and the somewhat self-conscious modesty to which Diogenes Laërtius attributes the choice of the designation is, in all probability, a piece of etymology crystallized into narrative. It is true that, as a matter of fact, the earliest uses of the word (the verb φιλοσοφῆω occurs in Herodotus and Thucydides) imply the idea of the pursuit of knowledge; but the distinction between the σοφός, or wise man, and the φιλόσοφος, or lover of wisdom, appears first in the Platonic writings, and lends itself naturally to the so-called Socratic irony. The same thought is to be found in Xenophon, and is doubtless to be attributed to the historical Socrates. But the word soon lost this special implication. What is of real interest to us is to trace the progress from the idea of the philosopher as occupied with any and every department of knowledge to that which assigns him a special kind of knowledge as his province. A specific sense of the word first meets us in Plato, who defines the philosopher as one who apprehends the essence or reality of things in opposition to the man who dwells in appearances and the shows of sense. The philosophers, he says, "are those who are able to grasp the eternal and immutable"; they are "those who set their

affections on that which in each case really exists" (*Rep.*, 480). In Plato, however, this distinction is applied chiefly in an ethical and religious direction; and, while it defines philosophy, so far correctly, as the endeavour to express what things are in their ultimate constitution, it is not yet accompanied by a sufficient differentiation of the subsidiary inquiries by which this ultimate question may be approached. Logic, ethics, and physics, psychology, theory of knowledge, and metaphysics are all fused together by Plato in a semi-religious synthesis: It is not till we come to Aristotle—the encyclopaedist of the ancient world—that we find a demarcation of the different philosophic disciplines corresponding, in the main, to that still current. The earliest philosophers, or "physiologists," had occupied themselves chiefly with what we may call cosmology; the one question which covers everything for them is that of the underlying substance of the world around them, and they essay to answer this question, so to speak, by simple inspection. In Socrates and Plato, on the other hand, the start is made from a consideration of man's moral and intellectual activity; but knowledge and action are confused with one another, as in the Socratic doctrine that virtue is knowledge. To this correspond the Platonic confusion of logic and ethics and the attempt to substitute a theory of concepts for a metaphysics of reality. Aristotle's methodic intellect led him to separate the different aspects of reality here confounded. He became the founder of logic, psychology, ethics, and aesthetics as separate sciences; while he prefixed to all such (comparatively) special inquiries the investigation of the ultimate nature of existence as such, or of those first principles which are common to, and presupposed in, every narrower field of knowledge. For this investigation Aristotle's most usual name is "first philosophy"; but there has since been appropriated to it, apparently by accident, the title "metaphysics." "Philosophy," as a term of general application, was not, indeed, restricted by Aristotle or his successors to the disciplines just enumerated. Aristotle himself includes under the title, besides mathematics, all his physical inquiries. It was only in the Alexandrian period, as Zeller points out, that the special sciences attained to independent cultivation. Nevertheless, as the mass of knowledge accumulated, it naturally came about that the name "philosophy" ceased to be applied to inquiries concerned with the particulars as such. The details of physics, for example, were abandoned to the scientific specialist, and philosophy restricted itself in this department to the question of the relation of the physical universe to the ultimate ground or author of things. This inquiry, which was long called "rational cosmology," may be said to form part of the general science of metaphysics, or at all events a pendant to it. By the gradual sifting out of the special sciences philosophy thus came to embrace primarily the inquiries grouped as "metaphysics" or "first philosophy." These would embrace, according to the scheme long current, ontology proper, or the science of being as such, with its branch sciences of (rational) psychology, cosmology, and (rational or natural) theology. Subsidiary to metaphysics, as the central inquiry, stand the sciences of logic and ethics, to which may be added aesthetics, constituting three normative sciences,—sciences, that is, which do not, primarily, describe facts, but rather prescribe ends. It is evident, however, that if logic deals with conceptions which may be considered constitutive of knowledge as such, and if ethics deals with the harmonious realization of the highest known form of existence, both sciences must have a great deal of weight in the settling of the general question of metaphysics.

Modern modifications of the above scheme will be presently considered; but it is sufficiently accurate as a starting-point, and its acceptance by so many generations of

thinkers is a guarantee for its provisional intelligibility. Accordingly, we may say that "philosophy" has been understood, during the greater part of its history, to be a general term covering the various disciplines just enumerated. It has frequently tended, however, and still tends, to be used as specially convertible with the narrower term "metaphysics." This is not unnatural, seeing that it is only so far as they bear on the one central question of the nature of existence that philosophy spreads its mantle over psychology, logic, or ethics. The organic conditions of perception and the associative laws to which the mind, as a part of nature, is subjected, are nothing to the philosopher; and therefore the handing over of (empirical) psychology to special investigators, which is at present taking place, can be productive of none but good results. Similarly, logic, so far as it is an art of thought or a doctrine of fallacies, and ethics, so far as it is occupied with a natural history of impulses and moral sentiments, do neither of them belong, except by courtesy, to the philosophic province. But, although this is so, it is perhaps hardly desirable to deprive ourselves of the use of two terms instead of one. It will not be easy to infuse into so abstract and bloodless a term as "metaphysics" the fuller life (and especially the inclusion of ethical considerations) suggested by the more concrete term "philosophy."

We shall first of all, then, attempt to differentiate philosophy from the special sciences, and afterwards proceed to take up one by one what have been called the philosophical sciences, with the view of showing how far the usual subject-matter of each is really philosophical in its bearing, and how far it belongs rather to the domain of science strictly so called. We shall also see in the course of this inquiry in what these various philosophical disciplines differ from one another, and how far they merge into another, or have, as a matter of fact, been confused at different periods in the history of philosophy. The order in which, for clearness of exposition, it will be most convenient to consider these disciplines will be psychology, epistemology or theory of knowledge, and metaphysics, then logic, aesthetics, and ethics. Finally, the connexion of the last-mentioned with politics (or, to speak more modernly, with jurisprudence and sociology) and with the philosophy of history will call for a few words on the relation of these sciences to general philosophy.

*Philosophy and Science.*—In distinguishing philosophy from the sciences, it may not be amiss at the outset to guard against the possible misunderstanding that philosophy is concerned with a subject-matter different from, and in some obscure way transcending, the subject-matter of the sciences. Now that psychology, or the observational and experimental study of mind, may be said to have been definitively included among the positive sciences, there is not even the apparent ground which once existed for such an idea. Philosophy, even under its most discredited name of metaphysics, has no other subject-matter than the nature of the real world, as that world lies around us in everyday life, and lies open to observers on every side. But if this is so, it may be asked what function can remain for philosophy when every portion of the field is already lotted out and enclosed by specialists? Philosophy claims to be the science of the whole; but, if we get the knowledge of the parts from the different sciences, what is there left for philosophy to tell us? To this it is sufficient to answer generally that the synthesis of the parts is something more than that detailed knowledge of the parts in separation which is gained by the man of science. It is with the ultimate synthesis that philosophy concerns itself; it has to show that the subject-matter which we are all dealing with in detail really is a whole, consisting of articulated members. Evidently, therefore, the relation existing be-



tween philosophy and the sciences will be, to some extent, one of reciprocal influence. The sciences may be said to furnish philosophy with its matter, but philosophical criticism reacts upon the matter thus furnished, and transforms it. Such transformation is inevitable, for the parts only exist and can only be fully, i.e., truly, known in their relation to the whole. A pure specialist, if such a being were possible, would be merely an instrument whose results had to be co-ordinated and used by others. Now, though a pure specialist may be an abstraction of the mind, the tendency of specialists in any department naturally is to lose sight of the whole in attention to the particular categories or modes of nature's working which happen to be exemplified, and fruitfully applied, in their own sphere of investigation; and in proportion as this is the case it becomes necessary for their theories to be co-ordinated with the results of other inquirers, and set, as it were, in the light of the whole. This task of co-ordination, in the broadest sense, is undertaken by philosophy; for the philosopher is essentially what Plato, in a happy moment, styled him, *συνσπικτικός*, the man who insists on seeing things together. The aim of philosophy (whether attainable or not) is to exhibit the universe as a rational system in the harmony of all its parts; and accordingly the philosopher refuses to consider the parts out of their relation to the whole whose parts they are. Philosophy corrects in this way the abstractions which are inevitably made by the scientific specialist, and may claim, therefore, to be the only concrete science, that is to say, the only science which takes account of all the elements in the problem, and the only science whose results can claim to be true in more than a provisional sense.

For it is evident from what has been said that the way in which we commonly speak of "facts" is calculated to convey a false impression. The world is not a collection of individual facts existing side by side and capable of being known separately. A fact is nothing except in its relations to other facts; and as these relations are multiplied in the progress of knowledge the nature of the so-called fact is indefinitely modified. Moreover, every statement of fact involves certain general notions and theories, so that the "facts" of the separate sciences cannot be stated except in terms of the conceptions or hypotheses which are assumed by the particular science. Thus mathematics assumes space as an existent infinite, without investigating in what sense the existence or the infinity of this "Unding," as Kant called it, can be asserted. In the same way, physics may be said to assume the notion of material atoms and forces. These and similar assumptions are ultimate presuppositions or working hypotheses for the sciences themselves. But it is the office of philosophy, or theory of knowledge, to submit such conceptions to a critical analysis, with a view to discover how far they can be *thought out*, or how far, when this is done, they refute themselves, and call for a different form of statement, if they are to be taken as a statement of the ultimate nature of the real.<sup>1</sup> The first statement may frequently turn out to have been merely provisionally or relatively true; it is then superseded by, or rather inevitably merges itself in, a less abstract account. In this the same "facts" appear differently, because no longer separated from other aspects that belong to the full reality of the known world. There is no such thing, we have said, as an individual fact; and the nature of any fact is not fully known unless we know it in all its relations to the

system of the universe, or, in Spinoza's phrase, "sub specie eternitatis." In strictness, there is but one *res completa* or concrete fact, and it is the business of philosophy, as science of the whole, to expound the chief relations that constitute its complex nature.

The last abstraction which it becomes the duty of philosophy to remove is the abstraction from the knowing subject which is made by all the sciences, including, as we shall see, the science of psychology. The sciences, one and all, deal with a world of objects, but the ultimate fact as we know it is the existence of an object for a subject. Subject-object, knowledge, or, more widely, self-consciousness with its implicates—this unity in duality is the ultimate aspect which reality presents. It has generally been considered, therefore, as constituting in a special sense the problem of philosophy. Philosophy may be said to be the explication of what is involved in this relation, or, in modern phraseology, a theory of its possibility. Any would-be theory of the universe which makes its central fact impossible stands self-condemned. On the other hand, a sufficient analysis here may be expected to yield us a statement of the reality of things in *its last terms*, and thus to shed a light backwards upon the true nature of our subordinate conceptions.

*Psychology, Epistemology, and Metaphysics.*—This leads to the consideration of our first group of subsidiary sciences—*PSYCHOLOGY* (*q.v.*), epistemology (theory of knowledge, Erkenntnisstheorie), and metaphysics (ontology; see *ΜΕΤΑΦΥΣΙΚΗ*). A special relation has always existed between psychology and systematic philosophy, but the closeness of the connexion has been characteristic of modern and more particularly of English thought. The connexion is not difficult to explain, seeing that in psychology, or the science of mind, we study the fact of intelligence (and moral action), and have, so far, in our hands the fact to which all other facts are relative. From this point of view we may even agree with Sir W. Hamilton when he quotes Jacobi's dictum—"Nature conceals God; man reveals God." In other words, as has just been said, the ultimate explanation of things cannot be given by any theory which excludes from its survey the intelligence in which nature, as it were, gathers herself up. But knowledge, or the mind as knowing, willing, &c., may be looked at in two different ways. It may be regarded simply as a fact, in which case the evolutions of mind may be traced and reduced to laws in the same way as the phenomena treated by the other sciences. This study gives us the science of empirical psychology, or, as it is now termed, psychology *sensu phrase*. In order to give an adequate account of its subject-matter, psychology may require higher or more complex categories than are employed in the other sciences, just as biology, for example, cannot work with mechanical categories alone, but introduces the conception of development or growth. But the affinities of such a study are manifestly with the sciences as such rather than with philosophy; and it has been already pointed out that the division of labour in this respect is proceeding rapidly. Since it has been taken up by specialists, psychology is being established on a broader basis of induction, and with the advantage, in some departments, of the employment of experimental methods of measurement. But it is not of mind in this aspect that such assertions can be made as those quoted above. Mind, as studied by the psychologist—mind as a mere fact or phenomenon—grounds no inference to anything beyond itself. The distinction between mind viewed as a succession of "states of consciousness" and the further aspect of mind which philosophy considers is very clearly put in a recent article by Professor Croom Robertson, who also makes a happy suggestion of two terms to designate the double point of view.

<sup>1</sup> The revisional office which philosophy here assumes constitutes her the critic of the sciences. It is in this connexion that the meaning of the definition of philosophy as "the science of principles" can best be seen. This is perhaps the most usual definition, and, though vague, one of the least misleading.

"We may view knowledge as mere subjective function, but it has its full meaning only as it is taken to represent what we may call objective fact, or is such as is named (in different circumstances) real, valid, true. As mere subjective function, which it is to the psychologist, it is best spoken of by an unambiguous name, and for this there seems none better than Intellection. We may then say that psychology is occupied with the natural function of *Intellection*, seeking to discover its laws and distinguishing its various modes (perception, representative imagination, conception, &c.) according to the various circumstances in which the laws are found at work. Philosophy, on the other hand, is theory of *Knowledge* (as that which is known)."—"Psychology and Philosophy," *Mind*, 1888, pp. 15, 16.

The confusion of these two points of view has led, and still leads, to serious philosophical misconception. It is hardly an exaggeration to say that, in the English school since Hume, psychology superseded properly philosophical inquiry. The infusion of epistemological matter into the numerous analyses of the human mind rendered the substitution plausible and left men satisfied. And we find even a thinker with a wider horizon like Sir W. Hamilton encouraging the confusion by speaking of "psychology or metaphysica,"<sup>1</sup> while his lectures on metaphysics are mainly taken up with what belongs in the strictest sense to psychology proper, with an occasional excursus (as in the theory of perception) into epistemology. That this confusion is on the way to be obviated for the future is largely due to the Kantian impulse which has been strongly felt of late in English thought, and which has acted in this matter on many who could not, by any laxity of terminology, be numbered as Kantians or Neo-Kantians. The distinction between psychology and theory of knowledge was first clearly made by Kant, who repeatedly insisted that the *Critique of Pure Reason* was not to be taken as a psychological inquiry. He defined his problem as the *quid juris* or the question of the validity of knowledge, not its *quid facti* or the laws of the empirical genesis and evolution of intellection (to use Professor Robertson's phraseology). Since Kant philosophy has chiefly taken the form of theory of knowledge or of a criticism of experience. Not, indeed, a preliminary criticism of our faculties or conceptions such as Kant himself proposed to institute, in order to determine the limits of their application; such a criticism *ab extra* of the nature of our experience is essentially a thing impossible. The only criticism which can be applied in such a case is the immanent criticism which the conceptions or categories exercise upon one another. The organized criticism of these conceptions is really nothing more than the full explication of what they mean and of what experience in its full nature or notion is. This constitutes the theory of knowledge, and lays down, in Kantian language, the conditions of the possibility of experience. These conditions are the conditions of knowledge as such, of self-consciousness in general, or, as it may be put, of objective consciousness. The inquiry is, therefore, logical or transcendental in its nature, and does not entangle us in any decision as to the conditions of the genesis of such consciousness in the individual. When we inquire into subjective conditions, we are thinking of facts causing other facts. But the logical or transcendental conditions are not causes or even factors of knowledge; they are the statement of its idea. Hence the dispute at the present time between evolutionist and transcendentalist rests, in general, on an *ignoratio elenchis*; for the history of the genesis of an idea (the historical or genetic method) does not contain an answer to—though it may throw light on—the philosophic question of its truth or validity. Speaking of this transcendental consciousness, Kant goes so far as to say that it is not

<sup>1</sup> It is true that he afterwards modifies this misleading identification by introducing the distinction between empirical psychology or the phenomenology of mind and inferential psychology or ontology, i.e., metaphysics proper. But he continues to use the terms "philosophy," "metaphysics," and "mental science" as synonymous.

of the slightest consequence "whether the idea of it be clear or obscure (in empirical consciousness), no, not even whether it really exists or not. But the possibility of the logical form of all knowledge rests on its relation to this apperception as a faculty or potentiality" (*Works*, ed. Hartenstein, iii. 578 note). Or, if we return to the distinction between epistemology and psychology, by way of illustrating the nature of the former, we may take the summing up of Mr Ward in a valuable article on "Psychological Principles" recently contributed to *Mind* (April 1883, pp. 166, 167). "Comparing psychology and epistemology, then, we may say that the former is essentially genetic in its method, and might, if we had the power to revise our existing terminology, be called biology; the latter, on the other hand, is essentially devoid of everything historical, and treats, *sub specie eternitatis*, as Spinoza might have said, of human knowledge, conceived as the possession of mind in general."

Kant's problem is not, in its wording, very different from that which Locke set before him when he resolved to "inquire into the original, certainty, and extent of human knowledge together with the grounds and degrees of belief, opinion, and assent." Locke's *Essay* is undoubtedly, in its intention, a contribution to the theory of knowledge, as any one may verify for himself by turning to the headings of the chapters in the fourth book. But, because time had not yet made the matter clear, Locke suffered himself to digress in his second book into the purely psychological question of the origin of our ideas, or, as Kant called it, the physiology of the human mind. Appearing thus, first, as the problem of perception (in Locke and his English successors), widening its scope and becoming, in Kant's hands, the question of the possibility of experience in general, epistemology may be said to have passed with Hegel into a completely articulated "logic," that claimed to be at the same time a metaphysic, or an ultimate expression of the nature of the real. This introduces us to the second part of the question we are seeking to determine, namely, the relation of epistemology to metaphysica.

It is evident that philosophy as theory of knowledge must have for its complement philosophy as metaphysica or ontology. The question of the truth of our knowledge, and the question of the ultimate nature of what we know, are in reality two sides of the same inquiry; and therefore our epistemological results have to be ontologically expressed. But it is not every thinker that can see his way with Hegel to assert in set terms the identity of thought and being. Hence the theory of knowledge becomes with some a theory of human ignorance. This is the case with Herbert Spencer's doctrine of the unknowable, which he advances as the result of epistemological considerations in the philosophical prolegomena to his system. Very similar positions were maintained by Kant and Comte; and, under the name of "agnosticism," the theory has popularized itself of late in the outer courts of philosophy, and on the shifting borderland of philosophy and literature. The truth is that the habit of thinking exclusively from the standpoint of the theory of knowledge tends to beget an undue subjectivity of temper. And the fact that it has become usual for men to think from this standpoint is very plainly seen in the almost universal description of philosophy as an analysis of "experience," instead of its more old-fashioned designation as an inquiry into "the nature of things." Now it is matter of universal agreement that the problem of being must be attacked indirectly through the problem of knowledge; and therefore this substitution certainly marks an advance, in so far as it implies that the fact of experience, or of self-conscious existence, is the chief fact to be dealt with. But if so, then self-consciousness must really be treated as existing,

and as organically related to the rest of existence. If self-consciousness be treated in this objective fashion, then we pass naturally from epistemology to metaphysics or ontology. (For, although the term "ontology" has been as good as disused, it still remains true that the aim of philosophy must be to furnish us with an ontology or a coherent and adequate theory of the nature of the existent.) But if, on the other hand, knowledge and existence be *ab initio* opposed to one another—if consciousness be set on one side as over against existence, and merely holding up a mirror to it—then it follows with equal naturalness that the truly objective must be something which lurks unrevealed behind the subject's representation of it. Hence come the different varieties of a so-called phenomenism. The upholders of such a theory would, in general, deride the term "metaphysics" or "ontology"; but it is evident, none the less, that their position itself implies a certain theory of the universe and of our own place in it, and philosophy with them will consist, therefore, in the establishment of this theory.

Without prejudice, then, to the claims of epistemology to constitute the central philosophic discipline, we may simply note its liability to be misused. The exclusive preoccupation of men's minds with the question of knowledge during the last quarter of a century or more drew from Lotze the caustic criticism that "the continual sharpening of the knife becomes tiresome, if, after all, we have nothing to cut with it." Stillingfleet's complaint against Locke was that he was "one of the gentlemen of this new way of reasoning that have almost discarded substance out of the reasonable part of the world." The same may be said with greater truth of the devotees of the theory of knowledge; they seem to have no need of so old-fashioned a commodity as reality. Yet, after all, Fichte's dictum holds good that knowledge *as* knowledge—*i. e.*, so long as it is looked at as knowledge—is, *ipso facto*, not reality. The result of the foregoing, however, is to show that, as soon as epistemology draws its conclusion, it becomes metaphysics; the theory of knowledge passes into a theory of being. The ontological conclusion, moreover, is not to be regarded as something added by an external process; it is an immediate implication. The metaphysic is the epistemology from another point of view—regarded as completing itself, and explaining in the course of its exposition that relative or practical separation of the individual known from the knowable world which it is a sheer assumption to take as absolute. This, not the so-called assumption of the implicit unity of being and thought, is the really unwarrantable postulate; for it is an assumption which we are obliged to retract bit by bit, while the other offers the whole doctrine of knowledge as its voucher.

*Logic, Aesthetics, and Ethics.*—If the theory of knowledge thus takes upon itself the functions discharged of old by metaphysics, it becomes somewhat difficult to assign a distinct sphere to logic. It has already been seen how the theory of knowledge, when it passed out of Kant's hands, and tried to make itself (a) complete and (b) presuppositionless, became for Hegel a logic that was in reality a metaphysic. This is the comprehensive sense given to logical science in the article LOGIC (*q. v.*) in this work; and it is there contended that no other definition can be made consistent with itself. It is, of course, admitted that this is not the traditional use of the term (see vol. xiv. p. 802). Ueberweg's definition of logic as "the science of the regulative laws of thought" (or "the normative science of thought") comes near enough to the old sense to enable us to compare profitably the usual subject-matter of the science with the definition and end of philosophy. The introduction of the term "regulative" or "normative" is intended to differentiate the science from psychology as the

science of mental events. In this reference logic does not tell us how our intellects connect themselves as mental phenomena, but how we ought to connect our thoughts if they are to realize truth (either as consistency with what we thought before or as agreement with observed facts). Logic, therefore, agrees with epistemology (and differs from psychology) in treating thought not as mental fact but as knowledge, as idea, as having meaning in relation to an objective world. To this extent it must inevitably form a part of the theory of knowledge. But, if we desire to keep by older landmarks and maintain a distinction between the two disciplines, a ground for doing so may be found in the fact that all the main definitions of logic point to the investigation of the laws of thought in a subjective reference,—with a view, that is, by an analysis of the operation, to ensure its more correct performance. According to the old phrase, logic is the art of thinking. Moreover, the fact that ordinary logic investigates its laws primarily in this reference, and not disinterestedly as immanent laws of knowledge or of the connexion of conceptions, brings in its train a limitation of the sphere of the science as compared with the theory of knowledge. We find the logician uniformly assuming that the process of thought has advanced a certain length before his examination of it begins; he takes his material full-formed from perception, without, as a rule, inquiring into the nature of the conceptions which are involved in our perceptive experience. Occupying a position, therefore, within the wider sphere of the general theory of knowledge, ordinary logic consists in an analysis of the nature of general statement, and of the conditions under which we pass validly from one general statement to another. But the logic of the schools is eked out by contributions from a variety of sources (*e. g.*, from grammar on one side and from psychology on another), and cannot claim the unity of an independent science.

ἘΣΤΗΤΙΚΟΣ (*q. v.*) may be treated as a department of psychology or physiology, and in England this is the mode of treatment that has been most general. To what peculiar excitation of our bodily or mental organism, it is asked, are the emotions due which make us declare an object beautiful or sublime? And, the question being put in this form, the attempt has been made in some cases to explain away any peculiarity in the emotions by analysing them into simpler elements, such as primitive organic pleasures and prolonged associations of usefulness or fitness. But, just as psychology in general can in no sense do duty for a theory of knowledge, so it holds true of this particular application of psychology that a mere reference of these emotions to the mechanism and interactive play of our faculties cannot be regarded as an account of the nature of the beautiful. The substitution of the one inquiry for the other may doubtless be traced in part to the latent assumption—standing very much in need of proof—that our faculties are constructed on some arbitrary plan, without reference to the general nature of things. Perhaps by talking of "emotions" we tend to give an unduly subjective colour to the investigation; it would be better to speak of the *perception* of the beautiful. Pleasure in itself is unqualified, and affords no differentia. In the case of a beautiful object the resultant pleasure borrows its specific quality from the presence of determinations essentially intellectual in their nature, though not reducible to the categories of science. We have a *prima facie* right, therefore, to treat beauty as an objective determination of things. The question of aesthetics would then be formulated—What is it in things that makes them beautiful, and what is the relation of this aspect of the universe to its ultimate nature, as that is expounded in metaphysics? The answer constitutes the substance of aesthetics, con-

sidered as a branch of philosophy. But it is not given simply in abstract terms; aesthetics includes also an exposition of the concrete phases of art, as these have appeared in the history of the world, relating themselves to different stages of the spirit's insight into itself and into things.

Of *EROS* (*q.v.*) it may also be said that many of the topics commonly embraced under that title are not strictly ethical at all, but are subjects for a scientific psychology employing the historical method with the conceptions of heredity and development, and calling to its aid, as such a psychology will do, the investigations of ethnology, and all its subsidiary sciences. To such a psychology must be relegated all questions as to the origin and development of moral ideas. Similarly, the question debated at such length by English moralists as to the nature of the moral faculty (moral sense, conscience, &c.) belongs entirely to psychology. This is more generally admitted in regard to the controversy concerning the freedom of the will, though that still forms part of most ethical treatises. If we exclude such questions in the interest of systematic correctness, and seek to determine for ethics a definite subject-matter, the science may be said to fall into two departments. The first of these deals with the notion of duty, as such, and endeavours to define the ultimate end of action; the second lays out the scheme of concrete duties which are deducible from, or which, at least, are covered by, this abstractly-stated principle. The second of these departments is really the proper subject-matter of ethics considered as a separate science; but it is often conspicuous by its absence from ethical treatises. However moralists may differ on first principles, there seems to be remarkably little practical divergence when they come to lay down the particular laws of morality. Hence, as it must necessarily be a thankless task to tabulate the commonplaces of conduct, the comparative neglect of this part of their subject is perhaps sufficiently explained. It may be added that, where a systematic account of duties is actually given, the connexion of the particular duties with the universal formula is in general more formal than real. It is only under the head of "casuistry" that ethics has been much cultivated as a separate science. The first department of ethics, on the other hand, is the branch of the subject in virtue of which ethics forms part of philosophy. As described above, it merges in general metaphysics or ontology, and ought rather to be called, in Kant's phrase, the metaphysics of ethics. A theory of obligation is ultimately found to be inseparable from a metaphysics of personality. The connexion of ethics with metaphysics will be patent as a matter of fact, if it be remembered how Plato's philosophy is summed up in the idea of the good, and how Aristotle also employs the essentially ethical notion of end as the ultimate category by which the universe may be explained or reduced to unity. But the necessity of the connexion is also apparent, unless we are to suppose that, as regards the course of universal nature, man is altogether an *imperium in imperio*, or rather (to adopt the forcible phrase of Marcus Aurelius) an abscess or excrescence on the nature of things. If, on the contrary, we must hold that man is essentially related to "a common nature," as the same writer puts it, then it is a legitimate corollary that in man as intelligence we ought to find the key of the whole fabric. At all events, this method of approach must be truer than any which, by restricting itself to the external aspect of phenomena as presented in space, leaves no scope for inwardness and life and all that, in Lotze's language, gives existence "value." Historically we may be said in an intelligible sense to explain the higher by showing its genesis from the lower. But in philosophy it is exactly the reverse; the lower is always to be explained by the higher. In the ethical

reference it has been customary to argue, as Sir W. Hamilton does, from man's moral being to "an Intelligent Creator and Moral Governor of the Universe." It is evident that the argument *ex analogia hominis* may sometimes be carried too far; but if a "chief end of man" be discoverable—*ἄρσένειον ἀγαθόν*, as Aristotle wisely insisted that the ethical end must be determined—then it may be assumed that this end cannot be irrelevant to that ultimate "meaning" of the universe which, according to Lotze, is the quest of philosophy. If "the idea of humanity," as Kant called it, has ethical perfection at its core, then a universe which is organic must be ultimately representable as a moral order or a spiritual kingdom such as Leibnitz named, in words borrowed from Augustine, a city of God.

*Politics, Sociology, Philosophy of History.*—In Aristotle we can observe how ethics is being differentiated from politics, but this differentiation does not, and ought not to, amount to a complete separation. The difficulty, already hinted at, which individualistic systems of ethics experience in connecting particular duties with the abstract principle of duty is a proof of the failure of their method. For the content of morality we are necessarily referred, in great part, to the experience crystallized in laws and institutions and to the unwritten law of custom, honour, and good breeding, which has become organic in the society of which we are members. The development of society is therefore brought within the scope of philosophy. So far as this development is traced in a purely historical spirit, it will be simply a sequence of efficient causes, in which, starting with a b c, we eventually arrive at A B C. But, if this sequence is to be philosophized, it must be shown that we have no means of knowing what a b c is except in its relation to A B C, its resultant. We interpret the process, therefore, as the realization of an immanent end. The state, as the organism in whose play morality is realized, becomes an interest of reason; and the different forms of state-organization are judged according to the degree in which they realize the reconciliation of individual freedom and the play of cultured interests with stable objectivity of law and an abiding consciousness of the greater whole in which we move. So far as the course of universal history can be truly represented as an approximation to this reconciliation by a widening and deepening of both the elements, we may claim to possess a philosophy of history. (A. SE.)

PHILOSTRATUS, the eminent Greek sophist, was probably born in Lemnos between 170 and 180 A.D. From his incidental statements respecting himself we learn that he studied at Athens, and was afterwards attached to the court of the empress Julia Domna, consort of Severus. Since he does not speak of her as living, while mentioning her as his patroness in his *Life of Apollonius of Tyana*, this work was probably written after her death. From some passages in it and his *Lives of the Sophists*, he would seem to have been in Gaul with Caracalla, and he may probably have accompanied that emperor on his progress through his dominions. The only other fixed date we possess for his life is afforded by his dedication of the *Lives of the Sophists* to Antonius Gordianus as proconsul. Gordianus was consul in 230, and his proconsulship must have been between that year and 234. It seems to be implied that Philostratus resided in Rome, and, according to Suidas, he lived until the reign of Philip (244-249). His works now extant are a biography of Apollonius of Tyana, *Lives of the Sophists*, *Heroicon*, *Imagines*, and *Epistles*.

The *Life of Apollonius of Tyana* has been partly discussed under APOLLONIUS. It may be compared to the *Cyropaedia* of Xenophon as a romance founded on fact, treating of a distinguished historical person, not in an historical spirit, but as an ideal model for imitation. While, however, the

incidents of Xenophon's romance were mostly his own invention, Philostratus was indebted for his to the narrative attributed to Damis, Apollonius's travelling companion; and many of the sayings ascribed to Apollonius, such as his bon-mots against Domitian and his protest against gladiatorial combats, are probably authentic. The rest of the work testifies to the increasing fondness of the age for the marvellous, which Lucian had vainly endeavoured to stem in the preceding generation, and to the tendency to set up semi-mythical sages like Pythagoras as prophets, at the expense of sober reasoners like Zeno and Epicurus. Philostratus, however, is careful to disclaim all connexion of his hero with mere vulgar thaumaturgy. The sorcerer, he expressly says, is a miserable person. Apollonius is the sage who foreknows the future not by incantations but by wisdom and conformity to the will of the gods,—a new Pythagoras, the prototype, we can now see, of Apuleius, Plotinus, and the other later Platonists, who, without wholly discarding philosophical method, coquetted with ecstasy and revelation. Philosophy, in truth, had become bankrupt, physical science did not yet exist, and the best minds of the time were necessarily thrown back on the supernatural. Philostratus gives this tendency of the age a concrete expression, and there is no reason to conceive that his work was composed in any spirit of antagonism to Christianity, whose Founder, equally with Apollonius himself, was venerated by his patron Alexander Severus. Though a mass of fiction, it is still very valuable as delineating the ideal of the philosophic character as recognized in the 3d century. It is full of errors in geography and chronology, but possesses great literary merit, being varied, entertaining, animated, and lively and accurate in its pictures of character. *Sophistica certe artis egregium dedit in hoc libro specimen*, says Kayser. The distinction between a philosopher and a sophist is clearly laid down by Philostratus himself in his next important work, the *Lives of the Sophists*. The philosopher investigates truth independently; the sophist embellishes the truth, which he takes for granted. The distinction is much the same as that between the theologian and the preacher, or the jurist and the advocate. Philostratus, though by no means attempting detailed biography after the fashion of Diogenes Laertius, has given us interesting sketches of a number of distinguished ornaments of the sophistical profession, mostly his immediate predecessors or contemporaries. He thus affords a lively picture of the intellectual standard of an age full of curiosity and intelligence, but unable to make progress in knowledge for want of a scientific method or a scientific spirit, living on old literary models which it was unable to emulate or vary, and hence compelled to prefer show to substance, and manner to matter. The *Heroicon* is a good specimen of the popular literature of the day. It may have arisen out of Caracalla's visit to Ilium, and the games celebrated by him in honour of Achilles. The subject is the injustice of Homer to Palamedes, which is expounded to a Phœnician merchant by a Thracian vine-dresser on the authority of the latter's tutelary demon, the hero Proteus. It was probably a common theme of declamation in the schools, to which Philostratus has contributed an elegant and graceful setting. The *Imagines*, after the life of Apollonius the most entertaining of Philostratus's writings, is perhaps the most valuable of any from the light it throws on ancient art. The writer is introduced as living in a villa near Naples, which contains a collection of choice paintings. To please the son of his host and his young companions he undertakes to describe and explain the pictures, which are sixty-four in all, including mythological, historical, allegorical, and landscape subjects. The descriptions are exceedingly good, and reveal the skilful word-painter no less than the accomplished

connoisseur of art. As pointed out by M. Bougot, they either actually are or are intended to be taken for improvisations, which explains some irregularities in the style. It has been much disputed whether they are genuine descriptions of actually existing works of art. The affirmative has been maintained by Goethe and Welcker, the negative by Heyne. In our days the controversy has been revived by two eminent German archaeologists, Friederichs and Brunn, the former impugning, the latter maintaining the actual existence of the pictures. Their arguments are reviewed in a recent and valuable work by E. Bertrand, who sides with Brunn, as also does Helbig. Perhaps the point is not of such extreme moment, for, if Philostratus had not actual pictures in his mind, he must nevertheless have described such as his hearers or readers were in the habit of seeing. The traces of improvisation, however, pointed out by M. Bougot afford a strong argument that he was lecturing upon a visible collection, and in any case his work is a most valuable guide to the manner in which heroic figures were delineated in ancient paintings, to the general grouping and arrangement of such works, and to the qualities which they were expected to possess. Philostratus's *Epistles* are entirely artificial, and mostly amatory. The style is good, and the originals of some pretty conceits appropriated by modern poets may be found in them.<sup>1</sup>

The first complete edition of the works of Philostratus was published by F. Morel, Paris, 1608. It is not much esteemed. That by Olearius (Leipzig, 1709) is much better; but the chief restorer of the text is C. F. Kayser, who, after having edited most of the writings of Philostratus, separately published a collective edition at Zurich in 1844, reissued in 1853, and again at Leipzig in 1870-71. There is a very good edition, with a Latin translation, by Westermann (Paris, 1849); this also contains Eusebius's *Lives of the Sophists* and the declamations of Himerius. The first two books of the *Lives of Apollonius* were translated into English by the celebrated and unfortunate Charles Blount in 1680; but the unorthodox nature of the commentary, attributed in part to Lord Herbert of Chisbury, occasioned the work to be prohibited, and it was not continued. A complete translation by E. Berwick, an Irish clergyman, was published in 1809. A French translation by Chassigny (*Le Merveilleux dans l'Antiquité*, Paris, 1862) contains some valuable notes. The most important works on the *Imagines* are: Friederichs, *Die Philostratischen Bilder*, 1860; Brunn, *Die Philostratischen Gemälde*, 1861; A. Bougot, *Une galerie antique*, 1881; and E. Bertrand, *Un critique d'art dans l'antiquité: Philostratus et son école*, 1882. (R. G.)

PHILOXENUS, one of the last of the dithyrambic poets of Greece, was born in 435 B.C. in the island of Cythera. When the island was conquered by the Athenians in 424 Philoxenus was sold as a slave to Agesylas, who gave him the name of Myrmex ("ant"). On the death of Agesylas he was bought by the dithyrambic poet Melanippides, who educated him, no doubt in his own profession. Philoxenus afterwards resided in Sicily, at the court of Dionysius, tyrant of Syracuse, whose bad verses he declined to praise, and was in consequence sent to work in the quarries. Being fetched back again and asked by the tyrant how he liked his verses now, the poet made no reply but "Take me away to the quarries." He is said to have quitted Sicily in disgust at the luxury and vulgarity of the people, abandoning an estate which he owned in the island. From Sicily he seems to have gone to Tarentum, and thence perhaps to Corinth. He visited Colophon in Asia Minor and died at Ephesus in 380. According to Suidas, Philoxenus composed twenty-four dithyrambs and a lyric poem on the genealogy of the *Æacids*. In his hands the dithyramb seems to have been a burlesque drama in verse, which was acted and sung to the accompaniment of elaborate instrumental music and enlivened

<sup>1</sup> A younger Philostratus, also called the Lemnian, is several times mentioned by the elder as a contemporary sophist. He speaks of him as a friend, but does not say that he was a kinsman. Another and much inferior collection of *Imagines* is extant under the name of this writer, who claims relationship with the elder Philostratus. It is probably a supposititious work.

with the dance,—in short, it was a sort of comic opera. The music, which Philoxenus himself composed, appears to have been of a debased, Offenbachian character. His masterpiece was the *Cyclops or Galatea*, a pastoral burlesque on the love of the Cyclops for the fair Galatea. Its general style may probably be gathered from the sixth idyl of Theocritus. The work must have been well known before 388, for it was parodied by Aristophanes in his play the *Plutus*, performed in that year. Another work of Philoxenus, sometimes attributed to a notorious parasite and glutton of the same name, is the *Δείπνον* (Dinner), of which considerable fragments have been preserved by Athenæus. This poem, of which the text is very obscure and corrupt, is little more than an elaborate bill of fare put into verse, and, as such, possesses more interest for cooks than scholars. In the time of Aristotle it was the one book read by the Athenian quidnuncs. The great popularity enjoyed by Philoxenus is attested not only by the allusions to him in the comic poets of his day but also by a complimentary resolution passed by the Athenian senate in 393 on the motion of the dithyrambic poet Cinesias. The intention of the decree was doubtless mainly political—to propitiate Dionysius—but the poet was included in it. Nor was his popularity transient: the poet Antiphanes of the Middle Comedy spoke of Philoxenus as a god among men; Alexander the Great had his poems sent to him in Asia along with the tragedies of Æschylus, Sophocles, and Euripides; the Alexandrian grammarians received him into the canon; and down to the time of Polybius his works were regularly learned and annually acted by the Arcadian youth. The scanty fragments of his works are to be found in Bergk's *Poeta Lyrici Græci*, vol. iii.

PHLEGON, of Tralles in Asia Minor, a Greek writer of the 2d century, was a freedman of the emperor Hadrian. His chief work was the *Olympiads* (chronicles, or collection of Olympic victories and chronicles), a universal history in sixteen books, from the 1st down to the 229th Olympiad (776 B.C. to 137 A.D.). If we may judge from the sample preserved by Photius, the work contained lists of the victors in the Olympic games together with a bare and disjointed summary of the chief historical events; it is probable, however, that Photius quoted from an epitome in eight books which we know to have existed, and which, together with another epitome in two books, is ascribed by Suidas to Phlegon himself. Portions of another work of Phlegon, *On Marvels*, along with parts of another *On Long-lived Persons*, and the opening part of his *Olympiads*, are extant in a Heidelberg MS. of the 10th century.

The book *On Marvels* contains some ridiculous stories about ghosts, prophecies, and monstrous births. The work *On Long-lived Persons* includes a list, extracted by Phlegon from the Roman censuses, of persons who had lived a hundred years and upwards. He mentions two men aged 136 years each, one of whom he professes to have seen. Other works ascribed to Phlegon by Suidas are a description of Sicily, a work on the Roman festivals in three books, and a topography of Rome. Helius Spartianus tells us that a life of Hadrian was published in Phlegon's name, but that it was written by the emperor himself. A work on *Women Wise and Dumb in War* has sometimes been wrongly attributed to Phlegon. From his remains Phlegon is seen to have been credulous and superstitious to absurdity, but his literary style deserves the remark of Photius that, without being pure Attic, it is not very bad. The complaint of Photius, that Phlegon wearied his readers by the numerous oracles which he dragged in, is fully borne out by the remains of his works. These remains are collected by Westermann in his *Scriptores rerum mirabilium Græci* (1839) and by Müller in his *Fragmenta Historicorum Græcorum*, vol. iii.

PHLOX, a considerable genus of *Polemoniaceæ*, chiefly consisting of North-American perennial plants, with entire, usually opposite, leaves and showy flowers generally in terminal clusters. Each flower has a tubular calyx with five lobes, and a salver-shaped corolla with a long slender

tube and a flat limb. The five stamens are given off from the tube of the corolla at different heights and do not protrude beyond it. The ovary is three-celled with one to two ovules in each cell; it ripens into a three-valved capsula. Many of the species are cultivated for the beauty of their flowers; and the forms obtained by cross-breeding and selection are innumerable. The garden varieties fall under three groups,—the annuals, including the lovely *P. Drummondii* from Texas and its many forms; the perennials, including a dwarf section of alpine plants (forms of *P. subulata*), suitable, by reason of their prostrate habit and neat mode of growth, for the rockery; and the taller-growing decumbent phloxes which contribute so much to the beauty of gardens in late summer, and which have probably originated from *P. paniculata*. The range of colour in all the groups is from white to rose and lilac.

PHOCÆA, in ancient geography, was one of the cities of Ionia, on the western coast of Asia Minor. It was the most northern of the Ionian cities, and was situated on the coast of the peninsula that separates the Gulf of Cyme, which was occupied by Æolian settlers, from the Hermæan Gulf, on which stood Smyrna and Clazomene.<sup>1</sup> Its advantageous position between two good harbours, called Næustathmus and Lampter, is pointed out by Livy (xxxvii. 31), and was probably the cause which led the inhabitants to devote themselves from an early period to maritime pursuits. We are expressly told by Herodotus that the Phocæans were the first of all the Greeks who undertook distant voyages and made known to their countrymen the coasts of the Adriatic, as well as those of Tyrrhenia and Spain. In the latter country they established friendly relations with Arganthonius, king of Tartessus, who even invited them to emigrate in a body to settle in his dominions, and, on their declining this offer, presented them with a large sum of money. This they employed in constructing a strong wall of fortification around their city, a defence which stood them in good stead when the Ionian cities were attacked by Cyrus in 546. On that occasion they refused to submit when besieged by Harpagus, the general of Cyrus; but, mistrusting their power of ultimate resistance, they determined to abandon their city, and, embarking their wives and children and most valuable effects, to seek a new home in the western regions, where they had already founded several flourishing colonies, among others those of Alalia in Corsica and the important city of Massilia in the south of Gaul. A large part of the emigrants, however, relented, and, after having proceeded only as far as Chios, returned to Phocæa, where they submitted to the Persian yoke. The rest, however, having bound themselves by a solemn oath never to return, proceeded to Corsica, where they settled for a time; but, being afterwards expelled from the island, they founded the colony of Velia or Elea in southern Italy.

Phocæa continued to exist under the Persian government, but greatly reduced in population and commerce, so that, although it joined in the revolt of the Ionians against Persia in 500, it was only able to send three ships to the combined fleet that fought at Lade. Nor did it ever again assume a prominent part among the Ionian cities, and it is rarely mentioned in Greek history. But at a later period it was sufficiently powerful to oppose a vigorous resistance to the Roman prætor Æmilius during the war against Antiochus in 191. On that occasion the town was taken and plundered, but it continued to survive, and we learn from its coins that it was a place of some importance throughout the Roman empire. The ruins still visible on the site bear the name of Palea Foggia, but they are of little interest. A small town in the immediate neighbourhood, known as Nova Foggia, appears to date only from Byzantine times.

<sup>1</sup> It was said to have been founded by a band of emigrants from Phocis, under the guidance of two Athenian leaders, named Philegones and Damon, but it joined the Ionian confederacy by accepting the government of Athenian rulers of the house of Cœdæus.



PHOCAS, emperor of the East from 602 to 610, was a Cappadocian of humble origin, and was still but a centurion when chosen by the army of the Danube to lead it against Constantinople. A revolt within the city soon afterwards resulted in the abdication of the reigning emperor MAURICE (q.v.) and in the speedy elevation of Phocas to the vacant throne (23d November 602). The secret of his popularity is hard to discover, but perhaps it is to be sought in the sheer recklessness of his audacity; courage is nowhere imputed to him, and he is known to have been ignorant, brutal, and deformed. "Without assuming the office of a prince he renounced the profession of a soldier; and the reign of Phocas afflicted Europe with ignominious peace, and Asia with desolating war." By the representations of Theodosius, Maurice's supposed son, and of Narses, the Byzantine commander-in-chief on the Persian frontier, Chosroes (Khosrau) II. was induced to take up arms against the emperor in 604 (see PERSIA, above, p. 614). The failures of the generals of Phocas could not but tend to weaken his always insecure tenure of the imperial crown, and the appearance of the Persian armies as far west as Chalcedon in 609-610 made his deposition by HERACLUS (q.v.) an easy task. He was beheaded by his successful rival on 4th October 610.

PHOCION, an Athenian statesman, whose private virtues won him the surname of "the Good," but whose mistaken policy fatally contributed to the downfall of Athens, was born about 402 B.C. His father, Phocus, was a pestle-maker, but would seem to have been a man of means, for Phocion in his youth was a pupil of Plato. If Plutarch is right in saying that he afterwards studied under Xenocrates, this implies that he kept up his philosophical studies in later life, for Xenocrates was his junior and did not succeed to the headship of the Academy until 339. As men of kindred character, they may well have been friends; we find them on one occasion serving on the same embassy. It was perhaps from the Academic philosophy that Phocion learned that contempt for luxury and that truly Socratic simplicity and hardness which characterized him throughout life. From Plato too he may have caught that scorn for the Athenians of his day which he often betrayed—a scorn harmless, perhaps, in the study, but fatal in the council and the camp. His words, though few, were pithy and forcible, his wit keen and caustic. Many of his trenchant sayings have been preserved by Plutarch. He was the only orator whom Demosthenes feared; when Phocion rose to speak Demosthenes used to whisper to his friends, "Here comes the chopper of my speeches." Gruff in manner, he was kind at heart, ever ready to raise the fallen and succour those in peril, even when they were his enemies. Being once reproached for pleading the cause of a bad man, he replied that the good had no need of help. When other generals were sent by Athens to the allies, the people closed their gates against them and prepared for a siege, but if it was Phocion they went out to meet him and conducted him in joyful procession into their midst. In his youth he saw service under the distinguished general Chabrias, whose temper, by turns sluggish and impetuous, he alternately stimulated and repressed. He thus won the regard of his good-natured commander, and was introduced by him to public notice and employed on important services. When Chabrias defeated the Spartans in the sea-fight off Naxos (September 376) Phocion commanded with distinction the left wing of the Athenian fleet. After the death of Chabrias (357) Phocion cared for the relatives of his patron, patiently endeavouring to train to virtue his wild and wayward son. A consistent advocate of peace, he was yet a good officer, and held the annual office of general no less than forty-five times, though he never sought election.

He was amongst the last of the Athenian leaders who combined the characters of statesman and soldier. In 351 Phocion and Evagoras, lord of the Cyprian Salamis, were sent by Idricus, prince of Caria, with a military and naval force to put down a revolt which had broken out against the Persians in Cyprus. The task was successfully accomplished. Next year<sup>1</sup> Phocion commanded a force which the Athenians sent to Euboea in support of the tyrant Plutarch of Eretria. For a time the Athenians were in a dangerous position, but Phocion extricated himself and defeated the enemy on the heights above Tamynæ. After the battle he humanely dismissed all his Greek prisoners, fearing the vengeance which the Athenians too often wreaked on their fallen foes. In 341 he returned to the island and put down Clitarchus, whom Philip, king of Macedonia, had set up as tyrant of Eretria. Demosthenes had long warned the Athenians against Philip, but there is nothing to show that in this he was backed by Phocion. On the contrary, from the opposition which he so often offered to Demosthenes, as well as from his subsequent policy, we may infer that Phocion discredited rather than corroborated the warnings of his contemporary. But, when Philip laid siege to Byzantium, the Athenians, at last thoroughly aroused to their danger, sent Chares with an expedition to relieve it. He failed to do so, and Phocion took his place (340). The Byzantines had refused to admit Chares into their city, but they welcomed Phocion. Athenians and Byzantines fought side by side, and Philip was compelled to raise the siege and retire from the Hellespont. Phocion afterwards retaliated on the king's territory by raids, in one of which he was wounded. When the Megarians appealed to Athens for help,<sup>2</sup> Phocion promptly marched to their aid, fortified the port Nisææ, and connected it with the capital by two long walls, thus securing Megara and its port against attacks by land.<sup>3</sup> In spite of the successful issue of his expedition to Byzantium Phocion advised the Athenians to make peace with Philip. But the war party led by Demosthenes prevailed, and the battle of Chæroneæ (August 338), in which Philip overthrew the united armies of Athens and Thebes, converted Greece into a province of Macedonia. This brought Phocion and the peace party into power, but Phocion consulted the dignity of Athens so far as to advise the people not to take part in the congress of the Greek states summoned by Philip to meet at Corinth until they knew what terms Philip meant to propose. The Athenians soon had reason to regret that they did not follow this advice. When the

<sup>1</sup> Diodorus (xvi. 46) speaks of Phocion as still in Cyprus in 350. But this can hardly be true if Phocion led the expedition to Euboea in Anthesterion (end of February and beginning of March) 350. See next note.

<sup>2</sup> The dates and even the order of the events from the Cyprian down to the Megarian expedition are variously given by modern writers. The order in the text is that of Plutarch and Diodorus. The dates assigned to the Cyprian, second Euboean, and Megarian expeditions are those of Diodorus. The first expedition to Euboea (as to the date of which see Clinton's *Festis Hellenicis*, vol. II.) and that to Megara are not mentioned by Diodorus. Plutarch mentions the Megarian after the Byzantine expedition. But the siege of Byzantium was not raised till the earlier half of 339, and Phocion afterwards spent some time in Macedonian waters. Thus he could hardly have been at Megara before midsummer 339. But Elatæ was seized by Philip in the winter of 339/338, and its seizure was the occasion of a league between Athens and Thebes. Hence, as the motive assigned for the Megarian expedition was distrust of Thebes, that expedition cannot have taken place after the capture of Elatæ. But the six months between midsummer and winter 339 would hardly suffice for the construction of the Long Walls. Perhaps, then, Plutarch has misplaced the expedition to Megara, and it ought to be dated earlier. Stillwall assigns it to 343.

<sup>3</sup> The Athenians had rendered the same service to the Megarians more than a century before, but these first Long Walls had been destroyed by the Megarians themselves in the Peloponnesian War (424).

news of Philip's assassination reached Athens (336) Phocion vainly dissuaded the people from publicly expressing what he termed a dastardly joy.

After the revolt of Thebes and its destruction by Philip's son and successor Alexander the Great, Athens, having been implicated in the movement, was called on by Alexander to surrender the orators of the anti-Macedonian party, including Demosthenes (335). Phocion advised the men to give themselves up, but nevertheless by his intercession he induced the conqueror to relent.<sup>1</sup> Alexander conceived a high opinion of Phocion, and ever afterwards treated him with marked respect. He would have loaded him with presents, but Phocion steadily declined them, the only favour he asked being the release of some prisoners. When Harpalus, a Macedonian officer who had betrayed the confidence reposed in him by Alexander, fled for refuge to Athens, Phocion, though he contemptuously refused the bribes which Harpalus offered him, nevertheless resisted the proposal to surrender the fugitive (324); and, after the death of Harpalus, Phocion and his son-in-law cared for his infant daughter. The wild joy which the death of Alexander (323) roused at Athens was not shared by Phocion, and he had nothing better than scorn for that heroic effort to shake off the Macedonian yoke known as the Lamian War (323-322). When the news of Leosthenes's victory over Antipater, the regent of Macedonia, was greeted at Athens with enthusiasm (323), Phocion sneeringly asked, "When shall we have done conquering?" Still, when a body of Macedonian and mercenary troops under Micion landed in Attica and ravaged the country, Phocion led out a force and defeated them with loss. After the battle of Crannon (322) Phocion's personal influence induced the victorious Antipater to spare Attica the misery of invasion, but he could not prevent the occupation of Munychia (one of the ports of Athens) by a Macedonian garrison. However, Menyllus, the commander of the garrison, was a friend of Phocion and respected the feelings of the Athenians. Further, the Athenians were required by Antipater to surrender the chief members of the anti-Macedonian party, amongst them Demosthenes and Hyperides, and to restrict their franchise by a property qualification. In consequence Hyperides was executed, Demosthenes died by his own hand, and over 12,000 citizens lost the franchise, many of them going into exile. These disfranchised citizens had afterwards an important influence on Phocion's fate. For some years Athens dwelt in peace, if not in honour, under the shadow of Macedonia. Phocion had the direction of affairs and filled the magistracies with respectable men. By his intercession with Antipater he procured for many of the exiles a repeal or mitigation of their sentence, but he declined to petition Antipater to withdraw the garrison from Munychia. The presents offered him by Antipater and Menyllus he refused. In 318 Antipater died, leaving as his successor in the regency of Macedonia the veteran general Polysperchon, instead of his own son Cassander. The new regent, finding himself isolated and wishing to strengthen himself against his enemies, tried to attach the Greeks to his cause by proclaiming in the name of the young king Philip Arrhidaeus that the oligarchies established by Antipater in the Greek cities should be abolished and the democracies restored, and that all exiles, with a few exceptions, should be allowed to return. A special letter to Athens in the king's name announced the restoration of the democracy. But Cassander was not to be set aside lightly; he was naturally supported by all who

had benefited by his father's measures, i.e., by the oligarchical and Macedonian party in the Greek states. Before the news of the death of Antipater got abroad Cassander sent Nicanor, an adherent of his own, to relieve Menyllus of the command in Munychia. Menyllus unsuspectingly resigned the command to him, and Nicanor held the place for Cassander. When, a few days later, the death of Antipater became known, there were angry murmurs at Athens that Phocion had been a party to the deception. Phocion heeded them not, but, following his usual policy, propitiated Nicanor in favour of Athens. But the people were excited by the promises of Polysperchon; Phocion could no longer hold them in. In a public assembly at which Nicanor was present an attempt was made to seize the obnoxious Macedonian, but he escaped. Warnings now poured in on Phocion to beware of him, but he confided in Nicanor's good intentions and would take no precaution. So Nicanor was enabled to seize and intrench himself in Piræus, the chief port of Athens. The irritation against Phocion was intense. An attempt to treat with Nicanor failed; he simply referred the envoys, of whom Phocion was one, to Cassander. The arrival in Attica of Alexander, son of Polysperchon, revived the hopes of the Athenians. He came at the head of an army and brought in his train a crowd of the exiles, and it was thought that, along with the constitution, he would restore Munychia and Piræus to Athens. Far from doing so, it soon appeared that his intention was to seize and hold these ports for Polysperchon, and rumour said that to this step he was instigated by Phocion. The people were furious. In a public assembly they deposed the existing magistrates, filled their places with the most pronounced democrats, and sentenced all who had held office under the oligarchy to exile or death. Among these was Phocion. With some of his companions in misfortune he fled to Alexander, who received the fugitives courteously and sent them to Polysperchon and the king, who were with an army in Phocia. Thither, too, came an embassy from Athens to accuse Phocion and his fellows before the king and to demand the promised independence. Polysperchon resolved to propitiate the Athenians with blood; so, after an audience disgraceful to all who took part in it except to Phocion, the refugees were packed in carts and sent to Athens to be tried by what Polysperchon called the new free people. A savage mob filled the theatre where the trial was to take place; the returned exiles mustered in force, and with them were women, aliens, and slaves. The prisoners were charged with having betrayed their country in the Lamian War and overturned the democracy. Every attempt Phocion made to defend himself was drowned in a storm of hooting. At last, renouncing the attempt, he was heard to say that for himself he pleaded guilty, but the rest were innocent. "Why," he asked, "will you kill them?" He was answered with a great shout, "Because they are your friends." Then Phocion was silent. All were condemned to die, the multitude rising to their feet like one man to give the verdict. A howling rabble followed them with curses to the prison. Phocion was the last to die (317), for he allowed his best friend Nicocles, as a last token of regard, to die before him. His old disdainful wit did not desert him. When his turn came there was not poison enough left, and he had to pay for more, remarking that at Athens a man could not even die for nothing. His body was cast out of Attic territory, but his faithful wife<sup>2</sup> secretly brought back his bones and interred them by the hearth. Afterwards the

<sup>1</sup> So Plutarch. *Phocion*, c. 17. But Diodorus (xvii. 15) and Plutarch himself elsewhere (*Demosth.*, c. 23) ascribe to Demades the credit of having mollified Alexander. Phocion's name is not mentioned in this connection by Arrian (*Anab.*, i. 10) nor by Justin (xi. 4).

<sup>2</sup> The story that this service was rendered by a Megarian woman rests on a false reading in Plutarch, *Phoc.*, c. 37, Μεγαρεύσῃ before γυναι being the interpolation of an ignorant copyist who mistook the preceding ῥῆσιν Μεγαρεύσῃ.

repentant Athenians buried them with public honours and raised a bronze statue to his memory.

The chief authorities for the life of Phocion are Diodorus (xvi. 42, 46, 74, xviii. 15, xviii. 18, 64-67) and the biographies of Plutarch and Nepos. (J. G. FR.)

PHOCIS was in ancient times the name of a district of central Greece, between Bœotia on the east and the land of the Ozolian Locrians on the west. It adjoined the Gulf of Corinth on the south, while it was separated on the north from the Malian gulf by the ridge of Mount Cnemis and the narrow strip of territory occupied by the Epineomidian and Opuntian Locrians. In early times, indeed, a slip of Phocian territory extended between these two Locrian tribes to the sea, and the port of Daphnus, opposite to the Cœnean promontory in Eubœa, afforded the Phocians an opening in this direction; but in the time of Strabo Daphnus had ceased to exist, and its territory was incorporated with Locris (Strabo, ix. 3, § 1).

Phocis was for the most part a rugged and mountainous country. In the centre of it rose the great mountain mass of Parnassus, one of the most lofty in Greece, attaining to the height of 8068 feet, and an underfall of this, Mount Cirphis (4130 feet), sweeps round to the Gulf of Corinth on the south, separating the Gulf of Crissa from that of Anticyra, both of which were included in the Phocian territory. The range of Mount Cnemis on its northern frontier was of less elevation (about 3000 feet), but rugged and difficult of access, while the upper valley or plain of the Cephissus, which intervened between this and the northern slopes of Mount Parnassus, constituted the only considerable tract of fertile and level country comprised within the limits of Phocis. The little basin adjoining the Crissean gulf, though fertile, was of very limited extent, and the broad valley leading into the interior from thence to Amphissa (now Salona) belonged to the Ozolian Locrians. Besides the Cephissus, the only river in Phocis was the Pleistus, a mere torrent, which rose in Mount Parnassus, and, after flowing past Delphi, descended through a deep ravine to the Crissean gulf.

Phocis possessed great importance in a military point of view, not only from its central position with regard to the other states of northern Greece and its possession of the great sanctuary of Delphi, but from its command of the pass which led from the Malian gulf across Mount Cnemis to Elatea in the valley of the Cephissus, and afforded the only access for an invader who had already passed Thermopylæ into Bœotia and Attica. Hence the alarm of the Athenians in 339 when it was suddenly announced that Philip had occupied Elatea. Again, the only practicable communication from Bœotia with Delphi and the western Locrians lay through a narrow pass known as the Schiste Hodos, between Mount Cirphis and the underfalls of Mount Helicon. From this point another deep valley branches off to the Gulf of Anticyra, and the Triodos or junction of the three ways was the spot celebrated in Greek story as the place where Œdipus met and slew his father.

The most important city in Phocis after Delphi was Elatea, the position of which has already been described; next to this came Abœ, also in the valley of the Cephissus, near the Bœotian frontier, celebrated for its oracle of Apollo. In the same neighbourhood stood Daulis and Ambrysus; while farther south, towards the Corinthian gulf, lay Anticyra, on the gulf of the same name. Crissa, which had been in early times one of the chief cities of Phocis, and had given name to the Crissean gulf, was destroyed by order of the Amphictyonic council in 591, and never rebuilt. The other towns of Phocis were places of no importance, and their names scarcely appear in history.

The whole extent of Phocis did not exceed half that of Bœotia, but it was broken up into a number of small townships—twenty-

two in all—forming a confederacy, the deputies of which used to meet in a "synedrion" or council-chamber near Daulis. But from an early period the predominance of Delphi, owing to the influence of its celebrated oracle, threw all the others into the shade. At first (as has been already stated in the article DELPHI) the Phocians were masters of the oracle, and of the town that had grown up on its site; but after the first Sacred War in 595 B.C., and the destruction of Crissa, Delphi became an independent city, and from this period a strong feeling of hostility subsisted between the Delphians and the Phocians. The latter, however, thus deprived of their chief city, sank into a position of insignificance, and played but an unimportant part in the affairs of Greece. During the Persian War of 480 their territory was ravaged by the invader, and several of their small cities destroyed. In the Peloponnesian War they were zealous allies of the Athenians, and for a short time recovered possession of Delphi, which was, however, soon after wrested from them; and it maintained its independence from the peace of Nicias in 421 till the outbreak of the Sacred War in 357. On this occasion the Phocians, who had been sentenced by the Amphictyons to the payment of a heavy fine, rose in arms against the decree, which they attributed to the hostile influence of the Thebans, and, under the command of Philomelus, made themselves masters of Delphi, and seized on the sacred treasures of the temple. With the assistance of these resources they were able to maintain the contest, under the command of Onomarchus, Phayllus, and Phœleucus, for a period of ten years, not only against the Thebans and their allies but even after the accession of Philip, king of Macedonia, to the side of their adversaries. This was the only occasion on which the Phocians bore a prominent part in Greek history. After their final defeat by Philip a decree was passed by the Amphictyons, in 346, that all the Phocian towns except Abœ should be destroyed, and the inhabitants dispersed in villages. Notwithstanding the ruin thus brought upon their country, many of their towns seem to have been subsequently rebuilt, and the Phocians were able to take part with the Athenians in the final struggle for Greek independence at Cheronea, and in the Samian War. Their last appearance in history was in defence of Delphi against the attack of the Gauls in 279; but they still continued to subsist as a separate though obscure people in the days of Strabo.

Of the origin of the Phocians as a people we have no information. The earliest traditions connect them with the pre-Hellenic Leleges, as was the case also with the Locrians, and this statement was probably intended to convey the fact that the two nations were tribes of the same race. They first appear under the name of Phocians in the Homeric catalogue as having joined the Greek armament against Troy under the command of the two sons of Iphitus (*Iliad*, ii. 517), and were restored amongst the Æolia division of the northern Greeks.

For the ancient geography of Phocis, see Strabo (ix. 3) and Pausanias (x.). The country and the existing remains of antiquity are described by Dodwell (vol. i. chaps. 6 and 7) and Leake (*Northern Greece*, vol. ii.).

PHŒBUS (*φωσφοσ*, the bright or pure), a common epithet of APOLLO (*q.v.*). Artemis in like manner is called Phœbe, and in the Latin poets and their modern followers "Phœbus" and "Phœbe" are often used simply for the sun and the moon respectively.

PHŒNICIA (Gr. *Φοινίκη*) forms part of the seaboard of SYRIA (*q.v.*), extending along the Mediterranean (sometimes called the Phœnician Sea) from the mouth of the Eleutherus in the north to Mount Carmel in the south, a distance of rather more than two degrees of latitude. In early times Phœnicians were settled beyond this district, but for the Persian period Dor may be taken approximately as the limit towards the south. In the north a strip of country on the other side of the Eleutherus (Nahr al-Kebîr) was frequently reckoned to Phœnicia. Formed partly by alluvium carried down by perennial streams from the mountains to the east, and fringed by great sand-dunes thrown up by the sea, Phœnicia is covered by a very fertile vegetable soil. It is only at Eleutherus in the north, and near Acre (Akka) in the south, that this strip of coastland widens out into plains of any extent; a smaller plain is found at Beirut (Beirut). For the most part the mountains approach within not many miles of the coast, or even close to it, leaving only a narrow belt of lowland, which from remote antiquity has been traversed by a caravan-route. To the south of Tyre the cliffs sometimes advance so close to the sea that a passage for the road had to be hewn out of the rocks, as at Scala Tyriorum (Bas an-

Nakura), and farther north at Promontorium Album (Ras al-Abyad). It is not known how far inland the Phœnician territory extended; the limit was probably different at different times. Both the maritime district, partly under artificial irrigation, and the terraces, laid out with great care on the mountain-sides, were in antiquity in a high state of cultivation; and the country—more especially that portion which lies north of the Kāsimiye (Litāni) along the flanks of Lebanon—still presents some of the richest and most beautiful landscapes in the world, in this respect far excelling the Italian Riviera. The lines of the limestone mountains, running for the most part parallel to the sea, are pierced by deep river-valleys; those that debouch to the south of the Kāsimiye have already been mentioned in the article PALESTINE; the most important of those to the north are the Nahr Zaherani, Al-Auwali, Damur (Tamyra), Nahr Beirut, Nahr al-Kalb (Lycus), Nahr Ibrahim (Adonis), Nahr Abu Ali (Kaddisaha). The mountains are not rich in mineral products; but it may be mentioned that the geologist Fraas has recently discovered indubitable traces of amber-digging on the Phœnician coast. The purple-shell (*Murex trunculus* and *brandaris*) is still found in large quantities. The harbours on the Phœnician coast which played so important a part in antiquity are nearly all silted up, and, with the exception of that of Beirut, there is no safe port for the large vessels of modern times. A few bays, open towards the north, break the practically straight coast-line; and there are a certain number of small islands off the shore. It was, in the main, such points as these that the Phœnicians chose for their towns; since, while affording facilities for shipping, they also enabled the Phœnicians to protect themselves from attacks from the mainland, which was subject to them within but narrow limits.

*Race.*—The ethnographic relations of the Phœnicians have been the subject of much debate. As in Gen. x., Sidon, the firstborn of Canaan, is classed with the Hamites, many investigators are still of opinion that, in spite of their purely Semitic language, the Phœnicians were a distinct race from the Hebrews. They attach great weight to the peculiarities that mark the course of Phœnician civilization, and, above all, to their political organization and colonizing habits, which find no analogies among the Semites. In favour of the opposite and more probable view, that the Phœnicians, like the Canaanites, are an early offshoot from the Semitic stock, it may be urged (1) that the account in Gen. x. is not framed on strict ethnographic lines, and (2) that the absence from Phœnicia of all trace of an original non-Semitic form of speech cannot be reconciled with the theory of an exchange of language. The close connexion which existed from an early period between the Phœnicians and the Egyptians accounts for many coincidences in the matter of religion. Phœnician civilization, being on the whole of but little originality, may have been that of a Semitic people, who, from their situation on the narrow strip of country at the east end of the Mediterranean, were naturally addicted to trade and colonization.

*Language.*—Inscriptions, coins, topographical names preserved by classical writers, proper names of persons, and the Punic passages in the *Pomulus* of Plautus combine to show that the Phœnician language, like Hebrew, belonged to the north Semitic group. Even the Phœnician which survived as a rustic dialect in north Africa till the 5th century of our era was very closely akin to Hebrew. Though it retained certain old forms obsolete in Hebrew, Phœnician, as we know, represents on the whole a later stage of grammatical structure than the language of the Old Testament. Its vocabulary, in like manner, apart from a few archaisms, coincides most nearly with later Hebrew. At a very early period Semitic words were

adopted into Greek from Phœnician; and it is also quite certain that the Phœnicians had at least a great share in the development and diffusion of the alphabetic character which forms the foundation of all European alphabets. We possess, however, only a few Phœnician inscriptions and coins of very early date. The longest and most important of the inscriptions—that on King Eshmun'azar's tomb—is in letters which, while very ancient in certain of their features, present a series of important modifications of the original type of the Semitic alphabet, as it can be fixed by comparison of the oldest documents. Still more divergent from the ancient characters are the forms of the letters on the Phœnician, *i.e.*, Punic, monuments of north Africa. (A. SO.)

*Religion.*—Considering the great part which the Phœnicians played in the movements of ancient civilization, it is singular how fragmentary are our sources of knowledge for all the most essential elements of their history. What we are told of their religion is only in appearance an exception to this rule. Eusebius in the *Præparatio Evangelica* cites at length from the Greek of Philo of Byblus a cosmogony and theogony professedly translated from a Berytian Sanchuniathon, who wrote 1221 B.C. But that this work is a forgery appears from the apocryphal authorities cited, and the affinity displayed with the system of Euhemerus. The forger was Philo himself, for the writer borrows largely from Hesiod and was therefore a Greek; he gives Byblus the greatest prominence in a history professedly Berytian, and was therefore a Byblian; and finally Philo was a fanatical Euhemerist, and the admitted object of the work was to make converts to that system. The materials used by Philo were, however, in all probability mainly genuine, but so cut and clipped to fit his system that they must be used with great caution and constantly controlled by the few scattered data that can be gathered from authentic sources.

The two triads of Hannibal's oath to Philip of Macedonia (Polyb., vii. 9, 2)—Sun, Moon, and Earth, and Rivers, Meadows, and Waters—contain the objects on which all Phœnician worship is based. Rivers were generally sacred to gods, trees to goddesses; mountains, too, were revered as nearer than other places to heaven; and berylia or meteoric stones were held sacred as divine messengers.

Philo's second generation of man (Genos and Genes) first worshipped the plants of the earth, till a drought ensued and they stretched out their hands towards the sun as the Lord of Heaven or Beelsamen (Beal-Shamaim),—an indication that the worship of heavenly bodies was regarded as a later development of religion. Baudissin, on the other hand, has lately maintained that all Phœnician deities were astral and only manifested themselves in the terrestrial sphere, that the things holy to them on earth were symbols, not dwelling-places, of the gods. And there seems to be little doubt that this was the theory of later Phœnician theology, as appears in the legend of the fiery star of the queen of heaven that fell into the holy stream at Aphaca (Sozom., ii. 5, 5), in the coincidence of the names of sacred rivers with those of the celestial gods, and in the name Ζεὺς Θαλάσσιος (Hesych.) for a Sidonian sea-god. But surely this theory was devised to remove a contradiction which theologians felt to be involved in the popular religion. In the latter logical consistency is not necessarily to be presumed, and astral and terrestrial worships might well exist side by side. In historical times the astral element had the ascendancy; the central point in religion, and the starting-point in all Phœnician mythology, was the worship of the Sun, who has either the Moon or (as the sun-god is also the heaven-god) the Earth for wife. In Byblus, for which alone we possess some details of the local cult, El was the founder and

lord of the town, and therefore of course had the pre-eminence in religion; and so the Byblian Philo makes ʼĒl to be the highest god and the other ʼĒlim or ʼelohim subordinate to him. In the other towns also the *numen patrium* was a form of the sun-god, or else his wife, and enjoyed somewhat exclusive honour—a step in the direction of monotheism similar to the Moabite worship of Chemosh (cp. the Measha stone). ʼĒl is represented as the first to introduce circumcision and the first who sacrificed an only son or a virgin daughter to the supreme god. He wanders over all the earth, westward towards the setting sun, and leaves Byblus to his spouse Baaltis—this is meant to explain why she had the chief place in the cult of Iyblus; her male companion Eliūn, Shadid (for μέγιστος θεός), is conceived as her youthful lover, and ʼĒl is transformed into a hostile god, who slays Shadid with the sword. According to another legend the youthful god is killed by a boar hile hunting, and the mourning for him with the finding of him again make up a chief part of Byblian worship, which at an early date was enriched with elements borrowed from Egypt and the myth of Osiris. In other places we find as spouse of the highest god the moon-goddess Astarte with the cow's horns, who in Tyre was worshipped under the symbol of a star as queen of heaven. With her worship as with that of Baaltis were associated wild orgies; and traces of the like are not lacking even at Carthage (Aug., *Civ. Dei*, ii. 4), where theology had given a more earnest and gloomy character to the goddess. Astarte was viewed as the mother of the Tyrian sun-god Melkarth (Eudoxus, in Athen., ix. p. 392 D), or, as his full title runs, "our lord Melkarth the Baal of Tyre" (*C.I.S.*, No. 122). On account of his regular daily course the Sun is viewed as the god who works and reveals himself in the world, as son of the god who is above the world, and as protector of civil order. But, again, as the Sun engenders the fruitfulness of the earth, he becomes the object of a sensual nature-worship, one feature of which is that men and women interchange garments. A chief feast to his honour in Tyre was the "awaking of Heracles" in the month Peritius (February/March; Menander of Eph., in Jos., *Ant.*, viii. 5, 3), a festival of the returning power of the sun in spring, probably alluded to in the sarcasm of Elijah (1 Kings xviii. 27). Peculiar to Berytus is the worship of Poseidon and other sea-gods, who are connected genealogically with Zeus Belus, a son of ʼĒl, born beyond the Euphrates, and perhaps therefore connected with the Babylonian fish-gods. Berytus was also a chief seat of the worship of the Cabiri, the seven nameless sons of Sydek, with their brother Eshmūn, who is the eighth and greatest of the Cabiri. Philo supplies for them a genealogy which is an attempt to present the growth of man from rude to higher civilization, and presents analogies, long since observed, to the genealogy of the sons of Cain in Genesis. Not only their half-divine ancestors but the Cabiri themselves belong to a comparatively recent stage of religious development. They are the patron deities of manual arts and civil industry, and as such are the great gods of the Phœnician land, specially worshipped in the federal centre Tripolis. On coins of this town they are called Syrian (i.e., perhaps Assyrian) gods,<sup>1</sup> which seems to imply that the Phœnicians themselves regarded as not primitive the many Egyptian elements which were quite early introduced into the religion of the Cabiri, and especially of Eshmūn. On the other hand, a figure allied to Eshmūn, Taant, the inventor of the alphabet, is certainly borrowed from the Egyptian Tahuti. So, too, Onka (Steph., s.v. "Ὀγκαίης") is probably the Anuke of Saïs, and it is possible that the whole

cycle of gods who revealed and interpreted the sacred books is Egyptian; some of the latter have the form of a serpent.

The Phœnicians did not set up anthropomorphic statues of the gods, but symbolic pillars of stone, or, in the case of the queen of heaven, of wood (ashrah). If an actual image was used, likeness to man was avoided by fantastic details: the god had two heads or wings, or some animal emblem, or was dwarfish or hermaphroditic, and so on. The sacrifices were of oxen and other male domestic animals—as expiatory offerings also stags<sup>2</sup>—and for minor offerings birds. Human sacrifices were exceptionally offered by the state to avert great disasters; the victim was chosen from among the citizens and must be innocent, wherefore children were chosen, and by preference firstborn or only sons. The same idea that the godhead demanded the holiest and most costly gift explains the prostitution of virgins at certain feasts in the sacred groves of the queen of heaven, and the temporary consecration of maidens or matrons as *kedeshoth* (ιερόδουλοι). For this custom, as for that of human sacrifice, substitutes were by and by introduced in many places; thus at Byblus it was held sufficient that the women cut off their hair at the feast of Adonis (*De Dea Syr.*, c. 6).

*Origin of the Phœnicians.*—The oldest towns were held to have been founded by the gods themselves, who presumably also placed the Phœnicians in them. Imitating the Egyptians, the race claimed an antiquity of 30,000 years (Africanus, in Syncellus, p. 31), yet they retained some memory of having migrated from older seats on an Eastern sea. Herodotus (vii. 89) understood this of the Persian Gulf; the companions of Alexander sought to prove by learned etymologies that they had actually found here the old seats of the Phœnicians. But all this rested on a mere blunder, and the true form of the tradition is preserved by Trogus (Just., xviii. 3, 3), who places the oldest seats of the Phœnicians on the Syrium stagnum or Dead Sea—with which the Greeks before the time of the Diadochi had no acquaintance—and says that, driven thence by an earthquake, they reached the coast, and founded Sidon. This earthquake Bunsen has ingeniously identified with that which destroyed Sodom and Gomorrah, and with which Genesis itself connects the migrations of Lot. Perhaps it played much such a part in the mythic history of the peoples of Canaan as the breach of the dam of Mārib does in the history of the Arabs.

In historical times the Phœnicians called themselves Canaanites and their land Canaan (Kēna'an, Kēna'; Xvā in Hecataeus, fr. 254), the latter applying equally to the coast which they themselves held and the inland highlands which the Israelites occupied. The Greeks call people and land Φοίνικες; Φοινίκη; the former is the older word, which in itself disposes of the idea that Phœnicia means the land of the date-palm, which the Greeks called φοίνιξ, i.e., Phœnician.<sup>3</sup> In truth, Φοίνικες, with an antique termination used in forming other names of nations (Αἰθίκες, Θρηίκες), is derived from φοινός, "blood-red," probably in allusion to the dark complexion of the race.

When the southern part of the coast of Canaan was occupied by the Philistines the region of Ekron became the boundary of Phœnicia to the south (Joah. xiii. 3); the northern boundary in the time of the Persians was the town of Posidium and the mouth of the Orontes (Herod., iii. 91; Pseudo-Scylax, § 104). Under the Seleucids these limits contracted, the southern boundary, being the Chorseus (Ptol., *Codd. B. E.*, Pal. 1), which falls into the sea north of the tower of Straton, and the northern the river

<sup>1</sup> For stags offered to Tanit see Clermont-Ganneau, *Journ. As.*, ser. 7, vol. xi. p. 232 sq., 444 sq.

<sup>2</sup> In reality the date-palm is not aboriginal in these regions, *Hehn, Kulturpflanzen*, &c., 3d ed., p. 233.

<sup>1</sup> Eckhel, *D.N.V.*, iii. 374.

Eleutherus, so that Orthosia was the last town of Phœnicia and the whole region of Aradus was excluded.<sup>1</sup> Under the Roman empire the southern boundary was unchanged, but the northern advanced to a little south of Balanea.<sup>2</sup> A still narrower definition of Canaan is that in Gen. x. 19 and Josh. xiii. 2-6, where Sidon or its territory is the northern limit; but the reference is only to the land destined to be occupied by Israel, for a younger hand has added to Sidon (the firstborn of Canaan) and Heth a list of other nations, sons of Canaan, extending northwards as far as Hamath.<sup>3</sup>

It is a singular fact that alike in the Old Testament and in Homer, in the time of Tyre's greatest might, we constantly read of Sidonians and not of Tyrians. The explanation that Sidonians is a synonym of Phœnicians in general is defended on 1 Kings v. 1 [15] compared with ver. 6 [20], but is not adequate; the same chapter distinguishes between the Sidonians and the Giblites or men of Byblus (E. V., "stone squarers," ver. 18 [32]). And in Gen. x. we have besides Sidon the peoples of Arca, Sinna, Aradus, and Simyra enumerated in order from south to north—mostly unimportant towns afterwards absorbed in the land of Aradus—and yet Tyre is lacking, though one fancies that we could better miss even Aradus, which was a colony from Sidon (Strabo, xvi. p. 753), only Aradus was founded by fugitives, and so must, from the first, have been independent. Hence we may conjecture that the list in Genesis is political in principle; and this gives us a solution of the whole difficulty, viz., that, during the flourishing period of Phœnicia, Sidon and Tyre formed a single state whose kings reigned first in Sidon and then in Tyre, but whose inhabitants continued to take their name from the old metropolis. The first unambiguous example of two distinct kings in Tyre and Sidon is in the end of the 8th century B.C., on an inscription of Sennacherib (Schrader, *K.A.T.*, 2d ed., p. 286 sq.), and there is every reason to think that the revolt of Sidon from Tyre about 726 spoken of by Menander (Jos., *Ant.*, ix. 14, 2) was a revolt not from Tyrian hegemony but from the Tyrian kingdom. The several Phœnician cities had lists of their kings back to a very early date. Abedbalus<sup>4</sup> reigned at Berytus in the time which Philo had ciphered out as that of the judge Jerubbaal, i.e., about the beginning of the 13th century B.C., and in Sidon there is word of kings at the time to which the Greeks referred the rape of Europa (15th century; see Lætus, in Tatian, *Adv. Græcos*, 58). The leading Phœnician towns are mentioned in connexion with the Syrian wars of the Pharaohs of the XVIIIth, XIXth, and XXth Dynasties (16th-13th century); thus under Thothmes III. we read of Berytus, Aca, Joppe, and repeatedly of Aradus, which is commonly spoken of along with Haleb (Aleppo) and other eastern districts. The mention of Tyre is less certain, as there were two cities which the Egyptians called Tar; but there is no mistake as to the city on the sea called "Taru the haven" in the journey of an Egyptian of the 14th century (*Rec. of the Past*, ii. 107 sq.).—"water is carried to it in barks, it is richer in fish than in sands"; the noble aqueducts therefore, of which the ruins are still seen, were not yet constructed.

The oldest parts of Tyre were taken to be the town on the mainland, afterwards known as Palæstynus, and the so-called temple of Hercules built on a rocky islet, which Hiram by and by united with the insular part of the town. According to native historians this temple was more properly one of Olympian Zeus, that is, of Beal-Shamsim, the Lord of Heaven.<sup>5</sup> Herodotus, after inquiries made

<sup>1</sup> Strabo, xvi. p. 753; Ptol., v. 16, 4, 5, both seemingly from Artemidorus. The Eleutherus as boundary appears also in Jos., *Ant.*, xv. 4, 1 *et seq.*

<sup>2</sup> Flin., *N. H.*, v. 69, 79; *Itin. Hieros.*, pp. 582, 585 (Wess.).

<sup>3</sup> See Wellhausen in *Jahrb. f. d. Theol.*, 1876, p. 403.

<sup>4</sup> Noldeke's conjecture for *ΑΒΟΒΑΛΟΣ*, in Porphyry, ap. Euseb., *Præp. Ev.*, x. 9.

<sup>5</sup> This appears by comparing Herod., ii. 44, with the mention of the same golden stals by Menander (Jos., *Cont. Ap.*, 4, 18).

on the spot, fixes the founding of the city in 2756 B.C.; but Tyre did not attain great importance till the latter island city was built. According to Trogus (Justin, xviii. 3, 5) the Phœnicians (not the people of Sidon, as the passage is often misread to mean), who had been subdued by the king of Ascalon, took ship and founded Tyre a year before the taking of Troy. This goes well with the spread of the Philistine power in the time of the later judges and with the fact that Ascalon was still a Canaanite town under Rameses II. (c. 1385 B.C.), while in the eighth year of Rameses III. (c. 1246) the Pulosata made a raid into Egypt.<sup>6</sup> Philistus (in Euseb., *Gen.*, No. 803) gives us without knowing it the era used in Tyre and in early times also in Carthage when he says that Zorus (i.e., Çor, Tyre) and Carchedon built Carthage in 1218 B.C., or rather, according to a very good MS. (Regin.), in 1209, which agrees with the date 1203 for the fall of Troy on the Parian marble, and also may be reconciled with the notice (taken from Philistus) in Appian, *Pœnicia*, i., that the founding of Zorus and Carchedon was fifty years before the fall of Troy, if we suppose that Philistus took for the latter event the latest date we know of, viz., that assigned by Democritus.<sup>7</sup> Now Josephus (*Ant.*, viii. 3, 1) counts 229 years from the building of Tyre to Hiram, and places the foundation of Carthage (*Cont. Ap.*, i. 18) in the 155th year from Hiram's accession. The best authority for the last-named event is Timæus, who puts it in 814 B.C. This gives us for the founding of Tyre a date twelve years later than that of Philistus, but it is probable that Josephus in summing up the individual reigns between Hiram and the building of Carthage as given by Menander departed from the intention of his author in assuming that the twelve years of Astartus and the twelve of the contemporaneous usurper were not to be reckoned separately.<sup>8</sup> This hypothesis enables us to give a restored chronology which cannot be far from the truth (see *infra*).

**Manufactures and Inventions.**—The towns of the Phœnician coast were active from a very early date in various manufactures. Glass work, for which the sands of the Belus gave excellent material, had its chief seat in Sidon; embroidery and purple-dyeing were favoured by the prevalence of the purple-giving murex all along the coast. The ancients ascribed to the Phœnicians the invention of all three industries, but glass-making seems to have been borrowed from Egypt, where this manufacture is of immemorial antiquity; and several circumstances indicate that the other two arts probably came from Babylon—in particular, the names of the two main tints of purple—dark red (argamân) and dark blue (têkhêleth)—seem not to be Phœnician. The Phœnicians, however, brought these arts to perfection and spread the knowledge of them. In other particulars also the ancients looked on the Phœnicians as the inventive people *par excellence*: to them as the great trading nation was ascribed the invention of arithmetic, measure, and weight, which are really Babylonian in origin, and also of writing, although it is not even quite certain that it was the Phœnicians who adapted the Egyptian hieroglyphic alphabet to Semitic use.<sup>9</sup> Yet here again the Phœnicians have undisputedly the scarcely inferior merit of having communicated the art to all the nations of the Mediterranean basin.

**Navigation, Trade, Colonies.**—The beginnings of navigation lie beyond all human memory, but it is not hard to understand how the ancients made this also an invention of the Phœnicians, whose skill as seamen was never matched by any ancient people before or after them. Even in later times Greek observers noted with admiration the exact order kept on board Phœnician ships, the skill with which every corner of space was utilized, the careful disposition of the cargo, the vigilance of the steersmen and their mates (Xen., *Æc.*, viii. 11 sq.). They steered by the pole-star, which the Greeks therefore called the Phœnician star (Hyginus, *Po. Ast.*, ii. 2); and all their

<sup>6</sup> See Brugnot, *Geschichte Aegyptens*, pp. 516, 598.

<sup>7</sup> If Democritus was born in 470 (Thrasylus), his date for the fall of Troy is 1160.

<sup>8</sup> He is contemporaneous on the reading *Μεθ'* of *Ἀναγρες* given by Theophilus, *Ad Autol.*, iii. 12. If Josephus took it so, then according to the best authorities he would get exactly 155 years.

<sup>9</sup> That the Semitic alphabet did not come from cuneiform writing may be taken as certain; but also it is not probable that it came from the hieratic character of the Egyptians.



vessels, from the common round γαῦλος, to the great Tarshish ships, the East-Indiamen—so to speak—of the ancient world, had a speed which the Greeks never rivalled. Of the extent of the Phœnicians' trade in the last days of Tyre's glory Ezekiel (xxvii. 12-25) has left a lively picture, which shows how large was the share they had in overland as well as in naval commerce. It was they, in fact, who from the earliest time distributed to the rest of the world the wares of Egypt and Babylon (Herod., i. 1). To the lands of the Euphrates and Tigris there were two routes: the more northerly passed obliquely through Mesopotamia and had on it the trading places of Haran (Carrhæ), Caneh (Cœnæ), and Eden; the other, more southerly, had Sheba (Sabæa) for its goal, and led down the Euphrates, passing Asshur (Sura) and Chilmad (Charmande). There were other routes in the Persian and Macedonian period, out they do not belong to the present history.

Actual inland settlements of the Phœnicians seem to have been few; we know of one near the head of the northern trade road, Laish, which was lost to the Danites in the time of the judges (Judges xviii.), and one on the southern route, Eddana on the Euphrates (Steph. B., s.v.), which corresponds in name with Eden, but is not the same place, but perhaps rather the Giddan of Isidore of Charax (§ 1). In the Arabian caravan trade in perfume, spices, and incense for worship the Phœnicians had a lively interest (Herod., iii. 107). These wares were mainly produced not in Arabia but in eastern Africa and India; but Sheba in Yemen was the emporium of the whole trade, and the active commerce of this rich and powerful state in the times before the Persian is seen better than by any direct testimony from the exact knowledge of the Sabaean lands shown in Gen. x., from the many references to Arabia and Sheba in the Assyrian monuments, and from such facts as Euting's discovery at Taimâ in the heart of Arabia of an Aramaic inscription of the 6th century B.C., composed by a man with an Egyptian name.<sup>1</sup>

In Egypt Phœnician trade and civilization soon took firm root; they alone were able to maintain their Egyptian trade and profits in the anarchic times of the XXIIIrd to the XXVth Dynasties (825-650 B.C.), times like those of the Mameluke bays, in which all other foreign merchants were frightened away and the Greek legend of the inhospitable Busiris originated.<sup>2</sup> The Tyrians had their own quarter in old Memphis (Herod., ii. 112), but there never were real colonies of the Phœnicians in Egypt.

That in matters economic Syria and Palestine depended on Phœnicia might have been inferred even if we had not the express testimony of Ezekiel that these lands were included in the sphere of Tyrian trade; so too was Togarmah, an Armenian district.

Cilicia was important to the Phœnicians as the natural point of shipment for wares from the Euphrates regions; and the opposite island of Cyprus attracted them by its store of timber for shipbuilding, and of copper. Both these countries were originally peopled by the non-Semitic Kittim, who have left their name in the Cilician district Oetis and the Cyprian city Citium; but they came under profound Semitic influences, mainly those of the Phœnicians, who on the mainland had settlements at Myriandus (Xen., *Anab.*, i. 4, 6) and Tarsus,<sup>3</sup> while in Cyprus Citium—which to the last remained the chief seat of the Phœnician tongue and culture—was held to have its foundation from Belus (Steph., s.v. "Λάριθος"), and Carpasia from Pygmalion (*Id.*, s.v.). Pseudo-Scylax (§ 103),

writing in 346 B.C., knows Carpasia, Cerynea, and Lapethus as Phœnician; but the view that Phœnician sway in Cyprus was very ancient and that the Phœnicians were gradually driven back by the Greeks appears not to be sound. On the contrary, the balance of power seems to have varied greatly; the Assyrian tribute-lists of 673 and 667 (Schrader, *K.A.T.*, p. 354 sq.) contain but two names of Phœnician cities in Cyprus, Silla (Soli) and Kartihadast (probably New Paphos); not one of the later Phœnician kingdoms is mentioned, so that presumably none of them then existed, and not one of the ten Cyprian kings mentioned appears to be Phœnician by name. Menander tells us (*Jos.*, *Ant.*, ix. 14, 2) that the kings of Tyre ruled over Cyprus at the close of the 8th century; but a very clear proof that there was no ancient and uninterrupted political connexion with Phœnicia lies in the fact that the Cyprian Greeks took the trouble to frame a Greek cuneiform character modelled on the Assyrian.

The Homeric poems represent the Phœnicians as present in Greek waters for purposes of traffic, including the purchase and capture of slaves, but not as settlers. Tradition (see especially Thucyd., i. 8) is unanimous in representing the Carians and Phœnicians as having occupied the islands of the Ægean before the migrations of the Greeks to Asia Minor, but so far as the Phœnicians are concerned this holds only of the southern islands—afterwards occupied by Dorians—where they had mining-stations, and also establishments for the capture of the murex and purple-dyeing.<sup>4</sup> The most northerly of the Cyclades on which we can prove a Phœnician settlement is Oliarus (Steph., s.v.), which was occupied by Sidonians, probably with a view to the use of the marble quarries of Paros, which lies opposite. Similarly the Byblians occupied Melos (Steph., s.v.), which produced a white pigment (Melian earth), alum, and sulphur. Two great islands were held as main seats of the purple trade, Cythera (Herod., i. 105) and Thera, with the neighbouring Anaphe (Herod., iv. 147; Steph., s.v. "Μεμβλίανος"),—as also the town Itanus at the eastern extremity of Crete (Steph., s.v.). Specially famous was the purple of the Laconian waters,—the isles of Elisahah of Ezekiel xxvii. 7. Farther east the Phœnicians were settled in Rhodes.<sup>5</sup> The Greek local tradition about the Phœnicians seems, in Thera and Rhodes, to embody real historical reminiscences, and it is confirmed for Thera and Melos by the discoveries of Phœnician pottery and ornaments in the upper strata of the tuff, and for other places by peculiar cults which survived among the later Dorian settlers. Thus the Aphrodite Urania of Cythera was identical with the Oriental goddess of love at Paphos, and Herodotus (i. 105) makes her temple to be founded from Ascalon; the coins of Itanus (Mionnet, ii. 284 sq.) show a fish-tailed deity; in Rhodes human sacrifices to Cronus were long kept up (Porph., *De Abs.*, ii. 54). The legends of Rhodes and Crete have a character quite distinct from that of other Greek myths, and so give lasting testimony to the deep influence in both islands of even the most hideous aspects of Phœnician religion; it is enough to refer in this connexion to the stories of the eight children of Helios in Rhodes, of Europa, the Minotaur, and the brazen Talos in Crete. The pre-Hellenic inhabitants of the islands, the Carians and their near kinsmen the Eteocretans or Mnōites (probably identical with the *PHILISTINES*, s.v.), had no native civilization, and were therefore wholly under the influence of the higher culture of the Phœnicians. But on the Greeks too the Phœnicians had no small influ-

<sup>1</sup> Hildaka, in *Sitzb. Berl. Ak.*, 1884, p. 618 sq.

<sup>2</sup> *Χιθρα*, the herald of Busiris, is simply *ΣΩ*, "dog."

<sup>3</sup> Tarsus was founded by Aradians, Dio Char., xxxiii. 40. *AR*, a city of the Phœnicians in Herodotus, fr. 359, is probably not *Agas* but *Gasa*.

<sup>4</sup> As an enormous supply of murex was needed for this industry, the conjecture of Duncker is probably sound, that the purple stations were the oldest of all Phœnician settlements.

<sup>5</sup> Rodanin, 1 Chron. i. 7, by which Dodanin in Gen. x. 4 must be corrected; see *Bergas* (f) and *Polyæmus*, in *Athens*, viii. p. 360 D.

ence, as appears even from the many Phœnician loan-words for stuffs, utensils, writing materials, and similar things connected with trade.<sup>1</sup> From the Phœnicians the Greeks derived their weights and measures; *μνά*, the Hebrew *maneh*, became a familiar Greek word. From Phœnicia too they had the alphabet which unanirous tradition connects with the name of Cadmus, founder of Thebes. Hence Cadmus has been taken to mean "eastern" (from *ἄρκος*), and Thebes viewed as a Phœnician colony; but the Greeks did not speak Phœnician, and the Phœnicians would not call themselves Easterns. Further, an inland colony of Phœnicians is highly improbable; and all other traces seem to connect Cadmus with the north. But the Cadmeans, who traced their descent to Cadmus, colonized Thera, and it was they who, mingling with the Phœnicians left on the island, learned the alphabet. It was in Thera, where the oldest Greek inscriptions have been found, that the invention of letters was ascribed to the mythic ancestor, and that he was made out to be a Phœnician. We now know better than we did a few years ago how much the oldest Greeks depended before the migrations on the movements of Eastern civilization, and can well believe that the Phœnicians played a very important part in this connexion. Thus in the tombs of Mycenæ we find Phœnician idols, objects of amber, and an ostrich egg side by side with rich jewels of gold, Oriental decoration, and images of Eastern plants and animals; thus too the rock-tombs of Hymettus closely resemble those of Phœnicia; and above all we find on the Isthmus of Corinth, that most ancient seat of commerce, the worship of the Tyrian Melkart under the name of Melicertes. Yet with all these proofs of a lively trade there is no trace of Phœnician settlements on the Greek mainland and the central islands of the Ægean; but in the north Thasus was occupied for the sake of its gold mines (Herod., vi. 47), and so probably was Galepsus on the opposite Thracian coast (Harpocr., s.v.), where also it was Phœnicians (Strabo, xiv. p. 680; from Callisthenes) who opened the gold mines of Pangæus. Beyond these points their settlements in this direction do not seem to have extended; the Tyrians, indeed, according to Ezekiel, traded in slaves and bronze-ware with the Greeks of Pontus (Javan), the Tibareni (Tubal), and Moschi (Meshech); but all supposed traces of actual settlements on these coasts prove illusory, and Prolectus on the Gulf of Astacus, which Stephanus attributes to the Phœnicians, lies so isolated that it was perhaps only a station of their fleet in Persian times.

The great centre of Phœnician colonization was the western half of the Mediterranean and the Atlantic coasts to the right and left of the straits. In especial the trade with Tarshish, that is, the region of the Tartessus (Guadalquivir), was what made the commercial greatness of the Phœnicians; for here they had not only profitable fisheries (tunny and murena) but above all rich mines of silver and other metals, to which the navigable rivers Guadiana and Guadalquivir gave easy access. The untutored natives had little idea of the value of the metals; for long there was no competition, and so the profits were enormous; it was said that even the anchors were of silver in ships returning from Spain (Diod., v. 35). Next the Phœnicians ventured farther on the ocean and drew tin from the mines of north-west Spain or the richer deposits of Cornwall; the tin islands (Cassiterides) were reached from Brittany, and are always distinguished from the British mainland, so that the old view which makes them the Scilly Islands is probably right. The tin was supposed to be produced where it was exchanged,—a very common case.<sup>2</sup> Amber too was brought in very early times from the farthest north; amber ornaments are often mentioned by Homer,

and have been found in the oldest tombs of Cumæ and in those by the Lion gate at Mycenæ. The Phœnicians can hardly have fetched the amber themselves from the Baltic or even from the North Sea (where it scarcely can have ever been common); it came to them by two trade routes, one from the Baltic to the Adriatic, the other up the Rhine and down the Rhone. But indeed a deposit of amber has been found in the Lebanon not far from Sidon,<sup>3</sup> and perhaps the Phœnicians worked this and only concealed, after their manner, the origin of the precious ware. Certainly the ancients knew of Syrian amber, and knew also that amber could be dug from the ground.<sup>4</sup> The rich trade with Spain led to the colonization of the west (Diod., *ut supra*). Strabo (l. 48) dates the settlements beyond the Pillars of Hercules soon after the Trojan War, in the time, that is, of Tyre's first expansion. Lixus in Mauritania was older than Gades (Pliny, xix. 63) and Gades a few years older than Utica (Vall., i. 2), which again was founded 1101 a.c. (Pseudo-Arist., *Mir. avoc.*, 134; Bocchus, in *Plin.*, xvi. 216). Most of the African colonies were no doubt younger; we have dates for Aozâ (887-855, Menander) and Carthage (814, Timæus). Here, as generally in like cases, the farthest points were settled first and the need for intermediate stations to secure connexion was felt later. The colonization was carried out on a great scale. Ophelas (Strabo, xvii. 826) may exaggerate when he speaks of 300 cities on the Mauretanian coast beyond the Pillars of Hercules; but the colonists and the Carthaginians after them stamped west Africa with a thoroughly Phœnician character, and their language was dominant, at least in the cities, far beyond the limits of their nationality, just as was the case with Latin and Arabic in later times. It is most likely that so great a mass of colonists was not wholly drawn from the narrow bounds of Phœnicia, but that the inland Canaanites, pushed back by Hebrews and Philistines, furnished many recruits; the supposed testimonies to this fact, however, are late, and certainly apocryphal.

Surveying the great settlements of the Phœnicians from east to west, we find them first in Sicily, occupying, in a way typical of the commencement of all their settlements, projecting headlands and neighbouring islets, from which they traded with the Siculi (Thucyd., vi. 2). Their chief seat seemingly was Macara (Hercules, *Polle*, 29), on the south coast, *Ἰνκίρως* on coins, Hercules Minos of the Greeks. Before the Greeks they retired to the north coast, where they held Motya, Panormus, and Soloeis, supported by their alliances with and influences over the Elymi, and by the neighbourhood of Carthage, which here and elsewhere succeeded to the heritage of Tyre, and gave protection to the Phœnician colonies. The islands between Sicily and Africa—Melite, with its excellent harbour and commanding position on the naval highway, Gulus, and Cosura—were also occupied (Diod., v. 12), and a beginning was made with the colonization of Sardinia (*ib.*, v. 25), when Caralis is said to be a Tyrian foundation (Claudian, *B. Gild.*, 520); but real sovereignty over this island and Corsica was first exercised by the Carthaginians.<sup>5</sup> It is uncertain if Phœnician trade with and influence on the Etruscans is older than the political alliance of the latter with Carthage; there were, at least, no Phœnician colonies in Italy. On the east coast of Spain Bercino (Auson., *Epist.*, xiv. 68) and Old Carthage (Ptol., ii. 6. 64) are settlements apparently older than the Spanish empire of Carthage, but their origin is not therefore necessarily Phœnician, especially as Old Carthage lies inland; they may date from the conflicts of Carthage and the Massiliotes. In Tartessus, on the other hand, or Turdetania, as it was called later, all the important coast towns were Phœnician (Strabo, iii. 161, 166 sq., 169 sq.).—Abdera, Sex (which was regarded as one of the oldest of the Tyrian settlements in Spain), Malaca, Cartota, and most famous of all, Gades, with its most holy shrine of Hercules; it lay on an islet which had not even drinking water, but the position was a commanding one. Still farther off lay Onoba, where the Tyrians are said to have settled before they were in Gades. In Africa the most easterly settlement was Great Leptis, which is the only colony known to Sidonians, driven from their home by

<sup>1</sup> See A. Müller, in *Beitr. z. K. d. indog. Spr.*, i. 278 sq.

<sup>2</sup> See *Lit. Contrib.*, 1871, p. 528.

<sup>3</sup> Franz, *Deut. Mon. im Lib.*, p. 94, and *Aus dem Orient*, ii. 60 sq.

<sup>4</sup> Pliny, *N.H.*, xxxvii. 37, 40, reading with Diefenbach *an Auson.*

<sup>5</sup> The Greeks of the 6th century had a very fantastic idea of the value of these islands (Herod., i. 170, v. 106, 124).

civil troubles (Ballast, *Jug.*, 78), and is therefore presumably one of the oldest. Less certain are the accounts that the sister cities Gê and Sibratha were founded, the former by Phœnicians from Sicily, the latter from Tyre (Sil Ital., iii. 256 sq.). The district Emporia on the Lesser Syrtis was named from its many Phœnician trading towns. Here, on the river Cinype, corn produced three-hundredfold, and a great trade-road led inland to the land of the Garamantes. That the commercial town of Tacape (Kâbis) and the island of Meainx (Jirba), with its purple-dyeing trade, were Phœnician is proved by inscriptions, and Capes, in inland Numidia, was deemed a foundation of the Tyrian Hercules (Oros., v. 15). Among the Phœnician towns in Africa proper Achulla was Melitana (Steph., s. s. "Αχολλα"), Lesser Leptis and Hadrumetum Tyrian (Pliny, v. 76; Solin., 27, 9), as was also Acza (Menander), that is, rather the Ucita of Strabo and Ptolemy (cp. Wilmanns on *C.I.L.*, viii. 68), 54 miles inland from Leptis, but Azia in inland Mauretania. On the north coast Carthage and Utica are Tyrian colonies, and probably also Hippo Zarytus, though Sidon, on a coin, claims it and other Tyrian colonies as her daughters (Movers, *Phœnicier*, ii. 2, p. 184). The unidentified town of Canthele and the island Eudeipne are called Liby-Phœnician (Steph., a. c. v.), and this name in later times denoted the Phœnicians in Africa apart from and in contrast to Carthage. The Semitic populations were thickly sown over all this region, but we cannot generally distinguish Phœnician colonies, Carthaginian foundations, and native settlements that had become Punic. Chalca, on the coast east of Oran, in the country of the Massayli, was Phœnician, but their great domain was the Atlantic coast of Mauretania. Tingis and Zelia, if originally Berber, became thoroughly Phœnician cities (Mela, ii. 6, 9; Strabo, iii. 140); the chief colony here was Lixus (Pa.-Scylax, § 112), a city accounted greater than Carthage. Southward, on the so-called ΚΑΛΟΣ Ἐυρωπῶν, and onwards to the mouth of the Dra river Tyrian colonies lay thick, and here a great trade-route went inland to the country of the Blacks. These colonies were ruined by the invasion of the Pharusii and Nigritæ (Strabo, xvii. 826), who spread destruction just as did the Almoravids when they issued from the same region in the 11th century; the Carthaginians saved the remnant of their kinsmen by sending Hanno to found the new colony of Thymlaterium and plant 30,000 Liby-Phœnicians in the old ports of Karikon Teichos, Gyttæ, Acra, Melitta, and Aramby. The most westerly point reached by the Phœnicians was the Fortunate Island (the largest of the Canaries, probably), which later fancy painted in glowing colours after intercourse with so distant a region had ceased (Diod., v. 20).

The trading connexions of the Phœnicians reached far beyond their most remote colonies, and it must have been their knowledge of Africa which encouraged Pharaoh Necho to send a Phœnician expedition to circumnavigate Africa. This greatest feat of ancient seamanship was actually accomplished in 611-605 B.C., at a time when the mother-country had already lost its independence, and the colonial empire had but a shadow of its former splendour. The power of Tyre rested directly on her colonies, which, unlike the Greek colonies, remained subject to the mother-city; we read of rebellions in Utica and Citium which were put down by arms. The colonies paid tithes of all their revenues and sometimes also of booty taken in war to the Tyrian Hercules, and sent envoys to Tyre for his chief feast. But Tyre was too remote long to exercise as effective a control over her dependencies as was possible to the more favourably placed Carthage; the relation gradually became looser, and the more substantial obligations of the colonies ceased to be discharged; yet Carthage certainly paid tithes to the Tyrian Hercules as late as the middle of the 6th century B.C.

*Fragments of History.*—Josephus (*Ant.*, viii. 5, 3, and *Ap.*, i. 17, 18) has fortunately preserved extracts of two Hellenistic historians, Dins and Menander of Ephesus, which supply at least the skeleton of the history of the golden age of Tyre. From them we learn that Hiram (or rather Hîrôm) I., son of Abibal, reigned from 981 to 946 B.C. He enlarged the insular town to the east by filling up the so-called ἐπιπέδον, united the temple of Beal-Shamaim with the main island by a mole, placed in it a golden pillar, and splendidly renewed the temples of Hercules and Astarte. The inhabitants of Utica—so the text must be corrected

(*Trusaitis*)—having ceased to pay tribute, Hiram reduced them in a victorious expedition, after which he founded the feast of the awaking of Hercules in the month Peritina. The Tyrian annals also mentioned the connexion of Hiram with Solomon king of Jerusalem. The relations of Phœnicians and Israelites had been generally friendly before this; it appears from Judges v. 17, Gen. xlix. 13, 20, that Asher, Zebulon, and Dan acknowledged some dependence on Sidon, and had in return a share in its commerce; and the only passage in the older period of the judges which represents Israelites as subject to Sidonians, and again casting off the yoke, is Judges x. 12, which perhaps refers to the time of power of the Canaanites of Hazor (Graetz, i. 413). The two nations drew close together under the kings. Hiram built David's palace (2 Sam. v. 11), and also gave Solomon cedar and fir-trees, as well as workmen for his palace and temple, receiving in exchange large annual payments of oil and wine, and finally the cession of a Galilean district (Cabul), in return for the gold he had supplied to decorate the interior of the temple. The temple was quite in Phœnician style, as appears particularly in the two pillars Jachin and Boaz. We may also judge that it was Hiram's temples that led Solomon to propose to himself a similar work.<sup>2</sup> One commercial result of the alliance with Solomon was the united expedition from Eziongeber on the Gulf of Akaba to Ophir (Malabar).<sup>3</sup> The oldest known Phœnician inscription (*C.I.S.*, No. 5) is of a servant of "Hiram king of the Sidonians," a title which, as we have seen, is quite suitable for the king of Tyre. Hiram's grandson Abdastarte I. (929-920) was murdered by his foster-brothers, and the eldest took the regal title (920-908), but in the last twelve years of his reign he shared his throne with a scion of the old house, [Abd]Astarte II. (908-896). His brother Astharym or Abdastharym (896-887) was murdered by a third brother Phelles, who, in turn, after a reign of but eight months, was slain by Ithobal I., priest of Astarte, whose reign (887-855) marks a return to more settled rule. Ithobal was beloved of the gods, and his intercession put an end to a year of drought which Josephus recognized as that which is familiar to us in the history of Elijah and Ahab. In 1 Kings xvi. 31 Ithobal appears as Ethbaal, king of the Sidonians. At this time the Tyrians still continued to expand mightily. Botrys in Phœnicia and Acza in Africa are foundations of Ithobal; the more famous Carthage owed its foundation to the civil discords that followed on the death of King Metten I. (849-820). According to the legend current in later Carthage (Justin, xviii. 4, 3-6, 9), Metten's son Phygmalion (820-773), who began to reign at the age of nine, slew, when he grew up, his uncle Sicharbas, the priest of Hercules and second man in the kingdom, in order to seize his treasures. The wife of Sicharbas was Elissa, Phygmalion's sister, and she fled and founded Carthage. Truth and fable in this legend are not easy to disentangle, but as Elissa is named also in the Tyrian annals she is probably historical.

From the time of Ithobal downwards the further progress of Phœnicia was threatened by a foreign power. The older campaigns of the empires of the Euphrates and Tigris against the Mediterranean coast had left no abiding results—neither that of the Chaldeans in 1535 or 1538 (Eus., *Can.*, No. 481), nor that of Tiglath Pileser I., c. 1120 B.C.<sup>4</sup>

<sup>2</sup> The date 11 or 12 Hiram which Josephus gives for the building of the temple (*Ant.*, viii. 3, 1; *Ap.*, i. 18) must in the Tyrian annals have referred to the cutting of wood in Lebanon for the native temples, which Josephus then misinterpreted by 1 Kings v. 6(20) sq.

<sup>3</sup> So Caldwell, *Comp. Gram. of Dravidian Languages*, p. 66; Burnell, *Indian Antiquary*, 1872, p. 280. The decisive argument is that the Hebrew word for "peacocks" can only be the Tamil *ibeti* [see, however, OPHIR].

<sup>4</sup> He had the control of the ships of the Aradians; Ménant, *Ann. des rois d'Assyrie*, p. 50.

<sup>1</sup> This is the Agnorium at the northern extremity of the island (Arr., ii. 24). Except in this point the topography of Benan (*Mis. de Phœn.*, p. 546 sq., and Pl. ix.) is here followed.

More serious was the new advance of the Assyrians under Ashurnācipal (c. 870), when this prince took tribute from the lords of Tyre, Sidon, Byblus, Mahallat, Maiz, Kais, the Westland, and the island Aradus. A king of Aradus was one of the allies of Rammanidri of Damascus whom Shalmaneser III. smote at Karkar in 854; thereafter the Assyrian took tribute of Tyre in 842 and 839, and in the latter year also from Byblus. Again in 803 Rammaniraru boasted of exacting tribute from Tyre and Sidon, but thereafter there was a respite until Tiglath Pileser II., the real founder of the Assyrian empire, to whom Tyre paid tribute in 741, and again along with Byblus in 738. In Tiglath Pileser's Philistine campaign of 734 Byblus and Aradus paid tribute, but a heavy contribution had to be exacted from Metten of Tyre by an Assyrian captain. For the history of Elulus, who reigned in Tyre under the name of Pylas<sup>1</sup> (c. 728-692), we have a fragment of Menander. He subdued a revolt of the Citæi in Cyprus, but thereafter was attacked by Shalmaneser IV.,<sup>2</sup> to whom Sidon, Ace, Palæstynus, and many other cities submitted, revolting from Tyre. A new kingdom was thus formed under a king [E]luli, whose name makes it likely that he was a relative of the Tyrian prince, and who presently appears on the monuments as lord of Great Sidon (the same name as in Josh. xix. 28), Lesser Sidon (= Palæstynus), and other cities. But insular Tyre did not yield, and Shalmaneser had to make a second expedition against it, for which the jealous particularism of the other Phœnician cities supplied the ships. With much inferior forces the Tyrians gained a naval victory and the king drew off. But the blockade was continued, and seems to have ended after five years in a capitulation. This siege probably began about the same time with that of Samaria, and may be dated 724-720. About 715 Ionian sea-rovers attacked Tyre and were repulsed by Sargon (Schrader, *K.A.T.*, p. 169), an affair in which we may find the historical basis of such legends as that in the *Cyclic Cypris*, that Sidon was taken by Priam's son Alexander. [E]luli did not prove a faithful subject; Sennacherib attacked him, and he had to flee to Cyprus, Ithobal being set in his place (701). Among the Phœnician kings who appeared to do homage to Sennacherib a prince of Tyre does not appear. One sees from all this how barbarous and ill-consolidated the Assyrian power in the west was; after the retreat of Sennacherib it was even for a time seriously threatened by the Ethiopian dynasty which then held Egypt; and this may explain the revolt of Abdimilkut, king of Sidon, which was visited by Esarhaddon with the destruction of the city, the captivity of part of the inhabitants, and the execution of the rebel king (680 B.C., Ménant, p. 241 *sq.*). Further unsuccessful revolts of Tyre (Beal I. being king, 662 or later) and of Aradus are recorded in the reign of Ashurbanipal; but at last the war of this monarch with his brother seems to have enabled Phœnicia to throw off the yoke without a contest (c. 660).

The Assyrians had proved their inability to create anything; but their talent for destruction was brilliantly exhibited in Phœnicia, and the downfall of Tyre was occasioned, if not caused, by their intervention in the west. For what Justin (xviii. 3, 6 *sq.*) relates of the Tyrians, that they were so reduced in number by protracted war with the Persians that, though they were at last victorious, their slaves were able to overpower and slay them to a man, all save Straton, whom a faithful servant saved, and whom the slaves chose, on account of his wisdom, to be king and founder of a new dynasty (Abdastarte III.), is only to be understood by reading Assyrians for Per-

sians.<sup>3</sup> The catastrophe must have occurred soon after the events already noticed; and in the same period falls the decay of the colonial power of Tyre, which we cannot follow in detail, though we can recognize some of its symptoms. After reaching the Mediterranean the Assyrians established themselves in Cyprus (709); in the Greek islands farther west the Phœnicians had before this time been gradually displaced by the Dorian migration, which, however, must not be taken to be a single movement eastward in the 11th century, but a long course of colonizing expeditions, starting from Argos and continued for generations, about which we can only say that the whole was over by the middle of the 8th century. Thasus, the most northern settlement in the Ægean, was already deserted by the Phœnicians when the father of the poet Archilochus led a Parian colony thither in 708. But the loss of the more western colonies seems to have been contemporary with the fall of Tyrian independence. About 701 Isaiah looks for a revolt of Tartessus (xxiii. 10), and the first Greek visitor, the Samian Colæus (639), found no trace of Phœnician competition remaining there (Herod., iv. 152). These circumstances seem to justify us in understanding what the contemporary poet Anacreon (fr. 8) says of the hundred and fifty years' reign of Arganthonius over Tartessus as really applying to the duration of the kingdom; and as he died in 645 the kingdom will date from 695. In Sicily the Phœnicians began to be pushed back from the time of the founding of Gela (690); and Himera (648) and Selinus (628) mark the limits of Greek advance towards the region on the north-west coast, which the Phœnicians continued to hold. In 654 the Carthaginians occupied the island Ebusus, on the sea-way to Spain (Diod., v. 16), a step obviously directed to save what could still be saved. Soon after this, when Psammetichus opened Egypt to foreigners (650), the Greeks, whose mental superiority made them vastly more dangerous rivals than the Assyrians, supplanted the Phœnicians in their lucrative Egyptian trade; it is noteworthy that Egypt is passed over in silence in Esakiel's full list of the trading connexions of Tyre.

In the last crisis of the dying power of Assyria the Egyptians for a short time laid their hand on Phœnicia, but after the battle of Carchemish (605) the Chaldeans took their place. Apries made an attempt to displace the Chaldeans, took Sidon by storm, gained over the other cities, and defeated the king of Tyre, who commanded the Phœnician and Cyprian fleet (Herod., ii. 161; Diod., i. 68). The party hostile to Chaldæa now took the rule all through Phœnicia. The new king of Tyre, Ithobal II., was on the same side (589), and after the fall of Jerusalem Nebuchadnezzar laid siege to the great merchant-city, which was still rich and strong enough to hold out for thirteen years (587-574).<sup>4</sup> Esakiel says that Nebuchadnezzar and his host had no reward for their heavy service against Tyre, and the presumption is that the city capitulated on favourable terms, for Ithobal's reign ends with the close of the siege, and the royal family is subsequently found in Babylon, obviously as cards that might on occasion be played against the actual princes of Tyre.<sup>5</sup> The king appointed by Nebuchadnezzar was Beal II. (574-564), on whose death a republic was formed under a single suffet. This form of government lasted a year, and then after three months' interregnum under the high priest Abbar there were for six years

<sup>3</sup> There was no Straton, king of Tyre, between 587 and 490; a war between Tyrians and Persians between 490 and 390 is nowhere heard of, and is highly improbable, and Straton, from what we learn of his descendants, cannot have reigned later than 514.

<sup>4</sup> See the Tyrian sources in Jos., *Ap.*, i. 21, compared with Esak. xxvi. 1 *sq.*, xxix. 17 *sq.*

<sup>5</sup> See Winer's "Pflanzprogramm": *De Nephuc. exp. Tyr. an B.* xxvi.-xxviii. (Leipzig, 1846).

<sup>1</sup> So Codd. Samb. Big. The name may be Pii-eeser.

<sup>2</sup> The best MSS.—Paris, 1421, and Oxon.—offer (according to a private communication of Professor Nieboer) traces pointing to the reading *ἐπὶ τοῦτον Σελάμης*.

two suffets—presumably one for the inland and one for Old Tyre—after which an elected king, Balatorus, ruled for a year (557-556). The next two kings (556-532) were brought from Babylon. Under the second of these, Hiram III, Phœnicia passed in 538 from the Chaldeans to the Persians; at the same time Amasis of Egypt occupied Cyprus (Herod., ii. 182). There seems to have been no struggle, the great sieges and the subsequent civil disorders had exhausted Tyre completely, and the city now becomes second to Sidon. Accordingly about this time Carthage asserted her independence; the political activity of Hanno the Great, the real founder of the Carthaginian state, falls in the years 538-521.<sup>1</sup> Of Hanno it is said that he made his townsmen Africans instead of Tyrians (Dio Chrys., *Or.*, xxv. 7). The old dependence was changed for a mere relation of piety.

**Constitution.**—As Carthage was of old a republic, and its constitution underwent many changes, it is not safe to infer from the two Carthaginian suffets that Tyre also stood in the oldest time under two such magistrates. All Canaanite analogy speaks for kingship in the several cities as the oldest form of Phœnician government. The royal houses claimed descent from the gods, and the king could not be chosen outside their members (Curt., iv. 1, 17). The land belonged to the king, who was surrounded by much splendour (Ezek. xxviii. 13), but the highly-developed independent activity of the citizens limited his actual power more than in ordinary Oriental realms; it was possible for war or peace to be decided at Tyre in the king's absence, and in Sidon against his will (Arrian, ii. 15, 16; Curt., iv. 1, 16). In Tyre the high priest of Hercules was the second man in the state (Just., xviii. 4, 5), and so the office was by preference given to a kinsman of the king. The sovereign had a council of elders, who in Sidon were in number a hundred; of these the most distinguished were the ten First whom we find at Marathus and Carthage (Diod., ii. 628; Just., xviii. 6, 1),—originally, it may be supposed, heads of the most noble houses. The third estate was the people; the freemen, however, were much outnumbered by the slaves, as we have seen in Tyre. Under the Persians there was a federal bond between the cities, which we may suppose to be due to that great organizer Darius I. The federation comprised Sidon, Tyre, and Aradus—Sidon being chief—and contributed 300 triremes to the Persian fleet (Herod., vii. 96-99); the contingents of the lesser towns were under the command of the great cities, which probably had the rule in other matters also. This holds for Marathus, Sigon, Mariamme, which belonged to Aradus (Arr., ii. 13), even for Byblus; also, which had its own kings in the Persian period, and seems from the number of its coins and inscriptions to have been very flourishing. We know the names of sixteen kings of Sidon, ten of Byblus, eight of Aradus, but none of Berytus in historical times; presumably it formed with Byblus a single kingdom, and in later times the capital was moved to the latter. Tripolis was a bond of three cities, Sidonian, Tyrian, and Aradian, a stadium distant from one another (Diod., xvi. 41). Here sat the federal council under the kings of the three leading states, who were accompanied to Tripolis by their senators (probably 300 in all). Among the chief concerns of this council were the relations to the Persian Government, which was represented at the meetings.

**Under Persian Rule.**—Phœnicia, Palestine, and Syria formed the fifth satrapy, paying a tribute of £99,296. The Phœnicians were favoured subjects for the sake of

<sup>1</sup> This date is got from Justin, who in xix. 1, 1 says of his Mago the same thing that others say of Hanno; for the defeat spoken of in xviii. 7, 1 is the battle against the Phœnicians in 538, and the war with a Spartan prince in Sicily (xix. 1, 7) is the war with Dorieus (510). Taking into account the eleven years of Hasdrubal's dictatorship we get Hanno's date as above.

their indispensable fleet; and having also common interests against Greece they were amongst the most loyal subjects of the empire. Sidon, as we have seen, was now the chief city; its king at the time of the expedition of Xerxes was Tetramnestus. Among his descendants was the youthful Eahmun'azar, whose inscription on the great sarcophagus in Egyptian style now in the Louvre, taken with other notices, enables us to make out the following fragment of a genealogical table with much probability.<sup>2</sup>

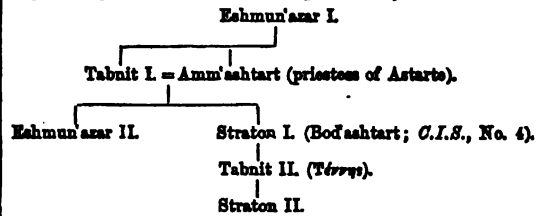

Reckoning back from Straton II., and remembering that Eahmun'azar II. died as a minor under the regency of his mother, we may place the death of the latter c. 400 B.C.; the gift of Dor and Japho, which he received from the great king, may have been a reward for fidelity in the rebellion of the younger Cyrus. Certainly it was not Eahmun'azar who led the eighty ships that joined Conon in 396 (Diod., xiv. 79), an event which may have been the beginning of the friendly relations between Sidon and Athens, indicated in a decree of "proxenia" for Straton I. (*C. I. Gr.*, No. 87). Tyre was then quite weak; between 391 and 386 it was stormed by Evagoras of Salamis (*Isocr.*, *Paneg.*, 161, and *Evag.*, 23, 62; Diod., xv. 2), who had already made the Greek element dominant over the Phœnician in Cyprus. Straton was friendly with Evagoras's son Nicocles; they rivalled one another in debauchery, and both found an unhappy end through their implication in the great revolt of the satraps (Ath., xii. 531). When Tachos entered Phœnicia Straton joined him, and on his failure (361) was about to fall into the hands of the foe when his wife slew him first and then herself (Jerome, ii. 1, 311 Vall.). A new revolt of Sidon against Persia took place under Tennes II. on account of insults offered to the Sidonians at the federal diet at Tripolis. Again they joined the Egyptian Nectanebus II., carried the rest of Phœnicia with them, and with the aid of Greek mercenaries from Egypt drove the satraps of Syria and Cilicia out of Phœnicia. Tennes, however, whose interests were not identical with those of the citizens at large, betrayed his people and opened the city to Artaxerxes III. The Sidonians, to the number of 40,000, are said to have burned themselves and their families within their houses (345 B.C., Diod., xvi. 41-45). Tennes himself was executed after he had served the ends of the great king. The *Periplus* ascribed to Scylax (§ 104) describes the respective possessions of Tyre and Sidon in the year before this catastrophe; Sidon had the coast from Leontopolis to Ornithopolis, an Aradus near the later Sycaminon, and Dor; Tyre had Sarepta and Eropo (†) in the district of the later Calamon, farther south a town seemingly called Cirtha, and, strangely enough, the important Ascalon. Tyre now again for a short time took the first place. When, however, Alexander entered Phœnicia after Issus and the kings were absent with the fleet, Aradus, Byblus, and Sidon joined him, the last-named showing special zeal against Persia. The Tyrians also offered submission, but refused to allow Alexander to enter the city and sacrifice in the temple of Hercules. Alexander was determined to make an example of the first sign of opposition that did not proceed from Persian officials, and

<sup>2</sup> See for details Guttschmid, in *Jahrb. f. Phil. u. Pädag.*, 1857, p. 613 sq.

at once began the siege. It lasted seven months, and, though the king, with enormous toil, drove a mole from the mainland to the island, he made little progress till the Persians were mad enough to dismiss the fleet and give him command of the sea through his Cyprian and Phœnician allies. The town was at length forced in July 332; 8000 Tyrians were slain, 30,000 inhabitants sold as slaves, and only a few notables, the king Azemileus, and the Carthaginian festal envoys, who had all taken shelter in the fane of Hercules, were spared (Arr., ii. 13, 15 sq.). Tyre thus lost its political existence, and the foundation of Alexandria presently changed the lines of trade and gave a blow perhaps still more fatal to the Phœnician cities. The Phœnicians thenceforth ceased to be a great nation, though under the Greeks Tyre and Sidon were still wealthy towns, the seats of rich merchants.

*Sources and Helps.*—The only at all continuous records of ancient tradition are the account of Phœnician mythology by Philo of Byblus, the extracts of the Tyrian annals by Josephus from Menander of Ephesus, and what Justin in the 18th book of his abridgment of Pompeius Trogus has taken from Timæus. Everything else has to be pieced together in mosaic fashion. The chief help is Movers's unfinished work, *Die Phœnizier*, I., ii. 1-3 (Bonn, 1841-56), which must be compared with his article "Phœnizien," in Ersch and Gruber (1848). Both works are learned and indispensable, but to be used with caution wherever the author's judgment on his material is involved, especially in the treatment of the mythology, which is merely syncretistic, whereas it is essential to a right understanding of this subject to distinguish the peculiarities of the several Semitic nations. Selden, *De diis Syris* (London, 1617), is still a valuable mine. The best recent contributions are those of Baudissin, *Studien zur semitischen Religionsgeschichte* (Leipzig, 1876, 1878). For the colonial history Bochart's monumental *Chanaan* (Casn, 1646) is not superseded even by Movers, who, as has been wittily observed, has created with the help of etymology Phœnician *chambres de réunion*; and, though Oleshausen (*N. Rhein. Mus.*, 1858, p. 321 sq.) does not go quite so far, both he and Mullenhoff (*Deutsche Alterthumskunde*, I., 1870) follow the steps of Movers much too closely. A good corrective is given by Meltzer (*Gesch. d. Karthager*, I., 1879), though he, again, is sometimes too sceptical. Movers is best on the history proper; and the admirable sketch in Grote's *History of Greece* should also be consulted. See also Duncker, *Gesch. des Alterthums*, and Maspero, *Hist. anc. de l'Orient* (A. v. G.)

*Art.*—Of Phœnician buildings few remains now exist on Phœnician soil; the coast has always been, and still is, densely peopled, and the builders of successive generations, like those of the present day, have regarded ancient edifices as their most convenient quarries. Phœnician architecture had its beginning in the widening and adaptation of caves in the rocks; the independent buildings of later times, constructed of great blocks of unhewn stone, are direct imitations of such cave-dwellings. As Syrian limestone (which is the material employed) does not admit of the chiselling of finer details, the Phœnician monuments are somewhat rough and irregular. Not a vestige remains of the principal sanctuary of this ancient people, the temple of Melkart in Tyre; but Renan discovered a few traces of the temple of Adonis near Byblus, and a peculiar mausoleum, Burj al-Bezzak, still remains near Amrit (Marathus). It may also be conjectured that the conduits of Ras al-Ain, south of Tyre, are of ancient date. Various notices that have come down to us render it probable that the Phœnician temples, in the erection of which great magnificence was undoubtedly displayed, were in many respects similar to the temple at Jerusalem; and confirmatory evidence is afforded by the remarkable remains of a sanctuary near Amrit, in which there is a cella in the midst of a large court hewn out of the rock, and other buildings more of an Egyptian style. In the domain of art originality was as little a characteristic of the Phœnicians as of the Hebrews; they followed foreign and especially Egyptian models. This influence is mainly evident in sculptured remains, in which Egyptian *motifs* such as the Ureus frieze and the winged sun-disk not unfrequently

occur. It was in the time of the Persian monarchy that Phœnician art reached its highest development; and to this period belong the oldest remains, numismatic as well as other, that have come down to us. The whole artistic movement may be divided into two great periods: in the first (from the earliest times to the 4th century a.c.) Egyptian influence is predominant, but the national Phœnician element is strongly marked; while in the second Greek influence has obtained the mastery, and the Phœnician element, though always making itself felt, is much less obtrusive. In the one period works of art, as statues of the gods and even sculptured sarcophagi, were sometimes imported direct from Egypt (such statues of the gods have been found even in the western colonies); in the other Greek works were procured mainly from Rhodes. The Phœnicians also adopted from the Egyptians the custom of depositing their dead in sarcophagi. The oldest examples of these anthropoid stone coffins are made after the pattern of Egyptian mummy-cases; they were painted in divers colours, and at first were cut in low relief; afterwards, however, and during the Greek period, the contours of the body began to be shown in stronger relief on the cover. Modern excavations show that, besides stone coffins (in marble or basalt), which indeed cannot be considered the oldest kind of receptacle, the Phœnicians employed coffins of wood, clay, and lead, to which were often attached metal plates or, at times it may be, decorations in carved wood. Embalming also seems to have been frequently practised as well as covering the body with stucco. Great care was bestowed by the Phœnicians on their burial-places, and their cemeteries are the most important monuments left to us. The tombs are subterranean chambers of the most varied form: the walls and roof are not always straight; sometimes there are two tiers of tombs one above the other, often several rows one behind the other. While in early times a mere perpendicular shaft led to the mouth of these excavations, at a later date regular stairs were constructed. The dead were deposited either on the floor of the chamber (often in a sarcophagus) or, according to the later custom, in niches. The mouths of the tombs were walled up and covered with slabs, and occasionally cippi were set up. The great sepulchral monuments (popularly called *maghâzil*, "spindles") which have been found above the tombs near Amrit are very peculiar: some are adorned with lions at the base and at the top with pyramidal finials. Besides busts (which belong generally to the Greek period), the smaller objects usually discovered are numerous earthen pitchers and lamps, glass wares, such as tear-bottles, tesserae, and gems. Unrifed tombs are seldom met with.



*Literature.*—For topography and art, see Renan, *Mission à Phœnicie* (Paris, 1846); for language, Schröder, *Die phœnicische Sprache* (Halle, 1859); and Stade in *Morgenländische Forschungen* (1876, p. 167); and for inscriptions, Corp. Inscr. Ser. (Paris, 1881, and following years). (A. 80.)

**PHŒNIX.** Herodotus (ii. 73), speaking of the animals in Egypt, mentions a sacred bird called "phœnix," which he had only seen in a picture, but which the Heliopolitans said visited them once in five hundred years on the death of its father. The story was that the phœnix came from Arabia, bearing its father embalmed in a ball of myrrh, and buried him in the temple of the sun. Herodotus did not believe this story, but he tells us that the picture represented a bird with golden and red plumage, and closely resembling an eagle in size and shape. The story of the phœnix is repeated with variations by later writers, and was a favourite one with the Romans. There is only one phœnix at a time, says Pliny (*N. H.*, x. 2), who, at the close of his long life, builds himself a nest with twigs of cassia and frankincense, on which he dies; from his corpse is generated a worm which grows into the young



phœnix. The young bird lays his father on the altar in the city of the sun, or burns him there, as Tacitus has it (*Ann.*, vi. 28). The story of the birth and death of the phœnix has several other forms. According to Horapollon (ii. 57) he casts himself on the ground and receives a wound, from the ichor of which the new phœnix springs; but the most familiar form of the legend is that in the *Physiologus*, where the phœnix is described as an Indian bird which subsists on air for 500 years, after which, lading his wings with spices, he flies to Heliopolis, enters the temple there, and is burned to ashes on the altar. Next day the young phœnix is already feathered; on the third day his pinions are full-grown, he salutes the priest and flies away. The period at which the phœnix reappears is very variously stated, some authors giving as much as 1461 or even 7006 years, but 500 years is the period usually named; and Tacitus tells us that the bird was said to have appeared first under Sesostria, then under Amasis, again under Ptolemy III., and once more in 34 A.D., after an interval so short that the genuineness of the last phœnix was suspected. The phœnix that was shown at Rome in the year of the secular games, A.U.C. 800, was universally admitted to be an imposture.<sup>1</sup>

The form and variations of these stories characterize them as popular tales rather than official theology; but they evidently must have had points of attachment in the mystic religion of Egypt, and indeed both Horapollon and Tacitus speak of the phœnix as a symbol of the sun. Now we know from the *Book of the Dead* and other Egyptian texts that a bird called the "bennu" was one of the sacred symbols of the worship of Heliopolis, and Wiedemann (*Ztsch. f. Aeg. Sprache*, xvi. p. 89 sq.) has made it tolerably clear that the bennu was a symbol of the rising sun, whence it is represented as "self-generating" and called "the soul of Ra (the sun)," "the heart of the renewed Sun." All the mystic symbolism of the morning sun, especially in connexion with the doctrine of the future life, could thus be transferred to the bennu, and the language of the hymns in which the Egyptians praised the luminary of dawn as he drew near from Arabia, delighting the gods with his fragrance and rising from the sinking flames of the morning glow, was enough to suggest most of the traits materialized in the classical pictures of the Phœnix. That the bennu is the prototype of the phœnix is further confirmed by the fact that the former word in Egyptian means also "palm-tree," just as the latter does in Greek. How far the Egyptian priests translated the symbolism of the bennu into a legend it would be vain to conjecture; that the common people did so is only what we should expect; and it is to be observed that the monuments have not yet shown any trace of the element in the classical legend which makes the phœnix a prodigy instead of a symbol—its actual appearance at long intervals. The very various periods named make it probable that the periodical return of the phœnix belongs only to vulgar legend, materializing what the priests knew to be symbolic. The hieroglyphic figure of the bennu is that of a heron

( *bennu*, or  *bââ*), and the gorgeous colours and plumed head spoken of by Pliny and others would be least inappropriate to the purple heron (*Ardea purpurea*),

with which, or with the allied *Ardea cinerea*, it has been identified by Lepsius and Peters (*Achtete Texte des Todtenbuchs*, 1867, p. 51). But it must be remembered that the bennu in the Egyptian texts is really a mere symbol, having the very vaguest connexion with any real bird, and the golden and purple hues described by Herodotus may be the colours of sunrise rather than the actual hues of the purple heron. How Herodotus came to think that the bird was like an eagle is quite unexplained; perhaps this is merely a slip of memory.

Many commentators still understand the word *phœnix*, in Job xxix: 18 (A.V. "sand") of the phœnix. This interpretation is perhaps as old as the (original) Septuagint, and is current with the later Jews, whose appetite for fable, however, is often greater than their exegetical sagacity. Compare Eisenmenger's *Entdecktes Judenthum*, vol. i. passim. Among the Arabs the story of the phœnix was confused with that of the salamander; and the *samand* or *samandal* (Damiri, ii. 36 sq.) is represented sometimes as a quadruped, sometimes as a bird. It was firmly believed in, for the incombustible cloths woven of flexible asbestos were popularly thought to be made of its hair or plumage, and were themselves called by the same name (comp. Yâkût, i. 529, and Dory, s. s.). The *'anâ* (Pera. *smurgâ*), a stupendous bird like the roc (*rûk*) of Marco Polo and the *Arabian Nights*, also borrows some features of the phœnix. According to Karwini (i. 420) it lives 1700 years, and when a young bird is hatched the parent of opposite sex burns itself alive. In the book of Kallilah and Dimnah the *simûr* or *'ankâ* is the king of birds, the Indian garûda on whom Vishnu rides.

PHŒNIXVILLE, a borough in the United States, in Schuylkill township, Chester county, Pennsylvania, is situated 27½ miles north-west of Philadelphia by the Philadelphia and Reading Railroad, on the right bank of the Schuylkill river, which is there joined by French Creek, crossed by eight fine bridges. Phœnixville is best known as the seat of the blast-furnaces and mills of the Phœnix Iron Company, which had its origin in a rolling and slitting mill erected in 1790 by Benjamin Longstreth, and long ranked as the largest in the States. The works cover 150 acres and employ sometimes 2500 men. Phœnixville also contains a pottery, a sash and planing mill, a shirt-factory, and needle works; and iron, copper, and lead are all mined in the neighbourhood. The vicinity of the borough is noted for its large number of magnificent iron bridges. The population was 2670 in 1850, 4886 in 1860, 5292 in 1870, and 6682 in 1880.

PHONETICS (*τὰ φωνητικά*, the matters pertaining to the voice, *φωνή*) is the science and art of the production of sounds, including cries, by means of the organs of speech in man and their analogues in other animals.

This very extensive subject may be divided into the following three parts. (1) *Anatomical*, the accurate description of all the organs employed, emissive (lungs, with the muscles acting on them, trachea, larynx, pharynx, mouth and its parts, nose and its passages, with its closing valve the uvula) and receptive (the ear, external and internal, and parts of the brain with which the auditory nerve communicates). As all voice-sounds are produced by imitation, defects in the receptive organs entail defects in the action of the emissive. The congenitally deaf are consequently mute. (2) *Physiological*, the co-ordinated action of the parts just referred to in hearing and uttering sounds, and especially expiration and inspiration, with laryngeal, oral, and nasal actions, and the relation of these actions to the will (on these see VOICE). (3) *Acoustical*, with especial reference to the action of double membranous reeds, as in the glottis; the effects of resonance chambers, both fixed and variable in shape and size, open and closed, single and combined, and of the passage of air, more or less in a state of sonorous vibration, through tubes of variable lengths and widths, with walls of variable hardness, and with or without the interposition of semi-viscous fluids, as well as of flapping, smacking, or vibrating parts, and of other obstructions: also investigations into the nature, pro-

<sup>1</sup> Some other ancient accounts may be here referred to. That ascribed to Hecateus is, in the judgment of Cobet (*Memorie*, 1883), stolen from Herodotus by a late forger. The poem of the Jew Eschiel quoted by Eusebius (*Præp. Ev.*, ix. 29, 30) appears to refer to the phœnix. Here the sweet song is first mentioned,—a song which, according to the poem on the phœnix ascribed to Laotantius, accompanies the rising sun. The bird is often spoken of in Latin poetry, and is the subject of an idyl by Claudian. See also Solinus, cap. xxxiii., with Salmastius's *Exercitationes*; Tertullian, *De resur. carnis* c. 33; Clemens Rom., *Ep.* i. ch. xxv.

duction, and appreciation of qualities of tone, and their gradual but rapid gliding one into another, as well as into the nature of sympathetic vibration, not only of the different cavities filled with air in the organs of speech but of the solid bony parts, and also the softer cartilages, sinews, and muscles connecting and supporting them. This part of the subject, which is far from having been fully investigated at present, has two main subdivisions—(a) *musical*, regarding the nature and properties of musical sound, and especially song, with their varieties due to force, pitch, and quality, as partly investigated in Helmholtz's *Sensations of Tone*; (b) *rhetorical*, regarding the mechanism of speaking as distinct from singing, the blending and differentiation of qualities of tone, partly musical and partly unmusical, with constantly variable and ill-defined pitch and force, influenced by feeling; this subdivision embraces speech in particular, its special sounds for conveying thought and feeling, with their constantly-shifting characters, and also cries of joy and pain, as well as, properly speaking, the cries of the lower animals by which they communicate with those of the same kind; hence it comprehends also language, elocution, and philology in their fundamental constitution.

In a more restricted sense, applied solely to human beings and to articulate significant sounds (that is, exclusive of cries of pain and pleasure, or the inarticulate and often unconscious noises of snoring, snuffing, gargling, panting, laughing, crying, sobbing, sneezing, and the like), the term "phonetics" is used to designate a work on the enumeration, evaluation, relations, classification, analysis, and synthesis of SPEECH-SOUNDS (*q. v.*),—that is, of the sounds actually used in speech for conveying and recording thought by different nations and tribes, together with a means of fixing them by visible signs. The alphabet has followed speech-sounds with very halting steps. It is only in quite recent times that sufficient knowledge of the nature of speech has been obtained to enable us in some measure to understand and unravel the mysteries of the old enigmatic forms, and thus to construct a securer basis for philology than the guesses on which it once rested.

In a still more restricted and popular sense the term "phonetics" has been recently used for attempts to construct a new practical alphabet for English or other individual languages, or for several such languages simultaneously, with a view either of superseding the alphabets at present in use, or of improving their employment, or, at any rate, of facilitating the generally very difficult tasks of teaching and learning to read and write. Attempts of this kind are by no means recent: witness Loys Meigret, *Traicté touchant le commun usage de l'escriure francoise* (1545); Sir Thomas Smith, *De recta et emendata lingue Anglicæ scriptura* (1568); J. Hart, *An orthographie, conteyning the due order and reason, howe to write or painte thimage of mannes voice, most like to the life or nature* (1569); [William] Bullockers *Books at large for the Amendment of Orthographie for English speech* (1580); Alexander Gill (master of St Paul's school, London, when Milton was there), *Logonomia Anglica: quæ gentis sermo facilius addiscitur* (1619 and 1621); Charles Butler, *The English Grammar, or the Institution of Letters, Syllables, and Words in the English tongue* (1633). All these works are more or less printed in the orthography proposed, and each orthography is different. They are described and illustrated in A. J. Ellis's *Early English Pronunciation*, parts i. and iii. It is, however, not necessary in this place to go beyond attempts made by persons still living. In 1847, after three years of experiments, Isaac Pitman and Alexander John Ellis brought out their phonotypy, consisting of twenty-three old types and seventeen new ones, with which, among much other matter, the *Bible*

and the *Phonetic News* newspaper were printed in 1849, and extensive experiments were made, showing that reading in this alphabet could be rapidly taught, and that when children had learned to read phonotypy well they could easily learn to read in ordinary spelling. The new letters were subsequently much and frequently altered in meaning by Pitman, who in 1884 still produced a *Phonetic Journal* weekly in his present phonotypy. Very numerous forms of phonotypy, following either the old or the new edition, have also appeared in America. Many other systems have been tried by accenting, italicizing, supernumbering, or diacritically marking the letters to make the ordinary letters of English spelling convey their sounds. Almost every new "pronouncing dictionary" has its own method. This last plan has been, on the whole, successfully applied for teaching to read by many writers. In order to avoid new types, or even accented letters, and yet have a practical phonetic alphabet for English and its dialects, Ellis prefixed to part iii. of his *Early English Pronunciation* (1871) an account of "Glossic, a new system of spelling intended to be used concurrently with the existing English orthography, in order to remedy some of its defects without detracting from its value." This has been extensively used by the English Dialect Society and in Ellis's works on *Pronunciation for Singers* (1877) and *Speech in Song* (1878), in which it is fully explained and used in complete practical accounts of the phonology of English, German, French, Italian, and Spanish. Henry Sweet, in his *Handbook of Phonetics* (Oxford, 1878), proposed his "Broad Romanic," admitting, however, a few inverted letters. Subsequently, the English Spelling Reform Association was started, and great numbers of new attempts at phonetic alphabets for English only were made, which will be found described and illustrated at full length in W. R. Evans's *Spelling Experimenter and Phonetic Investigator* (2 vols., September 1880 to April 1883). There is also an American spelling reform association. But neither association has as yet agreed upon a new alphabet. In 1881 the Philological Society of London approved of certain "partial corrections of English spelling" submitted by Sweet, and these are more or less used in the *Proceedings* of that society, as edited by Sweet, and are generally approved by the American association, but they are not by any means an entirely phonetic scheme. In the books referred to, and particularly Evans's, the whole of this special branch of the subject of phonetics, so far as English is concerned, may be sufficiently examined. (A. J. E.\*)

PHORMIUM, or NEW ZEALAND FLAX (also called "New Zealand hemp"), is a fibre obtained from the leaves of *Phormium tenax* (ord. *Liliaceæ*). The plant is a native of New Zealand, the Chatham Islands, and Norfolk Island; it is now cultivated as an ornamental garden-plant in Europe, and for economic purposes it has been introduced into the Azores. The leaves grow from 3 to 6 and even 9 feet in height and from 2 to 3 inches in breadth, springing from the extremity of a rhizome. After the tuft of leaves has continued growing for about three years a flowering stalk springs up to the height of about 16 feet, and when it comes to maturity the whole plant dies down. Meantime, however, lateral branches or fans have been given off from the main rhizome, and thus the life of the plant is continued by stem as well as seed. Phormium has been treated as a cultivated plant in New Zealand, though only to a limited extent, and with no promising results; for the supplies of the raw material dependence has been principally placed on the abundance of the wild stocks and on sets planted as hedges and boundaries by the Maori. Among these people the fibre has always been an article of considerable importance, yielding cloaks, mats, cordage,

fish-g-line, &c., its valuable properties having attracted the attention of traders even before colonists settled in the islands. The leaves, for fibre-yielding purposes, come to maturity in about six months, and the habit of the Maoris is to cut them down twice a year, rejecting the outer and leaving the central immature leaves. Phormium is prepared with great care by native methods, only the mature fibres from the under-side of the leaves being taken. These are collected in water, scraped over the edge of a shell to free them from adhering cellular tissue and epidermis, and more than once washed in a running stream, followed by renewed scraping till the desired purity of fibre is attained. This native process is exceedingly wasteful, not more than one-fourth of the leaf-fibre being thereby utilized. But up till 1860 it was only native-prepared phormium that was known in the market, and it was on the material so carefully, but wastefully selected that the reputation of the fibre was built up. The troubles with the Maoris at that period led the colonists to engage in the industry, and the sudden demand for all available fibres caused soon afterwards by the Civil War in America greatly stimulated their endeavour. Machinery was invented for disintegrating the leaves and freeing the fibre, and at the same time experiments were made with the view of obtaining it by water-retting and by means of alkaline solutions and other chemical agencies. But the fibre produced by these rapid and economical means was very inferior in quality to the product of Maori handiwork, mainly because weak and undeveloped strands are, by machine preparation, unavoidably intermixed with the perfect fibres, which alone the Maoris select, and so the uniform quality and strength of the material are destroyed. No means have yet been devised for producing by mechanical or chemical means fibre in the perfect condition it shows when selected and prepared by Maoria. Phormium is a cream-coloured fibre with a fine silky gloss, capable of being spun and woven into many of the heavier textures for which flax is used, either alone or in combination with flax. It is, however, principally a cordage fibre, and in tensile strength it is second only to Manila hemp; but it does not bear well the alternations of wet and dry to which ship-ropes are subject. It is largely used as an adulterant of Manila hemp in rope-making, and recently it has come into use as a suitable material for the bands of self-binding reaping-machines. Between 1864 and 1876 there were exported from New Zealand 26,434 tons of phormium, valued at £592,218; in 1881 the exports were 1307 tons, of the value of £26,285.

**PHOSPHORESCENCE**, a name given to a variety of phenomena due to different causes, but all consisting in the emission of a pale more or less ill-defined light, not obviously due to combustion. The word was first used by physicists to describe the property possessed by many substances of themselves becoming luminous after exposure to light. Such bodies were termed "phosphori," and the earliest known appears to have been barium sulphide, which was discovered by Vincenzo Cascariolo, a cobbler of Bologna, at the beginning of the 17th century. See PHOSPHORUS. Subsequently, when certain animals were observed to be similarly endowed, the word "phosphorescent" was applied to them also. It is clear, however, that the light derived from previous exposure to light, which thus becomes, as it were, stored up, is hardly comparable with that which is produced by living protoplasm and evidently under the control of the nervous system. It has been suggested that this latter should have a special name appropriated to it, and here it will certainly be convenient to divide the subject into two heads in accordance with this distinction.

**A. PHOSPHORESCENCE IN MINERALS.**—In addition to the phosphorescence after insolation already alluded to

(see LIGHT, vol. xiv. p. 603) many minerals exhibit this property under other circumstances: (a) on heating to a temperature much below what is known as "red heat" (fluorspar, lepidolite, quinine)—this being often attended with a change in molecular structure or in specific heat; (b) on friction, as in the case of fused calcium chloride (Homburg's phosphorus); (c) on cleavage, a property manifested by mica, the two split portions becoming electrified—the one positive, the other negative; (d) on crystallization, as boracic acid after fusion, or water on rapid freezing.<sup>1</sup>

A few meteorological phenomena may here be mentioned. Rain has been seen to sparkle on striking the ground, and waterspouts and meteoric dust have presented a luminous appearance. The *ignis fatuus*, or will-o'-the-wisp, seen in marshy districts, has given rise to much difference of opinion: Kirby and Spence suggest that it may be due to luminous insects; but this explanation will certainly not apply in all cases, and it is perhaps on the whole more reasonable to believe that the phenomenon is caused by the slow combustion of marsh gas (methyl hydride).

**B. PHOSPHORESCENCE IN ORGANISMS.**—The vegetable kingdom has furnished few instances of the property under consideration; the earliest on record took place in the year 1762, when a daughter of Linnæus saw luminous emanations from a species of *Tropæolum*, since which time a like appearance has been noticed in *Helianthus annuus*, *Lilium bulbiferum*, *Calendula officinalis*, *Tagetes patula*, and *T. erecta*, all of which are red or orange-coloured flowers. A few cryptogams have been seen to shine in the dark, e.g., *Schistospora osmundacea* among the liverworts; *Rhizomorpha subterranea*, *Fungus igneus* in Amboyna, and other fungi in Brazil and Italy; and the mycelium (thread-like fibres) of other species growing in decayed wood is also occasionally luminous. There are also a number of small marine phosphorescent organisms<sup>2</sup> (*Pyrocystis*, *Peridinium*), concerning which it is impossible to say with certainty whether they should be referred to the animal or the vegetable kingdom. But the most brilliant as well as the most varied and interesting cases of phosphorescence belong to the animal world, and there is not one of the larger groups which does not furnish some instances of it.

**Nature of the Light.**—The light emitted by different animals varies very much in colour: green has been noticed in the glow-worm, fire-flies, some brittle-stars, centipedes, and annelids; blue is seen in the Italian fire-fly (*Luciola italica*); and this and light green are the predominant colours exhibited by marine animals, although the beautiful Girdle of Venus and some species of *Salpa* and *Cleodora* appear red, and *Pavonaria* and other gorgonoids lilac. The curious lantern-fly (*Fulgora pyrorhynchus*) has a purple light. One very remarkable instance is mentioned of an *Appendicularia* in which the same individual appeared first red, then blue, and finally green.<sup>3</sup> In comparatively few cases has the light been examined by the spectroscope. Panceri<sup>4</sup> states that in every instance observed by him it was monochromatic, the spectrum consisting of a continuous band without any separate bright lines; in *Pholas* this band extended from the line E of the solar spectrum to a little beyond F; in *Umbellula*, examined on the voyage of the "Challenger," it was sharply included between the lines *b* and D.<sup>5</sup>

**Luminous Organs.**—In the lowest forms of life and in

<sup>1</sup> Pilpson, *Phosphorescence*, London, 1862.

<sup>2</sup> Ehrenberg, *Das Leuchten des Meeres*, 1835, and in *Abhandl. & Akad. Wiss.*, Berlin (1834), 1836.

<sup>3</sup> Giglioli, "La Fosforescenza del Mare," in *Bollet. d. Soc. Geog. Geol. Ital.*, 1870.

<sup>4</sup> Numerous papers in *Atti Accad. Sci. Fis. e Mat.*, Naples, 1870-78, and abstr., *Ann. Sci. Nat.*, ser. 5, vol. xvi., 1872.

<sup>5</sup> Thomson, *Voyage of the Challenger: the Atlantic*, London, 1877, vol. i. p. 150.

many jelly-fish there seem to be no organs specially set apart for the production of light, this being emitted from the whole surface of the body; but even in the latter group a degree of specialization is found, for in some it is only the marginal sense-organs, in others the radial canals and ovaries, that are luminous. In other groups of animals the localization of the photogenic property in certain organs or tissues is universal, and these present the utmost variety in structure and situation. In the sea-pens (*Pennatula*) every polyp has eight luminous bands on the outer surface of the stomach; when the colony is touched the light commences at the point irritated and then spreads to other portions. *Pyrosoma*, a colonial free-swimming ascidian, has two small patches of cells at the base of each inhalent tube; the cells have no nucleus, but contain a material which appears from its chemical relations to be fatty; as in *Pennatula*, the light spreads from the irritated point. In the transparent pelagic mollusc (*Phyllirohoe*) there are rounded cells connected with the nerve-twigs from which, as also from the ordinary cells of the nerve-ganglia, the light emanates. Several annelids (*Chastopterus*, *Tomopteris*) have luminous organs at the bases of lateral processes of the body. The rock-boring mollusc (*Pholias*), whose phosphorescent properties were known as long ago as the time of Pliny, has three distinct luminous organs—(1) a curved band along the anterior border of the mantle, (2) two small triangular patches at the entrance of the anterior siphon, and (3) two long parallel cords situated within this latter; these are all covered with ciliated epithelium, like that of other parts of the mantle, but having granular contents.<sup>1</sup>

The glow-worm (*Lampyrus splendidula*) has been investigated by Max Schultze;<sup>2</sup> he finds that the male has a pair of organs in each of the two segments preceding the last in the abdomen; each organ consists of a pale transparent superficial layer, which gives off the light, and a deep opaque layer, whose function is less obvious, but which may serve as a reflector.<sup>3</sup> Quite recently Emery<sup>4</sup> has examined the Italian fire-fly, in which both male and female are luminous. As in the glow-worm, the organ consists of two layers: the dorsal contains large quantities of uric acid salts; while in the ventral layer there are clear cells arranged in cylindrical lobules, which surround vertically-disposed tracheal limbs—a structure comparable to the stellate tracheal cells of Schultze. The luminous organs are regarded as homologous to the "fat body" so common in insects. The ultimate branches of the tracheae ramify in these and terminate in peculiar star-like cells; nerve-fibres are also present. The Mexican fire-flies (*Pyrophorus*) are in most respects similar to the glow-worm, but have a pair of organs in the thorax and one in the abdomen, whilst the lantern-flies (*Fulgora*) carry their light at the extremity of a long curved proboscis. Many crustaceans are luminous, but in most cases it has not been observed from what part of the body the light emanates; in some instances, however (*Thysanopoda* [*Nyctiphanes*] *norvegica*, *Euphausia pellucida*, &c.), there are small globular phosphorescent organs, which have often been described as eyes, beneath the thorax and between the abdominal swimmerets. Sars<sup>5</sup> states that "these globules . . . constitute a highly complicated luminous apparatus, the lenticular body of the organs, generally described as a true eye-lens, acting as a condenser, which . . . enables the animal to produce at will a very bright flash of light in a given direction." Mr John Murray in the same place records the occurrence

of a very brilliant display of this phosphorescence during the "Triton" expedition in the Faroe Channel.

Many deep-sea fish possess round shining bodies imbedded in the skin, either in the vicinity of the eye or along the sides of the body; some of these resemble modified eyes, whilst the structure of others recalls a glandular organ without the usual duct,<sup>6</sup> and it is supposed that some or all of these are luminous organs, the lens in the former group acting as a bull's eye (see ICHTHYOLOGY, vol. xii. p. 684).

Dead and putrescent animals are not unfrequently phosphorescent; this fact has most commonly been observed in fish, though instances are not wanting in which the property has been manifested by molluscs and other animals, and even by the human body. Furthermore, a few startling but apparently well-authenticated instances are on record in which human beings have been luminous while yet alive owing to certain states of disease.<sup>7</sup>

*Causes of Phosphorescence.*—On this head it is at present impossible to write with certainty; it seems likely, however, from the variety of the effects produced by different chemical and physical agents, that the causes are manifold. In many instances light is only emitted after stimulation, either mechanically, chemically (by fresh water, milk, ammonia), or by electricity, though there are cases in which this last has no effect whatever. The fact that the nervous system is so often closely connected with the luminous organs indicates that the exhibition of the light is either dependant on the volition of the animal or is the reflex result of the stimulation of sensory nerves (Panoery). In the glow-worm the distribution of tracheae (air-tubes) throughout the photogenic apparatus, and the fact that carbonic acid extinguishes the light while oxygen intensifies it, suggest that it is due to some form of slow combustion, while the fatty contents of the luminous cells of this and many other animals point to the probability that a fat containing free phosphorus is the active agent in the process. Since a large number of luminous organs retain their power after the death of the animal, and even after desiccation and subsequent moistening, there seems no necessity to adopt the theory that we have to deal with an instance of the direct transformation of vital into radiant energy.

The well-known phosphorescence of the sea is due to the animals which inhabit it, except in a few cases in which it has been ascribed to putrescent matter. This was known as long ago as 1749, when Vianelli<sup>8</sup> discovered in the waters of the Adriatic a luminous animalcule which was named by him *Nereis noctilucan*, and was probably the creature now known as *Noctiluca miliaris*. This minute animal swarms in countless myriads on the surface of the sea not very far from land, and is the commonest cause of its diffuse luminosity, although other low forms of life such as *Peridinium* (*Ceratium*) contribute in no small degree; and in mid-ocean another organism, *Pyrocystis*, which has often been mistaken for *Noctiluca*, appears to replace it, and is very abundant. The brilliant sparkling phosphorescence more rarely seen is caused by the presence of copepods and other small surface crustaceans.<sup>9</sup>

*Uses of Phosphorescence.*—The service rendered by this property to its possessors is in many cases by no means obvious; indeed it would seem certain that to crustacean larvae and other surface-organisms surrounded by voracious enemies phosphorescence must be a "perilous gift." It is possessed by so many anthozoa and jelly-fish, which have also stinging organs, that fish have perhaps learned to shun instinctively all phosphorescent animals; Bahner<sup>10</sup> states that fishes avoid nets in which phosphorescent *Medusae* have become entangled; if such be the case, it would be possible for animals otherwise defenceless to obtain protection by acquiring this property.<sup>11</sup> A similar hypothesis has been propounded with respect to the Italian fire-fly,<sup>12</sup> although, as regards the glow-worm, it has been generally believed that the light serves to attract the opposite sex, and the same has been stated with respect to the earth-worm. The fact that so many deep-sea animals are phosphorescent, coupled with the discovery that many fish from those regions have large and normally-developed eyes whilst others have organs which appear to be adapted for the production of light, has led to the belief that this source of light becomes of great importance in the depths of the ocean where no sunlight penetrates,—an hypothesis which is known as the "abyssal theory of light." (W. E. H.O.)

<sup>1</sup> Panceri, *op. cit.*

<sup>2</sup> Zur Kenntn. d. Leuchtorgane v. *Lampyrus splendidula*, in *Archiv f. mikr. Anat.*, vol. 1, 1865.

<sup>3</sup> Heinemann, "Unters. u. d. Leuchtorgane d. b. Vera Cruz vorkomm. Leuchtflöher," in *Archiv f. mikr. Anat.*, vol. VIII, 1872.

<sup>4</sup> *Zeitschr. f. wiss. Zool.*, vol. xl, 1884.

<sup>5</sup> *Narrative of the "Challenger" Expedition*, vol. I. 1885.

<sup>6</sup> Ussoff, *Bull. Soc. Imp. Nat. Moscou*, vol. IV. part 1. p. 77, 1879.

<sup>7</sup> Philpott, *op. cit.*

<sup>8</sup> *Nuove Scoperte intorno alle Luci notturne dell' Acque marine*, Venice, 1749.

<sup>9</sup> Verill, in *Nature*, vol. xxx. p. 281, 1884.

<sup>10</sup> *Zeitschr. f. wiss. Zool.*, xi, 1884.

**PHOSPHORUS AND PHOSPHATES.** "Phosphorus" (*φωσφόρος*, light-bringer) had currency in chemistry as a generic term for all substances which shine in the dark without burning, until the name came to be monopolized by a peculiar kind of "phosphorus" which was discovered, some time previous to 1678, by the German alchemist Brand of Hamburg. Brand, hoping to obtain thereby an essence for the "ennobling" of silver into gold, subjected urine-solids to dry distillation. In lieu of the hoped-for essence he obtained as part of the distillate a wax-like, easily fusible solid which, besides being phosphorescent, readily caught fire, to burn with a dazzling light into a white solid acid. The new phosphorus naturally excited universal interest; but it was, and remained, only a rather costly chemical curiosity until Scheele, in 1771, starting from the discovery of Gahn that bone-ash is the lime-salt of a peculiar non-volatile acid, proved that this acid is identical with the one formed in the combustion of phosphorus, and that the latter, being only "phlogisticated" bone-ash acid, can be obtained from it by distillation with charcoal at a high temperature. This method of Scheele's is used to the present day for the manufacture of phosphorus, and even the theoretical notion on which it rests is recognized as correct as far as it goes, anhydrous bone-ash acid being a compound of phosphorus with oxygen the formation of which involves the liberation of part of the energy ("phlogiston") of each in the kinetic form of heat. That phosphorus is an elementary substance was originally a surmise, which, however, has been confirmed by all subsequent experiences. In comparatively recent times it was found that Brand's phosphorus is susceptible of passing (by mere loss of energy) into two allotropic modifications, known as "red" and "metallic" phosphorus respectively, so that the name "phosphorus" has again come to assume a generic meaning, being used for these three substances and the element as such conjointly.

**Manufacture.**—For the manufacture of ordinary phosphorus any kind of phosphate of lime might be used, and in fact mineral phosphates are used occasionally, though as a rule the bones of domestic animals are employed as a raw material. Such bones (apart from a large percentage of water and a small admixture of fats and other subsidiary organic components) consist essentially of two things, namely, (1) *ossein*—a nitrogenous organic compound, insoluble in water, but convertible by long treatment with hot water into a solution of "glue"—and (2) an infusible and incombustible part,—the two being united together (perhaps chemically) into a cellular tissue. The following analysis of the humerus of an ox gives an idea of the constitution of the second part and its ratio to the whole.

Phosphate of lime, $P_2O_5, 3CaO$ .....	61.4	
Phosphate of magnesia, $P_2O_5, 3MgO$ .....	1.7	
Carbonate of lime.....	5.6	71.7
Osssein.....	28.3	
		100.0

The percentages, however, in bones generally are subject to great variation. When bones are heated to redness in the absence of air the organic part is destroyed, and there remains ultimately a cellular tissue of bone-phosphate impregnated, so to speak, with finely-divided charcoal. This black residue, known as "bone-black," is used largely for the decoloration of sugar-syrup, and, after having been exhausted in this direction, forms a cheap material for the manufacture of bone-ash and consequently of phosphorus; but, as a rule, the phosphorus-manufacturer makes his bone-ash direct from bones, by burning them in a furnace (constructed and wrought pretty much like a limekiln) between alternate layers of coal.

The burned bones (which retain their original shape)

are ground up into granules of about the size of lentils, and these are then placed in a wooden tank coated inside with lead, to be decomposed by means of about their own weight of chamber-acid, *i.e.*, sulphuric acid containing about 60 per cent. of real  $H_2SO_4$ . To accelerate the action the bone-meal is mixed with boiling water previous to the addition of acid, and steam may be passed into the magma when its temperature threatens to fall too low. The acid readily decomposes the carbonate of the bone-ash, and then acts, more slowly, on the phosphate, the process being completed in about twenty-four hours; and the result, in regard to the latter, is that about two-thirds of the phosphate are decomposed into sulphate of lime (gypsum), which separates out as a precipitate, and phosphoric acid, which unites with the residual one-third of the phosphate and the water into a solution of superphosphate of lime—

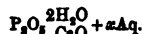

To eliminate the gypsum the mass is diluted with water, allowed to settle, and the solution drawn off with lead syphons, then the residue is washed by decantation, and ultimately filtered off through a bed of straw contained in a cask with a perforated bottom. The spent heat of the distillation-furnace is utilized to concentrate the united liquors to about 1.45 specific gravity, when a remnant of gypsum separates out, which must be removed. The clarified liquor is then mixed with about one-tenth of its weight of granulated charcoal, and the whole evaporated in an iron basin until the mass is sufficiently dry to be passed through a copper sieve and granulated. The granules are heated cautiously over a fire, to be dehydrated as far as possible without loss of phosphorus (as phosphuretted hydrogen); and the dry mass is then transferred to fire-clay retorts—either pear-shaped with bent-down necks, or cylinders, about 18 inches long and 4 inches in diameter, with straight necks—arranged within a powerful furnace. The condensers are made of earthenware, and must be so arranged that loss of phosphorus by combustion is avoided as far as possible; its condensation takes care of itself. One construction is to give the condenser the form of a bell-jar resting in a saucer containing water; lateral orifices in the bell serve to couple every two bells into one, to unite each with its retort-neck, and to send the vapour (of phosphuretted hydrogen, carbonic oxide, and other poisonous gases) into a chimney, where they take fire spontaneously, and the products are carried away by the draught. While the condensers are being adjusted the fire is kindled and raised very slowly, but ultimately forced up to the highest temperature which the retorts can stand, and maintained at this pitch until the appearance of the flames of the escaping vapours proves the absence from them of phosphorus, free or combined. This takes from thirty-six to forty-eight hours. The reduction-process, though in reality very complex, is in its principal features easily understood. The acid-phosphate behaves as if it were a mere mixture of  $\frac{2}{3} \times P_2O_5 + \frac{1}{3} \times P_2O_5, 3CaO$  (bone-phosphate). The quasi-free acid ( $\frac{1}{2}P_2O_5$ ) is reduced by the charcoal with formation of carbonic oxide and phosphorus-vapour, one-third of the phosphorus remaining in its original form of bone-phosphate.

The distillation of phosphorus is rather a dangerous operation, because the connecting pipes at the condensers are apt to get blocked up with frozen phosphorus, and consequently must be cleared from lime by copper or iron wires being pushed through them (at a certain risk to the operator). Another difficulty is that, although a retort may be quite whole in the ordinary sense, it may, and as a rule does, admit of the perspiration of phosphorus-vapour. To render retorts as neatly as possible impermeable to the

vapour they are being provided with two or three coats of some kind of cement, such as a mixture of slaked lime and borax, or a magma of clay, horse-dung, and water. In the collecting and further manipulation of the phosphorus the dangerous inflammability of the substance demands that all operations be conducted under water.

As soon as the retorts have cooled down sufficiently the condensers are detached and their tubuli bunged up to prevent access of air to the inside. The necks of the retorts are knocked off and thrown into water to save the phosphorus which has condensed within them and to unite it with that of the condensers. From the analysis of the ox-bone quoted we calculate that its ash contains 17.6 per cent. of phosphorus, of which two-thirds (= 11.7 per cent.) should be recoverable as free phosphorus; according to Fleck, the yield of phosphorus is 8 per cent., while Payen puts it down at 8 to 10 per cent. But this crude phosphorus is largely contaminated with blown-over bone-ash and charcoal and with "red" phosphorus. Its purification used to be effected everywhere by melting it under water of about 60° C., and pressing it through chamois leather by means of a force-pump. In certain French works porous fireclay serves as a filtering medium, while superheated steam supplies at the same time the necessary heat and pressure. By the addition of coarsely-powdered charcoal to the phosphorus the clogging-up of the pores of the fireclay septum is precluded. A more effectual method of purification is to re-distil the crude (or perhaps the previously filtered) phosphorus from out of cast-iron retorts, the necks of which dip half an inch deep into water contained in a bucket. A chemical method of purification is that of Böttcher, who fuses the crude phosphorus (100 parts) under water, with addition of 3.5 parts of oil of vitriol and 3.5 parts of bichromate of potash. The phosphorus passes, with a feeble gas-evolution, into an almost colourless liquid, with a loss of only 4 per cent. of its weight, as against the 10 to 15 per cent. unavoidably involved in the distillation process. To bring the purified phosphorus into the traditional form of sticks it is fused under water and sucked up into slightly conical glass tubes about two-fifths of an inch wide and a foot long; the tubes are closed below with the finger and immersed in cold water to cause the contents to freeze. The solid stick is then pushed out by means of a rod, and cut into pieces with a pair of scissors. For emission into commerce the sticks are put into cylindrical wide-necked glass bottles, or into tin canisters, full of water, which latter had better be mixed with a sufficiency of alcohol or glycerin to prevent freezing (and bursting) in winter time.

Seubert, about 1844, invented an ingenious apparatus for the continuous casting of phosphorus-sticks, consisting of a funnel-shaped vessel of copper, terminating below in a long horizontal copper tube, the outer end of which lies within a tank full of cold water. The phosphorus is placed in the funnel, covered with water, and the whole up to the cold-water tank raised (by means of a water-bath and steam-pipes) to a suitable temperature, matters being arranged so that the phosphorus freezes just on arriving at the exit end of the tube. The workman then catches the protruding button of phosphorus and pulls out an endless stick, which is cut up into pieces of the desired length. This ingenious apparatus, however, has not been found to work satisfactorily, and has been given up again in favour of some form of the old method. The loss of one-third of the phosphorus contained in the bone-ash, which is unavoidably involved in the ordinary method of phosphorus-making, can be avoided, according to Wöhler, by adding finely-powdered quartz to the mixture which goes into the retorts. The superphosphate is then completely decomposed with formation of a residue of silicate, instead of

phosphate, of lime. An improvement by Fleck aims at the utilization of the organic part of the bones. He proposes to recover the fat from the bones by boiling them with water and then the gelatin by digesting them in hydrochloric acid of 1.05 specific gravity. The gelatin remains in a coherent form; the phosphate passes into solution as mono-calcic salt, which is recovered by evaporation in crystals and then reduced by distillation with charcoal. None of these (and other) proposals have been much heeded; the manufacture of phosphorus at present, in fact, is almost a monopoly, the bulk of what occurs in commerce being produced by two firms, viz., Albright and Wilson of Oldbury, near Birmingham, and Coignet and Son in Lyons. According to E. Kopp, the production in 1874 amounted to 1200 tons.

Recently purified phosphorus is a slightly yellowish or colourless solid of about the consistence of beeswax. At low temperatures it is brittle; specific gravity = 1.83 at 10° C. It fuses at 44.3° C. into a strongly light-refracting liquid of 1.743 (Kopp) specific gravity. Neither in the solid nor in the liquid state does it conduct electricity. When heated further (in an inert atmosphere such as hydrogen or carbonic-acid gas) it boils at 290° C., and assumes the form of a colourless vapour which at 1040° C. is 4.5 times as heavy as air or 65.1 times as heavy as hydrogen, whence it follows that its molecular weight is  $2 \times 65.1 = 130.2$  — very nearly four times the atomic weight of phosphorus (31.0). Phosphorus is insoluble in water, more or less sparingly soluble in alcohol, ether, fatty oils, and oil of turpentine, and very abundantly soluble in bisulphide of carbon. When exposed to the air, and especially to moist air, it suffers gradual oxidation into phosphorous and phosphoric acids with evolution of a feeble light. Phosphorus does not phosphoresce in the absence of oxygen. Singularly, it does not phosphoresce in pure oxygen either, unless the tension of the gas be reduced to some point considerably below one atmosphere (Graham). Phosphorus is a most dangerous poison; doses of as little as 0.1 gramme (= 1.5 grains) are known to have been fatal to adults. The heads of a few lucifer matches may suffice to kill a child. Phosphorus is used chiefly for the manufacture of lucifer matches (see MATCHES, vol. xv. pp. 625, 626) and also in the manufacture of iodide of methyl and other organic preparations used as auxiliary agents in the tar-colour industry. Phosphorus-paste, made by working up a small proportion of phosphorus melted under water in a hot mortar with flour, is used as poison for vermin.

*Red Phosphorus.* — A red infusible solid which is always produced when ordinary phosphorus is made to burn in an insufficient supply of air, and also by the long-continued action of sunlight on phosphorus-sticks kept under water, used to be taken for a lower oxide of the element, until A. v. Schrötter of Vienna showed, in 1844, that it is nothing but an allotropic modification of the elementary substance. A given mass of ordinary phosphorus can be converted almost completely into the red modification by keeping it at 240° to 250° C. in the absence of air for a sufficient time. The addition of a trace of iodine to phosphorus at 200° C. brings about the conversion suddenly with large evolution of heat (Hrodie). Red phosphorus is now an article of chemical manufacture. The phosphorus is simply heated, and kept at the requisite temperature within a large iron pot which communicates with the atmosphere by only a narrow pipe. At a very slight expense of the material the air within the apparatus is quickly deoxygenated and converted into (inert) nitrogen. The requisite steady temperature is maintained by means of a bath of molten solder. By the new effect of the heat the phosphorus becomes more and more viscid and darker and darker in colour, and is at last completely converted into a dark-red opaque infusible solid. This, however, always includes a small proportion of the ordinary modification, which is most readily extracted by powdering the crude product and exhausting it with bisulphide of carbon, which does not affect the red kind. A less expensive method is to boil the powdered raw product with successive quantities of caustic-soda ley, when the ordinary phosphorus only is dissolved as hypophosphite with evolution of phosphuretted hydrogen. The residue is washed and



dried and then sent out in bottles or canisters like any ordinary chemical preparation. It is not at all affected by even moist air, nor by aerated water, hence it is neither phosphorescent nor poisonous. When heated in air to about 260° C. it begins to pass into the ordinary modification and consequently burns, readily enough, into the same phosphoric acid P<sub>2</sub>O<sub>5</sub> as ordinary phosphorus does. But its combustion-heat amounts to only 5070 Centigrade-units per unit-weight of fuel as against the 5953 units produced in the combustion of ordinary phosphorus. The balance of 883 units is the equivalent of the surplus of energy contained in the yellow as compared with the red modification. This accounts for the relative chemical inertness of the latter. The specific gravity of red phosphorus is 2.089 to 2.106 at 17° C.; its electric conductive power is about .000,000,1 of that of silver wire (Matthiessen). It is used in making safety-matches.

**Metallio Phosphorus.**—This, discovered by Hittorf, is obtained by heating ordinary phosphorus with lead in sealed-up tubes to redness for forty hours. After removal of the lead by nitric acid metallic phosphorus remains, partly in the shape of dark resplendent plates, partly in the form of microscopic rhombohedra. It requires a temperature of 353° to be converted into ordinary phosphorus-vapour. The specific gravity is 2.34 at 15° C.

**Detection of Phosphorus.**—The detection of (ord.) phosphorus in medico-legal cases offers no difficulty as long as the phosphorus has not disappeared by oxidation. In the case of a mass of food or the contents of a stomach the first step is to spread out the mass on a plate and view it in the dark. A very small admixture of phosphorus becomes visible by its phosphorescence. Failing this, the mass is distilled with water from out of a glass flask connected with a glass Liebig's condenser in a dark room. The minutest trace of phosphorus suffices to impart phosphorescence to the vapours at some stage of the distillation. Should this second test fail we must search for phosphorous acid, which may be there as a product of the oxidation of phosphorus originally present as such. To test for phosphoric acid would be of no use, as salts of this acid are present in all animal and vegetable juices and tissues. Phosphorous acid, if present, can be detected by treating the mass, in a properly constructed gas-evolution apparatus, with pure hydrochloric acid and zinc. The hydrogen gas evolved must be purified by passing it over pieces of solid caustic potash, and made to stream out of a narrow platinum nozzle. If the reagents are pure and phosphorous acid is absent the gas burns with a colourless flame, which remains so even when depressed by means of a porcelain plate; in the presence of phosphorous acid the gas contains phosphuretted hydrogen, which causes the flame of the gas to exhibit a green core, at least when depressed by means of a porcelain plate. The test is very delicate, but in interpreting a positive result it must be remembered that it applies likewise to hypophosphorous acid, and that certain salts of this acid are recognized medicinal agents.

Of all phosphorus compounds ortho-phosphates are the commonest, and they can be detected by the tests given below under "Phosphates." All other phosphorus compounds, when fused with carbonate of alkali and nitre, or heated in sealed-up tubes with strong nitric acid to a sufficient temperature, are changed so that the phosphorus assumes the form of ortho-phosphoric acid, which is easily detected. Either of the two operations named (by the mere action of the alkali or of the acid *qua* acid) converts what may be present of meta-phosphoric or pyro-phosphoric into ortho-phosphoric acid.

**Phosphor-Bronze.**—This name has been given to a class of useful metallic substances produced by the chemical union of either pure copper or of copper alloys with phosphorus. Most commercial copper is contaminated with a small proportion of its own suboxide, which, in the case of an otherwise pure metal, detracts from its tenacity and plasticity; and all ordinary bronze is subject to a similar contamination, because, whatever kind of copper may have been used in making it, the tin is sure to suffer partial oxidation, and some of this oxide, as Montefiore-Levi and Künzel found, remains diffused throughout the casting, and diminishes its homogeneity and solidity. Experience shows that both in the case of copper and bronze the oxygen present as metallic oxide can be removed by introduction into the fused metal of a judiciously limited proportion of phosphorus, which takes out the oxygen (and itself) into the slag as phosphate, and thus produces a purely metallic and consequently superior metal. A small excess of phosphorus in either case effects further improvement. A phosphor-copper containing 0.1 to 0.5 per cent. of the non-metallic element has all the plasticity of the pure metal coupled with higher degrees of hardness and solidity. An alloy of from 0.5 to 2.0 per cent. gives good castings, because, unlike the pure metal, it does not form blisters on solidifying. In the case of phosphorized bronze the presence of somewhat more than 0.5 per cent. of phosphorus (in the finished alloy) produces a warmer tone of colour (more gold-like than that of the plain alloy), a finer grain (similar to that of steel), a higher degree of elasticity, and a higher breaking-strain. The latter may be more than double that of the corresponding plain bronze. By

increasing or diminishing the proportion of phosphorus the mechanical properties of a phosphor-bronze can be modified at will, within wide limits. By its fine colour and its perfect fluidity when molten it lends itself particularly well for the casting of artistic or ornamental articles. The introduction of phosphorus into the metal is best effected by fusing it with the proper proportion of a rich phosphor-copper. A phosphor-copper containing about 9 per cent. of phosphorus can be produced as follows. A kind of potential phosphorus ("phosphorus mass") is made by mixing superphosphate of lime with 20 per cent. of charcoal, and dehydrating the mixture at a dull red heat. Six hundred parts of this mass are mixed with 975 of copper-turnings and 75 of charcoal, and kept at copper-fusion heat for sixteen hours within a graphite crucible. The phosphor-copper is obtained in the form of detached granules, which are picked out, re-fused, and cast out into cast-iron moulds. Phosphor-bronze has only come to be popularly known during the last decade or two; but as early as 1848 A. & H. Parkes of Birmingham took out a patent for phosphoriferous metallic alloys.

**Phosphuretted Hydrogens.**—Of these three are known, namely, (1) phosphine, a gas of the composition and specific gravity PH<sub>3</sub>, (2) a volatile liquid of the composition and vapour-density P<sub>2</sub>H<sub>4</sub>, and (3) a yellow solid of the probable composition P<sub>3</sub>H<sub>3</sub>. The liquid compound (No. 2) at once takes fire when it comes into contact with air, and a small admixture of its vapour to any inflammable gas, such as coal-gas, renders the latter self-inflammable. The most important and best known of the three hydrides is phosphine, PH<sub>3</sub>. This gas is formed when (syrupy) phosphorous acid is heated—thus, 4PH<sub>3</sub>O<sub>2</sub>=3PH<sub>3</sub>O<sub>4</sub>+PH<sub>3</sub>; also when phosphorus is being dissolved in hot solutions of caustic potash, soda, or baryta,

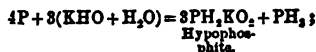

also by the action of water on the phosphides of highly basileous metals. The gas evolved by any of these processes is impure; that obtained by the second or third invariably includes vapour of P<sub>2</sub>H<sub>4</sub>, and consequently is self-inflammable. Pure phosphine can be obtained only by decomposing solid iodide of phosphonium with concentrated caustic potash-ley in a suitable gas-evolution bottle previously filled with hydrogen to avoid explosion. It is a colourless gas, smelling intensely like putrid fish, and very poisonous. It is slightly soluble in water, and takes fire in air only beyond 100° C. It may be mixed with pure oxygen without change; but when the mixture is suddenly expanded it explodes violently. Notwithstanding its analogy to ammonia (NH<sub>3</sub>), phosphine is only very feebly basic. It unites with gaseous hydriodic or hydrobromic acid into solid phosphonium salts PH<sub>3</sub>(I or Br); but these are both decomposed by water into the respective acids and phosphine. Pure phosphine is little known; chemists are more familiar with the (impure) gas which is evolved when "phosphide of calcium" is thrown into water, and which, containing vapour of P<sub>2</sub>H<sub>4</sub>, at once catches fire when it bubbles out of the water into the air, with formation of steam and a smoke of meta-phosphoric acid, which latter, in a still atmosphere, assumes the form of an exquisite vortex-ring. During the last decade or so this reaction has come to be pretty extensively utilized in navigation for producing a light on the surface of the sea at night, in case of accidents, and for other purposes. A British patent for this useful application of phosphide of calcium was granted (as No. 1828) to the agent of Silas and Pegot Ogier of Paris on the 8th of August 1859, but allowed to lapse in 1863, to be subsequently wrought by others. The manufacture of the phosphide is now (1884) being chiefly carried on by one firm (in Warrington, England), and through the courtesy of their chemist, Mr W. G. Johnston, the writer is enabled to give the following details. The preparation of the phosphide is effected within a crucible standing on a support within a furnace, and divided by a perforated false bottom into two compartments. The lower is charged with pieces of phosphorus, the upper, up to the closely-fitting lid, with fragments of quicklime. The firing is conducted so that the lime is red hot before the phosphorus, through the radiation and conduction of the heat applied above, begins to volatilize. A charge yielding 20 lb of product is finished in from five to eight hours. The reaction is very complex, but it is easy to see through its general course; part of the phosphorus deoxidizes lime with formation of P<sub>2</sub>O<sub>5</sub>, which unites with other lime into phosphate, and of calcium, which combines with other phosphorus into phosphides. Of the latter, PCA seems to predominate, and consequently the product, when thrown into water, should yield chiefly the hydride P<sub>3</sub>H<sub>3</sub>; but this latter very readily breaks up into phosphine and solid hydride P<sub>2</sub>H. The crude phosphide forms a brown stone-like mass, which must at once be secured in air-tight receptacles. But most of it is immediately worked up into "lights" of various kinds, of which the "life-buoy light" may be selected as an example. It consists of a cylindrical fluted-iron box, the upper half of which is taken up by an inverted hollow box, which serves as a float when the light is in the water. The lower half contains

some 16 oz. of fragments of phosphide of calcium. Two small circular portions of the top and bottom respectively consist of soft metal (lead). These are pierced with an appended pricker before the apparatus goes overboard along with the buoy, to which it is attached by means of a cord. The water penetrates through the lower hole and the gas comes out through the upper and burns with a brilliant flame, which is from 9 to 18 inches high and lasts for about half an hour. A larger similar contrivance, intended to be accommodated within a bucket full of water on deck, serves as an inextinguishable night-signal to ships in distress. By the British Merchant Shipping Act, 1876, Vict. 21, every sea-going passenger-steamers and every emigrant-ship must be provided with arrangements for inextinguishable distress-lights and life-buoy lights. In the British navy a peculiar form of the phosphide of calcium light is used in connexion with torpedo-practice.

**Phosphorus Bases.**—This is a generic name for organic bases which are related to phosphine ( $\text{PH}_3$ ), as the "compound ammonias" are to  $\text{NH}_3$ . See CHEMISTRY, vol. v. p. 516 *sq.*; also METHYL, vol. xvi. p. 187. Tri-ethyl phosphine  $\text{P}(\text{C}_2\text{H}_5)_3$ , a colourless self-inflammable liquid, readily unites with bisulphide of carbon into a red crystalline compound, and consequently is available as a delicate reagent for the detection of the vapour of this compound in coal-gas.

#### PHOSPHATES.

"Phosphates," in chemistry, is a generic term for the salts formed by the union of the acid-anhydride  $\text{P}_2\text{O}_5$  with bases or water or both. As explained in CHEMISTRY (vol. v. pp. 517, 518) there are three classes of phosphates customarily distinguished by the prefixes ortho, pyro, and meta. The last two nowhere occur in nature, and are hardly known to the arts; hence in this article only the ortho-compounds will be noticed, and their specific prefix will be dropped except where it is needed for definiteness. Combined phosphoric acid is universally diffused throughout the three kingdoms of nature, and it is perhaps as well to add to the practical, if not absolute, exclusion of all other phosphorus compounds. All organic tissues and juices contain it: of animal matters bones and blood-solids, of vegetable the seeds of cereals, may be referred to as being exceptionally rich in phosphates. Of mineral phosphates the following may be here referred to:—pyro-morphite,  $3(\text{P}_2\text{O}_5 \cdot 3\text{PbO}) + \text{PbCl}_2$ , where the chlorine may be replaced partially by fluorine; wavelite,  $2(\text{Al}_2\text{O}_3 \cdot \text{P}_2\text{O}_5) + \text{Al}_2\text{O}_3 \cdot 3\text{H}_2\text{O} + 9\text{Aq}$  (this is a crystalline mineral; an amorphous or massive phosphate of alumina, known as "rotundominal," occurs as a large deposit on a West Indian island); vivianite,  $\text{P}_2\text{O}_5 \cdot 3\text{FeO} + 8\text{H}_2\text{O}$ . All these and any others that might be named are rare minerals compared with apatite and its derivatives.

**Apatite.**—This exists in a variety of forms, but, as long as undecomposed, always answers the formula  $3(\text{P}_2\text{O}_5 \cdot 3\text{CaO}) + (\text{CaX}_2)$ . In the fluor-apatites the X is wholly F (fluorine); in the chlor-apatites it stands for (Cl), F, i. e., chlorine and fluorine coming up conjointly to two equivalents. See vol. xvi. p. 407.

**Phosphorites.**—Phosphorite is the name given to many impure forms of amorphous or massive apatite, modified more or less by disintegration. It occurs (a) in massive, irregular, corroded-looking nodules embedded in limestones or other kinds of soft rock near Amberg (Bavaria), in Baden, Württemberg, the Weser hills, and in the Teutoburger Wald, and contains from 40 to 80 per cent. of phosphate and up to 3 per cent. of fluoride of calcium; the phosphorite nodules in the sandstone of Kursk and Voronezh, the "South Carolina phosphate," and the "Lot phosphate" belong to the same category. It is met with (b) in more or less extensive beds, as "kidneys," as stalactites, or as a connective cement in breccias; such phosphorites, of which large quantities are found in the Lahn valley, generally contains only from 25 to 60 per cent. of phosphate of lime, and includes large percentages of clay or marl, and more or less of the phosphates of iron and alumina. Another variety is (c) black phosphorite slate. A deposit containing 20 per cent. of  $\text{P}_2\text{O}_5$  occurs in the Coal-measures of Hörde (Westphalia), also in Wales; an earthy deposit is found in the "braunkohle" of Pilgrimsreuth in the Fichtelgebirge. Phosphorite is also found (d) in veins, as a stone of very varying structure, generally intermixed with quartz,—for instance at Logrosan in Estremadura (65 to 80 per cent. of phosphate and up to 14 per cent. of fluoride of calcium), also in the Silurian slate of the Dniester.

**Coprolites.**—According to Buckland, coprolites are derived from the excrements of extinct animals. They consist of highly impure phosphate of lime. All native phosphates of calcium being fluoriferous, we need not wonder at the constant occurrence of traces of phosphates in the bones of vertebrate animals; the wonder is that the fluorine in these amounts to only .005 per cent.<sup>1</sup>

**Preparation.**—For the preparation of phosphates the oxide  $\text{P}_2\text{O}_5$  affords a natural starting-point. This substance is produced when phosphorus burns in an abundant supply of oxygen or air. Apparatus for the convenient execution of the process on a preparative scale are described in the handbooks of chemistry. Phosphoric anhydride forms a snow-white, loose, inodorous powder, which,

<sup>1</sup> Some books (Nickles) quote as high percentages as 1 or 1½, but these are based on erroneous analyses.

when heated in a hard glass tube to redness, sublimes slowly. It is extremely hygroscopic. When thrown into water it hisses like a red-hot iron and passes into the meta-acid, most of which, in spite of its abundant solubility, separates out as a sticky precipitate, which is rather slow in dissolving. It is the most energetic of all dehydrating agents; even sulphuric acid, when distilled with an excess of it, suffers dehydration, and passes into  $\text{SO}_3$ . The preparation is liable to be contaminated with red phosphorus and phosphorous anhydride ( $\text{P}_2\text{O}_3$ ), also with "white arsenic," because most commercial phosphorus, being made by means of pyrites-vitriol, is arseniferous. A freshly-prepared solution of the anhydride in water, being one of the meta-acid, coagulates albumen (as  $\text{HNO}_3$  does) and gives a white precipitate with nitrate of silver. But when the solution is allowed to stand, the dissolved meta-acid gradually passes into pyro-acid ( $\text{P}_2\text{O}_5 \cdot 2\text{H}_2\text{O}$ ), and this latter again gradually passes into ortho-acid ( $\text{P}_2\text{O}_5 \cdot 3\text{H}_2\text{O}$ ), the highest hydrate. At a boiling heat, especially if a little nitric acid be added, the whole of the dissolved  $\text{P}_2\text{O}_5$  is converted into ortho-acid in the course of one or two hours. The solution then does not coagulate albumen; it gives no precipitate with nitrate of silver unless the mixture be neutralized with an alkali, when a yellow precipitate of the salt  $\text{P}_2\text{O}_5 \cdot 3\text{Ag}_2\text{O}$  comes down. The aqueous ortho-acid, when evaporated at temperatures not exceeding  $160^\circ \text{C}$ ., and ultimately dried at this temperature, leaves its substance  $\text{P}_2\text{O}_5 \cdot 3\text{H}_2\text{O}$  as a thick syrup, which, when left to itself in a dry atmosphere, slowly freezes into crystals. At  $215^\circ \text{C}$ . the ortho-acid loses one-third of its water and becomes pyro-acid; at a red-heat it is reduced to a "glass" of meta-acid,  $\text{P}_2\text{O}_5 \cdot \text{H}_2\text{O}$ , which retains its water even at the highest temperatures. The substance known in pharmacy as "acidum phosphoricum glaciale" is very impure meta-acid.

**Ortho-Phosphoric Acid,  $\text{H}_3\text{PO}_4$ .**—The synthetic method described in the last paragraph is not so easy in practice as it appears on paper; hence it is generally preferred to prepare this substance by the oxidation of ordinary phosphorus with nitric acid. An acid of 1.2 specific gravity works best; weaker acids act too slowly; if stronger it may act with dangerous violence. One part of phosphorus is placed in a large tubulated retort, connected with an ordinary globular receiver, and treated therein, at a carefully regulated heat, with ten or twelve parts of the acid. When about half the acid has distilled over, it is poured back and the operation resumed and kept on until all the phosphorus is dissolved. The excess of nitric acid is then distilled over as far as conveniently possible and thus recovered. Towards the end of the distillation a fresh gas-evolution sets in through the conversion of previously produced phosphorous acid ( $\text{H}_3\text{PO}_3$ ) into phosphoric. The residual liquid in the retort is now poured out into a Berlin porcelain (or what is better, a platinum) basin, and, if it still contains phosphorous acid, fully oxidized by evaporation with occasional addition of strong nitric acid. Phosphorous acid, if present, is easily detected by the following tests: (1) its solution, when mixed with nitrate of silver and excess of ammonia, gives a black precipitate of metallic silver; (2) when heated with a solution of corrosive sublimate,  $\text{HgCl}_2$ , it produces a white precipitate of calomel,  $\text{Hg}_2\text{Cl}_2$ ; (3) when heated to boiling with excess of aqueous sulphurous acid it gives a precipitate of sulphur, or, if arsenious acid is present, of sulphide of arsenic. When the final oxidation is accomplished the acid needs only be freed of the remnant of nitric acid by repeated evaporation with water to be ready for use if arsenic be absent. As a rule, however, this impurity is present and must be removed by diluting the acid, passing in sulphuretted hydrogen first at  $70^\circ \text{C}$ ., and then in the cold, and allowing to stand for twenty-four hours, when all the arsenic is converted into sulphide, which, after elimination of the excess of sulphuretted hydrogen by continued exposure to air at a gentle heat, is filtered off. In practice, as a rule, the filtrate is being concentrated to some predetermined specific gravity and preserved as aqueous phosphoric acid, which preparation is official, and used besides for the cleansing of metallic surfaces, in lithography, and for other purposes. The British pharmacopoeia prescribes for the official acid a strength corresponding to 10 per cent. of  $\text{P}_2\text{O}_5$ .

Hager has published a complete table showing the dependence of the specific gravity, taken at  $17^\circ \text{C}$ ., on the strength of the acid. From it the following is extracted.

Spec. Grav.	Percentages of		Spec. Grav.	Percentages of	
	$\text{P}_2\text{O}_5$	$\text{H}_3\text{PO}_4$		$\text{P}_2\text{O}_5$	$\text{H}_3\text{PO}_4$
1.200	68.0	32.7	1.271	30.0	70.3
1.377	60.0	40.0	1.218	25.0	75.4
1.551	50.0	50.0	1.169	20.0	80.7
1.446	45.0	55.0	1.122	15.0	85.7
1.383	40.0	60.0	1.079	10.0	90.0
1.325	35.0	65.0	1.037	5.0	95.0

Aqueous phosphoric acid has all the properties of a decided acid, but, for a mineral acid, the exceptional qualities of an extremely sour taste and of non-poisonousness. Phosphoric is the only mineral acid which might be used as a condiment in place of vinegar.

or citric acid; but the writer is far from recommending the substitution. Professor Gaingee has made the very surprising discovery that meta-phosphoric and pyro-phosphoric, although so closely allied to ortho-phosphoric acid, are poisons, as phosphorous acid is.

Phosphoric acid readily combines with and neutralizes alkalis, even when these are given as carbonates. The concentrated acid, when heated in porcelain or glass, strongly attacks either material; hence its concentration ought always to be effected in platinum. In former times, when phosphorus was expensive, this acid, or rather an apology for the same, used to be prepared from bone-ash.

**Alkaline Phosphates.**—Of these the di-sodic salt is of the greatest practical importance. It is prepared by somewhat more than neutralizing the hot aqueous acid with carbonate of soda. A cheaper (manufacturing) process is to prepare a solution of "super-phosphate" from bone-ash by the action of vitriol, and, after elimination of the gypsum, to supersaturate the liquid with carbonate of soda and filter off the phosphate of lime produced (see p. 815 *supra*, where the process is explained indirectly). The salt, from sufficiently strong hot solutions, separates out in large transparent crystals of the composition  $\text{PO}_4\text{H}_2\text{Na}_2 + 12\text{H}_2\text{O}$ , which lose their crystal-water on exposure to dry air, even at ordinary temperatures, and very quickly at  $100^\circ\text{C}$ . The residue,  $\text{PO}_4\text{HN}_2 = \frac{1}{2}(\text{P}_2\text{O}_5 \cdot 2\text{Na}_2\text{O} \cdot \text{H}_2\text{O})$ , when heated to redness, loses its remnant of water and becomes pyro-phosphate, which latter retains its specific character on being dissolved in water. A solution of the (original) salt in water has a mild taste (hence its preferential application as a pleasant purgative); it colours red litmus-paper intensely blue, and does not act upon alkaline carbonate. But, when evaporated with the calculated proportion of carbonate of soda ( $\text{Na}_2\text{CO}_3$  per  $\text{P}_2\text{O}_5$ ) to dryness at, ultimately, a red heat, it yields a residue of tri-sodic salt ( $\text{PO}_4\text{Na}_3$ ) as a white mass, infusible at the highest temperature producible within a platinum crucible over a glass blowpipe. The solution of this salt in water has all the properties of a mixed solution of  $\text{PO}_4\text{Na}_2\text{H} + \text{NaOH}$ ; yet it is capable of depositing crystals of the composition  $\text{PO}_4\text{Na}_2 + 12\text{H}_2\text{O}$ . The mono-sodic salt ( $\text{PO}_4\text{H}_2\text{Na}$ ), producible by mixing together solutions containing the quantities  $\text{H}_2\text{PO}_4$  and  $\text{Na}_2\text{HPO}_4$ , is of no importance. Of the three *potash* salts, the mono-metallic salt ( $\text{PO}_4\text{KH}_2$ ) is the most readily produced. It forms beautiful anhydrous quadric crystals which at a red heat lose their  $\text{H}_2\text{O}$  and become meta-phosphate,  $\text{PO}_4\text{K}$ .

**Ammonia Salts.**—A strong solution of the acid, when supersaturated with ammonia, deposits on cooling crystals of the diammoniac salt  $\text{PO}_4(\text{NH}_2)_2\text{H}$ , liable to be contaminated with the mono-ammoniac salt. The tri-ammoniac salt is very unstable, and hardly known.

The double salt  $\text{PO}_4(\text{NH}_2)\text{NaH} + 4\text{H}_2\text{O}$  was known to the alchemists as "*sal microcosmicum urinae*," and is interesting historically as having served Brand as a raw material for the making of phosphorus. It is easily prepared, either by mixing the solution of the two quantities  $\text{PO}_4\text{Na}_2\text{HPO}_4$  and  $\text{PO}_4(\text{NH}_2)_2\text{HPO}_4$  together and allowing to crystallize, or by dissolving the former along with  $\text{NH}_4\text{Cl}$  parts of sal-ammoniac in water, and removing the chloride of sodium produced by crystallization *in the heat*. Microcosmic salt, when heated to redness, leaves a viscid glass of meta-phosphate of soda, which dissolves all basic metallic oxides pretty much as fused borax does, with formation of glasses which often exhibit colours characteristic of the dissolved oxides. Hence its application in blowpipe analysis.

**Phosphates of Lime.**—The normal salt  $\text{P}_2\text{O}_5 \cdot 3\text{CaO}$  or  $\text{PO}_4\text{Ca}_3$ , where  $\text{Ca} = \frac{1}{2}\text{Ca}$  = one equivalent of calcium, or perhaps a compound of it and carbonate of lime, forms the predominating component of bone-ash. A hydrate of the salt is produced by precipitating chloride of calcium solution with excess of ordinary phosphate of soda, mixed with enough of ammonia to produce (virtually) tri-alkaline salt, as a gelatinous precipitate similar in appearance and behaviour on filtration to precipitated alumina. A suspension of this precipitate in water, when mixed with a carefully adjusted quantity of hydrochloric acid, gradually passes into a mass of microscopic crystals of di-calcic salt,  $\text{PO}_4\text{Ca}_2\text{H} + x\text{Aq}$ , which latter is used medicinally. A solution of the di-calcic or tri-calcic salt, in the proper proportion of hot aqueous hydrochloric acid, deposits on cooling crusts of crystals of the mono-calcic salt  $\text{PO}_4\text{H}_2\text{Ca}$ , which is soluble in about 700 parts of cold water, but is decomposed, by hot water or by prolonged contact with a proportion of cold water insufficient to dissolve it, into free acid and a precipitate of di-calcic salt,  $2\text{PO}_4\text{CaH}_2 = \text{PO}_4\text{H}_2 + \text{PO}_4\text{Ca}_2\text{H}$ . A very impure form of this salt, known as "superphosphate," enters into the composition of many artificial manures. Such superphosphate is made industrially by treating broken-up bones, or powdered bone-ash, or powdered phosphorite, or coprolite, or occasionally apatite with chamber-acid, meaning vitriol of about 60 per cent., as it comes out of the chamber. The phosphate is mixed with the acid in a lead-lined trough by means of machinery, when a rather lively reaction sets in, involving the evolution of vapour of water mixed with hydrofluoric acid, and fluoride of silicon if mineral phosphates is used, possibly also with traces of fluoride or chloride of arsenic, and, in any case, with stinking volatile organic substances. The

vapour, therefore, must be removed by means of suitable draught arrangements. The mass passes from the trough into a (ventilated) chamber, where the reaction gradually accomplishes itself with ultimate formation of a porous friable mass, dry to the touch. This is superphosphate as it goes out into commerce or is used as an ingredient in making more complex manures. Its value is determined chiefly by its percentage of "soluble phosphoric acid," meaning the percentage of  $\text{P}_2\text{O}_5$  extractable as  $\text{PO}_4\text{H}_2$  or  $\text{PO}_4\text{CaH}_2$  by a certain large proportion of cold water. This percentage is liable to decrease on long-continued storing, especially in the case of mineral superphosphate, through a gradual formation of (or regeneration of originally present) phosphate of iron and alumina, partly, perhaps, also through the spontaneous decomposition of some of the mono-calcic salt into insoluble di-calcic salt and free acid. The portion of the  $\text{P}_2\text{O}_5$  which has thus become insoluble is designated "reduced" phosphoric acid. In regard to other phosphates than those named reference may be made to the handbooks of chemistry.

**Analysis.**—Phosphoric acid, when given in any form, *soluble in solution of ammonia*, can be detected and determined by "magnesia mixture" (a solution of chloride of magnesium and sal-ammoniac,  $\text{MgCl}_2 \cdot 2\text{NH}_4\text{Cl}$ , strongly alkalized by addition of aqueous ammonia). The phosphoric acid is very gradually, but at last completely, precipitated in microscopic crystals of the salt  $\text{PO}_4\text{MgNH}_4 + 6\text{H}_2\text{O}$ , which, though slightly soluble in water, can be washed pure, without loss, with dilute ammonia. All other acids except arsenic acid ( $\text{As}_2\text{O}_5$ )—which behaves like phosphoric, and, if present, must be removed by sulphuretted hydrogen—remain dissolved. The precipitate, when kept at a red heat, assumes the composition  $\text{P}_2\text{O}_5 \cdot 2\text{MgO}$ , and from the weight of the ignited precipitate that of the phosphoric acid present is easily calculated. Phosphates soluble in acids, and reprecipitated from their solutions as such by ammonia—as phosphate of lime or alumina, or ferric oxide—used to give great difficulties to the analysts until Sonnenschein founded an excellent quantitative method for their analysis upon a reaction discovered by Swanberg and Struve, which is explained under MOLYBDENUM (vol. xvi. p. 697). The phosphate is dissolved in nitric acid (hydrochloric is less to be recommended) and the solution mixed, and kept for some hours at  $40^\circ\text{C}$ , with a large excess of a solution of molybdate of ammonia in excess of nitric acid. The phosphoric acid (along with any arsenic acid that may be present) comes down as yellow crystalline phospho-molybdate of ammonia, soluble in phosphoric acid and slightly in water, but insoluble in *dilute* nitric acid in the presence of a sufficiency of nitrate of ammonia. The precipitate is soluble in aqueous ammonia, and from the solution its  $\text{P}_2\text{O}_5$  can be precipitated by magnesia mixture as above explained. Neither of the two methods applies directly to meta-phosphates or pyro-phosphates. Regarding these, see the last paragraph of the section "phosphorus" above. (W. D.)

**PHOTIUS**, patriarch of Constantinople from 857 to 867 and again from 877 to 886 A.D., the most eminent literary and ecclesiastical character of his age, was probably born between 820 and 825. If we could credit the assertions of his adversaries, his father, an official of the imperial court, named Sergius, was of heathen extraction, and his mother, Irene, a faithless nun. It is more certain that he displayed from an early age the most extraordinary talent and appetite for knowledge, and that, having mastered whatever Greek literature could give him (Latin and Hebrew he never acquired), he began to teach with distinguished success grammar, rhetoric, divinity, and philosophy. The way to public life was probably opened for him by the brilliant marriage of his maternal uncle to the princess Irene, sister of the empress Theodora, who, upon the death of her husband Theophilus in 842, had assumed the regency of the empire. Photius became captain of the guard and subsequently first imperial secretary. Somewhere about 850 he was entrusted with a mission to the "Assyrians," by whom the Saracens must be meant, possibly to the court of the caliph of Baghdad. Just previous to his departure on this mission he compiled his *Bibliotheca*, or *Myriobiblion*, the noblest monument of his erudition, and, from the number of classical authors whose writings it has partially preserved, by much the most important of his works.

Some time after his return from this embassy an unexpected path was opened to Photius's ambition by the dissensions between the patriarch Ignatius and Bardas, the uncle of the youthful emperor Michael III., who had succeeded to the regency on the disgrace of Theodora. Ignatius,

a man of austere morals and apparently not exempt from spiritual pride, had excommunicated Bardas on the ground of an alleged incestuous connexion with his daughter-in-law. Bardas retorted by an accusation of a conspiracy. Ignatius was arrested and imprisoned (November 857), and upon his refusing to resign was illegally deposed, when Photius, receiving all the necessary sacerdotal orders within six days, was installed as patriarch in his place. This sudden elevation of a layman to the highest ecclesiastical office could not but provoke scandal, even though the laic, as was actually the case, might be the first theologian of his age. Ignatius, continuing to refuse the abdication which could alone have given it a semblance of legality, was treated with extreme severity, and a violent persecution broke out against his adherents. Photius urged clemency in his epistles to Bardas, probably with sincerity, but shrunk from taking the only step which could have effectually repressed the persecution and healed the schism,—the resignation of the patriarchate. In judging his conduct, however, two circumstances have to be borne in mind,—the fact that the party of Ignatius dwindled away so rapidly as to flatter Photius with the hope of its extinction, and the espousal of his competitor's cause by Nicholas, bishop of Rome, in a manner highly offensive to the independent feeling of the Eastern Church. Photius felt himself the champion of Eastern Christianity against Latin pretensions; and, when in 863 Nicholas finally anathematized and deposed him, he replied by a counter-excommunication. He also sought to ally himself with Western bishops who had been displaced or suspended by the arrogant Nicholas, and with the latter's secular adversaries, while at the same time he was more honourably engaged in endeavours to reunite the Armenians to the Eastern Church, in combating the Paulicians, and in successful missions to the Russians and Bulgarians. While these transactions were proceeding the situation was suddenly changed by the murder of Photius's patron, Caesar Bardas, by order of the emperor Michael, who was himself assassinated by his colleague Basil in the following year (867). The fall of Photius immediately ensued, but the attendant circumstances are exceedingly obscure. According to Georgius Hamartolus, or rather his continuator, the cause was Photius's stern reproof of the crime by which Basil had obtained the throne. As the only definite testimony of any kind, this statement cannot be wholly disregarded, but it is certainly difficult to reconcile it with the general suppleness of Photius in his relations with the Byzantine court. Whatever the cause, Photius was removed from his office and banished about the end of September 867, a few days after the accession of Basil, and the deposed Ignatius, brought back from his exile, was reinstated on 23d November. The convocation of a general council followed, to give the restoration of Ignatius a character of indisputable legality. This synod, regarded by the Latins as the eighth oecumenical council, but rejected as such by the Greeks, met in October 869. The attendance of Eastern bishops was relatively very small; Photius's friends and creatures generally remained faithful to him; and the ostentatious patronage of Pope Hadrian must have been irritating to the Orientals. Photius, when brought before the assembly, maintained a dignified silence, which perplexed his accusers, but could not avert his condemnation. It seems, nevertheless, to have been generally felt that the proceedings of the council were entitled to little moral weight. The usurper, for such he unquestionably was, had successfully identified himself with the cause of his church and nation. In his captivity, which, notwithstanding his complaints, the extent of his correspondence proves to have been mild, he maintained the same unbending spirit, and rejected all overtures of compromise. About

876 he was suddenly recalled to Constantinople and entrusted with the education of Basil's children. A tale of his having regained favour by forging an illustrious genealogy for the upstart emperor may be dismissed without hesitation as an invention of his enemies. The cause was in all probability Basil's recognition of the fact that he had disgraced and banished the ablest man in his dominions, and the best qualified to fill the patriarchate upon the decease of the aged Ignatius. This event soon occurred, probably in October 877, and after a decent show of reluctance Photius again filled the patriarchal throne. According to his own account, which there seems no reason to discredit, he had become fully reconciled to his predecessor, and had shown him much kindness. Photius now proceeded to obtain the formal recognition of the Christian world. In November 879 a synod, considered by the Greeks as the eighth oecumenical council, and far more numerous attended than the one by which he had been deposed, was convened at Constantinople. The legates of Pope John VIII attended, prepared to acknowledge Photius as legitimate patriarch, a concession for which John was so much censured by Latin opinion that Baronius rather fancifully explains the legend of Pope Joan by the contempt excited by his want of spirit. John, however, was firm on the other two points which had long been contested between the Eastern and Western Churches, the ecclesiastical jurisdiction over Bulgaria and the introduction of the "filioque" clause into the creed. He disowned his legates, who had shown a tendency to yield, again excommunicated Photius, and thus kindled smouldering ill-will into the open hostility which has never been appeased to this day. Strong in the support of the council, Photius simply ignored him. He has been accused of interpolating John's letters, a charge not improbable in itself, but which can neither be proved nor disproved at this date. At the height of glory and success he was suddenly precipitated from his dignity by another palace revolution. Archbishop Theodore Saba-baren, his confidant and favourite, had accused Basil's son, Leo, of a conspiracy against his father. Leo owed his liberty and eyesight to Photius's entreaties; nevertheless, on his accession in 886, he involved his benefactor in the ruin of his accuser. Arrested, degraded from the patriarchate, banished to the monastery of Bordi in Armenia, Photius, as if by magic, disappears from history. No letters of this period of his life are extant, which leads to the inference that his imprisonment was severe. The precise date of his death is not known, but it is said to have occurred on 6th February 891.

For long after Photius's death his memory was held in no special honour by his countrymen. His literary merits were obscured by the growing barbarism of the times, and the anarchy and apparent decrepitude of the Roman Church made his protest against its pretensions seem superfluous. But, when, in the crusading age, the Greek Church and state were alike in danger from Latin encroachments, Photius became a national hero, and is at present regarded as little short of a saint. To this character he has not the least pretension. Few men, it is probable, have been more atrociously calumniated; but, when every specific statement to his prejudice has been rejected, he still appears on a general review of his actions worldly, crafty, and unscrupulous. Yet, however short he may fall of the standard of an Athanasius or a Luther, he shows to no little advantage when regarded as an ecclesiastical statesman. His firmness was heroic, his sagacity profound and far-seeing; he supported good and evil fortune with equal dignity; and his fall was on both occasions due to revolutions beyond his control. If his original elevation to the patriarchate was unquestionably irregular, his re-enthronement was no less certainly legal; he began as a usurper and ended as a patriot. His zeal for the promotion of learning, education, and missions was most genuine, and fruitful in good. In erudition, literary power, and force and versatility of intellect he far surpassed every contemporary. The records of his actions are so imperfect or so prejudiced that in endeavouring to judge his personal character we have to rely principally upon the internal evidence of his own letters. With every allowance for their *ex parte* and rhetorical character and the writer's manifest desire to display

himself in the most favourable light, they nevertheless seem to afford sufficient testimony of a magnanimous spirit and a feeling heart.

The most important of the works of Photius is his renowned *Myriobiblion*, a collection of extracts from and abridgments of 280 volumes of classical authors, the originals of which are now to a great extent lost. Dictated in haste immediately before his departure on his Eastern embassy, it is open to the charges of imperfect recollection and hasty criticism, but these are as nothing in comparison with its merits. It is especially rich in extracts from historical writers. To Photius we are indebted for almost all we possess of Ctesias, Memnon, Canon, the lost books of Diodorus Siculus, and the lost writings of Arrian. Theology and ecclesiastical history are also very fully represented. The best edition is Bekker's (Berlin, 1824-25), which, however, has neither notes nor a Latin version. The next of his works in importance is the *Amphilochia*, a collection of 333 questions and answers on difficult points in Scripture, addressed to Amphilochius, archbishop of Cyprius. This valuable work has exposed Photius to charges of plagiarism, which, as he does not claim entire originality, are wholly undeserved. The only complete edition is that published by Sophocles Oeconomus at Athens in 1858. Photius is further

author of a *Lexicon* (London, 1822), of a *Nomocanon* or harmony of the ecclesiastical canons with the imperial edicts relating to the discipline of the church, a work of great authority, but based on the labours of his predecessors, and of numerous theological writings. The more important of these are his treatise *Against the Pавлиtians*, in four books, and his controversy with the Latins on the procession of the Holy Spirit. His *Epistles* are valuable from their contents, but the style is often affected or unsuitable to the subject. The most complete edition is Valetta's (London, 1864). Many of Photius's works yet remain in manuscript. The only complete edition is Bishop Malou's in Migne's *Patrologia Græca*, and this is very imperfect and unsatisfactory.

After the allusions in his own writings the chief contemporary authority for the life of Photius is his bitter enemy Nicetas the Paphlagonian, the biographer of his rival Ignatius. In modern times his life has been written with great prejudice and animosity by Baronius, and by Weguolin in the *Memoirs of the Berlin Academy*, and more fairly by Hankins (*De Byzantinorum Rerum Scriptura*, pt. 1). But all previous writers are superseded by the classical work of Cardinal Hergenrother, *Photius, Patriarch von Constantinopel* (3 vols., Ratisbon, 1867-69). As a dignitary of the Roman Catholic Church Cardinal Hergenrother is inevitably biased against Photius as an ecclesiastic, but his natural candour and sympathy with intellectual eminence have made him just to the man, while his investigation of all purely historical and literary questions is industrious and exhaustive in the highest degree. (R. G.)

## PHOTOGRAPHY

IT would be somewhat difficult to fix a date when what we now know as "photographic action" was first recorded. No doubt the tanning of the skin by the sun's rays was what was first noticed, and this is as truly the effect of solar radiation as is the darkening of the sensitive paper which is now in use in photographic printing operations. We may take it that Scheele, the Swedish chemist, was the first to enter upon a scientific investigation of the darkening action of sunlight on silver chloride. He found by experiment that when silver chloride was exposed to the action of light beneath water there was dissolved in the fluid a substance which, on the addition of caustic (silver nitrate), caused the precipitation of new silver chloride, and that on applying liquor ammonia to the blackened chloride an insoluble residue of metallic silver was left behind. He also noticed that of the rays of the spectrum the violet most readily blackened the silver chloride. In Scheele, then, we have the first who applied combined chemical and spectrum analysis to the science of photography. Senebier repeated Scheele's experiments, and found that in fifteen seconds the violet rays blackened silver chloride as much as the red rays did in twenty minutes.<sup>1</sup> About twenty years later than Scheele's experiments Count Rumford contributed a paper to the *Philosophical Transactions of the Royal Society* (1798) entitled "An inquiry concerning the chemical properties that have been attributed to light," in which he tried to demonstrate that all effects produced on metallic solutions could be brought about by a temperature somewhat less than that of boiling water. Robert Harpur in 1802, however, conclusively showed in *Nicholson's Journal* that, at all events, salts of mercury were reduced by visible radiation and not by change of temperature. In 1801 we come to the next decided step in the study of photographic action, when Ritter proved the existence of rays lying beyond the violet limit of the spectrum, and found that they had the power of blackening silver chloride. Such a discovery naturally gave a direction to the investigations of others, and Seebeck (between 1802 and 1808) and Bérard turned their attention to this particular subject, eliciting information which at the time was of a valuable nature. We need only mention two or three other cases where the influence of light was noticed at the beginning of this century. Wollaston observed the conversion of yellow gum guaiacum into a green tint by the violet rays, and the restoration of the colour by the red rays,—both of which, he it observed,

are the effect of absorption of light, the original yellow colour of the gum absorbing the violet rays, whilst the green colour to which it is changed absorbs the red rays. Davy found that puce-coloured oxide of lead, when damp, became red in the red rays, whilst it blackened in the violet rays, and that the green oxide of mercury became red in the red rays,—again an example of the necessity of absorption to effect a molecular or chemical change in a substance. Desmottians in 1801 observed the change effected in Prussian blue, and Bockman noted the action of the two ends of the spectrum on phosphorus, a research which, it may be mentioned, Draper extended further in America at a later date.

To England belongs the honour of first producing a photograph by the utilization of Scheele's observations on chloride of silver. In June 1802 Wedgwood published in the *Journal of the Royal Institution* the paper—"An account of a method of copying paintings upon glass and of making profiles by the agency of light upon nitrate of silver, with observations by H. Davy." He remarks that white paper or white leather moistened with a solution of nitrate of silver undergoes no change when kept in a dark place, but on being exposed to the daylight it speedily changes colour, and, after passing through various shades of grey and brown, becomes at length nearly black. The alteration of colour takes place more speedily in proportion as the light is more intense.

"In the direct beam of the sun two or three minutes are sufficient to produce the full effect, in the shade several hours are required, and light transmitted through different-coloured glasses acts upon it with different degrees of intensity. Thus it is found that red rays, or the common sunbeams passed through red glass, have very little action upon it; yellow and green are more efficacious, but blue and violet light produce the most decided and powerful effects."

Wedgwood then goes on to describe the method of using this prepared paper by throwing shadows on it, and inferentially by what we now call "contact printing." He states that he has been unable to fix his prints, no washing being sufficient to eliminate the traces of the silver salt which occupied the unexposed or shaded portions. Davy in a note states that he has found that, though the images formed by an ordinary camera obscura were too faint to print out in the solar microscope, the images of small objects could easily be copied on such paper.

"In comparing the effects produced by light upon muriate of silver (silver chloride) with those upon the nitrate it seemed evident that the muriate was the most susceptible, and both were more readily acted upon when moist than when dry—a fact long ago known. Even in the twilight the colour of the moist muriate of silver, spread upon paper, slowly changed from white to faint

<sup>1</sup> It may here be remarked that had he used a pure spectrum he would have found that the red rays did not blacken the material in the slightest degree.

violet: though under similar circumstances no intermediate alteration was produced upon the nitrate. . . . Nothing but a method of preventing the unshaded parts of the delineations from being coloured by exposure to the day is wanting to render this process as useful as it is elegant."

In this method of preparing the paper lies the germ of the silver-printing processes which are practised at the present time (1834), and it was only by the spread of chemical knowledge that the hiatus which was to render the "process as useful as it is elegant" was filled up—when hyposulphite of soda, discovered by Chaussier in 1799, or three years before Wedgwood published his paper, was used for making the print permanent. Here we must call attention to an important observation by Dr Seebeck of Jena in 1810. In the *Farbenlehre* of Goethe he says:

"When a spectrum produced by a properly constructed prism is thrown upon moist chloride of silver paper, if the printing be continued for from fifteen to twenty minutes, whilst a constant position for the spectrum is maintained by any means, I observe the following. In the violet the chloride is a reddish brown (sometimes more violet, sometimes more blue), and this coloration extends well beyond the limit of the violet; in the blue the chloride takes a clear blue tint, which fades away, becoming lighter in the green. In the yellow I usually found the chloride unaltered; sometimes, however, it had a light yellow tint; in the red and beyond the red it took a rose or lilac tint. This image of the spectrum shows beyond the red and the violet a region more or less light and uncoloured. This is how the decomposition of the silver chloride is seen in this region. Beyond the brown band, . . . which was produced in the violet, the silver chloride was coloured a grey-violet for a distance of several inches. In proportion as the distance from the violet-increased, the tint became lighter. Beyond the red, on the contrary, the chloride took a feeble red tint for a considerable distance. When moist chloride of silver, having received the action of light for a time, is exposed to the spectrum, the blue and violet behave as above. In the yellow and red regions, on the other hand, it is found that the silver chloride becomes paler; . . . the parts acted upon by the red rays and by those beyond take a light coloration."

This has been brought prominently forward by Dr J. M. Eder as being undoubtedly the first record we have of photographic action lending itself to production of natural colours, a fact which, in describing the history of photographic phenomena, has been more or less overlooked. We shall see later on that this observation of Seebeck was allowed to lie fallow for many years, until it was again taken up and published as a novelty. In photography perhaps, above all other technical applications of science, there has been a great flood of rediscovery, owing, no doubt, in the first instance to the fact that much published in one country has remained unknown in others, and also to the fact that it is difficult to boil down photographic literature and to ascertain what is really scientifically true and what is merely the result of unscientific use of the imagination. Photography has suffered greatly also from the fact that those who follow it are usually artists rather than scientific men, and fall into mistakes of theory which must of necessity lead to wrong conclusions.

The first to found a process of photography which gave pictures that were subsequently unaffected by light was Nicéphore de NIÉPCE (*q.v.*). His process, which he called provisionally "héliographie, dessins, et gravures," consists in coating the surface of a metallic plate with a solution of asphaltum in oil of lavender and exposing it to a camera image. In his description he recommends that the asphaltum be powdered and the oil of lavender dropped upon it in a wine-glass, and that it be then gently heated. A polished plate is covered with this varnish, and, when dried, is ready for employment in the camera. After requisite exposure, which is very long indeed, a very faint image, requiring development, is seen. Development is effected by diluting oil of lavender with ten parts by volume of white petroleum. After this mixture has been allowed to stand two or three days it becomes free from turbidity and is ready to be used. The plate is placed in a dish

and covered with the solvent. By degrees the parts unaffected by light dissolve away, and the picture, formed of modified asphaltum, is developed. The plate is then lifted from the dish, as much as possible of the solvent being allowed to drain away. It is next placed on an inclined support and carefully freed from all the remaining solvents by washing in water. Subsequently, instead of using oil of lavender as the asphaltum solvent, Niepce employed an animal oil, which gave a deeper colour and more tenacity to the surface-film than did his original agent.

Later still, Daguerre and Niepce used as a solvent the brittle residue obtained from evaporating the essential oil of lavender dissolved in ether or alcohol,—a transparent solution of a lemon-yellow colour being formed. This solution was used for covering glass or silver plates, which, when dried, could be used in the camera. The time of exposure varied somewhat in length. Daguerre remarked that "the time required to procure a photographic copy of a landscape is from seven to eight hours, but single monuments, when strongly lighted by the sun, or which are themselves very bright, can be taken in about three hours." Perhaps there is no sentence which could be quoted that illustrates more forcibly the advance made in photography from the days when this process was described. The ratio of three hours to  $\frac{1}{175}$ th of a second is a fair estimate of the progress made since Niepce. The development was conducted by means of petroleum-vapour, which dissolved the parts not acted upon by light. As a rule silver plates seem to have been used, and occasionally glass; but it does not appear whether the latter material was chosen because an image would be projected through it or whether simply for the sake of effect. Viewed in the light of present knowledge, a more perfectly developable image in half-tone would be obtained by exposing the film through the *back* of the glass. The action of light on most organic matter is apparently one of oxidation. In the case of asphaltum or bitumen of Judaea the oxidation causes a hardening of the material and an insolubility in the usual solvents. Hence that surface of the film is generally hardened first which first feels the influence of light. Where half-tones exist, as in a landscape picture, the film remote from the surface first receiving the image is not acted upon at all, and remains soluble in the solvent. It is thus readily seen that, in the case of half-tone pictures, or even in copying engravings, if the action were not continued sufficiently long when the surface of the film farthest from the glass was first acted upon, the layer next the glass would in some places remain soluble, and on development would be dissolved away, carrying the top layer of hardened resinous matter with it, and thus give rise to imperfect pictures. In carbon-printing development from the back of the exposed film is absolutely essential, since it depends on the same principles as does heliography, and in this the same mode of procedure is advisable. It would appear that Niepce began his researches as early as 1814, but it does not appear that he was very successful in his first endeavours: it was not till 1827 that he had any success worth recounting. At that date he communicated a paper to Dr Bauer of Kew, the secretary of the Royal Society of London, with a view to its presentation to that society. Its publication, however, was prevented because the process, of which examples were shown, was a secret one. There lies before the present writer an authentic MS. copy of Niepce's "Mémoire," dated "Kew, le 8 Décembre 1827," in which he says it will be found that "in his framed drawings made on tin the tone is too feeble, but that by the use of chemical agents the tone may be darkened." This shows that Niepce was familiar with the idea of using some darkening medium even with his photographs taken on tin plates.



*Daguerreotype*.—We have already noticed in the joint process of Daguerre and Niepce that polished silver plates were used, and we know from the latter that amongst the chemical agents tried iodine suggested itself. Iodine vapour or solution applied to a silvered plate would cause the formation of silver iodide on those parts not acted upon by light. The removal of the resinous picture would leave an image formed of metallic silver, whilst the black parts of the original would be represented by the darker silver iodide. This was probably the origin of the daguerreotype process. Such shrewd observers as Niepce and Daguerre, who had formed a partnership for prosecuting their researches, would not have thus formed iodide of silver without noticing that it changed in colour when exposed to the light. What parts respectively Daguerre and Niepce played in the development of the daguerreotype, which we shall shortly describe, will probably never be known with absolute accuracy, but in a letter from Dr Bauer to Dr Bennett, F.R.S., dated 7th May 1839, the former says:

"I received a very interesting letter from Mons. Isidore Niepce, dated 12th March [about a month after the publication of the daguerreotype process], and that letter fully confirms what I suspected of Daguerre's manœuvres with poor Nicéphore, but Mr Isidore observes that for the present that letter might be considered confidential."

Dr Bauer evidently knew more of "poor Nicéphore's" work than most people, and at that early period he clearly thought that an injustice had been done to Niepce at the hands of Daguerre. It should be remarked that Nicéphore de Niepce died in 1833, and a new agreement was entered into between his son Isidore de Niepce and Daguerre to continue the prosecution of their researches. It appears further that Niepce communicated his process to Daguerre on 5th December 1829. At his death some letters from Daguerre and others were left by him in which the use of iodine, sulphur, phosphorus, &c., is mentioned as having been used on the metal plates, and their sensitiveness to light, when thus treated, commented upon. We are thus led to believe that a great part of the success in producing the daguerreotype is due to the elder Niepce; and indeed it must have been thought so at the time, since, on the publication of the process, life-pensions of 6000 francs and 4000 francs were given to Daguerre and to Isidore Niepce respectively. In point of chronology the publication of the discovery of the daguerreotype process was made subsequently to the Talbot-type process. It will, however, be convenient to continue the history of the daguerreotype, premising that it was published on 6th February 1839, whilst Talbot's process was given to the world on 25th January of the same year.

Daguerreotype pictures were originally taken on silver-plated copper, and even at the present day the silvered surface thus prepared serves better than electro-deposited silver of any thickness. An outline of the operations is as follows. A brightly-polished silver plate is cleaned by means, first of finely-powdered pumice and olive oil then of dilute nitric acid, and a soft buff is employed to give it a brilliant polish, the slightest trace of foreign matter or stain being fatal to the production of a perfect picture. The plate, thus prepared, is ready for the iodizing operation. Small fragments of iodine are scattered over a saucer, covered with gauze. Over this the plate is placed, face downwards, resting on supports, and the vapour from the iodine is allowed to form upon it a surface of silver iodide, which is the sensitive compound. It is essential to note the colour of the surface-formed iodide at its several stages, the varying colours being due to interferences caused by the different thicknesses of the minutely thin film of iodide of silver. The stage of maximum sensitiveness is obtained when it is of a golden orange colour. In this

state the plate is withdrawn and removed to the dark slide of the camera, ready for exposure. A plan frequently adopted to give an even film of iodide was to saturate a card with iodine and hold the plate a short distance above the card. Long exposures were required, varying in Paris from three to thirty minutes. The length of the exposure was evidently a matter of judgment, more particularly as over-exposure introduced an evil which was called "solarization," but which was in reality due to the oxidation of the iodide, itself altered by prolonged exposure to light. As a matter of history it may be interesting to remark that the development of the image by means of mercury vapour is said to be due to a chance discovery of Daguerre. It appears that for some time previous to the publication of the daguerreotype method he had been experimenting with iodized silver plates, producing images by what would now be called the "printing out" process. This operation involved so long an exposure that he sought some means of reducing it by the application of different reagents. Having on one occasion exposed such a plate to a camera-image, he accidentally placed it in the dark in a cupboard containing various chemicals, and found after the lapse of a night that he had a perfect image developed. By the process of exhaustion he arrived at the fact that it was the mercury-vapour, which even at ordinary temperatures volatilizes, that had caused this intensification of the almost invisible camera-image. It was this discovery that enabled the exposures to be very considerably shortened from those which it was found necessary to give in mere camera-*printing*. The development of the image was effected by placing the exposed plate over a slightly heated (about 75° C.) cup of mercury. The vapour of mercury condensed on those places where the light had acted in an almost exact ratio to the intensity of its action. This produced a picture in an amalgam of mercury, the vapour of which attached itself to the altered iodide of silver. Proof that such was the case was subsequently afforded by the fact that the mercurial image could be removed by heat. The developing box was so constructed that it was possible to examine the picture through a yellow glass window whilst the image was being brought out. The next operation was to fix the picture by dipping it in a solution of hyposulphite of soda. The image produced by this method is so delicate that it will not bear the slightest handling, and has to be protected from accidental touching.

The first great improvement in the daguerreotype process was the resensitizing of the iodized film by bromine vapour. Mr Goddard published his account of the use of bromine in conjunction with iodine in 1840, and M. Claudet employed a combination of iodine and chlorine vapour in 1841. In 1844 Daguerre published his improved method of preparing the plates, which is in reality based on the use of bromine with iodine. That this addition points to additional sensitiveness will be readily understood when we remark that so-called instantaneous pictures of yachts in full sail, and of large size, have been taken on plates so prepared,—a feat which is utterly impossible with the original process as described by Daguerre. The next improvement to be noticed in the process was toning or gilding the image by a solution of gold, a practice introduced by M. Fizeau. Gold chloride is mixed with hyposulphite of soda, and the levelled plate, bearing a sufficient quantity of the fluid, is warmed by a spirit-lamp until the required vigour is given to the image, as a consequence of which it is better seen in most lights. Nearly all the daguerreotypes extant have been treated in this manner, and no doubt their permanence is in a great measure due to this operation. Images of this class can be copied by taking electrotypes from them, as shown by Grove and others. These reproductions are admirable in every way, and furnish a posi-

tive proof, if any were needed, that the daguerrean image is a relief.

*Fox-Talbot Process.*—In January 1839 Fox Talbot described the first of his processes, photogenic drawing, in a paper to the Royal Society. He states that he began experimenting in 1834, and that in the solar microscope he obtained an outline of the object to be depicted in full sunshine in half a second. We must turn, however, to the *Philosophical Magazine* for the account of the full details of his method, which consisted essentially in soaking paper in common salt, brushing one side only of it with about a 12 per cent. solution of silver nitrate in water, and drying at the fire. Fox Talbot stated that by repeating the alternate washes of the silver and salt—always ending, however, with the former—greater sensitiveness was attained. This is the same in every respect as the method practised by Wedgwood in 1802; but, when we come to the next process, which he called "calotype" or "beautiful picture," we have a distinct advance. This process Talbot protected by a patent in 1841. It may be briefly described as the application of iodide of silver to a paper support. Carefully-selected paper was brushed over with a solution of silver nitrate (100 grains to the ounce of distilled water), and dried by the fire. It was then dipped into a solution of potassium iodide (500 grains being dissolved in a pint of water), where it was allowed to stay two or three minutes until silver iodide was formed. In this state the iodide is scarcely sensitive to light, but is sensitized by brushing "gallo-nitrate of silver" over the surface to which the silver nitrate had been first applied. This "gallo-nitrate" is not a chemical compound, but merely a mixture, consisting of 100 grains of silver nitrate dissolved in 2 oz. of water, to which is added one-sixth of its volume of acetic acid, and immediately before applying to the paper an equal bulk of a saturated solution of gallic acid in water. The prepared surface is then ready for exposure in the camera, and, after a short insolation in the dark, develops itself, or the development may be hastened by a fresh application of the "gallo-nitrate of silver." The picture is then fixed by washing it in clean water and drying slightly in blotting paper, after which it is treated with a solution of potassium bromide, and again washed and dried. Here there is no mention made of hyposulphite of soda as a fixing agent, that having been first used by Sir J. Herschel in February 1840. In a strictly historical notice it ought to be mentioned that development by means of gallic acid and nitrate of silver was first known to Rev. J. B. Reade. When impressing images in the solar microscope he employed gallic acid and silver in order to render more sensitive the chloride of silver paper that he was using, and he accidentally found that the image could be developed without the aid of light. The priority of the discovery was claimed by Fox Talbot; and his claim was sustained after a lawsuit, apparently on the ground that Reade's method had never been legally published. It would be beyond the scope of the present article to give the slight improvements which Talbot afterwards made in the process. In one of his patents he recognizes the value of the proper fixing of his photogenic drawings by the use of hyposulphite of soda, and also the production of positive prints from the calotype negatives. We pass over his application of albumen to porcelain and its subsequent treatment with iodine vapour, as also his application of albumen in which iodide of silver was held in suspension to a glass plate, since in this he was undoubtedly preceded by Niepce de St Victor in 1848.

*Albumen Process on Glass.*—It was a most decided step in advance when Niepce de St Victor, a nephew of Nicéphore de Niepce, employed a glass plate and coated it with iodized albumen. The originator of this method did not

meet with much success. In the hands of M. Blanquet Évrard it became more practicable; but it was carried out in its greatest perfection by M. Le Gray. The outline of the operations is as follows. The whites of five fresh eggs are mixed with about one hundred grains of potassium iodide, about twenty grains of potassium bromide, and ten grains of common salt. The mixture is beaten up into a froth with an egg-whisk or fork, and allowed to settle for twenty-four hours, when the clear liquid is decanted off. A circular pool of albumen is poured on a glass plate, and a straight ruler (its ends being wrapped with waxed paper to prevent its edge from touching the plate anywhere except at the margins) is drawn over the plate, sweeping off the excess of albumen, and so leaving an even film. The plate is first allowed to dry spontaneously, a final heating being given to it in an oven or before the fire. The heat hardens the albumen, and it becomes insoluble and ready for the nitrate of silver bath. One of the difficulties is to prevent crystallization of the salts held in solution, and this can only be effected by keeping them in defect rather than in excess. The plate is sensitized for five minutes in a bath of nitrate of silver, acidified with acetic acid, and exposed whilst still wet, or it may be slightly washed and again dried and exposed whilst in its desiccated state. The image is developed by gallic acid in the usual way. After the application of albumen many modifications were introduced in the shape of starch, serum of milk, gelatin, all of which were intended to hold iodide *in situ* on the plate; and the development in every case seems to have been by gallic acid. At one time the waxed-paper process subsequently introduced by Le Gray was a great favourite. Paper that had been made translucent by white wax was immersed in a solution of potassium iodide until impregnated with it, after which it was sensitized in the usual way, development being by gallic acid. This procedure is still followed in some meteorological observatories for obtaining transparent magnetograms, barograms, &c. Reflexion will show that in images obtained by this process the high lights are represented by metallic silver, whilst the shadows are translucent. Such a print is technically called a "negative." When chloride of silver paper is darkened by the passage of light through a negative, we get the highest lights represented by white paper and the shadows by darkened chloride. A print of this kind is called a "positive."

*Collodion Process.*—A great impetus was given to photography in 1850, rendering it easy of execution and putting it into the hands of the comparatively untrained. This was the introduction of collodion, a vehicle which up to the present day holds its own against the more rapid processes on account of the facility with which the plates are prepared, and also because it is a substance totally unaffected by silver nitrate, which is not the case when any organic substance is employed, and, it may be said, inorganic as well in many instances. Thus albumen forms a definite silver compound, as do gelatin, starch, and gum. The employment of collodion for use in photography was first suggested by Le Gray, who has been already mentioned in connexion with the albumen process. He does not appear to have gone beyond suggestion, and it remained for Archer of London, closely followed by Fry, to make a really practical use of the discovery. Collodion is a solution of cotton or cellulose in which some atoms of its hydrogen have been replaced by NO<sub>2</sub> by treatment with a more or less dilute mixture of sulphuric and nitric acids. The action of the sulphuric acid is to take up the molecules of water formed by elimination of the hydrogen from the cotton, which combines with oxygen from the nitric acid, the latter acid supplying the cotton with NO<sub>2</sub>. According to the temperature of the acids and

their dilution a tri-nitro or di-nitro cellulose is said to be formed, one of which is the explosive gun-cotton, insoluble in ether and alcohol, whilst the other, though inflammable, is readily soluble in a mixture of these two solvents. When collodion is poured on a glass plate it leaves on drying a hard transparent film which under the microscope is slightly reticulated. Before drying, the film is gelatinous and perfectly adapted for holding *in situ* salts soluble in ether and alcohol. Where such salts are present they crystallize out when the film is dried, hence such a film is only suitable where the plates are ready to be immersed in the silver bath. As a rule, about five grains of the soluble cotton are dissolved in an ounce of a mixture of equal parts of ether and alcohol, both of which must be of low specific gravity, '725 and '805 respectively. If the alcohol or ether be much diluted with water the cotton (pyroxylin) precipitates, but, even if less diluted, it forms a film which is "crapey" and uneven. Such was the material with which Le Gray proposed to work, and which Archer actually brought into practical use. The opaque silver plate with its one impression was abandoned; and the paper support of Talbot, with its inequalities of grain and thickness, followed suit, though not immediately. When once a fine negative had been obtained with collodion on a glass plate—the image showing high lights by almost complete opacity and the shadows by transparency (as was the case, too, in the calotype process)—any number of impressions could be obtained by means of the silver-printing process introduced by Fox Talbot, and they were found to possess a delicacy and refinement of detail that certainly eclipsed the finest print obtained from a calotype negative. To any one who had practised the somewhat tedious calotype process, or the waxed-paper process of Le Gray with its still longer preparation and development, the advent of the collodion method must have been extremely welcome, since it effected a saving in time, money, and uncertainty. The rapidity of photographic action was much increased, and the production of pictures became possible to hundreds who previously had been excluded from this art-science by force of circumstances. We can merely give an outline of the procedure, referring the reader for further information to the manuals of photography. A glass plate is carefully cleaned by the application of a detergent such as a cream of tripoli powder or spirits of wine (to which a little ammonia is often added), then wiped with a soft rag, and finally polished with a silk handkerchief or chamois leather previously freed from grease. A collodion containing soluble iodides and bromides is made to flow over the plate, all excess being drained off when it is covered. A good standard formula for the collodion may be taken to be as follows,—55 grains of pyroxylin, 5 oz. of alcohol, 5 oz. of ether; and in this liquid are dissolved 2½ grains of ammonium iodide, 2 grains of cadmium iodide, and 2 grains of cadmium bromide. When the collodion is set, i.e., when it is in a gelatinous condition, the plate is immersed in a bath of nitrate of silver—a vertical form being that mostly used in Britain, whilst a horizontal dish is used on the Continent—a good formula for which is 350 grains of silver nitrate with 10 oz. of water. The plate is steadily lowered into this solution without pause, and moved in it until all the repellent action between the aqueous solution of the silver and the solvents of the collodion is removed, when it is allowed to rest for a couple of minutes, after which period it is taken out and placed in the dark slide ready for exposure in the camera. After undergoing proper exposure the plate is withdrawn, and in a room lighted with yellow light the developing solution is applied, which originally was a solution of pyrogallol in water restrained in its action by the addition of acetic acid. One of the old formulæ

employed by Delamotte was 9 grains of pyrogallol, 2 drachms of glacial acetic acid, and 3 oz. of water. The image gradually appears after the application of this solution, building itself up from the silver nitrate clinging to the film, which is reduced to the metallic state by degrees. Should the density be insufficient a few drops of nitrate of silver are added to the pyrogallol-acid solution and the developing action continued.

In 1844 Hunt introduced another reducing agent, which has continued to be the favourite down to the present time, viz., ferrous sulphate. By its use the time of necessary exposure of the plate is reduced, and the image develops with great rapidity. A sample of this developing solution is 20 grains of ferrous sulphate, 20 minims of acetic acid, with 1 oz. of water. This often leaves the image thinner than is requisite for the formation of a good print, and it is intensified with pyrogallol and silver. There are other intensifiers used to increase the deposit on a plate by means of mercury or uranium, followed by other solutions to still further darken the double salts formed on the film; but into these it is not necessary to enter here. Such intensifying agents have to be applied to the image after the plate is fixed, which is done by a concentrated solution of hyposulphite of soda or by cyanide of potassium, the latter salt having been first introduced by Martin and Gaudin in 1853 (*La Lumière*, 23d April 1853). Twenty-five grains of cyanide of potassium to one ounce of water is the strength of the solution usually employed. The reaction of both these fixing agents is to form with the sensitive salts of silver double hyposulphites or cyanides which are soluble in water, not, as is often considered to be the case, to merely dissolve the silver salt itself. It may be well to remark that the utility of bromides in the collodion process seems to have been recognized in its earliest days, Archer (1852) and Bingham (1850) both mentioning it. We notice this, since as late as the year 1866 a patent-right in its use was sought to be enforced in America, the patent being taken out by James Cutting in July 1854.

*Positive Pictures by the Collodion Process.*—In the infancy of the collodion process it was shown by Mr Horne that a negative image could be made to assume the appearance of a positive by whitening the metallic silver deposit. This he effected by using with the pyrogallol acid developer a small quantity of nitric acid. A better result was obtained by Mr Fry with ferrous sulphate and ferrous nitrate, whilst Dr Diamond gave effect to the matter in a practical way. Mr Archer used mercuric chloride to whiten the image. To Mr Hunt, however, must be awarded the credit of noticing the action of this salt on the image, in his paper in the *Philosophical Transactions* of 1843. The whitened picture may be made to stand out against black velvet, or black varnish may be poured over the film to give the necessary black background, or, as has been done more recently, the positive pictures may be produced on japanned iron plates (ferrotype plates) or on japanned leather. This process is still practised by some photographers, and from the number of ferrotype plates sold the number of portraits taken by it must be still very large.

*Moist Collodion Process.*—From what has been stated above it will be seen that for the successful working of the collodion process it was necessary that the plate should be exposed very shortly after its preparation; this was a drawback, inasmuch as it necessitated taking a heavy equipment into the field. In May 1854, Messrs Spiller and Crookes published in the *Philosophical Magazine* a process whereby they were enabled to keep a film moist (so as to prevent crystallization of the silver nitrate) several days, enabling plates to be prepared at home, exposed in the field, and then developed in the dark room. The plate

was prepared in the usual way and a solution of zinc nitrate and silver nitrate in water was made to flow over it. The hygroscopic nature of the zinc salt kept sufficient moisture on the plate to attain the desired end. Various modifications in procedure have been made since, but it is scarcely necessary to record them here; for details the reader may consult the volumes of the *Photographic Journal*, 1854-55.

*Dry Plates.*—It would appear that the first experiments with collodion dry plates were due to M. Gaudin. In *La Lumière* of 22d April and 27th May 1854 he describes his researches on the question; whilst in England Mr G. R. Muirhead, on the 4th August 1854, stated that light acts almost as energetically on a dry surface as on a wet after all the silver has been washed away from the former previous to desiccation. Dr Taupenot, however, seems to have been the first to use a dry-plate process that was really workable. His original plan was to coat a plate with collodion, sensitize it in the ordinary manner, wash it, cause a solution of albumen to flow over the surface, dry it, dip it in a bath of silver nitrate, acidified with acetic acid, and wash and dry it again. The plate was then in a condition to be exposed, and was to be developed with pyrogallol acid and silver. In this method we have a double manipulation, which is long in execution, though perfectly effective, as we know from experience.

A great advance was made in all dry-plate processes by the introduction of what is known as the "alkaline developer," which is, however, inapplicable to all plates on which silver nitrate is present in the free state. It will be remembered that the developers previously described, either for collodion or paper processes, were dependent on the reduction of metallic silver by some such agent as ferrous sulphate, the reduction taking place gradually and the reduced particles aggregating on those portions of the film which had been acted upon by light. The action of light being to reduce the silver iodide, bromide, or chloride to the state of sub-salts (*e.g.*, sub-iodide of silver), these reduced particles really acted as nuclei for the crystallized metal. It will be evident that in such a method of development the molecular attraction acts at distances relatively great compared with the diameters of the molecules themselves. If it were possible to reduce the altered particles it was plain that development would be more rapid, and also that the number of molecules reduced by light would be smaller if the metallic silver could be derived from silver compounds within shorter distances of the centres of molecular attraction. Alkaline development accomplished this to a very remarkable extent; but the method is only really practicable when applied to films containing bromide and chloride of silver, as iodide is only slightly amenable to the alkaline body. We have not been able to trace the exact date of the introduction of this developer. It is believed to be of American origin; and it is known that in the year 1862 Major Russell used it with the dry plates he introduced. An alkaline developer consists of an alkali, a reducing agent, and a restraining agent. These bodies, when combined and applied to the solid bromide or chloride of silver, after being acted upon by light, as when a plate was exposed to the camera image, were able to reduce the sub-bromide or sub-chloride, and to build up an image upon it, leaving the unaltered bromide intact, except so far as it was used in the building up. In 1877 Abney investigated this action and was able to demonstrate what actually occurred during the development. One of the experiments will show on what grounds this conclusion was arrived at. A dry plate was prepared by the bath process in the usual manner (to be described below), and exposed in the camera. The exposed film was covered with another film of collodion-bromide emulsion, which of course had not seen the light.

An image was obtained from the double film by means of the developer, which penetrated through the upper unexposed film, and the development was prolonged until an image appeared through the same film, when the plate was fixed, washed, and dried. A piece of gelatinous paper was cemented on the upper film, and a similar piece on the lower after both had been stripped off the glass. When quite dry the two papers were forcibly separated, a film adhering to each. The upper film, *although never exposed to light*, showed an image in some cases more intense than the under film. The action of the alkaline developer was here manifest: the bromide of silver in close contiguity to the exposed particles was reduced to the metallic state. Hence, from this and similar experiments Abney was able to announce that silver bromide could not exist in the presence of freshly precipitated or reduced metallic silver, and that a sub-bromide was immediately formed. Thus  $Ag_2Br_2 + Ag_2 = 2Ag_2Br$ . From this it will be seen that the deposited silver is well within the sphere of molecular attraction, and that consequently a less exposure (*i.e.*, the reduction of fewer molecules of the sensitive salt) would give a developable image.

The alkalis used embraced the alkalis themselves and the mono-carbonates. The sole reducing agent up till recent times was pyrogallol acid. In the year 1880 Abney found that hydroquinone was even more effective than pyrogallol acid, its reducing power being stronger. Various other experimentalists tried other kindred substances, but without adding to the list of really useful agents. In 1884, however, Herr Egli and Arnold Spiller brought out hydroxylamin as a reducing agent, which promises to be of great use if it can be prepared cheaply enough.

Another set of developers for dry plates dependent on the reduction of the silver bromide and the metallic state is founded on the fact that certain organic salts of iron can be utilized. In 1877 Mr Carey Lea of Philadelphia and Mr William Willis announced almost simultaneously that a solution of ferrous oxalate in neutral potassium oxalate was effective as a developer, and from that time it has been universally acknowledged as a useful agent in that capacity; and it is a rare favourite, more especially amongst Continental photographers. In 1881 Abney showed that the addition of a small quantity of sodium hyposulphite very greatly increased its rapidity of action by reducing the time of exposure necessary to get a developable image. In 1882 Dr Eder demonstrated that gelatin chloride of silver plates could be developed with ferrous citrate, which could not be so readily accomplished with ferrous oxalate. The exposure for chloride plates when developed by the latter was extremely prolonged. In the same year Abney showed that if ferrous oxalate were dissolved in potassium citrate a much more powerful agent was formed, which allowed not only gelatin-chloride plates to be readily developed but also collodion-chloride plates. These, it may be said, were undevelopable except by the precipitation method until the advent of the agents last-mentioned; the chloride being as readily reduced as the sub-chloride rendered the development of an image impracticable.

Amongst the components of an alkaline developer we mentioned a restrainer. This factor, generally a bromide or chloride of an alkali, serves probably to form a compound with the silver salt which has not been acted upon by light, and which is less easily reduced than is the silver salt alone,—the altered particles being left intact. The action of the restrainer is regarded by some as due to its combination with the alkali. But whichever theory is correct the fact remains that the restrainer does make the primitive salt less amenable to reduction. Such restrainers as the bromides of the alkalis act through chemical means; but there are others which act through physical means, as

example of which we have in the preparation of a gelatin plate. In this case the gelatin wraps up the particles of the silver compound in a colloidal sheath, as it were, and the developing solution only gets at them in a very gradual manner, for the natural tendency of all such reducing agents is to attack the particles on which least work has to be expended. In the case of bromide of silver the developer has only to remove one atom of bromine, whereas it has to remove two in the case of sub-bromide of silver. The sub-bromide formed by light and that subsequently produced in the act of development are therefore reduced. A large proportion of gelatin compared with the silver salt in a film enables an alkaline developer to be used without any chemical restrainer; but when the gelatin bears a small proportion to the silver such a restrainer has to be used. With collodion films the particles of bromide are more or less unenveloped, and hence in this case some kind of chemical restrainer is absolutely necessary. We may say that the organic iron developers require less restraining in their action than do the alkaline developers.

Alkaline development was first used by Major Russell in a dry-plate process in which the collodion was merely bromized by means of bromides soluble in alcohol. The plate was prepared by immersion in a strong solution of silver nitrate and then washed and a preservative applied. The last-named agent executes two functions, one being to absorb the halogen liberated by the action of light and the other to preserve the film from atmospheric action. Tannin, which Major Russell employed, if we mistake not, is a good absorbent of the halogens, and acts as a varnish to the film. Other collodion dry-plate processes carried out by means of the silver-nitrate bath were very numerous at one time, many different organic bodies being also employed. In most cases ordinary iodized collodion was made use of, a small percentage of soluble bromide being as a rule added to it. When plates were developed by the alkaline method this extra bromide induced density, since it was the silver bromide alone which was amenable to it, the iodide being almost entirely unaffected by the weak developer which was at that time in general use.

One of the most successful bath dry-plate processes was introduced by Mr. R. Manners Gordon and was a really beautiful process. The plate was given an edging of albumen and then coated with ordinary iodized collodion to which one grain per ounce of cadmium bromide had been added. It was kept in the silver-nitrate bath for ten minutes, after which it was washed thoroughly. The following preservative was then applied:—

1.	{ Gum arabic .....	20 gra.
	{ Sugar candy .....	5 "
	{ Water .....	4 dr.
2.	{ Gallic acid .....	8 gra.
	{ Water .....	2 dr.

These ingredients were mixed just before use and, after filtering, applied for one minute to the plate, which was allowed to drain and set up to dry naturally. Great latitude is admissible in the exposure; it should rarely be less than four times or more than twenty times that which would be required for a wet plate under ordinary circumstances. The image may be developed with ferrous sulphate restrained by a solution of gelatin and glacial acetic acid, to which a solution of silver nitrate is added just before application, or by the following alkaline developer:—

1.	{ Pyrogallio acid .....	96 gra.
	{ Alcohol .....	1 oz.
2.	{ Potassium bromide .....	12 gra.
	{ Water .....	1 oz.
3.	{ Ammonium carbonate .....	80 gra.
	{ Water .....	1 oz.

The development of the image requires 6 minims of No. 1, ½ drachm of No. 2, with 3 drachms of No. 3. If properly

exposed the image appears rapidly and gradually gains in intensity, and when all action from the developer ceases the plate is washed and further intensified with pyrogallio acid and silver as is a wet plate. The image is finally fixed in sodium hyposulphite.

In photographic processes not only has the chemical condition of the film to be taken into account but also the optical. When light falls on a semi-opaque or translucent film it is scattered by the particles in it and passes through the glass plate to the back. Here the rays are partly transmitted and partly reflected, a very small quantity of them being absorbed by the material of the glass. Theory points out that the strongest reflexion from the back of the glass should take place at the vertical angle. In 1875 Abney investigated the subject and proved that practice agreed with theory in every respect, and that the image of a point of light in development on a plate was surrounded by a ring of reduced silver caused by the reflexion of the scattered light from the back surface of the glass, and that this ring was shaded inwards and outwards in such a manner that the shading varied with the intensity of the light reflected at different angles. To avoid "halation," as this phenomenon is called, it was usual for photographers to cover the back of their dry plates with some material which should be in optical contact with it, and which at the same time should absorb all the photographically active rays, and only replace those which were incapable of reducing the silver salt. This was called "backing a plate."

*Collodion Emulsion Processes.*—In 1864 Bolton and Sayce published the germ of a process which revolutionized photographic manipulations, and by a subsequent substitution of gelatin for collodion gave an impetus to photography which has carried it to that state of perfection at which it has arrived at the present time (1884). In the ordinary collodion process it will be recollected that a sensitive film is procured by coating a glass plate with collodion containing the iodide and bromide of some soluble salt, and then, when set, immersing it in a solution of silver nitrate in order to form iodide and bromide of silver in the film. The question that presented itself to Bolton and Sayce was whether it might not be possible to get the sensitive salts of silver formed in the collodion whilst liquid, and a sensitive film given to a plate by merely letting this collodion, containing the salts in suspension, flow over the glass plate. Gaudin had attempted to do this with chloride of silver, and later G. W. Simpson had succeeded in perfecting a printing process with collodion containing chloride of silver, citric acid, and nitrate of silver; but the chloride until recently has been considered a slow working salt, and nearly incapable of development. Up to the time of Bolton and Sayce's experiments iodide of silver had been considered the staple of a sensitive film; and, though bromide had been used by Major Russell and others, it had not met with so much favour as to lead to the omission of the iodide. At the date mentioned the suspension of iodide of silver in collodion was not thought practicable, and the inventors of the process turned their attention to bromide of silver, which they found could be secured in such a fine state of division that it remained suspended for a considerable time in collodion, and even when precipitated could be resuspended by simple agitation. The outline of the method was to dissolve a soluble bromide in plain collodion, and add to it drop by drop an alcoholic solution of silver nitrate, the latter being in excess or defect according to the will of the operator. To prepare a sensitive surface the collodion containing the emulsified sensitive salt was poured over a glass plate, allowed to set, and washed till all the soluble salts resulting from the double decomposition of the soluble bromide and the silver nitrate, together with the unaltered soluble

bromide or silver nitrate, were removed, when the film was exposed wet, or allowed to dry and then exposed. The rapidity of these plates was not in any way remarkable, but the process had the great advantage of doing away with the sensitizing nitrate of silver bath, and thus avoiding a tiresome operation. The plates were developed by the alkaline method, and gave images which, if not primarily dense enough, could be intensified by the application of pyrogallic acid and silver nitrate as in the wet collodion process. Such was the crude germ of a method which was destined to effect a complete change in the aspect of photographic negative taking;<sup>1</sup> but for some time it lay dormant. In fact there was at first much to discourage trial of it, since the plates often became veiled on development. Mr Carey Lea of Philadelphia, and Mr W. Cooper, jun., of Reading, may be said to have given the real impetus to the method. Mr Carey Lea, by introducing an acid into the emulsion, established a practicable collodion emulsion process, which was rapid and at the same time gave negative pictures free from veil. To secure the rapidity Carey Lea employed a fair excess of silver nitrate, and Colonel Wortley gained further rapidity by a still greater increase of it; the free use of acid was the only means by which this could be effected without hopelessly spoiling the emulsion. It may be well to mention that the effect of the addition of the mineral acids such as Carey Lea employed is to prevent the formation of (or to destroy when formed) any sub-bromide or oxide of silver, either of which acts as a nucleus on which development can take place. Captain Abney first showed the theoretical effect of acids on the sub-bromide, as also the effect of oxidizing agents on both the above compounds (see below). A more valuable modification was introduced in 1874 by Mr W. B. Bolton, one of the originators of the process, who allowed the ether and the alcohol of the collodion to evaporate, and then washed away all the soluble salts from the gelatinous mass formed of pyroxylin and sensitive salt. After washing for a considerable time, the pellicle was dried naturally or washed with alcohol, and then the pyroxylin redissolved in ether and alcohol, leaving an emulsion of silver bromide, silver chloride, or silver iodide, or mixtures of all suspended in collodion. In this state the plate could be coated and dried at once for exposure. Sometimes, in fact generally, preservatives were used, as in the case of dry plates with the bath, in order to prevent the atmosphere from rendering the surface of the film spotty or insensitive on development. This modification had the great advantage of allowing a large quantity of sensitive salt to be prepared of precisely the same value as to rapidity of action and quality of film. A great advance in the use of the collodion bromide process was made by Colonel Stuart Wortley, who in June 1873 made known the powerful nature of a *strongly* alkaline developer as opposed to the weak one which up to that time had usually been employed. The brief exposure necessary for a collodion emulsion plate, or indeed any dry plate, had not been recognized till the introduction of this developer. This at once placed in the hands of photographers an instrument which by judicious use enabled them to shorten the time of exposure of their plates and to render possible effects which had before been considered out of the question. As an example of the preparation of a collodion emulsion and the developer usually employed with it we give the following.—2½ oz. of alcohol, 5 oz. of ether, 75 grains of pyroxylin. In 1 oz. of alcohol are dissolved 200 grains of zinc bromide;<sup>2</sup> it is then acidulated with 4 or 5 drops

<sup>1</sup> An account of Mr Sayce's process is to be found in the *Photographic News* of October 1865, or the *Photographic Journal* of the same date.

<sup>2</sup> The advantages of this salt were pointed out by Mr. Warnerke in 1875.

of nitric acid, and added to half the above collodion. In 2 drachms of water are dissolved 330 grains of silver nitrate, 1 oz. of alcohol being added. The silvered alcohol is next poured into the other half of the collodion and the brominized collodion dropped in, care being taken to shake between the operations. An emulsion of bromide of silver is formed in suspension; and it is in every case left for 10 to 20 hours to what is technically called "ripen," or, in other words, to become creamy when poured out upon a glass plate. When the emulsion has ripened it may be used at once or be poured out into a flat dish and the solvents allowed to evaporate till the pyroxylin becomes gelatinous. In this state it is washed in water till all the soluble salts are carried away. After this it may be either spread out on a cloth and dried or treated with two or three doses of alcohol, and then redissolved in equal parts of alcohol (specific gravity, .805) and ether (specific gravity, .720). In this condition it is a washed emulsion, and a glass plate can be coated with it and the film dried, or it may be washed and a preservative applied. An excellent preservative introduced by Colonel Stuart Wortley is as follows:—

1. Salycylin, a saturated solution in water.
2. { Tannin ..... 60 gra.  
Distilled water ..... 1 oz.
3. { Gallic acid ..... 48 gra.  
Water ..... 1 oz.

To make the preservative, take 2 oz. of No. 1, 1 oz. of No. 2, ½ oz. of No. 3, 40 grains of sugar, and 7 oz. of water. The plates are immersed in this solution and dried. It is often necessary to give the plate a previous coating with very dilute albumen or gelatin in order to make the film of collodion adhere during development, which can be effected by the strong alkaline developer, or by the ferrous oxalate developer, previously noticed.

The type of a useful alkaline developer is as follows:—

1. { Pyrogallic acid ..... 96 gra.  
Alcohol ..... 1 oz.
2. { Potassium bromide ..... 12 gra.  
Water distilled ..... 1 oz.
3. { Ammonium carbonate ..... 80 gra.  
Water ..... 1 oz.

To develop the plate 6 minims of No. 1, ½ drachm of No. 2, and 3 drachms of No. 3 are mixed together and made to flow over the plate after washing the preservative off under the tap. Sometimes the development is conducted in a flat dish, sometimes the solution is poured on the plate.<sup>3</sup> The unreduced salts are eliminated by either cyanide of potassium or sodium hyposulphite. Intensity may be given to the image, if requisite, either before or after the "fixing" operation. Where resort is had to ferrous oxalate development, the developer is made in one of two ways—(1) by saturating a saturated solution of neutral potassium oxalate with ferrous oxalate, and adding an equal volume of a solution (10 grains to 1 oz. of water) of potassium bromide to restrain the action, or (2) by mixing, according to Eder's plan, 3 volumes by measure of a saturated solution of the potassium oxalate with 1 volume by measure of a saturated solution of ferrous sulphate, and adding to the ferrous oxalate solution thus obtained an equal bulk of the above solution of potassium bromide. The development is conducted in precisely the same manner as indicated above, and the image is fixed by one of the same agents.

*Gelatin Emulsion Process.*—The facility with which collodion emulsion plates could be prepared had turned all investigation into this channel, and collodion was not the only vehicle that was tried for holding the sensitive salts in suspension. As early as September 1871 Dr R. L.

<sup>3</sup> For further details the reader is referred to *Instruction in Photography*, p. 99.



Maddox had tried emulsifying the silver salt in gelatin, and had produced negatives of rare excellence, as the present writer can testify from personal knowledge. In November 1873 Mr King described a similar process, getting rid of the soluble salts by washing. Efforts had also been made in this direction by Mr Burgess in July 1873. Mr R. Kennett in 1874 may be said to have been the first to put forward the gelatin emulsion process in a practical and workable form, as he then published a formula which gave good and quick results. It was not till 1878, however, that the great capabilities of silver bromide when held in suspension by gelatin were fairly known; in March of that year Mr C. Bennett showed that by keeping the gelatin solution liquid at a low temperature for as long as seven days extraordinary rapidity was conferred on the sensitive salt. The molecular condition of the silver bromide seemed to be altered, and to be amenable to a far more powerful developer than had hitherto been dreamt of. In 1874 the Belgian chemist Stas had shown that various modifications of silver bromide and chloride were possible, and it seemed that the green molecular condition (one of those noted by Stas) of the bromide was attained by prolonged warming. It may in truth be said that the starting-point of rapid plates was 1878, and that the full credit of this discovery should be allotted to Mr C. Bennett. Both Kennett and Bennett got rid of the soluble salts from the emulsion by washing; and in order to attain success it was requisite that the bromide should be in excess of that necessary to combine with the silver nitrate used to form the emulsion. In June 1879 Abney showed that a good emulsion might be formed by precipitating a silver bromide by dropping a solution of a soluble bromide into a dilute solution of silver nitrate. The supernatant liquid was decanted, and after two or three washings with water the precipitate was mixed with the proper amount of gelatin. Dr van Monckhoven of Ghent, in experimenting with this process, hit upon the plan of obtaining the emulsion by splitting up silver carbonate with hydrobromic acid, leaving no soluble salts to be extracted. He further, in August 1879, announced that he had obtained great rapidity by adding to the bromide emulsion a certain quantity of ammonia. This addition rapidly altered the bromide of silver from its ordinary state to the green molecular condition referred to above. At this point we have the branching off of the gelatin emulsion process into two great divisions, viz., that in which rapidity was gained by long-continued heating, and the other in which it was gained by the use of ammonia—a subdivision which is maintained to the present day. Photographers' opinions as to the respective merits of the two methods are much divided, some maintaining that the quality of the heated emulsion is better than that produced by alkalinity, and *vice versa*. We may mention that in 1881 Dr Herschell introduced a plan for making an alcoholic gelatin emulsion with the idea of inducing rapid drying of the plates, and in the same year Dr H. Vogel of Berlin brought forward his ideas for combining gelatin and pyroxilin together by means of a solvent which acted on the gelatin and allowed the addition of alcohol in order to dissolve the pyroxilin. This method was called "collodio-gelatin emulsion," and apparently was only a shortlived process, which is not surprising, since its preparation involved the inhalation of the fumes of acetic acid.

The warming process introduced by Bennett was soon superseded. Colonel Stuart Wortley in 1879 announced that, by raising the temperature of the vessel in which the emulsion was stewed to 150° Fahr., instead of days being required to give the desired sensibility only a few hours were necessary. A further advance was made by boiling the emulsion, first practised, we believe, by Mr Mansfield

in 1879. Another improvement was effected by Mr W. B. Bolton by emulsifying the silver salt in a small quantity of gelatin and then raising the emulsion to boiling point, boiling it for from half an hour to an hour, when extreme rapidity was attained. It would be impossible to enumerate many minor improvements in this process that have from time to time been made; it is sufficient to have stated in historical sequence the different important stages through which it has passed. It may be useful to give an idea of the relative rapidities of the various processes we have described.

Daguerreotype, originally	.....	half an hour's exposure.
Calotype	.....	2 or 3 minutes'
Collodion	.....	10 seconds'
Collodion emulsion	.....	15 seconds'
Rapid gelatin emulsion	.....	1/4th second

By this it will be seen what advances have been made in the art of photography during the forty-five years of its existence.

The following is an outline of two representative processes. All operations should be conducted in light which can act but very slightly on the sensitive salts employed, and this is more necessary with this process than with others on account of the extreme ease with which the equilibrium of the molecules is upset in giving rise to the molecule which is developable. The light to work with, and which is safe, is gaslight or candlelight passing through a sheet of Chance's stained red glass backed by orange paper. Stained red glass allows but few chemically effective rays to pass through it, whilst the orange paper diffuses the light. If daylight be employed, it is as well to have a double thickness of orange paper. The following should be weighed out:—

1. Potassium iodide	.....	5 grs.
2. Potassium bromide	.....	135 "
3. Nelson's No. 1 photographic gelatin	.....	20 "
4. Silver nitrate	.....	175 "
5. Autotype or other hard gelatin	.....	100 "
5. Nelson's No. 1 gelatin	.....	100 "

No. 3 and 5 are rapidly covered with water or washed for a few seconds under the tap to get rid of any adherent dust. No. 2 is dissolved in 1 1/2 oz. of water, and a little tincture of iodine added till it assumes a light sherry colour. No. 1 is dissolved in 60 minims of water. No. 4 is dissolved in 1/2 oz. of water, and No. 3 is allowed to swell up in 1 oz. of water, and is then dissolved by heat. All the flasks containing these solutions are placed in water at 150° Fahr. and carried into the "dark room," as the orange-lighted chamber is ordinarily called; No. 3 and 4 are then mixed together in a jar or flask, and No. 2 added drop by drop till half its bulk is gone, when No. 1 is added to the remainder, and the double solution is dropped in as before. When all is added there ought to be formed an emulsion which is very ruddy when examined by gaslight, or orange by daylight. The flask containing the emulsion is next placed in boiling water, which is kept in a state of ebullition for about three-quarters of an hour. It is then ready, when the contents of the flask have cooled down to about 100° Fahr., for the addition of No. 5, which should in the interval be placed in 2 oz. of water to swell and finally be dissolved. The gelatin emulsion thus formed is placed in a cool place to set, after which it is turned into a piece of coarse canvas or mosquito-netting made into a bag. By squeezing, threads of gelatin containing the sensitive salt can be made to fall into cold water; by this means the soluble salts are extracted. This is readily done in two or three hours by frequently changing the water, or by allowing running water to flow over the emulsion-threads. The gelatin is next drained by straining canvas over a jar and turning out the threads on to it, after which it is placed in a flask, and warmed till it dissolves, half an ounce of alcohol being added. Finally, it is filtered through chamois leather or swansdown calico. In this state it is ready for the plates.

The other method of forming the emulsion is with ammonia. The same quantities as before are weighed out, but the solutions of Nos. 3 and 5 are first mixed together and No. 4 is dissolved in 1 oz. of water, and strong ammonia of specific gravity 880 added to it till the oxide first precipitated is just redissolved. This ammoniacal solution is then dropped into Nos. 2 and 3 as previously described, and finally No. 1 is added. In this case no boiling is required; but to secure rapidity it is as well that the emulsion should be kept an hour at a temperature of about 90° Fahr., after which half the total quantity of No. 5 is added. When set the emulsion is washed, drained, and redissolved as before; but in order to give tenacity to the gelatin the remainder of No. 5 is added before the addition of the alcohol, and before filtering.

*Coating the Plates.*—Glass plates are best cleaned with nitric acid, rinsed, and then treated with potash solution, rinsed again,

and dried with a clean cloth. They are then ready for receiving the emulsion, which, after being warmed to about 120° Fahr., is poured on them in sufficient quantity to cover well the surface. This being done, the plates are placed on a level shelf and allowed to stay there till the gelatin is thoroughly set; they are then put in a drying cupboard, through which, by a simple contrivance, a current of warm air is made to pass. It should be remarked that the warmth is only necessary to enable the air to take up the moisture from the plates. They ought to be dry in about twelve hours, and they are ready for immediate use.

**Exposure.**—With a good emulsion and on a bright day the exposure of a plate to a landscape, with a lens whose aperture is one-sixteenth that of the focal distance, should not be more than one-half to one-fifth of a second. This time depends, of course, on the nature of the view; if there be foliage in the immediate foreground it will be longer. In the portrait-studio, under the same circumstances, an exposure with a portrait-lens may be from half a second to four or five seconds.

**Development of the Plate.**—To develop the image either a ferrous oxalate solution or alkaline pyrogallol acid may be used. The former is conveniently prepared as described on p. 826. No chemical restrainer such as bromide of potassium is necessary, since the gelatin itself acts as a physical restrainer. If the alkaline developer be used, the following may be taken as a good standard:—

1.	{	Pyrogallol .....	50 grs.
		Citric acid .....	10 "
		Water .....	1 oz.
2.	{	Potassium bromide .....	10 grs.
		Water .....	1 oz.
3.	{	Ammonia, 380 .....	1 dr.
		Water .....	9 "

One drachm of each of these is taken and the mixture made up to 2 oz. with water. The plate is placed in a dish and the above poured over it without stoppage, whereupon the image gradually appears and, if the exposure has been properly timed, gains sufficient density for printing purposes. It is fixed in a solution of hyposulphite of soda, as in the other processes already described, and then thoroughly washed for two or three hours to eliminate all the soluble salt. This long washing is necessary on account of the nature of the gelatin.

**Intensifying the Negative.**—Sometimes it is necessary to intensify the negative, which can be done in a variety of ways with mercury salts. An excellent plan, introduced by the Platinotype Company, is to use a saturated solution of mercuric chloride in water, and a subsequent addition of 2 grains to the ounce of platonic chloride. This is put in a dish and the metallic solution allowed to act till sufficient density is obtained. With most other methods with mercury the image is apt to become yellow and to fade; with this apparently it is not.

**Varnishing the Negative.**—The negative is usually protected by receiving first a film of plain collodion and then a coat of shellac or other photographic varnish. This protects the gelatin from moisture and also from becoming stained with the silver nitrate owing to contact with the sensitive paper used in silver printing.

#### Printing Processes.

The first printing process may be said to be that of Fox Talbot (see above, p. 824), which has continued to be generally employed to the present day (with the addition of albumen to give a surface to the print,—an addition first made, we believe, by Fox Talbot). Paper for printing is prepared by mixing 150 parts of ammonium chloride with 240 parts of spirits of wine and 2000 parts of water, though the proportions vary with different manufacturers. These ingredients are dissolved, and the whites of fifteen fairly-sized eggs are added and the whole beaten up to a froth. In hot weather it is advisable to add a drop of carbolic acid to prevent decomposition. The albumen is allowed two or three days to settle, when it is filtered through a sponge placed in a funnel, or through two or three thicknesses of fine muslin, and transferred to a flat dish. The paper is cut of convenient size and allowed to float on the solution for about a minute, when it is taken off and dried in a warm room. For dead prints, on which colouring is to take place, plain salted paper is useful. It can be made of the following proportions—80 parts of ammonium chloride, 100 parts of sodium citrate, 10 parts of gelatin, 5000 parts of distilled water. The gelatin is first dissolved in hot water and the remaining components are added. It is next filtered, and the paper allowed to float on it for three minutes, then withdrawn and dried.

**Sensitizing Bath.**—To sensitize the paper it is made to float on a 10 per cent. solution of silver nitrate for three minutes. It is then hung up and allowed to dry, after which it is ready for use. To print the image the paper is placed in a printing-frame over a negative and exposed to light. It is allowed to print till such time as the image appears rather darker than it should finally appear.

**Toning and Fixing the Print.**—The next operation is to tone and fix the print. In the earlier days this was accomplished by means of a bath of *sel d'or*,—a mixture of hyposulphite of soda and auric chloride. This gilded the darkened parts of the print which light

had reduced to the semi-metallic state; and on removal of the chloride by means of hyposulphite an image composed of metallic silver, an organic salt of silver, and gold was left behind. There was a suspicion, however, that part of the coloration was due to a combination of sulphur with the silver, not that pure sulphide of silver is in any degree fugitive, but the sulphuretted organic salt of silver seems to be liable to change. This gave place to a method of alkaline toning, or rather, we should say, of neutral toning, by employing auric chloride with a salt, such as the carbonate or acetate of soda, chloride of lime, borax, &c. By this means there was no danger of sulphurization during the toning, to which the method by *sel d'or* was prone owing to the decomposition of the hyposulphite. The substances which can be employed in toning seem to be those in which an alkaline base is combined with a weak acid, the latter being readily displaced by a stronger acid, such as nitric acid, which must exist in the paper after printing. This branch of photography owes much to the Rev. T. F. Hardwich, he having carried on extensive researches in connexion with it during 1854 and subsequent years. MM. Davanne and Girard, a little later, also investigated the matter with fruitful results.

The following may be taken as two typical toning-baths:—

{	Auric chloride .....	1 part.
	Sodium carbonate .....	10 parts.
	Water .....	5000 "
{	(a) Borax .....	100 "
	Water .....	4000 "
{	(β) Auric chloride .....	1 part.
	Water .....	4000 parts.

In the latter (a) and (β) are mixed in equal parts immediately before use. Each of these is better used only once. A third bath is:—

Auric chloride .....	2 parts.
Chloride of lime .....	2 "
Chalk .....	40 "
Water .....	5000 "

These are mixed together, the water being warmed. When cool the solution is ready for use. In toning prints there is a distinct difference in the *modus operandi* according to the toning-bath employed. Thus in the first two baths the print must be thoroughly washed in water to enable all free silver nitrate to be carried away from the image, that salt forming no part in the chemical reactions. On the other hand, where free chlorine is used, the presence of free silver nitrate or some active chlorine absorbent is a necessity. In 1872 Abney showed that with such a toning-bath free silver nitrate might be eliminated, and if the print were immersed in a solution of a salt such as lead nitrate the toning action proceeded rapidly and without causing any fading of the image whilst toning, which was not the case when the free silver nitrate was totally removed and no other chlorine absorbent substituted. This was an important factor in the matter, and one which had been overlooked. In the third bath the free silver nitrate should only be partially removed by washing. The print, having been partially washed or thoroughly washed, as the case may be, is immersed in the toning-bath till the image attains a purple or bluish tone, after which it is ready for fixing. The solution used for this purpose is a 20 per cent. solution of hyposulphite of soda, to which it is best to add a few drops of ammonia in order to render it alkaline. About ten minutes suffice to effect the conversion of the chloride into hyposulphite of silver, which is soluble in hyposulphite of soda and can be removed by washing. The organic salts of silver seem, however, to form a different salt, which is partially insoluble, but which the ammonia just recommended helps to remove. If it is not removed, there is a sulphur compound left behind, according to Spiller, which by time and exposure becomes yellow.

The use of potassium cyanide for fixing prints is to be avoided, as this reagent attacks the organic coloured oxide which, if removed, would render the print a ghost. The washing of silver prints should be very complete, since it is said that the least trace of hyposulphite left behind renders the fading of the image a mere matter of time. Whether this be due to the hygroscopic nature of the hyposulphite and its reaction on the organic salt of silver, or to the destruction of the hyposulphite and sulphurizing of the black organic salt, seems at present to be an undetermined question. The stability of a print has been supposed to be increased by immersing it, after washing, in a solution of alum. The alum, like any other acid body, decomposes the hyposulphite into sulphur and sulphurous acid. If this be the case, it seems probable that the destruction of the hyposulphite by time is not the occasion of fading, but that its hygroscopic character is. This, however, as has already been said, is a moot point. It is usual to wash the prints some hours in running water. We have found that half a dozen changes of water, and between successive changes the application of a sponge to the back of each print separately, are equally or more efficacious. On drying, the print assumes a darker tone than what it has after leaving the fixing-bath.

Different tones can thus be given to a print by different toning-baths; and the gold itself may be deposited in a ruddy form or in a blue form. The former molecular condition gives the red and sepia tones, and the latter the blue and black tones. The degree

of minute subdivision of the gold may be conceived when it is stated that, on a couple of sheets of albuminized paper fully printed, the gold necessary to give a decided tone does not exceed half a grain.

**Colloidal-chloride Silver Printing Process.**—In the history of the emulsion processes we have already stated that Gaudin had attempted to use silver chloride suspended in collodion, but it was not till the year 1864 that any practical use was made of the suggestion so far as silver printing is concerned. In the autumn of that year Mr George Wharton Simpson worked out a method which has been more or less successfully employed, and is still one of the best with which we are acquainted. The formula appended is the original one which Mr Simpson published:—

1.	Silver nitrate .....	60 parts.
	Distilled water .....	60 "
2.	Strontium chloride .....	64 "
	Alcohol .....	1000 "
3.	Citric acid .....	64 "
	Alcohol .....	1000 "

To every 1000 parts of plain collodion 80 parts of No. 1, previously mixed with 60 parts of alcohol, are added; 60 parts of No. 2 are next mixed with the collodion, and finally 80 parts of No. 3. This forms an emulsion of silver chloride and also contains citric acid and silver nitrate. The defect of this emulsion is that it contains a large proportion of soluble salts, which are apt to crystallize out on drying, more particularly if it be applied to glass plates. The addition of the citric acid and the excess of silver nitrate is the key to the whole process; for, unless some body were present which, on exposure to light was capable of forming a highly-coloured organic oxide of silver, no vigour would be obtained in printing. If pure chloride be used, though an apparently strong image would be obtained, yet on fixing only a feeble trace of it would be left, and the print would be worthless. The colloidal-chloride emulsion may be applied to glass, as before stated, or to paper, and the printing carried on in the usual manner. The toning takes place by means of the chloride-of-lime bath or by ammonium sulpho-cyanide and gold, which is practically a return to the sel d'or bath. The organic salt formed in this procedure does not seem so prone to be decomposed by keeping as does that formed by albumen, and the washing can be more completely carried out. This is a beautiful process, and deserving of more attention than has hitherto been given to it.

**Gelatin-citro-chloride Emulsion.**—A modified emulsion printing process was introduced by Abney in 1861, which consisted in suspending silver chloride and silver citrate in gelatin, there being no excess of silver present. The formula of producing it is as follows:—

1.	Sodium chloride .....	40 parts.
	Potassium citrate .....	40 "
	Water .....	500 "
2.	Silver nitrate .....	150 "
	Water .....	500 "
3.	Gelatin .....	800 "
	Water .....	1700 "

Nos. 2 and 3 are mixed together whilst warm, and No. 1 is then gently added, the gelatin solution being kept in brisk agitation. This produces the emulsion of citrate and chloride of silver. The gelatin containing the suspended salts is heated for five minutes at boiling point, when it is allowed to cool and subsequently slightly washed, as in the gelatin-bromide emulsion. It is then ready for application to paper or glass. The prints are of a beautiful colour, and seem to be fairly permanent. They may be readily toned by the borax or by the chloride of lime toning-bath, and are fixed with the hyposulphite solution of the strength before given.

**Printing with Salts of Uranium.**—The sensitiveness of the salts of uranium to light seems to have been discovered by Niepce, and the fact was subsequently applied to photography by Burnett in England. One of the original formulæ consisted of 20 parts of uranic nitrate with 600 parts of water. Paper, which is better if slightly sized previously with gelatin, is floated on this solution. When dry it is exposed beneath a negative, and a very faint image is produced; but it can be developed into a strong one by 6 to 10 per cent. solution of silver nitrate to which a trace of acetic acid has been added, or by a 2 per cent. solution of auric chloride. In both these cases the silver and gold are deposited in the metallic state. Another developer is a 2 per cent. solution of ferro-cyanide of potassium to which a trace of nitric acid has been added, sufficient to give a red coloration. The development takes place most readily by letting the paper float on these solutions.

**Wothly Type.**—A variation was introduced in the uranium process by Herr Wothly in 1864, when he employed uranic nitrate with other salts in the collodion, and then coated starched paper with the product. The paper was printed until it assumed a bluish-black image, which was subsequently intensified by means of gold. The most generally used Wothly-type formula, however, consisted of a triple salt of silver nitrate, uranic nitrate, and ammoniac nitrate, which were dissolved in collodion. This compound was applied to paper sized with arrowroot, and, after drying, the printing proceeded in the usual manner, the image being subsequently fixed

with hyposulphite of soda. The prints produced by this method were very beautiful, but for some reason they found no great favour with the public.

**Printing with Chromates.**—The first mention of the use of potassium bichromate for printing purposes seems to have been made by Mungo Ponton in May 1836, when he stated that paper, if saturated with this salt and dried, and then exposed to the sun's rays through a drawing, would produce a yellow picture on an orange ground, nothing more being required to fix it than washing it in water, when a white picture on an orange ground was obtained. In 1840 M. E. Becquerel announced that paper sized with iodide of starch and soaked in bichromate of potash was, on drying, more sensitive than unsized paper. Joseph Dixon of Massachusetts, in the following year, produced copies of bank-notes by using gum arabic with bichromate of potash spread upon a lithographic stone, and, after exposure of the sensitive surface through a bank-note, by washing away the unaltered gum and inking the stone as in ordinary lithography. The same process, with slight modifications, has been used quite recently by Simonet and Toovey of Brussels, and is capable of producing most excellent results. Dixon's method, however, was not published till 1854, when it appeared in the *Scientific American*, and consequently, as regards priority of publication, it ranks after Fox Talbot's photo-engraving process (see below), which was published in 1852. On 18th December 1855 M. Alphonse Poitevin took a patent in England, in which he vaguely described a method of taking a direct carbon-print by rendering gelatin insoluble through the action of light on bichromate of potash. This idea was taken up by Mr Pouncey of Dorchester, who perhaps was the first to produce veritable carbon-prints, notwithstanding that Testud de Beauregard took out a somewhat similar patent to Poitevin's at the end of 1857.

Mr Pouncey published his process on 1st January 1859; but, as described by him, it was by no means in a perfect state, half-tones being wanting. The cause of this was first pointed out by Abbé Laborde in 1858, whilst describing a kindred process in a note to the French Photographic Society. He says, "In the sensitive film, however thin it may be, two distinct surfaces must be recognized—an outer, and an inner which is in contact with the paper. The action of light commences on the outer surface; in the washing, therefore, the half-tones lose their hold on the paper and are washed away." Mr J. C. Burnett in 1858 was the first to endeavour to get rid of this defect in carbon-printing. In a paper to the Photographic Society of London he says, "There are two essential requisites . . . (2) that in printing the paper should have its unprepared side (and not its prepared side, as in ordinary printing) placed in contact with the negative in the pressure-frame, as it is only by printing in this way that we can expect to be able afterwards to remove by washing the unacted-upon portions of the mixture. In a positive of this sort printed from the front or prepared side the attainment of half-tones by washing away more or less depth of the mixture, according to the depth to which it has been hardened, is prevented by the insoluble parts being on the surface and in consequence protecting the soluble part from the action of the water used in washing; so that either nothing is removed, or by steeping very long till the inner soluble part is sufficiently softened the whole depth comes bodily away, leaving the paper white." This method of exposing through the back of the paper was crude and unsatisfactory, and in 1860 Fargier patented a process in which, after exposure to light of the gelatin film which contained pigment, the surface was coated with collodion, and the print placed in warm water, where it separated from the paper support and could be transferred to glass. Poitevin opposed this patent, and his opposition was successful, for he had used this means of detaching the films in his powder-carbon process, in which ferric chloride and tartaric acid were used. Fargier at any rate gave an impetus to carbon-printing, and J. W. Swan (to whom electric lighting owes so much) took up the matter, and in 1864 secured a patent. One of the great features in Swan's innovations was the production of what is now known as "carbon-tissue," made by coating paper with a mixture of gelatin, sugar, and colouring matter, and rendered sensitive to light by means of bichromate of potash or ammonia. After exposure to light Swan placed the printed carbon-tissue on an india-rubber surface, to which it was made to adhere by pressure. The print was immersed in hot water, the paper backing stripped off, and the soluble gelatin containing colouring matter washed away. The picture could then be re-transferred to its final support of paper. In 1869 J. R. Johnson of London took out a patent in which he claimed that carbon-tissue which had been soaked in water for a short period, by its tendency to swell further, would adhere to any waterproof surface such as glass, metal, waxed paper, &c., without any adhesive material being applied. This was a most important and fruitful improvement. Johnson also added soap to the gelatin to prevent its excessive brittleness on drying, and made his final support of gelatinized paper, rendered insoluble by chrome alum. In 1874 J. R. Sawyer patented a flexible support for developing on; this was a sized paper coated with gelatin and treated with an ammoniacal solution of

shellac in borax, on which wax or resin was rubbed. The advantage of this flexible support is that the dark parts of the picture have no tendency to contract from the lighter parts, which they were apt to do when a metal plate was used, as was the case in Johnson's original process. With this patent, and minor improvements made since, carbon-printing has arrived at the state of perfection in which we find it to-day.

According to Liesegang, the carbon-tissue when prepared on a large scale consists of from 120 to 150 grains of gelatin (a soft kind), 15 grains of soap, 21 grains of sugar, and from 4 to 8 grains of dry colouring matter. The last-named may be of various kinds, from lamp-black pigment to soluble colours such as alizarin. The gelatin, sugar, and soap are put in water and allowed to stand for an hour, and then melted, the liquid afterwards receiving the colours, which have been ground with a mallet on a slab. The mixture is filtered through fine muslin. In making the tissue in large quantities the two ends of a piece of roll-paper are pasted together and the paper hung on two rollers; one of wood about 5 inches in diameter: is fixed near the top of the room and the other over a trough containing the gelatin solution, the paper being brought into contact with the surface of the gelatin by being made to revolve on the rollers. The thickness of the coating is proportional to the rate at which the paper is drawn over the gelatin: the slower the movement, the thicker the coating. The paper is taken off the rollers, cut through, and hung up to dry on wooden lathes. If it be required to make the tissue sensitive at once, 120 grains of potassium dichromate should be mixed with the ingredients in the above formula. The carbon-tissue when prepared should be floated on a sensitizing bath consisting of one part of potassium dichromate in forty parts of water. This is effected by turning up about 1 inch from the end of the sheet of tissue (cut to the proper size), making a roll of it, and letting it unroll along the surface of the sensitizing solution, where it is allowed to remain till the gelatin film feels soft. It is then taken off and hung up to dry in a dark room through which a current of dry warm air is passing. Tissue dried quickly, though not so sensitive, is more manageable to work than if more slowly dried. As the tissue is coloured, it is not possible to ascertain by inspection of it whether the printing operation is sufficiently carried out, and in order to ascertain this it is usual to place a piece of ordinary silvered paper in an "actinometer," or "photometer," alongside the carbon-tissue to ascertain the amount of light that has acted on it. There are several devices for ascertaining this amount, the simplest being an arrangement of a varying number of thicknesses of gold-beater's skin. The value of 1, 2, 3, &c., thicknesses of the skin as a screen to the light is ascertained by experiment. Supposing it is judged that a sheet of tissue under some one negative ought to be exposed to light corresponding to a given number of thicknesses, chloride of silver paper is placed alongside the negative beneath the actinometer and allowed to remain there until it takes a visible tint beneath a number of thicknesses equivalent to the strength of the negative. After the tissue is removed from the printing-frame—supposing a double transfer is to be made—it is placed in a dish of cold water, face downwards, along with a piece of Sawyer's flexible support (already described). When the edges of the tissue begin to curl up, its surface and that of the flexible support are brought together and placed flat. The water is pressed out with an india-rubber squeezer called a "squeegee" and the two surfaces adhere. About a couple of minutes later they are placed in warm water of about 90° to 100° Fahr., and the paper of the tissue, loosened by the gelatin solution next it becoming soluble, can be stripped off, leaving the image (reversed as regards right and left) on the flexible support. An application of warm water removes the rest of the soluble gelatin and pigment. When dried, the image is transferred to its permanent support. This usually consists of white paper coated with gelatin and made insoluble with chrome alum, though it may be mixed with barium sulphate or other similar pigments. This transfer-paper is made to receive the image by being soaked in hot water till it becomes slimy to the touch; and the surface of the damped print is brought in contact with the surface of the retransfer-paper in the same manner as was done with the flexible support and the carbon-tissue. When dry the retransfer-paper bearing the gelatin image can be stripped off the flexible support, which may be used again as a temporary support for other pictures.

Such is a brief outline of carbon-printing as practised at the present day, subject, of course, to various modifications which need not be entered into here. We ought, however, to mention that if a reversed negative be used the image may be transferred at once to its final support instead of to the temporary flexible support, which is a point of practical value, since single-transfer are better than double-transfer prints.

*Printing with Salts of Iron.*—Sir John Herschel and Mr Hunt in sundry papers and publications entered into various methods of printing with salts of iron. At the present time there are two or three which are practised, being used in draughtsmen's offices for copying tracings. When a ferric salt is exposed to light it becomes reduced to the ferrous state, and when this latter compound

is treated with potassium ferri-cyanide a blue compound is formed. If, therefore, a solution of a ferric salt be brushed over a paper, and the latter be dried, and then exposed behind a tracing, the parts of the ferric salt on the paper exposed beneath the white ground are converted into a ferrous salt, and if potassium ferri-cyanide be brushed over the paper, or the paper floated upon it, the tracing shows white lines on a blue ground. Another method is to mix ferri-cyanide of potassium with a ferric salt, and expose it behind a tracing or drawing. Where the light acts, the mixture is converted into a blue compound. The resulting print is the same as the foregoing. Another method of producing blue lines on a white ground is to expose paper coated with gum and a ferric salt to light, and then treat it with potassium ferri-cyanide. This body forms an insoluble blue compound with the ferric salt, whilst the ferrous salt is inactive, or only gives a soluble body. A further development of printing with salts of iron is the beautiful platinotype process. Sized paper is coated with a solution of ferric oxalate and a platinum salt, and exposed behind a negative. It is then floated on a hot solution of neutral potassium oxalate, when the image is formed of platinum black. This process was introduced by Mr W. Willis in 1874. The rationale of it is that a ferrous salt when in solution is capable of reducing a platinum salt to metallic platinum. In this case the ferrous salt is dissolved by the potassium oxalate, and at the moment of solution the platinum salt is reduced and forms the image.

*Photo-mechanical Printing Processes.*—Allusion has already been made to the invention of Poitevin, who claimed to have discovered that a film of gelatin impregnated with bichromate of potash, after being acted upon by light and damping, would receive greasy ink on those parts which had been affected by light. But Paul Oreloth seems to have made the discovery previous to 1854, for in his patent of that year he states that his designs were inked with printing ink before being transferred to stone or zinc. Tessie de Motay (in 1865) and Marechal de Metz, however, seem to have been the first to produce half-tones from gelatin films by means of greasy ink. Their general method of procedure consisted in coating metallic plates with gelatin impregnated with bichromate or trichromate of potash or ammonia and mercuric chloride, then treating with oleate of silver, exposing to light through a negative, washing, inking with a lithographic roller, and printing from the plates as for an ordinary lithograph. The half-tints by this process were very good, and illustrations executed by it are to be found in several existing works. The method of producing the plates, however, was most laborious, and it was not long before it was simplified by Albert of Munich. He had been experimenting for many years, endeavouring to make the gelatin films more durable than those of Tessie de Motay. He added gum-resins, alum, tannin, and other such matters, which had the property of hardening gelatin; but the difficulty of adding sufficient to the mass in its liquid state before the whole became coagulated rendered these unmanageable. It at last occurred to him that if the hardening action of light were utilised by exposing the surface next the plate to light after or before exposing the front surface of the film and the image, the necessary hardness might be given to the gelatin without adding any chemical hardeners to it. In Tessie de Motay's process the hardening was almost absent, and the plates were consequently not durable. It is evident that to effect this one of two things had to be done: either the metallic plate used by Tessie de Motay must be abandoned, or else the film must be stripped off the plate and exposed in that manner. Albert adopted the transparent plate, and his success was assured, since instead of less than a hundred impressions being pulled from one plate he was able to take over a thousand. This occurred about 1867, but the formula was not published for two or three years afterwards, when it was divulged by Olm and Grossman, one of whom had been employed by Albert of Munich, and had endeavoured to introduce a process which resembled Albert's earlier efforts. The name of "Lichtdruck" was given about this time to these surface-printing processes, and Albert may be considered, if not the inventor, at all events the perfecter of the method. Another modification of "Lichtdruck" was patented in England by Ernest Edwards under the name of "heliotype." This consisted in coating a glass plate, the surface of which was very finely ground, with bichromated gelatin to which a certain amount of chrome alum had been added. The film itself was much thicker than that of the Albert type, since it had to be detached from the surface of the glass by stripping, which was rendered possible by the previous application of a waxing solution to the plate. After the film was stripped off it was exposed under a negative for the time necessary to give a good image with printing ink, after which the inner side was exposed to light for almost the same length of time. The gelatin sheet was then transferred to a pewter plate, to which it was cemented by thick india-rubber cement and soaked in water till all the soluble bichromate was extracted. After this it was placed in a type printing-press and inked with a lithographic or gelatin roller, and an impression pulled on paper in the same manner as in printing with type, save that a greater pressure was brought to bear on the surface. This pressure was necessary

for two reasons,—the relief of the image would be too great if only a moderate pressure were used, and the entire surface was so large that a heavy pressure was requisite to make the paper bite on the ink. Between each pull the gelatin film was damped, the surface moisture taken off with a dry cloth, and the inking proceeded with. The drawback to this process is undoubtedly the great relief that is given from the film being so thick, but it is a more manageable process in some respects than that of Albert, since the support is unbreakable. We should mention that Edwards also patented the use of two or more inks of different degrees of stiffness. The stiffest, which was generally black, adhered to the most deeply printed parts of the image, the next stiffest to the next most deeply printed parts, and so on. By this means the least deeply printed parts acquired a different tone from that of the deeper printed parts, which was an advantage as regards artistic effect. The same method of inking could be applied to Albert's process with the same results. Since the time of the heliotype patent many improvements have been made in the minor details of the operations, and various firms now produce prints in greasy ink very little if at all inferior to silver prints.

**Woodbury Type.**—This process was invented by Mr W. Woodbury about the year 1864, though we believe that Mr J. W. Swan had been working independently in the same direction about the same time. In October 1864 a description of the invention was given in the *Photographic News*. M. Gaudin claimed the principle of the process, insisting that it was old, and basing his pretensions on the fact that he had printed with translucent ink from intaglio blocks engraved by hand; but at the same time he remarked that the application of the principle might lead to important results. It was just these results which Mr Woodbury obtained, and for which he was entitled to the fullest credit. Woodbury type is a combination of the principle upon which intaglio printing is based with that upon which a carbon-print is obtained. The general features of the procedure will be understood from the foregoing description of the carbon-process. An image is obtained on bichromatized gelatin from a negative of the usual kind by exposing a thick layer of gelatin to light and then washing away all its soluble parts from the back of the exposed print. This is the mould which it is necessary to obtain. At first Woodbury made electrotypes from the mould, from which he could obtain prints mechanically. The intaglio was placed on a specially devised printing-press, and the mould filled with gelatin containing colouring matter such as Indian ink. A piece of paper perfectly even in thickness was placed in contact with the mould, and a piece of flat glass under pressure brought down upon this. The excess of pigmented gelatin was squeezed out, and, when slightly set, it adhered to the paper and was brought away from the mould. After drying, a perfect picture was obtained in pigment, the image being reversed as regards right and left; but that difficulty was surmounted by using a reversed negative, and also by a modification of the process subsequently introduced by Mr Woodbury. The gelatin relief was made as before, and then by means of very heavy pressure in a hydraulic press the mould was squeezed into soft metal, from which the prints could be afterwards taken off. This is the same principle as that on which nature-printing is conducted, and at first sight it seems strange that material such as gelatin should be able to impress metal. Mr Woodbury found that it made very little if any difference in the sharpness of the image if the relief was reversed and the back of the relief pressed into the mould. This of course made the print correct as regards right and left. He has not, however, been content with his original operations, but has further simplified them, the outcome being what is known as the "stannotype process." In 1880 he read a description of it before the French Photographic Society. The modification consisted in taking a mould in gelatin from a positive on glass. The mould, when hardened by chemical means (as was indeed the case with the original Woodbury-type process), was attached to a sheet of flat glass, and then covered by the foil and passed through a rolling press the cylinders of which were covered with thick india-rubber. This forced the tinfoil into every crevice of the mould, yielding a block impervious to moisture and ready to have gelatin impressions taken from it. At first Mr Woodbury took an electrotype from the relief, covered with tinfoil, obtained from a negative, but he abandoned this for a simpler plan. He took a positive on glass in the ordinary manner adopted by photographers, from which he made a mould in gelatin. This he covered with tinfoil and printed direct from it.

*Photo-Lithography.*

Reference has already been made to the effect of light on gelatin impregnated with bichromate of potash, whereby the gelatin becomes insoluble, and also incapable of absorbing water where the action of the light has had full play. It is this last phenomenon which occupies such an important place in photo-lithography. In the spring of 1859 Asser of Amsterdam produced photographs on a paper

basis in printer's ink. Being anxious to produce copies of such prints mechanically, he conceived the idea of transferring the greasy ink impression to stone, and multiplying the impressions by mechanical lithography. Following very closely upon Asser, J. W. Osborne of Melbourne made a similar application; his process is described by himself in the *Photographic Journal* for April 1860 as follows. "A negative is produced in the usual way, bearing to the original the desired ratio. . . . A positive is printed from this negative upon a sheet of (gelatinized) paper, so prepared that the image can be transferred to stone, it having been previously covered with greasy printer's ink. The impression is developed by washing away the soluble matter with hot water, which leaves the ink on the lines of print of the map or engraving." The process of transferring is accomplished in the ordinary way. Early in 1860 Colonel Sir H. James, R.E., F.R.S., brought forward the Southampton method of photo-lithography, which had been carefully worked out by Captain de Courcy Scott, R.E. We give a detailed description of it as practised at Southampton.

**Preparation of the Paper.**—The mixture consists of 3 oz. of Nelson's "fine art" gelatin and 2 oz. of potassium bichromate dissolved in 10 oz. of water and added to the 40 oz. of water with which the gelatin, after proper soaking, has been previously mixed. Good and grainless bank post-paper (chosen on account of its toughness) of medium thickness is made to float on this solution (after it has been strained) for three minutes, when it is hung up in the dark to dry. It is again floated on the solution and hung up for desiccation by the corners opposite to those which were previously uppermost, and then passed through a copper-plate or lithographic press to obtain a smooth surface. The paper is next placed upon a negative and printed in the ordinary manner, the negative being very dense in those parts which should print white, and perfectly transparent where the black lines have to be impressed. From about two minutes' exposure in sunshine to an hour in dull light is requisite to give sufficient intensity to the prints, which are next covered with greasy printer's ink, made from lithographic printing ink, pitch, varnish, palm oil, and wax. The inking is best done by covering a lithographic stone with a fine layer by means of a roller, and then passing the paper through the press as if pulling a lithographic print,—an operation which may have to be repeated twice to ensure the whole surface being covered, and yet not too thickly. The inked print is placed face uppermost on water of a temperature of about 90° Fahr., and, when the soluble parts of the gelatin have taken up their full quantity of water, the paper is laid on a sloping glass plate, inked surface uppermost, and a gentle stream of warm water poured over it. This removes the soluble gelatin and the greasy ink lying on it, the removal being helped by the application of a very soft sponge. When all the gelatin and ink except that forming the image have been removed, the paper is allowed to dry till ready to transfer to stone. The method admits of several variations in detail, such as coating the gelatin with albumen and removing the soluble albumen by cold water, some of them being excellent, especially where the relief of the developed print is small, as relief is an enemy to the production of fine work on a lithographic stone, since the ink, in passing through the press, squeezes out and produces broad lines which should be otherwise fine.

Another method of producing a transfer, called the "papyrotype process," was published by Abney in 1870, in which the ink is put on to a surface of gelatin by means of a soft roller; and this has the great advantage that the ink can be removed at pleasure if any part is not satisfactorily inked, without the basis of the print being

destroyed. In this process tough paper is coated with a fine layer of gelatin and subsequently treated with alum or chrome alum, afterwards receiving another coating, as in the Southampton method. The printing too is carried out as in the Southampton method, but not so deeply. After withdrawing the prints from the printing-frame they are soaked in cold water, and a roller is passed over them charged with an ink made of 4 parts of best lithographic chalk ink mixed with 1 part of palm oil. A roller coated with velvet is said to be better than the ordinary composition rollers. The ink takes when the work is all clear; the transfer is exposed to light, and is ready to be put down on stone or zinc.

#### *Photo-Engraving and Photo-Reliefs.*

This may be divided into two classes, one the production of an engraved plate for printing by the copper-plate press, and the other for the production of *clichés* for printing with type. Niepce's process is still generally employed for the first when line engravings have to be reproduced. A copper plate is covered with asphaltum, a film negative placed in contact with it, and the necessary exposure given. After development with olive oil and turpentine the lines are shown as bare copper. The plate after being waxed at the back is next plunged into an acid bath and etched as are etched plates. When a half-tone negative has to be reproduced on copper Fox Talbot's method, described in his patents of 1852 and 1858, is still the simplest. A print on gelatin is transferred to a copper plate, and the surface etched by means of different strengths of ferric chloride, which renders the gelatin insoluble and impermeable; hence it will be seen that a weak solution of ferric chloride is able to reach the copper through the gelatin more readily than a strong one. In order to be successful it is necessary to give a grain to the plate; this is effected by sprinkling it with powdered resin, which is then warmed.

Relief plates for printing with type are usually made on zinc. If an ordinary photo-lithographic transfer be transferred to zinc and then sprinkled with resin, the zinc may be immersed in weak acid and the uncovered parts eaten away. The regularity of the erosion is much increased by previously immersing the plate in a weak solution of copper sulphate. The particles of metallic copper deposited on the zinc form with it and with dilute acid galvanic couples, which rapidly eat away the zinc. The etching bath should be kept in motion. The depth of the erosion is increased by littering the surface again with powdered resin, which adheres to the lines, and then heating the plate. The warmed resin runs down the eroded lines and protects them from under-cutting when again placed in acid. This process is applicable to line-engravings. Niepce's bitumen process is also applicable, but in that case a positive must be applied to the plate to be etched. There exist several methods by which half-tone negatives may be reproduced for working off in the printing-press. They depend principally on breaking up the whole surface by means of lines. Thus, if, between the surface on which the printing is to take place (and which has been coated with some sensitive medium) and the positive, a film on which a network of lines has been photographed be interposed, it is evident that the resulting print will consist of the half-tone subject together with an image of the network of lines. This can be etched in the manner described above. Most of these processes are secret, but it is believed that this is the one most generally practised.

#### *Photographs in Natural Colours.*

The first notice on record of coloured light impressing its own colours on a sensitive surface is in the passage

already quoted from the *Farbenlehre* of Goethe, where Seebeck of Jena (1810) describes the impression he obtained on paper impregnated with moist chloride of silver. In 1839 Sir J. Herschel (*Athenæum*, No. 621) gave a somewhat similar description. In 1848 Edmond Becquerel succeeded in reproducing upon a daguerreotype plate not only the colours of the spectrum but also, up to a certain point, the colours of drawings and objects. His method of proceeding was to give the silver plate a thin coating of silver chloride by immersing it in ferric or cupric chlorides. It may also be immersed in chlorine water till it takes a feeble rose tint. Becquerel preferred to chlorinize the plate by immersion in a solution of hydrochloric acid in water, attaching it to the positive pole of a voltaic couple, whilst the other pole he attached to a platinum plate also immersed in the acid solution. After a minute's subjection to the current the plate took successively a grey, a yellow, a violet, and a blue tint, which order was again repeated. When the violet tint appeared for the second time the plate was withdrawn and washed and dried over a spirit-lamp. In this state it produced the spectrum colours, but it was found better to heat the plate till it assumed a rose tint. At a later date Niepce de St Victor chlorinized by means of chloride of lime, and made the surface more sensitive by applying a solution of lead chloride in dextrin. G. W. Simpson also obtained coloured images on silver chloride emulsion in collodion, but they were less vivid and satisfactory than those obtained on daguerreotype plates. Poitevin obtained coloured images on ordinary chloride of silver paper by preparing it in the usual manner and washing it and exposing it to light. It was afterwards treated with a solution of bichromate of potash and cupric sulphate, and dried in darkness. Sheets so prepared gave coloured images from coloured pictures, which he stated could be fixed by sulphuric acid (*Comptes Rendus*, 1868, vol. lxi. p. 11). In the *Bulletin de la Société Française* (1874) St Florent describes experiments which he made with the same object. He immerses ordinary or albuminized paper in silver nitrate and afterwards plunges it into a solution of uranium nitrate and zinc chloride acidulated with hydrochloric acid; it is then exposed to light till it takes a violet, blue, or lavender tint. Before exposure the paper is floated on a solution of mercuric nitrate, its surface dried, and exposed to a coloured image.

It is supposed—though it is very doubtful if it be so—that the nature of the chloride used to obtain the chloride of silver has a great effect on the colours impressed; and Niepce in 1857 made some observations on the relationship which seemed to exist between the coloured flames produced by the metal and the colour impressed on a plate prepared with a chloride of such a metal. In 1880 (*Proc. Roy. Soc.*) Abney showed that the production of colour really resulted from the oxidation of the chloride that was coloured by light. Plates immersed in a solution of hydroxyl took the colours of the spectrum much more rapidly than when not immersed, and the size of the molecules seemed to regulate the colour. He further stated that the whole of the spectrum colours might be derived from a mixture of two or at most three sizes of molecules. In 1841, during his researches on light, Robert Hunt published some results of colour-photography by means of fluoride of silver. A paper was washed with nitrate of silver and with sodium fluoride, and afterwards exposed to the spectrum. The action of the spectrum commenced at the centre of the yellow ray and rapidly proceeded upwards, arriving at its maximum in the blue ray. As far as the indigo the action was uniform, whilst in the violet the paper took a brown tint. When it was previously exposed, however, a yellow space was occupied where the yellow



rays had acted, a green band where the green had acted, whilst in the blue and indigo it took an intense blue, and over the violet there was a ruddy brown. In reference to these coloured images on paper it must not be forgotten that pure salts of silver are not being dealt with as a rule. An organic salt of silver is usually mixed with chloride of silver paper, this salt being due to the sizing of the paper, which towards the red end of the spectrum is usually more sensitive than the chloride. If a piece of ordinary chloride of silver paper is exposed to the spectrum till an impression is made, it will usually be found that the blue colour of the darkened chloride is mixed with that due to the coloration of the darkened organic compound of silver in the violet region, whereas in the blue and green this organic compound is alone affected, and is of a different colour from that of the darkened mixed chloride and organic compound. This naturally gives an impression that the different rays yield different tints, whereas this result is simply owing to the different range of sensitiveness of the bodies. In the case of the silver chlorinized plate and of true collodio-chloride, in which no organic salt has been dissolved, we have a true coloration by the spectrum. At present there is no means of permanently fixing the coloured images which have been obtained, the effect of light being to destroy them. If protected from oxygen they last longer than if they have free access to it, as is the case when the surface is exposed to the air. That photography in colours may one day be accomplished is still possible, though the bright tints of nature can never be hoped for, since, as a rule, they are produced by sunbath, whereas on the plate they have to be viewed by diffused light.

*Action of Light on Silver Salts.*—The action of light on sensitive bodies has occupied the attention of many experimentalists from a very early period of photography. In 1777 Scheele, according to Hunt (*Researches in Light*), made the following experiments:—

"I precipitated a solution of silver by sal-ammoniac; then I edulcorated it and dried the precipitate and exposed it to the beams of the sun for two weeks; after which I stirred the powder, and repeated the same several times. Hereupon I poured some caustic spirit of sal-ammoniac (strong ammonia) on this, in all appearance, black powder, and set it by for digestion. This menstruum dissolved a quantity of *luna cornua* (horn silver), though some black powder remained undissolved. The powder having been washed was, for the greater part, dissolved by a pure acid of nitre (nitric acid), which, by the operation, acquired volatility. This solution I precipitated again by means of sal-ammoniac into horn silver. Hence it follows that the blackness which the *luna cornua* acquires from the sun's light, and likewise the solution of silver poured on chalk, is silver by reduction. . . . I mixed so much of distilled water with well-edulcorated horn silver as would just cover this powder. The half of this mixture I poured into a white crystal phial, exposed it to the beams of the sun, and shook it several times each day; the other half I set in a dark place. After having exposed the one mixture during the space of two weeks, I filtrated the water standing over the horn silver, grown already black; I let some of this water fall by drops in a solution of silver, which was immediately precipitated into horn silver."

This, as far as we know, is the first intimation of the reducing action of light. From this it is evident that Scheele had found that the silver chloride was decomposed by the action of light liberating some form of chlorine. Others have repeated these experiments and found that chlorine is really liberated from the chloride; but it is necessary that some body should be present which would absorb the chlorine, or, at all events, that the chlorine should be free to escape. A tube of dried silver chloride, sealed up *in vacuo*, will not discolour in the light, but keeps its ordinary white colour. A pretty experiment is to seal up *in vacuo*, at one end of a bent tube, perfectly dry chloride, and at the other a drop of mercury. The mercury vapour vol-

atilizes to a certain extent and fills the tube. When exposed to light chlorine is liberated from the chloride, and calomel forms on the sides of the tube. In this case the chloride darkens. Again, dried chloride sealed up in dry hydrogen discolours, owing to the combination of the chlorine with the hydrogen. Poitevin and H. W. Vogel first enunciated the law that for the reduction by light of the haloid salts of silver halogen absorbents were necessary, and it was by following out this law that the present rapidity in obtaining camera images has been rendered possible. To put it briefly, then, the action of light is a reducing action, which is aided by or entirely due to the fact that other bodies are present which will absorb the halogens. There is another action which seems to occur almost simultaneously when exposure takes place in the absence of an active halogen absorbent, as is the case when the exposure is given in the air,—that is, an oxidizing action occurs. The molecules of the altered haloid salts take up oxygen and form oxides. An example of this has already been shown in the section on "photographs in natural colours." If a sensitive salt be exposed to light and then treated with an oxidizing substance, such as bichromate of potash, permanganate of potash, hydroxyl, ozone, an image is not developed, but remains unaltered, showing that a change has been effected in the compound. If such an oxidized salt be treated very cautiously with nascent hydrogen the oxygen is withdrawn, and the image is again capable of development.<sup>1</sup>

*Spectrum Effects on Silver Compounds.*—The next inquiry is as to the effect of the spectrum on the different silver compounds. We have already described Seebeck's (1810) experiments on the chloride of silver with the spectrum whereby he obtained coloured photographs, but Scheele in 1777 allowed a spectrum to fall on the same material, and found that it blackened much more readily in the violet rays than in any other. Senebier's experiments have been already quoted at the beginning of this article. We merely mention these two for their historical interest, and pass on to the study of the action of the spectrum on different compounds by Sir J. Herschel which is to be found in the *Philosophical Transactions* for 1840. He there describes many interesting experiments, which became the foundations of nearly all subsequent researches of the same kind. The effects of the spectrum have been studied by various experimenters since that time, amongst whom we may mention Becquerel, Draper, Poitevin, H. W. Vogel, Schumann, and Abney. Fig. 1 (see pp. 836-38), which appeared in the *Proceedings of the Royal Society* for 1882, shows the most recent researches by the last-named experimenter as regards the action of the spectrum on the three principal haloid salts of silver. We may mention that in two instances exception has been taken to these results—(1) by H. W. Vogel, who recognizes a difference of behaviour in the spectrum in chloride and bromide of silver when precipitated in alcoholic and aqueous solutions, and (2) by Schumann to the effect of the spectrum on the double iodide and bromide, and iodide and chloride. The latter experimenter finds that when the two salts are mixed after precipitation the results are correct, but that if the precipitations of the two salts take place together the most refrangible maximum of sensitiveness disappears. The diagram (see fig. 1), however, will give a very approximate approach to the truth. Nos. 33 and 34 show the effect of the spectrum on a peculiar modification of silver bromide made by Abney, in which the silver bromide is seen to be sensitive to the infra-red rays. This modification is, and will be, largely used in investigating this part of the spectrum.

<sup>1</sup> See Abney, "Destruction of the Photographic Image," in *Phil. Mag.*, vol. v., 1878; also *Proc. Roy. Soc.*, vol. xxvii., 1878.

FIG. 1.—Spectrum Effects on Salts of Silver.

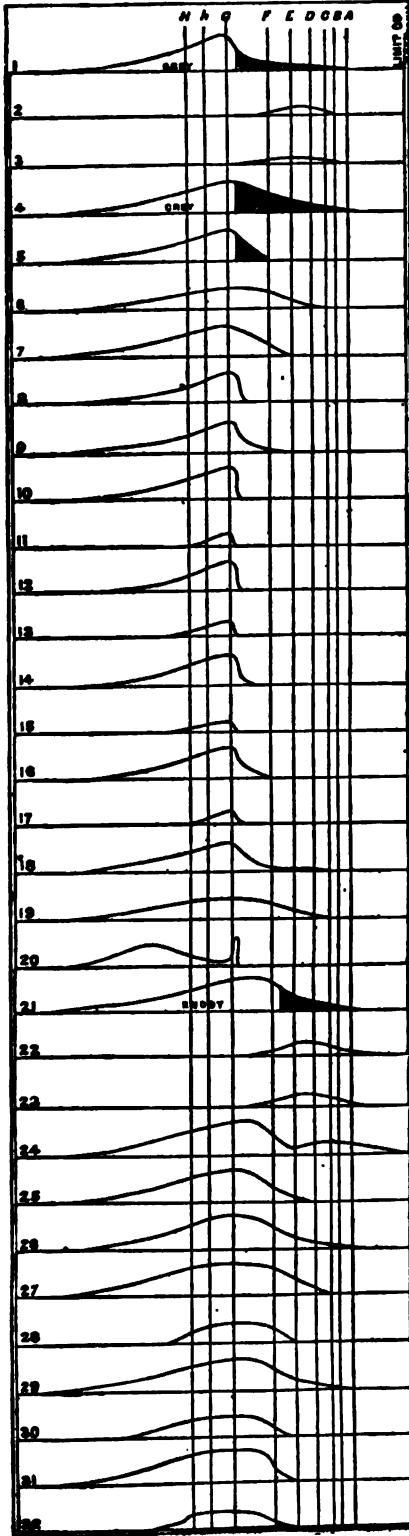

[P.—print; D.—developed; L.a.—long exposure; s.a.—short exposure.]

1 AgI+AgNO<sub>3</sub> on paper..... P.

2 " " ..... P.

3 " " ..... P.

4 AgI on paper washed from P. excess of AgNO<sub>3</sub> and treated with KNO<sub>3</sub>

5 AgI on paper washed from P. AgNO<sub>3</sub> soaked in NaCl, washed from excess, and exposed with KNO<sub>3</sub>

6 Paper floated on AgNO<sub>3</sub> .. P.

7 AgI on paper washed from P. excess of AgNO<sub>3</sub>, ruddy tint

8 AgI on paper washed from P. excess of AgNO<sub>3</sub> treated with KI and KNO<sub>3</sub>; or AgI in-collodion

9 AgI+AgNO<sub>3</sub> in albumen .. P.

10 AgI prepared in bath, treated D. with KI, washed, redipped (L.a.) in silver bath, developed with pyrogallie acid

11 " " ..... (s.a.)

12 AgI purified and exposed in D. presence of sensitiser, de- (L.a.) veloped by acid or alkaline developer

13 " " ..... (s.a.)

14 AgI unpurified, treated, and D. developed as above ..... (L.a.)

15 " " ..... (s.a.)

16 AgI with trace of AgCl or D. AgBr, developed by acid (L.a.) or alkaline method

17 " " ..... (s.a.)

18 AgI+AgNO<sub>3</sub> in albuminised D. collodion, or on paper washed, acid development

19 AgI+AgNO<sub>3</sub> in albuminised D. collodion, or on paper washed, ferrous citrate developer

20 AgI+AgNO<sub>3</sub>, prolonged ex- D. posure

21 AgBr+AgNO<sub>3</sub> on paper .. P.

22 " " .. P.

23 " " .. P.

24 Green AgBr in collodion, with P. or without AgNO<sub>3</sub>

25 Orange AgBr in collodion P. gelatin, with or without AgNO<sub>3</sub>

26 Grey AgBr in gelatin ..... P.

27 AgBr on paper washed from D. AgNO<sub>3</sub>, acid or ferrous (L.a.) citro-oxalate developer

28 " " ..... (s.a.)

29 Grey AgBr in gelatin, de- D. veloped alkaline or ferrous (L.a.) oxalate

30 " " ..... (s.a.)

31 Orange AgBr in collodion or D. gelatin, alkaline ferrous (L.a.) oxalate or acid developer

32 " " ..... (s.a.)

*Effect of Dyes on Sensitive Films.*—In 1874 Dr Vogel of Berlin called attention to this subject. He found that when films were stained with certain anilines and other dyes and exposed to the spectrum an increased action on development was shown in those parts of the spectrum which the dye absorbed. The dyes which produced this action he called "optical sensitizers," whilst preservatives which absorbed the halogens liberated by light he called "chemical sensitizers." A dye might, according to him, be an optical and a chemical sensitizer. He further claimed that, if a film were prepared in which the haloid soluble salt was in excess and then dyed, no action took place unless some "chemical sensitizer" were present. The term "optical sensitizer" seems a misnomer, since it is meant to imply that it renders the salts of silver sensitive to those regions of the spectrum to which they were previously insensitive, merely by the addition of the dye. The idea of the action of dyes was at first combated by many, but it was soon recognized that such an action did really exist. Abney showed in 1875 that certain dyes combined with silver and formed true coloured organic salts of silver which were sensitive to light; and Dr Amory went so far as to take a spectrum on a combination of silver with eosine, which was one of the dyes experimented upon by Major Waterhouse, who had closely followed Dr Vogel, and proved that the spectrum acted simply on those parts which were absorbed by the compound. Abney further demonstrated that, in many cases at all events, the dyes were themselves reduced by light, thus acting as nuclei on which the silver could be deposited. He further showed that even when the haloid soluble salt was in excess the same character of spectrum was produced as when the silver nitrate was in excess, though the exposure had to be prolonged. This action he concluded was due to the action of the dye. The subject has been discussed again recently owing to the production of so-called iso-chromatic films, i.e., films which are supposed to be sensitive to all colours, and which are prepared on gelatin or collodion plates by dyeing them with eosine or some similar dye; and the instructions given indicate that, if a coloured picture or landscape be photographed through yellow glass, the "yellows" will be denser in the negative than will the "blues." Experiment shows if a film after preparation be dipped in a solution of "eosine of silver," made by precipitating eosine with silver nitrate, washing the precipitate, and then dissolving in water faintly alkaline, a negative taken in the usual way will give the "yellows" equally as dense as the "blues." The action of the yellow glass is to cut off the blue rays to which the normal salt is most sensitive, and to leave the yellow rays unaltered; these then expend their energy upon the organic salt of silver. The advantage of rendering the yellows of a picture most intense in a negative is that the resulting print will be more nearly true to nature, since these are the most luminous rays. Further experiment ought surely to show how this can be done without the introduction of the tinted glass.

*Action of the Spectrum on Chromic Salts.*—The salts most usually employed in photography

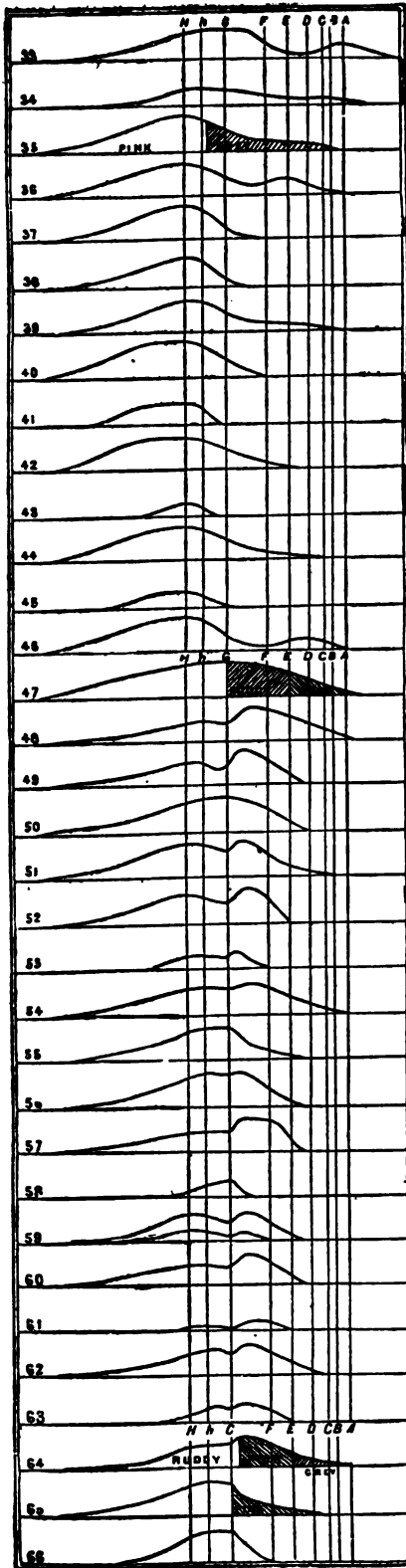

Green AgBr in collodion, D. developed ferrous oxalate (l.e.)  
 " " ..... (s.e.)  
 AgCl+AgNO<sub>3</sub> on paper .... F.  
 AgCl+AgNO<sub>3</sub> on paper, P. slight preliminary exposure  
 AgCl on paper washed from P. excess of AgNO<sub>3</sub>  
 AgCl on paper washed, F. treated with NaCl, washed again; also collodiochloride of silver, and yellow AgCl in gelatin  
 Grey AgCl in gelatin  
 AgCl in collodion, excess of D. AgNO<sub>3</sub> or NaCl present. (l.e.) ferrous citrate or acid development  
 " " ..... (s.e.)  
 " " ..... (s.e.)  
 Yellow AgCl in gelatin, acid D. or ferrous citro-oxalate (l.e.) development  
 " " ..... (s.e.)  
 " " ..... (s.e.)  
 Gray AgCl in gelatin, acid D. or ferrous citro-oxalate (l.e.) development  
 " " ..... (s.e.)  
 " " ..... (s.e.)  
 AgCl in collodion, short preliminary exposure, acid or ferrous citro-oxalate development  
 AgI+AgBr+AgNO<sub>3</sub> on P. paper, moist  
 AgI+AgBr, washed from P. AgNO<sub>3</sub>  
 " developed D. ferrous citro-oxalate  
 AgI+AgBr+AgNO<sub>3</sub> wet D. plate, acid or alkaline developer  
 AgI+AgBr in gelatin, devel. D. oped ferrous oxalate  
 AgBr+AgI in collodion, D. acid or alkaline developer (l.e.)  
 " " ..... (s.e.)  
 " " ..... (s.e.)  
 3AgI+AgBr on paper ..... F.  
 3AgI+AgBr on paper, devel. D. oped gallic acid  
 " developed ferrous D. citrate  
 3AgI+AgBr+AgNO<sub>3</sub> collo. D. ion, wet plate, acid or (l.e.) alkaline developer  
 " " ..... (s.e.)  
 " " ..... (s.e.)  
 3AgI+AgBr in gelatin, al. D. kaline or ferrous oxalate (l. & developer s.e. shown.)  
 AgI+3AgBr on paper or in D. collodion, ferrous citro-(l.e.) oxalate developer  
 " " ..... (s.e.)  
 " " ..... (s.e.)  
 AgI+3AgBr in gelatin, fer. D. rous oxalate developer (l.e.)  
 " " ..... (s.e.)  
 " " ..... (s.e.)  
 3AgI+AgCl+AgNO<sub>3</sub> on P. paper, or paper washed, both dry  
 AgI+AgCl+AgNO<sub>3</sub> wet, or P. 3AgI+AgCl+KNO<sub>3</sub> wet  
 3AgI+AgCl+AgNO<sub>3</sub> or D. 3AgI+AgCl+KNO<sub>3</sub> on paper, developed with gallic acid or ferrous citro-oxalate

are the bichromates of the alkalis. The result of spectrum action in connexion with them is confined to its own most refrangible end, commencing in the ultra-violet and reaching as far as in the solar spectrum. The accompanying diagram (fig. 2) shows the relative action of the

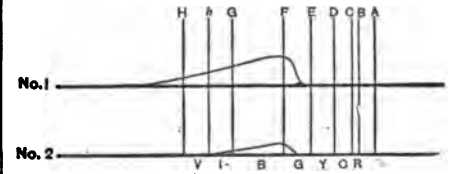

FIG. 2.—The top letters have reference to the Fraunhofer lines; the bottom letters are the initials of the colours. The relative sensitiveness is shown by the height of the curve above the base-line.

various parts of the spectrum on potassium bichromate. If other bichromates are employed, the action will be found to be tolerably well represented by the figures. No. 1 is the effect of a long exposure, No. 2 of a shorter one. It should be noticed that the solution of bichromate of potash absorbs those rays alone which are effective in altering the bichromate. A reference to pp. 831, 833 will show that the change is only possible in the presence of organic matter of some kind, such as gelatin or albumen.

*Action of the Spectrum on Asphaltum.*—This seems to be continued into and below the red; the blue rays, however, are the most effective. The action of light on this body is to render it less soluble in its usual solvents. Compare this statement with that on p. 822.

*Action of the Spectrum on Salts of Iron.*—Many ferric salts have been used from time to time in the production of prints, the most common at the present time being the ferric oxalate, by which the beautiful platinotype prints are produced. We give this as a representation (fig. 3) of the spectra obtained on ferric

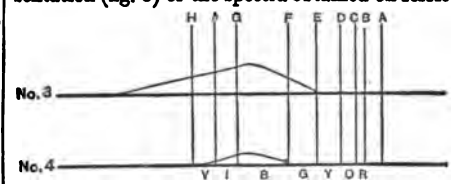
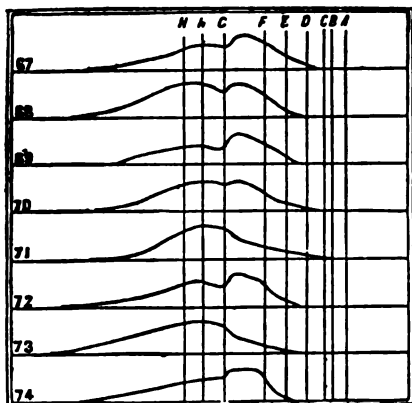

FIG. 3.—Same description as for fig. 2.

salts in general. Here, again, we have an example of the rigorous law that exists as to the correlation between absorption and chemical action. One of the most remarkable compounds of iron is that experimented upon by Sir J. Herschel and later by Lord Rayleigh, viz., ferrocyanide of potassium and ferric chloride. If these two be brushed over paper and the paper be then exposed to a bright solar spectrum, action is exhibited into the infra-red region. This is one of the few instances in which these light-waves of low refrangibility are capable of producing any effect. The colour of this solution is a muddy green, and analysis shows that it cuts off these rays as well as generally absorbs those of higher refrangibility.

*Action of Light on Uranium.*—The salts of uranium are affected by light in the presence of organic matter, and they too are only acted upon by those rays which they absorb. Thus nitrate



Washed 2AgI + AgCl on D. paper, ferrous citro-oxalate developer  
 2AgI + AgCl in gelatin, de-veloped ferrous oxalate  
 AgI + AgCl in gelatin, de-veloped ferrous oxalate  
 AgI + 2AgCl on paper, washed F.  
 AgI + 2AgCl + AgNO<sub>3</sub> wet... P.  
 AgI + 2AgCl in gelatin, or D. on paper, ferrous citro-oxalate or acid developer  
 AgI + 2AgCl + AgNO<sub>3</sub> acid D. developer  
 AgBr, exposed to light, P. treated with I, exposed to also spectrum.

of uranium, which shows, too, absorption-bands in the green blue, is affected more where these occur than in any other portion of the spectrum.

It would be going beyond our province to do more than enumerate the other metallic compounds which are amenable to chemical change by the impact of radiation; suffice it to say that some salts of mercury, gold, copper, lead, manganese, molybdenum, platinum, vanadium, are all affected, but in a less degree than those which we have discussed. In the organic world there are very few substances which do not change by the continuous action of light, and it will be found that as a rule they are affected by the blue end of the spectrum rather than by the red end. For a more detailed account we must refer the reader to *The Chemical Effects of the Spectrum* by Dr J. M. Eder (London).

The following table gives the names of the observers of the action of light on different substances with the date of publication of the several observations. It is nearly identical with one given by Dr Eder in his *Geschichte der Photo-Chemie*.

Substance.	Observer.	Date.
<i>Silver.</i>		
Nitrate solution mixed with chalk, gives in sunshine copies of writing	J. H. Schulze	1777
Nitrate solution on paper	Hellot	1787
Nitrate photographically used	Wedgwood and Davy	1802
Nitrate on silk	Fulham	1797
	Rumford	1798
Nitrate with white of egg	B. Fischer	1813
Nitrate with lead salts	Herschel	1839
Chloride	J. B. Becquerel	1737
Chloride in the spectrum	Schlesle	1777
Chloride photographically used	Wedgwood	1802
Chloride blackened	Lassaigne	1839
Iodide	Davy	1814
Iodide by action of iodine (on metallic silver)	Daguerre	1839
Iodide photographically used	Herschel	1840
Iodide with gallic acid	Talbot	1841
Iodide with ferrous sulphate	Hunt	1844
Chloride and iodide by chlorine and iodine (on metallic silver)	Clarend	1840
Bromide	Balard	1826
Bromide by action of bromine (on metallic silver)	Goddard	1840
Sulpho-cyanide	Grotthuis	1818
Nitrite	Hess	1828
Oxide with ammonia	Mitscherlich	1827
Sulphate	Bergmann	1779
Chromate	Vauquelin	1798
Carbonate	Buchholz	1800
Oxalate	Bergmann	1779
Benzoate	Trommsdorf	1798
Citrate	Vauquelin	1798
Kinate	Henry and Plisson	1829
Borate	Rose	1830
Ferrophosphate	Stromeyer	1830
Lactate	Polons and Gay-Lussac	1838
Formiate	Hunt	1844
Fulminate	Hunt	1844
Sulphide by vapour of sulphur (on metallic silver)	Nispee	1820
Phosphide by vapour of phosphorus (on metallic silver)	Nispee	1820
<i>Gold.</i>		
Oxide	Schlesle	1777
Chloride on paper	Hellot	1787
Chloride on silk	Fulham	1794
Chloride in ethereal solution	Rumford	1798
Chloride with ferro-cyanide and ferri-cyanide of potassium	Hunt	1844
Chloride and oxalic acid	Döbereiner	1831
Chromate	Hunt	1844
Flate of gold and iodine vapour	Goddard	1843
<i>Platinum.</i>		
Chloride in ether	Gehlen	1804
Chloride with lime	Herschel	1840
Iodide with lime	Herschel	1840
Bromide	Hunt	1844
Cyanide	Hunt	1844
Double chloride of platinum and potassium	Döbereiner	1828
<i>Mercury.</i>		
Oxide (mercurous)	Gay-Lussac and Thénard	1811
Oxide (mercurous)	Davy	1812
Oxide (mercurous)	Davy	1797
Oxide (more accurate observations)	Abildgaard	1797
	Harrp not till	1801
Chloride (mercurous)	K. Neumann previously to	1738
Chloride (mercuric)	Boullay	1828
Chloride with oxalic acid	Bergmann	1776
Sulphate	Meyer	1764

Substance.	Observer.	Date.
Oxalate (mercuric)	Bergmann	1778
Oxalate (mercurous)	Harrp	1828
Sulphate and ammonia (mercurous)	Fourcroy	1791
Acetate (mercurous)	Garot	1826
Bromide (mercurous)	Löwig	1828
Iodide (mercurous)	Torreswies	1828
	Arne	1828
	Field	1828
	Harrp	1828
Tartrate and potassium (mercurous)	Carbonell and Bravo	1831
Carbonate (mercuric)	Davy	1812
Nitrate	Herschel	1840
Sulphide (mercurous)	Vikruius	1 n.c.
<i>Iron.</i>		
Sulphate (ferrous)	Chastaign	1877
Chloride (ferrous) and alcohol	Bastuschaef	1738
Chloride and ether	Klaproth	1783
Oxalate (ferrous)	Döbereiner	1831
Ferro-cyanide of potassium	Heterich	1808
Sulpho-cyanide	Grotthuis	1818
Prussian blue	Scopoli	1783
Ferri-citrate with ammonium	Herschel	1780
Ferri-tartrate	Herschel	1840
Chromate	Hunt	1844
<i>Copper.</i>		
Chloride (cupric dissolved in ether)	Gehlen	1804
Oxalate with sodium	A. Vogel	1813
Chromate		
Chromate with ammonium		
Carbonate	Hunt	1844
Iodide		
Sulphate		
Chloride (cuprous)	A. Vogel	1859
Copper plates (iodised)	Kretsch	1841
	Talbot	1841
<i>Manganese.</i>		
Sulphate	Brandenburg	1813
Oxalate	Suckow	1822
Potassium permanganate	Fromberg	1824
Ferrous and cyanide of potassium	Hunt	1844
Chloride	Hunt	1844
<i>Lead.</i>		
Oxide	Davy	1802
Iodide		
Sulphide	Schönbain	1859
Peroxide	Gay-Lussac	1811
Red lead and cyanide of potassium	Hunt	1844
Acetate	Hunt	1844
<i>Nickel.</i>		
Nitrate		
Nitrate with ferro-prussiate	Hunt	1844
Iodide		
<i>Tin.</i>		
Purple of cassius	Uncertain.	
<i>Various Substances.</i>		
Cobalt	Hunt	1844
Arsenic sulphide (realgar)	Sage	1828
Antimony sulphide	Sackow	1832
Bismuth salts		
Cadmium salts	Hunt	1844
Rhodium salts		
Vanadic salts	Roscoe	1874
Iridium ammonium chloride	Döbereiner	1831
Potassium bichromate	Mungo Ponton	1828
Potassium with iodide of starch	Bequerel	1840
Metallic chromates	Hunt	1843
Chlorine and hydrogen	Gay-Lussac and Thénard	1809
Chlorine (titonized)	Draper	1842
Chlorine and ether	Cahours	1810
Chlorine in water	Berthollet	1785
Chlorine and ethylene	Gay-Lussac and Thénard	1809
Chlorine and carbon-monoxide	Davy	1812
Chlorine and marsh gas	Henry	1821
Chlorine and hydrocyanic acid	Savillat	1827
Bromide and hydrogen	Balard	1823

Substance.	Observer.	Date.
Iodine and ethylene	Faraday	1831
Cyanogen, solution of	Palouse and Richardson	1837
Various other methyl compounds	Cahours	1846
Hydrocyanic acid	Torosewicz	1836
Hypochlorites (calcium and potassium)	Döbereiner	1818
Uranium chloride and other	Gehlen	1804
Molybdenate of potassium and tin salts	Jager	1800
Crystallization of salts under influence of light	Petit	1773
	Chaptal	1788
	Disa	1789
	Boeckmann	1800
Phosphorus (in hydrogen, nitrogen, &c.)		
Phosphuretted hydrogen	A. Vogel	1812
Nitric acid	Scheele	1777
Kog's fat	Vogel	1808
Palm oil	Fier	1832
Asphalt	Niepece	1814
Resins (mastic, sandarac, gamboge, ammoniacum, &c.)	Senebier	1782
Guaiaecum	Hagemann	1782
Bitumens all decomposed, all residues of essential oils	Daguerre	1839
Coloured extracts from flowers	Senebier	1782
Similar colouring matters spread upon paper	Herschel	1848
Yellow wax bleached	Pliny	1 cent. A.D.
Eudoxia macrombolitica (purple dye)		10th cent.
	Cole	1684
Other purple dyes	Réaumur	1711
Oils generally	Senebier	1782
Nitric ether	Senebier	1782
Nicotine	Henry & Boutron-Charlard	1836
Banantine	Merk	1838

*Bibliography.*—Hardwich and Taylor, *Photographic Chemistry* (9th ed., 1883); Abney, *Text-Book of Photography* (1878), *Instruction in Photography* (1874); 6th ed., 1884); *Essentials of Photography* (1878), and *Photographic Optics*, 1884; Burton, *Modern Photography* (3d ed., 1883); Robinson and Abney, *Silver Printing* (1880); Eder, *Chemical Effects of the Spectrum* (Eng. tr., by Abney, 1884); Hepworth, *Photography for Amateurs* (1884); and Hunt, *Researches on L.*, (1854).

THE CAMERA.

Any article descriptive of photography would be incomplete without a brief notice of the development of the camera. The inventor of the camera obscura was Giambattista della PORTA (q.v.), who was born at Naples about 1540. Except as a scientific toy, his apparatus was not of any practical use, though it is the parent of the apparatus which have grown up with photography. The principles which govern photographic lenses have been briefly given under LIGHT (vol. xiv. p. 593 sq.) and OPTICS (vol. xvii. p. 803 sq.), and we need only state here that the finest camera which can be manufactured is useless unless the lens with which it has to be worked gives a flat field and an approximately achromatic image.

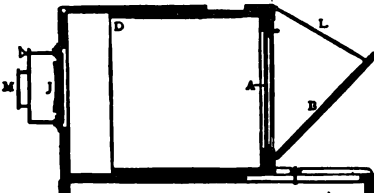
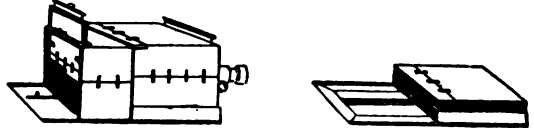

Fig. 4.—Daguerre's Camera. M, stop of lens; J, lens; A, ground glass plate, on which the image formed by the lens is thrown, and for which the sensitive plate is substituted; B, a mirror held at 45° by means of A, on which the operator viewed the image on the ground glass. The focus was obtained by sliding the inner box D towards or from the lens according to Hunt (*Photography*, 4th ed., p. 39), by which it will be seen that at first the idea existed of moving the plate away from the camera.

The first camera made in England, as far as is known, was that by Mr Palmer of Newgate Street, London, on the plan of Mr Fry and for him, in 1839. It was a very primitive apparatus, and was furnished with a lens made in the same year. The ordinary form of camera was simply a box, at one end of which was a lens, and at the other a ground glass for focusing, for which could be substituted a dark slide holding a sensitive plate. The adjustment of the focus was made by a rack and pinion motion attached to the lens. The arrangement, however, subsequently introduced for obtaining a rough approximation to focus was to have a sliding inner box as in Daguerre's camera; and finally to obtain the greatest sharpness the rack and pinion motion attached to the lens was used. It is evident that this form of camera has an advantage over the single box, since it allows more than one lens to be used. Ottwill's folding camera was a great improvement, in that, for outdoor work, it enabled a cumbersome article to be folded up into a compact space. Figs. 5 and 6 show it set up for use, and folded. A still more portable form was made by Mr George Edwards of Carlton Colville (Suffolk) in 1853, and for it he obtained the medal of the Society of Arts. Its portability is shown by the fact that for a 7-inch by 5½-inch plate its weight was only 2 lb 3 oz. Broadly speaking its principle was that of a couple of frames attached by screws to a solid bar, one of

which carried the dark slide and the other the lens. The two were connected together and enclosed in a cloth bag, which in reality



was the camera. This instrument is still used at the present day. It did not come into general use owing to its complicated arrangement of screws,—for the main point in any camera is that there should be as few loose screws as possible. The next improvement is that known as the bellows form, originally introduced, it is believed, by Captain Fowke, R. E., about 1854. Its introduction may be said to mark a new era in camera construction, and from that time to the present the bellows is to be found in nearly every improved form. After this invention the square instead of the tapering form of bellows was that most generally adopted. It is unnecessary to trace every improvement that has been introduced, but we give two typical



FIG. 7.—Hare's Camera.

ones (figs. 7 and 8), which are manufactured by Hare and Meagher respectively. It will be noticed that in both these cameras there

is an arrangement by which the focusing screens can be made to tilt at an angle with the axis of the lens. This is called a swing-back arrangement, and is necessary when photographing architectural subjects to prevent vertical lines converging in the picture. When the ground glass is in a vertical plane, no matter what tilt is given to the camera, vertical lines will always be shown as parallel in the picture. It will also be noticed that in these cameras there is an arrangement for focusing the lens by means of a rack and pinion motion in fig. 7, and by means of a screw in fig. 8. The gradual motion which can thus be given to the focusing screen is a great advantage, since lenses need not be constructed with rack and pinion motion. Many suggestions have been put forward for adapting

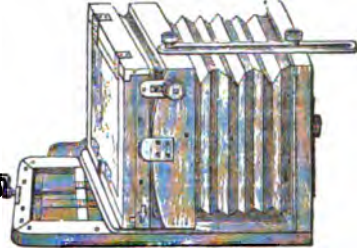

FIG. 8.—Meagher's Camera.

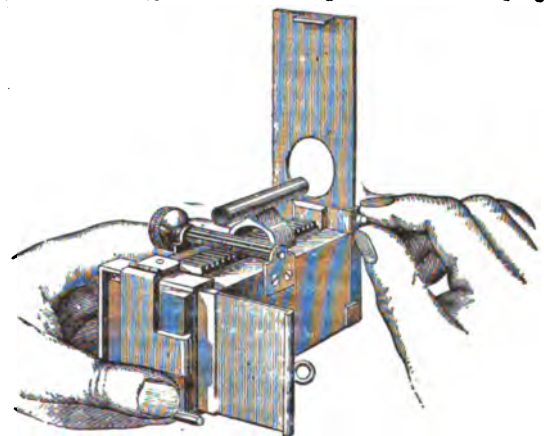

FIG. 9.—Marion & Co.'s Camera.

the camera for a developing chamber, and we believe Archer's could be used for this purpose. Mr Newton in 1852 introduced a camera in which wet plates after exposure were developed by dipping in troughs of solutions; and we might name many others who sub-



sequently worked at the same idea. It met, however, with no very great success. The introduction of dry plates was a great step for the landscape photographer, as it enabled him to carry a supply of plates in the field, and to develop them at home. To economize space and weight, what are known as "double backs" were invented. A "double back" is a dark slide in which two plates are placed back to back, being separated by an opaque plate. Each side of the slide can be drawn up or out so as to expose each plate. What are known as changing boxes answer the same purpose. They hold from one to two dozen plates, and by means of a special arrangement each plate can be conveyed to or removed from the dark slide without exposure to light. There are other plans also by which a certain number of plates can be carried in the camera itself and exposed in succession. The writer's opinion of such

instruments is that they possess no striking advantage and many disadvantages, unless for very special purposes. Even for a miniature camera for taking instantaneous street views whilst holding the apparatus in the hand the use of double backs is to be preferred. An excellent specimen is a camera made by Marion & Co. of London (see fig. 9): it is entirely of metal, and fitted with a finder and instantaneous shutter,—one which should stand any amount of rough usage. The whole apparatus, including a dozen plates, can easily be carried in the pocket. The dark slides are strongly made of metal.

In the preceding sketch, brief though it is, of the successive improvements in cameras, probably enough has been said to show the very remarkable development that has taken place since the days when a cigar-box and spectacle lens were used to obtain an image on a sensitive plate. (W. DE W. A.)

**PHOTOMETRY, CELESTIAL.** The earliest records that have come down to us regarding the relative positions of the stars in the heavens have always been accompanied with estimations of their relative brightness. With this brightness was naturally associated the thought of the relative magnitudes of the luminous bodies from whence the light was assumed to proceed. Hence in the grand catalogue of stars published by Ptolemy (c. 150 A.D.), but which had probably been formed three hundred years before his day by Hipparchus, the 1200 stars readily visible to the naked eye at Alexandria were divided into six classes according to their lustre, though instead of that term he uses the word *μέγεθος* or "magnitude"; the brightest he designates as being of the first magnitude, and so downwards till he comes to the *minimum visibile*, to which he assigns the sixth. These magnitudes he still further divides each into three. To those stars which, though ranged in any particular order of brightness, nevertheless exceed the average of that order in lustre he attaches the letter  $\mu$ , the initial letter in *μείωσις* (greater), and to those in the same order which exhibit a lustre inferior to that of the average he affixes the letter  $\epsilon$ , the initial letter of *ἐλάττωσις*. With this sort of subdivision he passes through all the six orders of magnitude. He does not, indeed, tell us the precise process by which these divisions were estimated, but the principle involved is obvious. The eye was here made the natural photometer, and it is certain that even in the instances where modern instrumental appliances are called into requisition the ultimate appeal is made to perception by the eye. Moreover, it is one of the many remarkable instances of the acuteness and precision of the Greek mind that for upwards of 1500 years no real improvement was made in these estimations of lustre by any of Ptolemy's numerous successors in this field of research. Flamsteed was the first astronomer who extended the estimation of magnitude to stars visible only by the telescope, and he improved Ptolemy's notation by writing 4.3 instead of  $\delta, \mu$ —indicating thereby an order of magnitude brighter than the average of a fourth, but inferior to that of a third—and 3.4 for  $\delta, \epsilon$ , and so on. Later astronomers have sometimes adopted a more precise nomenclature by subdividing the several orders decimally, but it does not appear that by any immediate and unaided effort the eye can estimate subdivisions of lustre exceeding the thirds adopted by the Greek philosopher.

It was not till the year 1796 that any real advance was made in stellar photometry. Sir W. Herschel, instead of assigning a particular magnitude to stars, arranged them in small groups of three or four or five, indicating the order in which they differed from each other in lustre at the time of observation. This method was admirably adapted to the discovery of any variations in brightness which might occur in the lapse of time among the members of the group. Sir William observed in this way some 1400 stars, published in catalogues scattered through the *Philosophical Transactions* from 1796 to 1799; but he discontinued the work before its conclusion. It might be urged that such

a work touches on no human interests, but it rightly seemed otherwise to the philosophic mind of the great astronomer. He remarked that the sun is, after all, only one among the stars, and that what befalls them in the way of varying light as time proceeds may also befall the sun. He puts the question, "Who would not wish to know what degree of permanency we ought to ascribe to the lustre of our sun! Not only the stability of our climates, but the very existence of the whole animal and vegetable creation itself, is involved in the question. Where can we hope to receive information upon the subject but from astronomical observations!"<sup>1</sup> These researches of the elder Herschel were in due time followed by those of his son, Sir John, about the year 1836 at the Cape of Good Hope. He both extended and improved the methods adopted by his father at Slough, and by a method of estimated sequences of magnitude he hoped to arrange all the stars visible to the naked eye at the Cape or in England in the order of their relative lustre, and then to reduce his results into the equivalent magnitudes adopted by the universal consent of astronomers. Sir John, however, like his father, left this important labour incomplete. Not only is the work one of great and continuous effort, but the effects of ever-varying meteorological conditions greatly impede it. Moreover, there is an unsatisfactory indefiniteness attending all estimations made by the unaided eye; numerical or quantitative comparisons are out of the question, and hence we find Sir John, in the very midst of establishing his "sequences," adopting also an instrumental method which might lead him to more definite results.

In the year when Sir John Herschel concluded his photometric work at the Cape (1838) Dr Argelander commenced, and in 1843 completed, his *Uranometria Nova*, in which the magnitudes of all stars visible to the unaided eye in central Europe are catalogued with a precision and completeness previously unknown. It contains 3256 stars, and although it will probably be superseded by instrumental photometry it must ever remain a monument of intelligent patience. Argelander's labours were confined to stars visible to the naked eye; by the aid of his assistants, Dr Schönfeld and Dr Krüger, a catalogue of magnitudes and celestial coordinates was ultimately published in their well-known *Durchmusterung*, extending to the enormous number of 324,000 stars.

Dr Gould also, in his *Uranometria Argentina*, has done similar work for stars visible only in the southern hemisphere, and with the aid of his colleagues has attained to an exactness and precision in his estimations of stellar lustre certainly not hitherto surpassed. There have been other worthy labourers in the same field, each of whom has rendered efficient service, such as Dr Heis and M. Houzeau; but it is chiefly to the labours of Argelander and Gould that astronomers at present make their appeal.

It is to Sir John Herschel that we are indebted for the first successful attempt at stellar photometry by what may

<sup>1</sup> *Phil. Trans.*, 1796, p. 184.



be termed "artificial" means. By the aid of appliances of the simplest kind he deflected the light of the moon (by means of the internal reflexion of a rectangular prism) through a small lens 0.12 inches in diameter and of very short focus, 0.2253 inches, so as to form a sort of artificial star in its focus. By the instrumentality of strings and a wooden pole he could move this artificial star of comparison so as to be in the same line of sight with any actual star whose light he proposed to measure. Other strings enabled him to remove this microscopic lunar image to such a distance from the eye that its light was adjudged to be sensibly the same as that of the star compared. The distance of the short focused lens with the image contiguous to it was measured by a graduated tape, and the inverse squares of these distances afforded relative numerical measures of the brightness of the several stars thus brought into ocular juxtaposition with the equalized light of the tiny lunar image. In this way he proceeded with the observations of a considerable number of stars, and these, by appropriate methods, were reduced so as to afford the means of the comparison of their relative brightness when set side by side with results obtained by means of his "sequences," and with the estimated magnitudes of preceding astronomers. Sir John, however, did not go on to the formation of a complete "uranometria." While he was thus busy at the Cape of Good Hope, Steinheil at Munich had completed for Dr Seidel an instrument nearly the same in principle but more manageable in form. He divided the small object-glass of a telescope into two halves, one of which was movable in the direction of its axis. The images of two stars whose light he desired to compare were formed by the intervention of prismatic reflexion, nearly in the same line of sight, and one of the lenses was then moved until the light of the two stars near the respective foci of the semi-lenses seemed equal to the judgment of the observer's eye. The distance through which it was necessary to bring the movable lens furnished the data for comparing the relative lustre of the two stars in question. A large amount of work was thus achieved by Seidel, which for a considerable time has been, with greater or less reason, regarded as worthy of confidence in regard to precision (*Trans. Mus. Acad.*, vol. ii.). Dr Zöllner substituted the deflected and reduced image of a lamp for one of Steinheil's stars, and the intensity of this light, or artificial star, he could by means of double refraction reduce in any measurable proportion he pleased according to the well-known relations of polarized light. In this way he could equalize the light of the artificial lamp-star with that of the real star with which he compared it; and the division of the lens was thus dispensed with, but a new difficulty was introduced in the impossibility of maintaining the constancy of the flame. Dr Zöllner also availed himself of the effects of double refraction in altering at will the colour of his artificial star of comparison. This ingenious form of photometer has enjoyed considerable reputation, but no astronomer has yet persevered in producing a complete "uranometria" by its aid. The most recent and probably the most successful device for a stellar photometer on the principle of equalising lights is that invented by Professor Pickering of Harvard College. He deflects the light of Polaris, or of some other star such as  $\lambda$  Ursæ Minoris, by means of prismatic reflexion, and he contrives to form an image of it contiguous to the image of any other star selected on the meridian. The equalization of the lights is then effected by the intervention of a polarizing apparatus, such as that adopted by Zöllner. Thus the artificial and in many respects objectionable lamp-star of Zöllner is dispensed with. Professor Pickering, with singular inventive power, has devised many other forms of stellar photometers on virtually the same principle; for a detailed

account of these labours the reader is referred to the *Annals of the Harvard College Observatory* (vol. xi.). Unlike his eminent predecessors, the American astronomer is persevering in the formation of a complete catalogue of star-magnitudes.

It has been already stated that mere estimations of relative brightness by the unaided eye are inadequate to the production of numerical quantitative results. In the instrumental devices explained, whether by means of the alteration of distances or by the known alteration of planes of polarization, no such defect exists. By their means it is possible to obtain a fairly exact numerical expression for the ratio of the intensities of the two lights measured. On applying a photometric measurement it is found that the ratio of the intensities of the lights in passing from one magnitude to the next, even in the conventional magnitudes of Argelander and Gould, is not by any means constant, and even hardly definite. At the suggestion of Mr Pogson it is now generally accepted by astronomers that the adopted and conventional ratio of the intensity of light in passing from one magnitude to another shall be 2.512, a convenient number because its logarithm is .4, which is easily remembered, and still more so because on the whole it agrees better than any other number with the varying light-ratio existing among the hitherto received orders of magnitude obtained by eye-estimation alone.

There remains still another principle on which a stellar photometer may be successfully formed, and which has been recently largely applied to the determination of star-magnitudes at the university observatory, Oxford. It is constructed on the principle that the absorption of light in passing through a uniform medium depends, *ceteris paribus*, upon the thickness. On this principle a thin wedge is constructed of homogeneous and nearly neutral-tinted glass, through which the images of stars formed in the focus of a telescope are viewed. Simple means are contrived for measuring with great exactness the several thicknesses at which the light of these telescopic star-images is extinguished. In this way the light of any star can be readily compared with that of Polaris (or any other selected star) at the moment of observation, and thus a catalogue of star-magnitudes can be formed. This method has been already applied by Professor Pritchard to all the brighter stars north of the equator; the results are published in the forty-seventh volume of the *Memoirs of the Royal Astronomical Society*, and are to be speedily followed by a complete catalogue, extending to all the stars in Argelander's *Uranometria Nova* north of the equator, and to a few others beyond. For the details of the processes adopted the reader must here, as in all other cases, consult the original researches.

Even in a rapid sketch of so extensive a subject some notice must be taken of the application of photometry to the determination of the relative amount of light received on the earth from the sun, the moon, and the planets. The methods by which these ratios have been obtained are as simple as they are ingenious; and for them we are mainly indebted to the labours of Bouguer and Bond. The former philosopher compared the light received from the sun with that from the moon in the following fashion in 1725. A hole one-twelfth of a Paris inch was made in the shutter of a darkened room; close to it was placed a concave lens, and in this way an image of the sun 9 inches in diameter was received on a screen. Bouguer found that this light was equal to that of a candle viewed at 16 inches from his eye. A similar experiment was repeated with the light of the full moon. The image now formed was only two-thirds of an inch in diameter, and he found that the light of this image was comparable with that of the same candle viewed at a distance of 50 feet. From

these data and a very simple calculation it followed that the light of the sun was about 256,289 times that of the moon. Other experiments followed, and the average of all the results was that the light of the sun was about 300,000 times the average light of a full moon, both being viewed in the heavens at the same altitudes. The details will be found in Bouguer's *Traité d'Optique*. Wollaston in 1829 tried a series of experiments in which the ratio 801,072 was obtained; but the omission of certain necessary precautions vitiates the result (*Phil. Trans.*, 1829). Bond (*Mem. Amer. Acad.*, 1851, p. 295) adopted a different process. He formed the image of the sun on a silvered globe of some 10 inches diameter; the light of this image was reflected on to a small mercurial thermometer bulb; and then this second image was compared with a Bengal light so moved that the lights appeared to be equal. The same process was adopted with the full moon instead of with the sun. The result was that the sun's light was 470,980 times that of the moon. Seidel long before this date had compared the light of the mean full moon with that of Jupiter in mean opposition; his result is 6430. So also this light of Jupiter was found to be 4864 times that of Venus at her brightest; and Jupiter was found to give 8.2 times the light of a Lyre. If, then, these numbers could be accepted with confidence, we should have the means of comparing the light received from the sun with that received from any of the stars. Adopting these precarious numbers on the authorities of Bond and Seidel we have the following results—

Sun's light =	470,980	that of the full moon.
"	= 622,600,000	" Venus at her brightest.
"	= 302,835,000	" Jupiter at mean opposition.
"	= 5,970,500,000	" Sirius.

Lastly, Bouguer, by comparing the light of the full moon viewed at different altitudes with an artificial light, found that the atmosphere absorbs 1877 of the light incident on it at the zenith of any place. Professor Pritchard, from photometric measures taken at Cairo, found this number to be 157. At Oxford it was 209. Thus Bouguer's determination indicates an absorptive capacity in the atmosphere of Brittany just midway between those of Oxford and Cairo. Seidel at Munich expresses "surprise" at finding his own results so nearly accordant with Bouguer's. These numbers, therefore, may be regarded as close approximations to fact.<sup>1</sup> (C. P.)

PHOTOPHONE. See TELEPHONE.

PHRENOLOGY. This name was given by Forster in 1815 to the empirical system of psychology formulated by Gall and developed by his followers, especially by Spurzheim and Combe. At first it was named "cranioscopy," "craniology," "physiognomy," or "zoonomy," but Forster's name was early adopted by Spurzheim, and became that whereby the system is now known. The principles upon which it is based are four: (1) the brain is the organ of the mind; (2) the mental powers of man can be analysed into a definite number of independent faculties; (3) these faculties are innate, and each has its seat in a definite region of the brain; (4) the size of each of these regions is the measure of the power of manifesting the faculty associated with it. While phrenology is thus, on the one hand, a system of mental philosophy, it has a second and more popular aspect as a method whereby the disposition and character of the individual may be ascertained. These two sides of the subject are distinct from each other, for,

<sup>1</sup> Since this article was put in type, Professor Pickering at Harvard College has published his concluded results. Professor Pritchard at Oxford has also completed his photometric measures of some 2000 of the same stars. Taken as a whole, and as comprising the first complete and systematic efforts in a new and difficult line of research, the agreement of the two catalogues may fairly be regarded as very satisfactory, not to say surprising.

while it can only serve as a reliable guide for reading character on the assumption of its truth as a philosophic system, yet the possibility of its practical application does not necessarily follow from the establishment of the truth of its theoretic side.

*History.*—That the phenomena of mind are in some measure connected with the action of the brain has been recognized from a very early age of philosophy. It is true that Aristotle<sup>2</sup> describes the brain as the coldest and most bloodless of bodily organs, of the nature of water and earth, whose chief purpose is to temper the excessive heat of the heart, as the cooler regions of the firmament condense the vapours rising from the earth. In his view, as in that of most of the earlier writers of other nations of antiquity, the heart is the seat of life; to it, not to the brain, the Hebrew writers refer thoughts and affections, while they considered judgment as seated sometimes in the head, sometimes in the kidneys.<sup>3</sup> This was, likewise, the teaching of the ancient Egyptian philosophy; and hence, while many rites were practised and many prayers offered for the preservation of the heart of the deceased, the brains were passed over with very little precaution for their preservation.<sup>4</sup> The influence of the Aristotelian teaching is traceable in that of some of the earlier classic writings on philosophy, as is that of the Hebrews in our own colloquial language; but we learn from Diogenes Laertius<sup>5</sup> that much more accurate physiological views were held by Pythagoras, who believed the mind and the intellect to have their seat in the brain. The theory of Hippocrates was Pythagorean rather than Aristotelian, for, although in one passage in his work *De Cordis* he expresses himself rather doubtfully, yet elsewhere he clearly states that he considers the brain to be the index and messenger of the intellect.<sup>6</sup> The cerebral seat of sense-perception is also taught by Plato,<sup>7</sup> who puts into the mouth of Socrates the theory that the brain is the organ affected by the senses, whereby memory and opinion arise, and from whence knowledge springs. The classic poets also notice this dependence of mind on brain; for example, in the *Clouds* (v. 1276) Strepsiades accuses Amynias of not being in his right mind, and, on being asked why, responds, "You seem to me as if you had had a concussion of the brain."

The two founders of anatomical science, Erasistratus and Herophilus, who lived in the days of Ptolemy Soter, taught not only that the brain was the seat of sensation and of intellect, but also that there was therein a certain degree of localization of function. Erasistratus believed that the sensory nerves arose from the brain-membranes, the motor from the cerebral substance. Herophilus was apparently the first who held that the vital forces resided in and circulated from the ventricles of the brain, at least so we gather from Celsus and the other authors who have preserved his views. By the influence of the writings of Galen,<sup>8</sup> which directly teach that the brain is the seat of

<sup>2</sup> *De partibus animalium*, li. c. 7 (Paris, 1629, p. 986).

<sup>3</sup> In the Chaldee portion of Daniel (li. 28, iv. 5, vii. 1) visions and thoughts are referred to the head. For other particulars as to early views see Nasse on the psychical relations of the heart in *Zeitscr. f. psychische Aerzte*, I, 1818. A few of the later medical writers express similar views; see Santa Cruz, *Opuscula medica*, Madrid, 1624.

<sup>4</sup> *Book of the Dead*, ch. xxvi. xxx.

<sup>5</sup> viii. 30, ed. Cobet, Paris, 1850, p. 211,—"ἄφρονες δὲ καὶ νοῦν, ἢ ἐν τῷ ἐγκεφάλῳ."

<sup>6</sup> "De morbo sacro," in *Opp.*, ed. Kühn, I. 612 sq.; also *Epist.*, iii. 824. Among later writers Livetus of Genoa taught the coextension of soul and body, upon which subject he wrote two books (Padua, 1616). In this connexion may be noted a curious work by Schegkian, *Dialogus de animæ principatu, Aristotelis et Galeni rationes præferens quibus ille cordi, hic cerebro, principatum attribuit*, Tübingen, 1542.

<sup>7</sup> *Phædo*, ch. xlv., Valpy's ed., 1833, p. 128. See also Haller's *Bibl. anat.*, I. 30.

<sup>8</sup> *De usu partium*, ed. Kühn, iii. 700,—"τὰς μὲν οὖν ἀνοητέρας τοῦ τῆς λογιστικῆς ψυχῆς εἰσὶν ἐν ἐγκεφάλῳ, καὶ πνεῦμα ψυχικὸν ἐν

soul and intellect, the Pythagorean doctrine became universally received among philosophers. According to the Galenical theory of life, the animal spirits arising from the brain are conveyed thence by the arteries through the body. These animal spirits have their origin in the ventricles of the brain, and pass thence to the heart. It is true that in one place (viii. 159) he refers their origin to the cerebral substance, but the ventricular theory was that adopted by his followers. This view is held by the Greek physicians,<sup>1</sup> some of whom even speculated on the relation of the intellect to the shape and size of the head. The Arabians adopted the same hypothesis, so we find Averrhoes<sup>2</sup> correcting Aristotle's notion of cerebral physiology in favour of Galen's view. Rhazes<sup>3</sup> also extended this by giving a sketch of a scheme of psychic localization; and Avicenna<sup>4</sup> added to the regions recognized by previous authors by interpolating one of his own. Such of the early Christian authors as had occasion to refer in their writings to the relation of soul to body naturally adopted the teaching of Galen, and suited it to their theology, thereby conferring on it an importance which rendered correction difficult. Thomas Aquinas<sup>5</sup> thus expresses his acquiescence in the theory of localization, as also in a sense does Tertullian.<sup>6</sup>

Early in the 13th century Albertus Magnus<sup>7</sup> gave a detailed description of the distribution of mental and psychical faculties in the head. The anterior region he assigned to judgment, the middle to imagination, and the posterior to memory. A somewhat similar allocation was made by Gordon, professor of medicine in Montpellier (1296),<sup>8</sup> who assigned common sensation and the reception of impressions to the anterior cornua of the lateral ventricles, *phantasia* to the posterior, this power being twofold (*imaginativa* and *cognitiva*), judgment or *estimativa* to the third ventricle, and memory to the fourth.<sup>9</sup> Figures of a similar division were given by Petrus Montagnana<sup>10</sup> and Lodovico Dolce,<sup>11</sup> still later by Ghiradelli<sup>12</sup> of Bologna and by Theodore Gall of Antwerp.<sup>13</sup> That the "vital spirits" resided in the ventricles was doubted by many, and refuted by a few of the anatomists of the 17th century. Bauhin in 1621<sup>14</sup> attacked the old view, and Hoffmann of Altorf

showed that, as the ventricles were closed cavities, they could not transmit any material fluid. That these spirits existed at all was doubted by Alexander Benedictus,<sup>15</sup> Plater,<sup>16</sup> and a few others; but they were believed in by the great majority of 17th and even of 18th century medical writers, many of whom conceived that the ventricles were "semper pleni spiritibus animalibus flammulis similibus, quorum beneficia intelligimus, sentimus, et movemus,"<sup>17</sup> and the opponents of this view were strongly assailed by Riolan and others as revolutionary. The grey matter of the surface of the cerebrum was first recognized as the true dynamic element by Malpighi<sup>18</sup> and Willis.<sup>19</sup> The latter regarded the convoluted surface of the cerebrum as the seat of the memory and the will, the convolutions being intended to retain the animal spirits for the various acts of imagination and memory. Imagination he described as seated in the corpus callosum, sense-perception in the corpus striatum, and *impetus et perturbatio* in the basal parts of the cerebrum above the crura. The thalami he regarded as the centres of sight and the cerebellum of involuntary acts. Columbus<sup>20</sup> ridiculed the idea that the convoluted surface can have anything to do with intellect, as the ass, a proverbially stupid animal, has a convoluted cerebrum. According to his view, the convolutions are for the purpose of lightening the brain and facilitating its movements. Succeeding anatomists simply varied these localizations according to their respective fancies. Lancisi placed sense-perception in the corpus callosum, Vieussens in the centrum ovale majus. Descartes supposed the soul to be seated in the pineal gland, Lotze in the pons Varolii.<sup>21</sup> Meyer considered abstract ideas to arise in the cerebellum, and memory to have its seat at the roots of the nerves.<sup>22</sup>

Of later writers three deserve special notice as having largely prepared the way for the more modern school of phrenology. Unzer of Halle in his work on physiology extended the pre-existing theories of localization. Metzger,<sup>23</sup> twenty years before the publication of Prochaska's work, had proposed to make a series of observations on the anatomical characters of the brains of persons of marked intellectual peculiarity; but it is not known to the present writer whether he ever carried this into effect. In a more special manner Prochaska of Vienna may be looked upon as the father of phrenology, as in his work on the nervous system, published in Vienna in 1784, are to be found the germs of the later views which were propounded in that city twelve years later.<sup>24</sup>

The system formulated by Gall is thus a modern expansion of an old empirical philosophy, and its immediate parentage is easily traced, although, according to Gall's

αδρῆ περιχρῆσθαι πᾶσι τοῖς." See also v. 288, viii. 159, xv. 360. In his *Definitiones medicæ* (467, xix. 459) he says that the brain has a ψυχρὸν ὄργανον, but does not specify in what part the power inheres.

<sup>1</sup> See Paulus Ægineta, Stephens's ed., 1567, cap. 62, col. 363, also Actariuz, *De actionibus et affectibus spiritus animalis*, Paris, 1556, p. 22, a. 7.

<sup>2</sup> *Comment. in Arist.*, Latin tr., Venice, 1550, vi. 73.

<sup>3</sup> "Imaginatio quidem in duobus ventriculis anterioribus perficitur. Cognito vero in medio expletur. Memoria autem posteriorem possidet ventriculum." *De re medica*, Gérard's tr., Basel, 1554, i. p. 9.

<sup>4</sup> *Lib. can.*, 1507, p. 19, and *De naturalibus*, c. 6.

<sup>5</sup> *Summa theologica*, ed. Migne, i. pp. 1094, 1106-7. Prochaska and his translator Laycock (*Mind and Brain*, ii. 168) charge Duns Scotus with holding this view, which most probably he did; he does not express it, however, but simply specifies the cerebrum and its root, the spinal cord, as the source of the nerves along which sensory impulses travel. *Comment. de anima*, Leyden, 1637, i. 515.

<sup>6</sup> *De anima*, cxiv., ed. Franeker, 1597, p. 268.

<sup>7</sup> *Opera*, Leyden, 1651, iii. 124, vi. 20.

<sup>8</sup> *Liber medicus*, Venice, 1494, 101.

<sup>9</sup> Avicenna's fifth region is interposed between *imaginatio* and *estimativa* (*De naturalibus*, c. vi.). Thomas Aquinas combines the last two, which he says are possessed by the same eminence (*op. cit.*, i. 1107). On the other hand, he says of *ratio particularis*, "medicæ assignant determinatum organum, scilicet mediam partem capitis" (l. 1106). <sup>10</sup> *Physiognomia*, Padua, 1491.

<sup>11</sup> *Dialogo nel quale si ragione del modo di accrescere e conservare la memoria*, Venice, 1562, 27. <sup>12</sup> *Physiognomia*, 1670.

<sup>13</sup> *Tabula element. scientiæ*, Roma, 1632.

<sup>14</sup> *Theatr. anat.*, Basel, 1621, iii. 314; Caspar Hoffmann, *De usu cerebri*, Lipsiæ, 1619. See also Spigelius, *De corp. Anasæ fabrica*, Amsterdam, 1645, 296; Varolius, 1591, p. 6; Wepfer, *Historiarum apoplecticarum potissimum anatomis subjectorum auctoria*, Amsterdam, 1681. See also many of the anatomical works of this age, such as those of Fernel, Cabrol, Argentarius, Rolinck, &c.

<sup>15</sup> Alexander Benedictus, *Anatomica*, vol. iii., Basel, 1527. Quercetanus is said by Laycock (following Prochaska) to have assailed this doctrine of spirits,—on what ground is not apparent, as he certainly expresses himself as a believer in the old view; see *Tetrus graviss. lobus capitis affect.*, Marburg, 1606, x. 89. Possibly Prochaska may allude to an obscure passage in the work of the other Quercetanus (Eustachius), *Acroasation in librum Hippocratis*, Basel, 1549, p. 14, not to the better-known Josephus Arminiacus, but he gives no reference.

<sup>16</sup> *Opera*, Basel, 1625, col. 82, 89.

<sup>17</sup> *Jovis opera medica*, Amsterdam, 1663, 32.

<sup>18</sup> "Epist. de cerebro et cort. cereb. ad Fracasatum," in *Opp.*, Geneva, 1685, vol. ii.

<sup>19</sup> *De anima brutorum*, Oxford, 1677, p. 71, "hæ particule subtilissimæ, spiritus animales dictæ, partium istarum substantiæ corticales primo subeunt, exinde in utriusque medullæ," &c., also p. 76 sq.

<sup>20</sup> *De re anatomica*, Frankfurt, 1593, p. 350.

<sup>21</sup> Fechner, *Psychophysica*, ii. 382.

<sup>22</sup> Some of the mediæval views were very fanciful, thus Schabtal Donolo taught that the spirit of life has its seat in the brain-membrane, expanded over the brain and subarachnoid fluid, as the Shekhinah in the heavens arched over the earth and waters. See *Der Mensch als Gottes Ebenbild*, ed. Jellinek, Leipzig, 1854.

<sup>23</sup> *Vermischte medicinische Schriften*, 1764, i. 58.

<sup>24</sup> See Laycock's trans., in *Sydenh. Society's Pub.*, 1851.

account, it arose with him as the result of independent observations. These, he tells us, he began to make at an early age, by learning to correlate the outward appearances and mental qualities of his schoolfellows.<sup>1</sup> Gall's first published paper was a letter in the *Deutscher Merkur* of December 1798, but his principal expositions were oral, and attracted much popular attention, which largely increased when, in 1802, he was commanded by the Austrian Government, at the instance of the ecclesiastical authorities, to discontinue his public lectures. In 1804 he obtained the co-operation of Spurzheim (1776-1832), a native of Long-wich near Treves, who became his pupil in 1800, and proved a powerful ally in promulgating the system. Master and pupil at first taught in harmony, but they found it advisable to separate in 1813; and we find Spurzheim, several years after their parting, declaring that Gall had not introduced any new improvements into his system since their separation (notes to Chenevix, p. 99). "My philosophical views," he also says, "widely differ from those of Gall."

In Paris, where he settled in 1807, Gall made many influential converts to his system. Broussais, Blainville, Cloquet, Andral, Geoffroy St-Hilaire, Vimont, and others warmly attached themselves to it, and countenanced its progress. Gall visited Great Britain, but the diffusion of phrenology there was chiefly due to Spurzheim, who lectured through the country and through America, and, with the aid of his pupil George Combe, soon attracted a large popular following. His most influential disciples were Elliotson, Andrew Combe, Mackenzie, Macnish, Laycock, and Archbishop Whately, and in America Caldwell and Godman. On the opposite side many influential men took up a strongly antagonistic position, prominent among whom were Barclay the anatomist, Rogee, Sir Charles Bell, Sir W. Hamilton, Jeffrey, Brougham, T. Brown, and Sir B. Brodie. The nature of the system rendered it eminently fitted to catch public attention, and it rapidly attained to so great a degree of popularity that in 1832 there were twenty-nine phrenological societies in Great Britain, and several journals devoted to phrenology in Britain and America; of these the *Phrenological Journal*, a quarterly edited chiefly by George Combe with aid from others of the Edinburgh confraternity, notably Sir George Mackenzie and Macnish, "the modern Pythagorean," lived from 1823 to 1847, through twenty volumes. The controversy in many places was heated and often personal, and this largely increased the popular interest. In the *Edinburgh Review* the theory was severely criticized by Thomas Brown, and afterwards in a still more trenchant manner by Jeffrey. In *Blackwood* it was ridiculed by Professor Wilson. Being a subject which lent itself easily to burlesque, it was parodied cleverly in a long rhyme by two authors, "The Craniad," 87 pages long, published in 1817, while, on the other hand, verse was pressed into its service in the rhyme "Phrenology in Edinburgh" in 1824.<sup>2</sup> The best defence of the system was that by Chenevix in the third number of the *Foreign Quarterly*, afterwards reprinted with notes by Spurzheim.

The popularity of phrenology has waned, and few of the phrenological societies now survive; the cultivation of the system is confined to a few enthusiasts such as will be found attached to any cause, and some professional teachers who follow phrenology as a vocation. Like many similar systems, it has a much larger following in America than in Europe. Based, like many other artificial philosophies, on an admixture of assumption and truth,

<sup>1</sup> For a brief sketch of the life of Gall, see GALL, vol. x. p. 37.

<sup>2</sup> Other burlesque and satirical writings were published at this time, notably *The Phrenologist*, a farce by Wade, 1830; *The Hædipice*, or *Phrenology opposed to Divine Revelation*, by James the Less; and *A Hæmet for the Hædipice*, or *Phrenology incompatible with Reason*, by Daniel the Bee.

certain parts will survive and become incorporated into scientific psychology, while the rest will in due course come to be relegated to the limbo of effete heresies.

*The Faculties and their Localities.*—The system of Gall was constructed by a method of pure empiricism, and his so-called organs were for the most part identified on slender grounds. Having selected the place of a faculty, he examined the heads of his friends and casts of persons with that peculiarity in common, and in them he sought for the distinctive feature of their characteristic trait. Some of his earlier studies were made among low associates, in jails, and in lunatic asylums, and some of the qualities located by him were such as tend to become perverted to crime. These he named after their excessive manifestations, mapping out organs of murder, theft, &c.; but as this cast some discredit on the system the names were changed by Spurzheim, who claimed as his the moral and religious considerations associated with it. Gall marked out on his model of the head the places of twenty-six organs as round enclosures with vacant interspaces. Spurzheim and Combe divided the whole scalp into oblong and conterminous patches (see the accompanying figures). Other methods of division and other names have been suggested by succeeding authors, especially by Cox, Sidney Smith (not Sydney), Toulmin Smith, Carus of Dresden, Don Mariano Cubi i Solar, Powell of Kentucky, Buchanan of Cincinnati, Hittel of New York. Some, like the brothers Fowler, raise the number of organs to forty-three; but the system of Spurzheim and Combe is that which has always been most popular in Britain.

Spurzheim separated the component faculties of the human mind into two great groups and subdivided these as follows.

#### I. Feelings, divided into—

1. Propensities, internal impulses inviting only to certain actions.
2. Sentiments, impulses which prompt to emotion as well as to action.
  - A. Lower,—those common to man and the lower animals.
  - B. Higher,—those proper to man.

#### II. Intellectual faculties.

1. Perceptive faculties.
2. Reflective faculties.

In the following list the locality and the circumstances of the first recognition of the organ are appended to the names, which are mostly the inventions of Spurzheim. Gall's names are placed in brackets.<sup>3</sup>

#### Propensities.

(1) Amistiveness (*Instinct de la génération*), median, below theinion; first determined by Gall from its heat in a hysterical widow, supposed to be confirmed by many observations, and referred to the cerebellum.<sup>4</sup>

(2) Philoprogenitiveness (*Amour de la progéniture*), median, on the squama occipitis, and selected as the organ for the love of children because this part of the skull is usually more prominent in apes and in women, in whom the love of children is supposed to be stronger than in men.

(3) Concentrativeness, below the obellion and over the lambda. This is a region of uncertain function, unnoticed by Gall, but described as Inhabitiveness by Spurzheim, because he found it large in cats and in a clergyman fond of his home. It has since been considered by Combe to be the seat of the power of concentration, whereof he believed Inhabitiveness to be a special case.

(4) Adhesiveness (*Amitié*), over the lateral convoluted area of the lambdoidal suture. This region was prominent in a lady introduced to Gall as a model of friendship, and is said by him to be the region where persons who are closely attached put their heads together.

(5) Combativeness (*Instinct de la défense*), above the asterion; it was found by Gall by examining the heads of the most quarrelsome

<sup>3</sup> For topographical purposes Broca's names are adopted as the most convenient for localities on the head.

<sup>4</sup> Apollonius Rhodius speaking of the love of Medea for Jason (*Argonautica*, III. 760-765) says, "δάκρυ δ' αὖτ' ἀφ' ὀφθαλμῶν ἦεν· ἔρως δ' αὖτ' αἰσ' ἄλλοις ἐμπεχούσα διὰ χροῶς, ἀμυβ' ἑσπείας ἴως καὶ ἀσφαλῆς, ἐνδὲν ἑλατὸν βίωσ' ἔχουσι, . . ."

of his low companions whom he had beforehand stimulated by alcohol. It was verified by comparing this region with the same part of the head of a quarrelsome young lady.

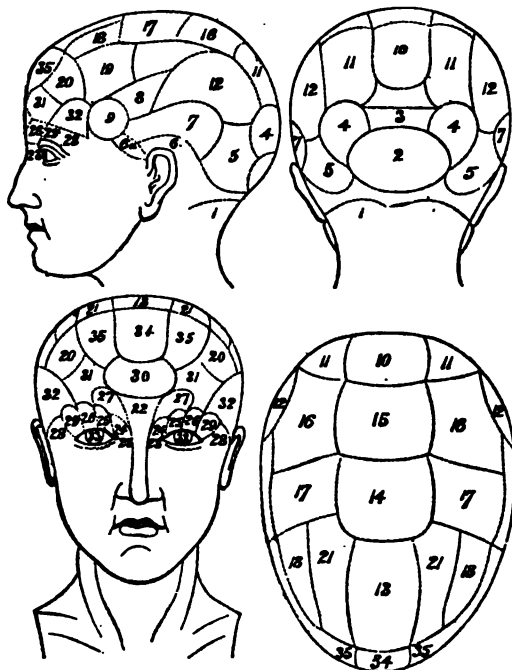

(6) Destructiveness (*Instinct carnassier*), above the ear meatus. This is the widest part of the skulls of carnivorous animals, and was found large in the head of a student so fond of torturing animals that he became a surgeon, also large in the head of an apothecary who became an executioner.

(6a) Alimentiveness, over the temporal muscle and above the ear. Hoppe describes it as being large in a gourmand acquaintance, and he therefore supposes it to be the organ of selecting food.

(7) Secretiveness (*Rese, Finesse*), the posterior part of the squamous suture.

(8) Acquisitiveness (*Sentimens de la propriete*), on the upper edge of the front half of the squamous suture. This part of the head Gall noticed to be prominent in the pickpockets of his acquaintance.

(9) Constructiveness (*Sens de mecanique*), on the stephanion; detected by its prominence on the heads of persons of mechanical genius. It was found large on the head of a milliner of uncommon taste and on a skull reputed to be that of Raphael.

The organ of Vitativeness, or love of life, is supposed by Combe to be seated at the base of the skull. To this locality Herophilus referred most of the intellectual powers.

*Lower Sentiments.*

(10) Self-esteem (*Orgueil, Fieris*), at and immediately over the obelion; found by Gall in a beggar who excused his poverty on account of his pride. This was confirmed by the observation that proud persons held their heads backwards in the line of the organ.

(11) Love of Approbation (*Vanté*), outside the obelion; the region in which Gall saw a protuberance on the head of a lunatic who fancied herself queen of France.

(12) Cautiousness (*Circumspection*), on the parietal eminence; placed here because an ecclesiastic of hesitating disposition and a vacillating councillor of state had both large parietal eminences.

*Superior Sentiments.*

(13) Benevolence (*Bonté*), on the middle of the frontal bone in front of the coronal suture; here Gall noticed a rising on the head of the highly-commended servant of a friend, as well as on a benevolent schoolmate who nursed his brothers and sisters when they were ill. To this spot Xenocrates referred the intellectual powers.

(14) Veneration (*Sentimens religieux*), median at the bregma. Gall noted when visiting churches that those who prayed with the greatest fervour were prominent in this region, and it was also prominent in a pious brother,

(15) Conscientiousness, unknown to Gall; recognised by Spurzheim usually from its deficiency, and placed between the last and the parietal eminence.

(16) Firmness (*Fermété*), median, on the sagittal suture from behind the bregma to the front of the obelion. Lavater first pointed out that persons of determination had lofty heads.

(17) Hope, not regarded as primary by Gall, who believed hope to be akin to desire and a function of every faculty which desires, and left this territory unallocated.

(18) Wonder, said to be large in vision-seers and many psychic researchers. A second similar organ placed between this and the next is called Mysterizingness by Forster, and is said to preside over belief in ghosts and the supernatural.

(19) Ideality (*Poésie*), noted by Gall from its prominence in the busts of poets; said to be the part touched by the hand when composing poetry.

(20) Wit (*Esprit caustique*), the frontal eminence, the organ of the sense of the ludicrous, prominent in Rabelais and Swift.

(21) Imitation (*Faculté d'imiter*), disposition to mimicry, placed between Benevolence and Wonder.

*Percipient Faculties.*

(22) Individuality, over the frontal sinus in the middle line; the capacity of recognizing external objects and forming ideas therefrom; said to have been large in Michelangelo, and small in the Scots.

(23) Form (*Mémoire des personnes*), capacity of recognizing faces; gives a wide interval between the eyes; found by Gall in a squinting girl with a good memory for faces.

(24) Size, over the trochlea at the orbital edge; described by Spurzheim and Vimont as the capacity of estimating space and distance.

(25) Weight, outside the last on the orbital edge and, like it, over the frontal sinus. The prominence of ridge here is due to large sinns or a projecting bone. Certain old writers, such as Strato Physicus, located the whole intellect in this ridge.

(26) Colour, also on the orbital edge external to the last.

(27) Locality (*Sens de localité*), placed above Individuality on each side, and corresponding to the upper part of the frontal sinus and to the region immediately above it.

(28) Number, on the external angular process of the frontal bone, large in a calculating boy in Vienna.

(29) Order, internal to the last, first noted by Spurzheim in an orderly idiot.

(30) Eventuality (*Mémoire des choses*), the median projection above the glabella, supposed to be the seat of the memory of events.

(31) Time, below the frontal eminence and a little in front of the temporal crest.

(32) Tune (*Sens des rapports des tons*), on the foremost part of the temporal muscle, where Gall noticed a bulge on the head of a musical prodigy of five.

(33) Language (*Sens des mots*), behind the eye. This was the first organ noticed by Gall, as a clever schoolfellow, quick at languages, had prominent eyes. Old authors have noted the connexion between prominent eyeballs and mental development; thus Gazzali and Sydenham Medicus Cyprinus place the intellect and soul in and behind the eyeballs.

*Effective Faculties.*

(34) Comparison (*Sagacité comparative*), median, at the top of the bare region of the forehead, where a savant friend of Gall's, fond of analogies, had a prominent brow.

(35) Causality (*Esprit métaphysique*), the eminence on each side of Comparison, noticed on the head of Fichte and on a bust of Kant; the seat of the faculty of correlating causes and effects.

The first identification of each organ was made by an induction from very limited data, but the founders and exponents of the system have collected all available instances wherein enlargements of each of these regions coexisted with increased powers of the faculty supposed to reside therein, and in some cases they have discovered coincidences of a surprising nature. When, however, such do not exist, a convenient excuse is found by reference to the indefinite article of temperament, or by a supposed explanation of the faculty in question as not simple but produced by the co-operation of other influences. Thus, as Sheridan's bump of wit was small, he is said not to have been truly witty, but to have had comparison and memory strongly developed. The girl Labrosse (described in Ferrasse's *Bulletin* for October 1831), who exhibited strong amativeness but had a rudimentary cerebellum, is said to have obliterated it by over-use. Thurtell, a cold-blooded murderer whose organ of benevolence was large, is said to have been generous, as he once gave half a guinea to a friend, &c.

The method whereby the sizes of organs are estimated is arbitrary and the boundaries of the regions indefinite. The attempts of Nicol, Straton, and Wight to devise mechanical and accurate modes of measurement have not been very successful and have not found favour with the professional phrenologist.

*Anatomical Aspect of Phrenology.*—The phrenological controversy served the useful purpose of stimulating research into the anatomy of the brain; but we owe very little of solid progress to the advocates of the system. Gall is the only writer of his creed in whose works original observations of value are to be found. Although the study of the surface of the cerebrum is of the essence of phrenology, yet nowhere in the circle of phrenological literature are the convolutions of the brain accurately described; our knowledge of their order and disposition comes from the morphologist, not from the phrenologist. The first real step towards their systematic description was made by Rolando,<sup>1</sup> who in 1830 described the fissure to which his name is attached, and very little advance was made until the publication in 1856 of Gratiolet's<sup>2</sup> and Huschke's<sup>3</sup> memoirs. These works for the first time placed the description of the surface of the brain, imperfectly attempted by Desmoulins in 1825,<sup>4</sup> on a satisfactory basis. Most of the anatomical details contained in the works on phrenology relate to controversial matters of secondary importance, and presuppose the truth of the theory; but even in connexion with these they give us no statistical details of any value. It would be important, for instance, to have tabulated a sufficiently large number of measurements of the relative thicknesses of scalp and skull in different regions, of the variations in development of the diploe, of the varying range of the frontal sinus; but of these we find no sufficient nor definite researches in the whole circle of books cited below.

As under ANATOMY (vol. i. p. 874) a careful description of the brain has been given, we need only allude to such anatomical points involved in the examination of phrenology as are not included in that account.

1. Any psychological theory which correlates brain-action and mental phenomena requires a correspondence between brain-size and mental power; and, speaking generally, we find that the brains of those whose capacities are above the average are larger than those of the general run of their fellow-men. The details of brain-weights will be found at pp. 879, 880 of the article cited.

2. Direct measurements of the relative developments of different portions of brains are difficult and troublesome to make; but their importance to phrenologists is so great that it is remarkable that no attempts to obtain any such were made by them. The series given by Wagner of the relative sizes of the cerebral lobes of four brains is almost the only record of importance in this direction, and is appended.

Brain of	Surface of Frontal Lobe.	Surface of Parietal Lobe.	Surface of Occipital Lobe.	Surface of Temporo-Sphenoidal.	Relation of Frontal Lobe (Excluding the Opercular and Sphenoidal Organs) to whole Surface = 1.	Relation of Parietal Lobe (Excluding the Sphenoidal) to Surface = 1.	Relation of Remaining Surface (Proprietary) to Surface = 1.	Extent of Free Surface.	Extent of Surface of Involutions.	Total Extent of Surface.	Weight in Grammes.
Fuchs, clinical teacher ....	148.400.8.59	97.5	.419	.908	.840	116.7	231.8	343	1460		
Gauss, mathematician ..	100	70.6	59.4	86.4	.407	.907	.874	112.8	223	341	1458
Workman ....	118.3	82.8	50.8	82	.385	.914	.885	97.4	193	291	1378
Woman .....	180	95	51	96.8	.409	.904	.870	107.8	200.9	317.4	1382

From this it appears that the woman exceeded Gauss in perceptive and reflective organs, exceeded Fuchs in sentiment, and fell below the workman in propensities. It must be said, however, that the phrenological divisions do not accurately coincide with the anatomical. Other series constructed along these lines are very

much wanted, and it would furnish important physiological data if the brains of men distinguished for special qualities were examined in this or some comparable way.

3. It is important in relation to phrenology to ascertain the constancy of the convolutions. Many varieties in the detail of the surface-patterns have been recorded by Tenchini, Poggi, Giacomini, Büdinger, and Sernow,<sup>5</sup> but the general plan is fairly uniform. A still more important question has been recently raised by Langley, viz., how far identical spots on identical convolutions in different brains consist of nerve-cells with precisely the same connexions. The convoluted arrangement results from growth of brain-surface under constraint, hence as the different tracts of surface undergo proportional overgrowth they fold along different lines. The occurrence of small differences in the rate of overgrowth, testified to by the varieties of the resulting pattern, will cause considerable alteration in the place of definite territories of grey cells. Some method for the determination of the limits of these shifting of place is much required.

4. The comparison of the rate of growth of brain with the development of mental faculties is important not only to the phrenologist but to the psychologist. No observations on this point were made by phrenological writers, and they simply refer to the first and rather crude observations of the earlier anatomists. We have, however, recently learned from the researches of Bischoff, Tuzeev, and Exner<sup>6</sup> many particulars as to the rate and progress of brain-growth. At birth the brain weighs one-tenth of the weight of the body, and averages about 11 ounces. For the first year brain-growth and consequently expansion of the skull proceed with great rapidity, the growth during a large part of this period averaging one cubic centimetre daily. This enormous increase is chiefly due to the rapid development of medullated nerve-fibres, which are deficient in the fetal brain. During the second and third years growth takes place more slowly, the occipital and parietal lobes increasing more than the frontal or temporo-sphenoidal. During these and the four succeeding years the base elongates commensurately with the increasing depth of the face. In the sixth and seventh years the frontal lobes grow faster than the parietals, and at seven the average brain has attained the weight of 1840 grammes, being to the weight of the body as 1:20. In the period between seven years and puberty growth is slight, but at puberty the whole brain grows actively, especially the frontal lobes. This activity lasts until about eighteen years of age, then diminishes; but the average brain does not reach its maximum size until about thirty, from a little after which period the brain tends to diminish towards senility.<sup>7</sup> These measurements illustrate the relation between brain-growth and mental development, but are as easily explicable on any psychological theory of brain-action as on the phrenological. The relation supposed by Davaine to subsist between development of the brain and stature is not borne out by statistics.<sup>8</sup>

5. The estimation of the relative development of grey and white matter in the several lobes is important to any theory of cerebral dynamics which allocates functions specifically diverse to each separate part of the brain-surface; but no attempt has been made by the phrenologist to obtain precise results in this direction, nor even to determine the physical constants of the two forms of brain-matter. The recently-introduced method of Bourgoin and Danilewaki, based upon the differing specific gravities of grey and white matter, promises to give definite information as to the relative amounts of these forms of brain-matter; but further experiments are needed to perfect the method.<sup>9</sup>

6. The relations, if any, between the alterations which take place in the shape and position of the head and alterations in brain-surface have been speculated on by the phrenologist. Broussais is reported to have said that his organ of causality had enlarged with increasing use, and a list of cases of similar alterations of head-shape is given by Deville (*Phren. Jour.*, xiv. 32), most of which are simply age-changes, of the kind described by Professor Cleland (*Phil. Trans.*, 1870). There are no exact measurements recorded which indicate the occurrence of topical increases of a normal brain in special directions coincident with the cultivation of definite faculties. All the so-called cases are given vaguely, with no measurements, and the careful measurements of George Combe in such cases as were available to him showed no appreciable alterations in adult heads even at long intervals of time (see also Andrew Combe, *Phren. Journ.* x. 414).

<sup>5</sup> *Rivista Sperimentale di Freniatria*, ii. 193 (1883); *ibid.* iv. 403; *Archiv für Anthropologie*, 1879, xi. 289.

<sup>6</sup> *Neurologisches Centralblatt*, 1883, p. 457.

<sup>7</sup> Weisbach, *Med. Jahrbuch der k. Genesl. der Aerzte*, Vienna, 1869, xvii. 133; Merkel, *Beitr. z. post-embryonale Entwicklung des menschl. Schädels*, Bonn, 1882; Calori, *Mem. de l'Acad. di Bologna*, 1871, x. 35.

<sup>8</sup> Lebon, *Revue d'Anthropologie*, 1879, 15; Marshall, *Proc. Roy. Soc.*, 1876, 504; Engel, *Wiener med. Wochenschrift*, 1863.

<sup>9</sup> *Centralblatt*, 1880, No. 14; *Beiträge zur Biologie*, Stuttgart, 1882.

<sup>1</sup> *Della Struttura degli emisferi Cerebrali*, Turin, 1830.

<sup>2</sup> *Mémoire sur les plis cérébraux de l'homme et des primates*, Paris, 1856.

<sup>3</sup> *Schädel, Hirn, und Serie*, Jena, 1856.

<sup>4</sup> Magendie and Desmoulins, *Anat. du syst. nerveux*, Paris, 1825.



7. The phrenological want of knowledge of the topography of the brain-surface was necessarily correlated with ignorance of the exact relations of the convolutions to the interior of the cranial bones; these have been carefully worked out by Huschke, Heffler, Turner, and Reid. Some latitude, however, must be allowed in topography, as the exact relation of convolution to skull varies with the shape of the skull. Giacomini showed that the fissure of Rolando is perceptibly farther back from the coronal suture in dolichocephalic than in brachycephalic skulls, and it is still farther back in the extreme boat-shaped form of long-headedness. Passet shows that there is a slight topographical difference in the two sexes (*Arch. f. Anthrop.*, 1882, xiv. 89), and in the heads of those with unsymmetrically-shaped skulls there is often a want of lateral symmetry of convolution. Artificial deformations likewise alter the topographical relations of convolutions, and have served not a little to puzzle the phrenologist. Thus, the artificial dolichocephaly of the Caribs having bulged the squama occipitis, they decided that these people must be amiable lovers of children,<sup>1</sup> &c.

8. The existence of structural differences between different areas of cerebral surface is important to any theory of cerebral localization, but no phrenologist has given us any original information on this point. Since the investigation of Baillarger,<sup>2</sup> it has been shown that some local differentiations of structure do really exist. Thus in the convolutions around the fissure of Rolando the ganglion-cells of the fourth layer are of large size (giant-cells of Betz), and in the convolutions of the temporo-sphenoidal lobe a layer of small angular cells (granule-cells) is interposed between the larger pyramidal and the ganglion-cells, so that, while in the parts of the brain above the fissure of Sylvius the grey cortex is for the most part five-layered, below and behind that fissure it is six-layered. There is no abrupt passage from the one to the other, the only sudden transition of structure of the grey cortex being at the hippocampal sulcus; and giant-cells, although of smaller size, and less like those of the anterior cornu of the spinal cord, are scattered over other parts of the cerebral grey matter.<sup>3</sup> In fig. 71, vol. i. p. 874, the relations of the convolutions to the internal surface of the skull are represented, and their want of accurate correlation to the phrenological areas can be seen by comparing that figure with the foregoing series.

The teachings of anatomy with regard to phrenology may be summarized thus: (1) the rate of growth of brain is concurrent with the rate of development of mental faculty; (2) there is some degree of structural differentiation as there are varying rates of development of different parts of the cerebral surface; (3) there is no accordance between the regions of Gall and Spurzheim and definite areas of cerebral surface.

*Physiological Aspect.*—The theory of some of the older metaphysicians, that the mind, in feeling and reflexion, makes use of no material instrument is not now accepted by psychologists. It was advanced by Brougham and Jeffrey as against the theory of phrenology; but the doctrine that the brain is the organ of the mind is now universally received. While it is probable that certain molecular changes in the grey matter are antecedents or concomitants of mental phenomena, the precise nature of these processes, to what extent they take place, or how they vary among themselves have not as yet been determined experimentally; the occurrence of the change can only be demonstrated by some such coarse method as the altered pulsation of the carotid arteries,<sup>4</sup> the increase of the temperature of the head,<sup>5</sup> the abstraction, during brain-acton, of blood from other organs as shown by the plethysmograph, or the formation of lecithin and other products of metabolism in brain-substance. As yet not a single step has been made towards the understanding of the connexion between the molecular changes in the nerve-cell and the phenomena of thought and feeling. While our

knowledge of the anatomy of the brain, especially of the grey nuclei and of the white bands uniting them, has within the last few years become much more accurate, brain-function has not as yet been so definitely determined; indeed, much of nerve-physiology, especially that part which relates to the division of labour in the nerve-centres, is largely hypothetical and based on anatomical structure. Certain masses of grey nerve-matter situated in the spinal cord and medulla oblongata are so linked by nerve-cords to organs outside the nervous system which are set apart for the discharge of separate functions that they obviously form parts of the mechanism for the fulfilment of such functions. In the cases where these can be subjected to experiment we learn that they are nervous centres presiding over the discharge of such functions; and it has been determined by experiment, or else deduced from anatomical structure, that in those lower parts of the nervous centres which are more directly connected with the segmental elements of the body there is a certain localization of function; hence the centres of pelvic actions, of respiration, cardiac action, and inhibition of vaso-motor influence, deglutition, secretions, &c., can be mapped out in ascending series. As certain of these centres are united by bands of fibres to the larger and higher-lying grey portions of the nervous centres there is an *a priori* presumption in favour of the extension of this principle of localization. This has been premised on metaphysical as well as on anatomical grounds. Bonnet believed each portion of the brain to have a specifically separate function, and Herbert Spencer has said that "no physiologist can long resist the conviction that different parts of the cerebrum subserve different kinds of mental action. Localization of function is the law of all organization whatever; separateness of duty is universally accompanied with separateness of structure, and it would be marvellous were an exception to exist in the cerebral hemispheres. Let it be granted that the cerebral hemispheres are the seats of the higher psychical activities; let it be granted that among these higher psychical activities there are distinctions of kind which, though not definite, are yet practically recognizable, and it cannot be denied, without going in direct opposition to established physiological principles, that these more or less distinct kinds of psychical activity must be carried on in more or less distinct parts of the cerebral hemisphere."

For the results of experiment on the brain, see *PHYSIOLOGY*, section "Nervous System."

There is a large weight of evidence, which cannot be explained away, in favour of the existence of some form of localization of function. So little is known of the physical changes which underlie psychical phenomena, or indeed of the succession of the psychical processes themselves, that we cannot as yet judge as to the nature of the mechanism of these centres. So much of the psychic work of the individual life consists in the interpretation of sensations and the translation of these into motions that there are strong *a priori* grounds for expecting to find much of the material of the nerve-centres occupied with this kind of work, but in the present conflict of experimental evidence it is safer to suspend judgment. That these local areas are not centres in the sense of being indispensable parts of their respective motor apparatuses is clear, as the function abolished by ablation of a part returns, though tardily, so that whatever superintendence the removed region exercised apparently becomes assumed by another part of the brain.<sup>6</sup> Experimental physiology and pathology, by suggesting other functions for much of the brain-surface, are thus directly subversive of much of the phrenology of Gall and Spurzheim.

<sup>1</sup> Martins tells us that the Caribs castrate their own children, fatten and eat them, an abuse of the organ of philoprogenitiveness: see also Garcilaso de la Vega, *Hist. des Incas*, i. 12.

<sup>2</sup> *Mém. de l'Acad. de Médecine*, 1840, viii. 149.

<sup>3</sup> For further particulars of structure, in addition to the authors quoted at vol. i. p. 878, see Bevan-Lewis and Clark, *P. R. S.*, 1878, and *Phil. Trans.*, 1880 and 1882.

<sup>4</sup> See Eugène Gley, "Sur les Conditions Physiologiques de la Pensée," in *Archives de Physiologie*, 1881, 742.

<sup>5</sup> Lombard, *N. Y. Med. Journal*, June, 1867, and *Experimental Researches on the Regional Temperature of the Head*, London, 1872.

<sup>6</sup> For cases, see Rochefontaine, *Archives de Physiologie*, 1883, 28; Bianchi, *La Psichiatria*, i. 97.

*Psychological Aspect.*—The fundamental hypothesis which underlies phrenology as a system of mental science is that mental phenomena are resolvable into the manifestations of a group of separate faculties. A faculty is defined as “a convenient expression for the particular states into which the mind enters when influenced by particular organs; it is applied to the feelings as well as to the intellect, thus the faculty of benevolence means every mode of benevolence induced by the organ of benevolence” (Combe). In another work the same author says it is “used to denote a particular power of feeling, thinking, perceiving, connected with a particular part of the brain.” The assumption is contained in the definition that the exercise of a faculty is the physical outcome of the activity of the organ, and in several of the standard works this is illustrated by analogies between these and other organs; thus the organs of benevolence and of firmness are said to be as distinct as the liver and pancreas. The mind, according to another author, consists of the sum of all the faculties. In this view the unity of consciousness is somewhat difficult to explain, and consequently there is assumed by others a single unifying substratum, and on this the organs are supposed to act; thus thoughts are defined as “relations of the simple substance, mind, to certain portions of the encephalon” (Welsh, *Phren. Journ.*, i. 206). Gall himself believed that there was but a single principle which saw, felt, tasted, heard, touched, thought, and willed (*Fonctions du Cerveau*, i. 243); and the American exponent of phrenology, Caldwell, says “the mind is as single in its power as it is in its substance; it is a quickening and operating principle, essential to all the mental faculties, but does not, by any means, possess them itself” (*Elements*, p. 16). It is not easy to understand the supposed relation of this hypothetical substratum to the separate faculties acting on it. It must be both immaterial and unconnected with the brain, as the whole two thousand million cells supposed to exist in the cerebral hemispheres are all parcelled out among the faculties, and none are left for the unifying *nous*.

Each organ is considered as engaged, either independently in bringing forth its own product, or collectively with others in elaborating compound mental states, and according to their several degrees of development and activity they are considered capable of perceiving, conceiving, recollecting, judging, or imagining each its own subject. This mechanical conception of the division of labour in the production of the phenomena of mind has the charm of simplicity, but is attended with the difficulty that arises in discriminating the operations of the different organs one from the other. Phrenologists are apt to be vague respecting the limits of the several faculties, as about the boundaries of the separate organs. It was pointed out by Jeffrey that the lines of demarcation between benevolence, adhesiveness, and philoprogenitiveness were indeterminate, although the organs are not very close, and the same applies to other organs.

It is unfortunate for the clearness of the definition that, although historically the faculties were the first phenomena noted, independent of and previous to their localization, yet in the definition the faculties are defined in terms of their localities.

The following arguments are adduced in favour of the fundamental separateness of the faculties: (1) analogy,—elsewhere in the animal economy division of labour is the rule; (2) the variety of mental endowment observed among children before they are influenced by education, and the inequalities in the mental endowments of individuals; (3) the phenomena of insanity, especially of inomania; (4) the varying periods at which individual faculties attain their maximum development; (5) the

phenomena of dreams, and the awakening of a limited number of faculties during them; (6) pain being felt in an organ when it is overtaxed.<sup>1</sup>

Such faculties are supposed to be primary—(1) as exist in some animals and not in others, (2) as vary in their development in the sexes, (3) as are developed in varying proportions with regard to other faculties, (4) as may act separately from other faculties, (5) as are not necessarily simultaneous with other faculties in action, (6) as are hereditary, and (7) as may be singly diseased.

According to the development of their powers mankind may be divided into six classes: (1) those in whom the highest qualities are largely developed and the animal qualities feeble; (2) those with the reversed conditions developed, with large animal and feeble intellectual and moral faculties; (3) those in whom good and evil are in constant war, with active animal and strong intellectual faculties and sentiments; (4) those partial geniuses in whom a few qualities are unusually developed, while the rest are at or below the mediocre standard; (5) those men of moderate endowment in whom some faculties are nearly or quite deficient; (6) those with an unvarying standard of undistinguished mediocrity in all their faculties.

It is perhaps unfortunate that the word “faculty” has been used in this sense of original power by phrenologists. It would have been better to employ, as Mr Lewes suggests, the term “function” for the native activity of an organ, and to leave “faculty” for the expression of an acquired activity. “Faculty is properly limited to active power, and therefore is abusively applied to the mere passive affections of the mind” (Hamilton, *Lectures*, i. 177).

*Practical Application.*—“Die Schädellehre ist allerdings nicht so sehr Irrthum in der Idee als Charlatanerie in der Ausführung,” says one of its most acute critics. Even though no fault could be found with the physiology and psychology of phrenology, it would not necessarily follow that the theory could be utilized as a practical method of reading character; for, although the inner surface of the skull is moulded on the brain, and the outer surface approximates to parallelism thereto, yet the correspondence is sufficiently variable to render conclusions therefrom uncertain. The spongy layer or diploe which separates the two compact tables may vary conspicuously in amount in different parts of the same skull, as in the cases described by Professor Humphry (*Journ. of Anat.*, vol. viii. p. 137). The frontal sinus, that *opprobrium phrenologicum*, is a reality, not unfrequently of large size, and may wholly occupy the regions of five organs. The centres of ossification of the frontal and parietal bones, the muscular crests of these and of the occipital bones also, differ in their prominence in different skulls. Premature synostoses of sutures mould the brain without doing much injury to its parts. Artificial malformations alter the apparent skull-shape considerably and affect the relative development of the brain but little. All these and other cogent reasons of a like kind, whose force can be estimated by those accustomed to deal with the component soft parts of the head, should lead phrenologists to be careful in predicating relative brain-development from skull-shape. Psychology, physiology, and experience alike contribute to discredit

<sup>1</sup> It is interesting in this connexion to note that in a case published by Professor Hamilton in *Braïn* (April 1884), where a tumour existed on the occipital lobe, the pain was persistently referred to the forehead. Many similar cases are to be noticed among the records of localised brain-lesions. Bearing on this point also it is worth noting, once for all, that in nothing is the purely hypothetical nature of phrenological description better realised than in the accounts of what these authors call the “natural language of the faculties,”—that poets are supposed to touch ideally when composing, musicians to press on tone and time, and painters on form and colour, when in the exercise of their arts! Yet we are gravely taught this in the standard works on the subject.

the system and to show how worthless the so-called diagnoses of character really are. Its application by those who are its votaries is seldom worse than amusing, but it is capable of doing positive social harm, as in its proposed application to the discrimination or selection of servants and other subordinate officials. It has even been proposed to use it for the purposes of the guarantee society and for the selection of parliamentary representatives. The sarcastic suggestion which originated with Christopher North of moulding children's heads so as to suppress the evil and foster the good was actually repeated in good faith by a writer on phrenology, but experience of the effects of malformation leads one to be sceptical as to the feasibility of this mode of producing a social Utopia. The application of phrenology to the art of painting and sculpture has been suggested, but a careful examination of some of the best pictures of the best masters, who were close observers of nature, shows that no phrenological principles were accepted by them in their works. An application to ethnology has also been proposed; but, although there are in most cases well-marked racial characters presented by the skull, yet all attempts at correlating national characteristics therewith have been groundless and worthless. For further particulars on allied subjects, see **PHYSIOGNOMY**.

**LITERATURE.**—Prochaska, *Functions of the Nervous System* (tr. by Laycock, in Sydenham Society's series, 1851); Gall, *Recherches sur le Système Nerveux*, &c. (Paris, 1809), *Anatomie et Physiologie du Système Nerveux*, &c. (Paris, 1810-19), *Traité des Dispositions innées de l'Âme et de l'Esprit* (Paris, 1811), and *Sur les Fonctions du Cerveau* (6 vols., 1826); Beryk, *Bemerkungen u. Zweifel über die Schädellehre des Dr. Gall's* (Leipzig, 1803); Marton, *Leichtfassliche Darstellung der Gehirn- u. Schädellehre* (Leipzig, 1803); Metzger, *Ueber den menschlichen Kopf* (Königsberg, 1803); Walther, *Neue Untersuchungen der Gall'schen Gehirn- und Schädellehre* (Munich, 1804); Kessler, *Prüfung des Gall'schen Systems* (Jena, 1805); Bischoff, *Darstellung des Gall'schen Gehirn- und Schädellehre*, &c. (Berlin, 1805); Ackermann, *Die Gall'sche Gehirnlehre widerlegt* (Heidelberg, 1806); Himly, *Erörterung der Gall'schen Lehre* (Halle, 1806); Forster, "Sketch of the New Anatomy and Physiology of the Brain," in *Pamphleteer* (1815, No. ix., reprinted with additions 1817); Spurzheim, *The Physiognomical System of Gall and Spurzheim* (London, 1815), *Phrenology, or the Doctrine of the Mind* (1825), and *The Anatomy of the Human Brain* (1826); Gordon, *Observations on the Structure of the Brain, comprising an estimate of the claims of Gall and Spurzheim*, &c. (1817); G. Combe, *Essays on Phrenology* (Edinburgh, 1819), *Elements of Phrenology* (1824), *System of Phrenology* (1825), *Constitution of Man* (1827), *Lectures on Phrenology* by Boardman (1839), and *Outlines of Phrenology* (1847); Dewhurst, *Guide to Human and Comparative Phrenology* (London, 1831); Otto, *Phrenologie aller Galle und Spurzheim's Hjerne- og Organlære* (Copenhagen, 1825); Broussais, *Cours de Phrenologie* (Paris, 1836); Vimont, *Traité de Phrenologie humaine et comparée* (1836); Noel, *Grundzüge der Phrenologie* (Leipzig, 1836), and *Die materielle Grundlage des Seelenlebens* (Leipzig, 1874); Maanish, *Introduction to Phrenology* (Glasgow, 1836); Capen, *Phrenological Library* (Boston, 1836); Ferraresi, *Memorie riguardanti la Dottrina Frenologica* (1836-38); Watson, *Statistics of Phrenology* (1836); Assis, *Traité de la Phrenologie* (Paris, 1839); Sidney Smith, *Principles of Phrenology* (Edinburgh, 1838); Joshua T. Smith, *Synopsis of Phrenology*; Forichon, *Le Matérialisme et la Phrenologie combattus* (Paris, 1840); K. G. Carus, *Grundzüge einer neuen und wissenschaftlich begründeten Kranioskopie* (Stuttgart, 1841); Castle, *Die Phrenologie* (Stuttgart, 1845); Struve, *Geschichte der Phrenologie* (Heidelberg, 1843); Idjicz, *Cours de Phrenologie* (Paris, 1847); Flourens, *Examen de la Phrenologie* (Paris, 1843); Serrurier, *Phrenologie Morale* (Paris, 1840); Mariano Cubi i Solar, *Leçons de Phrenologie* (Paris, 1857); Morgan, *Phrenology*; Donovan, *Phrenology*; Struve and Hirschfeld, *Zeitschrift für Phrenologie* (Heidelberg, 1843-45); *Phrenological Journal* (20 vols., 1823-47); Lélut, *Qu'est ce que la Phrenologie?* (1836), and *Réjet de l'Organologie phrenologique* (1845); Tupper, *Enquiry into Dr Gall's System* (1819); Wayte, *Anti-phrenology* (1829); Stone, *Observations on the Phrenological Development of Murderers* (Edinburgh, 1829); Epps, *Horæ Phrenologicae* (1829); Crock, *Compendium of Phrenology* (1878); Aken, *Phrenological Bijou* (1839); Hall, *Phreno-Magnet* (1843). (A. M.A.)

See Vol. XV Plate II.

**PHRYGIA** was the name of a large country in Asia Minor, inhabited by a race which the Greeks called Φρύγες, *Freemen*.<sup>1</sup> Roughly speaking, Phrygia comprised the

western part of the great central plateau of Anatolia, extending as far east as the river Halys; but its boundaries were vague,<sup>2</sup> and varied so much at different periods that a sketch of its history must precede any account of the geography. According to unvarying Greek tradition the Phrygians were most closely akin to certain tribes of Macedonia and Thrace; and their near relationship to the Hellenic stock is proved by all that is known of their language and art, and is accepted by almost every modern authority. The country named Phrygia in the better known period of history lies inland, separated from the sea by Paphlagonia, Bithynia, Mysia, and Lydia. Yet we hear of a Phrygian "thalassocracy" at the beginning of the 9th century B.C. The Troad and the district round Mount Sipylus are frequently called Phrygian, as also is the seaport Sinope; and a district on the coast between Sestus and the river Cius was regularly named Little Phrygia. Again, Abel<sup>3</sup> has pointed to the wide currency of names like Mygdones, Doliones, and Phryges or Briges both in Asia Minor and in Europe, and many other examples might be added. The inference has been generally drawn that the Phrygians were a stock widespread in the countries which lie round the Ægean Sea. There is, however, no decisive evidence, and no agreement among modern scholars, as to whether this stock came from the East over Armenia, or whether it was European in origin and crossed the Hellespont into Asia Minor.

According to Greek tradition there existed in early time a Phrygian kingdom in the Sangarius valley, ruled by kings among whom the names Gordius and Midas were common. It was known to the ancient Greeks of Ionia and the Troad as something great and half-divine. When the goddess appeared to her favourite Anchises she represented herself as daughter of the king of Phrygia; the Phrygians were said to be the oldest people, and their language the original speech of mankind;<sup>4</sup> the Phrygian kings were familiar associates of the gods, and the heroes of the land tried their skill against the gods themselves; we hear of the well-walled cities of Phrygia and of the riches of its kings. Tradition is completely corroborated by archaeological evidence. In the mountainous region on the upper waters of the Sangarius, between Kutayah and Afium Kara Hissar, there exist numerous monuments of great antiquity, showing a style of marked individuality, and implying a high degree of artistic skill among the people who produced them. On two of these monuments are engraved the names of "Midas the King" and of the goddess "Kymbile the Mother." Even the title "king" (δναξ)<sup>5</sup> appears to have been borrowed by Greek from Phrygian.

It is impossible to fix a date for the beginning of the Phrygian kingdom. It appears to have arisen on the ruins of an older civilization, whose existence is revealed to us only by the few monuments which it has left. These monuments, which are found in Lydia, Phrygia, Cappadocia, and Lycaonia, point to the existence of a homogeneous civilization over those countries; they show a singularly marked style of art, and are frequently inscribed with a peculiar kind of hieroglyphics, engraved *doustrophedon*, which have not as yet been deciphered.<sup>6</sup> There can be

<sup>1</sup> The difficulty of specifying the limits gave rise to a proverb—*ὄχις τὸ Φρυγίον*, Strabo.

<sup>2</sup> Art. "Phryges," in Pauli's *Real-Encykl.*

<sup>3</sup> Herod., ii. 2; Pausan., i. 14, 2; Claudian, *In Eutrop.*, l. 251; Apul., *Met.*, xi. p. 762.

<sup>4</sup> Favacrus on the Midas tomb. It is expressly recorded that *ῥίπαρος* is a Lydian word. *Βασίλευς* resists all attempts to explain it as a purely Greek formation, and the termination assimilates it to certain Phrygian words.

<sup>5</sup> It is common to name these monuments "Hittite," but this name presupposes the truth of an historical hypothesis, namely, the conquest of Asia Minor by a race whose capital was in Syria, which has not as yet been supported by any convincing arguments.

traced in Asia Minor an ancient road-system, to which belongs the "royal road" from Sardis to the Persian capital, Susa (Herod., v. 55). The royal road followed a route so difficult and circuitous that it is quite unintelligible as the direct path from any centre in Persia, Assyria, or Syria to the west of Asia Minor. It can be understood only by reference to an imperial centre far in the north. The old trade-route from Cappadocia to Sinope, which had passed out of use centuries before the time of Strabo (pp. 540, 546), fixes this centre with precision. It must be far enough west to explain why trade tended to the distant Sinope,<sup>1</sup> hardly accessible behind lofty and rugged mountains, and not to Amisus by the short and easy route which was used in the Græco-Roman period. This road-system, then, points distinctly to a centre in northern Cappadocia near the Halys. Here must have stood the capital of some great empire connected with its extremities, Sardis or Ephesus on the west, Sinope on the north, the Cilician Gates on the south, by roads so well made as to continue in use for a long time after the centre of power had changed to Assyria, and the old road-system had become circuitous and unsuitable.<sup>2</sup> The precise spot on which the city stood is marked by the great ruins of Boghas Keui, probably the ancient Pteria, of which the wide circuit, powerful walls, and wonderful rock-sculptures make the site indisputably the most remarkable in Asia Minor.

The ancient road from Pteria to Sardis crossed the upper Sangarius valley, and its course may be traced by the monuments of this early period.<sup>3</sup> Close to its track, on a lofty plateau which overhangs the Phrygian monument inscribed with the name of "Midas the King," is a great city, inferior indeed to Pteria in extent, but surrounded by rock-sculptures quite as remarkable as those of the Cappadocian city. The plateau is between 2 and 3 miles in circumference, and presents on all sides a perpendicular face of rock 50 to 200 feet in height. In part, at least, this natural defence was crowned by a wall built of large squared stones.<sup>4</sup> This city was evidently the centre of the old Phrygian kingdom of the Sangarius valley, but at least one of the monuments in it seems to belong to the older period of Cappadocian supremacy, and to prove that the city already existed in that earlier time.<sup>5</sup> The Phrygian kingdom and art therefore took the place of an older civilization. It is as yet impossible to determine the relation in which the Phrygians stood to the ruling race of that older period, whether they came in from the north-west, or whether they were a primitive people taught, and for a time ruled, by foreigners from Cappadocia, but at last expelling their teachers. It is probable that the tradition of battles between the Phrygians and the Amazons on the banks of the Sangarius preserves the memory of a struggle between the two races.<sup>6</sup>

Of the monuments that exist around this city two classes may be confidently referred to the period of Phrygian greatness. That which is inscribed with the name of "Midas the King" is the most remarkable example of one class, in which a large perpendicular surface of rock

is covered with a geometrical pattern of squares, crosses, and meanders, surmounted by a pediment supported in the centre by a pilaster in low relief. In some cases a floral pattern occupies part of the surface, and in one case the two sides of the pediment are filled by two sphinxes of extremely archaic type.<sup>7</sup> In some of these monuments a doorway is carved in the lower part; the door is usually closed, but in one case, viz., the sphinx monument just alluded to, the valves of the door are thrown wide open and give access to a little chamber, on the back of which is sculptured in relief a rude image of the Mother-goddess Cybele, having on each side of her a lion which rests its forepaws on her shoulder and places its head against hers. Sometimes a grave has been found hidden behind the carved front; in other cases no grave can be detected, but it is probable that they are all sepulchral.<sup>8</sup> The imitation of wood-work is obvious on several monuments of this kind. The second class is marked by the heraldic type of two animals, usually lions rampant, facing one another, but divided by a pillar or some other device. This type is occasionally found conjoined with the preceding; and various details common to both classes show that there was no great difference in time between them. The heraldic type is used on the monuments which appear to be the older, and the geometrical pattern is often employed on the inscribed monuments, which are obviously later than the uninscribed. Monuments of this class are carved on the front of a sepulchral chamber, the entrance to which is a small doorway placed high and inaccessible in the rocks.

Early Phrygian art stands in close relationship with the art of Cappadocia, but has such individuality, such freedom from conventionality, such power of varying and combining types learned from other peoples, as to show that the Phrygians possessed high artistic faculty very similar in character to the Greek. The monuments of the type of the Midas tomb are obviously imitated from patterns employed in cloth and carpets. Such patterns were used in Cappadocia; and the priest in the rock-sculpture at Ibriz wears an embroidered robe strikingly similar in style to the pattern on the Midas tomb; but the idea of using the pattern as the Phrygians did seems peculiar to themselves. The heraldic type of the second class is found also in the art of Assyria, and was undoubtedly adopted by the Phrygians from earlier art; but it is used so frequently in Phrygia as to be specially characteristic of that country.<sup>9</sup> While Phrygian art is distinctly non-Oriental in spirit, its resemblance to archaic Greek art is a fact of the greatest importance. It is not merely that certain types are employed both in Phrygia and in Greece, but most of the favourite types in early Greek art can be traced in Phrygia, employed in similar spirit and for similar purposes. The heraldic type of the two lions is the device over the principal gateway of Mycenæ, and stamps this, the oldest great monument on Greek soil, with a distinctly Phrygian character. Mycenæ was the city of the Pelopides, whom Greek tradition unhesitatingly declares to be Phrygian immigrants. A study of the topography of the Argive plain leads to the conclusion that Mycenæ, Midea, and Tiryns form a group of cities founded by an immigrant people in opposition to Argos, the natural capital of the plain and the stronghold of the native race. Midea

<sup>1</sup> Sinope was made a Greek colony in 751 B.C., but it is said to have existed long before that time.

<sup>2</sup> When the Persians conquered Lydia they retained, at least for a time, this route, which they found in existence, and the royal messengers went first across the Halys to Pteria, and then by the road across Cappadocia to the Cilician Gates.

<sup>3</sup> See a paper on "The Early Historical Relations between Phrygia and Cappadocia," in *Journ. Roy. As. Soc.*, 1883.

<sup>4</sup> The small fortress Pishmish Kalest is a miniature of the great city beside it; see Perrot, *Explor. Archéol.*, p. 169 and pl. viii.

<sup>5</sup> A large tumulus exists in this district between Bel Keui and Ak Euren, from which one large stone, with an inscription in the usual Cappadocian hieroglyphics, has already been dug.

<sup>6</sup> Abel (L.) identifies these two races, and makes the city at Boghas Keui a Phrygian city.

<sup>7</sup> Published in *Journ. Hell. Stud.*, 1884.

<sup>8</sup> The monuments of Phrygia fall into two groups, which probably mark the sites of two cities about 16 miles distant from each other. One group lies round the villages of Kumbet, Yapaldak, and Bakbahis; the other beside Ilyen, Bel Keui, Demirli, and Ayastin.

<sup>9</sup> The heraldic type continues on gravestones down to the latest period of paganism. Carpets with geometrical patterns of the Midas-tomb style are occasionally found at the present time in the houses of the peasantry of the district.

appears to be the city of Midas,<sup>1</sup> and the name is one more link in the chain that binds Mycenaë to Phrygia. This connexion, whatever may have been its character, belongs to the remote period when the Phrygians inhabited the Ægean coasts. In the 8th and probably in the 9th century B.C. communication with Phrygia seems to have been maintained especially by the Greeks of Cyme, Phocæa, and Smyrna. About the end of the 8th century Midas king of Phrygia married Damodice, daughter of Agamemnon, the last king of Cyme. Gyges, the first Mermnad king of Lydia (687-653), had a Phrygian mother. The worship of Cybele spread over Phocæa to the west as far as Massilia: rock monuments in the Phrygian style and votive reliefs of an Anatolian type are found near Phocæa. Smyrna was devoted to the Phrygian Meter Sipyrene. It is then natural that the lays of the Homerids refer to Phrygia in the terms above described, and make Priam's wife a Phrygian woman. After the foundation of the Greek colony at Sinope in 751 there can be no doubt that it formed the link of connexion between Greece and Phrygia. Phrygian and Cappadocian traders brought their goods, no doubt on camels, to Sinope, and the Greek sailors, the *deivavras* of Miletus, carried home the works of Oriental and Phrygian artisans. The Greek alphabet was carried back to Phrygia and Pteria, either from Sinope or more probably from Cyme, in the latter part of the 8th century. The immense importance of Sinope in early times is abundantly attested, and we need not doubt that very intimate relations existed at this port between the Ionic colonists and the natives. The effects of this commerce on the development of Greece were very great. It affected Ionia in the first place, and the mainland of Greece indirectly; the art of Ionia at this period is almost unknown, but it was probably most closely allied to that of Phrygia.<sup>2</sup> A striking fact in this connexion is the frequent use of a very simple kind of Ionic capital on the early Phrygian monuments, making it practically certain that the "proto-Ionic" column came to Greece over Phrygia. It is obvious that the revolution which took place in the relations between Phrygians and Greeks must be due to some great movement of races which disturbed the old paths of communication. Abel is probably correct in placing the inroads of the barbarous European tribes, Bithynians, Thyni, Mariandyni, &c., into Asia Minor about the beginning of the 9th century B.C. The Phrygian element on the coast was weakened and in many places annihilated; that in the interior was strengthened; and we may suppose that the kingdom of the Sangarius valley now sprang into greatness. The kingdom of Lydia appears to have become important about the end of the 8th century, and to have completely barred the path between Phrygia and Cyme or Smyrna. Ionian maritime enterprise opened a new way over Sinope.<sup>3</sup>

The downfall of the Phrygian monarchy can be dated with comparative accuracy. Between 680 and 670 the Cimmerians in their destructive progress over Asia Minor overran Phrygia; the king Midas in despair put an end to his own life; and from henceforth the history of Phrygia is a story of slavery, degradation, and decay, which contrasts strangely with the earlier legends. The catastrophe seems to have deeply impressed the Greek mind, and the memory of it was preserved. The date of the Cimmerian invasion is fixed by the concurrent testimony of the contemporary

poets Archilochus and Callinus, of the late chronographers Eusebius, &c., and of the inscriptions of the Assyrian king Esar-haddon. The Cimmerians were finally expelled from Asia Minor by Alyattes before his war with the Medes under Cyaxares (590-585 B.C.). The Cimmerians, therefore, were ravaging Asia Minor, and presumably held possession of Phrygia, the only country where they achieved complete success, till some time between 610 and 590. Phrygia then fell under the Lydian power, and by the treaty of 585 the Halys was definitely fixed as the boundary between Lydia and Media. The period from 675 to 585 must therefore be considered as one of great disturbance and probably of complete paralysis in Phrygia. After 585 the country was ruled again by its own princes, under subjection to Lydian supremacy. To judge from the monuments, it appears to have recovered some of its old prosperity, but the art of this later period has to a great extent lost the strongly-marked individuality of its earlier bloom. The later sepulchral monuments belong to a class which is widely spread over Asia Minor, from Lycia to Pontus. The graves are made inside a chamber excavated in the rock, and the front of the chamber imitates a house or temple. No attempt is made to conceal the entrance or render it inaccessible. The architectural details are in some cases unmistakably copied without intentional modification from the architecture of Greek temples, others point perhaps to Persian influence, while several—which are perhaps among the early works of this period—show the old freedom and power of employing in new and original ways details partly learned from abroad. This style continued in use under the Persians, under whose rule the Phrygians passed when Cyrus defeated Croesus in 546, and probably lasted till the 3d century B.C. One monument appears to presuppose a development of Greek plastic art later than the time of Alexander.<sup>4</sup> It would, however, be quite wrong to suppose that the influence of truly Hellenic art on Phrygia began with the conquest of Alexander. Under the later Mermnad kings the Lydian empire was penetrated with Greek influence, and Xanthus, the early Lydian historian, wrote his history in Greek. Under the Persian rule perhaps it was more difficult for Greek manners to spread far east; but we need not think that European influence was absolutely unfelt even in Phrygia. The probability is that Alexander found in all the large cities a party favourable to Greek manners and trade. Very little is to be learned from the ancient writers with regard to the state of Phrygia from 585 to 300. The slave-trade flourished: Phrygian slaves were common in the Greek market, and the Phrygian names Midas and Manes were stock-names for slaves. Herodotus (i. 14) records that a king Midas of Phrygia dedicated his own chair at Delphi; the chair stood in the treasury of Cypselus, and cannot have been deposited there before 680 to 660 B.C. It is not improbable that the event belongs to the time of Alyattes or Croesus, when Greek influence was favoured throughout the Lydian empire; and it is easy to understand how the offering of a king Midas should be considered, in the time of Herodotus, as the earliest made by a foreign prince to a Greek god. The Phrygian troops in the army of Xerxes were armed like the Armenians and led by the same commander.

It is to be presumed that the cities of the Sangarius valley gradually lost importance in the Persian period. Formerly the great line of communication across Anatolia traversed the Sangarius valley, but a better and shorter path south of the Salt Desert came into use in this period, from which these cities were far distant. The final catastrophe was the invasion of the Gauls about 270 to 250; and, though the circumstances of this invasion are almost

<sup>1</sup> A city Midea occurs also in Boetia, a village Midea on the Hællespont, and a city Midsum in the Sangarius valley.

<sup>2</sup> See Furtwängler, *Goldsfund am Vatersfelde*, Winckelm. Progr., 1884. The closest analogies of old Phrygian art are to be found in the earliest Greek bronze work in Olympia, Italy, and the northern lands.

<sup>3</sup> Hipponax, fr. 36 [49], proves that a trade-route from Phrygia down the Mæander to Miletus was used in the 6th century.

<sup>4</sup> A gorgoneum, on a tomb engraved in *Jour. Hell. Stud.*, pl. xxv.

unknown, yet we may safely reckon among them the complete devastation of northern Phrygia. At last Attalus I settled the Gauls permanently in eastern Phrygia, and a large part of the country was henceforth known as Galatia. Strabo mentions that the great cities of ancient Phrygia were in his time either deserted or marked by mere villages. The great city over the tomb of Midas has remained uninhabited down to the present day. About 5 miles west of it, near the modern Kumbet, stood Merus, a bishopric in the Byzantine time, but never mentioned under the Roman empire.

Alexander the Great placed Phrygia under the command of Antigonos, who retained it when the empire was broken up. When Antigonos was defeated and slain at the decisive battle of Ipsus, Phrygia came under the sway of Seleucus. As the Pergamian kings grew powerful, and at last confined the Gauls in eastern Phrygia, the western half of the country was incorporated in the kingdom of Pergamum. Under the Roman empire Phrygia had no political existence under a separate government,<sup>1</sup> but formed part of the vast province of Asia. In autumn 85 B.C. the pacification of the province was completed by Sulla, and throughout the imperial time it was common for the Phrygians to date from this era. The imperial rule was highly favourable to the spread of Hellenistic civilization, which under the Greek kings had affected only a few of the great cities, leaving the mass of the country purely Phrygian. A good deal of local self-government was permitted: the cities struck their own bronze coins, inscribed on them the names of their own magistrates,<sup>2</sup> and probably administered their own laws in matters purely local. The western part of the country was pervaded by Græco-Roman civilization very much sooner than the central, and in the country districts the Phrygian language<sup>3</sup> continued in common use at least as late as the 3d century after Christ.

When the Roman empire was reorganized by Diocletian at the end of the 3d century Phrygia was divided into two provinces, distinguished at first as Prima and Secunda, or Great and Little, for which the names Pacatiana and Salutaris<sup>4</sup> soon came into general use. Pacatiana comprised the western half, which had long been completely pervaded by Græco-Roman manners, and Salutaris the eastern, in which the native manners and language were still not extinct. Each province was governed by a "præses" or ἡγεμῶν about 412 A.D., but shortly after this date an officer of consular rank was sent to each province (Hierocles, *Synecd.*). About 535 Justinian made some changes in the provincial administration: the governor of Pacatiana was henceforth a "comes," while Salutaris was still ruled by a "consularis." When the provinces of the Eastern empire were reorganized and divided into "themata" the two Phrygias were broken up between the Anatolic, Opsician, and Thracasian themes, and the name Phrygia finally disappeared. Almost the whole of the Byzantine Phrygias is now included in the vilayet of Broussa or Khodavendikya, with the exception of a small part of Parorius and the district about Themisonium (Karayuk Bazar) and Ceretapa (Kayadibi), which belong to the vilayet of Koniya, and the district of Laodicea and Hierapolis, which belongs

to Aidin. The principal modern cities are Kutayah (Cotyæum), Eski Sheher (Dorylæum), Afium Kara Hissar (near Prymnessus), and Ushak (near Trajanopolis).

It is impossible to say anything definite about the boundaries of Phrygia before the 5th century. Under the Persians Great Phrygia extended on the east to the Halys and the Salt Desert; Xenophon (*Anab.*, i, 2, 19) includes Iconium on the south-east within the province, whereas Strabo makes Tyriæum the boundary in this direction. The southern frontier is unknown: the language of Livy (xxxviii, 15) implies that Metropolis (in the Tchul Ova) belonged to Pisidia; but Strabo (p. 629) includes it in Phrygia. Celæne, beside the later city of Apamea (Dineir), and the entire valley of the Lycus were Phrygian. The Mæander above its junction with the Lycus formed for a little way the boundary between Phrygia and Lydia. The great plateau now called the Banas Ova was entirely or in great part Phrygian. Mount Dindymus (Murad Dag) marked the frontier of Mysia, and the entire valley of the Tembrogius or Tembris (Porsuk Su) was certainly included in Phrygia. The boundaries of the two Byzantine Phrygias were not always the same. Taking Hierocles as authority, the extent of the two provinces at the beginning of the 6th century will be readily gathered from the accompanying list, in which those towns which coined money under the Roman empire are italicized and the nearest modern village is appended.

I. PACATIANA.—1. *Laodicea* (Eski Hissar); 2. *Hierapolis* (Pambuk Kalesi); 3. *Moeyna* (Gevaze); 4. *Metropolis*, only in *Notitius Episcop.* (Guzlar); 5. *Attuda* (Assar, south-west from Serai Keui); 6. *Trapezopolis* (perhaps between Davas Ova and Karayuk Ova); 7. *Colossæ* (near Chonas); 8. *Ceretapa Diocæsarea* (Kayadibi); 9. *Themisonium* (Karayuk Bazar); 10. *Tacina* (Yarishli); 11. *Sazan* (Sari Kavak, in Daz Kiri); 12. *Dionysopolis* (Orta Keui); 13. *Anastasiopolis*, originally a village of the *Hyrgalis* (Uch Kuyular); 14. *Attanassus* (Eski Aidan); 15. *Lunda* (Eski Seid); 16. *Peltis* (Karayashlar); 17. *Eumœna* (Ishakly); 18. *Siblia* (Homa); 19. *Pepusa* (Yannik Euren); 20. *Bria* (Garbasan or Suretly); 21. *Sebaste* (Sivally); 22. *Eluzo* or *Aludda* (Hadjimlar); 23. *Acmonia* (Ahat Keui); 24. *Alta* (Kirka); 25. *Hierocharas* (Otourak); 26. *Diocles* (Dols); 27. *Aristium* (Karaj Euren, in Sitchanly Ova); 28. *Cidyæus* (Cutch Eyuk); 29. *Apia* (Abia); 30. *Cotyæum* (Kutayah); 31. *Æsani* (Tchevdür Hissar); 32. *Tiberiopolis* (Altyntash); 33. *Cadus* (Gediz); 34. *Ancyra* (Kilisæ Keui); 35. *Synaus* (Simav); 36. *Flaviopolis Temenothyræ* (Kara Tash); 37. *Trajanopolis Grimenothyræ* (Giaour Euren, near Orta Keui); 38. *Blauadus* (Suleimany);

II. SALUTARIA.—1. *Eucarpia* (near Mantesh); 2. *Hieropolis* (Kotch Hissar); 3. *Otrous* (Tchor Hissar); 4. *Sectorium* (Emir Assar); 5. *Brusus* (Kara Sandykly); 6. *Boudus* (Aghi Kara); 7. *Augustopolis*, formerly Anabura (Sarmenesh); 8. *Sibidunda* (perhaps Yeni Keui); 9. *Lycias* (perhaps Bazar Agatch); 10. *Synnada* (Tchifut Cassaba); 11. *Prymnessus* (Seulun); 12. *Ipsus*, formerly *Julia* (near Sakly); 13. *Polybotus* (Bolawadun); 14. *Docimium* (Istcha Kara Hissar); 15. *Metropolis*, including Consi (B. Tchorgia and Ambasas (Ambanas); 16. *Merus* (Kumbet); 17. *Nacoles* (Seidi Ghaz); 18. *Dorylæum* (Eski Sheher); 19. *Midasium* (Kara Eyuk); 20. *Lycœones* (Kalejik); 21. *Auloers* (in Dombel Ova); 22 and 23. *Amadassus* and *Prepnisus* (unknown). In later times the important fortress (and bishopric) of Acroœnus was founded on the site of the present Afium Kara Hissar.

Besides these, certain cities beyond the bounds of the Byzantine Phrygias belonged under the Roman empire to the provinces of Asia and are usually considered Phrygian—(1) in Byzantine Pisidia, *Philomelium* (Ak Sheher), *Hadrianopolis* (Arkut Khan); (2) in Byzantine Galatia, *Amorium* (Assar near Hamza Hadji), *Orcistus* (Alikel or Alekian), *Tricomis* or *Trocmada* or *Trocnada* (Kainzas); (3) in Byzantine Lycia, *Cibyrs* (Horzum).

Phrygia contains several well-marked geographical districts. (1) **PARORIUS**, the narrow, flat, elevated valley stretching north-west to south-east between the Sultan Dag and the Emir Dag from Holmi (about Tchali) to Tyriæum (Ighin); its waters collect within the valley, in three lakes, which probably supply the great fountains in the Axyllum, and through them the Sangarius. (2) **AXYLLUM**, the vast treeless plains on the upper Sangarius; there burst forth at various points great perennial springs, the Sakaria fountains

<sup>1</sup> Oocelis, which is known only from coins, probably belongs to this province. Hierocles adds Theodosia, probably a name of *Deidus* (Demirji), which is usually included in Lydia. Mionnet gives coins of Moeyna, but they are falsely read and belong to the Moestani.

<sup>2</sup> Nos. 1-5 were called the Phrygian "Pentapolis."

<sup>1</sup> An imperial officer named *Procurator Phrygiæ* is mentioned in a few inscriptions of the 2d century; but he belongs to a financial, not an administrative division.

<sup>2</sup> This liberty was not granted to the cities of any other province in Asia.

<sup>3</sup> A number of inscriptions in a language presumably Phrygian have been discovered in the centre and east of the country; they belong generally to the end of the 2d and to the 3d century.

<sup>4</sup> The name Salutaris is first found in Ptolemy Silvius about 385; in the *Notit. Dignit.*, about 412 A.D., the names Pacatiana and Salutaris are used.



(Strabo, p. 548), Ilje Bashi, Bunar Bashi, Geuk Bunar, Urak Bashi, which feed the Sangarius. Great part of the Axylium was assigned to Galatia. (3) The rest of Phrygia is mountainous (except the great plateau, Banas Ova), consisting of hill-country intersected by rivers, each of which flows through a fertile valley of varying breadth. The northern half is drained by rivers which run to the Black Sea; of these the eastern ones, Porsuk Su (Tembris or Tembrogius), Seidi Su (Parthenius), Bardakchi Tchai (Xerabates), and Bayat Tchai (Alandrus), join the Sangarius, while the western,<sup>1</sup> Tausanly Tchai (Rhyndacus) and Simav Tchai (Macostus), meet and flow into the Propontia. The Hermus drains a small district included in the Byzantine Phrygia, but in earlier times assigned to Lydia and Mysia. Great part of southern and western Phrygia is drained by the Meander with its tributaries, Sandykly Tchai (Glaucus), Banar Tchai, Kopli Su (Hippurinus), and Tchuruk Su (Lycus); moreover, some upland plains on the south, especially the Dombai Ova (Anlocra), communicate by underground channels with the Meander. Finally, the Karayuk Ova in the extreme south-west drains through the Kazanes, a tributary of the Indus, to the Lycian Sea. Phrygia Parorius and all the river-valleys are exceedingly fertile, and agriculture was the chief occupation of the ancient inhabitants; according to the myth, Gordius was called from the plough to the throne. The high-lying plains and the vast Axylium furnish excellent pasturage, which formerly nourished countless flocks of sheep. The Romans also obtained fine horses from Phrygia. Grapes, which still grow abundantly in various parts, were much cultivated in ancient times. Other fruits are rare, except in a few small districts. Figs cannot be grown in the country, and the ancient references to Phrygian figs are either erroneous or due to a loose use of the term Phrygia.<sup>2</sup> Trees are exceedingly scarce in the country; the pine-woods on the western tributaries of the Sangarius and the valonia oaks in parts of the Banas Ova, and a few other districts, form exceptions. The underground wealth is not known to be great. Iron was worked in the district of Cibyra, and the marble of Synnada, or more correctly of Docimium, was largely used by the Romans. The scenery is generally monotonous; even the mountainous districts rarely show striking features or boldness of character; where the landscape has beauty, it is of a subdued melancholy character. The water-supply is rarely abundant, and agriculture is more or less dependent on an uncertain rainfall. The circumstances of the country are well calculated to impress the inhabitants with a sense of the overwhelming power of nature and of their complete dependence on it. Their mythology, so far as we know it, has a melancholy and mystic tone, and their religion partakes of the same character. The two chief deities were Cybele, the Mother, the reproductive and nourishing power of Earth, and Sabazius, the Son, the life of nature, dying and reviving every year. The annual vicissitudes of the life of Sabazius, the Greek Dionysus, were accompanied by the mimic rites of his worshippers, who mourned with his sufferings and rejoiced with his joy. They enacted the story of his birth and life and death; the Earth, the Mother, is fertilized only by an act of violence by her own child; the representative of the god was probably slain each year by a cruel death, just as the god himself died.<sup>3</sup> The rites were characterized by a frenzy of devotion, unrestrained enthusiasm, wild orgiastic dances, and wanderings in the forests, and were accompanied by the music of the flute, cymbal, and tambourine.<sup>4</sup> At an early time this worship was affected by Oriental influence, coming over Syria from Babylonia. Sabazius was identified with Adonis or Atya, Cybele with the Syrian goddess; and many of the coarsest rites of the Phrygian worship, the mutilation of the priests, the prostitution at the shrine,<sup>5</sup> came from the hot countries of the south-east. But one curious point of Semitic religion never penetrated west of the Haly: the pig was always unclean and abhorred among the Semites, whereas it was the animal regularly used in purification by the Phrygians, Lydians, Lycians, and Greeks.<sup>6</sup> The Phrygian religion exercised a very strong influence on Greece. In the archaic period the Dionysiac rites and orgies spread from Thrace into Greece, in

spite of opposition which has left many traces in tradition, and the worship of Demeter at Eleusis was modified by Cretan influence ultimately traceable to Asia Minor. Pindar erected a shrine of the Mother of the gods beside his house, and the Athenians were directed by the Delphic oracle to atone for the execution of a priest of Cybele during the Peloponnesian War by building the Metroon. In these and other cases the Phrygian character was more or less Hellenized; but wave after wave of religious influence from Asia Minor introduced into Greece the unmodified "barbarian" ritual of Phrygia. The rites spread first among the common people and those engaged in foreign trade. The comic poets satirized them, and Plato and Demosthenes inveighed against them; but they continued to spread, with all their ferocious enthusiasm, their superstition, and their obscene practices, wide among the people, whose religious cravings were not satisfied with the purely external religions of Hellenism. The orgies or mysteries were open to all, freemen or slaves, who had duly performed the preliminary purifications, and secured to the participants salvation and remission of sins. Under MYSTERIES (q. v.) a distinction of character has been pointed out between the true Hellenic mysteries, such as the Eleusinian, and the Phrygian; but there certainly existed much similarity between the two rituals. In the first centuries after Christ only the Phrygian and the Egyptian rites retained much real hold on the Græco-Roman world. Phrygia itself, however, was very early converted to Christianity. Christian inscriptions in the country begin in the 3d and are abundant in the 4th century. There is every appearance that the great mass of the people were Christians before 300, and Eusebius (*H. E.*, v. 16) is probably correct in his statement that in the time of Diocletian there was a Phrygian city in which every living soul was Christian. The great Phrygian saint of the 2d century was named Abercius; the mass of legends and miracles in the late biography of him long brought his very existence into dispute, but a recently-discovered fragment of his gravestone has proved that he was a real person, and makes it probable that the wide-reaching conversion of the people attributed to him did actually take place. The strange enthusiastic character of the old Phrygian religion was not wholly lost when the country became Christian, but is clearly traced in the various heresies that arose in central Anatolia. Especially the wild ecstatic character and the prophecies of the Montanists recall the old type of religion. Montanus (see MONTANISM, vol. xvi. p. 775) was born on the borders of Phrygia and Mysia (doubtless in the Murad Dagh), and was vehemently opposed by Abercius.

Of the old Phrygian language very little is known; a few words are preserved in Hesychius and other writers. Plato mentions that the Phrygian words for "dog," "fire," &c., were the same as the Greek; and to these we may add from inscriptions the words for "mother" and "king." A few inscriptions of the ancient period are known, and a somewhat larger number of the Roman period have been found, but not yet published.

Owing to the scantiness of published material about Phrygia frequent reference has been made in this article to unpublished monuments, and historical views are stated which have only quite recently been published by the writer. Besides the works already quoted of Abel and Ferrat, see Ritter's "Kleinasien," in his *Ergebnisse von Asien*; Leake's *Asia Minor*; Klepert's appendix to Franz, *Flav. Joseph. u. sein Städtchen Kleinasien*; Hase, in Eruck and Gruber's *Byzantion*; Hamilton's *Travels in Asia Minor*; Hirschfeld's "Reisebericht," in the *Ber. Monaster.* (1879); Texier, *Asia Minor*; Stuart, *Ancient Monuments*; besides the special chapters in the geographical treatises of Cramer, *Voyage St. Martin*, Forbiger, &c.; Ramsay, in *Mittheil. Instit. Athen.* (1882), *Bulletin de Correspond. Hellén.* (1882-83), and *Journal of Hellenic Studies* (1883 sq.). (W. M. EA.)

PHYRNE, a celebrated Greek courtesan, flourished in the time of Alexander the Great (4th century B.C.). She was born at Thebes in Boeotia, but seems to have lived at Athens. Originally so poor as to earn a living by gathering capers, she acquired so much wealth by her extraordinary beauty that she offered to rebuild the walls of Thebes, which had been destroyed by Alexander (335), on condition of inscribing on them, "Destroyed by Alexander, restored by Phyrne the courtesan." On the occasion of a festival of Poseidon at Eleusis she laid aside her garments, let down her hair, and stepped into the sea in the sight of the people, thus suggesting to the painter Apelles his great picture of Aphrodite rising from the Sea, for which Phyrne sat as model. The sculptor Praxiteles was one of her lovers, and she is said to have been the model of his celebrated Cnidian Aphrodite, which Pliny declared to be the most beautiful statue in the world.<sup>7</sup> There were statues of her by Praxiteles at Delphi and in

<sup>1</sup> This district was according to the Greek view part of Mysia.

<sup>2</sup> In Strabo, p. 577, *Ἰαδικύριον* must be wrong; *Ἰαδικύριον* is true to fact, and is probably the right reading. Olives cannot grow on the upland.

<sup>3</sup> These cults of Greece which are most closely related to the Phrygian were certainly accompanied originally by human sacrifices.

<sup>4</sup> The influence which was exerted on Greek music and lyric poetry by the Phrygian music was great; see MARSYAS, OLYMPUS.

<sup>5</sup> There is no direct evidence that this was practised in the worship of Cybele, but analogy and indirect arguments make it pretty certain.

<sup>6</sup> Cleon, the Phrygian, when high priest of the Cappadocian goddess at Comana, caused much scandal by using pigs in the sacred precincts (Strabo, p. 574); he only carried out the customs of his country. Pigs were used in all Greek purificatory rites, which were also practised in Lydia (Herod., i. 85). A pig is under the seat of the defiled dead on the happy tomb.

<sup>7</sup> So Athenæus, 590, 591. But, according to others (Clemens Alexandrinus, *Protrept.*, 53, and Arnobius, *Adv. Gentes*, vi. 13) Praxiteles's model for the Cnidian Aphrodite was Cratinus; and Pliny (*xxxv.* 87) says that some declared that Apelles's model was Pausanias.

her native town; the former was golden or plated with gold, the latter was of marble. It is said that at her request Praxiteles promised her the most beautiful of his works, but would not tell her which was it. Having discovered by a stratagem that of his works he prized most a statue of Love (Eros) and one of a Satyr, she asked of him the former and dedicated it in Thespia. Being accused of impiety by Euthias, she was defended by the orator Hyperides, one of her lovers. When it seemed that the verdict was about to be against her, he rent her robe and displayed her lovely bosom, which so moved her judges that they acquitted her. According to others it was Phryne herself who thus displayed her charms. She is said to have made an attempt on the virtue of the philosopher Xenocrates, and to have signally failed.

PHRYNICHUS, the name of a number of distinguished Greeks, of whom the most prominent were the following.

1. PHRYNICHUS, one of the earliest tragic poets of Athens, was the son of Polyphradmon, and a pupil or follower of Thespis, who is commonly regarded as the founder of tragedy. But such were the improvements introduced by Phrynichus that some of the ancients regarded him as its real founder. He flourished, according to Cyrillus and Eusebius, in 483 B.C., but he gained a poetical victory (probably his first), as early as 511. His famous play the *Capture of Miletus* was probably composed shortly after the conquest of that city by the Persians (494). It moved the Athenians to tears; they fined the poet 1000 drachms for reminding them of the woes of their friends, and decreed that the play should never be used again. In 476 Phrynichus won another poetical victory, probably with his play the *Phoenissæ*, which celebrated the defeat of Xerxes at Salamis (480). The drama derived its name from the chorus of Phœnician women. On this occasion Themistocles acted as choragus, and it is probable that the play was written to revive his waning popularity by reminding the Athenians of his great deeds. The *Persians* of Æschylus (exhibited in 472) was an imitation of the *Phoenissæ* of Phrynichus. Phrynichus died in Sicily, perhaps at the court of Hiero, tyrant of Syracuse, who welcomed those other great contemporary poets Æschylus and Pindar. The titles of his plays mentioned by Suidas and others show that he treated mythological as well as contemporary subjects; such are the titles *The Danaïdes*, *Actæon*, *Alceste*, *Tantalus*. But in his plays, as in the early tragedies generally, the dramatic element was subordinate to the lyric element as represented by the chorus. Indeed in his earliest dramas there can only have been one actor, for the introduction of two actors was a novelty due to his younger contemporary Æschylus, who first exhibited in 499. Phrynichus was especially famous for the sweetness of his songs, which were sung by old people down to the time of Aristophanes. Connected with the predominance of the chorus in early tragedies was the prominence in them of the dance. There is an epigram ascribed to Phrynichus in which he boasts that the figures of his dances were as various as the waves of the sea. According to Suidas it was Phrynichus who first introduced female characters on the stage (played by men in masks). The few remains of his works are collected by Wagner and Nauck in their editions of the fragments of the Greek tragedians.

2. PHRYNICHUS, a poet of the Old Attic Comedy and a contemporary of Aristophanes, is said by Suidas to have been an Athenian, but according to the scholiast on Aristophanes (*Frogs*, 13) he was satirized as a foreigner. His first comedy was exhibited in 429 B.C. (according to Suidas, as corrected by Clinton and Meineke). He composed ten plays, of which the *Solitary* ("Monotropos") was exhibited in 414 along with the *Birds* of Aristophanes and gained

the third prize, and the *Muses* carried off the second prize in 405, Aristophanes being first with the *Frogs*. This poet (*Frogs*, 13) accuses Phrynichus of employing vulgar tricks to raise a laugh, and he was further charged with plagiarism and defective versification, but such accusations were too commonly bandied between rival poets to merit much attention. He was not included by the Alexandrian critics in their canon of the best poets. The remains of his works, which have been edited with the other fragments of the Attic Comedy by Meineke and Bothe, are too scanty to allow us to judge of their merits.

3. PHRYNICHUS ARABIUS, a grammarian of Bithynia, lived in the reigns of the emperors Marcus Antoninus and Commodus (2d century A.D.). According to Suidas he was the author of the following works: (1) an *Atticist*, or *On Attic Words*, in two books; (2) *Τιθέμενον συναγωγή*; (3) *Σοφιστικὴ παρασκευή*, or *Sophistical Preparation*, in forty-seven or (according to others) seventy-four books. We have an account of the last-mentioned work by Photius, who had read thirty-six books of it. The copy used by Photius contained only thirty-seven books, but he states that the author in a preface addressed to the emperor Commodus, to whom the work was dedicated, promised, if life lasted, to write as many more books. Separate parts of the work were dedicated to various friends, and Phrynichus excused its delays and imperfections on the ground of numerous illnesses. It consisted of a collection of Attic words and phrases, arranged in alphabetical order, and distinguished according to the purposes they were meant to serve, whether oratorical, historical, conversational, jocular, or amatory. The models of Attic style, according to Phrynichus, were Plato, Demosthenes and the other nine Attic orators (viz., Antiphon, Andocides, Lysias, Isocrates, Isæus, Æschines, Dinarchus, Lycurgus, Hyperides), Thucydides, Xenophon, Æschines the Socratic, Critias, Antisthenes, Aristophanes and the other poets of the Old Comedy, together with Æschylus, Sophocles, and Euripides. Of these, again, he assigned the highest place to Plato, Demosthenes, and Æschines the Socratic. The work was learned, but prolix and garrulous. A fragment of it, contained in a Paris MS., was published by Montfaucon, and again by Im. Bekker in the first volume of his *Anecdota Græca* (Berlin, 1814). We possess another work of Phrynichus which is not mentioned by Photius, but is, perhaps, identical with the *Atticist* mentioned by Suidas. This is the *Selection* (*Eclogé*) of *Attic Words and Phrases*. It is dedicated to Cornelianus, a man of literary tastes, and one of the emperor's secretaries, who had invited the author to undertake the work. It is a collection of current words and forms which deviated from the Old Attic standard. Side by side with these incorrect words and forms are given the true Attic equivalents. The work is thus a "lexicon antibarbarum," and is interesting as illustrating the changes through which the Greek language had passed between the 4th century B.C. and the 2d century A.D. Phrynichus is especially severe upon Menander, and wonders what people can see in him to admire so much. The style is concise and pointed, and is occasionally relieved by touches of dry humour. The book is divided into two parts, of which the second appears in some editions as a separate work under the title of *Epitome*. Editions of it, with valuable notes, have been published by Chr. Aug. Lobeck (Leipsic, 1820) and W. G. Rutherford (London, 1881). Lobeck devotes his attention chiefly to the later, Rutherford to the earlier usages noticed by Phrynichus.

There was also an Athenian general Phrynichus in the Peloponnesian War, who took a leading part in establishing the oligarchy of the Four Hundred at Athens in 411 B.C. He was assassinated in the same year.

**PHTHALIC ACID.** This name was given by Laurent to a di-basic acid,  $C_8H_6O_4$ , which he obtained by the oxidation of naphthalin or its tetra-chloride with nitric acid. Schunck subsequently obtained the same acid by boiling alizarin with nitric acid, but failed to recognize its identity with Laurent's.

One part of naphthalin is mixed with two parts of chlorate of potash, and the mixture added cautiously to ten parts of crude muriatic acid. The product,  $C_8H_6Cl_2$ , is washed with water and then with "ligroin" (the more volatile fraction of petroleum). The chloride thus purified is oxidized by boiling it with ten parts of (gradually added) nitric acid of 1.45 specific gravity, evaporated to dryness, and the residue distilled to obtain the anhydride  $C_8H_4O_3$ , or rationally  $C_8H_4CO_2 > O$ , long colourless needles fusing at  $128^\circ C.$ , —the boiling point being  $276^\circ$ . When boiled with water it becomes phthalic acid, rat. formula  $C_8H_6COOH$ , rhombic crystals, fusing at  $184^\circ C.$  with transformation into anhydride, very slightly soluble in water (100 parts at  $11^\circ$  dissolve 0.77 parts), more soluble in alcohol (100 of absolute dissolve 10.1 parts at  $15^\circ$ ). Phthalic acid, when heated to redness with lime, breaks up into  $CO_2$  and benzol; the lime salt when mixed with one equivalent  $CaOH$  of lime, and kept at  $330^\circ$  to  $350^\circ C.$ , yields carbonate and benzoate—

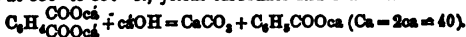

Hence phthalic acid should be obtainable by the oxidation of di-derivatives,  $C_8H_6R_2$ , of benzol ( $R = CH_3, C_2H_5, \&c.$ ), and indeed two acids,  $C_8H_6(COOH)_2$ , can be thus produced, but neither is identical with phthalic.

*Teraphthalic acid* is obtained by the oxidation of ordinary cymol,  $pC_8H_8$ , or other similar "para" bodies with bichromate of potash and sulphuric acid. It is a white powder, quite insoluble in water, sublimable without fusion or dehydration.

*Isophthalic acid* is obtained similarly from "meta" derivatives,  $mC_8H_8$ , of benzol, hair-fine needles fusing above  $300^\circ$ , almost insoluble in water, but pretty easily soluble in alcohol.

*Ortho-bi-derivatives of benzol* ought to give "ortho," i.e., Laurent's phthalic acid; but this acid itself is oxidized by the bichrome mixture into  $CO_2$  and  $H_2O$ .

*Phthalicins* are a most interesting family of coloured derivatives of phthalic anhydride, which were discovered by Daeyer, and soon found their way into the colour industry. As an example we quote *phenol-phthalicin*, obtained by the union of the anhydride with phenol,  $C_6H_5OH = H + C_6H_4.OH = H + "Phen."$  The phthalicin is

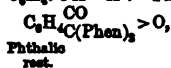

and, as will easily be understood, something widely different from the di-phenyl-phthalic ether. Phthalic anhydride and *resorcin*—one of the three di-hydroxy derivatives,  $C_6H_4(OH)_2$ , of benzol—unite into "fluorescin," distinguished by the strong fluorescence of its solutions. Tetra-brom-fluorescin, a beautiful red colour, is used industrially as *eosin* (from Greek *eos*, the morning-red).

**PHTHISIS** (*φθίσις*) or CONSUMPTION. This term, although applicable to several forms of wasting disease, is commonly used to designate a malady having for its chief manifestations progressive emaciation of the body and loss of strength, occurring in connexion with morbid changes in the lungs and in other organs.

Few diseases possess such sad interest for humanity as consumption, both on account of its widespread prevalence and its destructive effects, particularly among the young; and in every age of medicine the subject has formed a fertile field for inquiry as to its nature, its cause, and its treatment. On all these points medical opinion has undergone numerous changes with the advance of science and the application of more accurate methods of investigation; yet, notwithstanding the many important facts which within recent years have been brought to light, it must be admitted that our knowledge of this disease is still far from complete. As regards the nature or pathology of consumption it is unnecessary in a notice like the present to refer at length to the doctrines which have from time to time been held upon the subject, further than merely to indicate in a general way the views which have been more or less widely accepted in recent times. In the early part of the present century the study of the diseases of the

chest received a great impetus from the labours of Laennec, whose discovery of the stethoscope led to greater minuteness and accuracy in investigation (see *AUSCULTATION*). This physician held that phthisis depended on the development of tubercles in the lungs, which, undergoing various retrograde changes, led to the breaking down and excavation of these organs,—in short, produced the whole phenomena of consumption; and, further, that this tuberculous formation affected various other parts and organs, and was the result of a morbid constitutional condition or diathesis. This doctrine, which was generally taught during the first half of the century, and even longer, was to some extent superseded by that to which the greatest prominence was given by Niemeyer and others, namely, that the majority of cases of phthisis had their origin in an inflammation of the lung (catarrhal pneumonia), but that tubercle—the existence of which was freely admitted—might occasionally be evolved out of this condition. This view has had wide acceptance, but has been modified in a variety of ways, especially by its extension to inflammation in other parts besides the lungs, the unabsorbed products of which are held to be capable of producing tubercle by infection from within the system. Still more recently there has arisen another doctrine in connexion with the discovery by Koch of the micro-organism or bacillus of tubercle, which can be cultivated and which, when inoculated, appears capable of producing tubercular disease, namely, the doctrine of the infectiveness of phthisis by means of this "microbe" received into the system from without. This view, which is supported by many striking facts and arguments, has been extensively adopted as furnishing in all probability a rational basis of the pathology of tubercular consumption. Yet it has not been universally accepted, being held by many to be insufficient to account for the origin and course of the disease in numerous instances and in certain of its forms. It is impossible to deny an important place in the course of the disease to inflammatory processes. Even in those cases where the lungs are infiltrated with tubercular deposit evidence of inflammation is abundantly present, while, on the other hand, it would seem that in not a few instances the process is inflammatory throughout. That phthisis, therefore, is not the same process in all cases, but that there are distinct varieties of the disease, is made clear by the morbid anatomy of the lungs no less than by other considerations.

Whatever be the form, the common result of the presence of these disease-products is to produce consolidations in the affected portions of the lungs, which, undergoing retrograde changes (caseation), break down and form cavities, the result being the destruction in greater or less amount of lung-substance. These changes most commonly take place at the apex of one lung, but with the advance of the disease they tend to spread throughout its whole extent and to involve the other lung as well. When the disease is confined to a limited area of a lung it may undergo arrest—even although it has advanced so far as to destroy a portion of the pulmonary tissue, and a healing process may set in and the affected part cicatrize. This is, however, exceptional, the far more common course being the progress of the destructive change either by the spread of the inflammatory process or by infection through the lymphatics, &c., from the existing foci of diseased lung-tissue. Various morbid changes affecting the lungs themselves or other organs frequently arise in the course of phthisis, complicating its progress and reducing the chance of recovery. Of these the more common are affections of the pleura, stomach, liver, kidneys, and especially the intestines, which in the later stage of the disease become ulcerated, giving rise to the diarrhoea which is so frequent and fatal a symptom at this period.

The causes influential in producing phthisis are numerous and varied, but they may for general consideration be embraced under two groups, namely, those which are *predisposing* and operate through the constitution as a whole, and those which are *exciting* and act immediately upon the organs implicated. These two sets of causes may be more or less distinctly associated in an individual case; but, on the other hand, one may appear to act in both ways—as predisposing and exciting. The following may serve to illustrate some of the conditions of a predisposing kind. A constitutional tendency to scrofula and its manifestations lends itself readily to the production of phthisis. This morbid constitution is characterized among other things by a liability to low chronic forms of inflammation affecting gland-textures, mucous membranes, &c., the products of which show little readiness to undergo absorption, but rather to degenerate. Inflammations of this character affecting the lungs, as is not uncommon, have a special tendency to lead to the breaking down of lung-texture and formation of phthisical cavities. Many high authorities hold that tubercle-formation may be evolved out of scrofulous inflammations of glands, such as those of the neck, by an infective process, like that already referred to. The mention of this constitutional state naturally suggests another powerful predisposing cause, namely, hereditary transmission. The extent to which this influence operates as a cause of consumption has been differently estimated by writers, owing probably to the various aspects in which the matter is capable of being viewed. It is impossible to deny that the children of parents one or both of whom are consumptive are liable to manifest the disease,—that is, they inherit a constitution favouring its development under suitable exciting causes. But a similar constitutional proclivity may be induced by other influences acting through the parents. Should either or both of them be enfeebled by previous disease or by any other weakening cause, they may beget children possessing a strong predisposition to consumption. Marriages of near relatives are held by some to induce a consumptive tendency,—probably, however, owing to the fact that any constitutional taint is likely to be intensified in this way. Phthisis is a disease of early life, the period between fifteen and thirty-five being that in which the great majority of the cases occur, and of these by far the larger proportion will be found to take place between the ages of twenty and thirty. The influence of sex is not marked. Occupations, habits, and conditions of life have a very important bearing on the development of the disease apart altogether from inherited tendency. Thus occupations which necessitate the inhalation of irritating particles, as in the case of stone-masons, needle-grinders, workers in minerals, in cotton, flour, straw, &c., are specially hurtful, chiefly from the mechanical effects upon the delicate pulmonary tissue of the matter inhaled. No less prejudicial are occupations carried on in a heated and close atmosphere, as is often the case with compositors, gold-beaters, sempstresses, &c. Again, habitual exposure to wet and cold or to sudden changes of temperature will act in a similar way in inducing pulmonary irritation which may lead to phthisis. Irregular and intemperate habits are known predisposing causes; and over-work, over-anxiety, want of exercise, insufficient or unwholesome food, bad hygienic surroundings such as overcrowding and defective ventilation, are all powerful agents in sowing the seeds of the disease. Consumption sometimes arises after fevers and other infectious maladies, or in connexion with any long-continued drain upon the system, as in over-lactation. The subject of climate and locality in connexion with the causation of phthisis has received considerable attention, and some interesting facts have been ascertained on this

point. That phthisis is to be met with in all climes, and it would seem fully as frequently in tropical as in temperate regions, is evidence that climate alone exercises but little influence. It is very different, however, with locality, elevation appearing to affect to a considerable extent the liability to this disease. It may be stated as generally true that phthisis is less prevalent the higher we ascend. The investigations of Dr H. J. Bowditch in New England and of Dr George Buchanan of the Local Government Board in the counties of Surrey, Kent, and Sussex agree in proving that elevated regions with dryness of soil are hostile to the prevalence of consumption, while low-lying and damp districts seem greatly to favour its development; and it has been found that the successful drainage of damp localities has occasionally had a marked effect in reducing their phthisis mortality. In all such observations, however, various modifying circumstances connected with social, personal, and other conditions come into operation to affect the general result. As regards immediate or exciting causes, probably the most potent are inflammatory affections of the respiratory passages produced as the result of exposure. The products of such attacks are liable under predisposing conditions, such as some of those already mentioned, to remain unabsorbed and undergo degenerative changes, issuing in the breaking down and excavation of the pulmonary texture. A necessary consequence of the modern doctrine of the contagious nature and inoculability of tubercle has been to bring to the front a view as to phthisis once widely prevalent and in some countries—*e.g.*, Italy—never wholly abandoned, namely, its infectiousness. By some supporters of the recent theories of tubercle it is maintained that phthisis is communicated by infection and in no other way, the infecting agent being the bacillus. Others, while holding the view of the specific nature of the disease, deny that it can be communicated by infection like a fever, and cite the experience of consumption hospitals (such as that described by Dr C. T. Williams with respect to the Brompton Hospital) as to the absence of any evidence of its spreading among the nurses and officials. Others, again, deny both its specific nature and its direct infectious character. There appears, however, to be a growing opinion that phthisis may occasionally be acquired by a previously healthy person from close association with one already suffering from it, and, if this view be well founded, it affords a strong presumption that some infecting agent (such as the tubercle bacillus) is the medium of communication. The whole subject of the infectiousness of this disease is as yet unsettled; but there appears to be sufficient reason for special care on the part of those who of necessity are brought into close contact with patients suffering from it.

Cases of phthisis differ widely as regards their severity and their rate of progress. Sometimes the disease exhibits itself as an acute or galloping consumption, where from the first there is high fever, rapid emaciation, with cough and other chest symptoms, or with the comparative absence of these, and a speedily fatal termination. In such instances there would probably be found extensive tubercularization of the lungs and other organs. In other instances, and these constitute the majority, the progress of the disease is chronic, lasting for months or years, and along with periods of temporary improvement there is a gradual progress to a fatal issue. In other cases, again, the disease is arrested and more or less complete restoration to health takes place.

It is unnecessary to describe the symptoms or course and progress of all the varieties of this malady. It will be sufficient to refer to those of the ordinary form of the disease as generally observed. The onset may be somewhat

sudden, as where it is ushered in by hæmoptysis (spitting of blood), but more commonly it is slow and insidious and may escape notice for a considerable time. The patient is observed to be falling away in flesh and strength. His appetite fails, and dyspeptic symptoms trouble him. But the most marked feature of the condition is the presence of a cough, which is either persistent or recurs at certain times, as in lying down in bed or rising in the morning. The cough is dry or is accompanied with slight clear expectoration, and the breathing is somewhat short. Feverish symptoms are present from an early period, the temperature of the body being elevated, especially in the evening. The patient often complains of flying pains in the chest, shoulders, and back. Such symptoms occurring, especially in one who may possess by inheritance or otherwise an evident tendency to chest disease, should excite suspicion, and should be brought under the notice of the physician. They constitute what is commonly known as the first stage of phthisis and indicate the deposit of tubercle or else inflammatory consolidation in the lung.<sup>1</sup> Not infrequently the disease is arrested in this stage by judicious treatment, but should it go on the symptoms characterizing the second stage (that of softening and disintegration of lung) soon show themselves. The cough increases and is accompanied with expectoration of purulent matter in which lung-tissue and the bacillus of tubercle can be detected on microscopic examination.<sup>2</sup> The symptoms present in the first stage become intensified: the fever continues and assumes a hectic character, being accompanied with copious night-sweats, while the appetite and digestion become more and more impaired and the loss of strength and emaciation more marked. Even in this stage the disease may undergo abatement, and improvement or recovery take place, though this is rare; and by careful treatment the advance of the symptoms may be in a measure held in check. The final stage (or stage of excavation), in which the lung has become wasted to such an extent that cavities are produced in its substance, is characterized by an aggravation of all the symptoms of the previous stage. In addition, however, there appear others indicating the general break-up of the system. Diarrhœa, exhausting night-perspirations, and total failure of appetite combine with the cough and other pulmonary symptoms to wear out the patient's remaining strength and to reduce his body to a skeleton. Swelling of the feet and ankles and soreness of the mouth (aphthæ) proclaim the approach of the end.<sup>3</sup> Death usually takes place from exhaustion, but sometimes the termination is sudden from hæmorrhage, or from rupture of the pleura during a cough and the consequent occurrence of pneumothorax. A remarkable and often painful feature of the disease is the absence in many patients of all sense of the nature and

gravity of the malady from which they suffer, and their singular buoyancy of spirits (the *spes phthisica*), rendering them hopeful of recovery up till even the very end.

This description is but a brief and imperfect outline of the course and progress of an ordinary case of phthisis. It is scarcely necessary to remark that the disease is greatly modified in its course and progress and in the presence or absence of particular symptoms in individuals. Thus in some the chest-symptoms (cough, &c.) are prominent throughout, while in others these are comparatively in abeyance, and diarrhœa or fever and exhausting perspirations or throat-troubles specially conspicuous. Nevertheless, essentially the same pathological conditions are present in each case. Further, as has been already mentioned, there are types of the disease which obviously influence alike its main features and its duration; these have been embraced under two classes, the acute and the chronic. In the former, which includes the acute tuberculous and acute inflammatory or pneumonic phthisis, the progress of the disease is marked by its rapidity and the presence of fever even more than by local chest-symptoms. Such cases run to a fatal termination in from one to three or four months, and are to be regarded as the most severe and least hopeful form. The chronic cases, of which the description above given is an example (and which embrace various chronic changes, e.g., chronic interstitial pneumonia or cirrhosis of the lung), progress with variable rapidity. Their duration has been estimated by different authorities at from two to eight or more years. Much, however, necessarily depends on the effect the disease exercises upon the patient's strength and nutrition, on his circumstances and surroundings, and on the presence or absence of weakening complications. Many cases of this class remain for long unchanged for the worse, perhaps undergoing temporary improvement, while in a few rare instances, where the disease has become well marked or has even attained to an advanced stage, what is virtually a cure takes place.

The treatment of phthisis has received much attention from physicians as well as from empirics, by the latter of whom chiefly many so-called cures for consumption have from time to time been given forth. It need scarcely be stated that no "cure" for this disease exists; but, while this is true, it is no less true that by the adoption of certain principles of treatment under enlightened medical guidance a very great deal may now be done to ward off the disease in those who show a liability to it, and to mitigate and retard, or even arrest, its progress in those who have already become affected by it. The preventive measures include careful attention to hygienic conditions, both personal and surrounding. In the case of children who may inherit a consumptive tendency or show any liability to the disease much care should be taken in bringing them up to promote their general health and strengthen their frames. Plain wholesome food with fatty ingredients, if these can possibly be taken, milk, cream, &c., are to be recommended. Exercise in the open air and moderate exercise of the chest by gymnastics and by reading aloud or singing are all advantageous. An ample supply of fresh air in sleeping apartments, schools, &c., is of great importance, while warm clothing and the use of flannel are essential, especially in a climate subject to vicissitudes. The value of the bath and of attention to the function of the skin is very great. The like general hygienic principles are equally applicable in the case of adults. When the disease has begun to show any evidence of its presence its treatment becomes a matter of first importance, as it is in the early stages that most can be done to arrest or remove it. Special symptoms, such as cough, gastric disturbances, pain, &c., must be dealt with by the physician according to the indi-

<sup>1</sup> The examination of the chest by the usual methods of physical diagnosis reveals in this stage the following as among the chief points. On inspection the thorax is observed to be narrow and poorly developed, or it may be quite natural. At its upper region there may be noticed slight flattening under the clavicle of one side, along with imperfect expansion of that part on full inspiration. On percussion the note may be little if at all impaired, but frequently there is dullness more or less marked at the apex of the lung. On auscultation the breath-sounds are variously altered. Thus they may be scarcely audible, or again harsher than natural, and the expiration may be unduly prolonged. Sometimes the breathing is of an interrupted or jerky character, and is occasionally accompanied with fine crepitations or râles. Pleuritic friction-sounds may be audible over the affected area.

<sup>2</sup> In this stage the physical signs are more distinctive of the disease. Thus the flattening of the chest-wall is still more marked, as is also the dullness to percussion, while on auscultation the breathing is accompanied with coarse moist sounds or râles, which become more audible on coughing. The voice-sound is broncho-phonous.

<sup>3</sup> The physical signs now present are those of a cavity in the lung—viz., in general absolute dullness on percussion—cavernous breathing, gurgling râles, and pectoriloquy.

vidual case; but it is in this stage of the disease that the question of a change of climate in the colder seasons of the year arises among those whose circumstances render such a step practicable. There can be no doubt that as regards Great Britain the removal of patients threatened by or already suffering from consumption to some mild locality, either in the country or abroad, proves in many instances most salutary. The object aimed at is to obtain a more equable climate, where the atmosphere may have a soothing influence on the respiratory organs, and where also open-air exercise may be taken with less risk than at home. Of British health-resorts Bournemouth, Hastings, Torquay, Ventnor, Penzance, &c., in the south of England, are the best known and most frequented, and, although the climate is not so certain as in places farther south in Europe they possess the advantage of home residence, and may be resorted to by persons who are unable to undertake a farther journey. The climate of the Riviera (Maritime Alps) is of superior efficacy owing to its mildness and the dry bracing character of its air, and, despite the long journey, is as a rule to be recommended as one of the best for the greater proportion of the cases of phthisis. The same may be said for Algiers and Egypt. Of recent years the air of elevated dry regions, such as Davos in the Alps and the Rocky Mountains in America, has been strongly recommended, and in not a few cases appears to be productive of good in arresting the disease at its outset, and even advantageous in chronic cases where there is no great activity in its progress. Of like value, and in a similar class of cases, are long sea-voyages, such as those to Australia or New Zealand. Nevertheless, there is no doubt that consumptive patients are often sent abroad manifestly to die. It may be stated generally (although doubtless there may be exceptions) that where the disease exhibits a decidedly acute form, even in its earlier stages, any distant change is rather to be discouraged;

while in the advanced stages, where there is great prostration of strength, with colliquative symptoms, the removal of a patient is worse than useless, and frequently hastens the end.

Throughout the whole course of the malady the nutrition of the patient forms a main part of the treatment, and tonics which promote the function of the digestive organs are especially helpful. Codliver oil has long been held to be of eminent value, as it appears not merely to possess all the advantages of a food but to exert a retarding effect on the disease. Where it is well borne, not only will the weight of the body be found to increase, but the cough and other symptoms will markedly diminish. The oil is as a rule best administered at first in small quantity. The frequently employed substitutes, such as malt extract, tonic syrups, &c., although not without their uses, are all inferior to codliver oil. The occasional employment of counter-irritation to the chest in the form of iodine or small blisters is of service in allaying cough and relieving local pains. Respirators to cover the mouth and nose, and so constructed as to contain antiseptic media through which the air is breathed, are sometimes found to lessen cough and other symptoms of chest-irritation.

Among the most serviceable drugs in the treatment of the symptoms of phthisis are the preparations of opium. Administered along with such agents as hydrocyanic acid and expectorants, they are eminently useful in soothing severe cough; along with astringents they are equally valuable in controlling diarrhoea; while with quinine, digitalis, &c., they aid in allaying fever and restlessness and in procuring sleep. But besides these many other medicinal agents, too numerous to mention here, are employed with much advantage. Each case will present its own features and symptoms calling for special attention and treatment, and details upon these points must be left to the advice of the medical attendant. (J. O. A.)





